



**HAL**  
open science

# Wavelength-selective Ti:LiNbO<sub>3</sub> multiple Y-Branch coupler based on Focused Ion Beam Milled Bragg reflectors

Kamal Ghoumid, Badr-Eddine Benkelfat, Richard Ferriere, Gwenn Ulliac, Tijani Gharbi

► **To cite this version:**

Kamal Ghoumid, Badr-Eddine Benkelfat, Richard Ferriere, Gwenn Ulliac, Tijani Gharbi. Wavelength-selective Ti:LiNbO<sub>3</sub> multiple Y-Branch coupler based on Focused Ion Beam Milled Bragg reflectors. *Journal of Lightwave Technology*, 2011, 29 (23), pp.3536 - 3541. 10.1109/jlt.2011.2170056 . hal-03200777

**HAL Id: hal-03200777**

**<https://hal.science/hal-03200777>**

Submitted on 16 Apr 2021

**HAL** is a multi-disciplinary open access archive for the deposit and dissemination of scientific research documents, whether they are published or not. The documents may come from teaching and research institutions in France or abroad, or from public or private research centers.

L'archive ouverte pluridisciplinaire **HAL**, est destinée au dépôt et à la diffusion de documents scientifiques de niveau recherche, publiés ou non, émanant des établissements d'enseignement et de recherche français ou étrangers, des laboratoires publics ou privés.

# Wavelength-Selective Ti:LiNbO<sub>3</sub> Multiple Y-Branch Coupler Based on Focused Ion Beam Milled Bragg Reflectors

Kamal Ghoumid, Badr-Eddine Benkelfat, *Senior Member, IEEE*, Richard Ferriere, Gwenn Ulliac, and Tijani Gharbi

**Abstract**—This paper described a wavelength-selective couplers dedicated to drop functionality (spectral-selective couplers dedicated to wavelength demultiplexing). It is consist of two Y junctions: an input two drop channels and an output. The Y-branches distributors of optical power were carried out by a specific geometry of Ti:LiNbO<sub>3</sub> waveguides. Each Y junction is composed by two identical bends jointed at one with a weak inclination angle to decrease losses. On each arm of the Y-branches, a Bragg grating (BG) is etched by Focused Ion Beam (FIB) in order to extract a specific wavelength band. A two-channel configuration is adopted which demonstrate a drop functionality of two spectral bands centered at 1123 nm and 1527 nm. The complementary spectrum is available at the coupler output.

**Index Terms**—Bragg reflectors, drop channels, wavelength filtering devices, Y-branch coupler.

## I. INTRODUCTION

**D**ENSE and Coarse Wavelength Division Multiplexing (WDM) technologies, for metro and access networks, are some applications based on the use of specific optical devices. In the last decade, these optical networks are rapidly evolved from static to dynamic architectures. The critical component in a reconfigurable network is the Reconfigurable Optical Add/Drop (ROADM) which require flexibility in the optical wavelength domain, based on Wavelength Selective Switching (WSS).

A wavelength selective switch is an optical device that routes different spectral components from an input port to the desired output ports without optical-to-electrical-to-optical conversion.

In this context, several approaches have been proposed for implementation of the WSS subsystem. Most of them have

mainly focused on Liquid Crystal on Silicon (LCoS) and Micro-Electro-Mechanical-System (MEMS) technologies [1], [2].

In a conventional WSS, the optical performance (e.g., channel spacing, filter shape, etc.) is determined by the physical design of the optical structure through which the light passes. More recently, an add/drop filter based on coupled vertical gratings on silicon has been proposed to implement 1 by 4 WDM functionality [3]. The realization of such applications in integrated optics opens several applications.

Integrated optical components using Y-branch structures are used in such applications, are commonly employed in recent years like, for example, to realized Mach-Zehnder modulators [4], [5], or 1 × 2 digital optical switch known as “Y-branch digital optical switch” (DOS) [6]–[8]. Specific function, like variable power ratio division or TE/TM mode conversion, can be realized by using the electro-optic properties of lithium niobate (LN, LiNbO<sub>3</sub>) [9]. Wavelength filtering can also be obtained by surface acoustic wave (SAW) on LN. Furthermore, with an asymmetrical Y-junction structure fabricated by diffusing different materials into Y-cut LN, the incident TE and TM modes can be split by two output arms due to their different preferences of polarizations [10]. More recently the propagation in two-dimensional photonic crystal slabs allows an amplitude division of a guided beam [11].

The lithium niobate crystal stays a popular material for integrated optics, mainly due to its electro-optical, acousto-optical and non-linear properties that are exploited on various commercial devices [12]–[15]. It needs relatively simple techniques to obtain good performances compared with the sophisticated technologies used for semiconductor materials. The use of such a material is recommended in several integrated components.

The micro/nano-structuring of LiNbO<sub>3</sub> for the manufacture of BGs represents however a challenging task, due to the well known resistance of the material to standard machining methods [16]–[20]. Different approaches have been conducted for achieving nanostructures are employed [21]–[23]. The possibility of realizing miniature LiNbO<sub>3</sub> components arises with these fabrication methods.

In this article, FIB method is implemented to etch BGs on Ti:LiNbO<sub>3</sub> waveguides [24], [25] whose geometrical structure is composed by Y-branch junctions, in order to extract spectrum bands in awideband optical source. We chose this technique because we have already shown its effectiveness in achieving the proper Bragg reflectors with reflection coefficients that reach 97%, associated with bandwidth midheight width of about

Manuscript received February 03, 2011; revised June 21, 2011; accepted September 21, 2011. Date of publication September 29, 2011; date of current version November 25, 2011.

K. Ghoumid is with École Nationale des Sciences Appliquées d'Oujda, ENSAO, 60000 Oujda, Morocco, and also with Institut Femto-ST Département (LOPMD) UMR CNRS 6174, Université de Franche-Comté, 25030 Besançon Cedex, France (e-mail: kghoumid@ensa.univ-oujda.ac.ma; kamal.ghoumid@univ-fcomte.fr).

B.-E. Benkelfat is with Institut TELECOM, TELECOM Sud-Paris, Samovar UMR, INT-CNRS 5157, 91011 Evry Cedex, France (e-mail: Badr-Eddine.Benkelfat@int-edu.eu).

R. Ferrière, G. Ulliac, and T. Gharbi are with Institut Femto-ST Département d'Optique P.M. Duffieux (LOPMD) UMR CNRS 6174, Université de Franche-Comté, 25030 Besançon Cedex, France (e-mail: richard.ferriere@univ-fcomte.fr; gwenn.ulliac@univ-fcomte.fr; tijani.gharbi@univ-fcomte.fr).

Digital Object Identifier 10.1109/JLT.2011.2170056

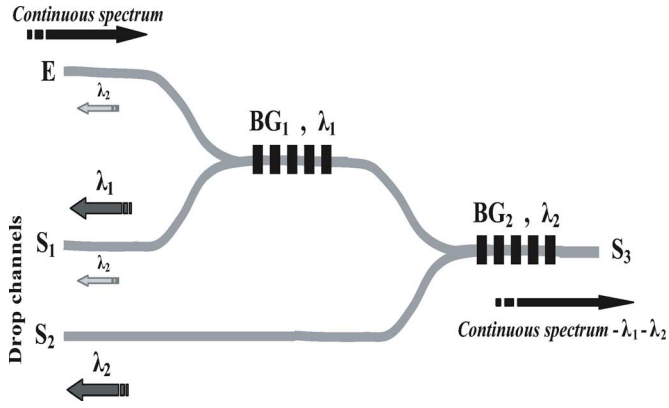

Fig. 1. Wavelength selective coupler composed by two Y junctions cascading: an input  $E$ , two drop channels  $S_1, S_2$ , and output  $S_3$ , including two Bragg gratings  $BG_1$  and  $BG_2$  on each arm.

100 nm [21], [22]. This method has already been employed to etch sub-micrometric one-dimensional structures in LiNbO<sub>3</sub> or 2D-photonic crystals. In comparison with more standard methods, FIB milling the advantage concerns the direct etching without any additional technological steps. Indeed FIB is a high capacity tool providing direct, local and controlled waveguide property modifications [24], [25].

Here we show the feasibility and the realization of a specific coupler using as a wavelength filter which consists of two Y-branches and two BGs in order to extract spectrum bands in a wideband optical source. Our idea was based on the properties of BGs that are used generally to achieve very high reflection around a given central wavelength. Thus, at the first two outputs, two spectral bands around 1123 nm and 1527 nm are extracted by the means of BGs. At the output, the complementary spectrum of the input source is available. This component could have a significant interest in convenient and reproducible fabrication technologies, ‘The benefit of the proposed structure is that it can be used as the switching element for wavelength routing in a wavelength selective switch.

We will consider as the future prospects will be to benefit from electro-optical properties of LN for realizing tunable devices, that would be very useful and convenient for the switching element for wavelength routing in a Wavelength Selective Switch.

## II. PRINCIPLE OF WAVELENGTH DEMULTIPLEXING BY MULTIPLE Y-BRANCH COUPLER

We present a wavelength-selective coupler; the common property desired in this type of device is the extraction of peculiar wavelengths from a continuum. Its basic scheme is given in Fig. 1; it consists in an input  $E$  and three outputs  $S_1, S_2$  and  $S_3$ . Two Bragg gratings noted  $BG_1$  and  $BG_2$  were etched in each arm of the Y junctions, they reflect the wavelengths around  $\lambda_1$  and  $\lambda_2$  respectively. The other wavelengths are transmitted and not affected by the BG.

If a continuous spectrum  $\sum_i \lambda_i$  is injected at  $E$ , a wavelength band reflected around  $\lambda_1$  and  $\lambda_2$  are recovered at  $S_1$  and  $S_2$  due to  $BG_1$  and  $BG_2$  respectively. It is obtained by the means of a ‘‘white’’ fiber laser. At  $S_3$  output, the entire spectrum is transmitted, except for the reflected bands. It should be noted

that the wavelengths reflected around  $\lambda_2$  and recovered at  $S_1$  have a power less than those recovered at  $S_2$ , this is due to the alignment losses. We also note that the output  $S_1$ , the presence of a small portion of the spectrum reflected wavelengths around  $\lambda_2$  due to  $BG_2$ .

We recall that the wavelengths reflected obey the Bragg condition given by the following equation [26]–[28]:

$$2n_{\text{eff}} \Lambda = m\lambda_B \quad (1)$$

where  $n_{\text{eff}}$  is the effective index of the propagating mode in the waveguide,  $m$  and  $\Lambda$  are respectively the Bragg order and period.  $\lambda_B$  is the Bragg wavelength.

## III. FABRICATION PROCESS

The preliminary experiments were carried out on a LiNbO<sub>3</sub> chip with a thickness of 0.5 mm and X-cut Z-propagation is used as substrate. In this configuration the two polarizations TE/TM of incident wave are affected by the same index  $n_0(\lambda = 1550 \text{ nm}) = 2.2112$  during its propagation. A Titanium layer (90 nm thickness) is deposited on the crystal surface by means of an Alliance Concept Eva 450 sputtering. The evaporation speed in the chamber is controlled by an Inficon quartz oscillator which assures a homogenous deposition of the metal. The geometric pattern of waveguides is realized by classical photolithographic techniques and chemical etching of the titanium layer. The optical waveguides are obtained by standard thermal indiffusion (1020°C during 8 h) of titanium ribbons (90 nm-thick and 7  $\mu\text{m}$  wide). The thermal diffusion of the titanium layer causes a variation of the refractive index of LN proportional to the concentration of Ti. Therefore, we obtain an increase in ordinary and extraordinary indexes of LiNbO<sub>3</sub>. Thus, the resulting layer is described as an index which is greater relatively to those of adjacent layers. It allows the confinement of light, and hence the realization of the waveguide Ti:LiNbO<sub>3</sub>. The guiding layer is of an index gradient, it is designed to reduce scattering losses due to interface roughness, and also to minimize the modal and polarization dispersion of the optical mode traveling in the waveguide.

With these experimental parameters the refractive indexes of the waveguide and the adjacent layers are:  $n_{\text{LiNbO}_3}(\lambda = 1550 \text{ nm}) = 2.2112$ ,  $n_{\text{Ti:LiNbO}_3}(\lambda = 1550 \text{ nm}) = 2.2275$ ,  $n_{\text{LiNbO}_3}(\lambda = 1135 \text{ nm}) = 2.2281$ ,  $n_{\text{Ti:LiNbO}_3}(\lambda = 1135 \text{ nm}) = 2.2432$ . In addition, it is worth noting that the waveguide is single mode obtained in the range of wavelengths [1050–1600] nm (with cutoff wavelength = 1070 nm). The 2D profile observed on a monitor via an infrared camera is shown in Fig. 2. These dimensions measured at  $1/e$  relatively to its maximum are  $W_x = 4 \mu\text{m}$  and  $W_y = 3 \mu\text{m}$ , and its maximum is measured at 2.8  $\mu\text{m}$ .

A top view of Ti:LiNbO<sub>3</sub> waveguide and the two Y-branches are represented on the Fig. 3. It is noted that the two Y junctions are designed with an inclination angle  $\alpha < 1^\circ$  in order to avoid significant propagation losses in the waveguide splitter [29]–[31]. In our conception, the angle of inclination of the arms is even lower than this value, it is  $0.6^\circ$ .

Once the waveguides were manufactured, the following step deals with the etching of  $BG_1$  and  $BG_2$ . The FIB method was

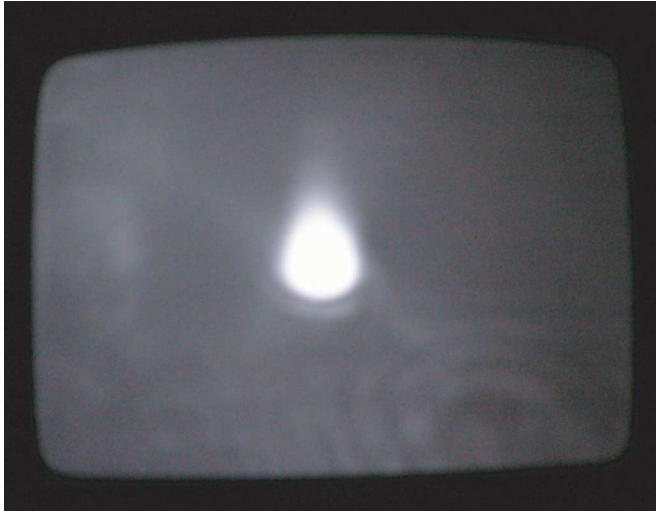

Fig. 2. The 2D profile of the mode propagated in the plan ( $XZ$ ) of Ti:LiNbO<sub>3</sub> waveguide observed on a monitor TV via an infrared camera. It is single-mode at the wavelength 1550 nm.

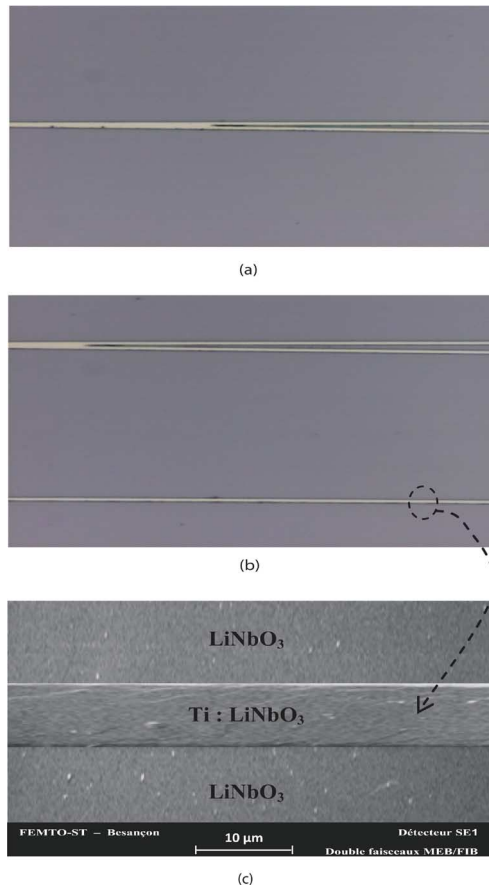

Fig. 3. (a) First junction Y, (b) second junction Y, (c) Ti:LiNbO<sub>3</sub> waveguide obtained by standard diffusion (90 nm thick and 7  $\mu\text{m}$  wide titanium layers at 1020°C during 8 h).

adopted to realize a micro-structuration of the waveguides. FIB technique produces a localized sputtering of the material. Consequently it induces significant transformations of the guide structure and a strong modification of the propagation properties. In these experimentations a dual beam Orsay Physics

Canon 31 LEO 4400 FIB was used, the command of the beam deflection was realized by a Raith Elphy Quantum 4.0 driver. Starting with the sputtering of a Chromium Cr layer whose main role is to prevent the accumulation of Ga<sup>+</sup> ions, with a thickness of 12 nm on the substrate, which was then inserted into the FIB chamber and exposed to a Ga<sup>+</sup> liquid metal ion source (LMIS) with ion acceleration energy of 30 keV.

For the design of both BGs, we used (1), with the Bragg order  $m = 5$ ,  $n_{\text{eff}1} = 2,2161$  and  $\lambda_{B_1} \approx 1,540$  nm. As a result, we obtain the following parameters: the first BG<sub>1</sub> has a period  $\Lambda_1 = 1.75$   $\mu\text{m}$ , a period number  $N_1 = 100$  and an etching depth  $l_1 = 2.6$   $\mu\text{m}$ , whereas the second BG<sub>2</sub> (with  $m = 5$ ,  $n_{\text{eff}2} = 2,2329$  and  $\lambda_{B_2} \approx 1135$  nm) has a period  $\Lambda_2 = 1.29$   $\mu\text{m}$ , a period number  $N_2 = 130$  and an etching depth  $l_2 = 2.6$   $\mu\text{m}$ . The BG obtained by FIB etching is illustrated in Fig. 4.

It should be noted the etching depth of the FIB process ( $l_1 = l_2 = 2.6$   $\mu\text{m}$ ) doesn't match the modal depth of the Ti diffused waveguides (about 2.2  $\mu\text{m}$  evaluated at  $1/e$  of maximum mode intensities [21]). This means for sure reduced grating effectiveness and additional out of plane losses. At this etching depth  $l = 2.6$   $\mu\text{m}$ , we expect an improvement of losses of in order of about 2.2 dB compared to the same BG the same quality but etched up to a depth of 3.7  $\mu\text{m}$ .

#### IV. RESULTS AND DISCUSSIONS

To assess the spectral responses in each output, a continuous spectrum source with a wavelength range of {850–1750} nm is launched at the coupler input. This continuum laser uses a strong nonlinear effect induced by a picosecond pulse (1064 nm) injected in a photonic crystal fiber specially designed [32]. It allows to obtain radiation with a flat broadband spectrum from {850–1750} nm. The measurement setup included: The measurement setup included: elements (V-grooves :  $Vg_1, \dots, Vg_4$ ) for the injection and recovery of transmitted and reflected optical signals, waveguide + selectif coupler, as well as three optical spectrum analysers OSA<sub>1</sub>, OSA<sub>2</sub> and OSA<sub>3</sub> to measure reflectivities and the transmittances respectively (Fig. 5).

Figs. 6 and 7, illustrate the reflectivities curves versus wavelengths measured at the outputs  $S_1$  and  $S_2$  respectively, they were centered around  $\lambda_1 = 1527$  nm and  $\lambda_2 = 1135$  nm. The coefficients of reflection of each curve were measured and found about 95%. The bandwidth at half maximum are respectively  $\Delta\lambda_1 = 49$  nm and  $\Delta\lambda_2 = 47$  nm.

Fig. 8 shows the measured transmission spectrum at the output  $S_3$  versus wavelengths of the signal of our device, and the whole transmitted spectrum was obtained except for the reflected wavelengths. It should be noted that the reflectance PSD and transmittance PSD are not the exact reciprocal of each other (because of the loss, absorption ...).

This study of experimental measurements implies the announcement of the existence of various types of losses which is related to: the injection and alignment process, material absorption, Y-junctions (inclination) and Bragg gratings corrugations. In the absence of corrugations, the three first types of front losses mentioned, can be estimated from Fig. 8 to be around 6 dB (this value is found to be the mean difference between curves (a) and (b)). The losses due to etching can be estimated

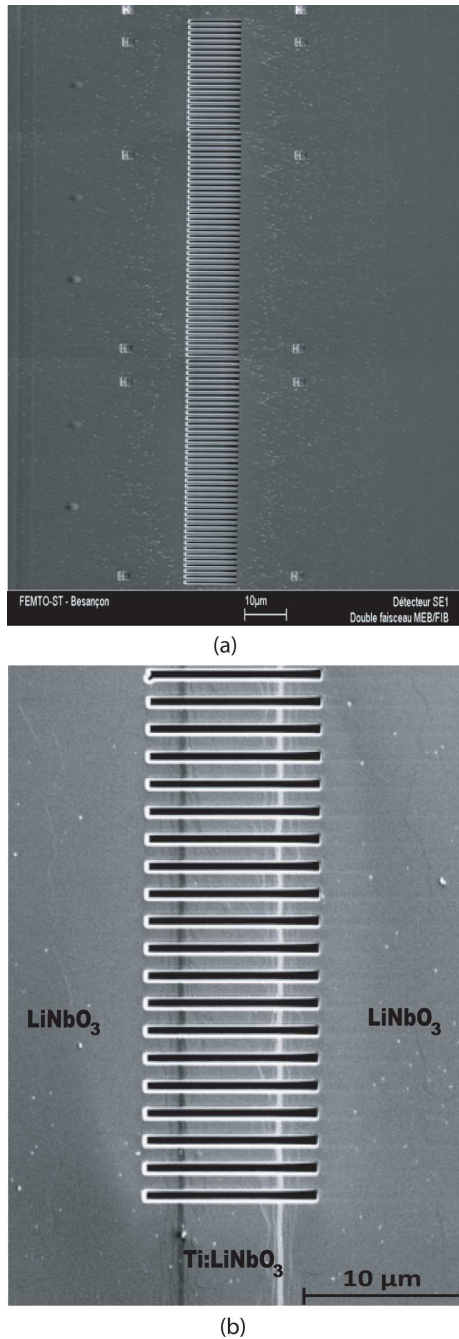

Fig. 4. (a) BG<sub>1</sub>( $\Lambda_1 = 1.75 \mu\text{m}$ ,  $N_1 = 100$ ,  $l_1 = 2.6 \mu\text{m}$ ) etched in a Ti:LiNbO<sub>3</sub> waveguide by FIB, (b) zoom of BG<sub>1</sub> and Ti:LiNbO<sub>3</sub> waveguide.

between 2 and 2.5 dB (the mean difference between curves (b) and (c)) [21].

A good results should be pointed out, a nice and non trivial feature of the presented experimental results is the absence of parasitic coupling to cladding modes, that usually induce unwanted losses at wavelengths shorter than the nominal one.

A significant remark concerning the existence of the parasitic peaks in the spectra of the reflectivities or of the transmittance measured at the exits  $S_1$ ,  $S_2$  and  $S_3$ , which are due to the roughness of the holes obtained after etching by FIB [21]. Indeed, by the engraving of a material by the mean of the FIB, the later is

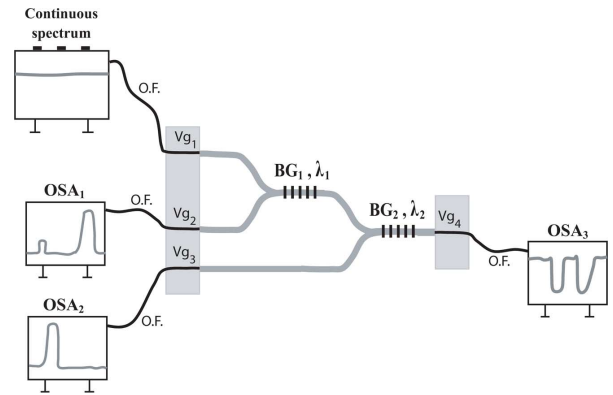

Fig. 5. Experimental setup : continuous spectrum [850–1750] nm, V-grooves  $Vg_1, \dots, Vg_4$ , optical fibers (O.F.), waveguide + selectif coupler and OSA<sub>1</sub>, OSA<sub>2</sub> and OSA<sub>3</sub>.

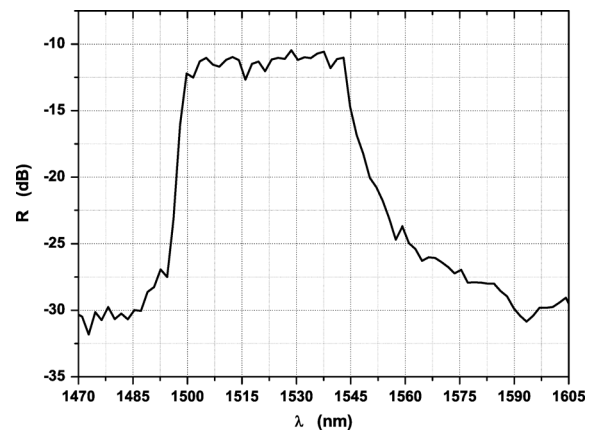

Fig. 6. Reflectivity versus wavelengths measured at the output  $S_1$ : peak centered around  $\lambda_1 = 1527 \text{ nm}$  with  $\Delta\lambda_{\text{HM}1} = 47 \text{ nm}$ .

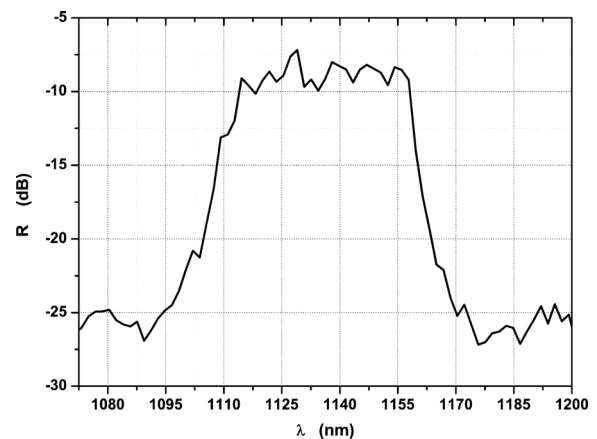

Fig. 7. Reflectivity versus wavelengths measured at the output  $S_2$ : peak centered around  $\lambda_2 = 1135 \text{ nm}$  with  $\Delta\lambda_{\text{HM}2} = 49 \text{ nm}$ .

insulated by Ga<sup>+</sup> ions, these induced modifications by the ionic insulation seems to be insignificant and the reason of the imperfections in the transmitted spectra and the Optical propagations is certainly due to the conical shape of the engraved BGs [33] and does not seem to be a modification of the substrate from the insulation.



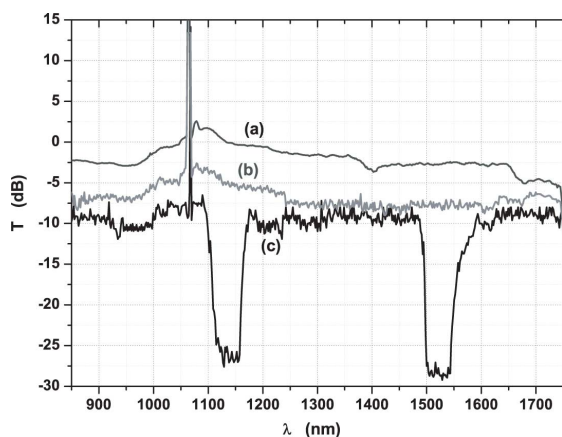

Fig. 8. Transmission versus wavelengths measured at the output  $S_3$ . The peak at 1064 nm corresponds to the pump of the 'white' laser employed to provide the wide spectrum at E input. (a) Source 'white' laser, (b) Ti:LiNbO<sub>3</sub> waveguide, (c) measured spectrum at the output  $S_3$ .

## V. CONCLUSION

A concrete application for extraction of wavelength bands by using Ti:LiNbO<sub>3</sub> waveguides with two Y junctions, comprising an input and a several outputs had been clearly demonstrated. The waveguides were manufactured by thermal diffusion process, and the Bragg gratings were etched by FIB in each Y-branch. Thus, a successful extraction from the bands around 1123 nm and 1527 nm was achieved. The principal advantages of this directional coupler, is that it can be used in both directions. Moreover, it can contain several Y junctions and several BGs, in order to extract other wavelengths. Nevertheless, we noted that the milling process of BGs was very long (eight hours).

Our perspective is to design, manufacture and characterize this kind of components suited for applications like DWDM. We will seek to remove wavelengths below 1 nm by changing the BGs parameters used for obtaining highly selective filters. Another objective will be to benefit from electro-optical properties of LN for realizing tunable devices that would be very useful and convenient in practical applications. Also, we note that this structure can be used in an application in the field of optical networks.

## ACKNOWLEDGMENT

The authors wish to acknowledge R. Salut, B. Guichardaz, D. Bitschene, J.-Y. Rauch, V. Petrini for technical assistance, and all personnel of the MIMENTO technology centre of the Institut FEMTO-ST, Besançon, France.

## REFERENCES

- [1] Y. Sakurai, M. Kawasugi, Y. Hotta, S. Khan, H. Oguri, K. Takeuchi, S. Michihata, and N. Uehara, "LCOS-based 4 × 4 wavelength cross-connect switch for flexible channel management in ROADMs," in *Proc. Opt. Fiber Commun. Conf.*, Los Angeles, CA, Mar. 6, 2011, pp. 1–3.
- [2] T. A. Strasser and J. L. Wagener, "Wavelength-selective switches for ROADM applications," *IEEE J. Sel. Topics Quantum Electron.*, vol. 6, no. 5, pp. 1150–1157, 2010.
- [3] D. T. H. Tan, K. Ikeda, S. Zamek, A. Mizrahi, M. P. Nezhad, A. V. Krishnamoorthy, K. Raj, J. E. Cunningham, X. Zheng, I. Shubin, Y. Luo, and Y. Fainman, "Wide bandwidth, low loss 1 by 4 wavelength division multiplexer on silicon for optical interconnects," *Opt. Exp.*, vol. 19, no. 3, pp. 2401–2409, 2011.
- [4] Q. Zhou, J. Yang, Z. Shi, Y. Jiang, B. Howley, and R. T. Chen, "Performance limitations of a Y-branch directional coupler-based polymeric high-speed electro-optical modulator," *Opt. Eng.*, vol. 43, no. 4, pp. 806–811, 2004.
- [5] D. An, Z. Shi, L. Sun, J. M. Taboada, Q. Zhou, X. Lu, R. T. Chen, S. Tabg, H. Zhang, W. H. Steier, A. Ren, and L. R. Dalton, "Polymeric electro-optic modulator based on 1A2 Y-fed directional coupler," *Appl. Phys. Lett.*, vol. 76, no. 15, pp. 1972–1974, 2000.
- [6] W.-C. Chang and H.-C. Hou, "Switching characteristics of Ni:LiNbO<sub>3</sub> directional couplers with two types of waveguide structures," *J. Micro Opt. Tech. Lett.*, vol. 23, no. 6, pp. 331–334, 1999.
- [7] Y. Sakamaki, T. Saida, M. Tamura, T. Hashimoto, and H. Takahashi, "Low-loss y-branch waveguides designed by wave front matching method and their application to a compact 1 × 32 splitter," *Electron. Lett.*, vol. 43, no. 4, pp. 217–219, 2007.
- [8] T. Erdogan, "Optical add-drop multiplexer based on an asymmetric Bragg coupler," *Opt. Commun.*, vol. 157, pp. 249–264, 1998.
- [9] Y. Hida, H. Onose, and S. Imamura, "Polymer waveguide thermo-optics switch with low electric power consumption at 1.3 μm," *IEEE Photon. Technol. Lett.*, vol. 5, no. 7, pp. 782–784, Jul. 1993.
- [10] C.-H. Chang and W.-S. Wang, "A novel Y-branch waveguide for power dividing and mode splitting," *Opt. Quantum Electron.*, vol. 28, pp. 1371–1377, 1996.
- [11] Y. Sugimoto, N. Ikeda, N. Carlsson, and K. Asakawa, "Light-propagation characteristics of Y-branch defect waveguides in AlGaAs-based air-bridge-type two-dimensional photonic crystal slabs," *Opt. Lett.*, vol. 27, no. 6, 2002.
- [12] D. K. Pant, R. D. Coalson, M. I. Hernandez, and J. Campos-Martinez, "Optimal control theory for optical waveguide design: Application to Y-branch structures," *Appl. Opt.*, vol. 38, no. 18, pp. 3917–3923, 1999.
- [13] R. R. A. Syms, "Optical directional coupler with a grating overlay," *Appl. Opt.*, vol. 24, no. 5, pp. 717–726, 1985.
- [14] P. Ganguly, J. C. Biswas, and S. K. Lahiri, "Analysis of Ti:LiNbO<sub>3</sub> zero-gap directional coupler wavelength division multiplexer/demultiplexer," *Opt. Commun.*, vol. 281, pp. 3269–3274, 2008.
- [15] R. Schiek, L. Friedrich, H. Fang, G. I. Stegeman, K. R. Parameswaran, M.-H. Chou, and M. M. Fejer, "Nonlinear directional coupler in periodically poled lithium niobate," *Opt. Lett.*, vol. 24, no. 22, pp. 1617–1619, 1999.
- [16] R.-H. Kim, J. Zhang, O. Eknoyan, H. F. Taylor, and T. L. Smith, "Narrowband Bragg reflectors in Ti:LiNbO<sub>3</sub> optical waveguides," *Appl. Opt.*, vol. 45, no. 20, pp. 4927–4932, 2006.
- [17] Y. Sidorin and A. Cheng, "Integration of Bragg gratings on LiNbO<sub>3</sub> channel waveguides using laser ablation," *Electron. Lett.*, vol. 17, no. 5, pp. 312–314, 2001.
- [18] J. Schtig, "Ti:LiNbO<sub>3</sub> stripe waveguide Bragg reflector gratings," *Electron. Lett.*, vol. 24, no. 14, pp. 844–845, 1988.
- [19] B. Wu, P. L. Chu, H. Hu, and Z. Xiong, "UV-induced surface-relief gratings on LiNbO<sub>3</sub> channel waveguides," *IEEE J. Quantum Electron.*, vol. 35, pp. 1369–1373, 1999.
- [20] N. Takeshima, Y. Kuroiwa, Y. Narita, S. Tanaka, and K. Hirao, "Fabrication of a periodic structure with a high refractive-index difference by femtosecond laser pulses," *Opt. Exp.*, vol. 14, no. 17, pp. 4019–4021, 2004.
- [21] K. Ghomid, R. Ferrière, B.-E. Benkelfat, B. Guizal, and T. Gharbi, "Optical performance of Bragg gratings fabricated in Ti:LiNbO<sub>3</sub> waveguides by focused ion beam milling," *J. Lightw. Technol.*, vol. 28, no. 23, pp. 3488–3493, Nov. 2010.
- [22] K. Ghomid, R. Ferrière, B.-E. Benkelfat, G. Ulliac, R. Salut, J.-Y. Rauch, and T. Gharbi, "Effect of depth etching on Bragg reflectors realized by focused ion beam in Ti:LiNbO<sub>3</sub> waveguide," in *Proc. SPIE*, 2009, vol. 7386, pp. 738613–1.
- [23] R. Ferrière, B.-E. Benkelfat, J. Dudley, and K. Ghomid, "Bragg miroir inscription on LiNbO<sub>3</sub> waveguides by index microstructuring," *J. Appl. Opt.*, vol. 45, no. 15, pp. 1–9, 2006.
- [24] K. Chaganti, I. Salakhutdinov, I. Avrutsky, G. W. Auner, and J. Mansfield, "Sub-micron grating fabrication on hafnium oxide thin-film waveguides with focused ion beam milling," *Opt. Exp.*, vol. 14, no. 4, pp. 1505–1511, 2006.
- [25] S. Yin, "Fabrication of high-aspect-ratio submicron-to-nanometer range microstructures in LiNbO<sub>3</sub> for the next generation of integrated optoelectronic devices by focused ion beams (FIB)," *Microw. Opt. Tech. Lett.*, vol. 22, no. 22, pp. 396–398, 1999.
- [26] T. Erdogan, "Fiber grating spectra," *J. Lightw. Technol.*, vol. 15, no. 8, pp. 1277–1294, 1997.

- [27] K. O. Hill, T. Fujii, D. C. Johnson, and B. S. Kawasaki, "Photosensitivity in optical fiber waveguides: Application to reflection filter fabrication," *Appl. Phys. Lett.*, vol. 32, no. 10, pp. 647–649, 1978.
- [28] N. Matuschek, F. X. Krtner, and U. Keller, "Exact coupled-mode theory for multilayer interference coatings with arbitrary strong index modulations," *IEEE J. Quantum Electron.*, vol. 33, no. 3, pp. 295–302, Mar. 1997.
- [29] J.-M. Lee, K.-J. Kim, and G. Kim, "Enhancing alignment tolerance of silicon waveguide by using a wide grating coupler," *Opt. Exp.*, vol. 16, no. 17, pp. 13024–13031, 2008.
- [30] S. Lardenois, D. Pascal, L. Vivien, E. Cassan, S. Laval, R. Orobtchouk, M. Heitzmann, N. Bouzaida, and L. Mollard, "Low-loss submicrometer silicon-on-insulator rib waveguides and corner mirrors," *Opt. Lett.*, vol. 28, no. 13, pp. 1150–1152, 2003.
- [31] I. Papakonstantinou, D. R. Selviah, and K. Wang, "Insertion loss and misalignment tolerance in multimode tapered waveguide bends," *IEEE Photon. Technol. Lett.*, vol. 20, no. 12, pp. 1000–1002, Dec. 2008.
- [32] J. Dudley, G. Genty, and S. Coen, "Supercontinuum generation in photonic crystal fiber," *Rev. Mod. Phys.*, vol. 78, pp. 1135–1184, 2006.
- [33] G. W. Burr, S. Diziain, and M.-P. Bernal, "The impact of finite-depth cylindrical and conical holes in lithium niobate photonic crystals," *Opt. Exp.*, vol. 16, no. 9, pp. 6302–6316, Sep. 2008.

**Kamal Ghoumid** received the Ph.D. degree from the Institut TELECOM, TELECOM Sud-Paris, Evry, France, and the University of Franche-Comté, Besançon, France, in 2008.

He has worked as postdoctoral researcher at Institut Jean Lamour of University of Henri Poincaré, Nancy, France, during 2009. His area of research work was to study Pirani Vacuum SAW sensor. He has taught at the ENSAO School, Oujda, Morocco. Since 2010, he has been working in LOPMD Laboratory of Institut FEMTO-ST, France. He has also the experience in research areas of electro-optic modulator, optical devices for high-speed WDM, signal processing and integrated optic components in the field of telecommunications.

**Badr-Eddine Benkelfat (SM'03)** was born on August 18, 1958. He received the Ph.D. degree from the University of Franche-Comté, Besançon, France, in 1983.

He presently holds a position of Professor at Institut TELECOM—TELECOM Sud-Paris, Evry, France. His currently research interest include optoelectronic systems for optical signal processing, optical devices for high-speed WDM optical fiber communications.

**Richard Ferriere** was born in 1947. He received the Doctorat de 3eme cycle in 1975 and the Doctorat d'Etat degree from the University of Franche-Comté, Besançon, France, in 1982.

In 1978, he joined the Centre National de la Recherche Scientifique (CNRS) as a Physicist, where he was involved with optical processing in polychromatic light and holographic optical elements. He current research deals with telemetry, femto-second laser milling, electroptic signal processing and integrated optics components in the field of telecommunications

**Gwenn Ulliac** received the M.Sc. and Ph.D. degrees in microwave and microtechnology from Lille University, France, in 2001 and 2005, respectively.

In 2006, he joined the FEMTO-ST Institute, where he is currently a research engineer in the clean room MIMENTO. His research interests include the fabrication and the technological developments of opto-electronic and acousto-optical components on lithium niobate material (waveguides, bragg gratings, photonic crystals, phononic crystals, acoustic resonator).

**Tijani Gharbi** received the D.Sc. degree in state molecular physics from the University of Franche-Comté, Besançon, France, in 1982.

He has extensive experience in research, training and valorization from the medical sector. He served for 30 years in the biomedical field. He is responsible for the team "Microsystems for Life Sciences" in the Optics Laboratory of Besançon, then head of the team "Biophotonics" of the FEMTO-ST UMR CNRS 6174. He assured the management of 20 Ph.D. theses. On the education side, it was the precursor of the rapprochement of the engineering and the medical technology in the region of Franche-Comté. As such, he is one of the founding members of the Higher Institute of Engineers of Franche-Comté (ISIFC). He is the author of numerous scientific papers published in major international journals. He is also an inventor of some 30 patents related to biomedical applications.