



HAL
open science

Efficient gene delivery by sonoporation is associated with microbubble entry into cells and the clathrin-dependent endocytosis pathway

Anthony Delalande, Chloe Leduc, Patrick Midoux, Michiel Postema, Chantal Pichon

► To cite this version:

Anthony Delalande, Chloe Leduc, Patrick Midoux, Michiel Postema, Chantal Pichon. Efficient gene delivery by sonoporation is associated with microbubble entry into cells and the clathrin-dependent endocytosis pathway. *Ultrasound in Medicine & Biology*, 2015, 41 (7), pp.1913-1926. 10.1016/j.ultrasmedbio.2015.03.010 . hal-03198520

HAL Id: hal-03198520

<https://hal.science/hal-03198520>

Submitted on 14 Apr 2021

HAL is a multi-disciplinary open access archive for the deposit and dissemination of scientific research documents, whether they are published or not. The documents may come from teaching and research institutions in France or abroad, or from public or private research centers.

L'archive ouverte pluridisciplinaire **HAL**, est destinée au dépôt et à la diffusion de documents scientifiques de niveau recherche, publiés ou non, émanant des établissements d'enseignement et de recherche français ou étrangers, des laboratoires publics ou privés.



Distributed under a Creative Commons Attribution - NonCommercial - NoDerivatives 4.0 International License

1 Title: Efficient gene delivery by sonoporation is associated with
2 microbubble entry to cells and the clathrin-dependent endocytosis
3 pathway.

4 Authors: Anthony Delalande^{1*}, Chloé Leduc¹, Patrick Midoux¹, Michiel Postema^{2,3},
5 Chantal Pichon^{1*}.

6 Affiliations:

7 1. Centre de Biophysique Moléculaire, CNRS UPR4301, Orléans, France,

8 2. Department of Physics and Technology, University of Bergen, Bergen, Norway

9 3. Department of Physics, University of the Witwatersrand, Johannesburg, South Africa.

10 *: co-corresponding authors: anthony.delalande@cnrs-orleans.fr and
11 chantal.pichon@cnrs-orleans.fr

12 **Abstract**

13 Microbubble oscillation under specific ultrasound settings leads to a permeabilization
14 of surrounding cells. This phenomenon, referred as sonoporation, allows for the *in-*
15 *vitro* and *in-vivo* delivery of extracellular molecules including plasmid DNA (pDNA).
16 To date, the biological and physical mechanisms behind this phenomenon are still
17 not fully understood. This study aims at investigating the interactions between
18 microbubbles and cells as well as the intracellular routing of pDNA and microbubbles
19 during and post-sonoporation. Investigations were done by high-speed imaging and
20 fluorescence confocal microscopy using HeLa cells stably expressing eGFP fused
21 with markers of cellular compartments. Soft-shelled microbubbles were observed to
22 enter into cells during sonoporation using experimented parameters that led to an
23 optimal gene transfer. They interacted with the plasma membrane in a specific area
24 stained with fluorescent cholera subunit B, a marker of lipid rafts. This process was
25 not observed with hard-shelled microbubbles which were not efficient for gene
26 delivery under our conditions. The pDNA was delivered in late endosomes after 3
27 hours post-sonoporation and few of them were found in the nucleus after 6 hours.
28 The gene transfer efficacy was greatly inhibited when cells were treated with
29 chlorpromazine, an inhibitor of the clathrin-dependent endocytosis pathway. By
30 contrast, no significant alteration was obtained when cells were treated with Filipin III
31 or Genistein both inhibitors of the caveolin-dependent pathway. This study highlights
32 that microbubble-cell interactions do not occur randomly during sonoporation;
33 microbubbles penetration inside cells imparts the efficacy of gene transfer at specific
34 ultrasound settings and the pDNA uptake is an active mechanism that involves the
35 clathrin-dependent pathway.

36

37 **Keywords:** ultrasound; microbubble; sonoporation; gene delivery; endocytosis;

38 clathrin-mediated endocytosis pathway

39

40 **Introduction**

41 Although being less efficient than gene delivery by viral vectors; non-viral gene
42 transfer still offers a great promise for gene therapy because of its safety compared
43 to its viral counterparts. Almost twenty years ago, an original drug/gene delivery
44 method based on ultrasound stimulation coupled to gaseous microbubbles was
45 proposed (Bao *et al.*, 1997). Upon ultrasound exposure, microbubbles can oscillate,
46 move, coalesce, fragment, or be disrupted otherwise (Postema and Gilja, 2007).
47 These properties modify the cell membrane permeability by a process known as
48 sonoporation (Bao *et al.*, 1997; Miller *et al.*, 1999; Taniyama *et al.*, 2002). It offers the
49 opportunity of site-specific local delivery of a drug or gene. In the field of gene
50 transfer, several studies have reported an improvement of gene delivery efficacy by
51 sonoporation (Bao *et al.*, 1997; Wang *et al.*, 2005). Numerous *in-vitro* and *in-vivo*
52 studies on sonoporation and its exploitation for gene transfer have been published
53 (Delalande *et al.*, 2011; Delalande *et al.*, 2013; Mehier-Humbert *et al.*, 2005; Noble *et*
54 *al.*, 2013; Pichon *et al.*, 2008). The main hypothesis assumes a direct entry of the
55 molecules through transient pores in the plasma membrane as a consequence of
56 interaction of oscillating microbubbles with the plasma membrane (Mehier-Humbert
57 *et al.*, 2005; Miller *et al.*, 1999; Taniyama *et al.*, 2002). Transient pores formed at the
58 plasma membrane are responsible for the direct intracellular delivery of small
59 molecules but also the outward transport of intracellular molecules (Kaddur *et al.*,
60 2010). According to Zhou *et al.*, the pore formed during sonoporation is estimated to
61 be 100 nm wide and opened during 5 seconds (Zhou *et al.*, 2009). The pore
62 formation may be the trigger of many intracellular mechanisms (Juffermans *et al.*,
63 2009). Several mechanisms of pore membrane formation could occur during
64 sonoporation (for a review see Delalande *et al.* (2012)). However, the mechanisms of

65 gene transfer from microbubble stimulation, its interaction with cells to gene
66 expression are still not well understood. Recently, some studies have shown that
67 endocytosis process could be involved in the sonoporation mechanism for large
68 molecules (Meijering *et al.*, 2009; Paula *et al.*, 2011), intracellular delivery of
69 liposomes (Afadzi *et al.*, 2013) and lipoplexes (Kurosaki *et al.*, 2014). As pDNA are
70 big molecules over 3 MDa, we suppose that endocytosis should be involved in gene
71 transfer by sonoporation. None of those studies have delineated the complete the
72 process of sonoporation. A better knowledge of the key steps occurring during and
73 after sonoporation could allow for an improvement of this method.

74 This is the first study making a correlation between optimal ultrasound parameters
75 determination for efficient gene transfer *in vitro* and the processes that govern this
76 efficacy. We observed that under optimal ultrasound parameters that lead to gene
77 transfer, microbubbles interacted preferentially with lipid raft areas of the cell and
78 some of them were found inside cells. Sonoporation-induced gene transfer is not a
79 purely mechanical process but biological as well. Here, we focused on the role of
80 endocytosis in cellular gene uptake. This hypothesis has been confirmed by the use
81 of a clathrin-dependent endocytosis inhibitor that abolished gene transfer efficacy.
82 The plasmid DNA was followed in the cell and was found mainly routed to rab7
83 positive endosomes 3 hours after sonoporation and close to the nucleus after 6 hours.

84

85 **Materials and Methods**

86 ***Cell culture***

87 Human epithelial cervix adenocarcinoma HeLa cells were used in this study (CCL2,
88 ATCC, Rockville, MD). HeLa cells stably expressing the fusion protein Rab7-GFP
89 and Nup153-GFP were developed to localize the fluorescent-labelled pDNA into
90 specific cellular structures (late endosomes and nucleus respectively). HeLa cells
91 were grown in MEM with Earl's salts medium (PAA Laboratories GmbH, Pasing,
92 Austria) supplemented with 10% v/v of FCS and 1% of non-essential amino acids
93 (PAA), penicillin (100 U/mL) and streptomycin (100 µg/mL) at 37°C in a humidified
94 atmosphere containing 5% CO₂. To select Rab7-eGFP and Nup153-eGFP transgene
95 expressing HeLa cells, cell medium was supplemented with G418 (200 µg/mL, PAA).
96 Cells were free from mycoplasma as evidenced by MycoAlert® Mycoplasma
97 Detection Kit (Lonza, Levallois Perret, France).

98 ***Plasmid DNA preparation and labelling***

99 A 7.5-kb homemade reporter plasmid that encoded the firefly luciferase gene (pLuc)
100 under the control of the strong cytomegalovirus promoter was used. Five consecutive
101 NFκB motifs that recognized the NFκB transcription factor were inserted upstream of
102 the promoter. All plasmids vectors were propagated from *Escherichia coli* DH5α
103 cultures. Supercoiled plasmid was isolated from bacteria by the standard alkaline
104 lysis method, and purification was carried out with the Qiagen Mega Kit (Qiagen,
105 Courtabœuf, France) according to the manufacturer's instructions. Each pDNA was
106 labelled with the Label IT nucleic acid labelling kit (Mirus, Madison, WI, USA) at 1:2
107 reagent/pDNA weight ratios according to manufacturer's instructions. When indicated,
108 plasmids were labelled with cyanine 3 or cyanine 5 fluorescein probes followed by

109 ethanol precipitation for DNA purification. The labelling densities were determined by
110 spectroscopy according to the manufacturer's protocol and corresponded to
111 approximately 1 fluorophore per 80 base pair. We verified that the labelling process
112 of the plasmid did not affect the gene expression.

113 ***Ultrasound exposure system for gene transfer***

114 US were generated from a 0.5-inch diameter, IBMF-014 planar transducer with a
115 center frequency of 1 MHz (Sofranel, Sartrouville, France). The transducer was
116 placed in a custom made polystyrene tank filled with degassed pure water. A signal
117 consisting of 1.0 MHz center frequency, 40% duty cycle and a pulse repetition
118 frequency (PRF) of 10 kHz was generated by a 33220A arbitrary function generator
119 (Agilent technologies, Les Ulis, France) and amplified by a RF power amplifier
120 (ADECE, Artannes sur Indre, France) was used as the input for the transducer. Peak
121 negative pressure of 150 kPa was used corresponding to an MI of 0.15. Ultrasound
122 stimulation time was set to 60 seconds. The transducer was calibrated in a Perspex
123 container using an HGL-200 PVDF bullet type hydrophone (Onda, Sunnyvale, CA)
124 placed at 3 cm, the natural focal distance of the transducer and behind the first
125 cuvette wall. Measures made with and without the cuvette wall conducted to an
126 average of 5% attenuation. Reflections from the cuvette were measured in a
127 separate experiment in our sonoporation setup. The transducer was driven using a
128 103 SPR pulser-receiver (Accu-Tron Inc). The reflections from the cuvette were
129 measured to be lower than -13 dB, and could therefore be neglected. Furthermore,
130 we investigated the influence of potential reflections from the 3-mm thick container
131 wall using the same pulser-receiver. Here, we found, that reflections from the inner
132 surface of the container were mostly cancelled out by the inverted-phase reflections
133 from the outer surface of the container. The transducer was positioned in front of the

134 sonoporation cuvette as depicted in the figure 1 (Sarstedt AG & Co, Nümbrecht,
135 Germany). 10^5 cells were grown on a resized Opticell[®] membrane (10×15 mm) (Nunc
136 GmbH & Co. KG, Langenselbold, Germany). Opticell[®] membranes were transferred
137 into polystyrene cuvettes (Sarstedt, Nümbrecht, Germany) containing 1.5 mL of
138 OptiMEM medium (Invitrogen, Carlsbad, CA, USA) supplemented with 1% FCS.
139 During sonoporation the cell medium was supplemented with 2.5 µg of pDNA and 5
140 µL of microbubbles and the cuvette was placed under gentle agitation using a
141 magnetic stirrer. After sonoporation the membrane was placed in the incubator with
142 the sonoporation medium on a 12-well cell culture plate.

143 ***Ultrasound exposure system for high-speed imaging***

144 The behaviour of microbubbles during sonoporation was studied by high-speed
145 imaging methods. We performed real-time visualization of sonoporation events to
146 investigate how microbubbles behave towards cells as a function of the acoustic
147 pressure. The different possibility of interactions between MicroMarker[®] microbubbles
148 and cells was investigated using the optimal acoustic parameters (1 MHz, 40% DC,
149 10 kHz PRF), at 100, 150 and 200 kPa.

150 For fast camera imaging experiments, the transducer was placed in a custom-made
151 aluminum sonication chamber with internal dimensions of 130×170×35 (mm)³ was
152 locked into to the xy-stage of a 200M inverted microscope (Carl Zeiss AG,
153 Oberkochen, Germany) coupled with a LSM Axiovert 510 confocal scanning device
154 (Carl Zeiss), using an EC Plan-Neofluar 40× magnification and 1.30 numerical
155 aperture oil objective (DIC M27, Carl Zeiss AG), with automated z-stack functionality
156 as shown in the figure 2. The color charge coupled device (CCD) of a Photron
157 FastCam MC-2.1 high-speed camera (VKT Video Kommunikation GmbH, Pfullingen,
158 Germany) was connected to the microscope. The sensor was rotated to make sure

159 that in all recorded movies, the ultrasound is directed from the bottom right to the top
160 left of the frame. The peak-negative acoustic pressures were measured in the
161 insonation tank at the objective's field of view and corresponded to a mechanical
162 index (MI) of 0.1, 0.15 or 0.2. The day before experiment, 1.6×10^6 cells were seeded
163 in an Opticell[®] chamber. Ultrasound contrast agents were injected into the cell culture
164 chamber before each experiment.

165 ***Ultrasound contrast agent***

166 In this study, Micromarker[®] (VisualSonics, La Frette S/Seine, France) microbubbles
167 were used. Micromarker[®] contrast agents contain a perfluorobutane (C₄F₁₀) gas
168 encapsulated by a phospholipid shell and have a median diameter between 2.3 to
169 2.9 μm . Microbubbles were prepared according to manufacturer's protocol,
170 Micromarker[®] suspension contained approximately 2×10^9 MB/mL.

171 ***Gene transfer efficacy***

172 We determined the optimal acoustic parameters that give the maximal gene transfer
173 on adherent HeLa cells using our set-up described in Figure 1. Four parameters were
174 tested: the sound pressure (kPa), the time of ultrasound exposure (sec), the duty
175 cycle (%) and the microbubble concentration (%). We tested different values of
176 acoustic pressure (from 100 to 200 kPa), duty cycles from 10 to 60% and ultrasound
177 exposure times ranging from 10 to 300 seconds. The importance of the amount of
178 microbubbles was also evaluated. When a parameter was tested, the other
179 parameters were fixed as follows: 150 kPa, 60 sec, 40% DC, 5 μL microbubbles.

180 The efficacy of sonoporation to deliver luciferase gene was determined by measuring
181 the luciferase activity 24 h after sonoporation of HeLa cells in the presence of a
182 plasmid encoding the luciferase reporter gene. Cells were harvested, lysed and the

183 luciferase activity was measured using a luminometer (Lumat LB9507, Berthold,
184 Wildbach, Germany) after adding 100 μ L of luciferase substrate (1 mM luciferin
185 containing ATP) to 60 μ L of cell lysate. The values were expressed as RLU (Relative
186 Luciferase Unit), this level was reported to the protein concentration in RLU/mg prot.
187 The protein concentration was measured by the bicinchoninic acid assay.

188 The gene transfer efficacy was also evaluated by flow cytometry when a plasmid
189 encoding for the GFP reporter gene was used (pMAX, Lonza). 24 h after
190 sonoporation cells were harvested, pelleted and re-suspended in PBS before flow
191 cytometry analysis; 10000 cells were analyzed for each condition.

192 ***Cell viability assay***

193 The cell viability was determined 24 h after sonoporation using the MTT colorimetric
194 assay. Cells were incubated during 4 h at 37°C, 5% CO₂ in presence of 3-(4,5-
195 dimethylthiazol-2-yl)-2,5-diphenyltetrazolium bromide (Sigma-Aldrich, St. Louis, USA)
196 at 500 μ g/mL. Cells were washed and incubated in a lysis buffer consisting of
197 acidified isopropanol containing 3% of SDS (Sigma-Aldrich) allowing the
198 solubilization of tetrazolium salts. Quantification was made measuring the optic
199 density at 560 nm; the control optical density was made using cells having received
200 the same manipulations without any treatment.

201 ***Microbubble fluorescent labelling***

202 To probe MicroMarker[®] microbubbles, their envelope was stained with the
203 fluorescent lipophilic probe DiD (λ_{ex} = 633 nm, λ_{em} = 643-670 nm) (Vybrant[™],
204 Molecular Probes[®], Invitrogen, San Diego, CA, USA). A ratio of 1 μ L of DiD to 40 μ L
205 MicroMarker[®] was used. The solution was homogenized by pipetting and it was used
206 after 5 min incubation at room temperature.

207 ***Lipid raft labelling***

208 To get more insight on interactions between microbubbles and cells, we identified if
209 the region where microbubbles clustered on the cell surface could be some specific
210 area of the plasma membrane as lipid rafts. Microbubbles were labelled with DiD
211 lipophilic dye and lipid rafts were stained with Rhodamine B-tagged cholera toxin B-
212 subunit (CTB, Molecular Probes, $\lambda_{\text{ex}} = 543 \text{ nm}$, $\lambda_{\text{em}} = 553\text{-}600 \text{ nm}$) known to interact
213 with GM1 gangliosides, one constituent of lipid rafts (Antes *et al.*, 1992). HeLa cells
214 were incubated with 2.5 $\mu\text{g/mL}$ of CTB during 30 minutes at 37°C before
215 sonoporation. Immediately after sonoporation cells were fixed using a 2%
216 paraformaldehyde solution in PBS. After three washes, resized Opticell[®] membranes
217 were then mounted on glass slides for confocal microscopy observations. Images
218 were analyzed for colocalization by the plugin JACoP in ImageJ (Bolte and
219 Cordelieres, 2006).

220 ***Importance of endocytosis during sonoporation***

221 To assess if endocytosis is needed to get an efficient gene transfer following
222 sonoporation a first experiment was the evaluation of incubation time of cells and
223 plasmid DNA on gene transfer efficacy. Cells were sonoporated and the medium was
224 retrieved and renewed with fresh medium immediately (0 h) or at different times up to
225 4 hours. Cells were harvested 24 hours later and the luciferase expression was
226 measured as previously described.

227 To validate the involvement of endocytosis in the process of gene transfer by
228 sonoporation, we tested the effect of depletion of cellular ATP and inhibitors of
229 clathrin and caveolae-mediated endocytosis pathways on the sonoporation gene
230 transfer efficacy. Cells were ATP-depleted by 30 minutes incubation in presence of

231 ATP depletion buffer (50 mM 2-deoxy-ATP, 50 mM sodium azide, 1.8 mM CaCl₂ in
232 PBS pH 7.4) before the sonoporation. Cells were pre-treated for 30 minutes with
233 either chlorpromazine (2.5 to 20 µg/mL; Sigma-Aldrich) an inhibitor of clathrin-
234 mediated endocytosis pathway, Filipin III (1 to 4 µg/mL; Sigma-Aldrich) or Genistein
235 (1 to 10 µg/mL), both inhibitors of caveolin-mediated endocytosis pathway (Ivanov,
236 2008). Then, sonoporation was performed in presence of indicated inhibitor and the
237 cell medium was only replaced two hours later to maintain the inhibition effect.

238 ***Plasmid DNA internalization assay***

239 The pDNA uptake by cells was evaluated by flow cytometry using a FITC-labelled
240 plasmid. Trypan blue was used as a quencher of the FITC-fluorescence at the
241 plasma membrane to distinguish pDNA attached to the plasma from internalized
242 pDNA (Van Amersfoort and Van Strijp, 1994). Cells were harvested immediately (0),
243 3 or 6 hours after sonoporation and analyzed by flow cytometry (LSR, BD). 10 000
244 events were used for each condition.

245 ***Statistical analysis***

246 Data was expressed as mean ± SD. Statistical differences between groups was
247 analyzed by the bilateral Mann–Whitney U-test and the correlation analyses were
248 conducted using the Spearman test using XLStat 2014 software (Addinsoft, Paris,
249 France). The significance was defined as a *p*-value ≤ 0.05.

250

251 **Results**

252 ***Optimal acoustic parameters determination for efficient gene transfer.***

253 Figure 3A shows the effect of the acoustic pressure on the gene transfer efficacy.
254 Increasing the acoustic pressure from 100 to 160 kPa caused a linear improvement
255 of the gene transfer efficacy (from 3.2×10^4 to 2×10^6 RLU/mg prot, 62-fold increase).
256 The maximum level of gene expression was obtained at 160 kPa and it decreased
257 with further increase in acoustic pressure. At 200 kPa, the efficacy was 10-fold lower
258 than the level obtained at 160 kPa (1.9×10^5 RLU/mg prot). In our study, the cell
259 viability was preserved (90% of cell viability) under the optimal condition for gene
260 transfer.

261 As observed in Figure 3B, the gene transfer efficacy was positively improved with
262 ultrasound exposure time between 10 and 60 seconds (2.1×10^4 and 5.4×10^5 RLU/mg
263 prot respectively). A plateau was observed between 60 and 300 seconds. However, it
264 should be noted that a high variability was observed for long stimulation times.
265 Indeed, we observed a cell toxicity ranging from 30 to 60% for the respective
266 ultrasound stimulation time of 10 and 300 seconds.

267 Regarding the duty cycle (Figure 3C), a threshold value of 40% duty cycle was
268 required for an efficient gene transfer. Between 10 and 30% duty cycle, a very low
269 expression level of luciferase gene was obtained (around 10^4 RLU/mg prot). At 40%
270 duty cycle, there was 75-fold increase of gene transfer efficacy as compared to 10%
271 duty cycle. Then, a plateau was reached between 40 and 60% duty cycle. However,
272 experiments conducted at 60% duty cycle led to a low viability (40%).

273 Figure 3D shows that a minimum volume of microbubble of 2.5 μ L is required to get
274 an increased gene expression compared to control without microbubbles (6.2×10^5

275 RLU/ mg prot using 2.5 μ L of microbubbles vs. 5.8×10^4 RLU/ mg prot for the control
276 without microbubbles). No significant improvement was achieved when higher
277 volumes were injected.

278 ***Microbubble behavior during sonoporation***

279 Depending on the acoustic pressure used three different types of microbubble-cell
280 interactions were observed (figure 4 and supplementary video). At 100 kPa, a cellular
281 massage was the main observed phenomenon. Ultrasound-activated microbubbles
282 remained in contact with the cell membrane during the whole stimulation (Figure 4A).
283 At this acoustic pressure, a low level of gene transfer was obtained as seen on
284 Figure 3A. At 150 kPa, an additional phenomenon consisting of the microbubble
285 entry into cells was depicted (figure 4B). The microbubble was first interacting with
286 cells and then disappeared after few milliseconds. In the presented sequence, two
287 microbubbles (indicated by arrow heads) penetrated inside cells after 600 ms of
288 ultrasonic stimulation. This observation is in accordance with our previous study
289 (Delalande *et al.*, 2011). Note that the optimal gene transfer efficacy was obtained at
290 this acoustic pressure range (Figure 3A). For a sound pressure of 200 kPa,
291 microbubbles were either driven out from the field of view due to excessive radiation
292 force or interacted violently with the cell. The latter induced the cell detachment from
293 the support. At 200 kPa, the gene transfer efficacy was ten times lower than at 150
294 kPa that is likely due to the above-described phenomena.

295 Our real-time sonoporation result indicate that three event types could be recorded:
296 microbubbles stuck on cell membrane during the insonation corresponding to the
297 cellular massage; microbubbles entering into cells (translation) and microbubbles
298 having a violent interaction with cells. Table 1 summarizes the correlation between

299 gene transfer efficacy and the different types of events recorded during sonoporation
300 and the acoustic pressure used. A positive correlation could be measured between
301 the gene transfer efficiency and the microbubble entry to cells ($p < 0.0001$). Moreover
302 the incidence of violent interactions was found positively correlated with the acoustic
303 pressure ($p < 0.0001$).

304 ***Lipids rafts and microbubble-cell interactions.***

305 At optimal parameters for gene transfer, microbubbles were found mainly colocalized
306 with lipid rafts immediately after sonoporation with a coefficient of colocalization of
307 0.706 and an overlapping coefficient of 0.803. This is shown by the purple color
308 corresponding to a colocalization of DiD-labelled microbubbles presented in blue and
309 Rhodamine B-labelled cholera toxin B presented in red (figure 5).

310 ***Plasmid DNA and microbubble intracellular routing upon sonoporation***

311 Figure 6 presents the localization of plasmid DNA (red) in HeLa cells expressing
312 Rab7-eGFP (green). Immediately after sonoporation, pDNA was mainly localized at
313 the plasma membrane without any co-localization with Rab7-eGFP (Figures 6A and
314 6B). Observations from 3 hours post-sonoporation indicated that some of pDNA
315 ended up into late endosomes as demonstrated by the yellow color (merge of green
316 and red spots) revealing their localization in Rab7-positive organelles (Figures 6C
317 and 6D).

318 Figure 7 presents the localization of plasmid DNA (red) and DiD-labelled
319 microbubbles (blue) in HeLa cells expressing Nup153-eGFP (green). 6 hours post-
320 sonoporation plasmid DNA was found to be close to the nuclear envelope, very few
321 copies of plasmid DNA were observed in the nucleus. Microbubbles could also be
322 observed in the cells after at this time point.

323 Figure 8 presents the kinetics of a FITC-labelled pDNA uptake after sonoporation by
324 flow cytometry. When analyzing the cells immediately after sonoporation, 4% of cells
325 were found positive for FITC fluorescence. The maximum of cells carrying
326 sonoporated pDNA is reached (12.5%) upon 3 hours post-sonoporation. This value
327 drops to 9.6% when trypan blue was added to quench the extracellular fluorescence
328 meaning that most of pDNA was internalized at this time. After 6 hours post-
329 sonoporation the percentage of cells carrying pDNA decreased to 3.5%. The mean
330 fluorescence intensity values (MFI) obtained in different conditions without trypan
331 blue treatment followed the same trend as the percentage of fluorescent cells. After 6
332 hours, a decrease of MFI value by 1.5 fold times was observed.

333 ***Endocytosis process involvement during sonoporation***

334 Figure 9 shows the influence of time incubation on gene transfer efficacy. No
335 significant gene transfer efficacy increase was found during the first hour of
336 incubation. However, it was improved 15-times greater when the medium was
337 removed upon 2 hours after sonoporation compared to an immediate washing. When
338 the sonoporation medium was replaced after 4 hours post-sonoporation, it resulted in
339 the highest gene transfer efficacy (1.82×10^8 RLU/mg prot), 328 times higher than
340 when the medium was changed immediately following sonoporation process.

341 A sonoporation in an ATP-depletion condition conducted to a gene transfer efficacy
342 28-fold lower than the control (figure 10A). The use of caveolae pathway inhibitors
343 Filipin III or Genistein had no significant effect on gene transfer by sonoporation
344 (figures 10B and 10C). By contrast, there was a significant and dose-dependent
345 inhibition when the clathrin-dependent endocytosis inhibitor used was
346 chlorpromazine. The gene transfer was significantly decreased by 3, 5 and 140-fold

347 when cells were respectively incubated in presence of 7.5, 10 and 20 µg/mL
348 chlorpromazine (figure 10D) corresponding to a decrease of 70, 82 and 99% of the
349 luciferase expression obtained in control cells (p -value<0.05). No significant inhibition
350 was observed with chlorpromazine concentration of 5 µg/mL. It is worth to note that a
351 significant toxicity of chlorpromazine was obtained using a concentration of 20 µg/mL
352 (approximately 30% of cell viability).

353 We validated the effectiveness of the endocytosis inhibition protocol by testing the
354 effect on the internalization of transferrin, a positive control of the clathrin-dependent
355 endocytosis pathway (data not shown). These conditions led also to an inhibition of
356 transferrin uptake whilst little effect was obtained with cells incubated in the presence
357 of Filipin III.

358 **Discussion**

359 The aim of this study was to investigate cellular events that occur during
360 sonoporation from microbubble-cell interactions, intracellular plasmid DNA routing
361 and transgene expression.

362 ***Optimal parameters determination***

363 The levels of luciferase activity obtained were in the same range as those reported in
364 our previous results obtained with HeLa cells in suspension in the presence of BR14
365 microbubbles (Kaddur *et al.*, 2010). In this study, a plateau was also reached at 40%
366 duty cycle.

367 Duvshani *et al.* obtained also similar results when they performed sonoporation on
368 mouse prostate adenocarcinoma cells although their experiments have been
369 conducted with Optison™ (Duvshani-Eshet and Machluf, 2007). The ultrasound
370 settings used in this study were similar in acoustic pressure, duty cycle and

371 frequency but not for the insonation time that was between 10 to 30 minutes. In
372 another study performed on HeLa cells using SonoVue[®], Li *et al.* have found that a
373 maximum efficacy was obtained for an ultrasonic stimulation of 240 kPa for 7 minutes
374 with a duty cycle of 60%. However, they measured a high toxicity (30% of cell
375 viability) (Li *et al.*, 2009). The high variability that we observed after increasing
376 stimulation time could be explained by an increase in the toxicity induced by
377 sonoporation with time of stimulation. A minimum volume of microbubbles was
378 necessary to reach a good gene transfer efficacy. The microbubble concentration
379 used was similar to that previously obtained on HeLa cells in suspension in the
380 presence of microbubbles BR14 (Kaddur *et al.*, 2010) and the study of Rahim *et al.*
381 performed on CHO cells adherent in the presence of SonoVue[®] (Rahim *et al.*, 2006).
382 The gene transfer efficacy was often decreased when too many microbubbles (above
383 10 μ L) were in the presence of cells due to the formation of microbubble clusters
384 reducing microbubble-cell interactions or either to the cell toxicity as observed
385 previously (Nomikou *et al.*, 2012).

386 Taken together, the results obtained from the optimal acoustic parameters
387 determination reflect the importance of each parameter used in ultrasound
388 effectiveness for gene transfer mediated by sonoporation.

389 ***Microbubble-cell interactions***

390 Depending on the settings used, the microbubble-cell interactions could be changed.
391 Therefore, we established a sonoporation device coupled to a high-speed camera to
392 observe these interactions in real time. The high speed imaging results showed that
393 during ultrasound stimulation (1 MHz, 150 kPa, 40% duty cycle), microbubbles were
394 interacting with cell membranes as observed in our previous studies (Delalande *et al.*,
395 2013; Delalande *et al.*, 2011). At this precise acoustic setting the microbubble entry in

396 cells was preferentially observed and this parameter gave the highest gene transfer.
397 A positive correlation between these two events could mean that the entry of the
398 microbubble while entering directly or indirectly promotes the pDNA delivery into the
399 cell. The microbubble entrance could allow extracellular calcium entry (Fan *et al.*,
400 2012) and this calcium could trigger endocytosis (MacDonald *et al.*, 2005).

401 As we could expect microbubbles do not interact with random areas of the cell. The
402 preferential localization of microbubbles during sonoporation is in lipid raft region.
403 Because oscillating microbubbles are attracted to each other this localization might
404 be explained by the fact that microbubbles are attracted to acoustically active areas
405 in the cell. At this location, plasma membrane is composed of cluster of lipids
406 enriched with cholesterol and sphingomyelin occupying at least 50% of the plasma
407 the membrane (Jurak *et al.*, 2014). These areas are dynamic membrane domains
408 tightly packed by lipid-lipid interactions. Moreover, cholesterol and sphingolipids are
409 known to rigidify the plasma membrane; thus microbubbles could be attracted to
410 these rigid parts of the plasma membrane. Note that lipid raft area has been reported
411 to be active in terms of endocytosis process (Ares and Ortiz, 2012). This hypothesis
412 is in line with the sonophore formation in the plasma membrane described by
413 Krasovitski *et al.* (Krasovitski *et al.*, 2011). Sonophores are the expansion of a gap
414 between the two membranes leaflets due to cavitation during the ultrasound negative
415 peak pressure; this expansion stretches the plasma membrane until rupture to create
416 a pore. Sonophores could be mainly formed either in the vicinity or in lipid raft areas
417 and therefore attract microbubbles to this location. Microbubbles could be attracted to
418 these areas because oscillating sonophores act like oscillating microbubble, due to
419 the clustering phenomenon because in-phase oscillating objects are clustering
420 (Kotopoulis and Postema, 2010). Moreover oscillating microbubble interacts

421 differently when in contact to a surface for example microbubbles will collapse
422 asymmetrically next to rigid surface (Prentice *et al.*, 2005). We could imagine that the
423 cell surface rigidity mismatch between lipid raft areas and the rest of the cell could
424 create a preferential interaction site with microbubbles.

425 ***Plasmid DNA cellular routing after sonoporation***

426 A key to success of this delivery method lies in understanding not only the
427 mechanism governing microbubble and cell interactions but also the fate of pDNA
428 after sonoporation. The internalization process of the plasmid DNA after sonoporation
429 was found to be a slow phenomenon. 4 hours of interaction time between plasmid
430 DNA and the cells was needed to get the maximum of gene transfer efficacy and flow
431 cytometry analyses showed that the plasmid DNA was mainly internalized after 3
432 hours. Real-time confocal microscopy investigations showed that pDNA was mainly
433 localized at the plasma membrane straightaway following sonoporation and these
434 spots could progressively move inside cells as we have observed previously
435 (Delalande *et al.*, 2013). These structures could correspond either to vesicles
436 (endosome) or aggregates-like structures upon sonoporation. The presence of free
437 pDNA not co-localized with Rab7-eGFP vesicles observed in figures 6A and 6C
438 indicates that some of them might be able to escape the lysosome pathway or they
439 could also be the result of a direct entrance across the plasma membrane during the
440 sonoporation. The presence of microbubbles and pDNA inside cells raises the
441 question about their cellular entry pathway. The kinetics of pDNA uptake shows that
442 only the combination of ultrasound and microbubbles was able to efficiently drive
443 pDNA inside the cells.

444 Our observations indicated also that pDNA were not observed into the nucleus, spots
445 were close to the nucleus as indicated by their localization in the vicinity of nuclear

446 envelope delimited by Nup153-eGFP. However, we found in the same conditions a
447 good gene transfer efficiency meaning that pDNA reach the nucleus this discrepancy
448 could be due to a weaker fluorescent signal when the plasmid DNA reaches the
449 nucleus (Maury *et al.*, 2014). The amount of pDNA found close to or inside the
450 nucleus was not abundant compared to the pDNA entered into the cell observed at
451 earlier time points suggesting a massive degradation or efflux of pDNA as observed
452 after 6 hours by the decrease of MFI value by 1.5 fold times. However, this decrease
453 was not as much as the one observed for the cell percentage which dropped from 9.6
454 at 3 hours to 3.5% at 6 hours. This reveals that some cells, likely those that had
455 internalized a low amount of pDNA, have lost completely their content as indicated by
456 the reduction of the cell percentage. The sonoporation efficacy could be improved at
457 this step. In our study, the routing of the pDNA to the nucleus was also facilitated by
458 the presence of optimal NF κ B binding consensus sequence put upstream of the CMV
459 promoter of the luciferase coding sequence (Goncalves *et al.*, 2009).

460 The maximum of cells carrying sonoporated pDNA is reached (12.5%) upon 3 hours
461 post-sonoporation as a consequence of internalization process. When considering
462 the values obtained after trypan blue treatment, the increase of MFI value after 3
463 hours was not as much as that observed with the percentage of cells. This
464 observation suggests that during 3 hours after sonoporation, a new cell population
465 took up pDNA via endocytosis process as validated by the increase of FITC-positive
466 cell percentage. However, the amount of pDNA internalized during 3 hours was not
467 very much higher than that occurred during the sonoporation process as indicated by
468 the very slight increase of MFI value. This is in agreement with the fact that free
469 pDNA were hardly up taken by cells and that microbubbles could not bind to pDNA to
470 improve its internalization.

471 ***Involvement of endocytosis during sonoporation process***

472 The impact of endocytosis on the sonoporation efficacy was shown in two ways.

473 After 6 hours the quantity of cells carrying plasmid DNA drops to 3.5% probably
474 because of the degradation of the internalized pDNA. Free pDNA lifetime in cytosol
475 has been estimated to be between 50 and 90 min (Lechardeur *et al.*, 1999). A part of
476 pDNA endocytosed in Rab7 vesicles, as observed in figure 6C, may also reach the
477 lysosome pathway to be degraded (Bucci *et al.*, 2000).

478 The use of endocytosis inhibitors showed that the main endocytosis pathway routing
479 plasmid DNA was the clathrin-dependent pathway. The lack of significant gene
480 transfer inhibition using caveolae inhibitors was unexpected because of the
481 preferential localization of microbubbles observed in the lipid raft area. A correlation
482 between this localization and caveolae endocytosis would have been expected
483 (Lajoie and Nabi, 2010). The results obtained with chlorpromazine are in the same
484 line as those obtained by Meijering *et al.*; they have reported that a 50% inhibition of
485 500-kDa dextran delivery by sonoporation was obtained when endothelial cells were
486 treated with chlorpromazine (Meijering *et al.*, 2009). In contrast to our results, these
487 authors have observed an inhibition with the Filipin III, this difference could be due to
488 the size of the molecule transferred that was smaller (500 kDa for the dextran *versus*
489 3 MDa for the plasmid) and/or to the difference in cell type used. The reason why
490 clathrin-dependent endocytosis pathway is more effective to deliver plasmid DNA
491 rather than the caveolae pathway remains unknown. For example, the endocytosis
492 route of lipoplexes or polyplexes can be different in function of their chemical
493 composition (Billiet *et al.*, 2012).

494 The main limitation of this study lies in the fact that all the experiments have been
495 done in separate experiments. A single-cell study of the sonoporation process would
496 be the best to prove the correlation between all the phenomena observed.

497 **Conclusion**

498 We have found the optimal ultrasound parameters in our set-up for an efficient gene
499 delivery on HeLa adherent cells. This study showed the cell-microbubbles
500 interactions and the intracellular fate of microbubbles and pDNA during and after the
501 sonoporation process. A set-up combining high speed camera coupled with confocal
502 fluorescence microscopy has allowed us to observe that depending on the acoustic
503 pressure used, some microbubble were forced to enter the cell during sonoporation
504 whilst other were stuck at the plasma membrane. The microbubbles were found to
505 enter in cells only in the best conditions of transfection suggesting that the
506 microbubble entry could be closely correlated to the pDNA entry into the cell. By
507 combining fluorescent pDNA with cellular tools exhibiting fluorescent intracellular
508 compartments, confocal microscopy observations and uptake experiments indicated
509 that the pDNA were taken up by cells through clathrin-mediated-endocytosis pathway
510 as confirmed by their localization inside late endosomes and the effect of the
511 pharmacological inhibitors. It is worth noting that the observations made in this study
512 may not be translated to other nucleic acids and particularly for small molecules
513 oligonucleotides as siRNA. Knowing this intracellular fate of microbubble and pDNA
514 will be helpful for a rational design of potent sonoporation for gene delivery that might
515 be combined with molecular imaging.

516

517

518 **Acknowledgements**

519 The authors thank the French “Région Centre” and National Research Agency for
520 funding.

521 **References**

- 522 Afadzi M, Strand SP, Nilssen EA, Masoy SE, Johansen TF, Hansen R, Angelsen BA, Davies
523 CD. Mechanisms of the Ultrasound-Mediated Intracellular Delivery of Liposomes and
524 Dextrans. *IEEE Trans. Ultrason. Ferroelectr. Freq. Control* 2013;60:21-33.
- 525 Antes P, Schwarzmann G, Sandhoff K. Detection of protein mediated glycosphingolipid
526 clustering by the use of resonance energy transfer between fluorescent labelled lipids.
527 A method established by applying the system ganglioside GM1 and cholera toxin B
528 subunit. *Chem Phys Lipids* 1992;62:269-80.
- 529 Ares GR, Ortiz PA. Dynamin2, Clathrin, and Lipid Rafts Mediate Endocytosis of the Apical
530 Na/K/2Cl Cotransporter NKCC2 in Thick Ascending Limbs. *J. Biol. Chem.*
531 2012;287:11.
- 532 Bao S, Thrall BD, Miller DL. Transfection of a reporter plasmid into cultured cells by
533 sonoporation in vitro. *Ultrasound Med Biol* 1997;23:953-9.
- 534 Billiet L, Gomez JP, Berchel M, Jaffres PA, Le Gall T, Montier T, Bertrand E, Cheradame H,
535 Guegan P, Mevel M, Pitard B, Benvegna T, Lehn P, Pichon C, Midoux P. Gene
536 transfer by chemical vectors, and endocytosis routes of polyplexes, lipoplexes and
537 lipopolyplexes in a myoblast cell line. *Biomaterials* 2012;33:2980-90.
- 538 Bolte S, Cordelieres FP. A guided tour into subcellular colocalization analysis in light
539 microscopy. *Journal of microscopy* 2006;224:213-32.
- 540 Bucci C, Thomsen P, Nicoziani P, McCarthy J, van Deurs B. Rab7: a key to lysosome
541 biogenesis. *Mol Biol Cell* 2000;11:467-80.
- 542 Delalande A, Bouakaz A, Renault G, Tabareau F, Kotopoulis S, Midoux P, Arbeille B,
543 Uzbekov R, Chakravarti S, Postema M, Pichon C. Ultrasound and microbubble-
544 assisted gene delivery in Achilles tendons: Long lasting gene expression and
545 restoration of fibromodulin KO phenotype. *J Control Release* 2011;156:223-30.
- 546 Delalande A, Kotopoulis S, Postema M, Midoux P, Pichon C. Sonoporation: Mechanistic
547 insights and ongoing challenges for gene transfer. *Gene* 2013;525:191-9.
- 548 Delalande A, Kotopoulis S, Rovers T, Pichon C, Postema M. Sonoporation at a low
549 mechanical index. *Bubble science, Engineering and Technology* 2011;3:3-11.
- 550 Delalande A, Postema M, Mignet N, Midoux P, Pichon C. Ultrasound and microbubble-
551 assisted gene delivery: recent advances and ongoing challenges. *Therapeutic*
552 *Delivery* 2012;3:1199-215.
- 553 Duvshani-Eshet M, Machluf M. Efficient transfection of tumors facilitated by long-term
554 therapeutic ultrasound in combination with contrast agent: from in vitro to in vivo
555 setting. *Cancer gene therapy* 2007;14:306-15.
- 556 Fan Z, Liu H, Mayer M, Deng CX. Spatiotemporally controlled single cell sonoporation. *Proc*
557 *Natl Acad Sci U S A* 2012;109:16486-91.
- 558 Goncalves C, Ardourel MY, Decoville M, Breuzard G, Midoux P, Hartmann B, Pichon C. An
559 optimized extended DNA kappa B site that enhances plasmid DNA nuclear import
560 and gene expression. *J Gene Med* 2009;11:401-11.
- 561 Ivanov AI. Pharmacological inhibition of endocytic pathways: is it specific enough to be
562 useful? *Methods in molecular biology* (Clifton, N.J 2008;440:15-33.
- 563 Juffermans LJ, Meijering DB, van Wamel A, Henning RH, Kooiman K, Emmer M, de Jong N,
564 van Gilst WH, Musters R, Paulus WJ, van Rossum AC, Deelman LE, Kamp O.
565 Ultrasound and microbubble-targeted delivery of therapeutic compounds: ICIN Report

- 566 Project 49: Drug and gene delivery through ultrasound and microbubbles. *Neth Heart*
567 *J* 2009;17:82-6.
- 568 Jurak M, Golabek M, Holysz L, Chibowski E. Properties of Langmuir and solid supported lipid
569 films with sphingomyelin. *Advances in colloid and interface science* 2014.
- 570 Kaddur K, Lebegue L, Tranquart F, Midoux P, Pichon C, Bouakaz A. Transient
571 transmembrane release of green fluorescent proteins with sonoporation. *IEEE Trans*
572 *Ultrason Ferroelectr Freq Control* 2010;57:1558-67.
- 573 Kotopoulis S, Postema M. Microfoam formation in a capillary. *Ultrasonics* 2010;50:260-8.
- 574 Krasovitski B, Frenkel V, Shoham S, Kimmel E. Intramembrane cavitation as a unifying
575 mechanism for ultrasound-induced bioeffects. *Proc Natl Acad Sci U S A*
576 2011;108:3258-63.
- 577 Kurosaki T, Kawakami S, Higuchi Y, Suzuki R, Maruyama K, Sasaki H, Yamashita F,
578 Hashida M. Development of anionic bubble lipopolyplexes for efficient and safe gene
579 transfection with ultrasound exposure in mice. *Journal of Controlled Release*
580 2014;176:24-34.
- 581 Lajoie P, Nabi IR. (2010) LIPID RAFTS, CAVEOLAE, AND THEIR ENDOCYTOSIS, In: Jeon
582 KW, ed. *International Review of Cell and Molecular Biology, Vol 282*. San Diego:
583 Elsevier Academic Press Inc, 135-63.
- 584 Lechardeur D, Sohn KJ, Haardt M, Joshi PB, Monck M, Graham RW, Beatty B, Squire J,
585 O'Brodovich H, Lukacs GL. Metabolic instability of plasmid DNA in the cytosol: a
586 potential barrier to gene transfer. *Gene Ther* 1999;6:482-97.
- 587 Li YS, Davidson E, Reid CN, McHale AP. Optimising ultrasound-mediated gene transfer
588 (sonoporation) in vitro and prolonged expression of a transgene in vivo: potential
589 applications for gene therapy of cancer. *Cancer Lett* 2009;273:62-9.
- 590 MacDonald PE, Eliasson L, Rorsman P. Calcium increases endocytotic vesicle size and
591 accelerates membrane fission in insulin-secreting INS-1 cells. *J Cell Sci*
592 2005;118:5911-20.
- 593 Maury B, Goncalves C, Tresset G, Zeghal M, Cheradame H, Guegan P, Pichon C, Midoux P.
594 Influence of pDNA availability on transfection efficiency of polyplexes in non-
595 proliferative cells. *Biomaterials* 2014;35:5977-85.
- 596 Mehier-Humbert S, Bettinger T, Yan F, Guy RH. Plasma membrane poration induced by
597 ultrasound exposure: implication for drug delivery. *J Control Release* 2005;104:213-
598 22.
- 599 Meijering BD, Juffermans LJ, van Wamel A, Henning RH, Zuhorn IS, Emmer M, Versteilen
600 AM, Paulus WJ, van Gilst WH, Kooiman K, de Jong N, Musters RJ, Deelman LE,
601 Kamp O. Ultrasound and microbubble-targeted delivery of macromolecules is
602 regulated by induction of endocytosis and pore formation. *Circ Res* 2009;104:679-87.
- 603 Miller DL, Bao S, Morris JE. Sonoporation of cultured cells in the rotating tube exposure
604 system. *Ultrasound Med Biol* 1999;25:143-9.
- 605 Noble ML, Kuhr CS, Graves SS, Loeb KR, Sun SS, Keilman GW, Morrison KP, Paun M,
606 Storb RF, Miao CH. Ultrasound-targeted microbubble destruction-mediated gene
607 delivery into canine livers. *Mol Ther* 2013;21:1687-94.
- 608 Nomikou N, Tiwari P, Trehan T, Gulati K, McHale AP. Studies on neutral, cationic and
609 biotinylated cationic microbubbles in enhancing ultrasound-mediated gene delivery in
610 vitro and in vivo. *Acta Biomater* 2012;8:1273-80.

- 611 Paula DM, Valero-Lapchik VB, Paredes-Gamero EJ, Han SW. Therapeutic ultrasound
612 promotes plasmid DNA uptake by clathrin-mediated endocytosis. *J Gene Med*
613 2011;13:392-401.
- 614 Pichon C, Kaddur K, Midoux P, Tranquart F, Bouakaz A. Recent advances in gene delivery
615 with ultrasound and microbubbles. *J. Exp. Nanosci.* 2008;3:17-40.
- 616 Postema M, Gilja OH. Ultrasound-directed drug delivery. *Current pharmaceutical*
617 *biotechnology* 2007;8:355-61.
- 618 Prentice P, Cuschierp A, Dholakia K, Prausnitz M, Campbell P. Membrane disruption by
619 optically controlled microbubble cavitation. *Nat. Phys.* 2005;1:107-10.
- 620 Rahim A, Taylor SL, Bush NL, ter Haar GR, Bamber JC, Porter CD. Physical parameters
621 affecting ultrasound/microbubble-mediated gene delivery efficiency in vitro.
622 *Ultrasound Med Biol* 2006;32:1269-79.
- 623 Taniyama Y, Tachibana K, Hiraoka K, Namba T, Yamasaki K, Hashiya N, Aoki M, Ogihara T,
624 Yasufumi K, Morishita R. Local delivery of plasmid DNA into rat carotid artery using
625 ultrasound. *Circulation* 2002;105:1233-9.
- 626 Van Amersfoort ES, Van Strijp JA. Evaluation of a flow cytometric fluorescence quenching
627 assay of phagocytosis of sensitized sheep erythrocytes by polymorphonuclear
628 leukocytes. *Cytometry* 1994;17:294-301.
- 629 Wang X, Liang HD, Dong B, Lu QL, Blomley MJ. Gene transfer with microbubble ultrasound
630 and plasmid DNA into skeletal muscle of mice: comparison between commercially
631 available microbubble contrast agents. *Radiology* 2005;237:224-9.
- 632 Zhou Y, Kumon RE, Cui J, Deng CX. The Size of Sonoporation Pores on the Cell Membrane.
633 *Ultrasound Med Biol* 2009.
- 634

635 **Figure captions**

636 **Figure 1** - *In vitro* sonoporation set-up used for gene transfer experiments.

637 **Figure 2** - *In vitro* set-up used for high-speed imaging experiments. The top panel
638 represents an overview of the devices used; the bottom panel is a close-up view of
639 the water tank mounted on the microscope.

640 **Figure 3** - Optimal sonoporation parameters determination. (A) Influence of the
641 acoustic pressure (parameters: 5 μ L MB, 60 sec, 40% DC, 2.5 μ g pDNA). (B)
642 Influence of the time of insonation (parameters: 150 kPa, 5 μ L MB, 40% DC, 2.5 μ g
643 pDNA). (C) Influence of the duty cycle (DC) (parameters: 150 kPa, 60 sec, 5 μ L MB,
644 2.5 μ g pDNA). (D) Influence of the concentration in microbubbles (parameters: 150
645 kPa, 60 sec, 40% DC, 2.5 μ g pDNA). Values shown represent means of 3
646 experiments done in duplicates.

647 **Figure 4** - Sequences of images of HeLa cells in the presence of microbubbles; (A)
648 images taken during an ultrasound stimulation at 100 kPa, the microbubble
649 surrounded interacts with the plasma membrane by cellular "massage"; (B) images
650 taken during an ultrasound stimulation at 150 kPa, the arrowed microbubbles shrink
651 before entering in the cell; (C) images taken during an ultrasound stimulation at 200
652 kPa, a microbubble interacts with a cell and detaches it from its support. The arrows
653 show the microbubbles to observe over time. The time displayed corresponds to the
654 value after the start of the ultrasound stimulation.

655 **Figure 5** – Localization of MB to cell membrane interaction area after sonoporation
656 by confocal microscopy. (A) Lipid raft areas were labelled by RhodB-cholera toxin
657 subunit B (red) and MB were labelled with DiD (blue). (B) A high level of
658 colocalization (purple) between MB and lipid rafts was found showing that during

659 ultrasound stimulation MB are preferentially interacting with cell membrane in lipid
660 rafts areas. The white rectangle shows a magnified view of the plasma membrane
661 used for the colocalization analysis ($r=0.70$).

662 **Figure 6** - Localization of pDNA relative to late endosomes. HeLaRab7-eGFP cells
663 were sonoporated at optimal acoustic parameters in presence of 2.5 μ g of Cy3-
664 tagged pDNA and microbubble. Green and red staining correspond to Rab7-eGFP
665 positive late endosomes and pDNA-Cy3, respectively. Yellow color corresponds to a
666 co-localization of pDNA and Rab7 (arrows). Confocal microscopy observations were
667 made either immediately after sonoporation (A, B) or 3 hours post-sonoporation (C,
668 D). A and C: phase contrast images; B and D: merge of green (Rab7-eGFP) and red
669 (pDNA-Cy3) fluorescence images. White dotted lines in the right frames indicate the
670 cell plasma membrane boundary and the arrows show colocalization spots between
671 Rab7-GFP endosomes and pDNA-Cy3.

672 **Figure 7** - Localization of pDNA relative to the nucleus 6 h post-sonoporation.
673 HeLaNup153-eGFP cells were sonoporated at optimal acoustic parameters in
674 presence of 2.5 μ g of Cy3-tagged pDNA and DiD labelled microbubbles (blue). The
675 green staining corresponds to Nup153-eGFP, which delimits the cell nucleus. Some
676 plasmids were found close to the nucleus 6 hours after sonoporation. Microbubbles
677 were still found in the cytoplasm and in the nucleus 6 hours after sonoporation. A:
678 phase contrast image, B: merge of green (Nup153-eGFP), red (pDNA-Cy3) and blue
679 (MB-DiD) fluorescence images.

680 **Figure 8** – Analysis of plasmid DNA internalization after sonoporation. Cells were
681 sonoporated using the optimal acoustic parameters with 2.5 μ g of FITC labelled
682 plasmid DNA. The presence of plasmid DNA on cells was analyzed by flow cytometry
683 immediately (white), 3 (grey) and 6 (black) hours after sonoporation in presence or

684 not of trypan blue. Trypan blue was used to quench FITC fluorescence from plasma
685 membrane; the remaining fluorescence corresponds to internalized plasmid DNA.
686 The histograms represent the percentage of FITC-positive cells and the squares
687 represent the mean fluorescence intensity (MFI) of the cells in each condition.

688 **Figure 9** – Gene transfer efficacy by the function of sonoporation medium incubation
689 time. The cell medium was replaced by fresh medium immediately (0), 0.5, 1, 2 or 4
690 hours after sonoporation. The gene transfer efficacy was evaluated 24 hours after
691 sonoporation and expressed as RLU/mg prot. The values represent means and
692 standard error of at least 3 experiments.

693 **Figure 10** - Effect of cellular ATP depletion and endocytosis inhibitors on the efficacy
694 of gene transfer by sonoporation (A: ATP depletion; B: Filipin III; C: Genistein; D:
695 Chlorpromazine). Parameters used: 1 MHz, 60 sec, 150 kPa, 40% DC, 5 μ L MB, 10
696 μ g pDNA. The gene transfer efficacy and the cell viability were determined 24 hours
697 after sonoporation. Values represent mean of luciferase activity in RLU/mg prot. *:
698 statistical difference compared to control with a p -value < 0.05.

699 **Supplementary video 1.**

700 The video shows 3 sequences of images of HeLa cells in the presence of
701 microbubbles; (1) images taken during an ultrasound stimulation at 100 kPa, the
702 microbubble surrounded interacts with the plasma membrane by cellular "massage";
703 (2) images taken during an ultrasound stimulation at 150 kPa, the arrowed
704 microbubbles shrink before entering in the cell; (3) images taken during an ultrasound
705 stimulation at 200 kPa, a microbubble interacts with a cell and detaches it from its
706 support.

707

708 **Table 1.**

Peak negative acoustic pressure (kPa)	Gene transfer efficacy (RLU/mg proteins)	Microbubble-cell interaction type observed			Videos recorded (n)
		Microbubble stuck to cell membrane (%)	Microbubble entry to cell (%)	Violent microbubble-cell interactions (%)	
100	3.2×10^4	86	14	0	9
150	1.8×10^6	39	43	18	45
200	1.9×10^5	33	24	53	21

709 Table 1. Comparison between gene transfer efficacy values and microbubble-cell interaction type observed by

710 high speed imaging.

Figure 1

[Click here to download Figure: Figure 1.pdf](#)

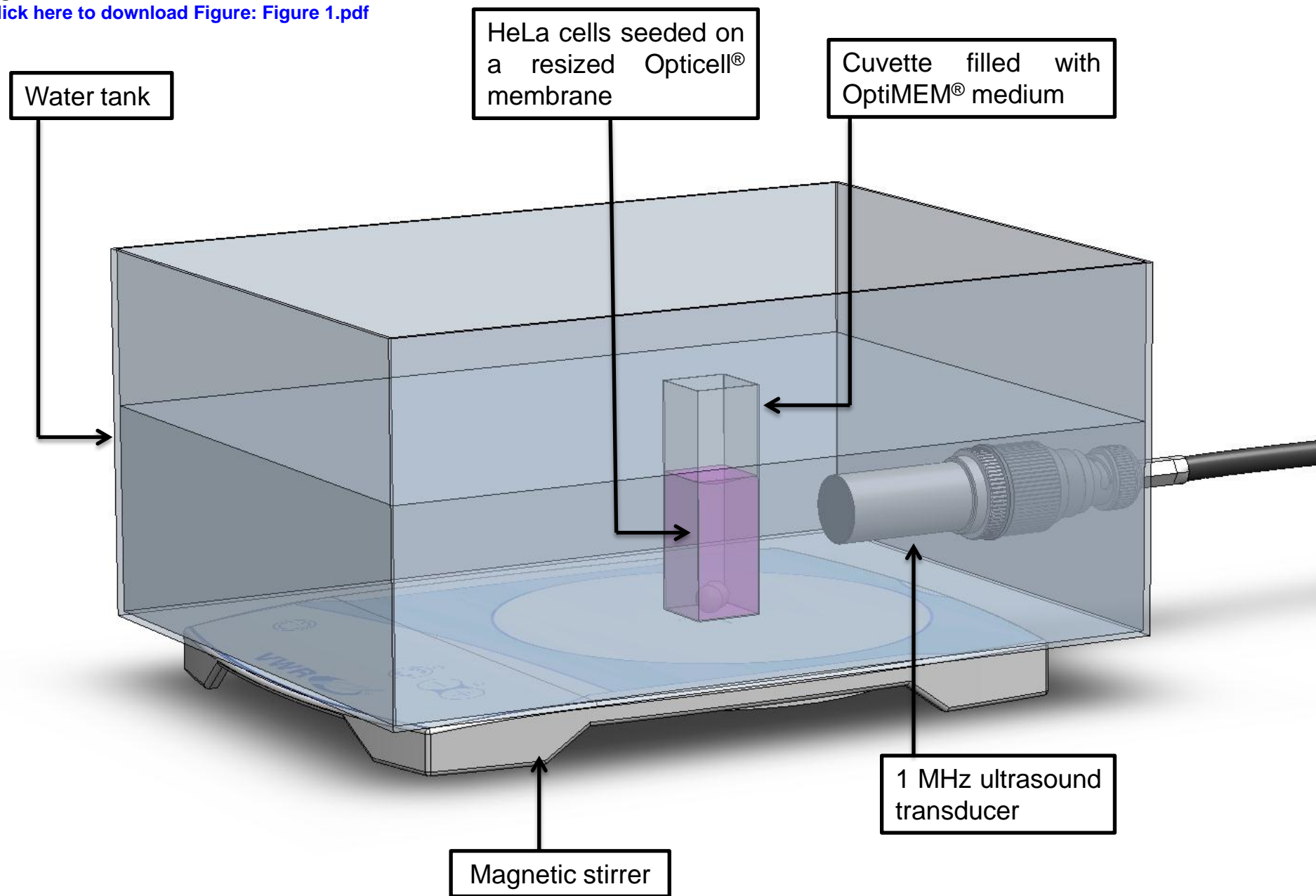


Figure 2
[Click here to download high resolution image](#)

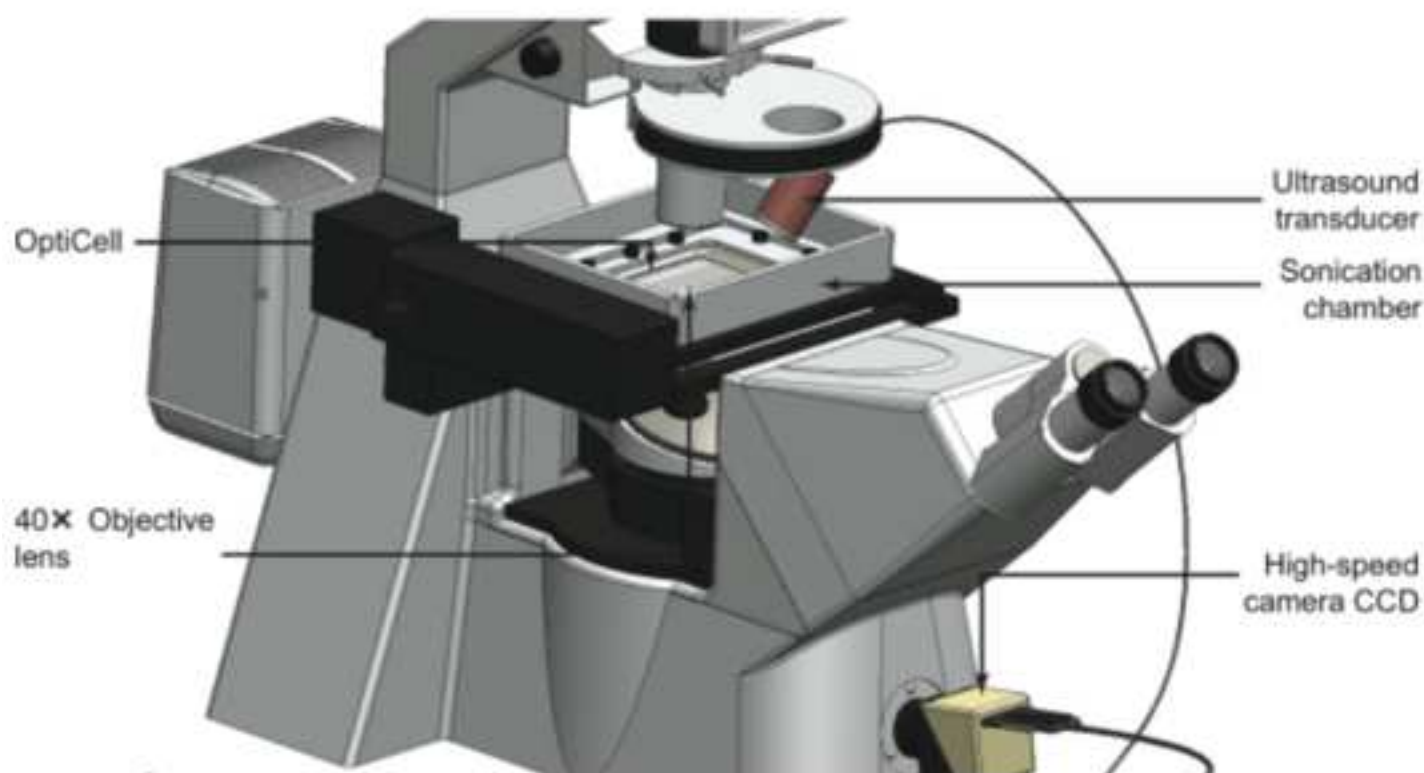
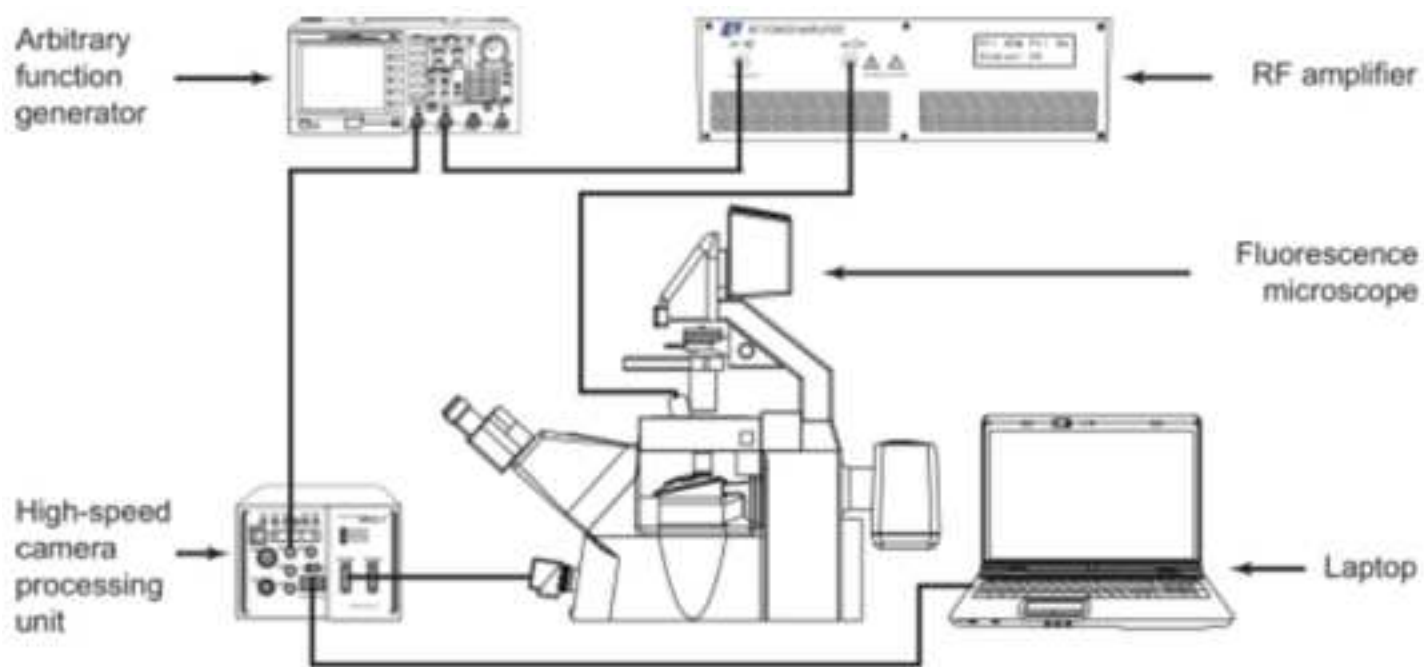


Figure 3
[Click here to download Figure: Figure 3.pdf](#)

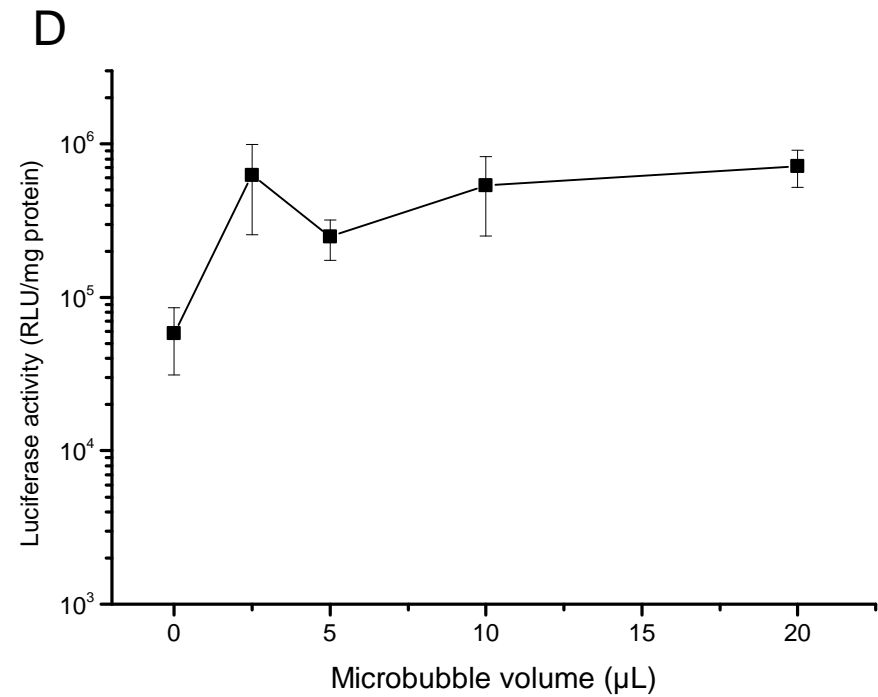
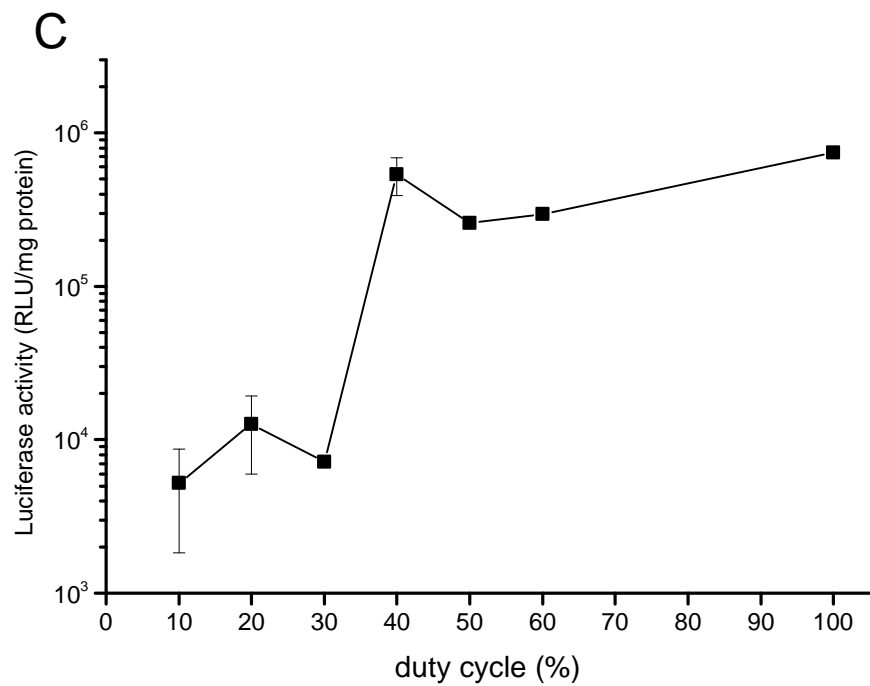
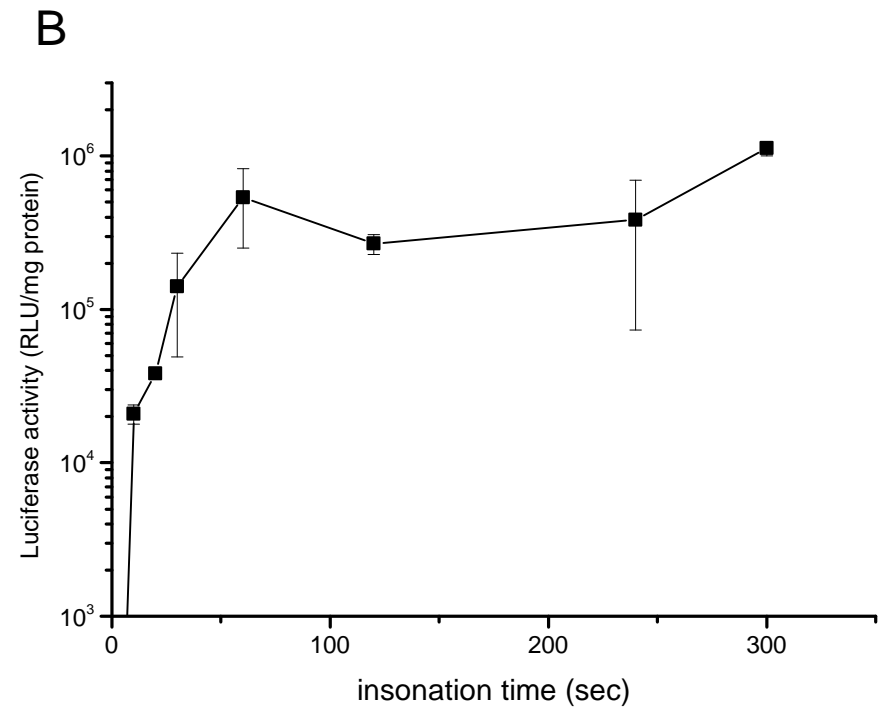
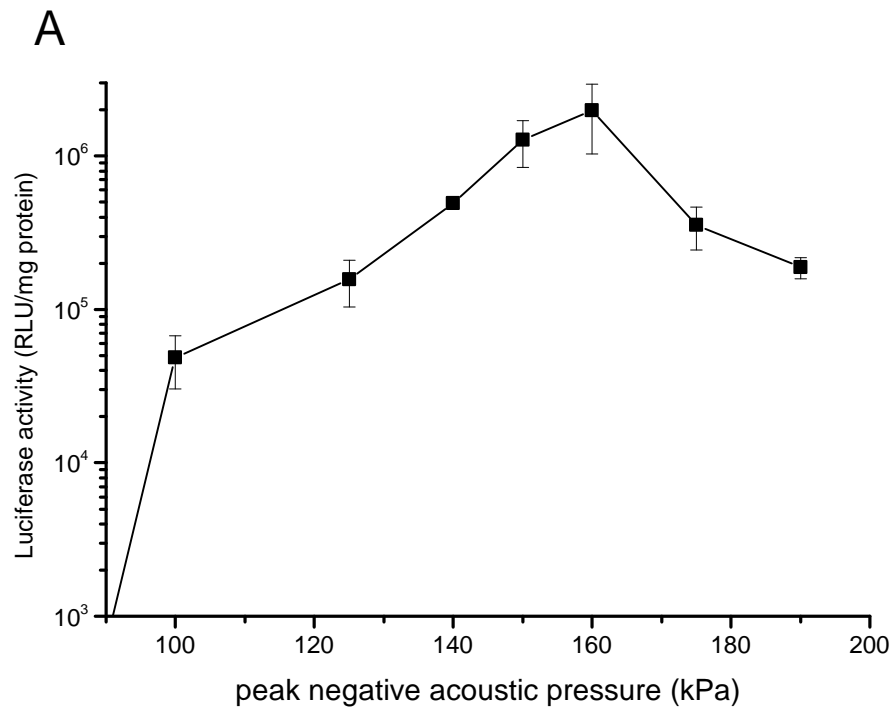


Figure 4
[Click here to download Figure: Figure 4rev2.pdf](#)

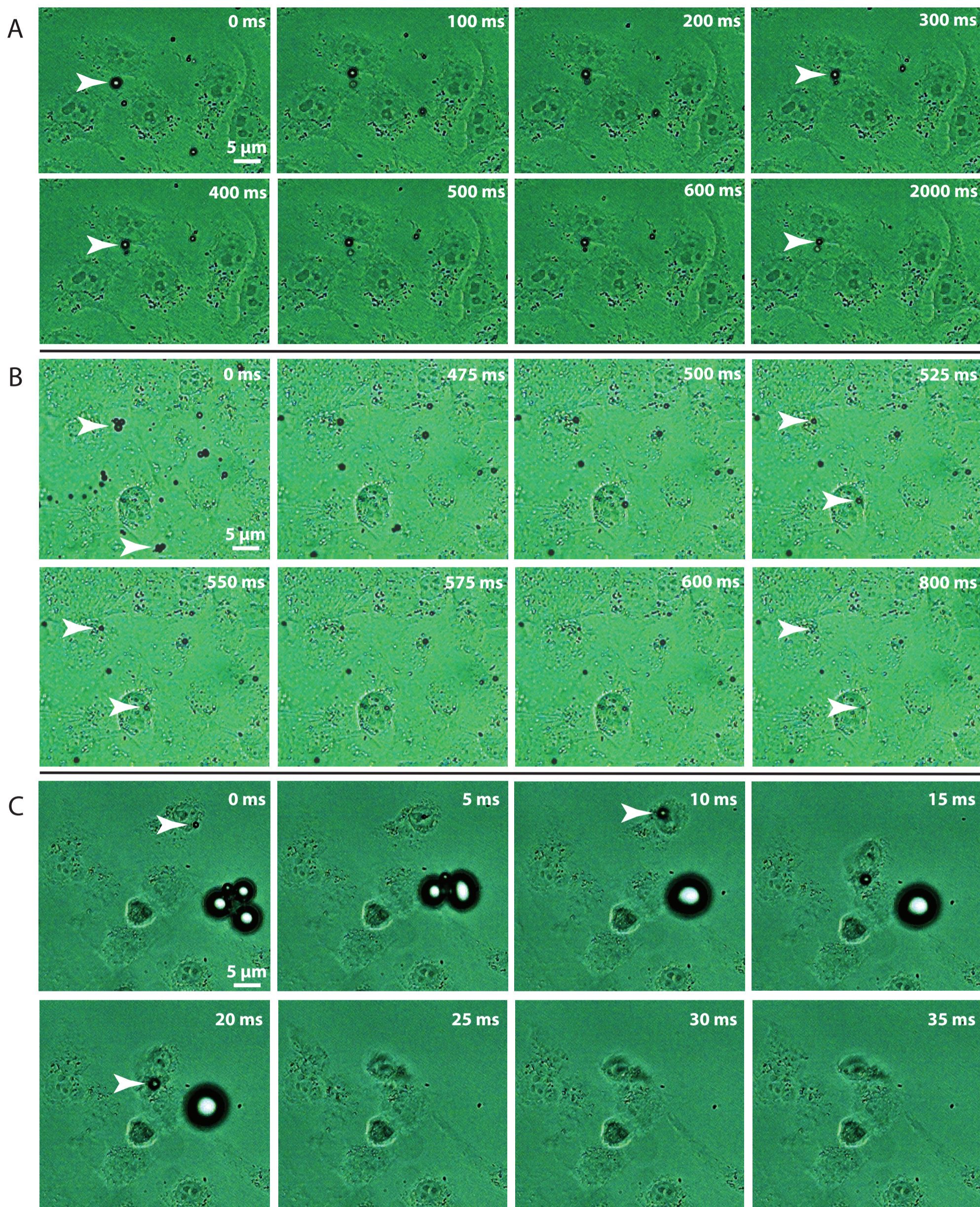


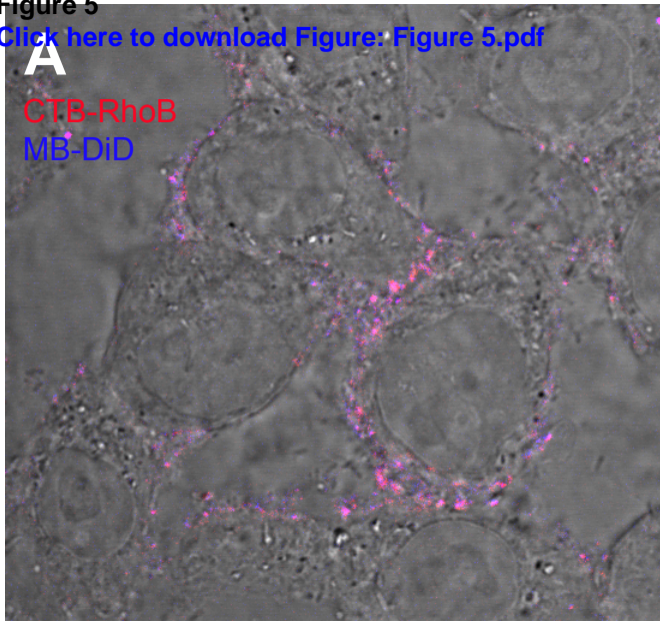
Figure 5

[Click here to download Figure: Figure 5.pdf](#)

A

CTB-RhoB

MB-DiD



B

zoom

$r=0.70$

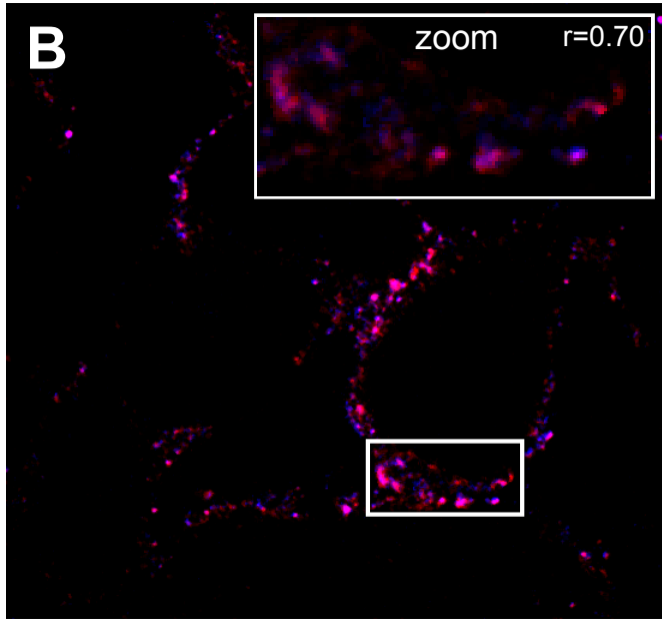
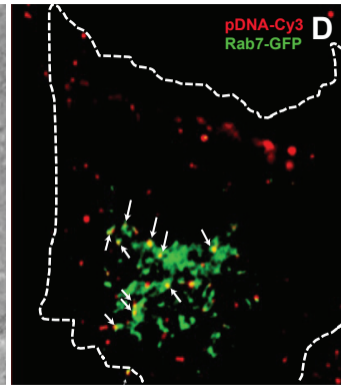
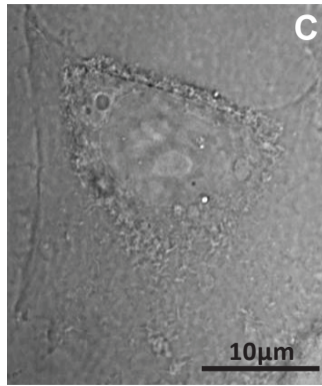
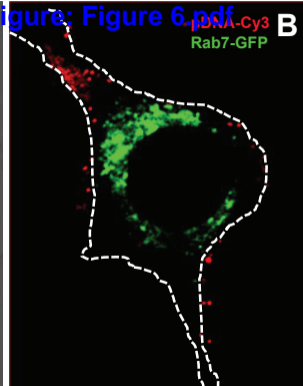
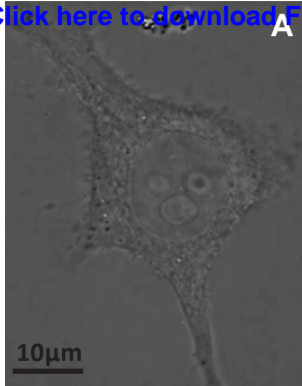


Figure 6

[Click here to download Figure: Figure 6.pdf](#)



A10 μm

pDNA-Cy3

Nup153-GFP

MB-DiD

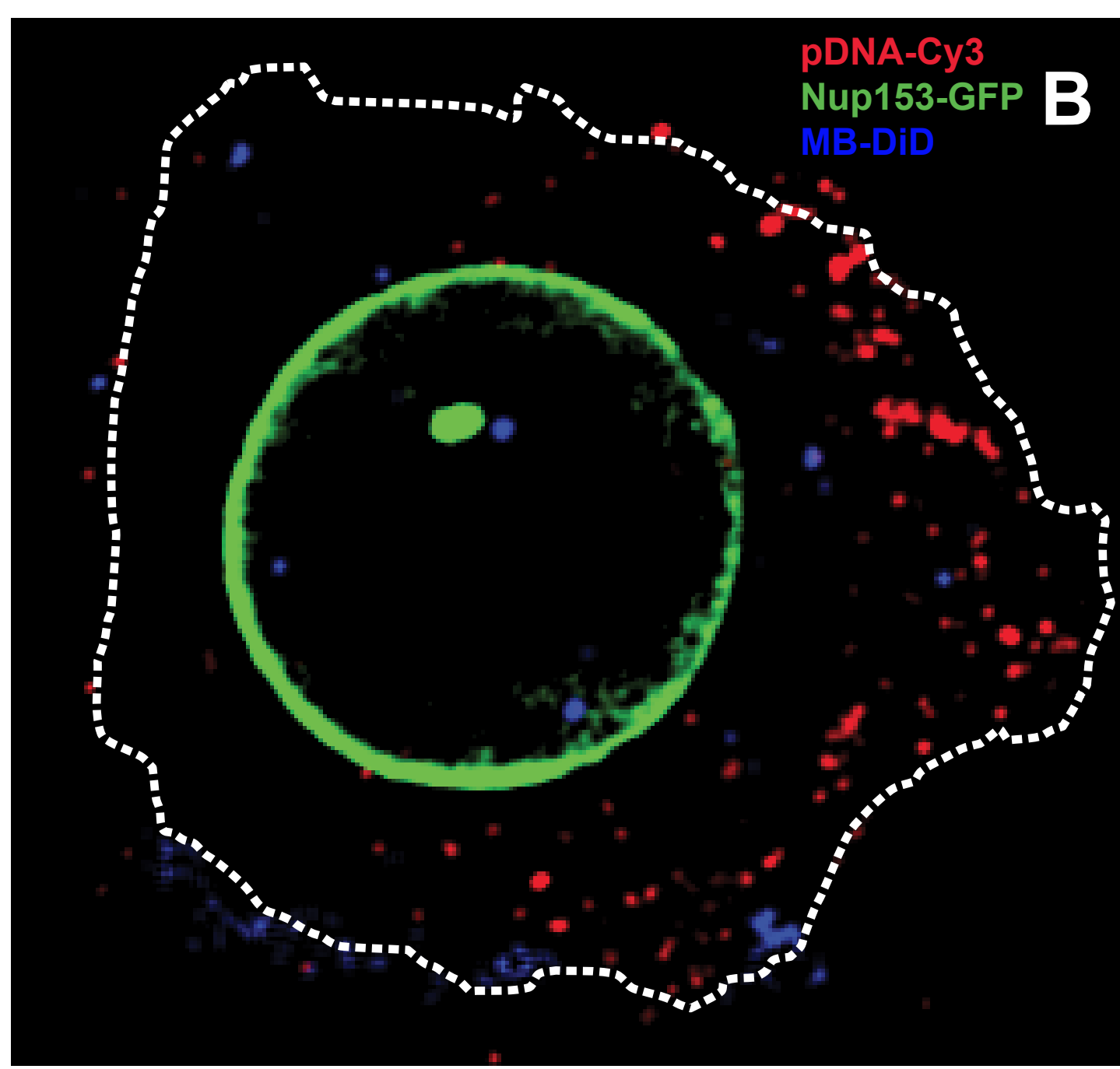
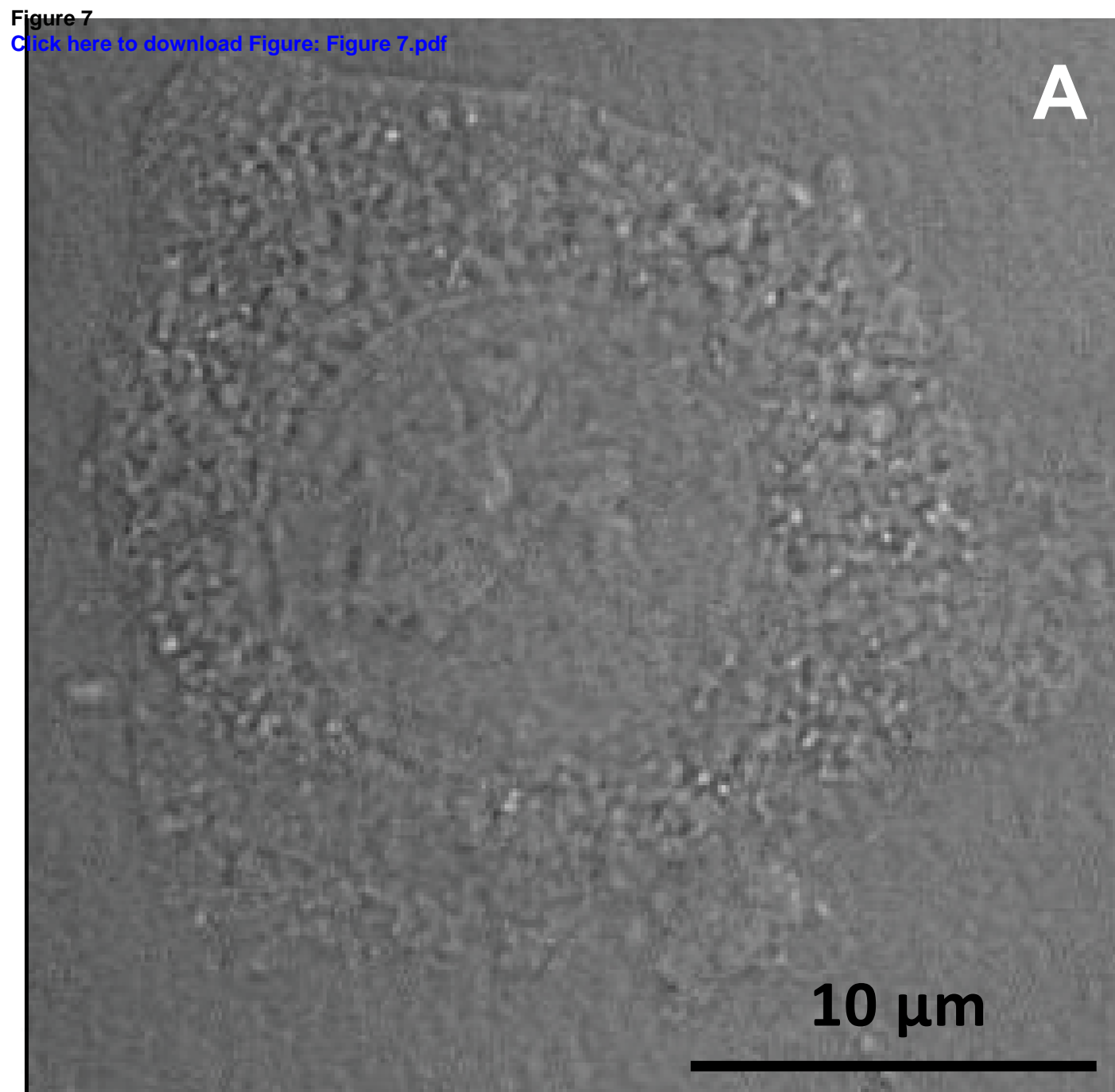
B

Figure 8
[Click here to download Figure: Figure 8-06-06-14-19-40.pdf](#)

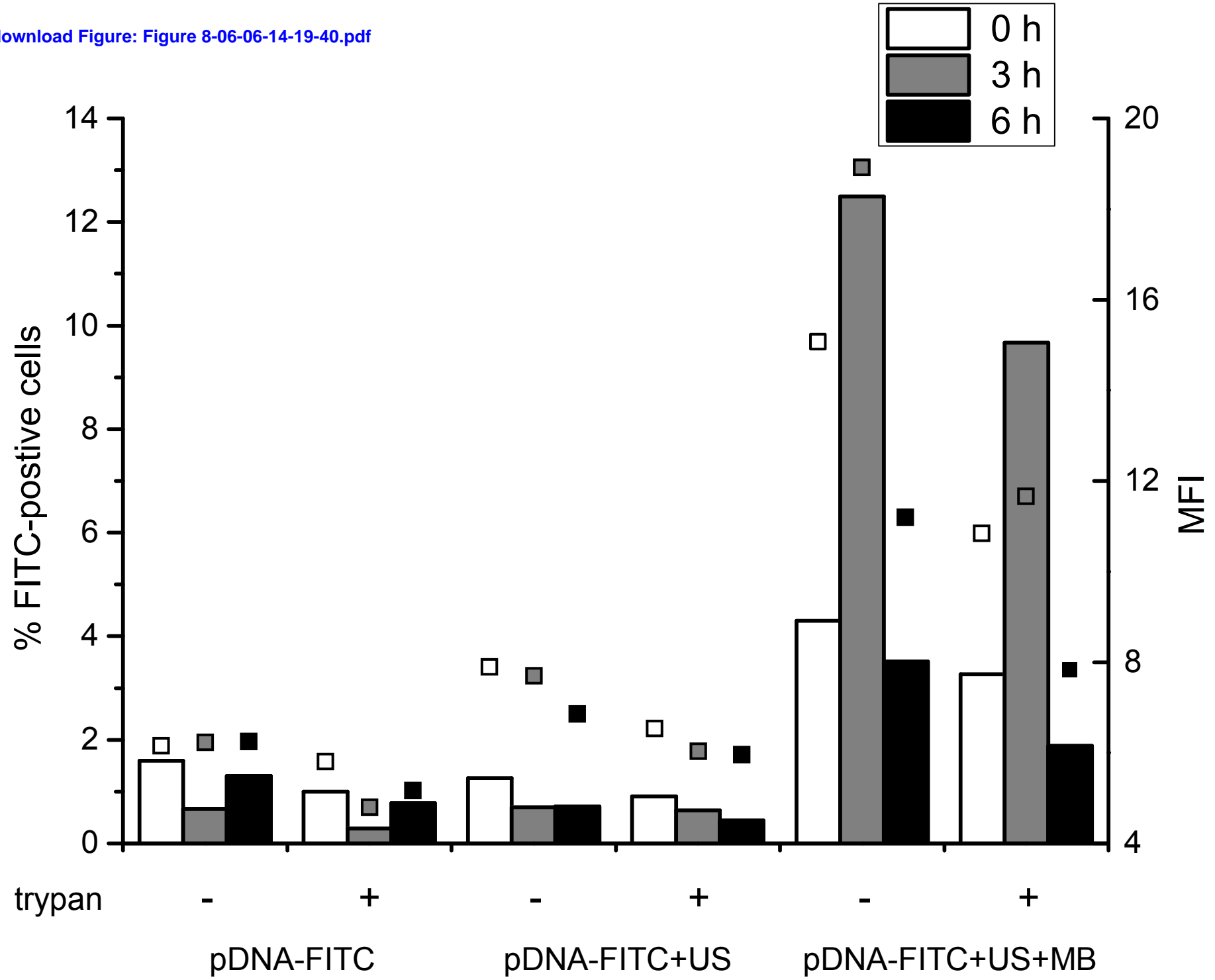


Figure 9
[Click here to download Figure: Figure 9.pdf](#)

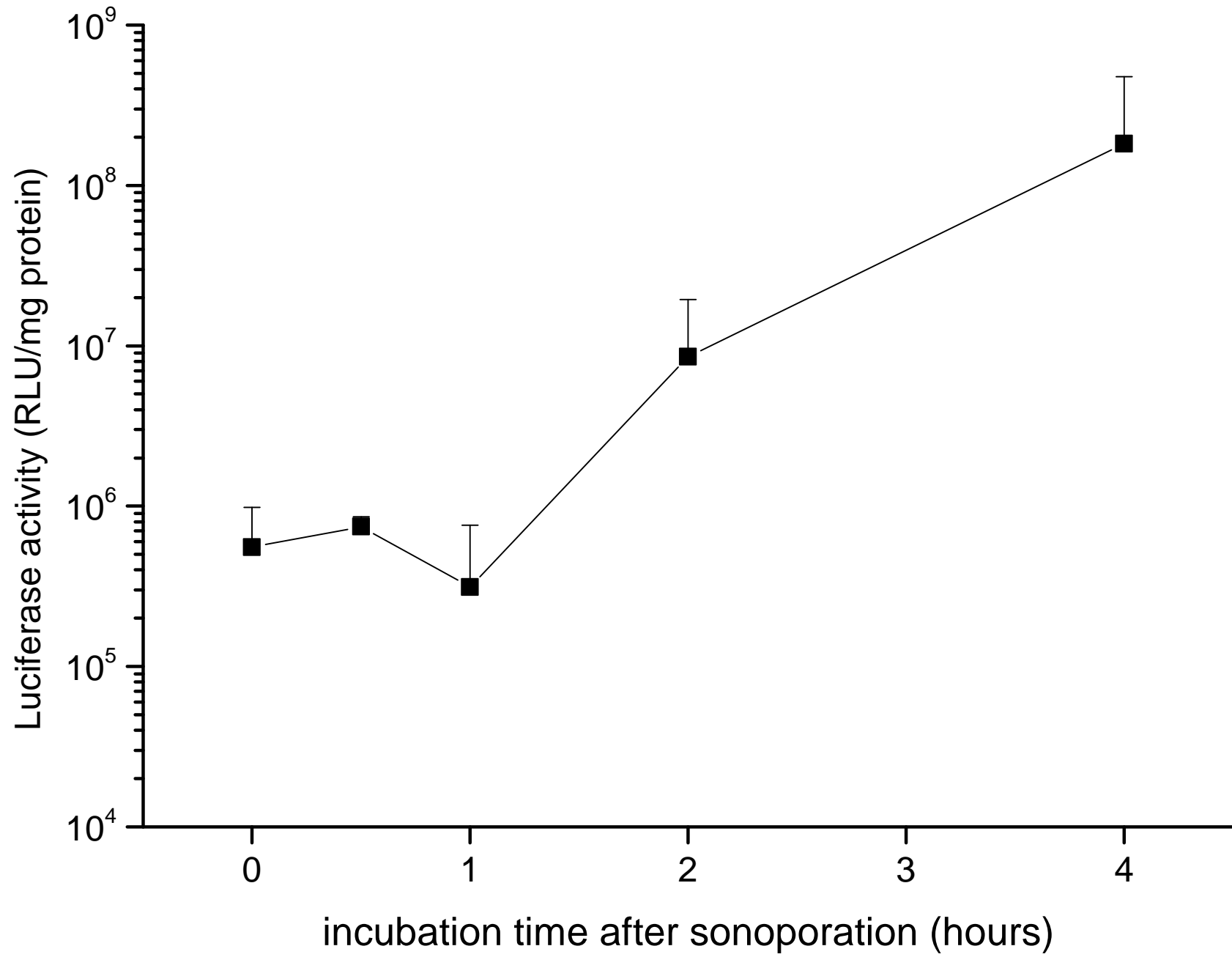
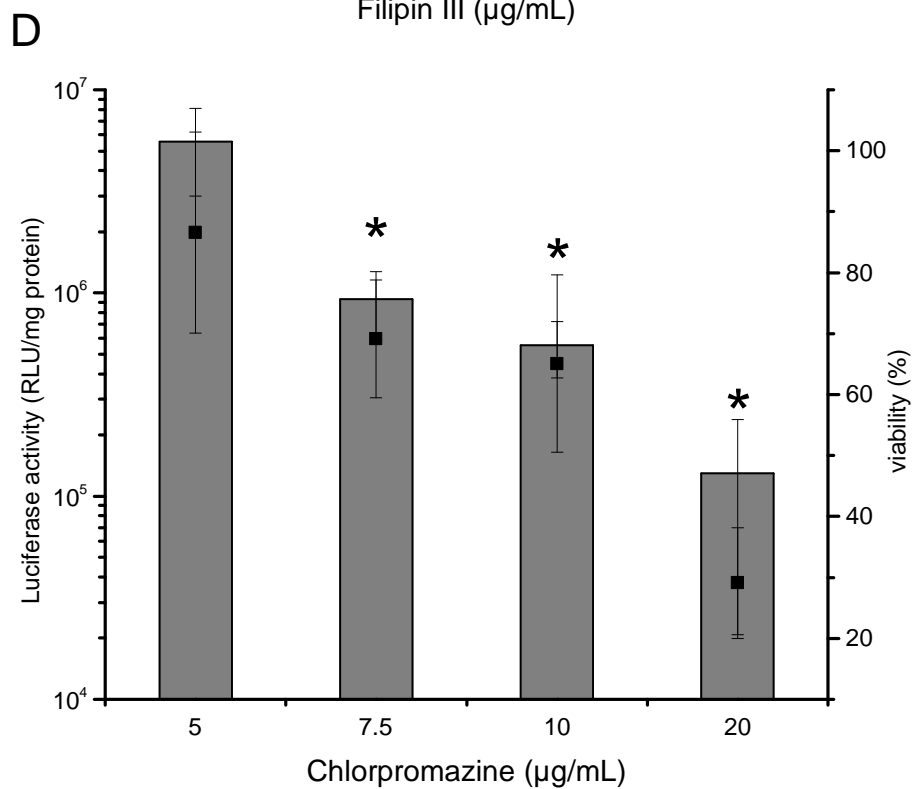
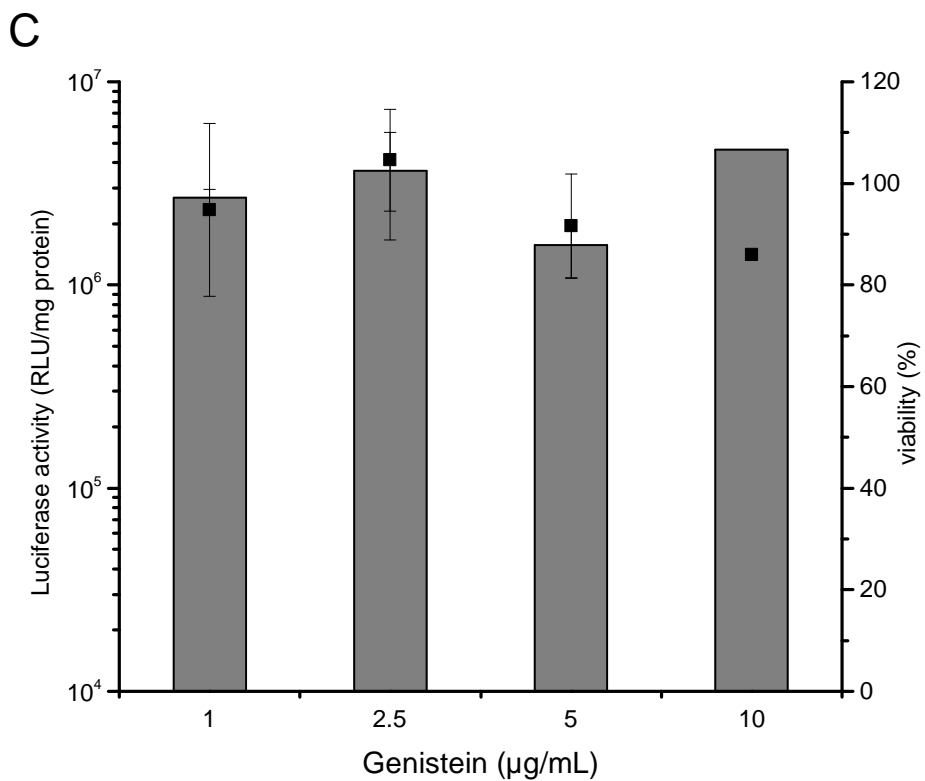
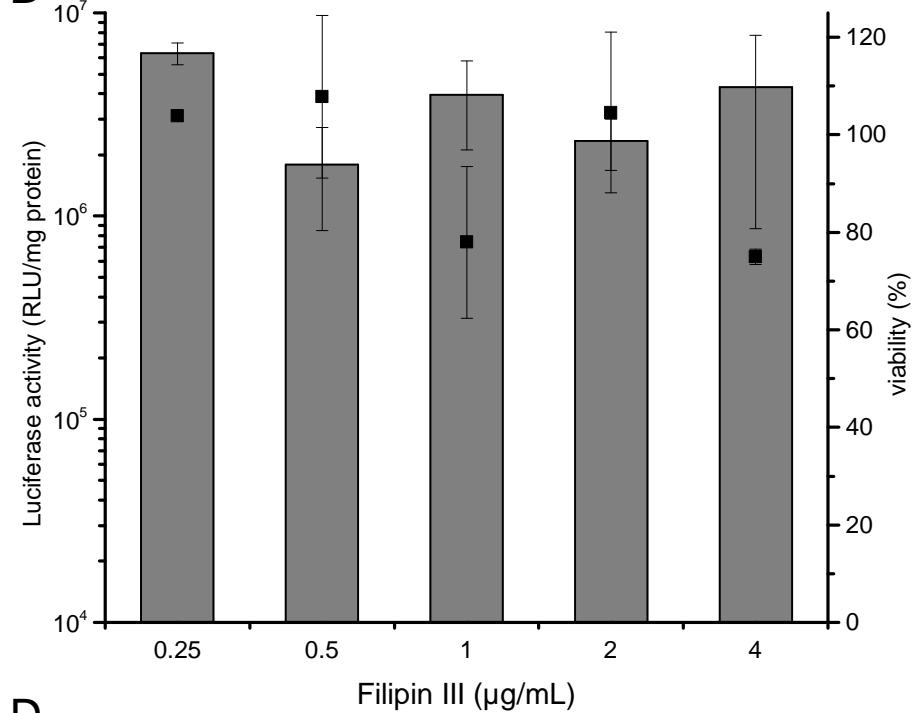
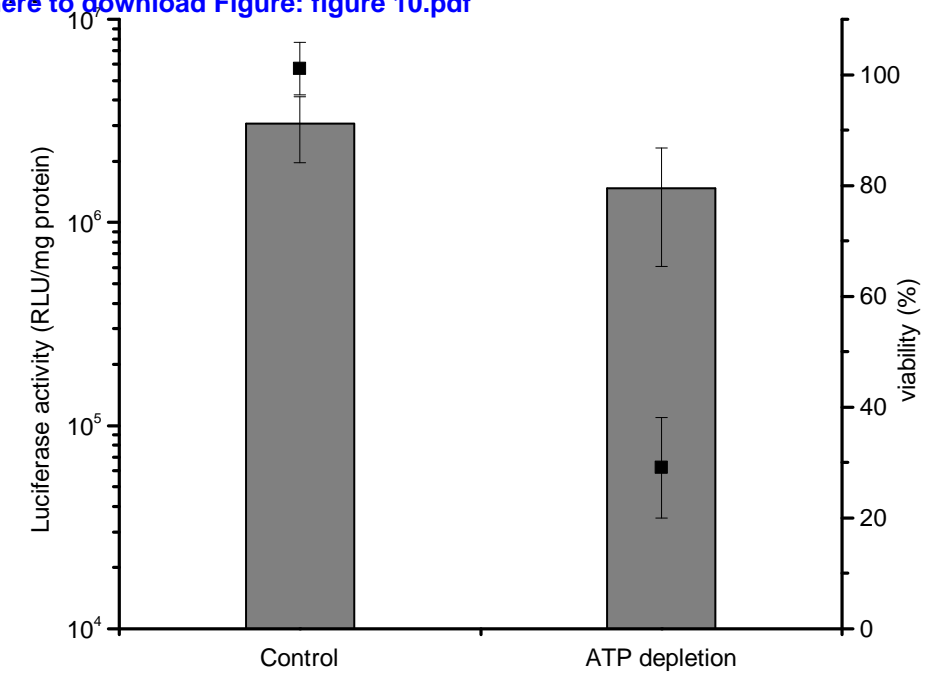


Figure 10
[Click here to download Figure: figure 10.pdf](#)



Supplemental Video

[Click here to download Supplemental Video: UMB paper.mp4](#)