



HAL
open science

Computers in industry systemic formalisation of Cyber-Physical-Social System (CPSS): A systematic literature review

Bereket Abera Yilma, Hervé Panetto, Yannick Naudet

► **To cite this version:**

Bereket Abera Yilma, Hervé Panetto, Yannick Naudet. Computers in industry systemic formalisation of Cyber-Physical-Social System (CPSS): A systematic literature review. *Computers in Industry*, 2021, 129, pp.103458. 10.1016/j.compind.2021.103458 . hal-03190888v1

HAL Id: hal-03190888

<https://hal.science/hal-03190888v1>

Submitted on 6 Apr 2021 (v1), last revised 9 Apr 2021 (v2)

HAL is a multi-disciplinary open access archive for the deposit and dissemination of scientific research documents, whether they are published or not. The documents may come from teaching and research institutions in France or abroad, or from public or private research centers.

L'archive ouverte pluridisciplinaire **HAL**, est destinée au dépôt et à la diffusion de documents scientifiques de niveau recherche, publiés ou non, émanant des établissements d'enseignement et de recherche français ou étrangers, des laboratoires publics ou privés.

Computers in Industry

Systemic formalisation of Cyber-Physical-Social System (CPSS): A Systematic Literature Review --Manuscript Draft--

Manuscript Number:	COMIND-D-20-00385
Article Type:	Research Paper
Keywords:	Cyber-Physical-Social System; Cyber-Physical System; Systematic Literature Review; System-of-Systems; Meta-model; Personalisation
Corresponding Author:	Bereket Abera YILMA Luxembourg Institute of Science and Technology Luxembourg, ESCH/ALZETTE LUXEMBOURG
First Author:	Bereket Abera YILMA
Order of Authors:	Bereket Abera YILMA Yannick Naudet Hervé Panetto
Abstract:	<p>The notion of Cyber-Physical-Social system (CPSS) is an emerging concept developed as a result of the need to understand the impact of Cyber-Physical Systems (CPS) on humans and vice versa. This paradigm shift from CPS to CPSS was mainly attributed to the increasing use of sensor enabled smart devices and the tight link with the users. The concept of CPSS has been around for over a decade and it has gained an increasing attention over the past few years. The evolution to incorporate human aspects in the CPS research has unlocked a number of research challenges. Particularly human dynamics brings additional complexity that is yet to be explored. The exploration to conceptualise the notion of CPSS has been partially addressed in few scientific literatures. Additionally, this conceptualisation has always been use-case dependent. Thus, there is a lack of generic view as most works focus on specific domains. Furthermore the systemic core and the principles linking it with the theory of systems are loose. This work aims at addressing these issues by first exploring and analysing scientific literatures through a Systematic Literature Review (SLR). Thereby identifying the state-of-the-art perspectives on CPSS regarding definitions, underlining principles and application areas. Subsequently, based on the findings of the SLR, we propose a domain-independent definition and a meta-model for CPSS, grounded in the Theory of Systems. Finally a discussion on feasible future research directions is presented.</p>

- Systemic formalization of Cyber-Physical-Social Systems (CPSS)
- Meta-model of Cyber-Physical-Social System
- Survey on Cyber-Physical-Social-System
- Systematic Literature review on Cyber-Physical-Social System.
- Personalisation in Cyber-Physical-Social System

Systemic formalisation of Cyber-Physical-Social System (CPSS): A Systematic Literature Review

Bereket Abera Yilma^{a,b}, Hervé Panetto^b and Yannick Naudet^a

^aLuxembourg Institute of Science and Technology (LIST), 5, Avenue des Hauts-Fourneaux, L-4362, Esch-sur-Alzette, Luxembourg

^bUniversité de Lorraine, CNRS, CRAN, F-54000 Nancy, France

ARTICLE INFO

Keywords:

Cyber-Physical-Social System
Cyber-Physical System
Systematic Literature Review
System-of-Systems
Meta-model
Personalisation

ABSTRACT

The notion of Cyber-Physical-Social system (CPSS) is an emerging concept developed as a result of the need to understand the impact of Cyber-Physical Systems (CPS) on humans and vice versa. This paradigm shift from CPS to CPSS was mainly attributed to the increasing use of sensor enabled smart devices and the tight link with the users. The concept of CPSS has been around for over a decade and it has gained an increasing attention over the past few years. The evolution to incorporate human aspects in the CPS research has unlocked a number of research challenges. Particularly human dynamics brings additional complexity that is yet to be explored. The exploration to conceptualise the notion of CPSS has been partially addressed in few scientific literatures. Additionally, this conceptualisation has always been use-case dependent. Thus, there is a lack of generic view as most works focus on specific domains. Furthermore the systemic core and the principles linking it with the theory of systems are loose. This work aims at addressing these issues by first exploring and analysing scientific literatures through a Systematic Literature Review (SLR). Thereby identifying the state-of-the-art perspectives on CPSS regarding definitions, underlining principles and application areas. Subsequently, based on the findings of the SLR, we propose a domain-independent definition and a meta-model for CPSS, grounded in the Theory of Systems. Finally a discussion on feasible future research directions is presented.

1. Introduction

Cyber-Physical-Social System(CPSS) is an emerging research topic resulting from the introduction of a Social dimension to the existing Cyber-Physical System (CPS) research. The notion of CPS was originally derived from an engineering perspective with the support of the US National Science Foundation (NSF) [1, 2]. The objective of CPS was mainly controlling and monitoring physical environments and phenomena via the integration of sensing, computing, and actuating devices. In parallel the notion of Internet of Things (IoT) which originates in the late 90's¹ took off as a paradigm with the support of the European Commission from a Computer Science perspective [3]. The emergence of IoT played an indispensable role for the orchestration of the physical and cyber systems with the goal of connecting tools and electronic equipment to the Internet and develop a network of computers and objects.

Despite their initial philosophical difference, IoT and CPS share many similarities hence they have been used sometimes interchangeably without a clearly defined demarcation [4]. There is however a fundamental difference that should be highlighted: the fact that a CPS refers to a particular system explicitly, while IoT refers at the same time to the concept, the system formed by all the connected devices and a particular system of interconnected objects. As a system, a CPS typically collects and controls information about phenomena from the physical world through networks of interconnected devices, in order to achieve its objective [5]. In the development of both paradigms, humans were originally assumed as external entities interacting with these systems.

Over the years the increasing popularity of smart devices and their significant role in the daily life of their users has led CPS systems to consider humans as a multifaceted source of information (i.e. human sensors)[6, 7]. Subsequent research studies have started to incorporate humans in CPS research. This trend in particular has uncovered the importance of humans' centrality for the development of CPS which was then recognised by the Human-in-the-Loop (HitL) CPS paradigm [8, 9, 10], where humans are intrinsic actors of the system. Different techniques have then been

 bereket.yilma@list.lu (B.A. Yilma); herve.panetto@univ-lorraine.fr (H. Panetto); yannick.naudet@list.lu (Y. Naudet)

¹The earliest quote about Internet of Things in a presentation from Kevin Ashton, 1999, MIT Auto-ID Center, reported in Forbes in 2002 (see <https://www.forbes.com/global/2002/0318/092.html5f7b1b353c3e>)

Systemic formalisation of Cyber-Physical-Social System (CPSS): A Systematic Literature Review

ARTICLE INFO

Keywords:

Cyber-Physical-Social System
 Cyber-Physical System
 Systematic Literature Review
 System-of-Systems
 Meta-model
 Personalisation

ABSTRACT

The notion of Cyber-Physical-Social system (CPSS) is an emerging concept developed as a result of the need to understand the impact of Cyber-Physical Systems (CPS) on humans and vice versa. This paradigm shift from CPS to CPSS was mainly attributed to the increasing use of sensor enabled smart devices and the tight link with the users. The concept of CPSS has been around for over a decade and it has gained an increasing attention over the past few years. The evolution to incorporate human aspects in the CPS research has unlocked a number of research challenges. Particularly human dynamics brings additional complexity that is yet to be explored. The exploration to conceptualise the notion of CPSS has been partially addressed in few scientific literatures. Additionally, this conceptualisation has always been use-case dependent. Thus, there is a lack of generic view as most works focus on specific domains. Furthermore the systemic core and the principles linking it with the theory of systems are loose. This work aims at addressing these issues by first exploring and analysing scientific literatures through a Systematic Literature Review (SLR). Thereby identifying the state-of-the-art perspectives on CPSS regarding definitions, underlining principles and application areas. Subsequently, based on the findings of the SLR, we propose a domain-independent definition and a meta-model for CPSS, grounded in the Theory of Systems. Finally a discussion on feasible future research directions is presented.

1. Introduction

Cyber-Physical-Social System(CPSS) is an emerging research topic resulting from the introduction of a Social dimension to the existing Cyber-Physical System (CPS) research. The notion of CPS was originally derived from an engineering perspective with the support of the US National Science Foundation (NSF) [1, 2]. The objective of CPS was mainly controlling and monitoring physical environments and phenomena via the integration of sensing, computing, and actuating devices. In parallel the notion of Internet of Things (IoT) which originates in the late 90's¹ took off as a paradigm with the support of the European Commission from a Computer Science perspective [3]. The emergence of IoT played an indispensable role for the orchestration of the physical and cyber systems with the goal of connecting tools and electronic equipment to the Internet and develop a network of computers and objects.

Despite their initial philosophical difference, IoT and CPS share many similarities hence they have been used sometimes interchangeably without a clearly defined demarcation [4]. There is however a fundamental difference that should be highlighted: the fact that a CPS refers to a particular system explicitly, while IoT refers at the same time to the concept, the system formed by all the connected devices and a particular system of interconnected objects. As a system, a CPS typically collects and controls information about phenomena from the physical world through networks of interconnected devices, in order to achieve its objective [5]. In the development of both paradigms, humans were originally assumed as external entities interacting with these systems.

Over the years the increasing popularity of smart devices and their significant role in the daily life of their users has led CPS systems to consider humans as a multifaceted source of information (i.e. human sensors)[6, 7]. Subsequent research studies have started to incorporate humans in CPS research. This trend in particular has uncovered the importance of humans' centrality for the development of CPS which was then recognised by the Human-in-the-Loop (HitL) CPS paradigm [8, 9, 10], where humans are intrinsic actors of the system. Different techniques have then been used to introduce human actors in CPS, paving the way for the foundation of Cyber-Physical-Social System(CPSS) [11, 12]. Over the past decade different researchers used different terminologies to refer to the integration of the human aspect in to CPS projecting different conceptualizations . For instance in [13, 14, 15, 16, 17, 18, 19, 20, 21, 22] Cyber-physical-human systems (CPHS) was used, being defined as "*a system of interconnected systems (computers,*

¹The earliest quote about Internet of Things in a presentation from Kevin Ashton, 1999, MIT Auto-ID Center, reported in Forbes in 2002 (see <https://www.forbes.com/global/2002/0318/092.html5f7b1b353c3e>)

cyber-physical devices, and people) “talking” to each other across space and time, and allowing other systems, devices, and data streams to connect and disconnect.” In [23] the concept of Cyber-Physical-Social-Thinking hyperspace (CPST) was introduced for geological information service system. These works define CPSS as “a system deployed with emphasis on humans, knowledge, society, and culture, in addition to Cyber space and Physical space. Hence, it can connect nature, cyber-space, and society with certain rules.” where as CPST is established through the mergence of a new dimension of thinking space into the CPS space. The thinking space is a *high-level thought or idea raised during the intellectual activities of people*. These works visualize the *intellect* of humans separately from the Social aspect of CPSS as Thinking space. On the other hand the term Social-Cyber-Physical-Systems (SCPS) was also used in [24, 25, 26, 27]. The commonly shared understanding of SCPS was “*complex socio-technical systems, in which human and technical aspects (CPS) are massively intertwined.*” as defined by [27]. According to this definition the awareness of SCPS extends to the intangibles of social context, which includes social culture and norms, personal beliefs and attitudes, and informal institutions of social interactions. Finally, the term Cyber-Physical Human-Machine system was also used in [28].

Nowadays the acronym CPSS is being widely used in various application areas. Smart Cities, Smart Homes, Schools, Offices, Museums, and medium to large scale Industries are among the main sectors, where applications of the CPSS notion has gained momentum [11, 12, 29, 30, 31, 32, 33, 34, 35, 36, 37, 38, 39, 40, 41, 42, 43, 44, 45, 46]. Despite the advances made to integrate human aspects in CPS, the development of CPSS research is still in it’s infancy. There are still no reliable approaches to harmoniously model the social part together with cyber and physical. Additionally the hardly predictable and complex nature of humans by itself brings additional complexity to the system. Humans are social creatures and the term "Social" carries a broader meaning as it reflects emotional, cognitive and behavioral aspects of a human [12] which are deemed as the three layers of human interaction responses [47, 48, 49]. Moving forward towards a harmonious integration of social aspects, the CPSS research should take a holistic approach on the synergy between social aspects and CPS [12]. However, today, the commonly adopted conceptualisations of CPSS often capture partial characteristics of the social dimension.

In this sense, there is a need for reaching a common understanding on the concepts of CPSS to guide in the development of technologies. In recent years some works carried out literature reviews with the objective to provide a view on CPSS development, challenges and application areas [2, 8, 46, 50, 51, 22, 52, 43, 53]. Although a seemingly common understanding may have been reached in some domains and, in some cases, more general concepts were introduced [12], there is a lack of a uniform systemic ground and domain-independent view of CPSS. In general to the best of our knowledge, there is a lack of consensus regarding the conceptualisation of CPSS and its characteristics considering commonalities how they are treated in different domains in the scientific literature. Therefore, this work aims at exploring the state-of-the-art regarding Cyber-Physical-Social system (CPSS). We put special focus on identifying definitions and characteristics of CPSS and how the social and human aspects are integrated in current research trends.

To this end, we conduct a Systematic Literature Review (SLR). The contributions of this work can be summarised as: (1) to provide a view on the state-of-the-art perspectives of CPSS considering how they are defined, and how social aspects are depicted within various domains in CPSS literature. (2) to identify main issues in the integration of social aspects provided in scientific papers regardless of the application domain, (3) to establish a common ground towards a unified definition of CPSS through a systemic formalisation and a meta-model proposal, and (4) Propose a future research direction to support the integration of social aspects in CPSS research.

This paper is organised as follows. Section 2 introduces the research context and establishes a core systemic ground presenting a brief overview of General Systems Theory (GST) and System-of-Systems (SoS) Principles. Section 3 describes the methodology followed to perform the SLR, the approaches used to analyse the selected papers and the results obtained from the analysis. Section 4 presents the state-of-the-art perspectives on CPSS, by discussing definitions and how the social aspect is conceptualised in literature. Section 5 presents the Systemic formalisation of CPSS by establishing a link with the theory of systems. Section 6 covers a discussion on feasible future research direction. Finally, Section 7 presents a concluding discussion.

2. Research Context

To understand what a CPSS is, how it has evolved, reflect on state-of-the-art perspectives and propose future research directions, this study formed by SLR tries to answer the following key research questions:

- How is a CPSS defined?

- How is the Social dimension (i.e. human aspect) conceptualised in current CPSS research?
- What are the application areas of CPSS?
- What are the main issues and challenges in the current CPSS research? (mainly due to the active involvement of humans).
- What can be made to address these challenges?

CPSS is a complex system; more precisely it is a System-of-Systems (SoS) [54]. Thus, before defining CPSS and its characteristics, it is worth to first explore the definition and properties of a System and System-of-Systems (SoS) from a generic perspective. Thereby to establish a core systemic ground to the CPSS research. Therefore, in this section we first introduce some notions of General Systems Theory (GST) [55] and System-of-Systems (SoS) Principles [54, 56].

2.1. General Systems Theory (GST) and System-of-Systems (SoS) Principles

Originally, in the General Systems theory (GST) a system was defined as *a complex set of interacting elements, with properties richer than the sum of its parts* [55]. Based on GST, Naudet et al. [57] introduced systems science for interoperability and proposed a definition of system which is fitting for the context of CPSS. In this work we adopt the following definition of a system [57]:

Definition 1. *"A System is a bounded set of interconnected elements forming a whole that functions for a specific finality (objective) in an environment, from which it is dissociable and with which it exchanges through interfaces" [57].*

In this work the authors characterised a system by its components and the interactions between them, where each component can itself be a system. Thus, they can form a System-of-Systems (SoS). The term System-of-Systems came into common usage in the late 90's to characterise large systems often formed from a variety of component systems which developmentally and operationally exhibit the behaviour of complex adaptive systems (CAS) [58, 59]. The SoS notion fundamentally captured the non-monolithic nature of complex modern systems. The earliest and most accepted definition of SOS is the one by [54] formalised as follows:

Definition 2. *"A System-of-Systems (SoS) is an assemblage of components which individually may be regarded as systems, and which possesses two additional properties:*

- **Operational Independence of the Components:** *If the system-of-systems is disassembled into its component systems the component systems must be able to usefully operate independently.*
- **Managerial Independence of the Components:** *The component systems not only can operate independently, they do operate independently. The component systems are separately acquired and integrated but maintain a continuing operational existence independent of the system-of-systems" [54].*

From a systems engineering perspective, the notion of SoS was best described as an emergent system from at least 2 *loosely coupled systems* that are collaborating [56]. The SoS principle dictates that the relationship between component systems is recursive as any system is produced by another higher system, answering specific requirements. For a dedicated project, the target system (CPSS in our case) is the final produced system, in this recursively loop.

There are two fundamental perspectives to view a system [60]: from the *teleological* aspect and from the *ontological* aspect. The *teleological* aspect is focused on the behaviour and functioning of the system, while in the *ontological* perspective a system is addressed from a structural point of view. In order to characterise a CPSS, both the ontological and teleological aspects have to be considered because the complexity demands more than the structure and interactions between components to be taken into account. The main components and their relationship have first to be identified. Then, functions and behaviours of system components should be formalised, as they can constrain the objectives of the CPSS [61]. Having recalled the notion of System and System-of-Systems (SoS), we subsequently define the key systemic concepts to be used in this work, reusing or extending definitions from [57].

- **System Component:** is an element of a *System* that is a system itself composed of sub-components that are in a relation and can be decomposed until an atomic level.

- **Relation:** is a link between two entities whatever the nature of the link. From a systemic point of view relation can be formalised locally or globally, i.e. between system components or between a system and its environment or other systems. We can further distinguish between structural and behavioural relation [57].
- **Environment:** represents a space that is outside a system’s boundary. An environment itself is a system. In a system context there are two types of environments to consider; a specific system’s environment which acts on or is acted by the system it surrounds and global environment which is the complement of the system. The global environment starts where the system is no more influenced and influences no more.
- **Interface:** is a component of a system through which a connection between a system and its environment can be established. It also represents a system’s boundaries.
- **Objective:** a finality or objective defines a system’s goal at a given time. Every system has an objective often composed of sub-objectives. An objective can be either uniform throughout the life-cycle of a system or changing in different contexts.
- **Function:** is the set of actions the system can execute for the purpose of achieving its objectives. It is a property of a system that can be lent for or inherited by a super-system (SoS). A function is a means to an end (Objective).

Figure 1 illustrates a systemic model adopted from [57] and modified incorporating the SoS notion from systems engineering perspective by using UML 2.0 notation.

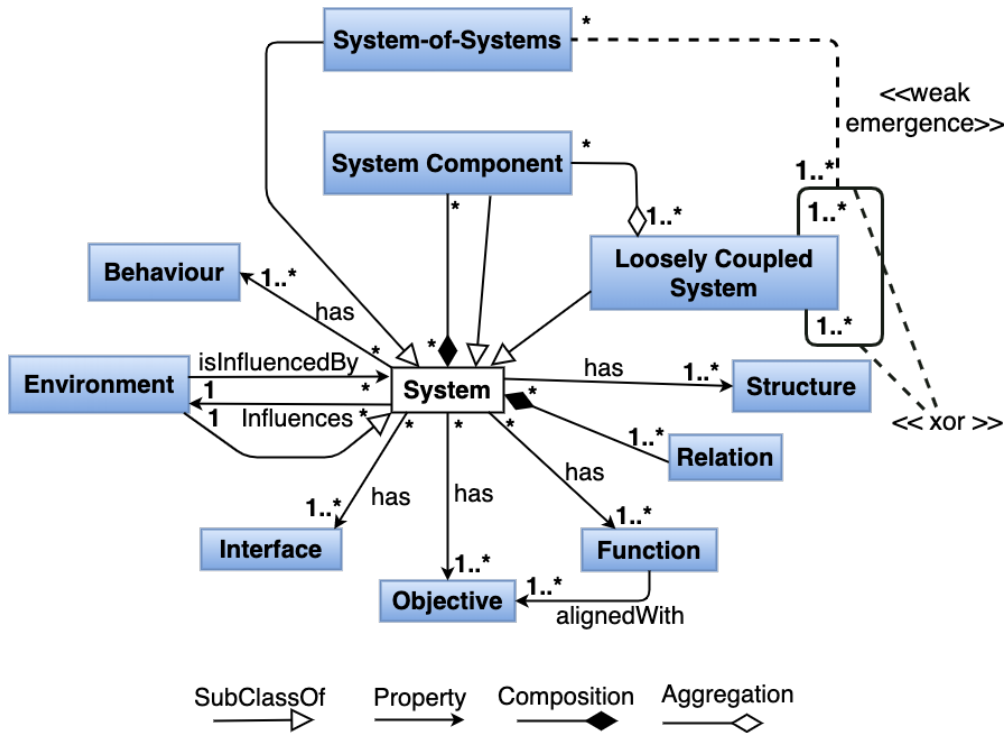

Figure 1: The Systemic model.

3. Systematic Literature review

The systematic literature review presented in this research paper is conducted according to the guidelines proposed by Kitchenham [62]. The objectives of this particular SLR is to evaluate and interpret all available research relevant to answer the key research questions presented in Section 2. The SLR aims to present a fair evaluation of the state-of-the-art on CPSS following a rigorous and audateable methodology. The main advantage of conducting such an SLR

is to provide a background by identifying gaps, detecting challenges and screening bad practices. Thus, to showcase state-of-the-art conceptualisations and position novel research activities appropriately[63]. This review is undertaken following a predefined search strategy and presents evidence concerning the data sources, the selection and analysis criteria.

3.1. Method of Research

The methodology we use is the following: (i) Define the paper selection procedure (including search questions, keywords, sample sources and the paper selection steps); (ii) Present the paper selection and the bibliographic analysis (i.e. point out the year of publication, the publishers, countries and the addressed domains); (iii) identify State-of-the-art perspectives on CPSS (definitions, application areas, challenges and gaps in CPSS literature, report and discuss findings); Finally, (v) Propose a generic definition through a systemic formalisation and illustrate promising future research direction to tackle systemic complexities originating from social dynamics. This is further illustrated by Figure 2, through a Business Process Model and Notation (BPMN) diagram [64].

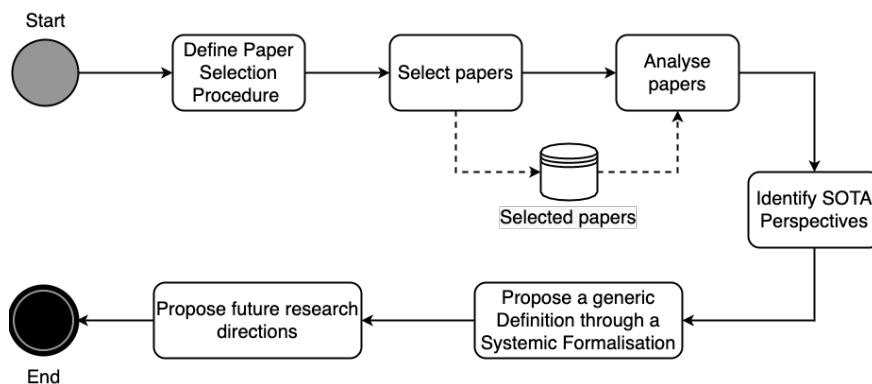

Figure 2: Overview of the methodology followed in this work.

3.2. Paper Selection Procedure

In this subsection we present the details of our paper selection procedures (i.e. Database selection, Keyword and Search strings definition and paper filtering steps).

3.2.1. Database Selection

In order to cover all relevant studies that could potentially answer the above mentioned key research questions we searched for papers by querying the following digital libraries: ACM, Scopus, IEEE_Xplore, Taylor & Francis Online, Wiley and Springer. We selected six databases taking into account that a minimum of four is deemed sufficient to perform a robust literature search [65]. It is worth mentioning that among the six queried databases Scopus is known to be an extensive abstract and citation database that gathers papers from several peer-reviewed journals. The papers retrieved from this database come from diverse publishers such as Elsevier, Springer, Taylor & Francis Online, and IEEE. It is expected that this will provide more robustness to the search. Normally, duplicated papers are expected to appear from this search and they are removed. Each database has its own syntax to write queries. Hence, the search strings described in Section 3.2.2 are slightly modified for each database to obtain the expected output.

3.2.2. Keywords and search strings definition

The keywords used in this study were defined based on an iterative process, which is described as follows. First we queried the digital libraries with the search string *Cyber Physical Social System* denoted by S_1 . A total of 431 papers were retrieved. From these papers, we extract the most used keywords (i.e. repeated more than five times) and the most repeated terms (i.e. repeated more than fifteen times) in their titles and abstract. This was done by downloading paper's metadata (i.e. title, year of publication, authors, abstract and keywords). Next, we perform a data mining on the extracted metadata in order to identify the relevant keywords using VOSviewer software [66]. VOSviewer is used to construct and visualise co-occurrence networks of important terms extracted from the metadata. Additionally a manual

analysis of the metadata was carried out in order to identify relevant keywords. Combining the two we identified twelve additional keywords and redefined the search string S_1 to S_2 .

- S_1 : {Cyber Physical Social System}
- S_2 : {Cyber Physical Social system}, {Human Cyber Physical System}, {Socio Cyber Physical System}, {Social IoT}, {Cyber physical Human System}, {Social Cyber Physical System}, {Human in the Loop CPS}, {Cyber Physical Social Thinking}, {Cognitive IOT}, {Human Centered IoT}, {Human Centered CPS}, {Human in the Mesh}.

Querying the databases with S_2 we retrieved a total of 705 papers. Table 1 summarises the total number of papers obtained from each database per search string.

Publisher Databases	Search string S_1	Search string S_2
ACM	9	114
Scopus	248	260
IEEE_Xplore	67	189
Taylor & Francis	4	4
SpringerLink	99	101
Wiley	4	37
Total	431	705

Table 1: Number of papers retrieved from each database, per search string.

3.2.3. Papers Filtering

After retrieving 705 papers from the the database search, we included 34 additional papers using the “snowball sampling” technique [67]. In the “snowball sampling” we considered the referrals of CPSS approaches made by experts, as well as the most cited papers in the existing surveys and reviews. A total of 739 publications were identified at the end of this sampling phase. Subsequently the selection of papers to be analysed and included in the study was done in a two step filtering mechanism. In the first filtering step represented by F_1 the metadata of each paper was screened through a set of inclusion and exclusion criteria. The second filtering step involves reading the full text of the remaining papers. To select which papers are to be considered in this study an additional set of inclusion and exclusion criteria were applied represented by F_2 . The two step filtering mechanism is described in table 2, and the overall paper selection process is depicted in Figure 3 through a Business Process Model and Notation (BPMN) diagram [64].

Filter	Inclusion Criteria	Exclusion Criteria
F_1	Papers written in English Paper with full text access Primary studies	Papers not written in English Paper without full text access Literature reviews
F_2	Papers establishing a link between CPS/IoT and social dimensions/ human aspects Papers containing definitions Papers with implicit definitions Papers discussing open challenges in CPSS Papers proposing solutions for social dynamics in CPSS	Papers without link between CPS/IoT and social dimensions/ human aspects Papers that are only about CPS/IoT

Table 2: Inclusion and exclusion criteria used to select the papers. The criteria are organised in two filters, F_1 and F_2 , the first is related to metadata analysis whilst the second is based on analysing the full text of the papers.

The overall sample considered in this study constitutes papers published up to May 2020. The time distribution of the papers published is shown in Figure 5. A small fluctuation can be seen between the years 2007 and 2014 in the number of papers. In 2015 a steady growth appeared followed by a sharp increase in 2016 with gradual changes in 2017 and 2018. In the year 2020, the rate of publication only within the first few months has almost doubled the previous year. This evolution rationalises the the increasing attention the CPSS research gained over the years.

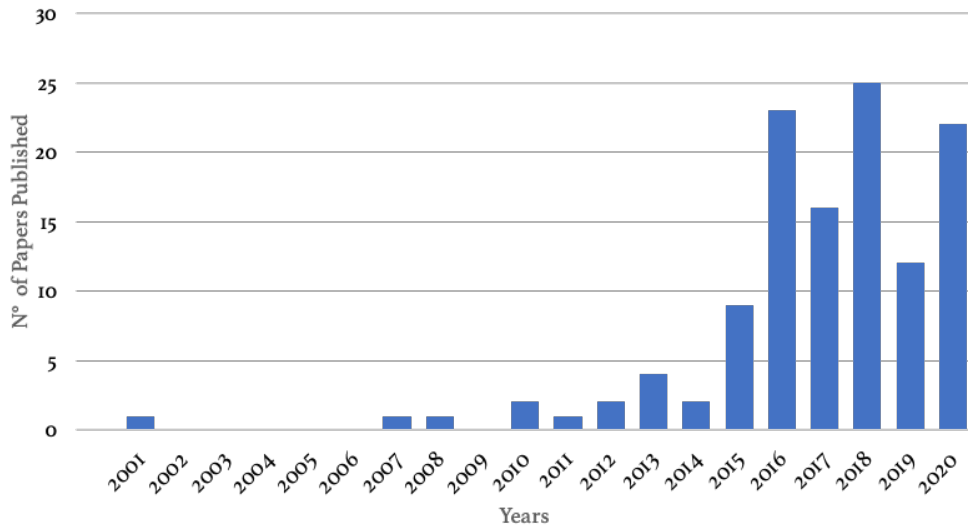

Figure 5: Number of papers published per year.

Our analysis also revealed the development of CPSS research across nations worldwide. As it can be seen on Figure 6, *China*, *USA* and *Italy* are the leading contributors followed by *Canada*, *Germany* and *France* in terms of the number of publications produced until May 2020. Figure 7 illustrates the development of CPSS research worldwide according to the number of publication produced by countries. Since the goal of this study was also to identify the application areas of CPSS we did not restrict the search strings to specific domains. Hence, we identified a number of application areas addressed by the works selected for this study which are summarised in Figure 8.

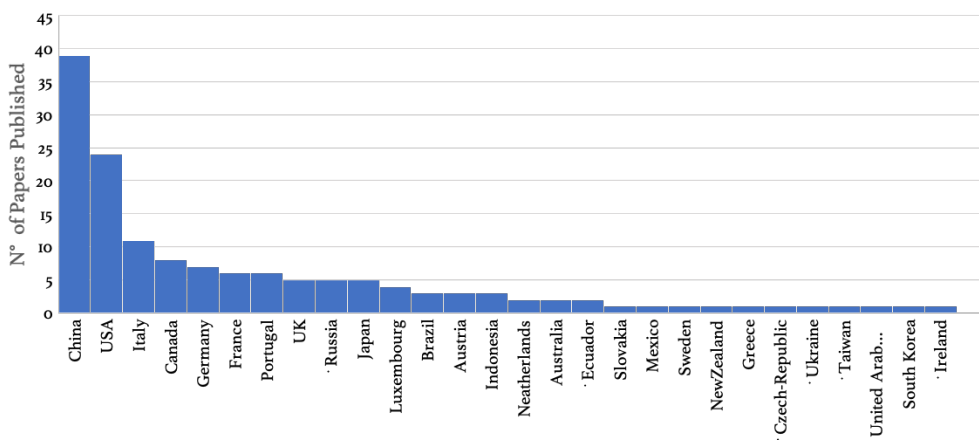

Figure 6: Number of papers published per Country.

Systemic formalisation of Cyber-Physical-Social System(CPSS)

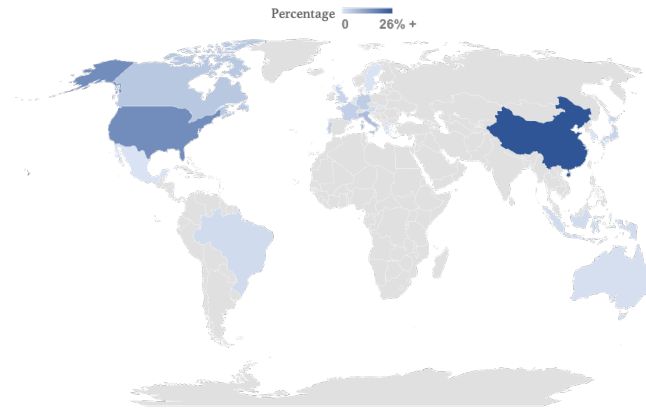

Figure 7: The development of CPSS research worldwide according to the number of publication.

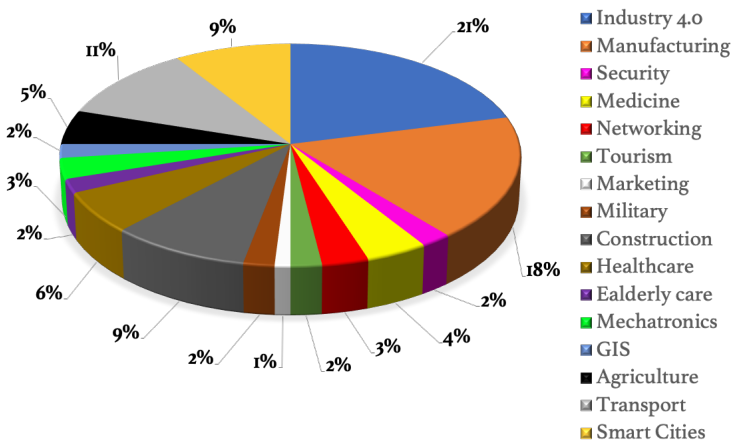

Figure 8: Application areas of CPSS.

4. State of the Art Perspectives

In this section we present the state-of-the-art perspectives on CPSS by first exploring alternative terminologies and their corresponding definitions followed by a discussion on the CPSS paradigm with an exclusive analysis on works that used the CPSS acronym. Subsequently we present our analysis on how the social dimension/human aspect has been conceptualised in the CPSS literature.

4.1. Alternative Terminologies

While studying the selected papers from Section 3 we observed that a number of alternative terminologies to CPSS has been used by different researchers. Thus, we identified eleven terminologies for which a seemingly coherent definitions could be extracted. A summary of the terminologies and their extracted definitions is presented in Table 4. Figure 9 illustrates the distribution of identified terminologies over the sample references used in this study.

All of the alternative terminologies defined in Table 4 are complex interconnected systems which according to the

Term	Definition	Reference
CPHS/ HCPS	Cyber-Physical-Human System (CPHS) or Human-Cyber-Physical System(HCPS) is a system of interconnected systems (i.e. computers, devices and people) that interact in real-time working together to achieve the goals of the system –which ultimately are the humans’ goals.	[13, 14, 15, 17, 19, 20, 68, 68, 69, 70, 71, 72, 73]
(HiL)CPS	Human-in-the-Loop Cyber-Physical System ((HiL)CPS) is a system consisting of a loop that involves humans, an embedded system (cyber component), and the physical environment where the embedded system augments a human interaction with the physical world making humans’ intents, psychological states, emotions, and actions an intrinsic part of any computational system. Thus, establishing a feedback control loop.	[10, 74, 75, 76, 77, 78, 79, 80, 81, 52, 82]
SIoT	Social Internet of Things (SIoT) is a kind of Social network where every node is an object capable of establishing social relationships with other things in an autonomous way according to rules set by the owner. SIoT is created by integrating social networking (SN) principles into the native IoT model.	[83, 84, 85, 86, 87, 88, 51]
SCPS	Social Cyber-Physical System (SCPS) is Cyber-physical system (CPS) that strongly interacts with the human domain and the embedding environment, working according to the expectations of humans, communities and society, under the constraints and conditions imposed by the embedding environment.	[27, 89, 24, 90, 91, 26]
CPST	Cyber-Physical-Social Thinking (CPST) is a concept emerged through the fusion of CPS and IoT on the basis of cloud computing technology, as a broader vision of the IoT. Precisely CPST is a hyperspace established by merging a new dimension of thinking space with the CPS.	[92, 93, 23]
HCPPS	Human Cyber-Physical Production System (HCPPS) is a generic architecture with the control loop, adaptive automation control systems, and human-machine interaction to support humans, machines, and software to interface in the virtual and physical worlds so as to create a human-centric production system.	[94, 95]
CIoT	Cognitive Internet of Things (CIoT) is a paradigm aimed at improving performance and to achieve intelligence of IoT through cooperative mechanisms with Cognitive Computing technologies that try to mimic human-like Cognitive capabilities, such as Understanding, reasoning and Learning.	[96, 97]
HitM	Human in the Mesh (HitM) refers to human activities in Cyber-Physical production system in which the worker is participating to the process of production planning and its loop of control, and it is usually enacted by the role of the Manager.	[42]
CPHMS	Cyber-Physical Human–Machine Systems (CPHMS) is a CPS that includes problems of cognition (planning and decision making), navigation, action, human-robot interaction (perception, environment sensing, and interfacing with the end-user), and architecture development and middleware.	[16]
PCSC	Physical-Cyber-Social Computing is a paradigm that encompasses a holistic treatment of data, information, and knowledge from the Physical, Cyber and Social worlds to integrate, correlate, interpret, and provide contextually relevant abstractions to humans.	[98]
Smart-CPS	is a CPS that combines various data sources (both from physical objects and virtual components), and applying intelligence techniques to efficiently manage real-world processes.	[99]

Table 4: Alternative terminologies to CPSS and their corresponding definitions as proposed by different researchers .

Systemic formalisation of Cyber-Physical-Social System(CPSS)

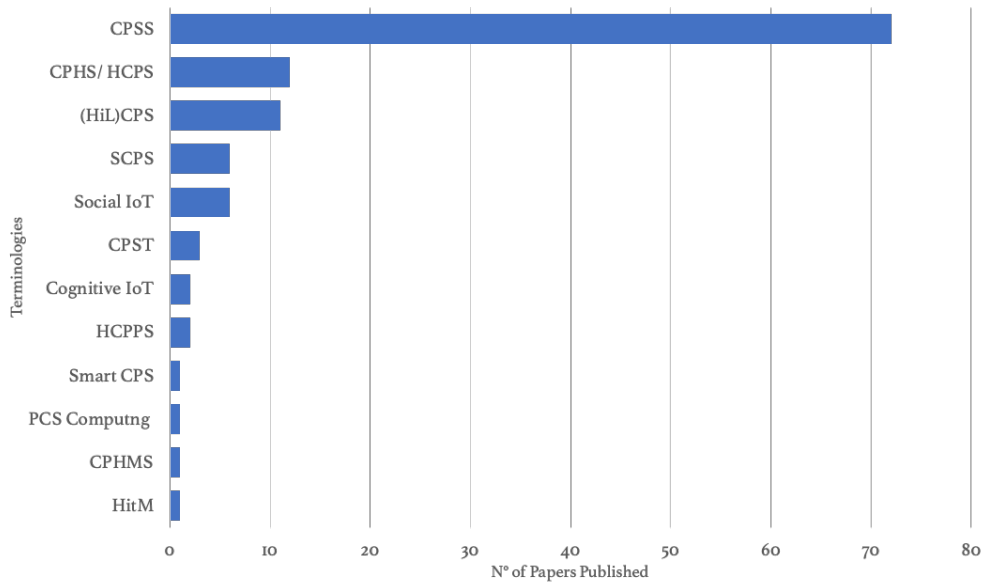

Figure 9: Distribution of terminologies over sample papers

systemic notion introduced in Section 2.1 correspond to an SoS. As a system each has its own finality (objective) to be achieved through a certain set of functionalities. Further analysing these concepts in light of the theory of systems, we identified some commonalities and differences mainly in terms of their corresponding systemic objectives and component systems. To elaborate this we present five objective oriented categorisation of the acronyms below.

- **Category A:** includes *CPHS/HCPS*, *SCPS*. These systems contain human, computers and devices as component systems interconnected to support human (i.e. meet the objective of human).
- **Category B:** includes *CIoT*, *CPST*, *Smart-CPS*, *CPHMS*. The objective of these systems is to improving the performance of CPS/IoT devices by introducing intelligence.
- **Category C:** includes *(HiL)CPS*, *HCPPS*, *HitM*. These systems focus on establishing a control loop between humans, devices and their environment. Generally three types of feedback controls can be established, (i) *applications where humans directly control the system*, (ii) *applications where the system passively monitors humans and takes appropriate actions*, and (iii) *a hybrid of (i) and (ii)*.
- **Category D:** includes *PCSC*. The focus of these systems is to provide contextually relevant abstractions to human by exploiting data knowledge and information from the environment.
- **Category E:** includes *SIoT*. This category of systems create a social network of things/ devices so that the devices can establish relationships and operate autonomously.

In addition to the differences in objectives which are usually use-case/ domain dependent, component-wise relationships and inter-dependencies of these systems are also diverse and vaguely explained. Nevertheless, all of these systems contain Human, Computers and Smart devices as component systems which is commonly shared by other works that use the **CPSS** acronym. In the next subsection we present the results from exploration of the rest of the works in our sample references that adopt the CPSS acronym. particularly we present the core definitions given for CPSS, we then discuss the **CPSS paradigm** and take a closer look at how the social dimension (human aspect) is conceptualised in literature.

4.2. Cyber-Physical-Social System (CPSS)

Our analysis revealed that the ways of defining CPSS is also different from one research work to another. Particularly, we identified five major categories of definitions that can summarise the understanding of the CPSS notion in literature presented in Table 5.

Definition	Reference
1. CPSS is a system consisting of a computer system, a controlled object and interacting social components (e.g., humans). Thus allowing the control of physical object using computation and social data to ultimately achieve moral goals and online cloud management of social processes.	[100, 101, 102, 103, 104, 105, 30, 44, 106, 107, 108, 38, 109, 110, 111, 112, 113]
2. CPSS is a system consisting of not only cyberspace and physical space, but also human knowledge, mental capabilities, and socio-cultural elements. Information from cyberspace interacts with physical and mental spaces in the real world, as well as the artificial space mapping different facets of the real world.	[114, 115, 12, 116, 117, 118, 119, 120]
3. CPSS is a system comprising three intertwining subsystems (i) <i>The human-based system</i> which refers to the social system containing human actors and their interconnected devices/agents and/or social platforms providing human-based services, (ii) <i>The software-based system</i> that refers to the cyber world providing software-based services including the underlying infrastructures and platforms, either on-premise or in the Cloud and (iii) <i>The thing-based systems</i> referring to the physical world that includes sensors, actuators, gateways and the underlying infrastructures. CPSS tightly integrate physical, cyber, and social worlds to provide proactive and personalized services for humans.	[121, 122, 123, 61, 124, 125, 6, 126, 127, 39, 29, 128, 53, 11, 40, 129, 34, 130, 131]
4. CPSS is an extension of CPS/IoT formed by introducing human's social behaviour fostering a synergetic interaction between computing and human experience. Thus, integrating Big Data Collectors (BDCs), Service Organizers (SOs) and users to build a unified data-centric computing framework.	[132, 133, 45, 134, 135, 136, 137, 138, 53, 41, 139, 43, 32, 37, 35, 33, 31, 140, 141, 36, 142, 143]
5. CPSS is a paradigm originates from the technology development of the cyber-physical systems (CPS) and cyber-social systems (CSS) to enable smart interaction between cyber, physical and social spaces, where CPS includes communicators, multimedia entertainment and business processing devices, etc. and CSS refers to social networks such as Facebook, Twitter, Youtube, etc.	[98, 144, 145, 146, 147]

Table 5: Definition categories of the CPSS acronym in literature.

Currently a **CPSS** refers to an interaction space composed of humans and smart devices which is similar to the alternative systems discussed in section 4.1. However, the **CPSS** paradigm where the "S" refers to "Social" carries a broader semantics. In Social science, Turner [148] defined a Social interaction as *a situation where the behaviors of one actor are consciously reorganized by, and influence the behaviors of, another actor, and vice versa* which can be extended to *the process whereby there is a mutual influence between behaviors of multiple individuals*. There are also other close interpretations all driven from most influential works of Goffman [149] and Weber [150]. Most commonly recognised types of social interactions are: Exchange, Competition, Collaboration and Conflict. Overall, what qualifies an interaction as *social* is complex, but is inherently associated to specific characteristics of humans: consciousness and understanding. According to Weber's social action theory, [150], a social interaction implies taking the actions of the other into account, which in turn means having a *sympathetic understanding*. Here, the adjective sympathetic resonates more of human behaviour in an interaction context because it relates to sentiments, compassion, and empathy. Today CPS start only to have some features resembling those characteristics, especially driven by the work in social robotics, or emotion recognition. However they are far from being equivalents to human ones, and allow only weakly Human-CPS interaction at a social level. Hence, human-machine interaction in a truly collaborative manner demands efficient means to understand and reason such dynamic responses of a human. Cognition and understanding is a first prerequisite, which will allow the machine to adapt its behaviour to the presence of humans (situation identification), and to individuals (personalisation). Then, having sentiments, compassion or empathy (i.e. emotional responses)

leads us to another level in the evolution of machines, which is related to anthropomorphism, a research topic in social robotics; [151]. The process of ensuring seamless Human-Machine interaction requires incorporating all or at least most of the social dimensions in machines; [151]. Considering this broad spectrum that comes with the added "Social" component in CPS, the CPSS paradigm can be seen as a generalisation of such systems. (i.e. *alternative terminologies* (Section 4.1) \subseteq CPSS)

Despite the alternative terminologies used and their different conceptualisations discussed in Section 4.1 a common understanding shared among all works is that the notion of CPSS they define corresponds to an interaction space (both virtual and physical) cohabited by humans and CPS devices. Inherently the emergence of these systems is tightly coined with the presence of human at the vicinity of CPS which leads to some form of interaction. A human is a social creature and social interaction is by far the most seamless experience one can have as far as interaction goes. This is because it captures not only task related engagements of a human but also behavioural, emotional and cognitive characteristics which are deemed as the three layers of human response in any kind of interaction. [47, 48, 49].

Considering an interaction among humans, one can understand or at least interpret the other person's emotional, cognitive and behavioural responses because we are equipped with similar sets of sensors and information processing units. Perhaps, *Social interaction* is the best interaction model which could potentially results a synergistic interaction experience in a CPSS context if properly mimicked in machines.

4.2.1. Conceptualising the Social dimension /Human aspects in CPSS

Having explored the various definitions of CPSS in literature, in this subsection we take a closer look at how the social dimension, i.e., the human aspect, has been conceptualised. The analysis reveals that research works systematically adopt one of the two views detailed below:

1. *Human as a sensor*: This is relatively the earliest view in the evolution from CPS to CPSS which originates with the increasing use of sensor-enabled smart devices by humans. In this view the social aspect was brought by considering humans as sources of information for Cyber-Physical systems (i.e. sensors). This conceptualisation primarily focuses on fusing various information originating from the social space (humans and their observations) with cyber-systems and physical-systems in order to accommodate various application needs [100, 101, 102, 103, 104, 105, 30, 44, 106, 107, 108, 38, 109, 110, 111, 112, 113, 144, 146, 147].
2. *Human as a system component*: On the other hand most of the recent works tend to conceptualize the social aspect of CPSS not only by considering human as a social sensor but also as co-creators being an integral part of the system. It is also known as the human-centric way of conceptualizing CPSS [98]. This way of conceptualization considers humans as members of the CPSS, involving observations, experiences, background knowledge, society, culture and perceptions (i.e human intelligence and social organizations (e.g. Communities)) in order to co-create products and services together with the CPS. Here humans play the role of resources in that they provide information, knowledge, services, etc., which at the same time they consume, thus becoming users of the CPSS [114, 115, 12, 116, 117, 118, 119, 120, 121, 122, 123, 61, 124, 125, 6, 126, 127, 39, 29, 128, 53, 11, 40, 129, 34, 130, 131, 98, 145, 132, 133, 45, 134, 135, 136, 137, 138, 53, 41, 139, 43, 32, 37, 35, 33, 31, 140, 141, 36, 142, 143].

Adopting the second view in recent years, a considerable advance has been made in CPSS research. Particularly research works had successful results in designing smart environments and objects/machines to perform various tasks with maximum effectiveness. These results are becoming more and more evident in various fields and the pursuit of simulating human intelligence in machines has allowed achieving high quality in task execution, in some cases even surpassing a human potential. However, as mentioned in section 4.2 the development of CPSS is still in it's infancy. This is mainly due to the fact that high performance in task execution as a result of social sensing and data analytics does not capture the true nature of social interaction which is embedded in humans. Furthermore in the current CPSS development direction the advance in task execution performance is promoting machines to replace human labor. Meanwhile the role of human is becoming nothing more than a button pusher. Of course labor intensive tasks if done faster and better should be taken by machines. Nevertheless, this should not be a trend in all aspects since human knowledge and skills remain indispensable. According to [152], putting humans and machines to work closely by promoting collaboration, learning and supervision can potentially deliver better outcomes than isolated operations. Enhancing the interaction between humans and machine in this context to reflect human like-social interaction is what signifies a true CPSS. Hence, the CPSS paradigm should take a holistic approach in understanding what characteristics

make humans social creatures and investigate to mimic those aspects in machines to bring about a synergistic social interaction. Thus, designing machines not to replace a human but to become better companion to co-create and serve. Doing so however is not a solution that emanates only from *Engineering* or *Computer Science* research. In addition to human dynamics itself the CPSS paradigm is also faced with a number of challenges that are associated to the presence of human in the system. Resource management, Interoperability, Privacy and Security are among the major ones [11, 50]. Hence, It requires additional interdisciplinary effort to address these issues and integrate social aspects in CPSS. Particularly from fields that investigate human dynamics. This includes but not limited to *Cognitive science*, *behavioural science*, *affect/emotion recognition and related subfields of Artificial intelligence (AI)*. Furthermore, to facilitate such multidisciplinary collaborations and support the development of novel methods in system designs, domain independent and common systemic ground of CPSS is needed. However, to the best of our knowledge this has not yet been addressed. Therefore, in the next section we propose a systemic formalisation of CPSS and a core meta-model to establish a systemic ground and underlining principles for the development of a true CPSS.

5. A Systemic formalisation of CPSS

According to the systemic notion established in section 2.1 a CPSS is before all a system, precisely a System-of-Systems (SoS). Having analysed the state-of-the-art on CPSS, it is evident that there is a lack of formalisation and a common understanding of CPSS which is grounded on the theory of systems. Hence, in this section we propose a systemic formalisation of CPSS to create a domain independent understanding of CPSS. Thus, making it suitable for adaptability across different domains and fostering a multidisciplinary collaborative research topic. As explained in the previous section, the current CPSS view shared by majority of the works is perceived as an environment. However, a CPSS is beyond an interaction environment. To elaborate on this, we introduce two distinct kinds of CPSS, namely, the *CPSS Space*, which corresponds to the current understanding, and the *CPSS Object*. Making this distinction allows to consider the latter as a next generation of CPS that is enhanced with social attributes allowing a better handling of human dynamics (*i.e.*, complex behavioural, emotional and cognitive aspects) and able to somehow socialise. We define a CPSS as follows, recalling that System and System-of-Systems are respectively defined by definition 1 and 2:

Definition 3. Cyber-Physical-Social System (CPSS): *is a system comprising cyber, physical and social components, which exists or emerges through the interactions between those components. A CPSS comprises at least one physical component responsible for sensing and actuation, one cyber component for computations and one social component for actuating social functions. We distinguish between two categories of CPSS, namely CPSS Object and CPSS Space.*

Definition 4. CPSS Object: *is a Cyber-Physical System enhanced with social capabilities. A CPSS Object is equipped with functions for sensing, actuation and computation, and social functions related to cognition, emotion or social behaviour, which has the capacity to understand and adapt to the needs and behaviour of a human.*

Examples of CPSS objects are social or collaborative robots, or machines and smart devices extended with social capabilities.

Definition 5. CPSS Space: *is a System-of-Systems (SoS) that emerges through the interaction of humans and CPS or CPSS Objects. A CPSS Space is the space (physical and/or virtual) where humans and CPS or CPSS Objects interact together.*

Examples of smart spaces are the so-called smart enterprises, smart buildings, smart homes, smart cities, etc. They are sometimes also called smart environments or smart systems[153]. Today, the CPSS Space concept refers to humans and CPS Objects, which are socially constrained. Our new perspective considers spaces with humans and CPSS Objects, *i.e.* machines with the ability to detect, reason and adopt to humans social interaction responses (emotional, cognitive and behavioural).

The complexity of any system depends on the nature of relations between its components, together with their individual nature, functions, objectives and behaviour. In a CPSS Space, CPS and CPSS Objects have their own functions and objectives. The space also has its own objectives which may imply some specific response from those CPS / CPSS Objects, but also some specific behaviour from humans. However, humans evolve in such kind of space in compliance with their own personality, capabilities and objectives. As a consequence, their behaviour cannot be predicted easily, and can generate instabilities in the CPSS Space. Additionally, humans might not be tolerant when it comes to following or respecting rules that are not aligned with their personality, way of thinking or convictions, thus adding

to the complexity. The fulfillment of a CPSS Space objectives while considering the constraints and complexity due to dynamic interactions between the entities evolving in it, humans and CPS or CPSS Objects, remains a challenge because they have all their own objectives and behaviour. This requires solutions that go beyond what CPS frameworks can offer currently. The systemic formalisation of CPSS proposed in this work allows to clearly identify system components and their interactions. This helps to recognise their functions, constraints and objectives, making it easier to detect possible conflicts and better manage instabilities. Moving forward we define the key relationships that exist between components leading to the emergence of a CPSS.

Let C , P , S be respectively the set of cyber, physical, and social components, and R be the set of existing relations, in a system of interest. We define three kinds of relations:

- $R^X: X \times X \rightarrow R$, where X is "C", "P" or "S"
- $R^{XY}: X \times Y \rightarrow R$, where X and Y are "C", "P" or "S" and $X \neq Y$
- $R^{CPS}: C \times P \times S \rightarrow R$

There are in total seven types of relations that can link components of a CPSS together, which we detail in the following: R^C , R^P , R^S , R^{CP} , R^{PS} , R^{CS} , and R^{CPS} .

- R^C :- refers to a connection between cyber components, existing in the virtual space, for example an information flow, a command, query, etc. It can also refer to the sharing of a computational resources. *e.g.*, two software packages sharing the same processing unit.
- R^P :- refers to a connection between physical components, existing in the physical space. An example could be the connection between mechanical parts of a machine.
- R^S :- refers to a social relationship between social components. It can materialise as an information flow or a transfer of knowledge between social components. It also reflects cognitive ties that govern human behaviour, *e.g.*, an intellectual conversation between people.
- R^{CP} :- refers to a relationship that exists between cyber components and physical components that can potentially result in the integration of computation with physical processes (sensing or actuation), *e.g.*, the relation between components of a smartphone to function. The R^{CP} relation leads to the emergence of a CPS (Cyber-Physical System):

$$\forall C, \forall P, \exists R^{CP} \Leftrightarrow \exists CPS \quad (1)$$

- R^{PS} :- refers to a relationship that exists between physical components and social components that can potentially result in cognitive processes and observable social behaviours. This is the property that enables a human to take actions that reflects his emotion, cognition and behaviour in a given context. The R^{PS} relation leads to the emergence of a PSS (Physical-Social System):

$$\forall P, \forall S, \exists R^{PS} \Leftrightarrow \exists PSS \quad (2)$$

- R^{CS} :- refers to the relationship between Cyber and Social components that can potentially result in the integration of computation and social capabilities, *e.g.*, virtual representation of people in a social network. The R^{CS} relation leads to the emergence of a CSS (Cyber-Social System):

$$\forall C, \forall S, \exists R^{CS} \Leftrightarrow \exists CSS \quad (3)$$

- R^{CPS} :- refers to a relationship that exists between at least one cyber, one physical and one social component, that can potentially result in the integration of sensing, actuation, computation and social processes. The R^{CPS} relation leads to the emergence of a CPSS (Cyber-Physical-Social System). R^{CPS} can also exist when we have the three components and there exist one relation between C and P (R^{CP}) and another relation between P and S (R^{PS}).

Formally, we define the emergence of a CPSS by the following formula:

$$\forall C, \forall P, \forall S, (\exists R^{CP} \wedge \exists R^{PS}) \vee \exists R^{CPS} \Rightarrow \exists CPSS \quad (4)$$

According to formula 4, there are two possibilities for the emergence of a CPSS (i) when there is at least one Cyber, one Physical, and one Social component, with at least two relations between them, R^{CP} and R^{PS} , which lead to an R^{CPS} that is responsible for the emergence of a CPSS or (ii) when there is a direct relationship R^{CPS} between the three components. The former creates a CPSS Space while the latter is responsible for the emergence of a CPSS Object. To support this, in Figure 10 we proposed a meta-model for CPSS using UML 2.0 notation. An earlier version of CPSS meta-model has been previously proposed by [12] as an extension from [154] to introduce the social component in CPS. The meta-model presented in Figure 10 is an extension and a generalisation of these preceding works. It formalises the main components of a CPSS as combinations of fundamental (C)yper, (P)hysical and (S)ocial elements, as well as the relation between them. It allows representing the different kinds of systems that emerge when relations are instantiated: Cyber-Physical-Social System (CPSS), Cyber-Physical System (CPS), Physical-Social System (PSS), and Cyber-Social System (CSS).

The CPSS meta-model is built on top of the systemic meta-model presented in Section 2.1. Formally, all component classes (*Cyber Component*, *Physical Component*, *Social Component*) are subclasses of *System Component*, and all system classes (*CPS*, *PSS*, *CPSS*, *CSS*) are subclasses of the general System class. As systems, the latter inherit from all the properties detailed in Section 2.1.

While the concepts of CPS and CPSS were already known, the meta-model introduces two new concepts: PSS and CSS. *PSS* is a composition of physical and social elements, where the social part is materialised through the physical part. The main representative is the *Human* system: the physical part is the physical body, while the social part is composed of the attributes that generate social responses such as cognition, behaviour and emotion, manifested through the body but distinct from it. The reader could argue that for Human, the social system is indeed a part of the physical system. However, we view the intangibles of social system separately to allow better understanding of the concepts. Thus, it unfolds additional layers of complexity. As the details are not of particular focus in this section, we

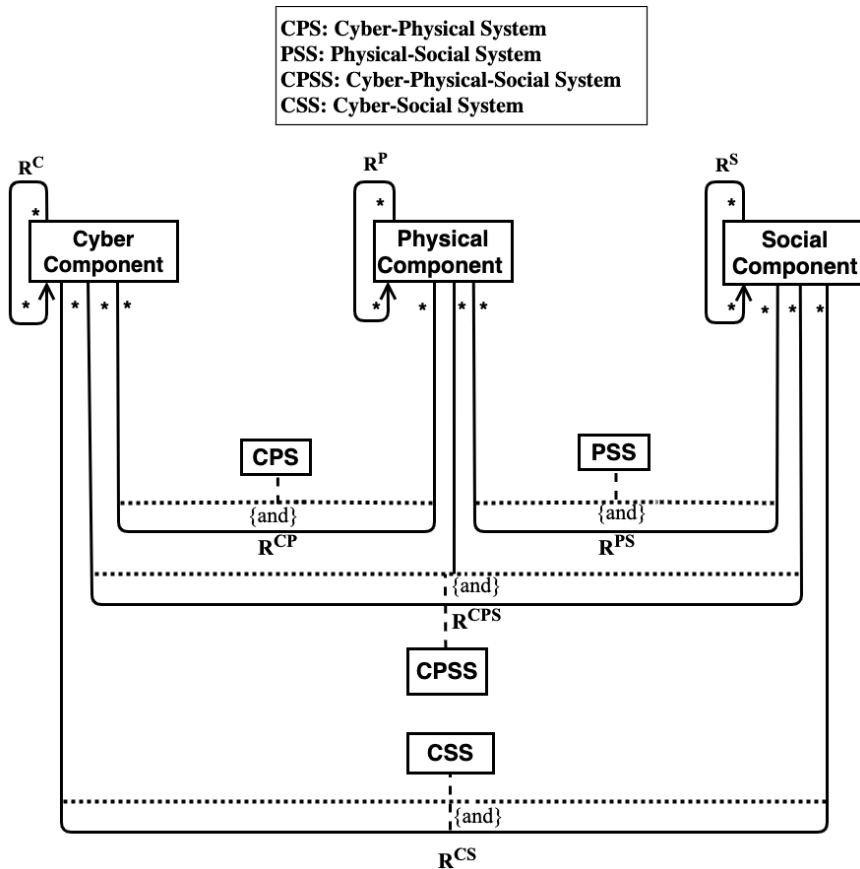

Figure 10: The CPSS Meta-model.

will keep things simplified for now and leave this for further discussion. CSS corresponds to a system where the social component is manifested through the cyber component. A typical kind of CSS is a *Social Network*, [155], where the social activities actually result from interactions in the virtual world. For a better readability in Fig. 10, relations are represented by a link, but all should be understood as subclasses of the systemic *Relation* class. The constraint *{and}* is used to represent the mandatory requirement of at least one component from each part in relation in order for a new system to emerge.

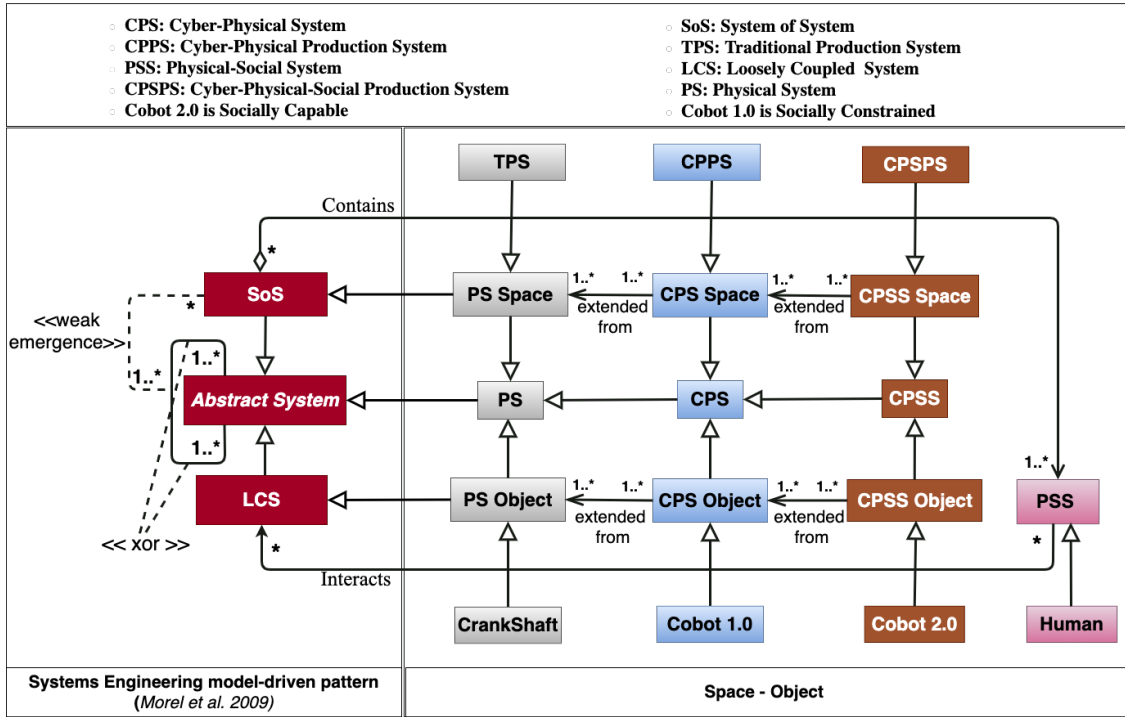

Figure 11: CPSS Space-Object Meta-model.

To elaborate on the distinction between *CPSS Object* and *CPSS Space* we present a complementary meta-model inspired by Systems Engineering model-driven pattern [56] in Figure 11. The classes *CPSS Object* and *CPSS Space* are subclass of *CPSS* which is a subclass of an *Abstract System* by inheritance. The *Abstract System* class is equivalent to the *System class* in Figure 1. In the work of *Morel et al.* [56] systems were described to be of tightly coupled (TCS) or loosely coupled (LCS). The tight coupling of systems refers to the composition of elementary elements, visible but so tightly linked together that the modification of one of them may cause trouble to the high order system that embeds it where as LCSs are less constrained in this sense. Thus, for most engineered systems, SoS was described as a *weak emergence* from LCSs. Nevertheless, SoS can also emerge from TCSs as in the case of *PSS* (e.g. *Human system*). The *CPSS Object* class is an LCS by inheritance extended from the *CPS Object* class which is an extension of *PS Object* class. Similarly, the class *CPSS Space* is an extension of *CPS Space* extended from *PS Space* which is a subclass of *SoS*. Thus, *CPSS Space* becomes an *SoS* by inheritance which is an aggregation of *Human*, *CPSS Objects*, *CPS Objects* and *PS Objects* interacting together. Similarly *CPS Space* is an *SoS* which is an aggregation of *Human* and the socially constrained LCSs (i.e. *PS Objects* and *CPS Objects*). We named Collaborative robot of today, *Cobot 1.0* as an example of *CPS Object* as it is socially constrained while *Cobot 2.0* is presented as an example of a socially capable *CPSS Object*.

The *CPSS Space-Object distinction Meta-model* (Figure 11) visualises the inheritance of properties and relations in the evolution from *Physical System* (e.g. *Traditional Production System(TPS)*) to *Cyber-Physical System* (e.g. *Cyber-Physical Production System(CPPS)*) and to *Cyber-Physical-Social System* (e.g. *Cyber-Physical-Social Production System(CPSPS)*). Reflecting back on the state-of-the-art the evolution of CPSS is summarised in Figure 12. The bubbles below the arrow represent the composition of the interaction spaces as the components mature. Whereas the bubbles above the arrow depict the details in the make up of the individual systems that a human interacts with. As it

can be seen in figure 12 the current understanding of CPSS corresponds to the *CPS space* respecting the granularity of the evolution. Hence, we have human interacting with socially constrained *CPS Objects*. However, our postulate is that a true *CPSS Space* is the one where a human interacts mainly (but eventually not only) with the CPSS's social component which is materialised through the socially capable *CPSS Objects* represented by the top bubble. Hence, the *CPSS* paradigm we propose in this work primarily aims at shading light in this direction to achieve social capability of machines.

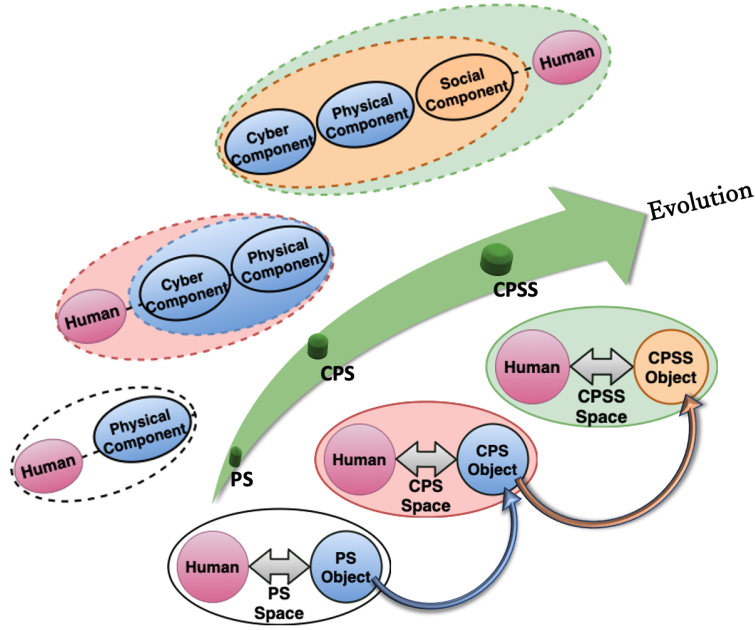

Figure 12: CPSS Evolution.

6. Perspectives and Future Direction

The proposed formalisation of CPSS followed by the discussion in section 5 makes it clear that the current state of the research is way behind from achieving the required level of maturity to be called a true CPSS. Hence, it opens opportunities in the CPSS research domain to propose solutions that can pave the way towards a true CPSS. From the state-of-the-art analysis it is also understandable that there are a number of open challenges to be addressed in the CPSS research such as *resource management, interoperability, security, etc.* [11]. Nevertheless, in the road towards a true CPSS, human dynamics remains being one of the major challenges yet to be tackled.

In a nutshell the CPSS vision introduced in section 5 ultimately aims at formalising a space called "*CPSS Space*" where the current socially constrained "*CPS Objects*" evolve to socially capable "*CPSS Objects*", ensuring thus a seamless interaction with humans. Doing so however requires first identifying the key social components in human-to-human interaction and mimicking those components in *CPS Objects* to transform them into *CPSS Objects*. Considering a human-to-human interaction, it is obvious that the quality of the interaction is subject to how well the individuals know each other. (*i.e.* if one knows the other person's preferences, behaviour, likes and dislikes it is more convenient to respond appropriately in a social context). The same is true in a human-machine interaction. Having a social component by itself signifies the ability to actuate socially however, for a seamless interaction one needs to know the interacting individual at a personal level. This is because each person is unique and his/her actions and behaviours are guided by individual knowledge, preferences, interests, culture and beliefs. Hence, in the context of *CPSS Space* the need to ensure a true social interaction positions the concept of *personalisation* or adaptation of the systems to human presence, at the heart of the problem.

The field of Personalisation is a relatively older research field dating back to the late 90s. The notion of personalisation, which is broadly known as customization, refers to tailoring a service or a product in a way that it fits to specific individuals' preferences, cognition, needs or capabilities under a given context [156]. Over the years technological

advances in web applications, online marketing and a tight link between humans and smart devices has revolutionized the need for personalized services. Virtual assistants on devices such as Alexa, Siri and Cortana, Chat-bots, Online recommendations for e-commerce and entertainment are among the popular areas where virtual personalisation has gained momentum. Recently the concept of personalisation, which is widely used in virtual applications started to be applied in physical spaces. For instance in museums to guide visitors to their presumed points of interest, in trip planning application to sort travel and tour recommendations. Nevertheless, unlike virtual personalisation, Physical space personalisation introduces more complexities from the physical world to the personalisation problem. This is because there are a number of stakeholders evolving in the physical space together with the personalised service consumer. Each stakeholder evolves with their own objectives to be satisfied, constraining each other while at the same time being constrained by environmental factors. This together with inconsistencies imposed by human behaviour and preferences makes the problem of personalisation rather complex. These contexts qualify as typical CPSS Spaces since they correspond to places cohabited by humans and CPS devices that are in virtual and physical interaction, however not designed as such. Hence, physical space personalisation can be framed as *Personalisation in CPSS*. This allows to leverage the systemic notion presented in section 2.1 to identify the main stakeholders, their corresponding objectives and constraining factors. The Problem of personalisation in a CPSS context has previously been formalised by taking into account not only the receiver of the personalisation service but also the co-existing stakeholders that have a direct or indirect influence on the user or the personalisation objective [11, 106].

Introducing the notion of personalisation in a CPSS context opens opportunities to design systems with abilities of recognising individual needs and preferences. Thereby enabling CPS Objects to somehow actuate socially and help bring the interaction experience to a personal level. As this is unexplored direction, particularly from the CPSS perspective discussed in this paper, we believe that it will contribute in the quest towards a true CPSS.

7. Conclusion

This work presented a Systematic Literature Review on Cyber-Physical-Social System (CPSS) identifying the complete spectrum of the notion and the underlining principles. It summarises the state-of-the-art perspectives on CPSS definitions, application areas and conceptualisations of the social aspect. The analysis revealed that the definitions provided for the CPSS notion as well as the conceptualisations of the social aspect are tightly linked to the target application areas. Despite the surge in the adoption of the CPSS acronym across various domains, there is no domain-independent formalisation or a common framework to characterise the concept. Furthermore, as CPSS is primarily regarded as a system, it should have an appropriate ground on systems science to appropriately design systemic objectives, component-wise relationships and interdependencies. Thus, allowing a better handling of perturbations and maintain systemic stability. However, the links with the theory of system in CPSS design methodologies are loose. Additionally the social aspect is not fully integrated in the paradigm. Following the results of the SLR analysis a systemic formalisation was proposed. This was done to establish a generic definition of CPSS grounded on the theory of systems and allow the development of novel methods to integrate the full spectrum of social aspects into CPSS. The CPSS paradigm proposed in this work distinguishes between two types of CPSS namely *CPSS Space* and *CPSS Object*. The *CPSS Objects* are evolved *CPS Objects* with social actuation capability. Whereas the *CPSS Space* is perceived as a place cohabited by humans and *CPSS Objects* that are in a virtual and physical interaction. The formalisation and the novel concepts introduced in this work were illustrated through meta-models. Having established a vision for the future of CPSS, the formalisation reveals that the current conceptualisations are not where they need to be to arrive at the required level of maturity. To this regard *Personalisation in Cyber-Physical-Social Systems* was proposed as one feasible direction to improve the social interaction experience in a CPSS context extending preceding works. Nevertheless, the proposal of creative directions to attenuate issues particularly related to social dynamics remain indispensable in the pursuit towards a true CPSS.

References

- [1] A. Koubâa, B. Andersson, A vision of cyber-physical internet, in: 8th International Workshop on Real-Time Networks, 2009, pp. –.
- [2] V. Gunes, S. Peter, T. Givargis, F. Vahid, A survey on concepts, applications, and challenges in cyber-physical systems., *KSI Transactions on Internet & Information Systems* 8 (12) (2014).
- [3] J. Gubbi, R. Buyya, S. Marusic, M. Palaniswami, Internet of things (iot): A vision, architectural elements, and future directions, *Future generation computer systems* 29 (7) (2013) 1645–1660.
- [4] S. Jeschke, T. Meisen, Everything 4.0-drivers and challenges of cyber physical systems, www.ima-zlw-ifu.rwth-aachen.de (2013).

- [5] E. A. Lee, Cyber physical systems: Design challenges, in: 2008 11th IEEE International Symposium on Object and Component-Oriented Real-Time Distributed Computing (ISORC), IEEE, 2008, pp. 363–369.
- [6] S. Wang, A. Zhou, M. Yang, L. Sun, C. Hsu, F. yang, Service Composition in Cyber-Physical-Social Systems, IEEE Transactions on Emerging Topics in Computing (2017) [doi:10.1109/TETC.2017.2675479](https://doi.org/10.1109/TETC.2017.2675479).
- [7] Z. Su, Q. Qi, Q. Xu, S. Guo, X. Wang, Incentive scheme for cyber physical social systems based on user behaviors, IEEE Transactions on Emerging Topics in Computing (2017).
- [8] D. S. Nunes, P. Zhang, J. S. Silva, A survey on human-in-the-loop applications towards an internet of all, IEEE Communications Surveys & Tutorials 17 (2) (2015) 944–965.
- [9] S. K. Sowe, E. Simmon, K. Zettsu, F. De Vault, I. Bojanova, Cyber-Physical-Human Systems: Putting People in the Loop, IT Professional 18 (1) (2016) 10–13. [doi:10.1109/MITP.2016.14](https://doi.org/10.1109/MITP.2016.14).
- [10] S. Munir, J. A. Stankovic, C.-J. M. Liang, S. Lin, Cyber physical system challenges for human-in-the-loop control, in: 8th International Workshop on Feedback Computing (Feedback Computing 13), USENIX Association, San Jose, CA, 2013, pp. 363–369. URL <https://www.usenix.org/conference/feedbackcomputing13/workshop-program/presentation/munir>
- [11] B. A. Yilma, Y. Naudet, H. Panetto, Introduction to personalisation in cyber-physical-social systems, in: Lecture Notes in Computer Science (including subseries Lecture Notes in Artificial Intelligence and Lecture Notes in Bioinformatics), Vol. 11231 LNCS, Springer Verlag, 2019, pp. 25–35. [doi:10.1007/978-3-030-11683-5_3](https://doi.org/10.1007/978-3-030-11683-5_3).
- [12] B. A. Yilma, H. Panetto, Y. Naudet, A Meta-Model of Cyber-Physical-Social System: The CPSS Paradigm to Support Human-Machine Collaboration in Industry 4.0, in: IFIP Advances in Information and Communication Technology, Vol. 568, Springer New York LLC, 2019, pp. 11–20. [doi:10.1007/978-3-030-28464-0_2](https://doi.org/10.1007/978-3-030-28464-0_2).
- [13] S. K. Sowe, E. Simmon, K. Zettsu, F. De Vault, I. Bojanova, Cyber-Physical-Human Systems: Putting People in the Loop, IT Professional 18 (1) (2016) 10–13. [doi:10.1109/MITP.2016.14](https://doi.org/10.1109/MITP.2016.14).
- [14] A. Smirnov, N. Shilov, O. Gusikhin, Cyber-physical-human system for connected car-based e-tourism : Approach and case study scenario, 2017 IEEE Conference on Cognitive and Computational Aspects of Situation Management, CogSIMA 2017 (2017) 1–7 [doi:10.1109/COGSIMA.2017.7929591](https://doi.org/10.1109/COGSIMA.2017.7929591).
- [15] S. A. Kumar, B. Bhargava, R. Macêdo, G. Mani, Securing iot-based cyber-physical human systems against collaborative attacks, in: 2017 IEEE International Congress on Internet of Things (ICIOT), IEEE, 2017, pp. 9–16.
- [16] J. Quintas, P. Menezes, J. Dias, Information model and architecture specification for context awareness interaction decision support in cyber-physical human-machine systems, IEEE Transactions on Human-Machine Systems 47 (3) (2016) 323–331.
- [17] A. Smirnov, A. Kashevnik, N. Shilov, A. Makklya, O. Gusikhin, Context-aware service composition in cyber physical human system for transportation safety, in: 2013 13th International Conference on ITS Telecommunications (ITST), 2013, pp. 139–144. [doi:10.1109/ITST.2013.6685535](https://doi.org/10.1109/ITST.2013.6685535).
- [18] P.-L. Wu, D. Raguraman, L. Sha, R. B. Berlin, J. M. Goldman, A treatment validation protocol for cyber-physical-human medical systems, in: 2014 40th EUROMICRO Conference on Software Engineering and Advanced Applications, IEEE, 2014, pp. 183–190.
- [19] C. Scheuermann, B. Bruegge, J. Folmer, S. Verclas, Incident Localization and Assistance System: A case study of a Cyber-Physical Human System, in: 2015 IEEE/CIC International Conference on Communications in China - Workshops (CIC/ICCC), 2015, pp. 57–61. [doi:10.1109/ICCCChinaW.2015.7961580](https://doi.org/10.1109/ICCCChinaW.2015.7961580).
- [20] H. Zhang, C. Li, Y. Chen, P. Ren, L. Wang, Predictable wireless networking for real-time cyber-physical-human systems, in: 2017 IEEE/ACM Second International Conference on Internet-of-Things Design and Implementation (IoTDI), IEEE, 2017, pp. 319–320.
- [21] K. D. Tsoukalas, G. P. Kontoudis, K. G. Vamvoudakis, Active-bayesian learning for cooperation connectivity in dynamic cyber-physical-human systems, in: 2017 IEEE Symposium Series on Computational Intelligence (SSCI), IEEE, 2017, pp. 1–7.
- [22] H. Haggi, M. Song, W. Sun, et al., A review of smart grid restoration to enhance cyber-physical system resilience, in: 2019 IEEE Innovative Smart Grid Technologies-Asia (ISGT Asia), IEEE, 2019, pp. 4008–4013.
- [23] Y. Zhu, Y. Tan, R. Li, X. Luo, Cyber-Physical-Social-Thinking Modeling and Computing for Geological Information Service System, in: 2015 International Conference on Identification, Information, and Knowledge in the Internet of Things (IIKI), 2015, pp. 193–196. [doi:10.1109/IIKI.2015.48](https://doi.org/10.1109/IIKI.2015.48).
- [24] J. Kannisto, N. Makitalo, T. Aaltonen, T. Mikkonen, Programming model perspective on security and privacy of social cyber-physical systems, Proceedings - 2016 IEEE International Conference on Mobile Services, MS 2016 (2016) 87–94 [doi:10.1109/MobServ.2016.23](https://doi.org/10.1109/MobServ.2016.23).
- [25] J. Xu, A. Liu, N. Xiong, T. Wang, Z. Zuo, Integrated collaborative filtering recommendation in social cyber-physical systems, International Journal of Distributed Sensor Networks 13 (12) (2017). [doi:10.1177/1550147717749745](https://doi.org/10.1177/1550147717749745).
- [26] Q. Xu, Z. Su, S. Yu, Green social cps based e-healthcare systems to control the spread of infectious diseases, in: 2018 IEEE International Conference on Communications (ICC), 2018, pp. 1–5. [doi:10.1109/ICC.2018.8422421](https://doi.org/10.1109/ICC.2018.8422421).
- [27] I. Horvath, Beyond advanced mechatronics: New design challenges of social-cyber-physical systems, in: s.n. (Ed.), Proceedings of the 1" Workshop on "Mechatronic Design" Linz 2012, ACCM, 2012, pp. 1–20, geen ISBN; 1th Workshop on "Mechatronic Design", Linz, Austria ; Conference date: 30-11-2012 Through 30-11-2012.
- [28] L. Chen, D. J. Cook, B. Guo, W. Leister, Guest editorialspecial issue on situation, activity, and goal awareness in cyber-physical human-machine systems, IEEE Transactions on Human-Machine Systems 47 (3) (2017) 305–309.
- [29] L. Huang, G. Zhang, S. Yu, A Data Storage and Sharing Scheme for Cyber-Physical-Social Systems, IEEE Access 8 (2020) 31471–31480. [doi:10.1109/ACCESS.2020.2973354](https://doi.org/10.1109/ACCESS.2020.2973354).
- [30] F. Zhong, G. Wang, Z. Chen, F. Xia, G. Min, Cross-modal retrieval for CPSS data, IEEE Access 8 (2020) 16689–16701. [doi:10.1109/ACCESS.2020.2967594](https://doi.org/10.1109/ACCESS.2020.2967594).
- [31] J. Wang, Z. Yan, K. C. K.-C. K. K.-C. Li, H. Xie, X. Liu, Local Codes with Cooperative Repair in Distributed Storage of Cyber-Physical-Social Systems, IEEE Access 8 (2020) 38622–38632. [doi:10.1109/ACCESS.2020.2975577](https://doi.org/10.1109/ACCESS.2020.2975577).
- [32] F. Shen, C. Xu, J. Zhang, Statistical Behavior Guided Block Allocation in Hybrid Cache-Based Edge Computing for Cyber-Physical-Social

- Systems, *IEEE Access* 8 (2020) 29055–29063. doi:10.1109/ACCESS.2020.2972305.
- [33] K. Peng, X. Qian, B. Zhao, K. Zhang, Y. Liu, A New Cloudlet Placement Method Based on Affinity Propagation for Cyber-Physical-Social Systems in Wireless Metropolitan Area Networks, *IEEE Access* 8 (2020) 34313–34325. doi:10.1109/ACCESS.2020.2974895.
- [34] L. Xu, J. Han, T. Wang, L. Bai, An Efficient CNN to Realize Speckle Correlation Imaging Based on Cloud-Edge for Cyber-Physical-Social-System, *IEEE Access* 8 (2020) 54154–54163. doi:10.1109/ACCESS.2020.2979786.
- [35] Y. Peng, Y. Song, W. Huang, H. Deng, Y. Wang, Q. Chen, M. Liao, J. Hua, Self-Layer and Cross-Layer Bilinear Aggregation for Fine-Grained Recognition in Cyber-Physical-Social Systems, *IEEE Access* 8 (2020) 55826–55833. doi:10.1109/ACCESS.2020.2981950.
- [36] W. Zhang, X. Chen, Y. Liu, Q. Xi, A Distributed Storage and Computation k-Nearest Neighbor Algorithm Based Cloud-Edge Computing for Cyber-Physical-Social Systems, *IEEE Access* 8 (2020) 50118–50130. doi:10.1109/ACCESS.2020.2974764.
- [37] Z. Zhu, Y. Wen, Z. Zhang, Z. Yan, S. Huang, X. Xu, Accurate position estimation of mobile robot based on cyber-physical-social systems (CPSS), *IEEE Access* 8 (2020) 56359–56370. doi:10.1109/ACCESS.2020.2980558.
- [38] Z. Liu, X. Yin, Y. Hu, CPSS LR-DDoS Detection and Defense in Edge Computing Utilizing DCNN Q-Learning, *IEEE Access* 8 (2020) 42120–42130. doi:10.1109/ACCESS.2020.2976706.
- [39] F. Dai, Q. Mo, Z. Qiang, B. Huang, W. Kou, H. Yang, A Choreography Analysis Approach for Microservice Composition in Cyber-Physical-Social Systems, *IEEE Access* 8 (2020) 53215–53222. doi:10.1109/ACCESS.2020.2980891.
- [40] X. Wang, L. T. Yang, Y. Wang, X. Liu, Q. Zhang, M. J. Deen, A Distributed Tensor-Train Decomposition Method for Cyber-Physical-Social Services, *ACM Transactions on Cyber-Physical Systems* 3 (4) (2019) 1–15. doi:10.1145/3323926.
- [41] W. Li, Z. Lin, H. Zhou, G. Yan, Multi-objective optimization for cyber-physical-social systems: a case study of electric vehicles charging and discharging, *IEEE Access* 7 (2019) 76754–76767.
- [42] P. Fantini, P. Leitao, J. Barbosa, M. Taisch, Symbiotic Integration of Human Activities in Cyber-Physical Systems, *IFAC-PapersOnLine* 52 (19) (2019) 133–138. doi:https://doi.org/10.1016/j.ifacol.2019.12.124.
URL <http://www.sciencedirect.com/science/article/pii/S2405896319319597><https://doi.org/10.1016/j.ifacol.2019.12.124>
- [43] P. Wang, L. T. Yang, J. Li, J. Chen, S. Hu, Data fusion in cyber-physical-social systems: State-of-the-art and perspectives, *Information Fusion* 51 (2019) 42–57. doi:10.1016/j.inffus.2018.11.002.
- [44] V. Hahanov, S. Chumachenko, E. Litvinova, A. Hahanova, Cyber-physical social monitoring and governance for the state structures, in: 2018 IEEE 9th International Conference on Dependable Systems, Services and Technologies (DESSERT), 2018, pp. 123–129. doi:10.1109/DESSERT.2018.8409112.
- [45] C. G. Cassandras, Smart cities as cyber-physical social systems, *Engineering* 2 (2) (2016) 156 – 158. doi:https://doi.org/10.1016/J.ENG.2016.02.012.
URL <http://www.sciencedirect.com/science/article/pii/S2095809916309420>
- [46] S. De, Y. Zhou, I. Larizgoitia Abad, K. Moessner, Cyber-physical-social frameworks for urban big data systems: A survey, *Applied Sciences* 7 (10) (2017) 1017.
- [47] D. A. Norman, *The Design of Everyday Things*, 1st Edition, Basic Books, New York, 1988.
- [48] D. A. Norman, The design of everyday things, *Choice Reviews Online* 51 (10) (2014) 51–5559–51–5559. doi:10.5860/choice.51-5559.
- [49] M. Peruzzini, F. Grandi, M. Pellicciari, Exploring the potential of operator 4.0 interface and monitoring, *Computers & Industrial Engineering* (2018) 105600doi:https://doi.org/10.1016/j.cie.2018.12.047.
- [50] Y. Zhou, F. R. Yu, J. Chen, Y. Kuo, Cyber-physical-social systems: A state-of-the-art survey, challenges and opportunities, *IEEE Communications Surveys & Tutorials* 22 (1) (2019) 389–425.
- [51] H. Lee, J. Kwon, Survey and Analysis of Information Sharing in Social IoT, in: 2015 8th International Conference on Disaster Recovery and Business Continuity (DRBC), 2015, pp. 15–18. doi:10.1109/DRBC.2015.13.
- [52] M. V. Bavaresco, S. D’Oca, E. Ghisi, R. Lamberts, Technological innovations to assess and include the human dimension in the building-performance loop: A review, *Energy and Buildings* 202 (2019) 109365. doi:https://doi.org/10.1016/j.enbuild.2019.109365.
URL <http://www.sciencedirect.com/science/article/pii/S0378778819315853>
- [53] J. J. Zhang, F.-Y. Wang, X. Wang, G. Xiong, F. Zhu, Y. Lv, J. Hou, S. Han, Y. Yuan, Q. Lu, et al., Cyber-physical-social systems: The state of the art and perspectives, *IEEE Transactions on Computational Social Systems* 5 (3) (2018) 829–840.
- [54] M. W. Maier, *Architecting Principles for Systems-of-Systems*, *INCOSE International Symposium* 6 (1) (1996) 565–573. doi:10.1002/j.2334-5837.1996.tb02054.x.
- [55] L. Von Bertalanffy, The history and status of general systems theory, *Academy of management journal* 15 (4) (1972) 407–426.
- [56] G. Morel, H. Panetto, F. Mayer, J.-P. Auzelle, System of enterprise-systems integration issues: an engineering perspective, *IFAC Proceedings Volumes* (10 2007).
- [57] Y. Naudet, T. Latour, W. Guedria, D. Chen, Towards a systemic formalisation of interoperability, *Computers in Industry* 61 (2) (2010) 176 – 185, integration and Information in Networked Enterprises. doi:https://doi.org/10.1016/j.compind.2009.10.014.
URL <http://www.sciencedirect.com/science/article/pii/S0166361509002073>
- [58] W. A. Owens, *The emerging US system-of-systems*, National Defense University, Institute for National Strategic Studies, 1996.
- [59] D. C. Gompert, J. A. Isaacson, R. Corporation., N. D. R. I. (U.S.), *Planning a ballistic missile defense system of systems : an adaptive strategy / David C. Gompert and Jeffrey A. Isaacson*, RAND Santa Monica, Calif, 1999.
- [60] J. L. Dietz, J. A. Hoogervorst, Enterprise ontology in enterprise engineering, in: *Proceedings of the 2008 ACM symposium on Applied computing*, ACM, 2008, pp. 572–579.
- [61] J. Zeng, L. T. Yang, J. Ma, A system-level modeling and design for cyber-physical-social systems, *ACM Transactions on Embedded Computing Systems* 15 (2) (2016). doi:10.1145/2834119.
URL <https://www.scopus.com/inward/record.uri?eid=2-s2.0-84969988986&doi=10.1145/2834119&partnerID=40&md5=13caa6475159934da4140e8c52dca20f>

- [62] B. Kitchenham, Procedures for performing systematic reviews, Keele, UK, Keele University 33 (2004) (2004) 1–26.
- [63] G. d. S. S. Leal, W. Guédria, H. Panetto, Interoperability assessment: A systematic literature review, *Computers in Industry* 106 (2019) 111–132.
- [64] OMG, Business Process Model and Notation (BPMN), Version 2.0 (January 2011).
URL <http://www.omg.org/spec/BPMN/2.0>
- [65] B. Kitchenham, R. Pretorius, D. Budgen, O. P. Brereton, M. Turner, M. Niazi, S. Linkman, Systematic literature reviews in software engineering – a tertiary study, *Information and Software Technology* 52 (8) (2010) 792 – 805. doi:<https://doi.org/10.1016/j.infsof.2010.03.006>.
URL <http://www.sciencedirect.com/science/article/pii/S0950584910000467>
- [66] N. Van Eck, L. Waltman, Software survey: Vosviewer, a computer program for bibliometric mapping, *scientometrics* 84 (2) (2010) 523–538.
- [67] C. Wohlin, Guidelines for snowballing in systematic literature studies and a replication in software engineering, in: *Proceedings of the 18th international conference on evaluation and assessment in software engineering*, 2014, pp. 1–10.
- [68] R. Sharpe, K. van Lopik, A. Neal, P. Goodall, P. P. Conway, A. A. West, An industrial evaluation of an Industry 4.0 reference architecture demonstrating the need for the inclusion of security and human components, *Computers in Industry* 108 (2019) 37–44. doi:[10.1016/j.compind.2019.02.007](https://doi.org/10.1016/j.compind.2019.02.007).
- [69] A. Y. . Ou, Yu Jiang, P. Wu, L. Sha, R. B. Berlin, Using human intellectual tasks as guidelines to systematically model medical cyber-physical systems, in: *2016 IEEE International Conference on Systems, Man, and Cybernetics (SMC)*, 2016, pp. 4394–4399. doi:[10.1109/SMC.2016.7844922](https://doi.org/10.1109/SMC.2016.7844922).
- [70] C. Kotronis, I. Routis, A. Tsadimas, M. Nikolaidou, D. Anagnostopoulos, A Model-Based Approach for the Design of Cyber-Physical Human Systems Emphasizing Human Concerns, in: *2019 IEEE International Congress on Internet of Things (ICIOT)*, 2019, pp. 100–107. doi:[10.1109/ICIOT.2019.00028](https://doi.org/10.1109/ICIOT.2019.00028).
- [71] P. Fantini, M. Pinzone, M. Taisch, Placing the operator at the centre of Industry 4.0 design: Modelling and assessing human activities within cyber-physical systems, *Computers and Industrial Engineering* 139 (February 2018) (2020) 105058. doi:[10.1016/j.cie.2018.01.025](https://doi.org/10.1016/j.cie.2018.01.025).
- [72] J. Zhou, P. Li, Y. Zhou, B. Wang, J. Zang, L. Meng, Toward new-generation intelligent manufacturing, *Engineering* 4 (1) (2018) 11–20.
- [73] J. Zhou, Y. Zhou, B. Wang, J. Zang, Human–cyber–physical systems (hcpss) in the context of new-generation intelligent manufacturing, *Engineering* 5 (4) (2019) 624 – 636. doi:<https://doi.org/10.1016/j.eng.2019.07.015>.
URL <http://www.sciencedirect.com/science/article/pii/S2095809919306514>
- [74] G. Schirner, D. Erdogmus, K. Chowdhury, T. Padir, The future of human-in-the-loop cyber-physical systems, *Computer* 46 (1) (2013) 36–45. doi:[10.1109/MC.2013.31](https://doi.org/10.1109/MC.2013.31).
- [75] V. Dimitrov, T. Padir, A shared control architecture for human-in-the-loop robotics applications, in: *The 23rd IEEE International Symposium on Robot and Human Interactive Communication*, 2014, pp. 1089–1094. doi:[10.1109/ROMAN.2014.6926397](https://doi.org/10.1109/ROMAN.2014.6926397).
- [76] A. Figueira, D. Nunes, R. Barbosa, A. Reis, H. Aguiar, S. Sinche, A. Rodrigues, V. Pereira, H. Dias, C. Herrera, D. Raposo, J. S. Silva, F. Boavida, WeDoCare: A humanitarian people-centric cyber-physical system for the benefit of refugees, in: *2016 IEEE Global Humanitarian Technology Conference (GHTC)*, 2016, pp. 213–219. doi:[10.1109/GHTC.2016.7857283](https://doi.org/10.1109/GHTC.2016.7857283).
- [77] A. C. Koenig, R. Riener, *The human in the loop, Neurorehabilitation Technology, Second Edition* (2016) 161–181doi:[10.1007/978-3-319-28603-7_9](https://doi.org/10.1007/978-3-319-28603-7_9).
- [78] X. Wang, L. Li, Y. Yuan, P. Ye, F.-Y. Wang, ACP-based social computing and parallel intelligence: Societies 5.0 and beyond, *CAAI Transactions on Intelligence Technology* 1 (4) (2016) 377–393. doi:<https://doi.org/10.1016/j.trit.2016.11.005>.
URL <http://www.sciencedirect.com/science/article/pii/S246823221630083X>
- [79] J. A. Stankovic, Research Directions for Cyber Physical Systems in Wireless and Mobile Healthcare, *ACM Transactions on Cyber-Physical Systems* 1 (1) (2016) 1–12. doi:[10.1145/2899006](https://doi.org/10.1145/2899006).
- [80] M. Jirgl, Z. Bradac, P. Fiedler, Human-in-the-loop issue in context of the cyber-physical systems, *IFAC-PapersOnLine* 51 (6) (2018) 225–230.
- [81] D. Nunes, J. S. Silva, F. Boavida, *A Practical Introduction to Human-in-the-Loop Cyber-Physical Systems*, 1st Edition, Wiley-IEEE Press, 2018.
- [82] C. Cimini, F. Pirola, R. Pinto, S. Cavalieri, A human-in-the-loop manufacturing control architecture for the next generation of production systems, *Journal of Manufacturing Systems* 54 (2020) 258–271. doi:<https://doi.org/10.1016/j.jmsy.2020.01.002>.
URL <http://www.sciencedirect.com/science/article/pii/S0278612520300029>
- [83] M. Davoudpour, A. Sadeghian, H. Rahnama, Synthesizing social context for making Internet of Things environments more immersive, in: *2015 6th International Conference on the Network of the Future (NOF)*, 2015, pp. 1–5. doi:[10.1109/NOF.2015.7333282](https://doi.org/10.1109/NOF.2015.7333282).
- [84] V. Miori, D. Russo, Improving life quality for the elderly through the Social Internet of Things (SIoT), in: *2017 Global Internet of Things Summit (GIoTS)*, 2017, pp. 1–6. doi:[10.1109/GIoTS.2017.8016215](https://doi.org/10.1109/GIoTS.2017.8016215).
- [85] K. Rabadiya, A. Makwana, S. Jardosh, Revolution in networks of smart objects: Social Internet of Things, in: *2017 International Conference on Soft Computing and its Engineering Applications (icSoftComp)*, 2017, pp. 1–8. doi:[10.1109/ICSOFTCOMP.2017.8280086](https://doi.org/10.1109/ICSOFTCOMP.2017.8280086).
- [86] E. Baccarelli, M. Scarpiniti, P. G. V. Naranjo, L. Vaca-Cardenas, Fog of Social IoT: When the Fog Becomes Social, *IEEE Network* 32 (4) (2018) 68–80. doi:[10.1109/MNET.2018.1700031](https://doi.org/10.1109/MNET.2018.1700031).
- [87] R. Girau, E. Ferrara, M. Pintor, M. Sole, D. Giusto, Be Right Beach: A Social IoT System for Sustainable Tourism Based on Beach Overcrowding Avoidance, in: *2018 IEEE International Conference on Internet of Things (iThings) and IEEE Green Computing and Communications (GreenCom) and IEEE Cyber, Physical and Social Computing (CPSCoM) and IEEE Smart Data (SmartData)*, 2018, pp. 9–14. doi:[10.1109/Cybermatics_2018.2018.00036](https://doi.org/10.1109/Cybermatics_2018.2018.00036).
- [88] P. Smart, A. Madaan, W. Hall, Where the smart things are: social machines and the Internet of Things, *Phenomenology and the Cognitive Sciences* 18 (3) (2019) 551–575. doi:[10.1007/s11097-018-9583-x](https://doi.org/10.1007/s11097-018-9583-x).
- [89] X. Yao, Y. Lin, Emerging manufacturing paradigm shifts for the incoming industrial revolution, *International Journal of Advanced Manufacturing Technology* 85 (5-8) (2016) 1665–1676. doi:[10.1007/s00170-015-8076-0](https://doi.org/10.1007/s00170-015-8076-0).

- [90] J. Zhou, X. Yao, J. Zhang, Big Data in Wisdom Manufacturing for Industry 4.0, in: 2017 5th International Conference on Enterprise Systems (ES), 2017, pp. 107–112. doi:10.1109/ES.2017.24.
- [91] T. Nguyen, A modelling simulation based engineering approach for socio-cyber-physical systems, in: 2017 IEEE 14th International Conference on Networking, Sensing and Control (ICNSC), 2017, pp. 702–707. doi:10.1109/ICNSC.2017.8000176.
- [92] Y. Zhu, Y. Tan, R. Li, X. Luo, Cyber-physical-social-thinking modeling and computing for geological information service system, International Journal of Distributed Sensor Networks 12 (11) (2016) 155014771666666. doi:10.1177/1550147716666666.
URL <http://journals.sagepub.com/doi/10.1177/1550147716666666>
- [93] H. Ning, H. Liu, J. Ma, L. T. Yang, R. Huang, Cybermatics: Cyber–physical–social–thinking hyperspace based science and technology, Future Generation Computer Systems 56 (2016) 504 – 522. doi:https://doi.org/10.1016/j.future.2015.07.012.
- [94] I. Zolotová, P. Papcun, E. Kajáti, M. Miškuf, J. Mocnej, Smart and cognitive solutions for Operator 4.0: Laboratory H-CPSS case studies, Computers & Industrial Engineering 139 (October 2018) (2020) 105471. doi:https://doi.org/10.1016/j.cie.2018.10.032.
URL <https://doi.org/10.1016/j.cie.2018.10.032><http://www.sciencedirect.com/science/article/pii/S0360835218305126>
- [95] D. Romero, J. Stahre, M. Taisch, The Operator 4.0: Towards socially sustainable factories of the future, Computers & Industrial Engineering 139 (November 2019) (2020) 106128. doi:https://doi.org/10.1016/j.cie.2019.106128.
URL <http://www.sciencedirect.com/science/article/pii/S0360835219305972>
- [96] P. Dutta Pramanik, S. Pal, P. Choudhury, Beyond automation: The cognitive iot, Artificial Intelligence Brings Sense to the Internet of Things. Springer International Publishing AG 10 (2018) 978–3.
- [97] M. Zhang, H. Zhao, R. Zheng, Q. Wu, W. Wei, Cognitive internet of things: concepts and application example, International Journal of Computer Science Issues (IJCSI) 9 (6) (2012) 151.
- [98] A. Sheth, Physical-Cyber-Social Computing: An Early 21st Century Approach to Computing for Human Experience, IEEE Internet Computing 14 (1) (2010) 88–91. doi:10.1109/MIC.2010.4.
URL <http://wiki.knoesis.org/index.php/PCS{%}%5Cnfiles/2/PCS.html>
- [99] F. C. Delicato, A. Al-Anbuky, K. I.-K. Wang, Editorial: Smart Cyber–Physical Systems: Toward Pervasive Intelligence systems, Future Generation Computer Systems 107 (2020) 1134–1139. doi:https://doi.org/10.1016/j.future.2019.06.031.
URL <http://www.sciencedirect.com/science/article/pii/S0167739X19316619>
- [100] R. K. Ganti, Y.-E. Tsai, T. F. Abdelzaher, Senseworld: Towards cyber-physical social networks, in: 2008 International Conference on Information Processing in Sensor Networks (ipsn 2008), IEEE, 2008, pp. 563–564.
- [101] D. N. Crowley, E. Curry, J. G. Breslin, Closing the loop — From citizen sensing to citizen actuation, in: 2013 7th IEEE International Conference on Digital Ecosystems and Technologies (DEST), 2013, pp. 108–113. doi:10.1109/DEST.2013.6611338.
- [102] M. Gharib, P. Lollini, A. Bondavalli, Towards an approach for analyzing trust in Cyber-Physical-Social Systems, 2017 12th System of Systems Engineering Conference, SoSE 2017 (2017) 1–6doi:10.1109/SYSOSE.2017.7994947.
- [103] H. Ramadhan, D. Oktaria, I. G. B. B. Nugraha, Road traffic signal control using cyber physical social system, in: 2017 International Conference on Information Technology Systems and Innovation (ICITSI), 2017, pp. 223–227. doi:10.1109/ICITSI.2017.8267947.
- [104] K. Murakami, Cpss (cyber-physical-social system initiative-beyond cps (cyber-physical system) for a better future-” keynote speech, JEC-ECC 2012 (2012).
- [105] R. E. N. Sisyanto, Suhardi, N. B. Kurniawan, Hydroponic smart farming using cyber physical social system with telegram messenger, in: 2017 International Conference on Information Technology Systems and Innovation (ICITSI), Institute of Electrical and Electronics Engineers Inc., 2017, pp. 239–245. doi:10.1109/ICITSI.2017.8267950.
- [106] Y. Naudet, B. A. Yilma, H. Panetto, Personalisation in Cyber Physical and Social Systems: The Case of Recommendations in Cultural Heritage Spaces, in: Proceedings - 13th International Workshop on Semantic and Social Media Adaptation and Personalization, SMAP 2018, 2018, pp. 75–79. doi:10.1109/SMAP.2018.8501890.
- [107] Q. Gao, X. Shen, W. Niu, Large-Scale Synthetic Urban Dataset for Aerial Scene Understanding, IEEE Access 8 (2020) 42131–42140. doi:10.1109/ACCESS.2020.2976686.
- [108] B. Xin, Y. Wang, Stability and Hopf Bifurcation of a Stochastic Cournot Duopoly Game in a Blockchain Cloud Services Market Driven by Brownian Motion, IEEE Access 8 (2020) 41432–41438. doi:10.1109/ACCESS.2020.2976501.
- [109] Y. Song, Y. Zhu, J. Hou, S. Du, S. Song, Astronomical data preprocessing implementation based on FPGA and data transformation strategy for the FAST telescope as a giant CPS, IEEE Access 8 (2020) 56837–56846. doi:10.1109/ACCESS.2020.2981816.
- [110] J. Leng, P. Jiang, C. Liu, C. Wang, Contextual self-organizing of manufacturing process for mass individualization: a cyber-physical-social system approach, Enterprise Information Systems 0 (0) (2018) 1–26. doi:10.1080/17517575.2018.1470259.
- [111] P. Wang, L. T. Yang, J. Li, An Edge Cloud-Assisted CPSS Framework for Smart Cities, IEEE CLOUD COMPUTING 5 (5) (2018) 37–46. doi:{10.1109/MCC.2018.053711665}.
- [112] B. Bordel Sanchez, R. Alcarria, A. Sanchez-Picot, D. Sanchez-de Rivera, A Methodology for the Design of Application-Specific Cyber-Physical Social Sensing Co-Simulators, SENSORS 17 (10) (OCT 2017). doi:{10.3390/s17102177}.
- [113] Y. Xue, X. Yu, Beyond Smart Grid-A Cyber-Physical-Social System in Energy Future, PROCEEDINGS OF THE IEEE 105 (12) (2017) 2290–2292. doi:{10.1109/JPROC.2017.2768698}.
- [114] Z. Liu, D.-s. S. Yang, D. Wen, W.-m. M. Zhang, W. Mao, Cyber-Physical-Social Systems for Command and Control, IEEE Intelligent Systems 26 (4) (2011) 92–96. doi:10.1109/MIS.2011.69.
URL <http://ieeexplore.ieee.org/document/5968110/>
- [115] X. Wang, W. Wang, L. T. Yang, S. Liao, D. Yin, M. J. Deen, A Distributed HOSVD Method With Its Incremental Computation for Big Data in Cyber-Physical-Social Systems, IEEE Transactions on Computational Social Systems 5 (2) (2018) 481–492. doi:10.1109/TCSS.2018.2813320.
- [116] X. Zhou, G. Xu, J. Ma, I. Ruchkin, Scalable platforms and advanced algorithms for IoT and cyber-enabled applications, Journal of parallel

- and distributed computing 118 (1) (2018) 1–4. doi:{10.1016/j.jpdc.2018.03.002}.
- [117] K. Ding, P. Jiang, Incorporating social sensors, cyber-physical system nodes, and smart products for personalized production in a social manufacturing environment, Proceedings of the institution of mechanical engineers part b-journal of engineering manufacture 232 (13, SI) (2018) 2323–2338. doi:{10.1177/0954405417716728}.
- [118] X. Luo, Z. He, Z. Zhao, L. Wang, W. Wang, H. Ning, J.-H. Wang, W. Zhao, J. Zhang, Resource Allocation in the Cognitive Radio Network-Aided Internet of Things for the Cyber-Physical-Social System: An Efficient Jaya Algorithm, SENSORS 18 (11) (NOV 2018). doi:{10.3390/s18113649}.
- [119] F. Ansari, M. Khobreh, U. Seidenberg, W. Sihn, A problem-solving ontology for human-centered cyber physical production systems, CIRP JOURNAL OF MANUFACTURING SCIENCE AND TECHNOLOGY 22 (2018) 91–106. doi:{10.1016/j.cirpj.2018.06.002}.
- [120] F.-Y. Wang, J. J. Zhang, Transportation 5.0 in cps: Towards acp-based society-centered intelligent transportation, in: 2017 IEEE 20th International Conference on Intelligent Transportation Systems (ITSC), IEEE, 2017, pp. 762–767.
- [121] A. Smirnov, T. Levashova, N. Shilov, K. Sandkuhl, Ontology for cyber-physical-social systems self-organisation, in: Conference of Open Innovation Association, FRUCT, Vol. 2014-Decem, 2014, pp. 101–107. doi:10.1109/FRUCT.2014.7000933.
- [122] W. Guo, Y. Zhang, L. Li, The integration of CPS, CPSS, and ITS: A focus on data, Tsinghua Science and Technology 20 (4) (2015) 327–335. doi:10.1109/TST.2015.7173449.
- [123] A. Smirnov, A. Kashevnik, N. Shilov, Cyber-physical-social system self-organization: ontology-based multi-level approach and case study, in: 2015 IEEE 9th International Conference on Self-Adaptive and Self-Organizing Systems, IEEE, 2015, pp. 168–169.
- [124] S. Misra, S. Goswami, C. Taneja, Multivariate Data Fusion-Based Learning of Video Content and Service Distribution for Cyber Physical Social Systems, IEEE Transactions on Computational Social Systems 3 (1) (2016) 1–12. doi:10.1109/TCSS.2016.2561200.
- [125] Z. C. M. Candra, H. Truong, S. Dustdar, On Monitoring Cyber-Physical-Social Systems, in: 2016 IEEE World Congress on Services (SERVICES), 2016, pp. 56–63. doi:10.1109/SERVICES.2016.14.
- [126] Z. Su, Q. Qi, Q. Xu, S. Guo, X. Wang, Incentive Scheme for Cyber Physical Social Systems Based on User Behaviors, IEEE Transactions on Emerging Topics in Computing (2017) 1doi:10.1109/TETC.2017.2671843.
- [127] M. Z. Candra, H.-L. Truong, Reliable coordination patterns in cyber-physical-social systems, in: 2016 International Conference on Data and Software Engineering (ICoDSE), IEEE, 2016, pp. 1–6.
- [128] S. Wang, Y. Guo, Y. Li, C.-H. C.-H. Hsu, Cultural distance for service composition in cyber-physical-social systems, Future Generation Computer Systems (2018). doi:10.1016/j.future.2018.06.012.
- [129] C. Gan, Q. Feng, X. Zhang, Z. Zhang, Q. Zhu, Dynamical Propagation Model of Malware for Cloud Computing Security, IEEE Access 8 (2020) 20325–20333. doi:10.1109/ACCESS.2020.2968916.
- [130] S. Liu, Y. Chen, H. Huang, L. Xiao, X. Hei, Towards smart educational recommendations with reinforcement learning in classroom, in: 2018 IEEE International Conference on Teaching, Assessment, and Learning for Engineering (TALE), IEEE, 2018, pp. 1079–1084.
- [131] S. B. Utomo, B. Hendradjaya, Usability testing and evaluation of smart culinary system based on cyber-physical-social system, in: 2017 International Conference on Information Technology Systems and Innovation (ICITSI), IEEE, 2017, pp. 219–222.
- [132] G. Xiong, F. Zhu, X. Liu, X. Dong, W. Huang, S. Chen, K. Zhao, Cyber-physical-social system in intelligent transportation, IEEE/CAA Journal of Automatica Sinica 2 (3) (2015) 320–333. doi:10.1109/JAS.2015.7152667.
- [133] A. Costanzo, A. Faro, D. Giordano, C. Spampinato, An ontological ubiquitous city information platform provided with Cyber-Physical-Social-Systems, 2016 13th IEEE Annual Consumer Communications and Networking Conference, CCNC 2016 (2016) 137–144doi:10.1109/CCNC.2016.7444746.
- [134] C. Huang, J. Marshall, D. Wang, M. Dong, Towards Reliable Social Sensing in Cyber-Physical-Social Systems, in: 2016 IEEE International Parallel and Distributed Processing Symposium Workshops (IPDPSW), 2016, pp. 1796–1802. doi:10.1109/IPDPSW.2016.132.
- [135] A. Costanzo, A. Faro, D. Giordano, C. Spampinato, Implementing Cyber Physical social Systems for smart cities: A semantic web perspective, in: 2016 13th IEEE Annual Consumer Communications Networking Conference (CCNC), 2016, pp. 274–275. doi:10.1109/CCNC.2016.7444777.
- [136] F.-Y. Wang, The emergence of intelligent enterprises: From cps to cpss, IEEE Intelligent Systems 25 (4) (2010) 85–88.
- [137] F. Bu, A High-Order Clustering Algorithm Based on Dropout Deep Learning for Heterogeneous Data in Cyber-Physical-Social Systems, IEEE Access 6 (2017) 11687–11693. doi:10.1109/ACCESS.2017.2759509.
- [138] R. Dautov, S. Distefano, D. Bruneo, F. Longo, G. Merlino, A. Puliafito, Data processing in cyber-physical-social systems through edge computing, IEEE Access 6 (2018) 29822–29835.
- [139] M. Huang, W. Liu, T. Wang, Q. Deng, A. Liu, M. Xie, M. Ma, G. Zhang, A Game-Based Economic Model for Price Decision Making in Cyber-Physical-Social Systems, IEEE Access 7 (2019) 111559–111576. doi:10.1109/ACCESS.2019.2934515.
- [140] H. Wang, X. Chen, A fast alternating direction method of multipliers algorithm for big data applications, IEEE Access 8 (2020) 20607–20615. doi:10.1109/ACCESS.2020.2967843.
- [141] L. Jiao, H. Yin, Y. Wu, Dynamic Resource Allocation for Scalable Video Streaming in OFDMA Wireless Networks, IEEE Access 8 (2020) 33489–33499. doi:10.1109/ACCESS.2020.2973929.
- [142] Q. Li, Z. Shi, H. Zhang, Y. Tan, S. Ren, P. Dai, W. Li, A cyber-enabled visual inspection system for rail corrugation, FUTURE GENERATION COMPUTER SYSTEMS-THE INTERNATIONAL JOURNAL OF ESCIENCE 79 (1) (2018) 374–382. doi:{10.1016/j.future.2017.04.032}.
- [143] J. Feng, L. T. Yang, X. Liu, R. Zhang, Privacy-preserving tensor analysis and processing models for wireless internet of things, IEEE WIRELESS COMMUNICATIONS 25 (6) (2018) 98–103. doi:{10.1109/MWC.2017.1800097}.
- [144] Z. M. Candra, H.-L. Truong, S. Dustdar, On monitoring cyber-physical-social systems, in: 2016 IEEE World Congress on Services (SERVICES), IEEE, 2016, pp. 56–63.
- [145] S. Mendhurwar, R. Mishra, Integration of social and iot technologies: architectural framework for digital transformation and cyber security challenges, Enterprise Information Systems (2019) 1–20.

- [146] S. Li, S. Zhao, Y. Yuan, Q. Sun, K. Zhang, Dynamic Security Risk Evaluation via Hybrid Bayesian Risk Graph in Cyber-Physical Social Systems, *IEEE TRANSACTIONS ON COMPUTATIONAL SOCIAL SYSTEMS* 5 (4) (2018) 1133–1141. doi:{10.1109/TCSS.2018.2858440}.
- [147] R. E. N. Sisyanto, N. B. Kurniawan, et al., Hydroponic smart farming using cyber physical social system with telegram messenger, in: 2017 International Conference on Information Technology Systems and Innovation (ICITSI), IEEE, 2017, pp. 239–245.
- [148] J. H. Turner, *A theory of social interaction*, Stanford University Press, 1988.
- [149] E. Goffman, *The Presentation of Self in Everyday Life* Editorial Reviews, no. 9780385094023, University of Edinburgh, Social Sciences Research Centre, Edinburgh, 1958.
- [150] M. Weber, *Economy and society an outline of interpretive sociology.*, Bedminster Press, New York, 1968.
- [151] B. R. Duffy, Anthropomorphism and the social robot, *Robotics and Autonomous Systems* 42 (3) (2003) 177 – 190, socially Interactive Robots. doi:[https://doi.org/10.1016/S0921-8890\(02\)00374-3](https://doi.org/10.1016/S0921-8890(02)00374-3).
- [152] F. Bouffaron, J.-M. Dupont, M. Frédérique, G. Morel, Integrative construct for model-based human-system integration: a case study, *IFAC Proceedings Volumes* 47 (3) (2014) 12317 – 12324, 19th IFAC World Congress. doi:<https://doi.org/10.3182/20140824-6-ZA-1003.02459>.
- [153] M. Romero, W. Guédria, H. Panetto, B. Barafort, Towards a characterisation of smart systems: A systematic literature review, *Computers in Industry* 120 (2020) 103224. doi:<https://doi.org/10.1016/j.compind.2020.103224>. URL <http://www.sciencedirect.com/science/article/pii/S0166361520300270>
- [154] M. Lezoche, H. Panetto, Cyber-physical systems, a new formal paradigm to model redundancy and resiliency, *Enterprise Information Systems* (2018) 1–22.
- [155] M. Doostmohammadian, H. R. Rabiee, U. A. Khan, Cyber-social systems: modeling, inference, and optimal design, *IEEE Systems Journal* 14 (1) (2019) 73–83.
- [156] J. Karlgren, *An algebra for recommendations: Using reader data as a basis for measuring document proximity* (1990).

Declaration of interests

The authors declare that they have no known competing financial interests or personal relationships that could have appeared to influence the work reported in this paper.

The authors declare the following financial interests/personal relationships which may be considered as potential competing interests: