

African Red Slip ware in Sicily during the Roman empire and the Late Antiquity : the region of Agrigento and Termini Imerese.

Fabrizio Ducati*

Claudio Capelli**

* Università degli Studi di Palermo; Aix Marseille Univ, CNRS, CCJ, Aix-en-Provence, France

** DISTAV, Università degli Studi di Genova

Topics

1. The integrated approach for the characterization of the African Red Slip ware workshops
2. African Red Slip ware in Sicily: the contribution of CASR project (2008-2016)
3. New data about African Red Slip ware: the surveys in Agrigento and Termini Imerese hinterland
4. The calcareous flanged bowls from Cignana: imitation or not?

African Red Slip wares : workshops and production areas

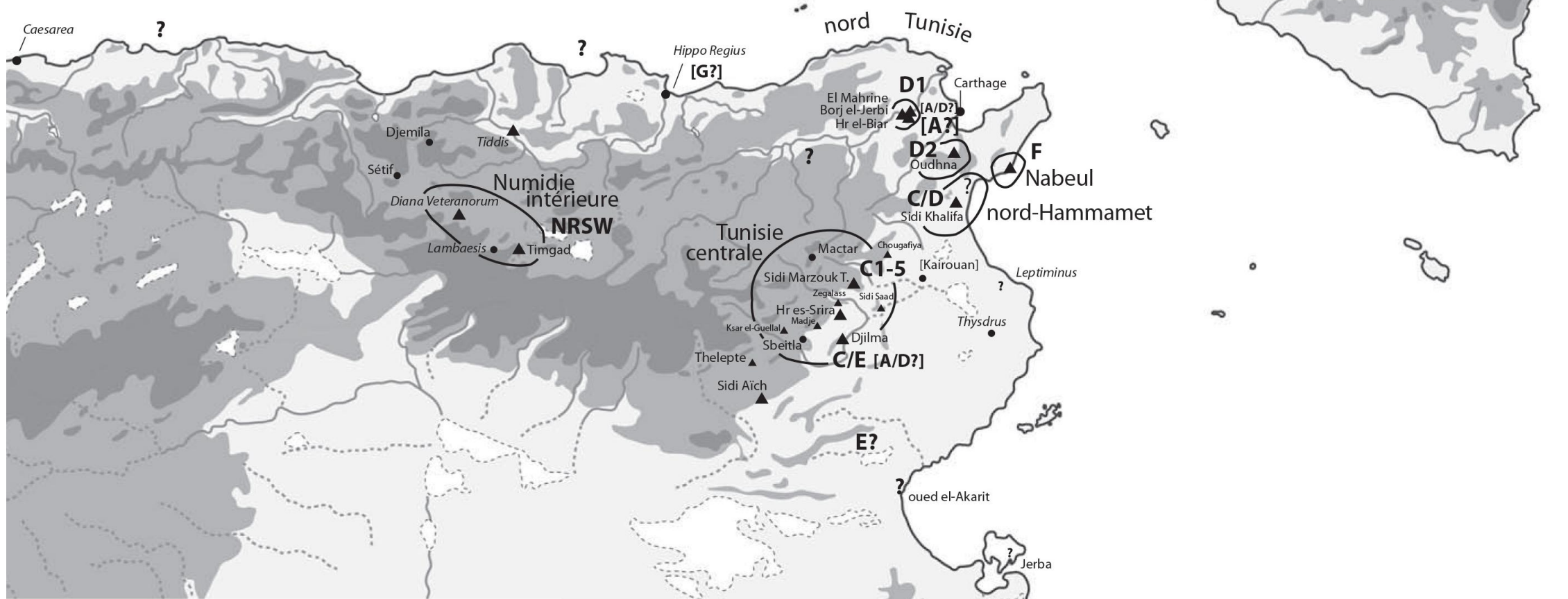

▲ : ateliers de sigillée repérés sur le terrain

D1 : zone de production (assurée)

[A/D?] : zone de production (hypothétique)

NRSW : sigillée numidienne ; TRSW : sigillée tripolitaine



From BONIFAY 2016, p. 521, fig. 127

The integrated approach: archaeology and archaeometry

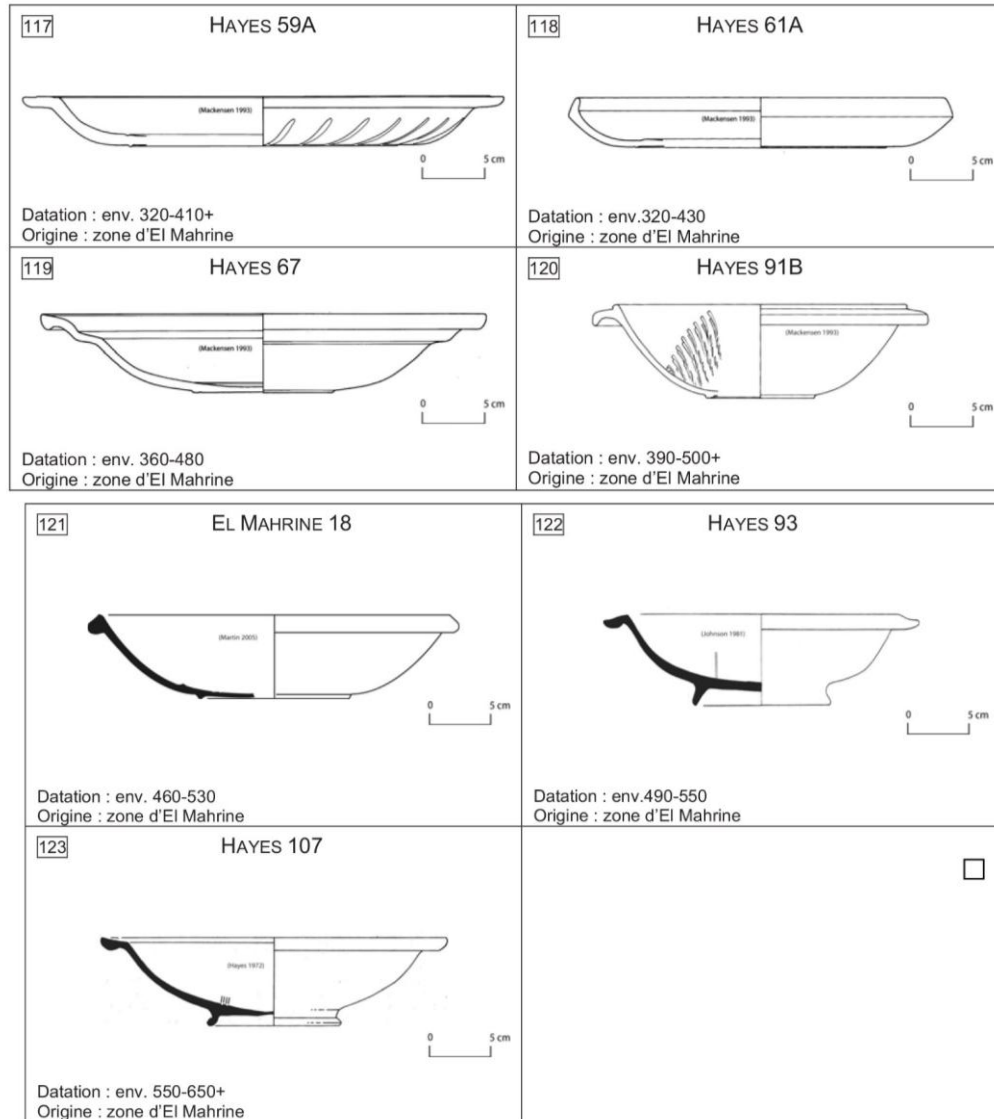

From BONIFAY 2004, Pl II, n. 11.



D1
Atelier d'El Mahrine
Hayes 67

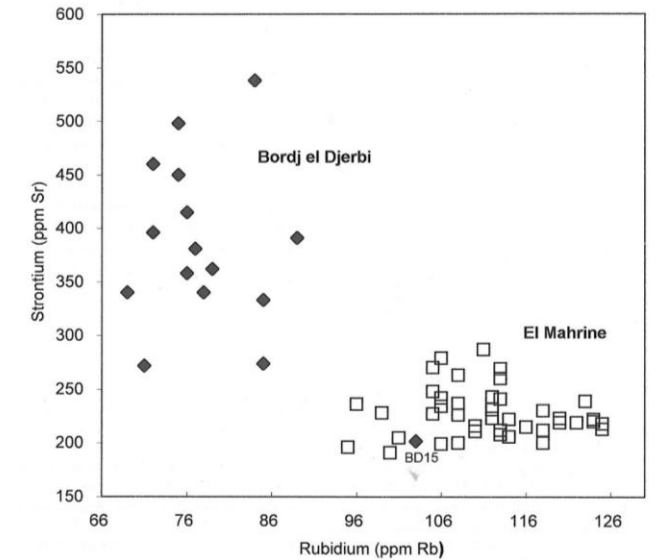
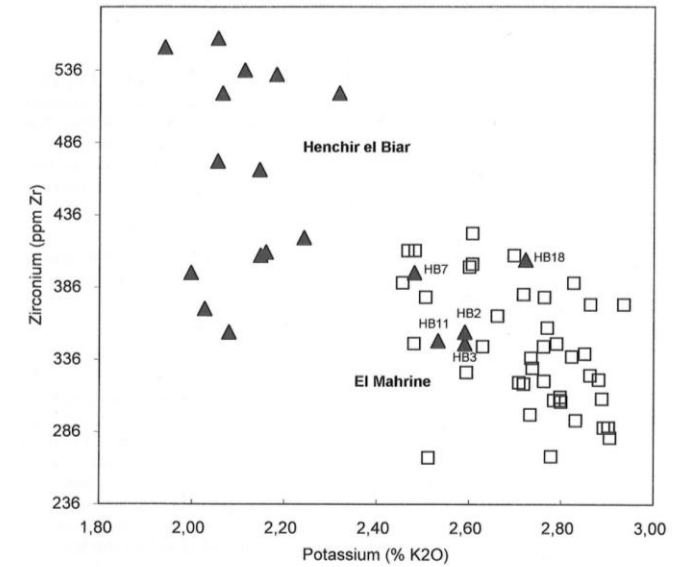
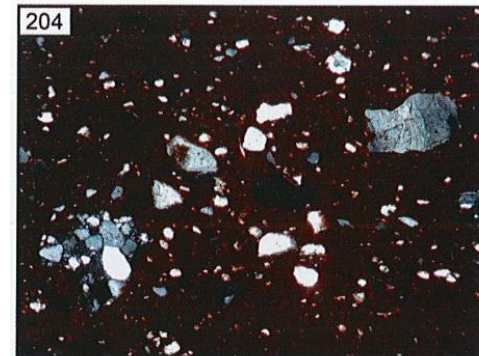
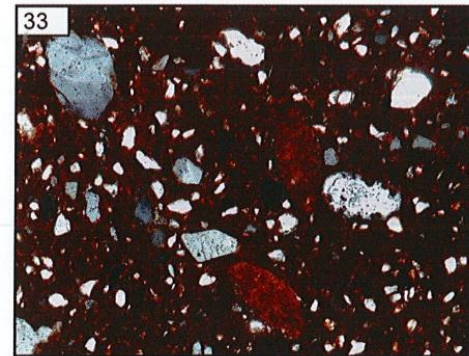

From BONIFAY 2016, pp. 557-558; CAPELLI *et alii* 2016, p. 384, fig. 81.

From MACKENSEN, SCHNEIDER 2002, fig. 14-15.

Working on consumption sites outside Africa

Hayes 2/3A, Hayes 6, Hayes 7,
Hayes 15, Hayes 27

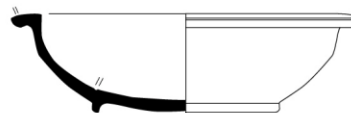
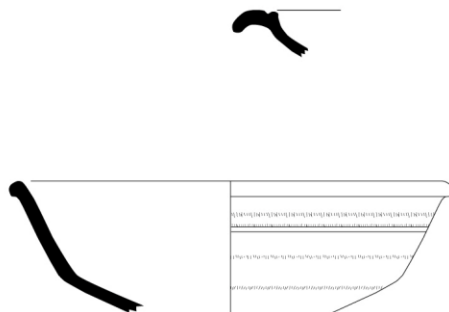

0 5 cm

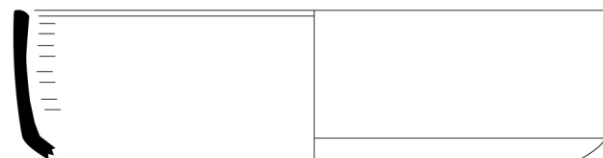

ARS A1



ARS D1



ARS C/D



ARS F

The CASR project (2008-2016) : La Ceramica Africana nella Sicilia Romana

La ceramica africana
nella Sicilia romana

La ceramique africaine
dans la Sicile romaine

a cura di / sous la direction de
Daniele Malfitana e / et Michel Bonifay

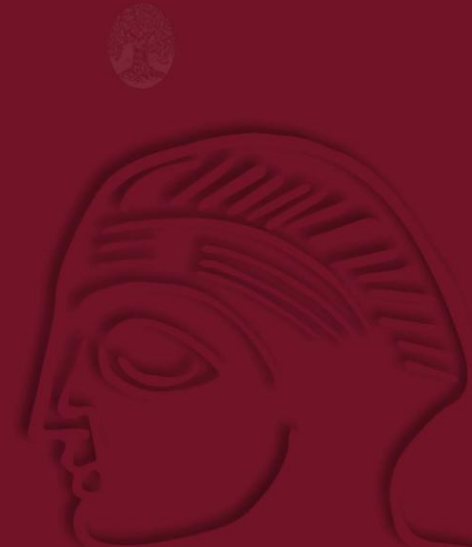

Tomo / Tome I

Testo e Tavole
Texte et Planches

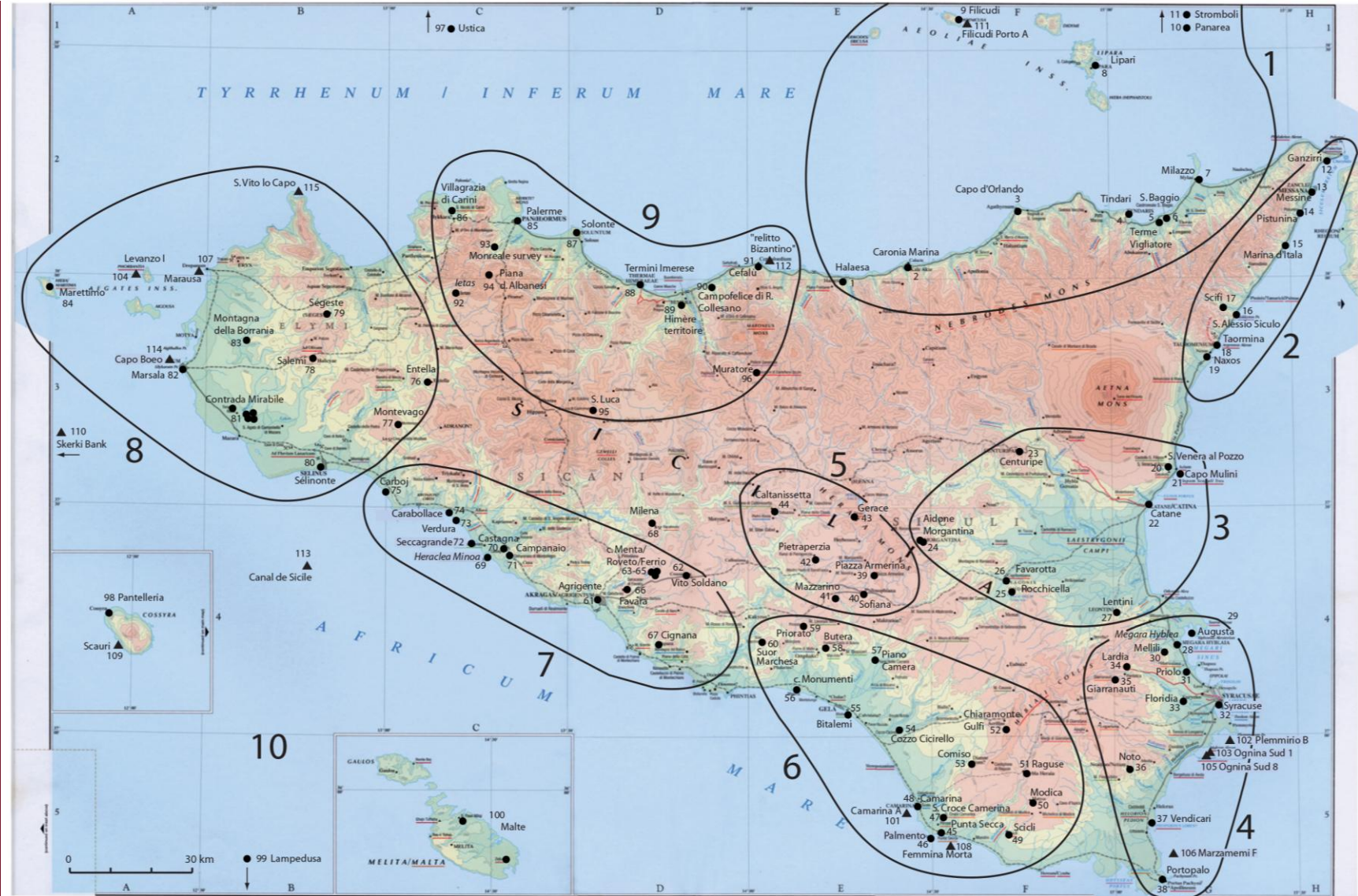

From BONIFAY *et alii* 2016, p. 354, fig. 85 : Sicilian sites analyzed during the CASR project

The CASR project (2008-2016) : La Ceramica Africana nella Sicilia Romana

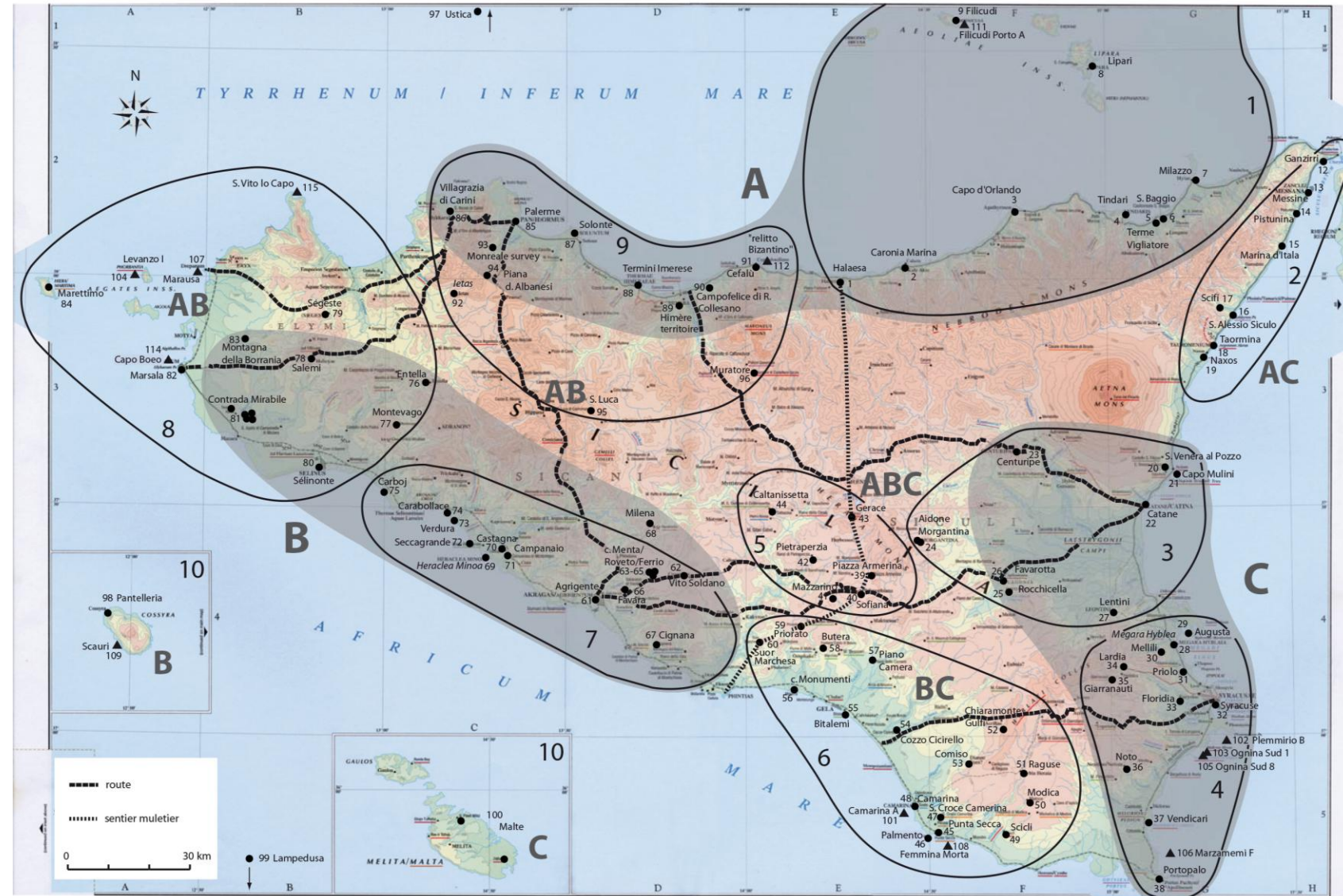
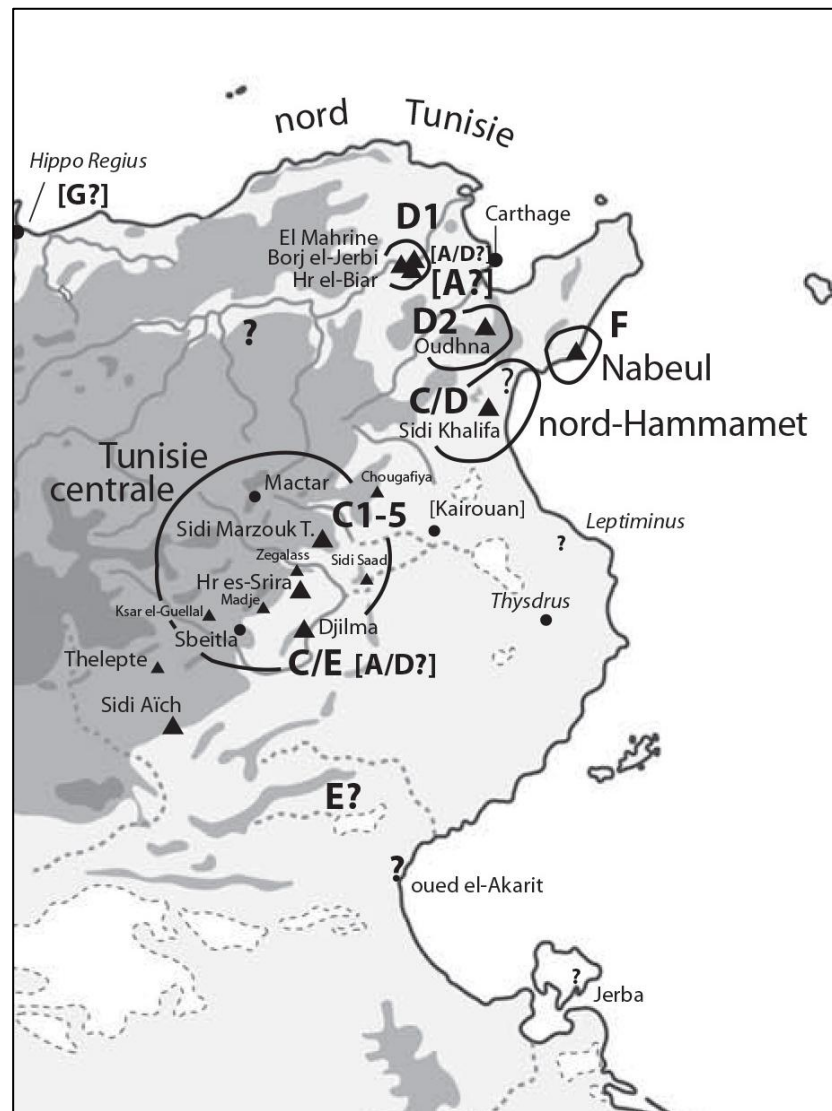

Main workshops and production areas in Tunisia

From BONIFAY, MALFITANA 2016, p. 408, fig. 90. Main import facies

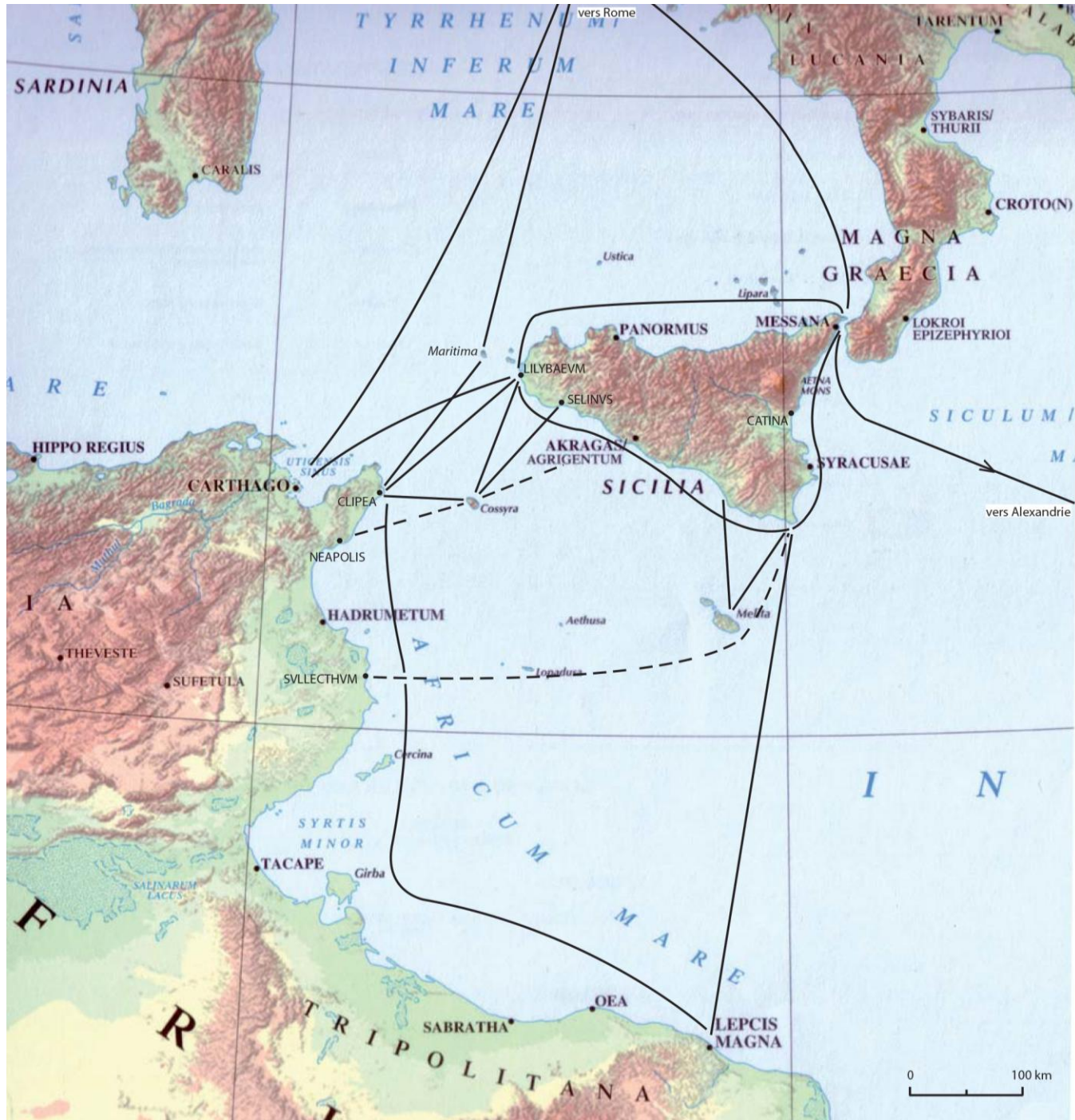

From BONIFAY, MALFITANA 2016, p. 412, fig. 91.
 Routes that supplied Sicily with African
 potteries

African Red Slip ware from the region of Agrigento and Termini Imerese

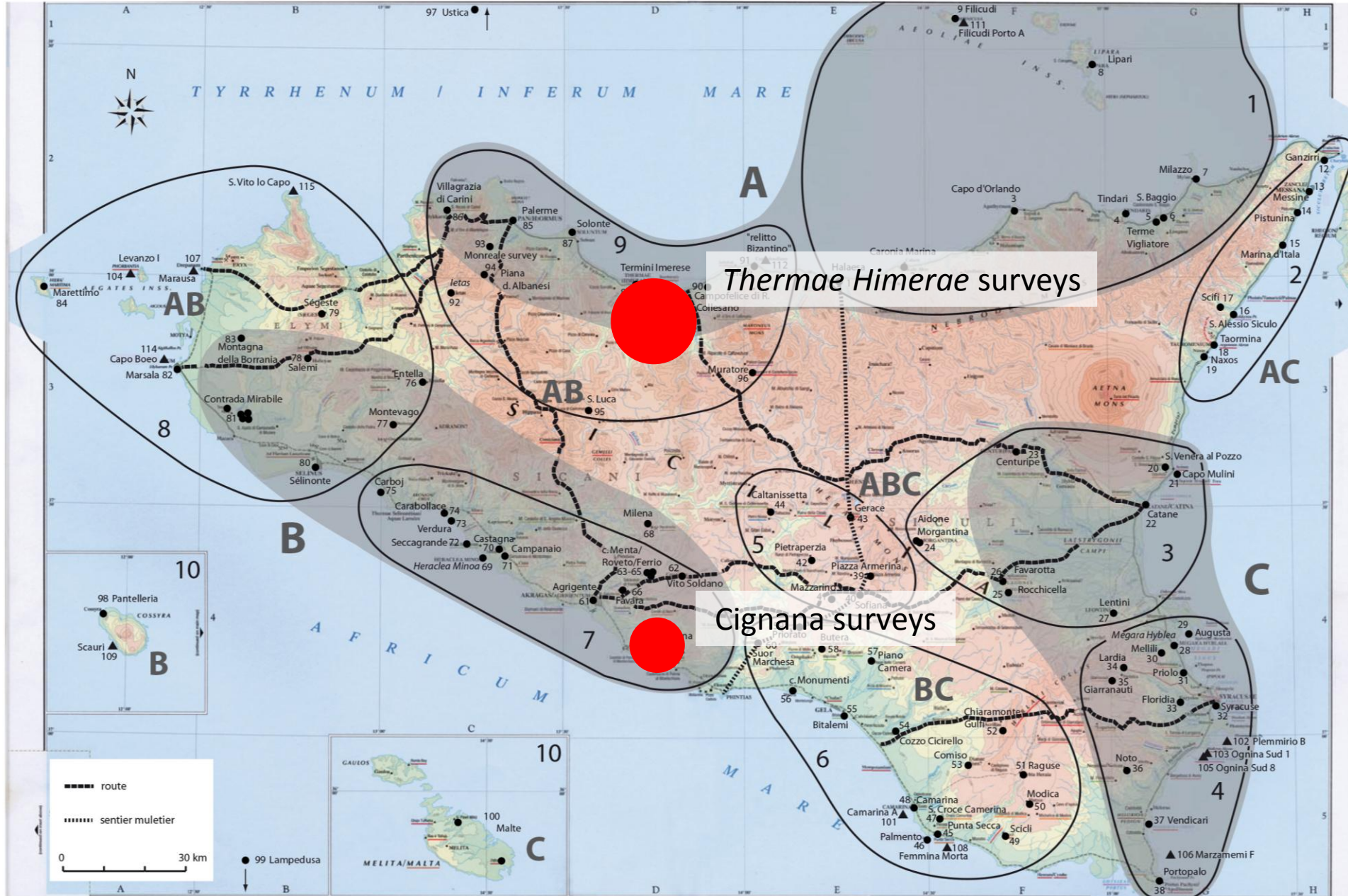

The surveys on *Thermae Himerae* hinterland



Hayes 59

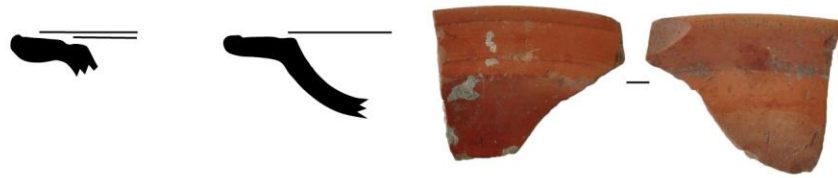

Hayes 61A



Hayes 67



Hayes 73 and 76



0 5 cm

ARS D1 from the region of El Mahrine

Hayes 91B



ARS D from the region of Carthage

Hayes 82 and 64



Hayes 80



The surveys around the Roman Villa of Cignana : 20 Km South-East from Agrigento



Hayes 61B

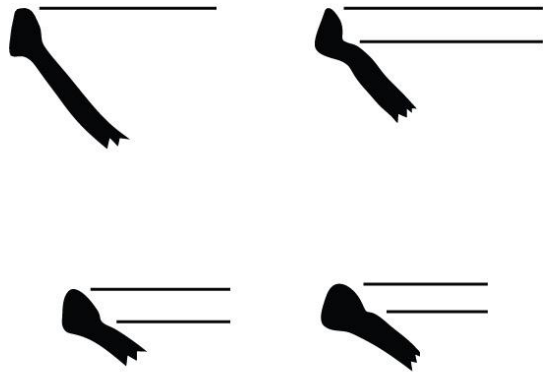

Hayes 92 *similis*

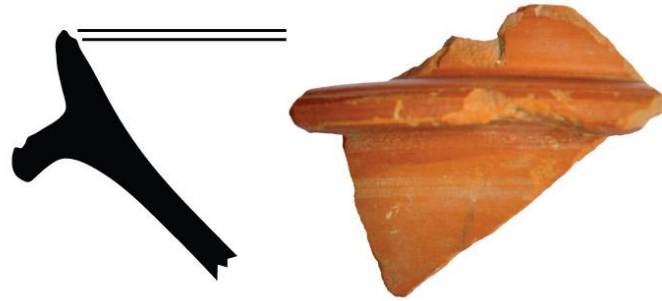

ARS C/D
from Sidi Khalifa



Hayes 88



0 5 cm

Style A(iii)

The surveys around the Roman Villa of Cignana : 20 Km South-East from Agrigento



ARS F: Hayes 50B, n° 61 from Nabeul

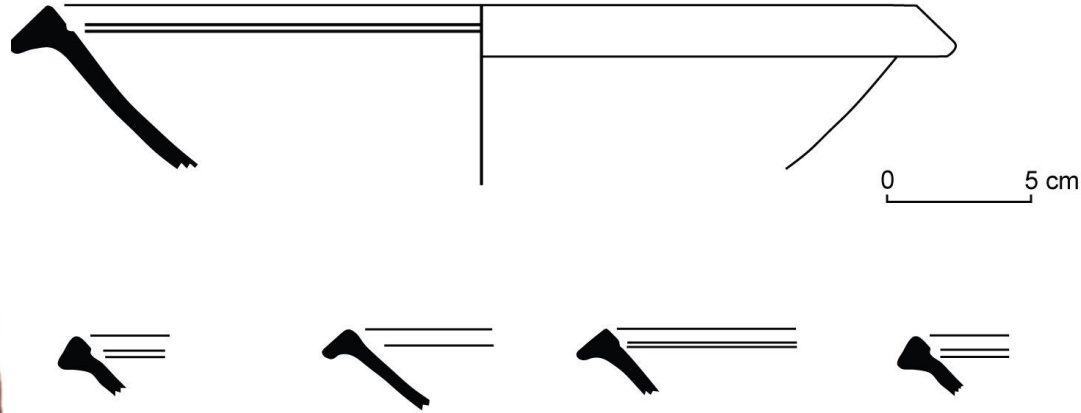

ARS D: Hayes 61 C from
the North of the Gulf of
Hammamet

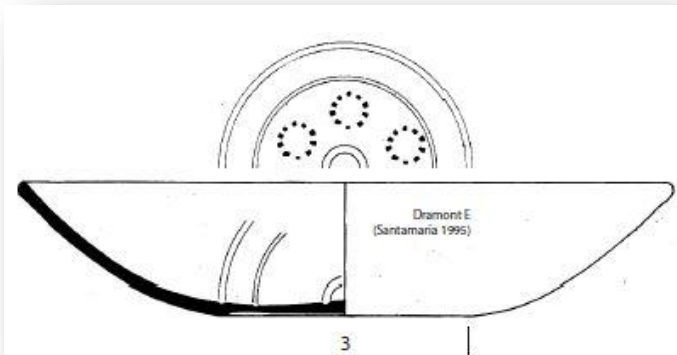

From BONIFAY 2004, fig. 105

ARS D2: Hayes 103 or 104 (?)
decorated in style E (ii), from Atelier X



Flanged bowls from Cignana surveys

Small flanged bowls with calcareous matrix and iron-rich slip, on the inner and outer side.

Sites that delivered flanged bowls

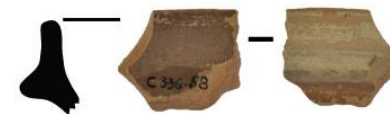
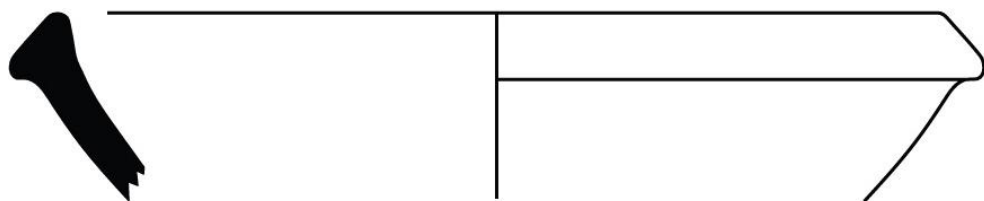
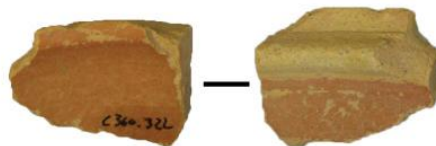
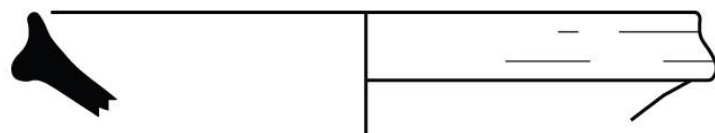
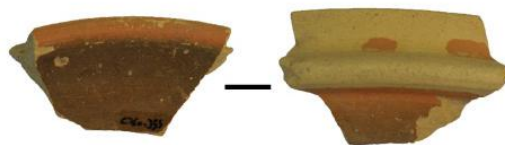
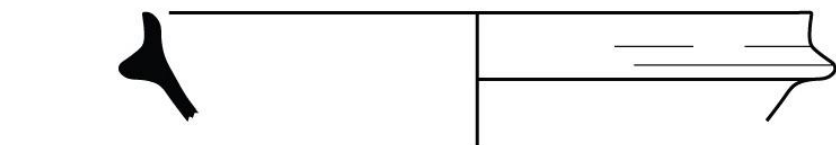
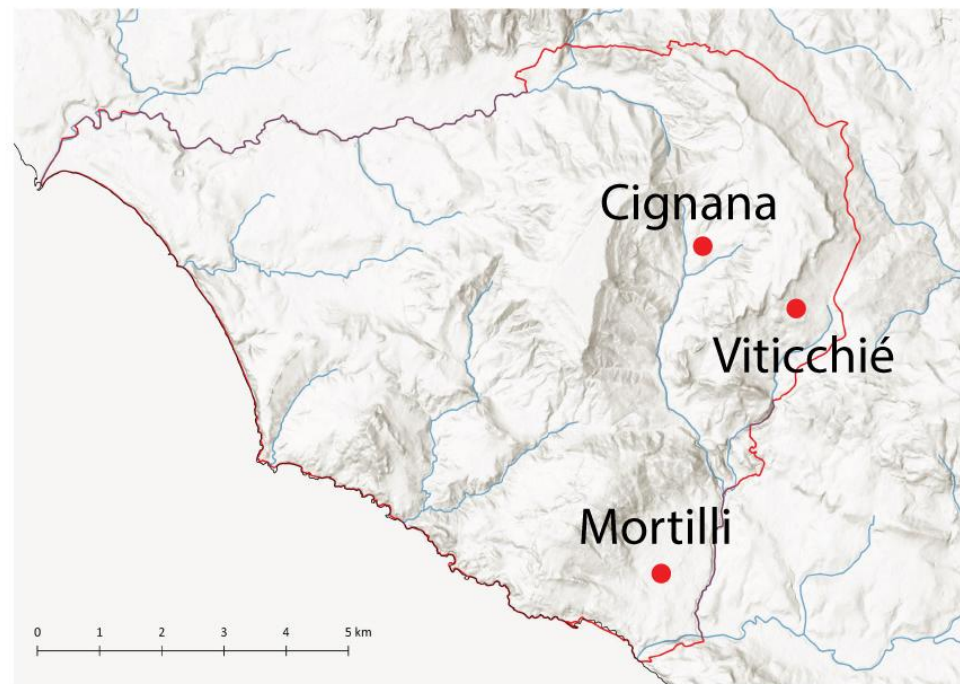

Flanged bowls from Cignana excavation (2006): SAS IV

The area of the Late Antique village

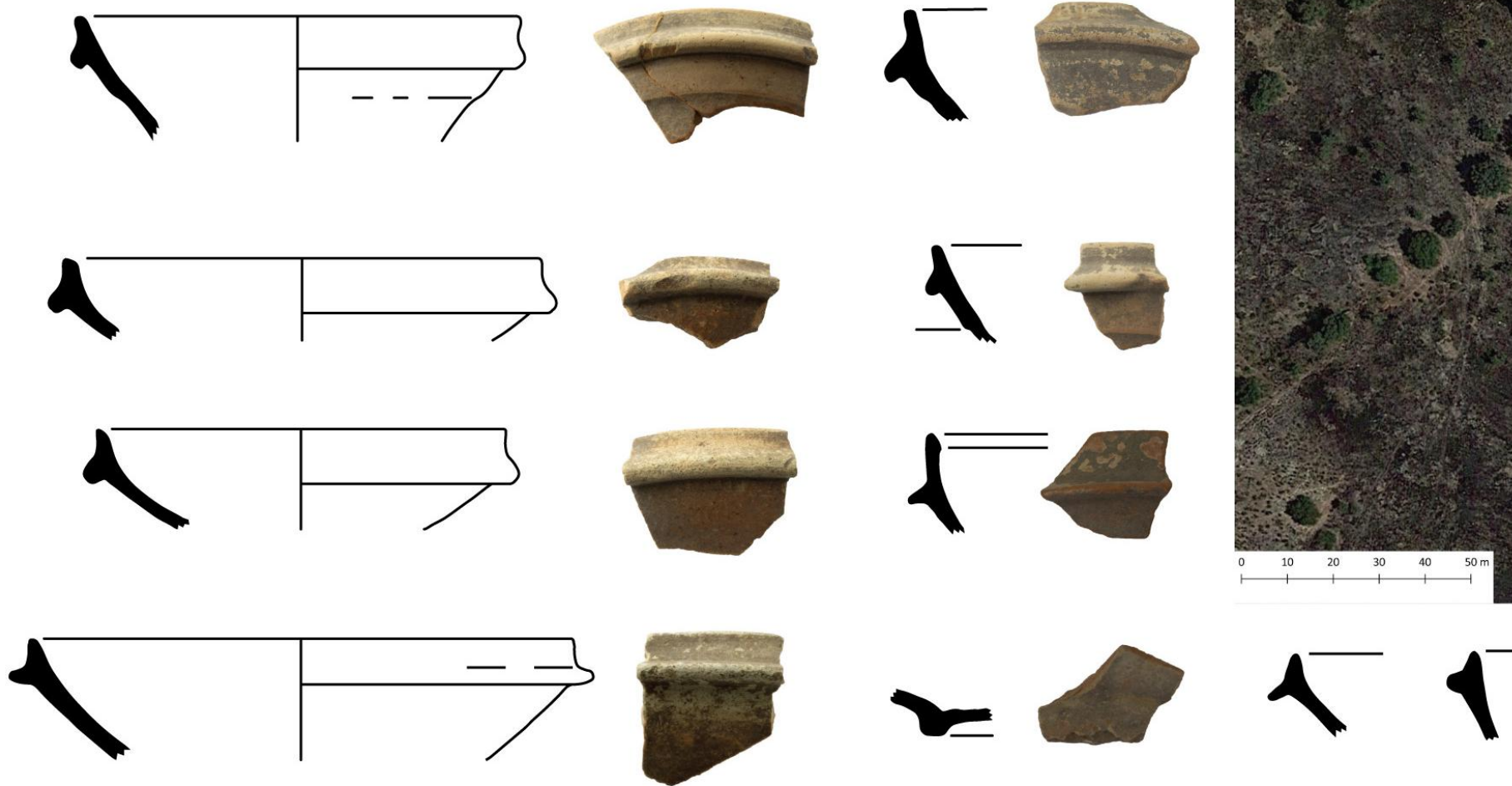

0 5 cm

Thanks to Maria Serena Rizzo (Parco Archeologico della Valle dei Templi), supervisor Cignana excavation.

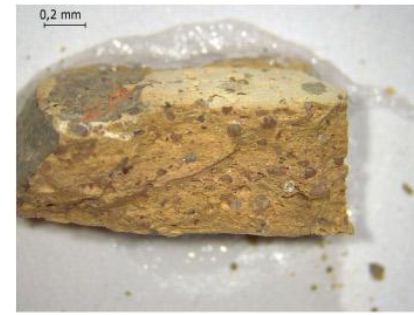

Dérivée de sigillée brune à pâte blanche

From BONIFAY 2004, Pl. II, n. 20

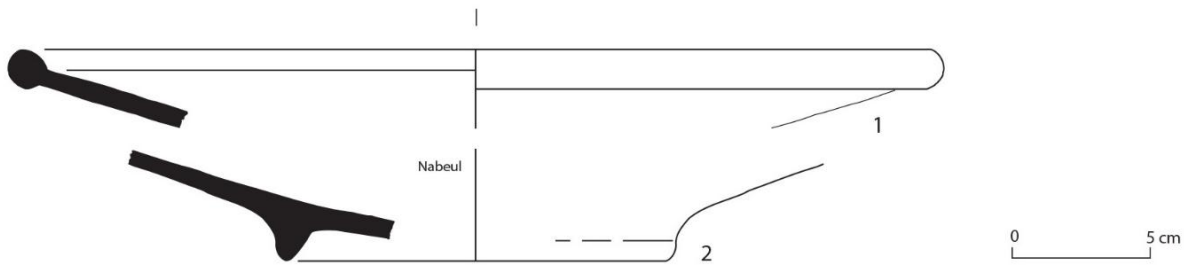

Hayes 105 from Nabeul.
End VII – beginning VIII century (?).
From BONIFAY 2004, fig. 111

Ceramica romana a vernice rossa

From the *Domus of Gaudenzio* in Rome

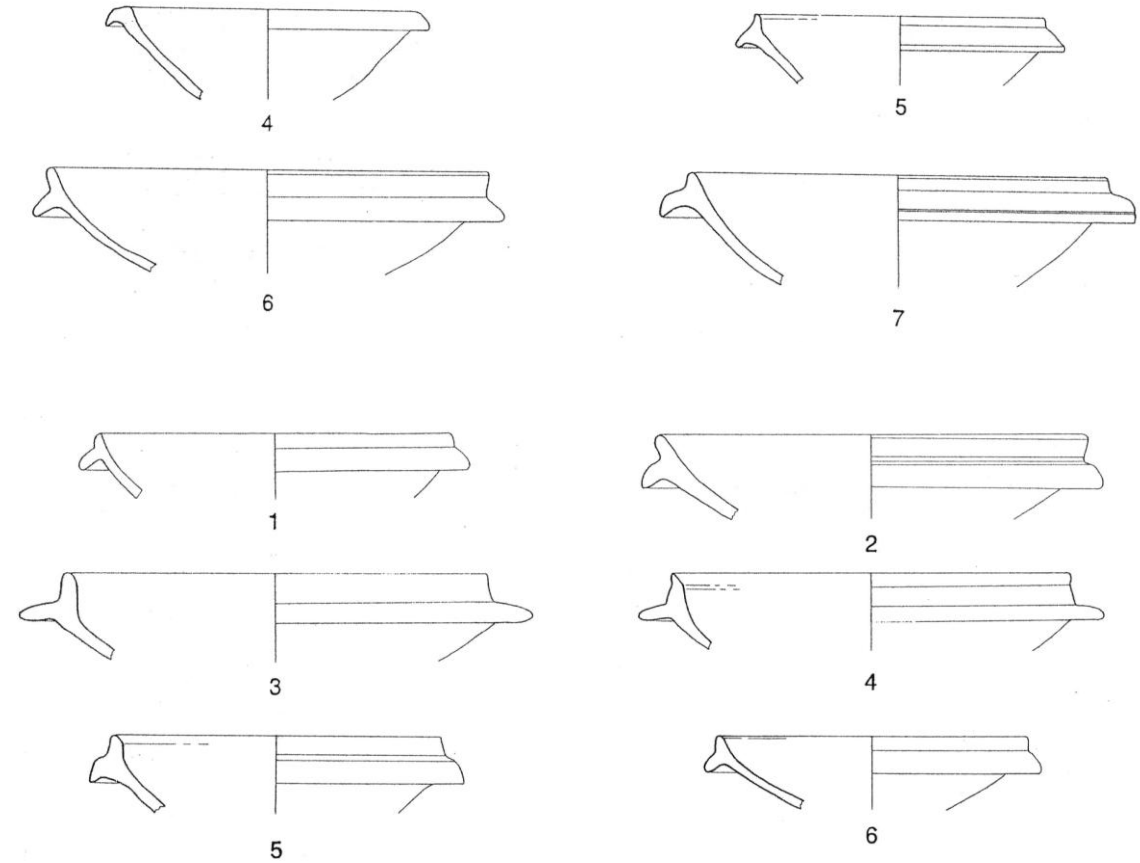

From FONTANA 1988, fig. 5-6

Flanged bowls from Cignana surveys

336.68

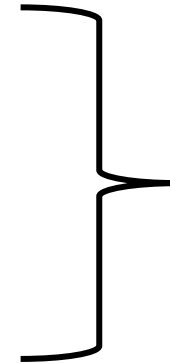
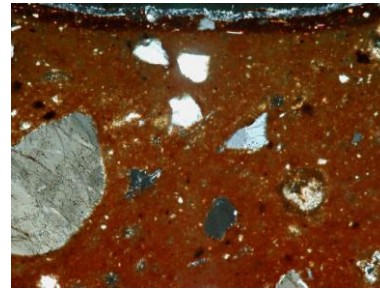
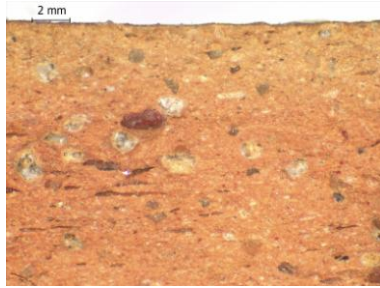

**Unknown origin, Tunisia excluded
(Algeria??)**

360.355

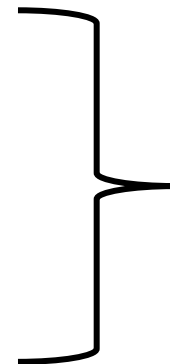
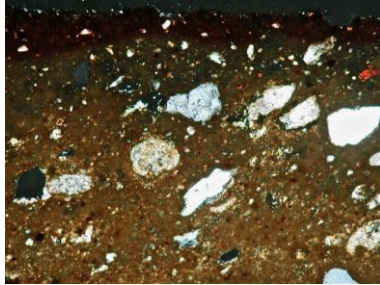
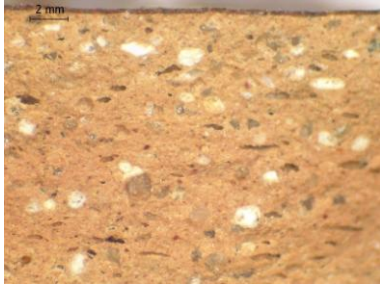

**Possible origins: North-West Tunisia,
Algeria, South Spain, Sicily (?)**

360.322

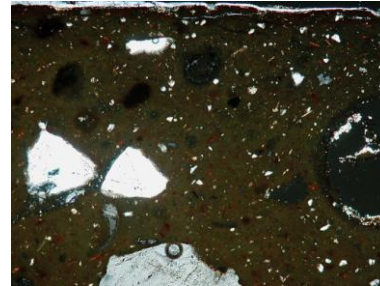
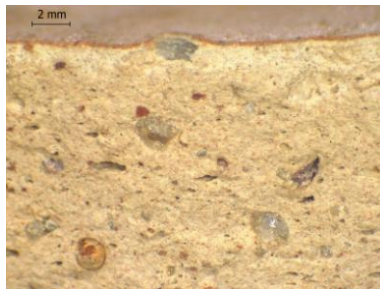

360.478

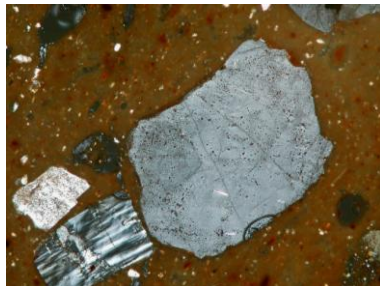



The same sherd was firstly published by RIZZO, ZAMBITO 2012

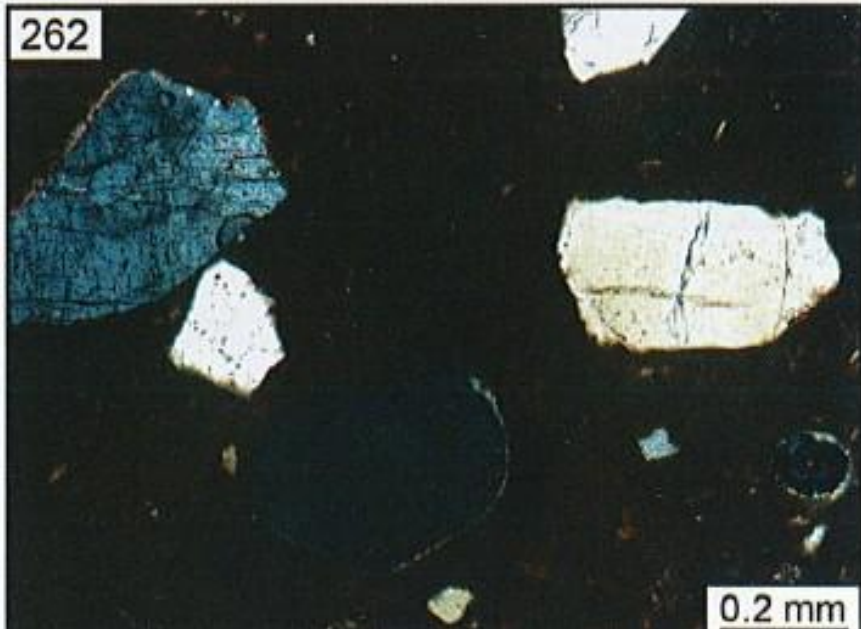

CASR n° 262 [SIC 515] : Flanged bowl from Cignana (Site 67). Origin not from Africa. Maybe central-south Sicily

From CAPELLI *et alii* 2016, p. 350, fig. 83

Imitations of African Red Slip ware

Imitations of ARS A and C

Imitations of ARS D

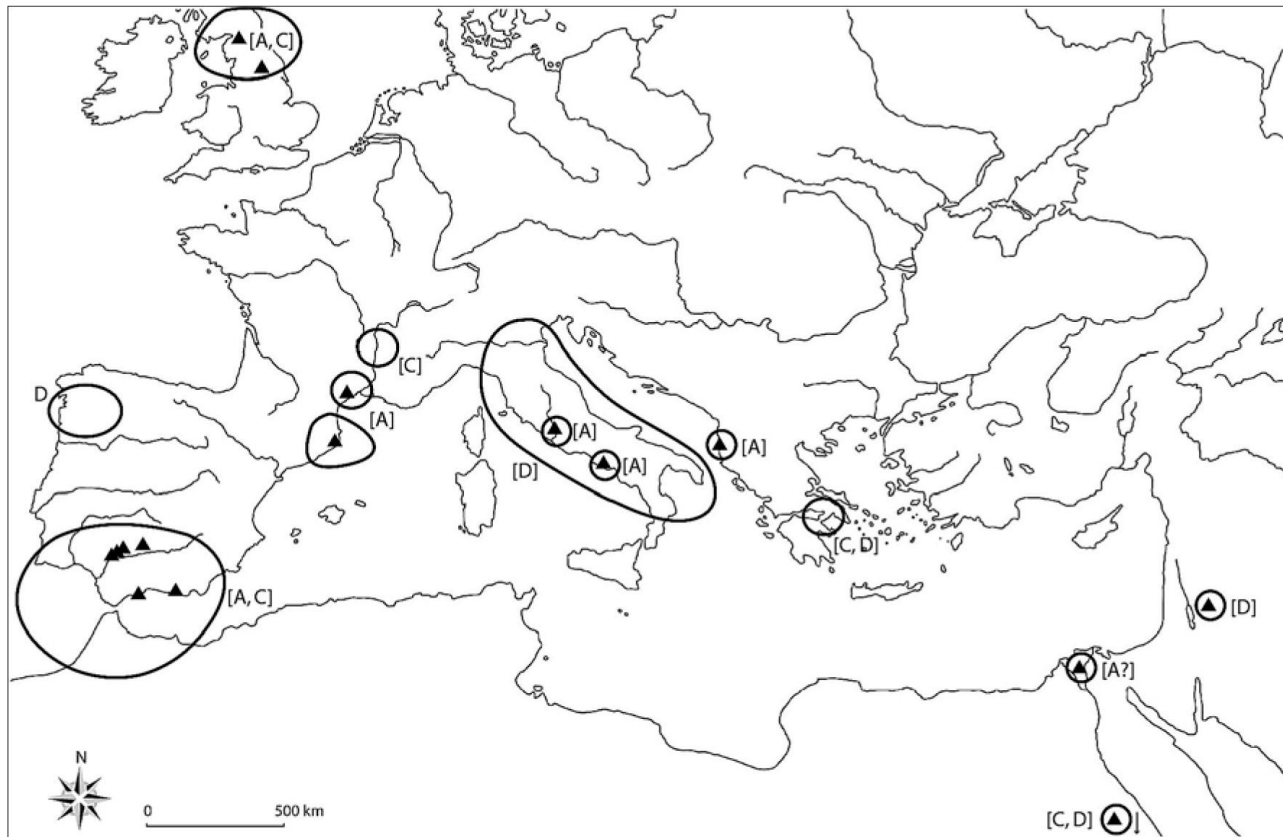

From BONIFAY 2014, fig. 5. Main zones imitating ARS

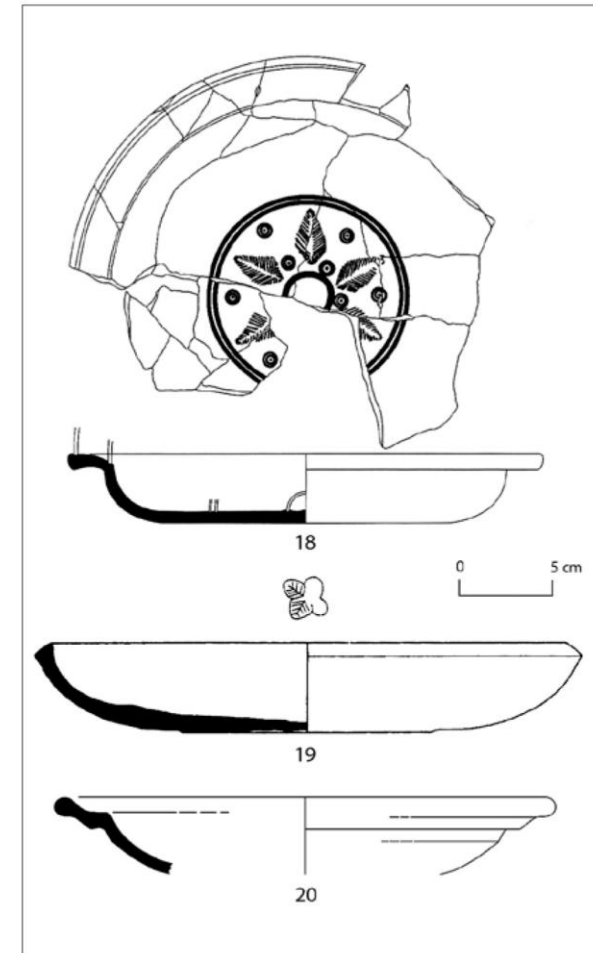
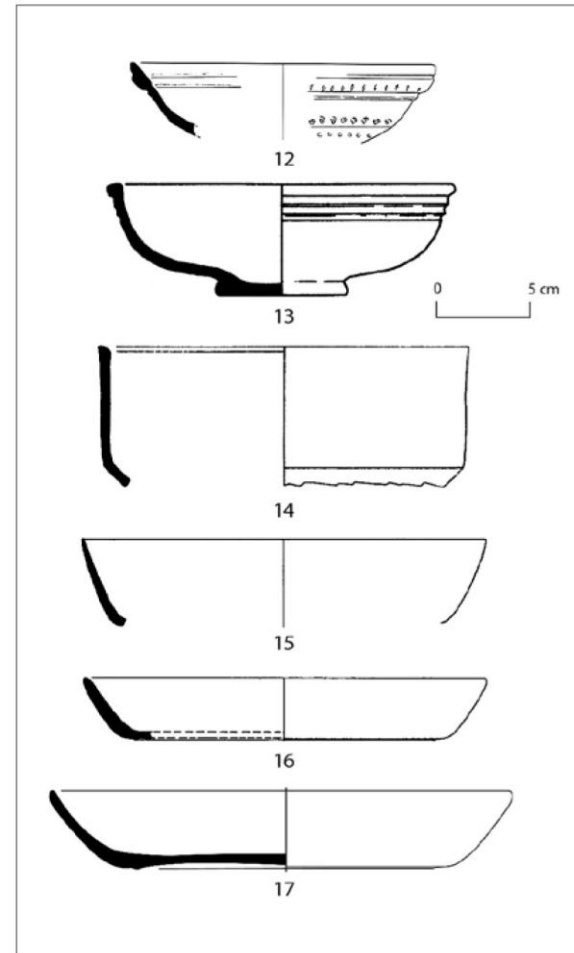

From BONIFAY 2014, figg. 6-7.

Flanged bowls produced in Africa between the 6th and the end of the 7th century

Fine wares

Types derived from Hayes 91 (?)

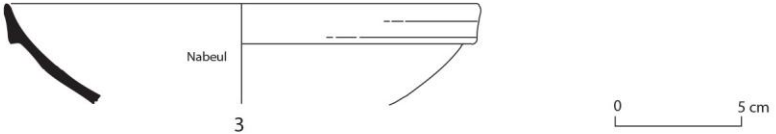

Common wares

Type Carthage Class 2

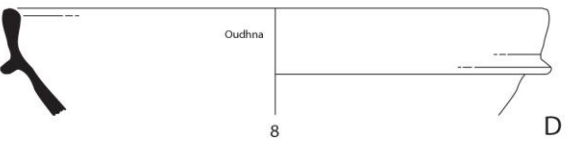
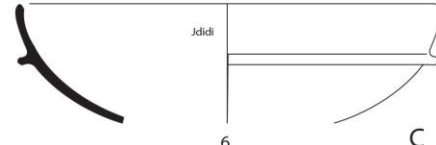
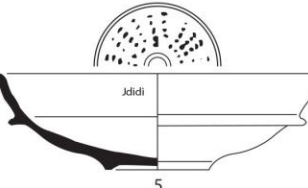
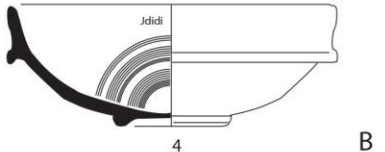
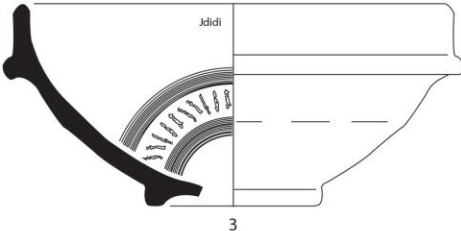
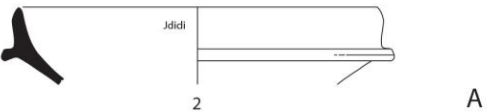

From BONIFAY 2004, fig. 111 and 138

Flanged bowls produced in Africa between the 6th and the end of the 7th century

Common wares

Late byzantine types with stamped decoration

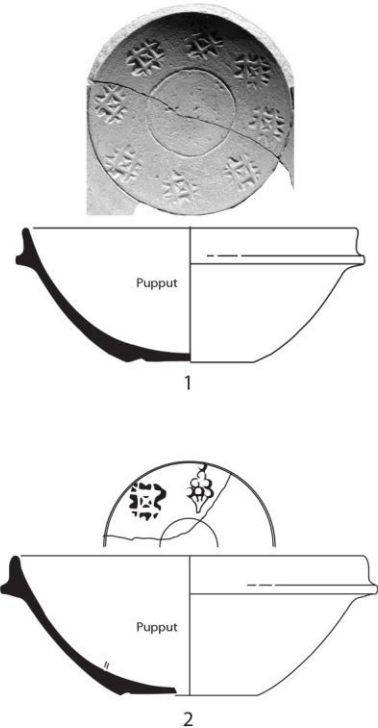

Late byzantine types with painted decoration

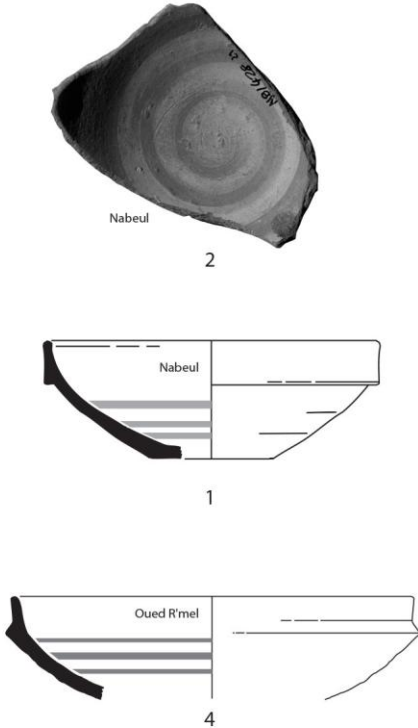

Other late byzantine types

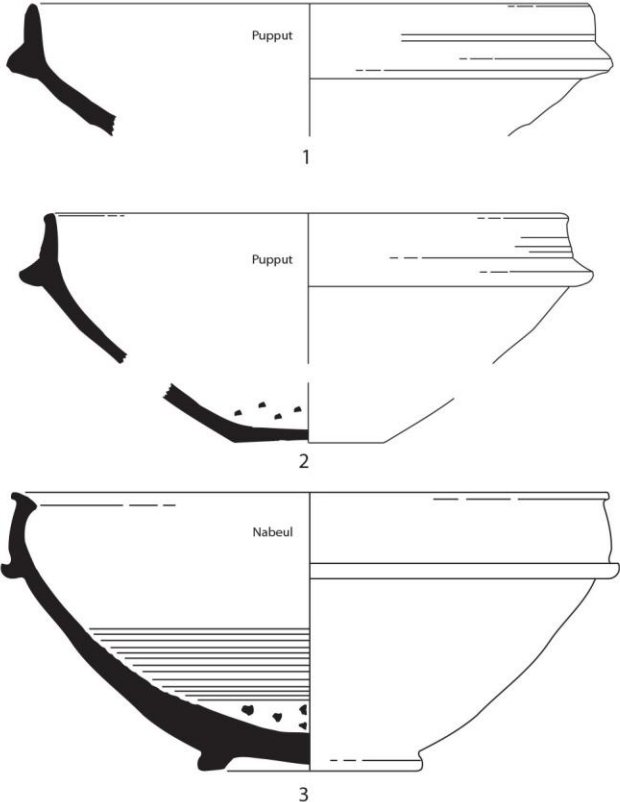

From BONIFAY 2004, fig. 141

Thank you!

Fabrizio Ducati : fabrizio.ducati90@gmail.com

Claudio Capelli : capelli@dipteris.unige.it

Session 162 Culture contacts in the western Mediterranean sea during the Roman Age. Pottery as cultural marker between traffics and local productions

BONIFAY 2004

M. Bonifay, *Etudes sur la céramique romaine tardive d'Afrique*, BAR IS-1301, Oxford 2004.

BONIFAY 2014

M. Bonifay, *Céramique africaine et imitations : où, quand, pourquoi?*, in R. Morais, A. Fernández, M. J. Sousa (ed.), *As produções cerâmicas de imitação na Hispania*, monografias ex officina hispana II, Tomo I, Madrid 2014, 75-91.

BONIFAY 2016

M. Bonifay, *Annexe 1. Éléments de typologie des céramiques de l'Afrique romaine*, in MALFITANA, BONIFAY 2016, pp. 507-573.

BONIFAY, MALFITANA 2016

M. Bonifay, D. Malfitana, *L'apport de la documentation sicilienne à l'étude du commerce de l'Afrique romaine*, in MALFITANA, BONIFAY 2016, pp. 403-439,

BONIFAY *et alii* 2016

M. Bonifay, C. Franco, G. Cacciaguerra, *Analyse micro-régionale de la diffusion des céramiques africaines en Sicile*, in MALFITANA, BONIFAY 2016, pp. 353-401.

CAPELLI *et alii* 2016

C. Capelli, M. Bonifay, C. Franco, C. Huguet, V. Leitch, T. Mukai, *Étude archéologique et archéométrique intégrée*, in MALFITANA, BONIFAY 2016, pp. 273-351,

FONTANA 1988

S. Fontana, *Le "imitazioni" della sigillata africana e le ceramiche da mensa italiche tardo-antiche*, in L. Saguì (a cura di), *Ceramica in Italia : VI-VII secolo*. Atti del Convegno in onore di John W. Hayes (Roma, 11-13 maggio 1995), vol. I-II, Firenze 1998, pp. 83-100.

Session 162 Culture contacts in the western Mediterranean sea during the Roman Age. Pottery as cultural marker between traffics and local productions

MACKENSEN, SCHNEIDER 2002

M. Mackensen, G. Schneider, *Production centres of African red slip ware (3rd-7th c.) in northern and central Tunisia: archaeological provenance and reference groups based on chemical analysis*, in JRA 15, 2002, pp. 121-15.

MALFITANA, BONIFAY 2016

D. Malfitana, M. Bonifay (a cura di), *La ceramica africana nella Sicilia romana / La céramique africaine dans la Sicile romaine*, I-II, Catania 2016.

RIZZO, ZAMBITO 2012

M.S. Rizzo, L. Zambito, *La cultura materiale di un villaggio di età bizantina nella Sicilia centromeridionale: apporti dall'Oriente e dall'Africa a Cignana (Naro, Agrigento)*, in AfrRom XIX, Sassari 2010, Roma 2012, pp. 3051-3064.