



**HAL**  
open science

# Potential of Ammonia as future Zero-Carbon fuel for future mobility: Working operating limits for Spark-Ignition engines

Christine Mounaïm-Rousselle, Pierre Brequigny, S Houillé, C Dumand

## ► To cite this version:

Christine Mounaïm-Rousselle, Pierre Brequigny, S Houillé, C Dumand. Potential of Ammonia as future Zero-Carbon fuel for future mobility: Working operating limits for Spark-Ignition engines. SIA POWERTRAIN & ENERGY 2020, Nov 2020, Online, France. hal-03188481

**HAL Id: hal-03188481**

**<https://hal.science/hal-03188481v1>**

Submitted on 2 Apr 2021

**HAL** is a multi-disciplinary open access archive for the deposit and dissemination of scientific research documents, whether they are published or not. The documents may come from teaching and research institutions in France or abroad, or from public or private research centers.

L'archive ouverte pluridisciplinaire **HAL**, est destinée au dépôt et à la diffusion de documents scientifiques de niveau recherche, publiés ou non, émanant des établissements d'enseignement et de recherche français ou étrangers, des laboratoires publics ou privés.

# Potential of Ammonia as future Zero-Carbon fuel for future mobility: Working operating limits for Spark-Ignition engines

C. Mounaïm-Rousselle<sup>1</sup>, P. Brequigny<sup>1</sup>, S. Houillé<sup>2</sup>, C. Dumand<sup>2</sup>

1: Univ. Orléans, INSA-CVL, EA 4229 – PRISME, F-45072 Orléans, France

2: Groupe PSA, Centre Technique de Vélizy, Vélizy-Villacoublay, France

**Abstract:** The objective of this paper is to provide new data about the possibility to consider ammonia as a zero carbon fuel for spark-ignition engine. For that a current GDI PSA engine was chosen in order to update the results available in the literature mainly obtained with CFR engine. Particular attention was paid to the possible low limit load by using pure ammonia, or with a small amount of hydrogen, depending on engine speed, in order to highlight the limitation during cold start conditions. It can be concluded that these conditions require H<sub>2</sub> addition, but 10% (of the total fuel volume) is sufficient. Measurements of exhaust pollutants and in particular, NO<sub>x</sub> led to an assessment of the effect of dilution and the limitation with pure ammonia fuel in turbocharged like conditions: for these conditions, no more than 10% of EGR allows stable working operation but can reduce NO<sub>x</sub> by up to 40%.

**Keywords:** Spark-ignition engine, Ammonia, H<sub>2</sub> addition,

## 1. Introduction

The 2010 Paris Agreement [1] aiming at mitigating greenhouse gases requires a global transition from fossil to renewable resources use in the next decades. Nowadays the main energy sources, such as fossil fuels, should be replaced by renewable energy sources, together with an increased electrification of many usages. Alternative fuels are therefore widely considered as important energy carriers, because they are particularly adapted for specific hard-to-electrify end-uses, such as high temperature heat, long-distance mobility, or even for mid- and long-term energy storage. According to the International Energy Agency (IEA)<sup>1</sup>, 'green' hydrogen will play a key role in the world's transition to a sustainable energy future as it is one of the most promising and clean energy carriers, both

---

<sup>1</sup> <https://www.iea.org/reports/the-future-of-hydrogen>

for transportation and power generation [2,3]. However, even using the best available technologies, its density is too low for it to be easily transported and stored with acceptable safety and at a reasonable cost.

Among other renewable fuels, Ammonia (NH<sub>3</sub>) is currently receiving an increased interest as a potential renewable carbon-free energy carrier [2]. It is both considered as a fuel for direct use in combustion system or fuel cell, or as an efficient hydrogen carrier (17.8% hydrogen content by mass) when it is decomposed. Although ammonia use as an internal combustion engine fuel has been considered since many decades, its deployment was first limited by the competition with hydrocarbon fuels in terms of availability, handling ease and safety and also energy density and combustion properties. Indeed, it is a toxic chemical with a difficult flammability and very low combustion intensity, illustrated by its narrow flammability limits (FL) and low Laminar Burning Velocity (LBV) in Table 1, respectively. Nonetheless, today's context on global warming is making fossil fuels undesired due to their unacceptable environmental impact, and ammonia exhibits many advantages. First, due to the huge development of renewables energies and the water electrolysis as one storage solution, 'green' ammonia could be produced economically without any carbon emissions and as its combustion releases mainly water and nitrogen. Moreover, as displayed in Table 1, ammonia can be stored as liquid under mild pressure conditions at ambient temperature, thus ensuring a comparable energy density with other fuels, especially regarding its competitive Lower Heating Value (LHV). A life cycle analysis, provided by Bicer and Dincer [4] showed that greenhouse gas emissions could be reduced by almost a factor three by using ammonia-fuelled vehicles instead of gasoline vehicles.

Table 1. Ammonia properties and comparison with other fuels at 300 K and 0.1 MPa, unless stated otherwise.

Data from [2,5,6].

Species	Ammonia	Methanol	Hydrogen	Methane	Gasoline
Formula	NH <sub>3</sub>	CH <sub>3</sub> OH	H <sub>2</sub>	CH <sub>4</sub>	-
Storage	Liquid	Liquid	Compressed	Compressed	Liquid
Storage temperature (K)	300	300	300	300	300
Storage pressure (MPa)	1.1	0.1	70	25	0.1

density @ storage conditions (kg.m <sup>-3</sup> )	600	784.6	39.1	187	~740
FL in air (vol.%)	15-28	6.7-36	4.7-75	5-15	0.6-8
LBV @ stoichiometry (m.s <sup>-1</sup> )	0.07	0.36	3.51	0.38	0.58
Auto-ignition T (K)	930	712	773-850	859	503
Research Octane Number	130	119	>100	120	90-98
LHV (MJ/kg)	18.8	19.9	120	50	44.5

Even though now there is no transport fleet running with ammonia as fuel, using it as an alternative to fossil fuels for transportation vehicles was already considered decades ago. The first famous example is the bus fleet operated in Belgium during World War II caused by the limited availability of Diesel fuel [7]. It is also the birth of the first dual-fuel engine: coal gas (composed of 50% H<sub>2</sub>) was directly injected into the combustion chamber filled with ammonia. In the mid-60s, several studies [8–14] focused on the possibility of using ammonia as fuel in thermal engines, providing first recommendations regarding the chemical compatibility of ammonia because of its corrosiveness to copper, copper alloys, nickel and even some plastics.

The two classical engine architectures were considered in these studies, namely Spark-Ignition (SI) and Compression Ignition (CI). Although, most projects currently concern CI engines [15], the low auto-ignition ability and high octane rating (Table 1) of ammonia suggests a more suitable use in SI engines. The energy content of ammonia introduced for a stoichiometric mixture with air is higher than that of gasoline, but fuel consumption is double in the case of neat ammonia. However, its low flame speed and narrow flammability limits can lead to incomplete combustion in SI engines. To counterbalance, ignition could be promoted by a more reactive fuel, as H<sub>2</sub> or gasoline type fuel and the in-cylinder temperature can be increased by a higher compression ratio (CR) or supercharged conditions without any risk of knocking.

A recent review [16] reported only 16 studies investigating the use of ammonia fuel in spark-ignition engine. About half of them were conducted in CFR engine with CR ranging from 6.1 to 10 which is representative of current vehicles [6,10,17–21]. The other half were conducted with modern single cylinder engine [22–25] or multi-cylinder engine [26,27]. Among those studies, only two investigated higher CR, i.e. about 14:1 [6,22]. Among these studies, it is striking to realise that only a few have explored the feasibility of running an SI engine with ammonia only. At this state it can be concluded that pure ammonia is possible mainly at full load operation as underlined in [22] and recently confirmed by Lhuillier et al. [24,25]. To improve the combustion process, the best carbon-free promoter is hydrogen but also due to its combustion velocity and wide flammability range. In [16], Mounaïm-Rousselle and Brequigny concluded from previous studies [6,23–25,28] that with conventional CR (about 10:1), only small quantities of hydrogen are necessary to ensure stable operation and best efficiencies (around 5 to 10%). Those small quantities can even be obtained by the means of an thermal converter to dissociate on-board ammonia into H<sub>2</sub> and N<sub>2</sub> [22,29]. Only, one study evokes the specificity of H<sub>2</sub> requirement at idle speed, which seems to be so important that it cannot be provided with such converter [28].

Regarding the pollutant emissions caused by the use of ammonia fuel, the issue is not trivial and requires in-depth studies before being able to propose optimized solutions according to the best operating mode to deal with the problem of NO<sub>x</sub>, perhaps N<sub>2</sub>O but also NH<sub>3</sub> or even H<sub>2</sub>. Without any aftertreatment device, it appears that:

- lean operation leads to high NO<sub>x</sub> (higher than with gasoline) but low unburnt NH<sub>3</sub>
- rich operation leads to low NO<sub>x</sub> but too high unburnt NH<sub>3</sub>, unacceptable due to the smell and toxicity
- increasing H<sub>2</sub> quantity at the intake leads to slightly higher NO<sub>x</sub> level but very low unburnt NH<sub>3</sub> (due to a better combustion efficiency) but with some H<sub>2</sub> content at the exhaust.

At this point, the optimization of the use of ammonia as fuel suffers from the limited data available on the performance of ammonia-fueled vehicles. Therefore, in order to increase the knowledge on ammonia fueled SI engine, the present paper will provide new database:

- first by providing the operating conditions at full load (i.e. atmospheric intake pressure) but as a function of different engine speed and H<sub>2</sub> quantity in the fuel blend,
- second, the lowest possible intake pressure, i.e. load conditions,

- and last in the case of turbocharged conditions (fixed regime of 2000 rpm), to evaluate the maximum dilution ratio limit and its impact on pollutant.

## 2. Experimental Method

### 2.1 Experimental Setup

Engine experiments were conducted in a modern four-cylinder four-stroke Gasoline Direct Injection-SI EP6 PSA engine, modified to become an indirect injection single-cylinder engine by filling only one out of four cylinders as fully described [21]. The engine specifications are presented in Table 2.

Table 2. Engine specifications.

Displaced volume	399.5 cm <sup>3</sup>
Stroke	85.8 mm
Bore	77 mm
Connecting rod length	138.5 mm
Compression ratio	10.5:1
Number of valves	4

The engine is driven by an electric motor at a fixed engine speed varied from 650 to 2000 rpm. The main shaft is equipped with an optical encoder for angular position monitoring with a 0.1 Crank Angle Degree (CAD) resolution. A water-cooled AVL piezoelectric pressure transducer with a 0.1 CAD resolution and a measuring range of 0 – 25 MPa provides in-cylinder pressure measurements. Engine intake and exhaust temperature and pressure are monitored using type K thermocouples and piezo-resistive absolute pressure transducers. The absolute cylinder pressure is obtained by equalizing it with the mean absolute intake pressure,  $P_{in}$ , at 20 CAD after inlet valve opening. The spark plug device is the original one with a time discharge set to 2 ms.

Ammonia, hydrogen and air gaseous flows are measured and controlled using Brooks thermal mass flowmeters with  $\pm 0.7\%$  accuracy. They are preheated to the intake temperature of 323 K and premixed in an intake plenum before injection. A scheme of the experimental setup is shown in Figure 1.

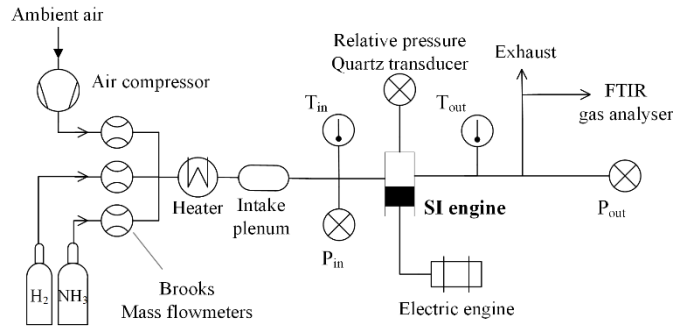
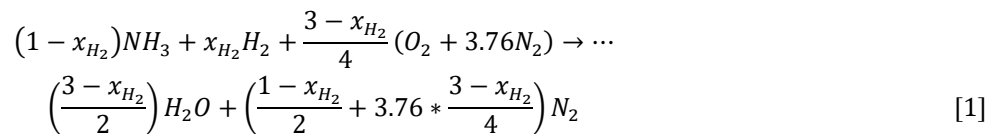

Figure 1. Layout of the experimental setup.

The wet exhaust gases are analyzed using a Gaset Fourier Transform Infrared (FTIR) spectrometer to assess H<sub>2</sub>O, NO, NO<sub>2</sub>, N<sub>2</sub>O and NH<sub>3</sub> concentrations. To obtain simultaneous quantitative measurement of many gaseous species with a good time resolution and accuracy, the interferences between the species of interest are correctly identified and considered in the analysis settings. The analysis ranges and uncertainty estimation can be found in previous work [30]. Please note that error bars are not plotted consistently in order to improve readability. In addition, analyzers for H<sub>2</sub> by thermal conductivity and O<sub>2</sub> by paramagnetic (ADEV) are used on a dry exhaust gas sample (without H<sub>2</sub>O and NH<sub>3</sub>). The water vapor measurement done with the FTIR analyzer is used for wet correction. The accuracy of the H<sub>2</sub> and O<sub>2</sub> analyzers is  $\pm 1\%$  (range 0 – 20% H<sub>2</sub>, 0 – 21% O<sub>2</sub>).

## 2.2 Investigated conditions

The global stoichiometric reaction of NH<sub>3</sub>/H<sub>2</sub>/air complete combustion is, where  $x_{H_2}$  is the hydrogen molar fraction in the fuel mixture, as:



Non-stoichiometric mixtures are defined by the global equivalence ratio:

$$\phi = \frac{\frac{X_{H_2} + X_{NH_3}}{X_{air}}}{\left(\frac{X_{H_2} + X_{NH_3}}{X_{air}}\right)_{st}} \quad [2]$$

$X_s$  represents the molar fraction of the species,  $s$ , in the reactive mixture. The spark-ignition timing is set to ensure the maximum net indicated mean effective pressure (IMEP) with a coefficient of variation of the IMEP over 100

cycles,  $COV_{IMEP}$  lower than 5%. Only averaged values over 100 cycles are presented in this paper. The range of investigated operating conditions is summarized in Table 4.

Table 3. Overview of the test conditions.

Engine speed (rpm)	650; 1000; 1500; 2000
Intake temperature (K)	323
Intake pressure (bar)	[0.6 – 1] 1.3 for dilution impact
H <sub>2</sub> molar fraction in the fuel, $x_{H_2}$	[0.0 – 0.10]
$\phi$	[0.9 – 1.1]
%N <sub>2</sub> dilution	Up to 8% of the total at the intake

### 3. Results

#### 3.1 Operating limits

In Table 4, stable operation modes are identified with a cross and black cells indicate conditions where either ignition or stable operation ( $COV_{IMEP} \leq 5\%$ ) were possible. As it can be seen, addition of 10% H<sub>2</sub> is sufficient to promote the ignition in all conditions. Increasing the engine speed makes the combustion for pure ammonia more difficult. Besides, it was not possible to ignite or ensure stable operations at 2000 rpm for pure ammonia. It is also more difficult to obtain stable combustion in lean conditions.



Table 4. Limits in operating the engine with ammonia for several engine speeds, equivalence ratios, percentages of H<sub>2</sub> as a function of intake pressures

		650 rpm			1000 rpm			1500 rpm			2000 rpm			
		%H <sub>2</sub>												
$\Phi$	P <sub>in</sub> (bar)	0%	5%	10%	0%	5%	10%	0%	5%	10%	0%	5%	10%	
0.9	<=0,65	X						X	X			X		
	0,8-0,85	X		X	X	X	X	X		X	X		X	
	1	X		X	X	X	X	X	X	X	X		X	
1	<=0,65	X			X	X	X	X			X			
	0,8-0,85	X	X	X	X	X	X	X		X	X		X	
	1	X	X	X	X	X	X	X	X	X	X		X	
1.1	<=0,65	X		X	X	X	X	X			X			
	0,8 -0,85	X	X	X	X	X	X	X		X	X		X	
	1	X	X	X	X	X	X	X	X	X	X		X	

Figure 2 shows the IMEP as a function of the minimum intake pressure acceptable to ensure stable operation, i.e. COV<sub>IMEP</sub><=5%. Increasing H<sub>2</sub> content in the fuel enables to operate at lower intake pressure down to 0.55 bar which

provides a 2.75 Bar IMEP. For pure ammonia, the minimum intake pressure achieved is 0.75 bar corresponding to 4.8 bar IMEP. It is therefore possible to operate the engine at very low load.

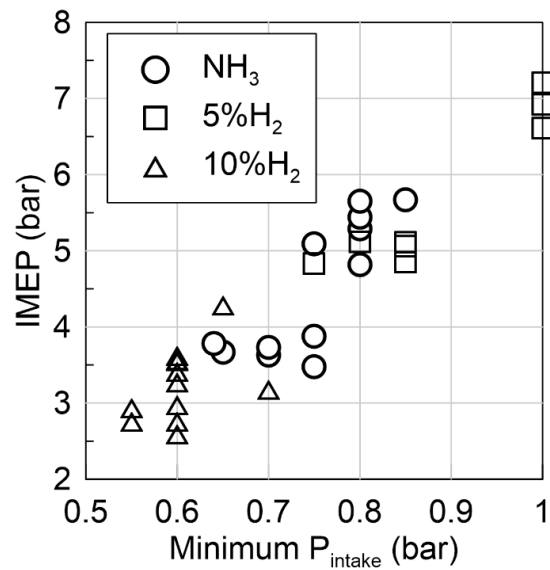

Figure 2. IMEP vs. minimum intake Pressure

### 3.2 Engine speed effect for engine performance at atmospheric intake pressure

Figure 4 shows the IMEP as a function of the engine speed, for 10% H<sub>2</sub> in the fuel, which guarantees stable operations in all conditions. One can notice the classical IMEP increase with engine speed at optimized Spark-Timing [31] due to improved combustion, less wall heat losses and improved volumetric efficiency. Higher IMEP is obtained for stoichiometric and slightly rich mixture due to higher energy content. It seems that the IMEP peak value is not reached on this engine speed range consistently with the work of Cornelius et al. [9] that show the peak IMEP at 2500 rpm with a very similar CR.

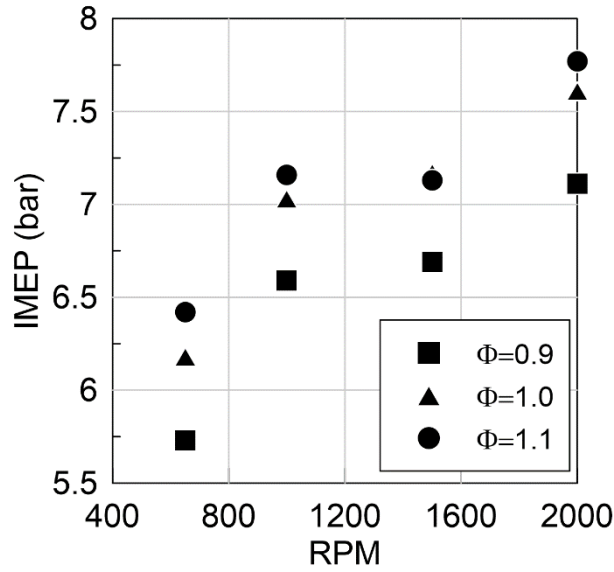

Figure 3. IMEP vs. Engine Speed at  $P_{in} = 1$  bar and 10%  $H_2$ . 1500 rpm from [23].

Ignition timing (IT) and Combustion phasing (CAX = Crank Angle Degrees (CAD) when X% of fresh fuel mass is burned) at the stoichiometric condition with 5%  $H_2$  in ammonia blend are plotted in Figure 4. Similar combustion phasing and durations are displayed except for 2000 rpm which has a much earlier spark timing. This phasing is set because of a very low flame speed compared to the engine speed: the flame requires therefore more CAD to propagate in the cylinder.

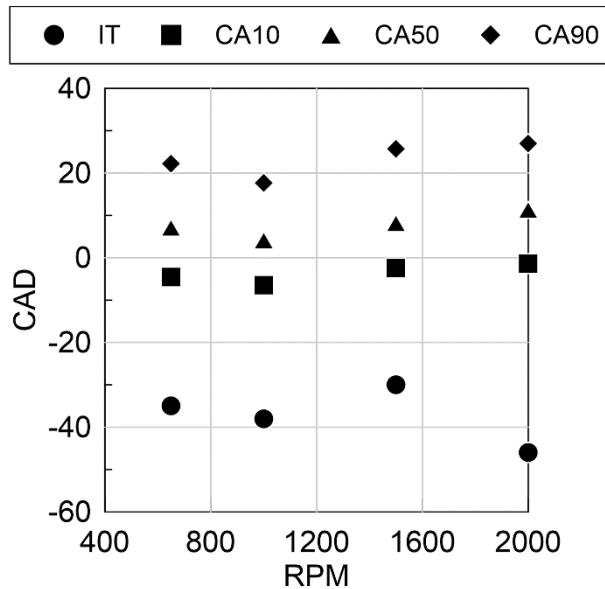

Figure 4. Combustion phasing for  $P_{in}=1$  bar,  $\Phi=1$ , 5%  $H_2$ . 1500 rpm from [23]

Figures 5 and 6 present respectively  $NH_3$  and  $NO_x$  emissions as a function of the equivalence ratio for all  $H_2$  contents and 3 engine speeds at atmospheric intake pressure. As well expected,  $NH_3$  at exhaust increases with

equivalence ratio and NOx decreases. The addition of H<sub>2</sub> in ammonia decreases NH<sub>3</sub> emissions at the exhaust, due to less NH<sub>3</sub> as fuel at the intake but also a slight improvement of the combustion efficiency, as for example at the stoichiometry from 0.95 for neat ammonia to 0.96 with 10%H<sub>2</sub> at 1000 rpm,

The maximum of NOx level is founded in this study at  $\Phi=0.9$  for all conditions. The decrease of NOx with equivalence ratio increase as previously observed [23–25], is similar to NOx evolution for any hydrocarbons even if NOx pathway is not only the thermal one. Indeed, there is also the fuel NO route due to the presence of N in the fuel molecule itself. This increases NOx level at the exhaust. Increasing the engine speed seems to reduce NH<sub>3</sub> level but the effect on NOx is less evident. In their study, Frigo and Gentili [28] showed that NOx level was almost constant as a function as the engine speed from 2500 to 4000 rpm, but it should be kept in mind that NH<sub>3</sub>/H<sub>2</sub> ratio was optimised for each operation condition. Here, if NOx is plotted as a function of the engine speed for 2 equivalence ratio and the 3 fuel compositions, as seen in Fig. 7, it can be concluded that for  $\Phi=0.9$ , NOx increases with both engine speed and %H<sub>2</sub> increase. For stoichiometric mixture, the engine speed effect is less evident. NOx emissions are mainly composed by NO as seen on Fig. 8 where NO<sub>2</sub>/NO is plotted. Minimum levels of NO<sub>2</sub> are observed at stoichiometry for 650 (about 20 ppm) and 2000 rpm (about 90 ppm). However higher values are measured at 1000 rpm (between 300 and 500 ppm) without any expected explanations. Increasing equivalence ratio decreases NO<sub>2</sub> but less than for NO thus increasing the proportion of NO<sub>2</sub> in the NOx.

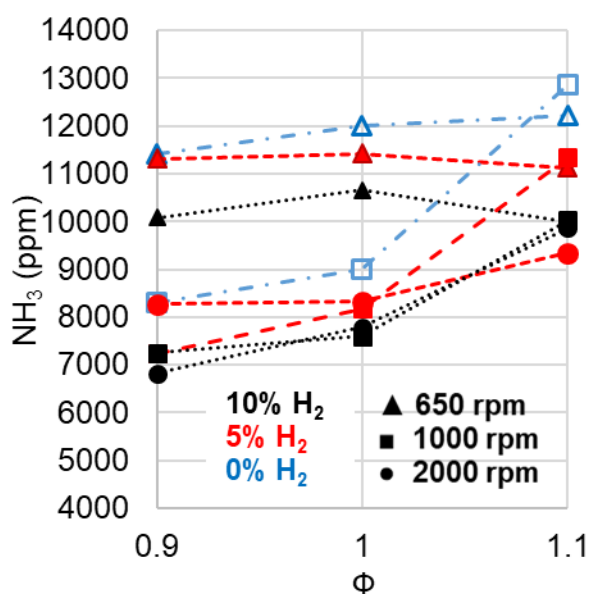

Figure 5. NH<sub>3</sub> emissions vs equivalence ratio for different engine speeds and H<sub>2</sub> content, P<sub>in</sub>=1 bar.

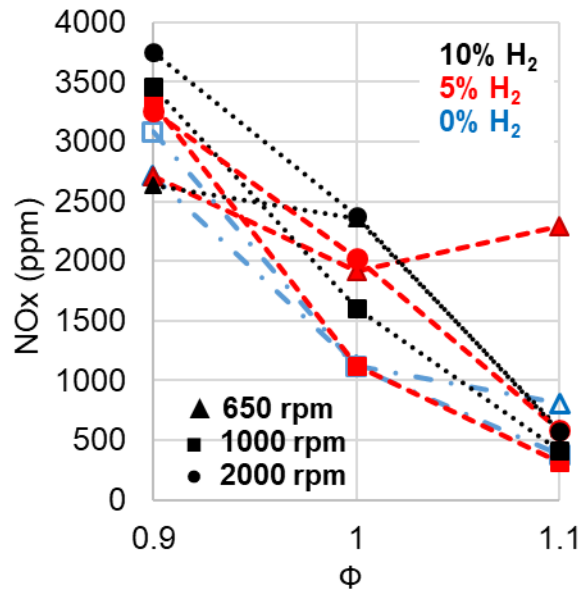

Figure 6. NO<sub>x</sub> emissions vs equivalence ratio for different engine speeds and H<sub>2</sub> content, P<sub>in</sub>=1 bar.

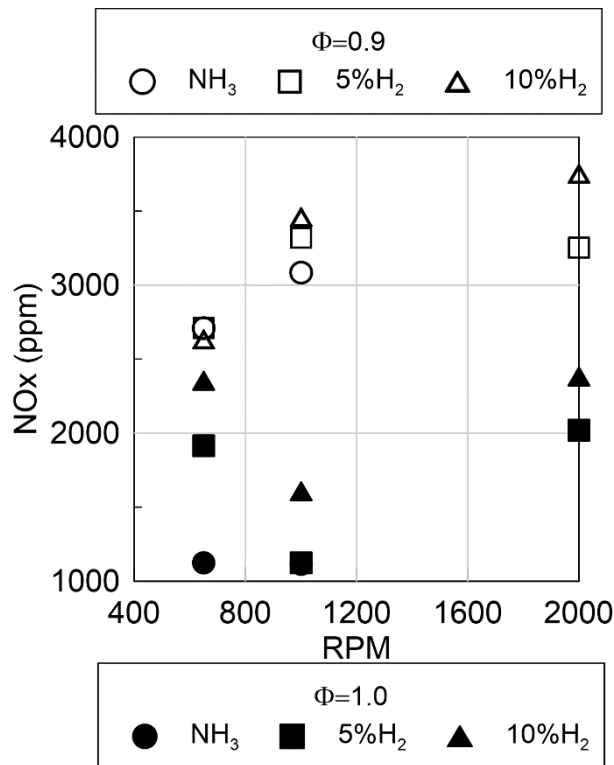

Figure 7. NO<sub>x</sub> emissions vs engine speed for H<sub>2</sub>% content (0,5 and 10), at  $\Phi = 0.9$  and 1. P<sub>in</sub>=1 bar

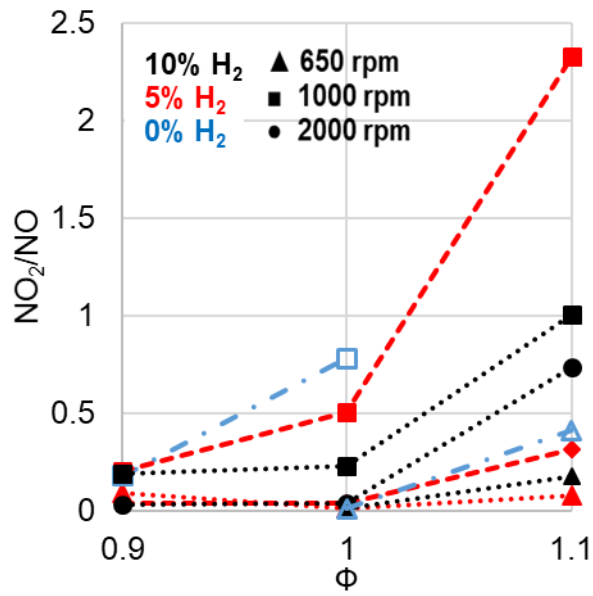

Figure 8. NO<sub>2</sub>/NO emissions vs equivalence ratio for different engine speeds and H<sub>2</sub> content, P<sub>in</sub>= 1 bar.

The combustion of NH<sub>3</sub>, due to the combustion kinetics and the presence of N in the fuel, can generate another product, N<sub>2</sub>O, which has higher global warming potential than CO<sub>2</sub> itself (i.e. 265 times higher). The evolution of N<sub>2</sub>O as function of the equivalence ratio, plotted in Figure 9, presents the same trend as NO<sub>x</sub> emissions: with a maximum value on the lean side and a decrease with the equivalence ratio increase. Maximum level measured is about 80 ppm which corresponds to 2.1% equivalent of CO<sub>2</sub> at the exhaust. It can be noted also that the increase

of engine speed clearly increases  $N_2O$  emissions (by 1.5) and also the increase of  $H_2$  seems to favour the production of  $N_2O$ . As a result, the potential of  $NH_3$  as fuel in decreasing greenhouse gases emissions is here illustrated.

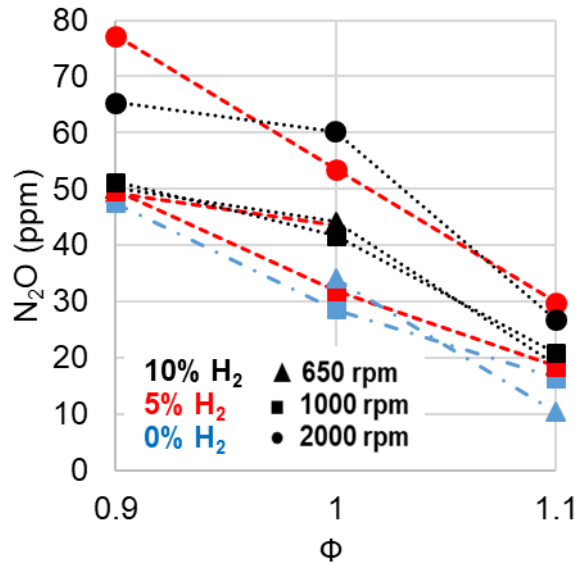

Figure 9.  $N_2O$  emissions vs equivalence ratio for different engine speeds and  $H_2$  content,  $P_{in}=1$  bar.

Due to the presence of  $H_2$  in some fuel mixtures, it is interesting to follow also  $H_2$  emissions, as displayed in Figure 10. As expected,  $H_2$  reaches important level as unburnt gases of the fuel mixture until 3% of total exhaust gases, in the case of rich fuel mixtures. But it is interesting to notice that  $H_2$  is found at the exhaust even for neat ammonia combustion. This is in agreement with the work of Cornelius et al. [9] and Lhuillier et al. [24] and indicates  $NH_3$  dissociation in the cylinder. For neat ammonia in rich conditions,  $H_2$  emissions are even higher than  $H_2$  content in  $NH_3$  blend. For lean and stoichiometric conditions, as the measured values are below the accuracy range of the analyser, it proves the total consumption of  $H_2$  as in [9,24]. The increase of engine speed seems to lead to an increase of  $H_2$  emissions. Some kinetics simulations are needed to improve these results as a function of residence time.

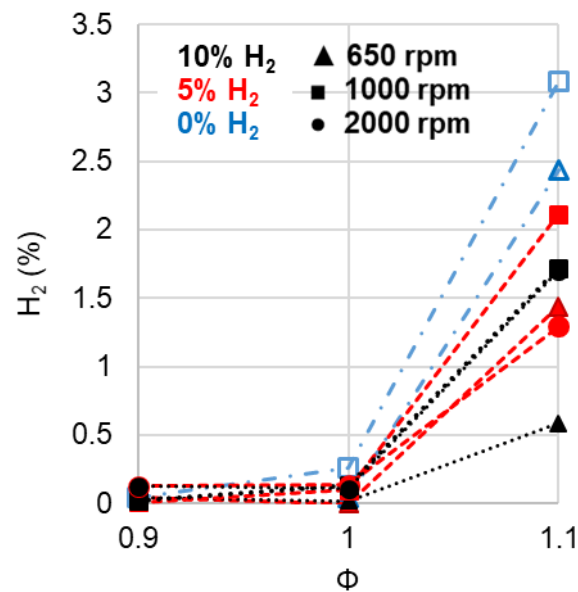

Figure 10. H<sub>2</sub> emissions vs equivalence ratio for different engine speeds and H<sub>2</sub> content, P<sub>in</sub>=1 bar.

From the exhaust pollutants measurement, it is clear that mitigation strategies for both NH<sub>3</sub> and NO<sub>x</sub> are needed before to consider ammonia as a fuel, acceptable for commercial applications. A Selective Catalyst Reactor (SCR) could be one solution, since both heat and the NO<sub>x</sub> reducing agent, NH<sub>3</sub> is available in the exhaust pipe, as suggested by Westlye et al. [17]. It has to be noticed first that NH<sub>3</sub> content in the exhaust is for all conditions higher than NO<sub>x</sub> to allow SCR operating. The feasibility of that approach is assessed in Figure 11 that shows the average exhaust temperature as function of the equivalence ratio. As expected, the highest exhaust temperatures are obtained for stoichiometric and slightly rich mixtures, where the maximum LBV is reached, thus bringing the operating conditions closer to an ideal cycle. The best operating temperature for usual catalysts is in the range 280–480 °C. This would require running the engine below 2000 rpm for an atmospheric intake pressure. Indeed, increasing the engine speed increases the exhaust gas temperature due to a higher exhaust flowrate whereas H<sub>2</sub> content in the fuel (in the range studied) seems not to have impact on the exhaust temperature consistently with Lhuillier et al. results [23].



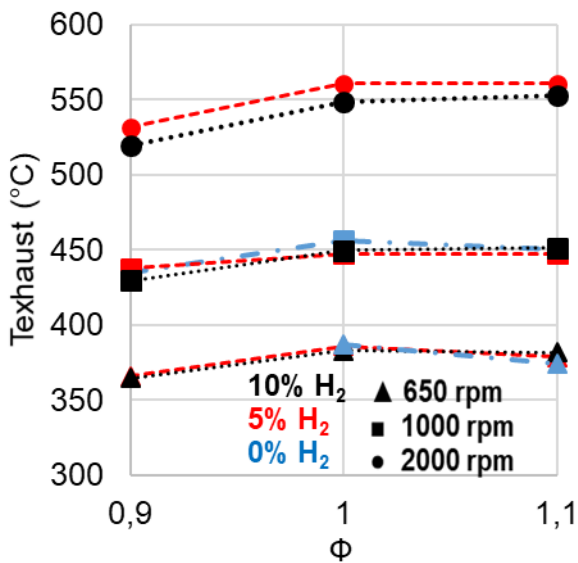

Figure 11. Exhaust temperature vs. equivalence ratio.  $P_{in}=1$  bar

Nonetheless, before considering complicate post-exhaust systems, the use of exhaust gases recirculation (internal or external) can be explored for two main reasons: to limit NO<sub>x</sub> emissions, especially for lean operating mode but also for rich pure ammonia to get H<sub>2</sub> contents at the intake and therefore help the combustion development itself. In the following, a dilution with N<sub>2</sub> is considered only to evaluate the stability of the combustion itself in the case of pure ammonia (without any H<sub>2</sub> content at the intake).

### 3.3 Dilution opportunity @ 1500 rpm and $P_{in}=1.3$ bar

In order to simulate EGR effect, N<sub>2</sub> was introduced at the intake in the case of ammonia as fuel only. An intake pressure of 1.3 bar was chosen, as this operating condition is easier with pure ammonia [25]. It was possible to ignite the air-NH<sub>3</sub>-N<sub>2</sub> mixture until a N<sub>2</sub> amount up to 9% of the total intake air-fuel mixture, which corresponds to maximum 11% of intake air as an equivalent EGR. As shown in Figure 12, IMEP linearly decreases with %N<sub>2</sub> (because of the lower energy content) up to 6-7% N<sub>2</sub> where a drop occurs due to the stability limit that is reached as seen on the COV<sub>IMEP</sub> in Figure 13.

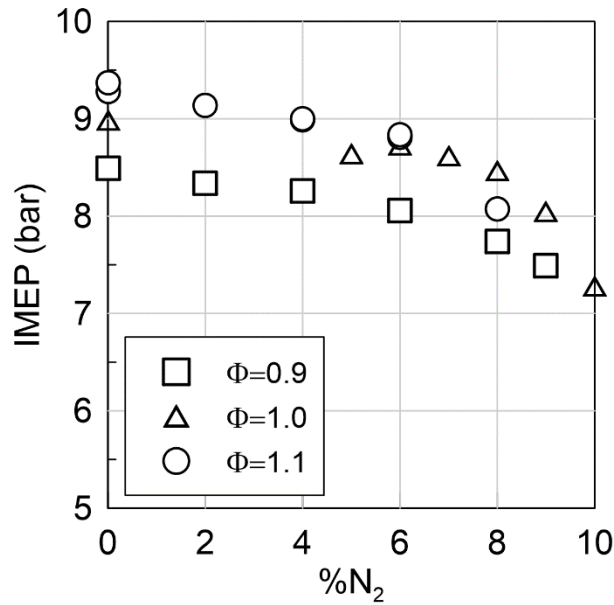

Figure 12. IMEP vs %N<sub>2</sub> in total intake gases for pure ammonia, P<sub>in</sub>=1.3 bar, 1500 rpm.

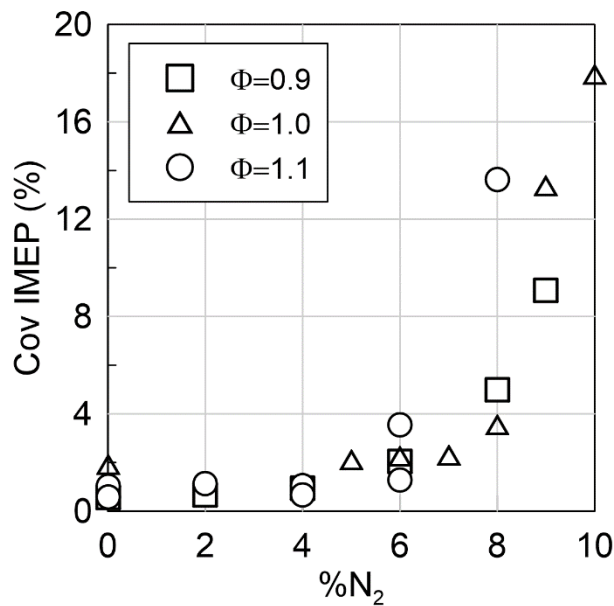

Figure 13. COV<sub>IMEP</sub> vs %N<sub>2</sub> in total intake gases for pure ammonia, P<sub>in</sub>=1.3 bar, 1500 rpm.

As expected, the combustion remains stable up to a certain percentage before COV<sub>IMEP</sub> explodes (about 8%N<sub>2</sub>) similarly to hydrocarbon fuel [32]. Dilution shows interesting potential in reducing NO<sub>x</sub> at the exhaust as it can be seen in Figure 14, especially on the lean side where a 40% decrease is observed with 8%N<sub>2</sub> without increasing NH<sub>3</sub> emissions. Real EGR could be even more interesting since it should contain unburned NH<sub>3</sub> as well as potential H<sub>2</sub> as already show in Fig. 10 [24].

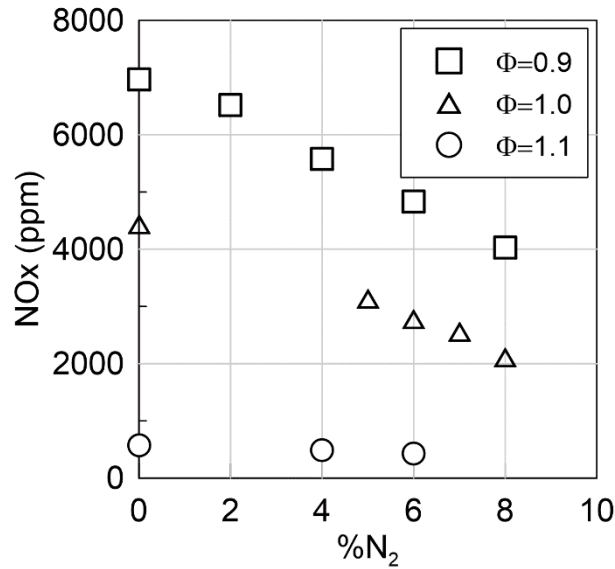

Figure 14. NO<sub>x</sub> vs vs %N<sub>2</sub> in total intake gases for pure ammonia. P<sub>in</sub>=1.3 bar, 1500 rpm.

#### 4. Conclusion

This paper has provided insights in operating an ammonia fuelled Spark-Ignition engine in terms of operating limit, engine speed effect, and dilution possibilities.

Regarding the operating limits, it has been showed that it is possible to run one engine at very low load as 2.75 bar IMEP, when 10%H<sub>2</sub> is added wand at the idle speed (i.e 650 rpm) even with neat ammonia as fuel. Globally, 10%H<sub>2</sub> in the fuel is enough to operate in all conditions. However, for neat ammonia, the low load operation is difficult and requires a greater minimum intake pressure. Moreover, the operation at 2000 rpm is not possible due to the slow combustion speed. At full load, concerning the effect of the engine speed, IMEP displays a classical increase with engine regime. Combustion phasing appears to be not affected by the engine speed but the ignition timing needs to be advanced for higher engine speed so that the flame has sufficient time to propagate inside the cylinder.

Regarding the emissions, NH<sub>3</sub> at the exhaust decreases with an engine speed increase, with highest levels reached for rich mixture. NO<sub>x</sub> emissions are mainly composed by NO and the effect of the engine speed seems to depend on the equivalence ratio. Even if NH<sub>3</sub> does not produce any carbon content at the exhaust, it can emit N<sub>2</sub>O, one of the most important greenhouse gases. Due to its very low emission level, the global warming potential represents only 2.1% equivalent of CO<sub>2</sub> impact. For both NO<sub>x</sub> and N<sub>2</sub>O, highest levels of emissions are observed on the lean side with a decrease with equivalence ratio increase. Last, H<sub>2</sub> is obtained at the exhaust in rich conditions even for

neat ammonia combustion, which will be an interesting opportunity for real EGR applications in order to promote combustion. Exhaust temperatures were also monitored and seem suitable for a SCR use to mitigate both  $\text{NH}_3$  and  $\text{NO}_x$  emissions at least below 2000 rpm.

The last part of this study shows that dilution with  $\text{N}_2$  in turbocharged like conditions is interesting in decreasing  $\text{NO}_x$  at the exhaust especially for lean and stoichiometric mixture even if only an equivalent EGR ratio lower than 10% is used to ensure combustion stability. As a result, there is an interesting potential in studying operation with real EGR dilution as it should contain not only  $\text{N}_2$  but also  $\text{H}_2$ ,  $\text{NO}_x$ ,  $\text{NH}_3$ , and water which will surely impact the chemistry and the thermodynamics.

## 5. Acknowledgement

The authors acknowledge the contribution of B. Raitière and J. Bouriot, from joint PRISME/PSA Open lab 'Energetics', for their technical support.



This project receives support from the European Union's Horizon 2020 research and innovation under grant agreement No. 862482 (ARENHA project)

## 6. References

- [1] UNFCCC, Paris Agreement, Paris, 2015.
- [2] A. Valera-Medina, H. Xiao, M. Owen-Jones, W.I.F. David, P.J. Bowen, Ammonia for power, *Prog. Energy Combust. Sci.* 69 (2018) 63–102. doi:10.1016/J.PECS.2018.07.001.
- [3] A.T. Wijayanta, T. Oda, C.W. Purnomo, T. Kashiwagi, M. Aziz, Liquid hydrogen, methylcyclohexane, and ammonia as potential hydrogen storage: Comparison review, *Int. J. Hydrogen Energy.* 44 (2019) 15026–15044. doi:https://doi.org/10.1016/j.ijhydene.2019.04.112.
- [4] Y. Bicer, I. Dincer, Life cycle assessment of ammonia utilization in city transportation and power generation, *J. Clean. Prod.* 170 (2018) 1594–1601. doi:https://doi.org/10.1016/j.jclepro.2017.09.243.

- [5] P.J. Linstrom, W.G. Mallard, NIST Chemistry WebBook, NIST Standard Reference Database Number 69, 20899th ed., National Institute of Standards and Technology, Gaithersburg MD, n.d. doi:<https://doi.org/10.18434/T4D303>.
- [6] C.S. Mørch, A. Bjerre, M.P. Gøttrup, S.C. Sorenson, J. Schramm, Ammonia/hydrogen mixtures in an SI-engine: Engine performance and analysis of a proposed fuel system, *Fuel*. 90 (2011) 854–864. doi:10.1016/j.fuel.2010.09.042.
- [7] E. Koch, Ammonia as a fuel for motor buses, *J. Inst. Pet.* 31 (1949) 21–32.
- [8] J.T. Gray, E. Dimitroff, N.T. Meckel, R.D. Quillian, Ammonia Fuel - Engine Compatibility and Combustion, SAE Tech. Pap. (1966). doi:10.4271/660156.
- [9] W. Cornelius, L.W. Huellmantel, H.R. Mitchell, Ammonia as an Engine Fuel, SAE Tech. Pap. (1965). doi:10.4271/650052.
- [10] E.S. Starkman, H.K. Newhall, R. Sutton, T. Maguire, L. Farbar, Ammonia as a Spark Ignition Engine Fuel: Theory and Application, SAE Tech. Pap. (1966). doi:10.4271/660155.
- [11] E.S. Starkman, G.E. James, H.K. Newhall, Ammonia as a Diesel Engine Fuel: Theory and Application, SAE Tech. Pap. (1967). doi:10.4271/670946.
- [12] T.J. Pearsall, C.G. Garabedian, Combustion of Anhydrous Ammonia in Diesel Engines, SAE Tech. Pap. (1967). doi:10.4271/670947.
- [13] R.F. Sawyer, E.S. Starkman, L. Muzio, W.L. Schmidt, Oxides of Nitrogen in the Combustion Products of an Ammonia Fueled Reciprocating Engine, SAE Tech. Pap. (1968). doi:10.4271/680401.
- [14] C. Garabedian, J. Johnson, The theory of operation of an ammonia burning internal combustion engine, report 634681, Michigan, USA, 1965.
- [15] P. Dimitriou, R. Javaid, A review of ammonia as a compression ignition engine fuel, *Int. J. Hydrogen Energy*. 45 (2020) 7098–7118. doi:10.1016/j.ijhydene.2019.12.209.
- [16] C. Mounaïm-Rousselle, P. Brequigny, Ammonia as Fuel for Low-Carbon Spark-Ignition Engines of Tomorrow's Passenger Cars, *Front. Mech. Eng.* 6 (2020) 70. <https://www.frontiersin.org/article/10.3389/fmech.2020.00070>.

- [17] F.R. Westlye, A. Ivarsson, J. Schramm, Experimental investigation of nitrogen based emissions from an ammonia fueled SI-engine, *Fuel*. 111 (2013) 239–247. doi:10.1016/j.fuel.2013.03.055.
- [18] S.M. Grannell, D.N. Assanis, S. V Bohac, D.E. Gillespie, The Fuel Mix Limits and Efficiency of a Stoichiometric, Ammonia, and Gasoline Dual Fueled Spark Ignition Engine, *J. Eng. Gas Turbines Power*. 130 (2008). doi:10.1115/1.2898837.
- [19] S. Grannell, D. Assanis, D. Gillespie, S. Bohac, Exhaust Emissions From a Stoichiometric, Ammonia and Gasoline Dual Fueled Spark Ignition Engine, in: *Proc. ASME Intern. Combust. Engine Division 2009 Spring Tech. Conf.*, Milwaukee, Wisconsin, USA, 2009. doi:10.1115/ICES2009-76131.
- [20] K. Ryu, G.E. Zacharakis-Jutz, S.-C. Kong, Performance enhancement of ammonia-fueled engine by using dissociation catalyst for hydrogen generation, *Int. J. Hydrogen Energy*. 39 (2014) 2390–2398. doi:10.1016/j.ijhydene.2013.11.098.
- [21] K. Ryu, G.E. Zacharakis-Jutz, S.-C. Kong, Effects of gaseous ammonia direct injection on performance characteristics of a spark-ignition engine, *Appl. Energy*. 116 (2014) 206–215. doi:10.1016/j.apenergy.2013.11.067.
- [22] M. Koike, H. Miyagawa, T. Suzuoki, K. Ogasawara, Ammonia as a hydrogen energy carrier and its application to internal combustion engines, in: *Gaydon, Warwickshire (Eds.), Sustain. Veh. Technol.*, Woodhead Publishing, 2012: pp. 61–70. doi:10.1533/9780857094575.2.61.
- [23] C. Lhuillier, P. Brequigny, F. Contino, C. Mounaïm-Rousselle, Experimental study on ammonia/hydrogen/air combustion in spark ignition engine conditions, *Fuel*. 269 (2020) 117448. doi:10.1016/j.fuel.2020.117448.
- [24] C. Lhuillier, P. Brequigny, F. Contino, C. Rousselle, Performance and Emissions of an Ammonia-Fueled SI Engine with Hydrogen Enrichment, *SAE Tech. Pap.* (2019). doi:10.4271/2019-24-0137.
- [25] C. Lhuillier, P. Brequigny, F. Contino, C. Rousselle, Combustion Characteristics of Ammonia in a Modern Spark-Ignition Engine, *SAE Tech. Pap.* (2019). doi:10.4271/2019-24-0237.
- [26] Y. Woo, J.Y. Jang, Y.J. Lee, J.N. Kim, Recent progress on the Ammonia-Gasoline and the Ammonia-Diesel Dual Fueled Internal Combustion Engines in Korea, in: *11th Annu. NH3 Fuel Conf.*, Des Moines, Iowa, USA, 2014.
- [27] S.O. Haputhanthri, T.T. Maxwell, J. Fleming, C. Austin, Ammonia and Gasoline Fuel Blends for Spark Ignited Internal

Combustion Engines, J. Energy Resour. Technol. 137 (2015). doi:10.1115/1.4030443.

- [28] S. Frigo, R. Gentili, Analysis of the behaviour of a 4-stroke Si engine fuelled with ammonia and hydrogen, Int. J. Hydrogen Energy. 38 (2013) 1607–1615. doi:10.1016/j.ijhydene.2012.10.114.
- [29] M. Comotti, S. Frigo, Hydrogen generation system for ammonia-hydrogen fuelled internal combustion engines, Int. J. Hydrogen Energy. 40 (2015) 10673–10686. doi:10.1016/j.ijhydene.2015.06.080.
- [30] C. Lhuillier, P. Brequigny, N. Lamoureux, F. Contino, C. Mounaïm-Rousselle, Experimental investigation on laminar burning velocities of ammonia/hydrogen/air mixtures at elevated temperatures, Fuel. (2019) 116653. doi:10.1016/J.FUEL.2019.116653.
- [31] J.B. Heywood, Internal combustion engine fundamentals, McGraw-Hill, 1988.
- [32] L. Francqueville, J.-B. Michel, On the Effects of EGR on Spark-Ignited Gasoline Combustion at High Load, SAE Int. J. Engines. 7 (2014) 1808–1823. doi:10.4271/2014-01-2628.

## 7. Glossary

*CAD*: Crank Angle Degree

*IMEP*: Indicated Mean Effective Pressure

*RPM*: Rotation per Minute

*COV*: Coefficient of variation

*NO<sub>x</sub>*: Nitrogen oxides

*IT*: Ignition Timing

*EGR*: Exhaust Gas Recirculation