



**HAL**  
open science

# Interoperability in the cyber-physical manufacturing enterprise

Georg Weichhart, Hervé Panetto, Arturo Molina

► **To cite this version:**

Georg Weichhart, Hervé Panetto, Arturo Molina. Interoperability in the cyber-physical manufacturing enterprise. *Annual Reviews in Control*, 2021, 51, pp.346-356. 10.1016/j.arcontrol.2021.03.006 . hal-03186819

**HAL Id: hal-03186819**

**<https://hal.science/hal-03186819v1>**

Submitted on 31 Mar 2021

**HAL** is a multi-disciplinary open access archive for the deposit and dissemination of scientific research documents, whether they are published or not. The documents may come from teaching and research institutions in France or abroad, or from public or private research centers.

L'archive ouverte pluridisciplinaire **HAL**, est destinée au dépôt et à la diffusion de documents scientifiques de niveau recherche, publiés ou non, émanant des établissements d'enseignement et de recherche français ou étrangers, des laboratoires publics ou privés.

# Interoperability in the Cyber-Physical Manufacturing Enterprise

Georg Weichhart\* 0000-0002-1405-5825, Hervé Panetto\*\* 0000-0002-5537-2261,  
Arturo Molina\*\*\* 0000-0001-5461-2879

\* *PROFACTOR GmbH, Austria (e-mail: georg.weichhart@profactor.at)*

\*\* *University of Lorraine, CNRS, CRAN, France*

*(e-mail: herve.panetto@univ-lorraine.fr)*

\*\*\* *Tecnológico de Monterrey, México (e-mail: armolina@tec.mx)*

**Abstract:** New technologies supporting cyber-physical enterprise systems with respect to online decision-making based on up-to-date data, require networked sensor and actor systems in place. Interoperability is a key factor when supporting systems in a system-of-systems. In this paper, we survey approaches on Enterprise Interoperability with special attention to the Cyber-Physical Manufacturing Enterprise. The paper identifies the need for interoperability in system-of-systems in contrast to integration in a single system. Also identified are issues due to insufficient support for physical aspects of systems. An application scenario from the manufacturing domain will serve to underpin the developed approach.

**Keywords:** Systems Interoperability; Enterprise Integration; Internet-of-Things and Sensing Enterprise; Cyber-Physical Systems; Enterprise Interoperability

## 1. INTRODUCTION

For this work it is important to distinguish enterprise integration and interoperability. The research topic *Enterprise Interoperability* evolved from *Enterprise Integration*. Therefore, we first introduce Enterprise Integration. “Enterprise Integration consists in breaking down organizational barriers to improve synergy within the enterprise so that business goals are achieved in a more productive and efficient way” (Vernadat, 2002, p. 15).

Enterprise Interoperability is defined in more general terms from an information systems point of view, as “the ability of two or more systems or components to exchange and use information” (IEEE, 1990, p. 42).

However, Enterprise Integration and Enterprise Interoperability follow a similar business goal. The major differentiator is the degree of coupling between the parts that are interacting. Integration (here) implies a tight coupling whereas interoperability focuses on loose coupling. The loose coupling and the definition of interfaces allows autonomy of parts and supports exchange of parts (Panetto, 2007).

Common to both approaches is that there is also a process point of view. “... it must be stressed that integration is a never-ending process. First, because it is a goal. Second, because the enterprise is in a permanent process of change.” (Vernadat, 2002, p. 18). This is even more true when loose coupled systems are considered, as it is the case with Enterprise Interoperability.

The second important concept for this work is the concept of *Cyber-Physical System* (CPS). These are systems that involve

a hardware and a software part (more follows below). And (with respect to the point of view taken here) multiple of such CPSs are connected, and collaboration is required for reaching a higher goal to which several CPSs contribute. This implies that the (loose or tight) integration of interacting CPSs is required.

The following parts of the paper are organised as follows. First, we introduce CPS, and discuss Cyber-Physical-Enterprises. This is followed by a discussion of Systems-of-Systems related to CPS. We then present a well-known schema on Enterprise Interoperability, which is used to discuss multiple approaches to loose coupling in Cyber-Physical Enterprise Systems. Applications of Enterprise Interoperability in the Cyber-Physical Manufacturing Enterprise are analysed. This is followed by presenting our conclusions.

## 2. FROM CYBER-PHYSICAL SYSTEMS TO THE CYBER-PHYSICAL ENTERPRISE

The introduction of *Cyber-Physical Systems* (CPS), together with advances in Information and communication technologies (ICT) has been the major driving force for the 4<sup>th</sup> industrial revolution (Arnold et al., 2016). These advances are empowering an era of digital transformation (digitalization) by offering connectedness and intelligent computation. Thus, promoting collaboration in production systems and organizational integration. Industry 4.0 technologies, particularly in automation fields, forecast promising solutions for the future of digitized industrial ecosystem. One of the major expected outcomes of this revolution is the allocation of

tedious and repetitive tasks to intelligent machines and robots (Moeuf et al., 2018; Mourtzis et al., 2019). A CPS describes a broad range of network connected systems that are physically-aware and integrate embedded computing (cyber) and technologies. into the physical world (De Carolis et al., 2016). These systems are engineered by a multidisciplinary team (Derler et al., 2013). Inside these kinds of networks are components with advanced abilities: sensing, data collection, data transmission and mechanical actuation. The era of digital transformation is evolving faster than expected. One aspect of this evolution is to enhance advanced collaboration mechanisms in industries; particularly collaborations that are involving humans and machines (Bouffaron et al., 2014; Hernoux et al., 2015; Panetto et al., 2019; Zhang et al., 2017). In these industrial contexts, the nature of relations between humans and CPS is demanding not only task execution but also cognitive interaction (Fast-Berglund et al., 2020). However, the current design approaches of industrial systems heavily rely on the core concept of CPS lacking efficient means to link technical and social prospects. This degrades the quality of collaboration and can compromise safety (Moulières-Seban et al., 2017) resulting in challenges for delivering and coping with the speed of evolution in Industry 4.0. Particularly the main challenge originates from the complexity of human nature, as people usually do not follow rules that are not matching with their way of thinking, preferences, needs and capabilities. In addition to this, it has to be taken into account that everyone is unique and her behaviour under different circumstances is driven by complex and dynamic phenomena,

which are not fully understood. A CPS promotes intensive connection and coordination between physical elements and computational elements, providing, using, modifying data and services simultaneously (He, 2014) (cf. Fig. 1). This figure shows a Cyber-Physical System decomposed in 4 functional units. This figure highlights not only the physical system and the cyber-system, but also the interfaces between these. Within each of the four units, different degrees of sophistication are exemplified. To clarify all elements composing a CPS and the relationships between the components, a meta-model of CPSs has been proposed (Lezoche and Panetto, 2020) - see Fig.2.

Putting multiple CPS (as defined above) in an Enterprise context of networked CPS, a *Cyber-Physical Enterprise* (CPE) viewpoint is developed. A CPES has three basic capabilities (Cardin, 2019): Intelligence (computation), Connectedness (communication), and Responsiveness (control). Using the words of (Monostori et al., 2016), a Cyber-Physical Enterprise (Panetto et al., 2019) *consists of autonomous and cooperative elements and sub-organisations that are connected based on the context within and across all levels of the global organisation, from processes, through machines and up to enterprises and supply-chains networks.* These capabilities allow considering a CPE as a support to transform its processes into highly distributed and interconnected networks of “entities” requiring new ways of interactions between these entities. One example of such formalism is collaborative control theory (Nof, 2007) for the collaborative factory of the future (Moghaddam and Nof, 2017).

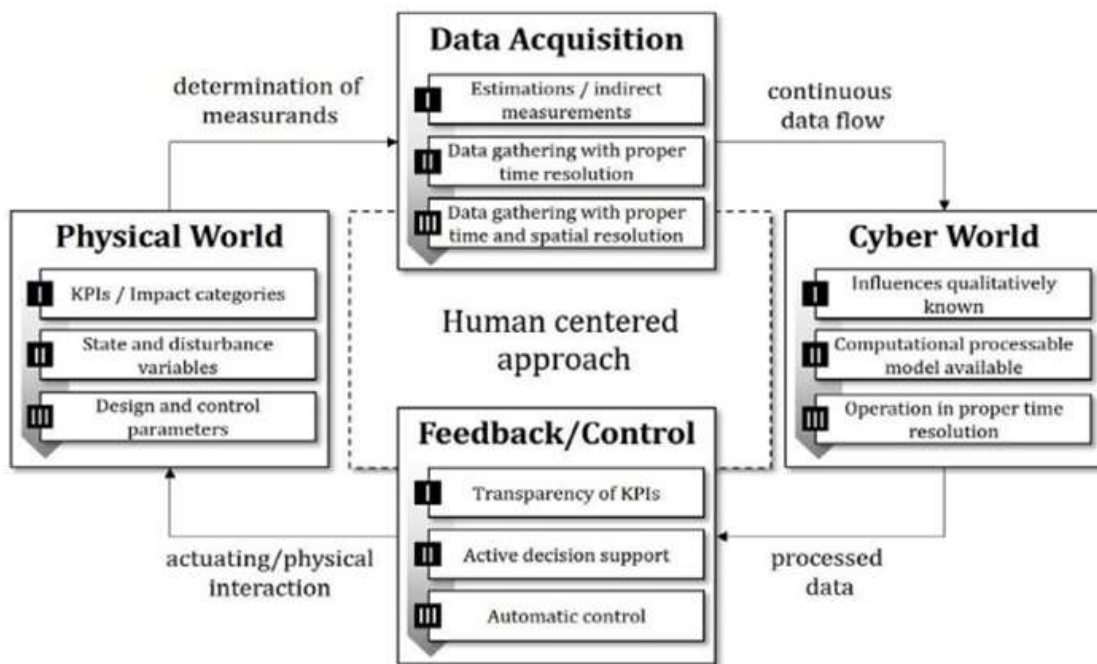

Fig.1 CPS principles (Cesare Alippi, 2014)

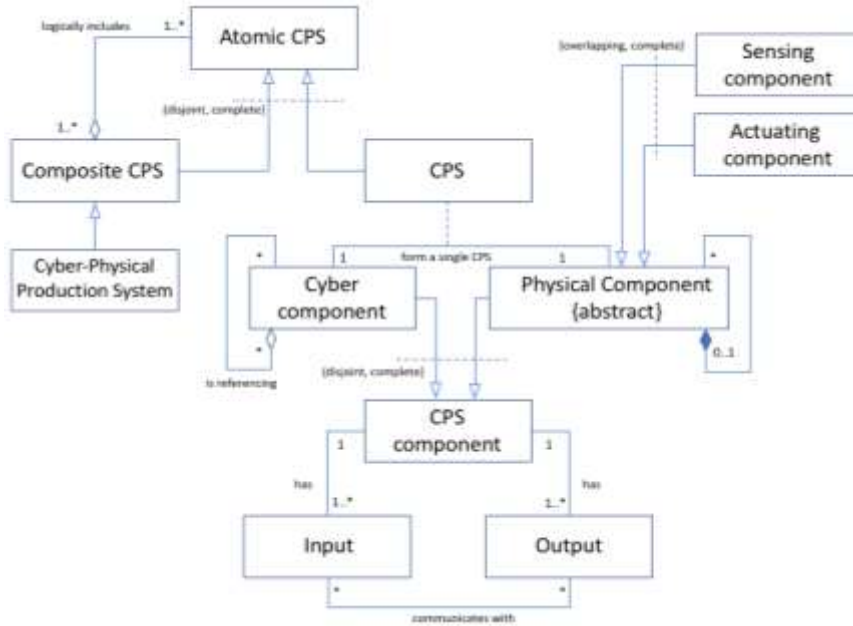

Fig. 2 CPS metamodel (Lezoche and Panetto, 2020)

### 3. THE ENTERPRISE AS A CYBER-PHYSICAL SYSTEM-OF-SYSTEMS

A Cyber-Physical Enterprise (CPE) may be considered as a *System-of-Systems*, built on 5 basic capabilities (Boardman and Sauser, 2006) (see Table 1): Autonomy, Belonging, Connectivity, Diversity and Emergence.

The Cyber-Physical Enterprise and a System-of-Systems point of view may be extended towards *Complex Adaptive Enterprise Systems* (CAS) (Weichhart, 2014). Although no agreed-upon definition of a Complex Adaptive System exists, some properties are commonly discussed in the literature. A CAS consists of autonomous Agents (Holland, 1998, 1996). These Agents are capable of sensing their environment, plan actions and execute them in the environment. The environment typically reacts to these actions. Agents are independent and have their own goals they follow. Agents are evaluating their actions against these goals to see if a goal can still be reached.

In a CAS not a single agent is placed, but multiple agents. These agents might either be communicating directly to each other with messaging or might indirectly communicate with each other by placing signals in the environment. These means of communication connect the agents among each other or with the environment. The loose coupling of agents in a CAS allows some (unplanned) behaviour to emerge.

In both cases, the SoS and the CAS case, the *loose coupling* of the systems (agents) makes them *fundamentally* different to Systems. This is not only true for the System but also for Systems Engineering (BKCASE Editorial Board, n.d.; Morel et al., 2007). A System may be engineered in a process that integrates the parts. This integration is possible as the parts are passive without individual goals. In a loose coupled CAS or SoS, the Systems that form the super-systems maintain their individual autonomy. The groups of systems or agents may for example change during the engineering process.

Neither CAS (and Holonics) nor SoS can, by definition, work with integration (tight coupling) of systems or agents / holons. Support for interoperability, and very loose coupling in the CP Enterprise is strongly needed.

### 4. EI FRAMEWORKS FOR THE CYBER-PHYSICAL ENTERPRISE

In the following, we are taking a look into existing approaches where Enterprise Interoperability is applied in an (implicit or explicit) Systems-of-Systems context.

Enterprise Interoperability is grounded in Enterprise Integration. There is an overlap between approaches supporting loose coupling in Enterprise Integration and Enterprise Interoperability. The concept of interoperability is different to integration in a similar manner as the concept of system-of-systems and systems (see above).

There is a continuum between the extremes of tight integration and loose coupled interoperability. In addition to this, an enterprise system can be positioned in different locations along the continuum on different levels of the enterprise at the same time (e.g. tight coupling of technical systems and loose coupling of organisational systems).

In the following, first, a brief look into these different levels of granularity in the enterprise system-of-system is taken. These levels are summarized in figure 3. It addresses the physical and the cyber-world and the interaction of both.

Table 1: Differentiating a System from a System-of-Systems (Boardman and Sauser, 2006) applied to the Cyber-Physical Enterprise

Property	System	System-of-Systems
<b>Autonomy</b>	No autonomy of parts; only autonomy of the system.	Autonomy is exercised by constituent systems in order to fulfil the purpose of the SoS.
<b>Belonging</b>	Parts are akin to family members; they did not choose themselves but came from parents. Belonging of parts is in their nature.	Constituent systems choose to belong on a cost/benefits basis; also in order to cause greater fulfilment of their own purposes, and because of belief in the SoS supra purpose.
<b>Connectivity</b>	Prescient design, along with parts, with high connectivity hidden in elements, and minimum connectivity among major subsystems.	Dynamically supplied by constituent systems with every possibility of myriad connections between constituent systems, possibly via a net-centric architecture, to enhance SoS capability.
<b>Diversity</b>	Managed i.e. reduced or minimized by modular hierarchy; parts' diversity encapsulated to create a known discrete module whose nature is to project simplicity into the next level of the hierarchy	Increased diversity in SoS capability achieved by released autonomy, committed belonging, and open connectivity
<b>Emergence</b>	Foreseen, both good and bad behaviour, and designed or tested as appropriate	Enhanced by deliberately not being foreseen, though it's crucial importance is, and by creating a potential for emergence that will support early detection and elimination of bad behaviours.

The first level describes *legal interoperability*. An enterprise is part of a social context. That context is made explicit by the rules the society has established. That's the legal frameworks. Enterprises taking part in this system, have to be interoperable

with the legal frameworks. Legal frameworks have influence on the sustainability of an enterprise. This is simply by (not) tolerating certain behaviour. This includes interoperability of behaviour (in the general sense) between enterprises that take part in a supply network.

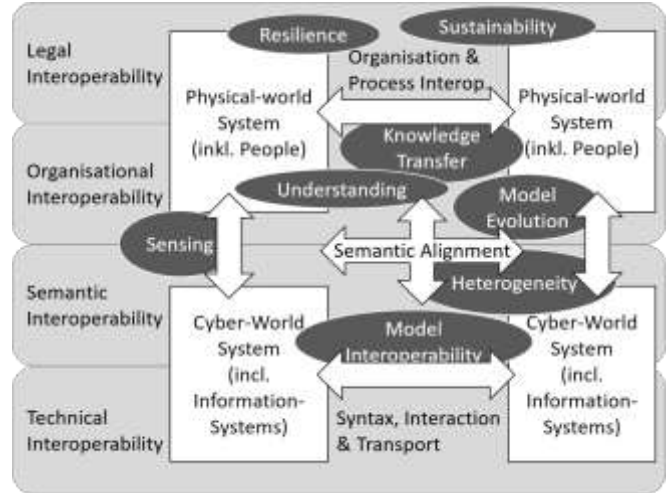

Fig. 3 Interoperability Framework based on EIF European (Panetto et al., 2019)

On the next level of granularity, enterprise systems consist of systems themselves. The systems that form the enterprise have to be interoperable within the context established by the enterprise. Processes and knowledge transfers need to take place in the enterprise as it evolves. The organizational level involves some sort of *pragmatic interoperability*, because here the doing of agents in the enterprise manifests itself in (explicit or implicit) processes (Weichhart et al., 2016b).

In the cyber-physical enterprise *semantic interoperability* of data and information is needed between any agents (no matter if human or artificial). Semantics addresses the meaning of information shared between two or more agents (Panetto et al., 2016).

For parts of the CP Enterprise, common interface standards and data exchange mechanisms can be established. These are technical interfaces to machines and also include artificial personal assistant agents that visualise data in a personalized way. These technical interfaces including e.g. types of exchanged data and application programming interfaces (APIs) need to be interoperable also over time.

#### 4.1 Organisational Interoperability

Organisational levels of Enterprise Interoperability address work processes and knowledge shared across the enterprise. In both cases not only different parts of the enterprise are involved, but both elements (and others) are evolving over time.

Enterprise Interoperability itself, is also a process, because evolving systems require maintaining interoperability over time. This is true for all levels (e.g. Software APIs change from version to version of an application), but will be considered mainly on this level. From an organisational learning and

knowledge management point of view (Firestone and McElroy, 2004), this is required for continuous learning in the organisation in order to improve. Two approaches exist, on the one hand side, e-learning technologies can be used to support the continuous evolution of models in a group (Weichhart, 2015). On the other hand, learning and improvement are goals in-line with the process of maintaining interoperability in enterprises when facing changes required for improvement (Weichhart et al., 2016a). In both cases, adaptation and change is a social learning experience involving multiple agents.

A project supporting organisational interoperability is MISE and its successor MISE2 (Bénaben et al., 2013, 2015). The developed approach is a service-based Mediation Information System supporting interoperability for collaborations of organisations. Using Business Process Management knowledge transfers with respect to individual and collaborative business behaviour is supported. A mediation information system, based on a service-oriented architecture, allows the generation of collaborative workflows, integrating service-based applications. The third tool is an event-driven architecture, which supports organisations in agile behaviour and reactions to events. Events triggered by the supervision of collaborative situations and by (hardware) sensors.

With respect to the Cyber-Physical Enterprise, the agility aspect of MISE, does allow to take signals from the environment into account and to react on signals in a workflow. Yet, the concept of Cyber-Physical requires a more in-deep conceptual integration of physical elements and cyber-elements.

The SuddEN international research project has, among other results, created an organisational learning approach for supporting interoperability (Weichhart et al., 2010). Here the underlying assumptions built on a view of organisations constantly changing and learning, improving. This learning includes social learning where multiple stakeholders collaboratively work on a topic. This organisational learning model builds on organisational learning (Firestone and McElroy, 2005) in order to work on interoperability in a team of organisations. Here interoperability is seen as a process that one needs to constantly follow, so the interoperability is maintained despite organisational systems that are evolving.

SuddEN focuses on evolution and learning in organisational settings. Here a conceptual integration of physical elements is missing.

The Liquid Sensing Enterprise (LSE) approach builds on the assumption that the enterprise is a complex adaptive system. It aims at the provision of an infrastructure for enterprise systems-of-systems to evolve over time (Agostinho and Jardim-Goncalves, 2015). In this model-driven approach, independent agents communicate with each other using models. Used models (e.g. for decision making) will need to be changed and to be transformed (Weichhart and Fessl, 2005). In the LSE, a model morphism agent is proposing model mappings. The use of a simulation environment allows estimating the impact of changes to the existing system.

The approach does already include CPS on a conceptual level. LSE separates concerns of the real, digital and virtual World.

LSE applications follow a CPS point of view, as it builds on abstract models and metadata that supports the virtualisation of real devices like sensors, actuators, and the information contributed by these systems (Agostinho and Jardim-Goncalves, 2015).

The S<sup>3</sup> Enterprise (Smart, Sensing, Sustainable Enterprise) (Weichhart et al., 2016b) is an approach that conceptualises the enterprise as a socio-technical information system (Stamper et al., 2000) where human and artificial agents are making decisions. The dynamics of the (business) environment requires the enterprise to constantly evolve. Data and Information, measured by sensors of cyber-physical systems and which transform the data using intelligent algorithms, are supporting the evolution.

The S<sup>3</sup> Enterprise is a concept in-line with the Cyber-Physical Enterprise. It addresses the enterprise as an organisational concept as well as the information flows (semantic interoperability) and technical aspects.

However, in this conceptualisation, the evolution and complex interaction of systems is of importance. Any approach for the S<sup>3</sup> Enterprise, requires that evolution and also learning is possible. Engineering support for Enterprise Models has to respect such evolutions with features like re-use of model parts, notifications of change need to be supported.

#### 4.2 Semantic Interoperability

As seen in figure 3 above, semantic interoperability is a core aspect. Semantic interoperability does refer to data flows and understanding of the transmitted data-concepts on the sender and the receiver side. As such, it requires conceptual interoperability for understanding the other's worldview. It also requires technical interoperability for transferring data from sender to receiver.

Ontological approaches support the reasoning and common understanding of multiple agents (in the broad sense of the word).

The Ontology of Enterprise Interoperability (OoEI) (Naudet et al., 2010) takes a systemic perspective on Enterprise Interoperability. Its core is grounded in General Systems Theory (Bertalanffy, 1969, 1950). It has been created to allow capturing and modelling systemic aspects of enterprises as systems. Relating the OoEI to the discussion above, it has to be noted that it focuses on systems but does not include a systems-of-systems point of view. Nevertheless, it takes an ontological approach on Interoperability in Enterprise Systems. Among other things, the ontology defines a Meta-Model of Systems, their interfaces, different types of relationships of systems to other systems and the environment.

The OoEI has been evolved in order to capture dynamic aspects provided by the Complex Adaptive Systems (CAS) theory (Weichhart, 2014). As already mentioned above, CAS theory is compatible with SoS theory. However, the systems are addressed as agents. Therefore, among other concepts, agents (i.e. dynamic systems) have been introduced. A second important addition to the OoEI is the concept of *Attractor*. This concept is necessary, to influence the agents' behaviour, which

is controlled by the individual agent itself. This resulted in the OoEI<sup>CAS</sup> Domain Specific Language (Weichhart et al., 2016a).

In addition to extending the OoEI with CAS concepts a different approach to support modelling such systems has been used. A different approach has been taken for implementing models in OoEI<sup>CAS</sup>. A *Domain Specific Language* (DSL) approach has been taken. This allows specifying ontological concepts and agent behaviour in a single language.

That DSL is implemented using the SCALA programming language<sup>1</sup>. SCALA allows to define internal DSLs as it offers a wide variety of syntactic possibilities. SCALA also provides native support for actor-based models (Hewitt, 1977). Actors are active systems similar to agent theory. With the notable exception, that most actors are created by parent-actors. These exceptions include the first actor created and system-specific actors.

The OoEI<sup>CAS</sup> DSL can be used to link physical systems with cyber systems. The chosen approach supports an agent-based design, which has shown to be a suitable and efficient means for the design and engineering of complex software architecture problems for production systems (Hehenberger et al., 2016).

Formal methods have been created to analyse the semantic gap between multiple information systems with respect to the used data model (Yahia et al., 2012b). Semantic blocks allow identifying borders of data sub-systems. Ongoing research aims at answering the question if a hierarchy of semantic blocks support the analysis of a correlation between sub-systems interoperability and systems interoperability of data models (Yahia et al., 2012a).

For supporting the use of a data model by multiple human or artificial agents, semantic annotations may be used to enhance the existing data models (Liao et al., 2015). Such annotations might be developed with respect to multiple aspects like the domain or the structure of a data model. These annotations help for the reconciliation modelling language constructs, support model transformations or the verification of modelling constraints (Liao et al., 2016).

With respect to semantic interoperability specifically for CPS, the Systems Modelling Language (SysML) (Object Management Group, 2018), has been proposed to support the integration of cyber-physical systems. SysML can be combined with agent-based approaches to support Cyber-Physical Production Process Modelling and engineering (Hehenberger et al., 2016; Vogel-Heuser, 2015).

#### 4.3 Technical Interoperability

On the technical level, the topic of interoperability between machines is handled using standards. Message-based protocols like MQTT<sup>2</sup>, AMQP<sup>3</sup> support a loose coupling of software modules in particular within a service-based architecture. These protocol standards allow establishing a data transfer between independently developed software modules. These

message-based middle-wares allow decoupling data from computational services. Distributed (e.g. edge-computing) based systems can be built. However, the semantics of the data is a separate issue (Pauker et al., 2016).

#### 4.4 Reference Architectures and Reference Models

A task-force formed by members of IFAC and IFIP workgroups has established the Generalised Enterprise Reference Architecture and Methodology (GERAM) (Bernus et al., 2006; IFIP-IFAC Task Force, 1999). It is also part of the annex to ISO 15704 (ISO/TC 184/SC 5, 2019). GERAM has been a project to combine existing architecture languages like CIMOSA (Kosanke, 1995; Kosanke et al., 1999), GRAI (Vallespir et al., 1992) and GIM (Vallespir et al., 1993), and PERA (Li and Williams, 2002).

GERAM describes methods, models and tools needed to design, implement and maintain an integrated enterprise. However, GERAM is not a concrete approach for an enterprise reference architecture. It organises existing enterprise integration knowledge. GERAM consists of the following parts (IFIP-IFAC Task Force, 1999):

- GERA - Generic Enterprise Reference Architecture
- EEMs - Enterprise Engineering Methodology
- EMLs - Enterprise Modelling Languages
- GEMCs - Generic Enterprise Modelling Concepts
- PEMs - Partial Enterprise Models
- EETs - Enterprise Engineering Tools
- EMs - (Particular) Enterprise Models
- EMOs - Enterprise Modules
- EOSs - (Particular) Enterprise Operational Systems

GERAM describes the elements for enterprise engineering and integration. It sets the basis for tools and methods that support enterprise integration and enterprise architecture. However, no specific tools, methods are imposed (Bernus et al. 2015). The core component of GERAM is the reference Architecture (GERA). It defines concepts for enterprise integration projects.

The GERAM approach allows to include CPS concepts in its modelling approach. However, no specific preparation is made to model technology that has integrated software and hardware elements.

A proposal for an S<sup>3</sup> Enterprise Reference Model (E-RM) based on the RM-ODP (Reference Model of Open Distributed Processing) (ISO/IEC JTC 1/SC 7, 1998) has been presented by (Chavarría-Barrientos et al., 2017, 2018) to guide the design and developments in the context of Sensing, Smart and Sustainable Manufacturing Enterprises.

The S<sup>3</sup> E-RM (cf. figure 4) has been conceived as a Model-Driven Architecture to support the design of an enterprise capturing the requirements independent from technology:

- Enterprise,
- Information &

<sup>1</sup> <https://www.scala-lang.org/>

<sup>2</sup> <http://mqtt.org/>

<sup>3</sup> <https://www.amqp.org/>

- Computational Viewpoint

This is the basis to derive design and generation of IT systems using the technology specific viewpoints:

- Engineering and
- Computational

Figure 4 presents examples of modelling approaches that capture the desired aspects of the viewpoints. These examples are listed below with the brief descriptions of each viewpoint.

The *Enterprise Viewpoint* describes the enterprise strategy (competitive, value chain and production/service) and is associated with the specification of requirements for ODP systems. UML modelling is used to support a formal representation: User case diagrams, Package Diagrams, Sequence Diagrams (Packages).

The *Information Viewpoint*, using UML class diagrams and activity diagrams, focuses on describing semantics of information and information processing functions related to Product, Manufacturing Systems and Knowledge models.

The *Computational Viewpoint* represents the Core Business Process (New Product Development, Obtaining Customer Commitment, Order Processing, Customer Service) using UML (Sequence Diagram Classes, Activity Diagrams) and Petri Nets.

The *Engineering Viewpoint* enables the specification of the processing, storage and communication functions required to implement the system such as Software as a Service Platform – Cloud Computing Infrastructure) and Software tools (Java based SaaS Platform and Private cloud platform). Here the inclusion of an Enterprise Operating System (EOS) could be possible (Youssef and Zacharewicz, 2019; Youssef et al., 2017, 2016).

Finally, the *Technological Viewpoint* describes all technologies for sensing (RFID, WSN and Real-time networked systems) including smart resources (Machines, AGVs, Robots, PLCs, CNCs) which connected enables the realization of a cyber-physical-production-system.

Figure 5 presents an overview of the overall development process where different stages require different models. Technology independent models are created during requirement elicitation and design. The design phase will result in detailed design documents. Technology specific developments provide detailed specifications for platforms on which the information systems are deployed. For detailed design and analysis simulation can be used.

## 5. APPLICATION TO MANUFACTURING

Cyber-Physical Systems provide a huge potential for the manufacturing industry (VDI/VDE-Gesellschaft Mess- und Automatisierungstechnik, 2013). The physical product is extended by data. Data flows upstream (from customer to suppliers) allows individualized products and lot-size one production. Data flows down-stream (from suppliers to original equipment manufacturers (OEMs)) supports to extend the function of the physical product. This data might for example specify the materials used, in order to support

remanufacturing and reuse. In other use-cases additional digital services support binding customers to the OEM (Breitfuß et al., 2017).

### 5.1 Cyber-Physical Production Systems

By putting the CPE vision into a manufacturing context, the shop floor becomes a *Cyber-Physical Production System* (CPPS). A CPPS is a network of interconnected CPSs, specialized for manufacturing (Zeid et al., 2019).

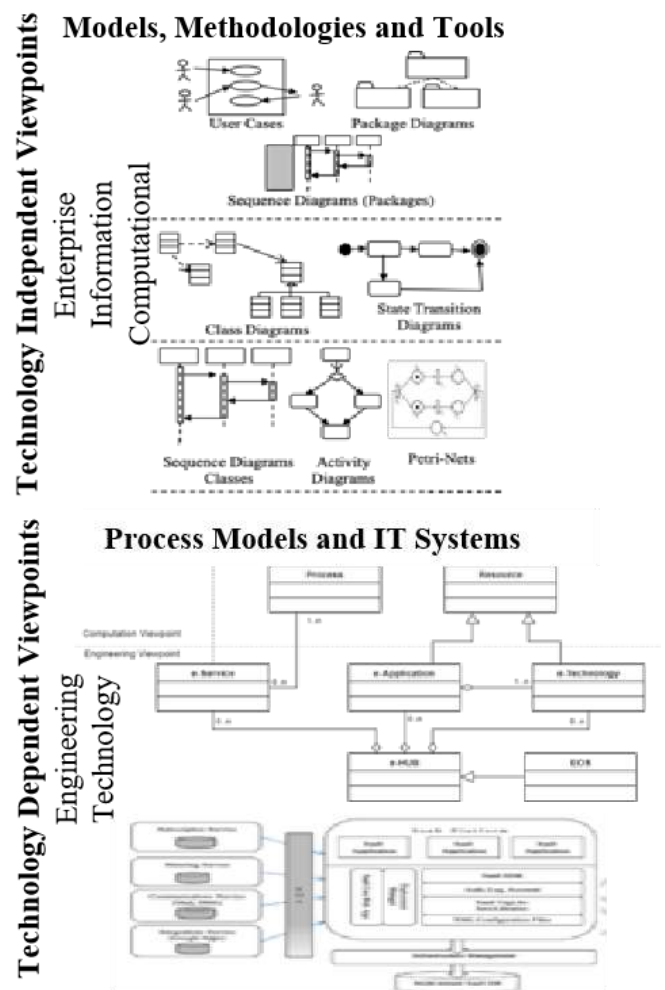

Figure 4. S<sup>3</sup> Enterprise Reference Model (S<sup>3</sup> E-RM)

The challenge of a new vision of Cyber-Physical Production Systems is to change the architecture from a hierarchy to a modular and interconnected system implemented either as services or agents (Hehenberger et al., 2016). The automation pyramid (see fig. 6) shows the currently used architecture. Different levels provide functions that can be distinguished by the planning horizon of the function. On lower levels of the pyramid the services or functions need to support reactions of systems in a (sub-)second timeframe. SCADA supports the handling of events and monitoring of machine states by human and artificial agents. MES systems support the scheduling of



production orders to machines and operators. Here we have a timeframe of a work shift or day. With an ERP number of operators and amounts of resources needed for a certain amount of production orders are planned and ordered.

The physical parts and the software need to be interoperable and continuously interacting (Panetto and Molina, 2008). Machines wrapped by software systems that represent the machine in cyberspace, follow the design principle proposed in holonics manufacturing (Brussel et al., 1998; Morel et al., 2003). In holonic systems, the piece of software provides intelligence and communication capabilities for physical machines. These Cyber-Physical Systems (aka holons) take part in a Hierarchy on the shop floor. A Hierarchy is a structure like a hierarchy, however power is on lower levels. Every holon is part of a holon and is at the same time composed of holons. A CPPS consists of autonomous and cooperative elements and subsystems that are connected based on the context within and across all levels of production, from processes, through machines and up to production and logistics networks (Monostori et al., 2016).

### 5.2 Technical Interoperability for CPPS

For the manufacturing industry there are some standards with respect to technical interoperability available. For example, OPC UA<sup>4</sup> (Schleipen, 2013; Schleipen et al., 2016) supports loose coupling and hence adaptability of production processes. OPC UA provides the technical standards to observe parameters on machines using a publish-subscribe protocol.

Another example is the IEC 61499 Standard (Christensen et al., 2012; ISO/IEC JTC 1/SC 7, 1998; Zöitl and Strasser, 2017) supports the integration of distributed control applications for production systems. The standard provides the possibility to create an abstraction layer providing function blocks. These function blocks may be wired together to provide the desired functionality. These kinds of systems are tightly coupled at design and deployment time. But the abstraction layer allows changing the physical system and the control system if they provide the same function blocks.

### 5.3 Semantic Interoperability for Manufacturing

The semantic models for manufacturing need to cover three elements: Product and Services (inkl. materials, parts needed); Production Process; Production Resource (Operators, Machine) (Garcia-Crespo et al., 2010).

The product model describes the goal and requirements. The process describes how this goal is reached, and the resource model describes how tasks are implemented / realised.

For Semantic Interoperability in Manufacturing, it must be possible to provide a consistent view on the product along the different stages of its development process and production process across the supply chain (Panetto et al., 2012).

Automation ML and System ML are two semantic modelling approaches that allow to connect different views and parts of manufacturing (Henssen and Schleipen, 2014; Lüder et al., 2010; Object Management Group, 2018; Schleipen and Drath, 2009; Tsadimas, 2015).

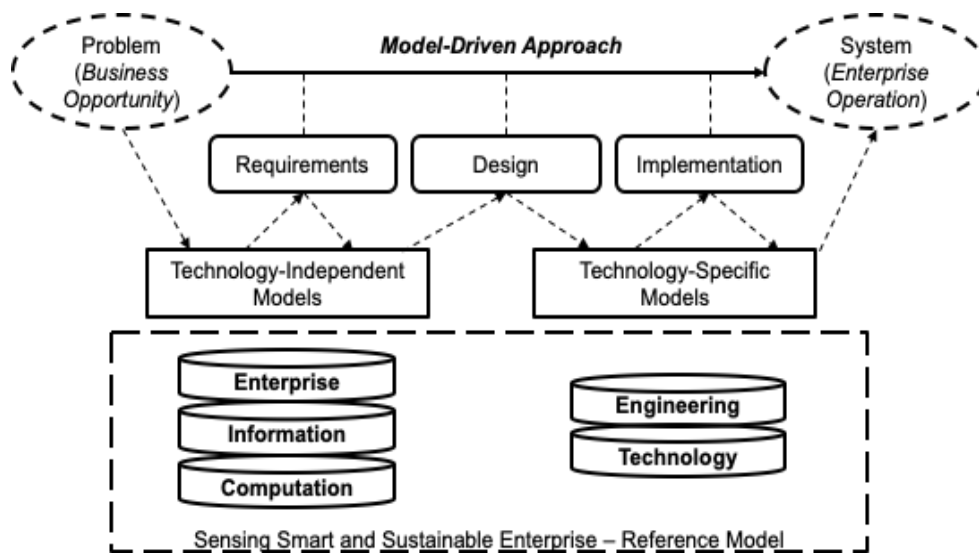

Figure 5. Model Driven approach using S<sup>3</sup> E-RM

<sup>4</sup> <https://opcfoundation.org/about/opc-technologies/opc-ua/>

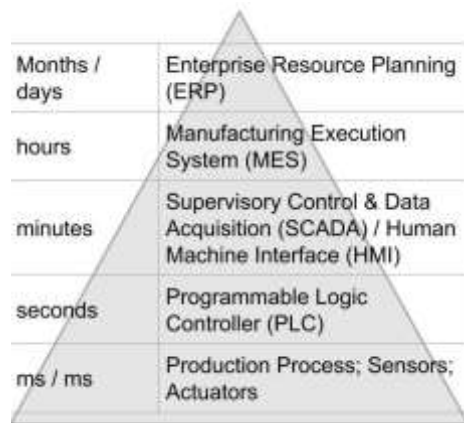

Figure 6. Manufacturing Architecture: Automation Pyramid

#### 5.4 Organisational Interoperability for Manufacturing

Smart Manufacturing, requires the possibility to connect CPSs horizontally across the supply chain (Zeid et al., 2019). However, this connectivity is also required to connect vertically machines and business processes (Kusiak, 2019). It is essential for being able to realize the vision of smart manufacturing to be able to handle data flows horizontally and vertically (Kusiak, 2017).

A manufacturing relevant initiative for interoperable connectivity across the supply chain is GAIA-X<sup>5</sup>. The GAIA-X ecosystem, which is currently under development, promises a federated infrastructure of distributed service and data providers and consumers. Federated means that there is a loose coupling between the data sources, sinks and services. This also implies heterogeneous data models and distributed storage. The loose coupling requires central services that allow data and / or services to be searched, requested and accessed. Complex services can be offered by combining simple services.

This project provides an infrastructure to be used by enterprises to connect different suppliers and enterprise customers. The participants are responsible to maintain their own data-bases. GAIA-X provides the services to connect these.

#### 5.6 EI for the Manufacturing Supply Chain

Several of the discussed approaches have been developed for the supply chain. For example, the GAIA-X infrastructure aims at boosting cross-organisational interoperability by providing a federated infrastructure. However, given the current state, the tools to support interoperability on all levels are currently developed. With respect to levels of Enterprise Interoperability, the technical infrastructure is currently in the focus of the developments. Yet, the overarching goal of enabling a federated system demands also technical services supporting semantic interoperability from the start.

The LSE approach provides an infrastructure to support manufacturing enterprise networks (Agostinho and Jardim-

Goncalves, 2015). The developed infrastructure supports sensing and adaptation of self-organizing enterprise systems. Enterprises should be enabled to detect missing or broken interoperability on organisational level between enterprises, and then react to that. This approach focuses on supporting the design and evolution of such systems.

In SuddEN the core idea is to support the design of supply networks where through the use of knowledge management. SuddEN supports conceptual interoperability and semantic interoperability for organisational networks (Weichhart et al., 2010).

For supply chains, interoperability of different systems also supports supply chain resilience (Kusiak, 2018, 2019). Interoperability (in its general sense) enables data-flows across the supply chain, which is important for digitalisation in manufacturing and smart manufacturing approaches.

#### 5.6 Enterprise Operating System

Enterprise Operating Systems (EOS) has been proposed to tackle the challenge of connecting and controlling all the resources (humans, IT, machines), processes and business models within an enterprise (Youssef and Zacharewicz, 2019; Youssef et al., 2017, 2016). As such it is an approach to enterprise interoperability which aims at covering the technology, semantic and organisational levels. The approach has been demonstrated with a pilot project related to a Bank's operation and manufacturing firm (Youssef et al., 2016). A framework for EOS using Zachman has been described by (Tayebi et al., 2010) for development and maintenance of enterprise operating systems. This EOS has been implemented using PRINCE2 (Tayebi et al., 2010). The implementation of this concept at industrial scale has been presented by (Chavarría-Barrientos et al., 2017, 2018), in collaboration with LOVIS Company in London. The implementation aims supporting integration and interoperability of systems at manufacturing companies.

This implementation has been done using as an architecture the S<sup>A3</sup> E-RM for modelling collaborative networks, and formally described using the Unified Modelling Language (UML). Figure 7 depicts how the S<sup>A3</sup> E-RM integrates the EOS concept in the reference model. It also shows the complete S<sup>A3</sup> E-RM and different enterprise's concepts that allows the design and creation of Cyber-Physical Enterprises.

The technology independent viewpoints define business models and business processes to guide the execution of the enterprise operations. These models and processes could be simulated using a Digital Twins. Business process models using Petri-nets could generate code to be executed by the SaaS platform. The SaaS platform connects all objects using communication protocols with sensing and smart manufacturing resources (includes IT resources). Digital Twins can also be used to simulate manufacturing and production processes.

<sup>5</sup> <https://www.data-infrastructure.eu/GAIA-X/Navigation/EN/Home/home.html>

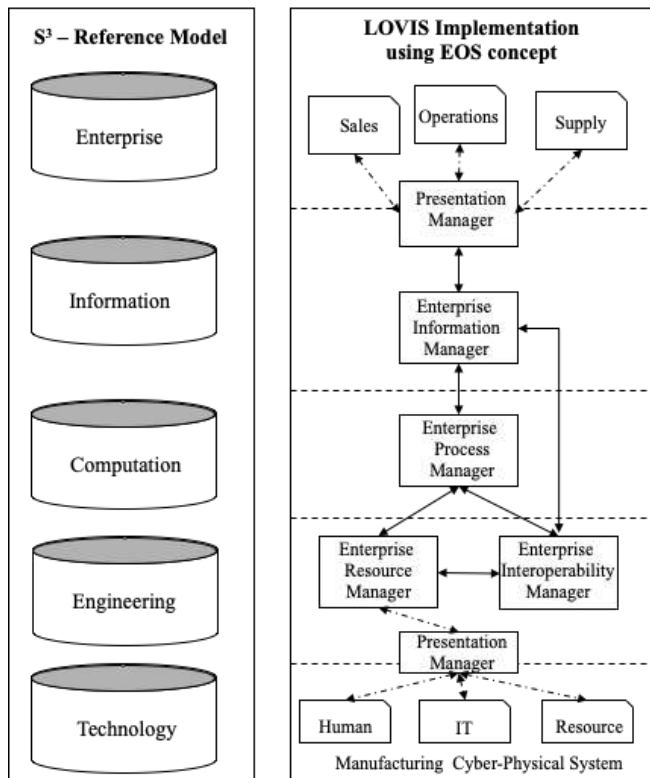

Figure 7. Implementation of an EOS System using the  $S^3$  E-RM (Chavarría-Barrientos et al., 2018)

Figure 8 presents an overview of a concrete example; how different parts of the proposed approaches are applied in the manufacturing enterprise. The Cyber-Physical Enterprise System describes the different levels of the reference model with strategic, tactical and operational decisions. Enterprise Strategies of the firm have been defined to compete as a low-cost supplier, with a vertical collaboration as a value chain decision, and with MTO production strategy. The information models used are an Ontology of mechanical parts, a CPS Micro-Factory defined as an object-oriented information model. The knowledge captures the production rules that manage the scheduling operations. Two business processes (Order Processing & Customer Service) are executed by ERP and CRM systems and a digital twin built using Petri Nets. The engineering viewpoint is supported by Software as a Service Platform and Cloud Computing. The enterprise resources include two operators, Wireless Sensors Networks and Intelligent Control, CPS Micro-factory and Digital Twin (Molina et al 2021).

## 6. CONCLUSIONS

Enterprise interoperability is a model-driven approach (Youssef et al., 2017; Zacharewicz et al., 2020). As such, it

provides input to many engineering domains where multiple models and distributed or decentralized systems are used. Interoperability is an approach that addresses important aspects for multiple individual systems to form a System-of-Systems (SoS).

Cyber-Physical Systems and Cyber-Physical Production Systems are inherently System-of-Systems located in the cyber and the physical world. As such, there are specific challenges in particular from an interoperability point of view.

In this paper, a look into approaches that support one or more layers of Enterprise Interoperability for Cyber-Physical Systems has been taken. Then the application of Enterprise Interoperability approaches in the special domain of manufacturing has been reviewed.

This highlights the added value Enterprise Interoperability as a general approach to the design and operation of manufacturing systems. Supporting tools and modelling approaches for exist. The specific nature of manufacturing enforces the point of view that manufacturing systems are Cyber-Physical Systems which in turn are Systems-of-Systems. Manufacturing Systems by their inherent nature combine existing software and hardware to execute physical processes.

Critical challenges to consider aligning the Cyber-Physical Enterprise and the Cyber-Physical Systems are: Heterogeneous Applications, Heterogeneous Networks and Heterogeneous Sensor Platforms. There is a need to provide semantic middleware that includes Information & Knowledge Models to achieve seamless integration. Runtime support is needed when systems change (their behaviour) and interoperability is lost. Different technologies and approaches are needed to have a digital twin for different physical aspects in order to develop, monitor and maintain interoperability in a CP(P)S.

The following complex problems need to be addressed in systems-of-systems in particular from a CPS point of view:

- Interoperability Aspects
  - Operational Independence of Elements
  - Managerial Independence of Elements
  - Information and Knowledge Model for Semantic Interoperability
- Design and Maintenance Aspects
  - Evolutionary Development
  - Emergent Behaviour
- Distributed Aspects
  - Geographical Distribution of Elements
  - Networks of Systems
- Heterogeneity Aspects
  - Interdisciplinary Study
  - Heterogeneity of Systems

## Concepts

## Modelling Tools and IT System

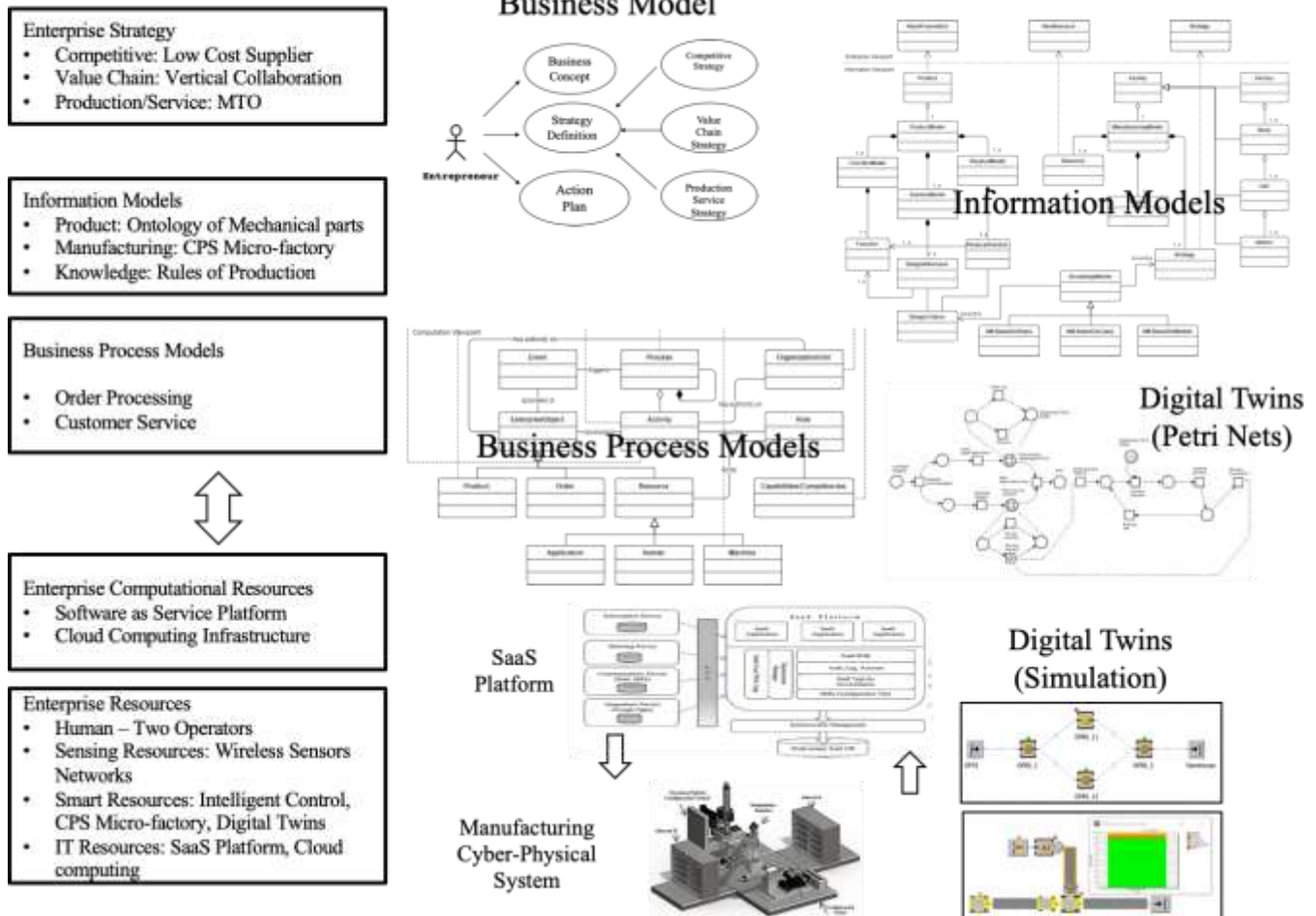

Figure 8. Using the S<sup>3</sup> E-RM to guide the creation of Cyber-Physical Enterprises.

Current Enterprise Interoperability concepts address the enterprise from an information systems point of view. The physical layer is not addressed. In the approaches analysed there is only an interface to sensors, actors based on standards. Exemplary interfaces include message queues like MQTT. However, this does not allow to address physical (incl. Physical dimensions, energy/power, etc.) interoperability. An information systems point of view is too limited. Physical interoperability is hardly addressed in the analysed approaches.

From the analysed literature, the conclusions are:

- Cyber-Physical Systems are Systems-of-Systems
- Integration violates the Systems-of-Systems idea; Interoperability is necessary to maintain independence of the systems.
- Enterprise Interoperability matches the needs for the Cyber-Physical Enterprise
- Enterprise interoperability approaches have insufficient support for physical aspects (volume, mass, electrical power, pressure, etc.)
- There is a tool chain missing for the different phases of systems in the Cyber-Physical Enterprise. Design

Engineering, Implementation, Execution, Maintenance of Cyber-Physical Systems need support in order to maintain the interoperability of that CPS with other systems interfaced.

One of the generic approaches which guides research is the S<sup>3</sup> Reference Model. Yet, there are some new concepts and tools missing to support the implementation of Cyber-Physical Systems.

The S<sup>3</sup> Reference Model provides a very broad approach. However, a RM only guides its users and does not give any specific support. The S<sup>3</sup> Enterprise is an approach that is close to the ideas of the Cyber-Physical Enterprise. Currently the concept of *Cyber-Physical System* is not specifically addressed. The S<sup>3</sup> Enterprise Reference Model is an approach that can support the Cyber-Physical Enterprise but does provide no support for *Cyber-Physical Systems as first-class citizens*. The approach will be extended on conceptual level in the future.

### ACKNOWLEDGEMENT

This work has been supported by the European Union and the State of Upper Austria within the strategic program Innovative

Upper Austria 2020 & #upperVision2030, project: WI-2020-578813/4 “DigiManu (Extended 2021)” .

## REFERENCES

- Agostinho, C., Jardim-Goncalves, R., 2015. Sustaining interoperability of networked liquid-sensing enterprises: A complex systems perspective. *Annu. Rev. Control* 39, 128–143. <https://doi.org/10.1016/j.arcontrol.2015.03.012>
- Arnold, C., Kiel, D., Voigt, K.-I., 2016. How the Industrial Internet of Things Changes Business Models in Different Manufacturing Industries. *Int. J. Innov. Manag.* 20(8), 1640015. <https://doi.org/10.1142/S1363919616400156>
- Bénaben, F., Boissel-Dallier, N., Pingaud, H., Lorre, J.-P., 2013. Semantic issues in model-driven management of information system interoperability. *Int. J. Comput. Integr. Manuf.* 26(11). <https://doi.org/10.1080/0951192X.2012.684712>
- Bénaben, F., Mu, W., Boissel-Dallier, N., Barthe-Delanoë, A.-M., Zribi, S., Pingaud, H., 2015. Supporting interoperability of collaborative networks through engineering of a service-based Mediation Information System (MISE 2.0). *Enterp. Inf. Syst.* 9, 556–582. <https://doi.org/10.1080/17517575.2014.928949>
- Bernus, P., Mertins, K., Schmidt, G. (Eds.), 2006. *Handbook on Architectures of Information Systems, International Handbooks on Information Systems.* Springer.
- Bernus, P., Noran, O., Molina, A., 2015. Enterprise architecture: Twenty years of the GERAM framework. *Annu. Rev. Control* 39, 83–93. <https://doi.org/10.1016/j.arcontrol.2015.03.008>
- Bertalanffy, L. von, 1969. *General System Theory - Foundations, Development, Applications*, 17th edition. ed. George Braziller, New York.
- Bertalanffy, L. von, 1950. An Outline of General System Theory. *Br. J. Philos. Sci.* 1, 134–165.
- BKCASE Editorial Board, n.d. *Guide to the Systems Engineering Body of Knowledge (SEBoK).*
- Boardman, J., Sauser, B., 2006. System of Systems - the meaning of of, in: *System of Systems Engineering, 2006 IEEE/SMC International Conference On.* IEEE, 1–6. <https://doi.org/10.1109/SYBOSE.2006.1652284>
- Bouffaron, F., Dupont, J.-M., Frédérique, M., Morel, G., 2014. Integrative construct for Model-Based Human-System Integration: a case study. *IFAC Proc.* Vol. 47(3), 12317–12324. <https://doi.org/10.3182/20140824-6-ZA-1003.02459>
- Breitfuß, G., Mauthner, K., Lassnig, M., Stabauer, P., Günter, G., Stummer, M., Freiler, M., Meilinger, A., 2017. *Analyse von Geschäftsmodellinnovationen durch die digitale Transformation mit Industrie 4.0 (resreport).* salzburgresearch and EVOLARIS and syngroup.
- Brussel, H. van, Wyns, J., Valckenaers, P., Bongaerts, L., Peeters, P., 1998. Reference architecture for holonic manufacturing systems: PROSA. *Comput. Ind.* 37(3), 255–274. [https://doi.org/10.1016/S0166-3615\(98\)00102-X](https://doi.org/10.1016/S0166-3615(98)00102-X)
- Cardin, O., 2019. Classification of cyber-physical production systems applications: Proposition of an analysis framework. *Comput. Ind.* 104, 11–21. <https://doi.org/10.1016/j.compind.2018.10.002>
- Cesare Alippi, 2014. *Intelligence for embedded systems: a methodological approach.* Springer.
- Chavarría-Barrientos, D., Batres, R., Wright, P.K., Molina, A., 2018. A methodology to create a sensing, smart and sustainable manufacturing enterprise. *Int. J. Prod. Res.* 56(1.2), 584–603. <https://doi.org/10.1080/00207543.2017.1386333>
- Chavarría-Barrientos, D., Chen, D., Funes, Rafael., Molina, A., Vernadat, F., 2017. An Enterprise Operating System for the Sensing, Smart, and Sustainable Enterprise. *IFAC-Pap.* 50(1), 13052 – 13058. <https://doi.org/10.1016/j.ifacol.2017.08.2004>
- Christensen, J.H., Strasser, T., Valentini, A., Vyatkin, V., Zoitl, A., 2012. The IEC 61499 function block standard: Software tools and runtime platforms. *ISA Autom. Week.*
- De Carolis, A., Tavola, G., Taisch, M., 2016. Cyber-physical systems in manufacturing: future trends and research priorities, in: *21st Summer School Francesco Turco 2016.* Presented at the 21st Summer School Francesco Turco 2016, AIDI-Italian Association of Industrial Operations Professors, pp. 12–17.
- Derler, P., Lee, E.A., Tripakis, S., Törngren, M., 2013. Cyber-Physical System Design Contracts, in: *Proceedings of the ACM/IEEE 4th International Conference on Cyber-Physical Systems, ICCPS '13.* Association for Computing Machinery, New York, NY, USA, pp. 109–118. <https://doi.org/10.1145/2502524.2502540>
- Fast-Berglund, Å., Romero, D., Åkerman, M., Hodig, B., Pichler, A., 2020. Agent- and Skill-Based Process Interoperability for Socio-Technical Production Systems-of-Systems, in: Lalic, B., Majstorovic, V., Marjanovic, U., von Cieminski, G., Romero, D. (Eds.), *Advances in Production Management Systems. Towards Smart and Digital Manufacturing.* APMS 2020, IFIP Advances in Information and Communication Technology. Springer International Publishing, Cham, pp. 46–54.
- Firestone, J.M., McElroy, M.W., 2005. Doing knowledge management. *Learn. Organ.* 12(2), 189–212. <https://doi.org/10.1108/09696470510583557>
- Firestone, J.M., McElroy, M.W., 2004. Organizational learning and knowledge management: the relationship. *Learn. Organ.* 11(2), 177–184.
- Garcia-Crespo, A., Ruiz-Mezcua, B., Lopez-Cuadrado, J.L., Gómez-Berbis, J.M., 2010. Conceptual model for semantic representation of industrial manufacturing processes. *Comput. Ind.* 61(7), 595–612. <https://doi.org/10.1016/j.compind.2010.01.004>
- He, H., 2014. *Intelligence for Embedded Systems: A Methodological Approach [Book Review].* IEEE Comput. Intell. Mag. 9(3), 85–87.
- Hehenberger, P., Vogel-Heuser, B., Bradley, D., Eynard, B.,

- Tomiyama, T., Achiche, S., 2016. Design, modelling, simulation and integration of cyber physical systems: Methods and applications. *Comput. Ind.* 82, 273–289. <https://doi.org/10.1016/j.compind.2016.05.006>
- Henssen, R., Schleipen, M., 2014. Interoperability between OPC UA and AutomationML. *Procedia CIRP* 25, 297–304.
- Hernoux, F., Nyiri, E., Gibaru, O., 2015. Virtual Reality for Improving Safety and Collaborative Control of Industrial Robots, in: *Proceedings of the 2015 Virtual Reality International Conference, VRIC '15*. Association for Computing Machinery, New York, NY, USA. <https://doi.org/10.1145/2806173.2806197>
- Hewitt, C., 1977. Viewing control structures as patterns of passing messages. *Artif. Intell.* 8(3), 323–364. [https://doi.org/10.1016/0004-3702\(77\)90033-9](https://doi.org/10.1016/0004-3702(77)90033-9)
- Holland, J.H., 1998. *Emergence: From Chaos to Order*. Basic Books.
- Holland, J.H., 1996. *Hidden Order: How Adaptation Builds Complexity*. Basic Books, New York.
- IEEE, 1990. *Standard Glossary of Software Engineering Terminology* (No. STD 610.12). IEEE.
- IFIP-IFAC Task Force, 1999. *GERAM: Generalised Enterprise Reference Architecture and Methodology (GERAM EA Framework v.1.6.3) [WWW Document]*. URL <http://www.ict.griffith.edu.au/~bernus/taskforce/index.html> (accessed 11.5.19).
- ISO/IEC JTC 1/SC 7, 1998. *ISO/IEC 10746-1:1998 - Information technology — Open Distributed Processing — Reference model: Overview — Part 1*.
- ISO/TC 184/SC 5, 2019. *ISO 15704:2019: Enterprise modelling and architecture - Requirements for enterprise-referencing architectures and methodologies*.
- Kosanke, K., 1995. CIMOSA — Overview and status. *Comput. Ind.* 27, 101–109. [https://doi.org/10.1016/0166-3615\(95\)00016-9](https://doi.org/10.1016/0166-3615(95)00016-9)
- Kosanke, K., Vernadat, F., Zelm, M., 1999. CIMOSA: enterprise engineering and integration. *Comput. Ind.* 40(2), 83–97. [https://doi.org/10.1016/S0166-3615\(99\)00016-0](https://doi.org/10.1016/S0166-3615(99)00016-0)
- Kusiak, A., 2019. Fundamentals of smart manufacturing: A multi-thread perspective. *Annu. Rev. Control* 47, 214–220. <https://doi.org/10.1016/j.arcontrol.2019.02.001>
- Kusiak, A., 2018. Smart manufacturing. *International Journal of Production Research*, 56(1-2), 508–517. <https://doi.org/10.1080/00207543.2017.1351644>
- Kusiak, A., 2017. Smart manufacturing must embrace big data. *Nature* 544, 23–25. <https://doi.org/10.1038/544023a>
- Lezoche, M., Panetto, H., 2020. Cyber-Physical Systems, a new formal paradigm to model redundancy and resiliency. *Enterp. Inf. Syst.* 14(8), 1150–1171. <https://doi.org/10.1080/17517575.2018.1536807>
- Li, H., Williams, T.J., 2002. Management of complexity in enterprise integration projects by the PERA methodology. *J. Intell. Manuf.* 13(6), 417–427. <https://doi.org/10.1023/A:10210377>
- Liao, Y., Lezoche, M., Panetto, H., Boudjlida, N., 2016. Semantic annotations for semantic interoperability in a product lifecycle management context. *Int. J. Prod. Res.* 54(18), 5534–5553.
- Liao, Y., Lezoche, M., Panetto, H., Boudjlida, N., Loures, E.R., 2015. Semantic annotation for knowledge explicitation in a product lifecycle management context: A survey. *Comput. Ind.* 71, 24–34. <https://doi.org/10.1016/j.compind.2015.03.005>
- Lüder, A., Hundt, L., Keibel, A., 2010. Description of manufacturing processes using AutomationML, in: *2010 IEEE 15th Conference on Emerging Technologies & Factory Automation (ETFA 2010)*. IEEE, pp. 1–8.
- Moeuf, A., Pellerin, R., Lamouri, S., Tamayo-Giraldo, S., Barbaray, R., 2018. The industrial management of SMEs in the era of Industry 4.0. *Int. J. Prod. Res.* 56(3), 1118–1136. <https://doi.org/10.1080/00207543.2017.1372647>
- Moghaddam, M., Nof, S.Y., 2017. The collaborative factory of the future. *Int. J. Comput. Integr. Manuf.* 30(1), 23–43. <https://doi.org/10.1080/0951192X.2015.1066034>
- Molina A., Ponce P., Miranda J., Cortés D., 2021, *Enabling Systems for Intelligent Manufacturing in Industry 4.0: Sensing, Smart and Sustainable Systems for the Design of S3 Products, Processes, Manufacturing Systems, and Enterprises*, 1st ed. 2021 Edition, Springer.
- Monostori, L., Kádár, B., Bauernhansl, T., Kondoh, S., Kumara, S., Reinhart, G., Sauer, O., Schuh, G., Sihm, W., Ueda, K., 2016. Cyber-physical systems in manufacturing. *CIRP Ann.* 65(2), 621–641. <https://doi.org/10.1016/j.cirp.2016.06.005>
- Morel, G., Panetto, H., Mayer, F., Auzelle, J.-P., 2007. System of Enterprise-Systems Integration Issues: an Engineering Perspective, in: *IFAC (Ed.), IFAC Conference on Cost Effective Automation in Networked Product Development and Manufacturing, IFAC-CEA'07*. Elsevier, Monterrey, Mexique, p. CDROM.
- Morel, G., Panetto, H., Zaremba, M., Mayer, F., 2003. *Manufacturing Enterprise Control and Management System Engineering: Paradigms and Open Issues*. *Annu. Rev. Control* 27, 199–209.
- Moulières-Seban, T., Bitonneau, D., Salotti, J.-M., Thibault, J.-F., Claverie, B., 2017. Human Factors Issues for the Design of a Cobotic System, in: *Savage-Knepshield, P., Chen, J. (Eds.), Advances in Intelligent Systems and Computing*. Presented at the *Advances in Human Factors in Robots and Unmanned Systems.*, Springer, Cham, pp. 375–385.
- Mourtzis, D., Fotia, S., Boli, N., Vlachou, E., 2019. Modelling and quantification of industry 4.0 manufacturing complexity based on information theory: a robotics case study. *Int. J. Prod. Res.* 57(22), 6908–6921. <https://doi.org/10.1080/00207543.2019.1571686>

- Naudet, Y., Latour, T., Guédria, W., Chen, D., 2010. Towards a systemic formalisation of interoperability. *Comput. Ind.* 61, 176–185. <https://doi.org/10.1016/j.compind.2009.10.014>
- Nof, S.Y., 2007. Collaborative control theory for e-Work, e-Production, and e-Service. *Annu. Rev. Control* 31(2), 281–292. <https://doi.org/10.1016/j.arcontrol.2007.08.002>
- Object Management Group, 2018. OMG Systems Modeling Language V1.6beta.
- Panetto, H., Iung, B., Ivanov, D., Weichhart, G., Wang, X., 2019. Challenges for the Cyber-Physical Manufacturing Enterprises of the Future. *Annu. Rev. Control* 47, 200–213. <https://doi.org/10.1016/j.arcontrol.2019.02.002>
- Panetto H., 2007. Towards a classification framework for interoperability of enterprise applications. *Int J of Comp Integrated Manufacturing* 20(8), 727–40. <https://doi.org/10.1080/09511920600996419>.
- Panetto, H., Jardim-Goncalves, R., Molina, A., 2012. Enterprise Integration and Networking: Theory and practice. *Annu. Rev. Control* 36, 284–290. <https://doi.org/10.1016/j.arcontrol.2012.09.009>
- Panetto, H., Molina, A., 2008. Enterprise Integration and Interoperability in Manufacturing Systems: trends and issues. *Comput. Ind.* 59(7), 641–646. <https://doi.org/10.1016/j.compind.2007.12.010>
- Panetto, H., Zdravkovic, M., Jardim-Goncalves, R., Romero, D., Cecil, J., Mezgár, I., 2016. New Perspectives for the Future Interoperable Enterprise Systems. *Comput. Ind.* 79, 47–63. <https://doi.org/10.1016/j.compind.2015.08.001>
- Pauker, F., Frühwirth, T., Kittl, B., Kastner, W., 2016. A Systematic Approach to OPC UA Information Model Design. *Procedia CIRP* 57, 321–326. <https://doi.org/10.1016/j.procir.2016.11.056>
- Schleipen, M., 2013. Adaptivität und semantische Interoperabilität von Manufacturing Execution Systemen (MES) (PhD Thesis). Karlsruher Institut für Technologie. <https://doi.org/10.5445/KSP/1000031462>
- Schleipen, M., Drath, R., 2009. Three-view-concept for modeling process or manufacturing plants with AutomationML, in: 2009 IEEE Conference on Emerging Technologies & Factory Automation. IEEE, 1–4.
- Schleipen, M., Gilani, S.-S., Bischoff, T., Pfrommer, J., 2016. OPC UA & Industrie 4.0 - Enabling Technology with High Diversity and Variability. *Procedia CIRP* 57, 315–320. <https://doi.org/10.1016/j.procir.2016.11.055>
- Stamper, R., Liu, K., Hafkamp, M., Ades, Y., 2000. Understanding the roles of signs and norms in organizations - a semiotic approach to information systems design. *Behav. Inf. Technol.* 19(1), 15–27. <https://doi.org/10.1080/014492900118768>
- Tayebi, S.R.M., Ostadzadeh, S.S., Mazaheri, S., 2010. Designing enterprise operating system with PRINCE2 framework, in: 2010 International Conference on Computer and Communication Technologies in Agriculture Engineering. pp. 479–482. <https://doi.org/10.1109/CCTAE.2010.5544345>
- Tsadimas, A., 2015. Model-based enterprise information system architectural design with SysML, in: Research Challenges in Information Science (RCIS), 2015 IEEE 9th International Conference On. pp. 492–497. <https://doi.org/10.1109/RCIS.2015.7128911>
- Vallespir, B., Merle, C., Doumeingts, G., 1993. GIM: A technico-economic methodology to design manufacturing systems. *Control Eng. Pract.* 1(6), 1031–1038. [https://doi.org/10.1016/0967-0661\(93\)90014-I](https://doi.org/10.1016/0967-0661(93)90014-I)
- Vallespir, B., Merle, C., Doumeingts, G., 1992. The GRAI Integrated Method: a Technico- Economical Methodology to Design Manufacturing Systems. *IFAC Proc. Vol.* 25(23), 73–78. [https://doi.org/10.1016/S1474-6670\(17\)52231-4](https://doi.org/10.1016/S1474-6670(17)52231-4)
- VDI/VDE-Gesellschaft Mess- und Automatisierungstechnik, 2013. Cyber-Physical Systems: Chancen und Nutzen aus Sicht der Automation. VDI/VDE-Gesellschaft Mess- und Automatisierungstechnik.
- Vernadat, F.B., 2002. Enterprise Modeling and Integration (EMI): Current Status and Research Perspectives. *Annu. Rev. Control* 26, 15–25.
- Vogel-Heuser, B., 2015. Cyber physical production systems/industry 4.0 - challenges in research and industrial application [WWW Document]. 41st Annu. Conf. IEEE Ind. Electron. Soc. IECON Yokohama Jpn. Plenary Talk. URL <https://mediatum.ub.tum.de/node?id=1283333> (accessed 11.5.19).
- Weichhart, G., 2015. Supporting the evolution and interoperability of organisational models with e-learning technologies. *Annu. Rev. Control* 39, 118–127. <https://doi.org/10.1016/j.arcontrol.2015.03.011>
- Weichhart, G., 2014. Requirements for Supporting Enterprise Interoperability in Dynamic Environments, in: Mertins, K., Bénaben, F., Poler, R., Bourrières, J.-P. (Eds.), Enterprise Interoperability VI, Proceedings of the I-ESA Conferences. Springer Berlin / Heidelberg, pp. 479–488. [https://doi.org/10.1007/978-3-319-04948-9\\_40](https://doi.org/10.1007/978-3-319-04948-9_40)
- Weichhart, G., Feiner, T., Sary, C., 2010. Implementing organisational interoperability – The Sudden approach. *Comput. Ind.* 61(2), 152–160. <https://doi.org/10.1016/j.compind.2009.10.011>
- Weichhart, G., Fessler, K., 2005. Organisational network models and the implications for decision support systems. *IFAC Proceedings Volumes*, 38(1), 19–24.
- Weichhart, G., Guédria, W., Naudet, Y., 2016a. Supporting Interoperability in Complex Adaptive Enterprise Systems: A Domain Specific Language Approach. *Data Knowl. Eng.* 105, 90–106. <https://doi.org/10.1016/j.datak.2016.04.001>
- Weichhart, G., Molina, A., Chen, D., Whitman, L., Vernadat, F., 2016b. Challenges and Current Developments for Sensing, Smart and Sustainable Enterprise Systems. *Comput. Ind.* 79, 34–46. <https://doi.org/10.1016/j.compind.2015.07.002>

- Yahia, E., Aubry, A., Panetto, H., 2012a. Formal measures for semantic interoperability assessment in cooperative enterprise information systems. *Comput. Ind.* 63(5), 443–457. <https://doi.org/10.1016/j.compind.2012.01.010>
- Yahia, E., Lezoche, M., Aubry, A., Panetto, H., 2012b. Semantics enactment for interoperability assessment in enterprise information systems. *Annu. Rev. Control* 36, 101–117. <https://doi.org/10.1016/j.arcontrol.2012.03.008>
- Youssef, J., Zacharewicz, G., 2019. Enterprise Operating System (EOS) in Action: Distributed Simulation of Enterprise Activities and Operations, in: 2019 Winter Simulation Conference (WSC). pp. 90–104. <https://doi.org/10.1109/WSC40007.2019.9004958>
- Youssef, J.R., Zacharewicz, G., Chen, D., 2016. Developing an Enterprise Operating System (EOS) - Requirements and Architecture, in: 2016 IEEE 25th International Conference on Enabling Technologies: Infrastructure for Collaborative Enterprises (WETICE). pp. 130–135.
- Youssef, J.R., Zacharewicz, G., Chen, D., Vernadat, F., 2017. EOS: enterprise operating systems. *Int. J. Prod. Res.* 56(8), 2714–2732. <https://doi.org/10.1080/00207543.2017.1378957>
- Zacharewicz, G., Daclin, N., Doumeingts, G., Haidar, H., 2020. Model Driven Interoperability for System Engineering. *Modelling* 1, 94–121. <https://doi.org/10.3390/modelling1020007>
- Zeid, A., Sundaram, S., Moghaddam, M., Kamarthi, S., Marion, T., 2019. Interoperability in Smart Manufacturing: Research Challenges. *Machines* 7, 21. <https://doi.org/10.3390/machines7020021>
- Zhang, F., Liu, M., Shen, W., 2017. Operation modes of smart factory for high-end equipment manufacturing in the Internet and Big Data era, in: 2017 IEEE International Conference on Systems, Man, and Cybernetics (SMC). pp. 152–157.
- Zoitl, A., Strasser, T., 2017. Distributed control applications: guidelines, design patterns, and application examples with the IEC 61499. CRC Press.