



HAL
open science

A novel second-order sliding mode control of hybrid fuel cell/super capacitors power system considering the degradation of the fuel cell

Yue Zhou, Hussein Obeid, Salah Laghrouche, Mickaël Hilairet, Abdesslem Djerdir

► To cite this version:

Yue Zhou, Hussein Obeid, Salah Laghrouche, Mickaël Hilairet, Abdesslem Djerdir. A novel second-order sliding mode control of hybrid fuel cell/super capacitors power system considering the degradation of the fuel cell. *Energy Conversion and Management*, 2021, 229, pp.113766 (10). hal-03186574

HAL Id: hal-03186574

<https://hal.science/hal-03186574>

Submitted on 3 Feb 2023

HAL is a multi-disciplinary open access archive for the deposit and dissemination of scientific research documents, whether they are published or not. The documents may come from teaching and research institutions in France or abroad, or from public or private research centers.

L'archive ouverte pluridisciplinaire **HAL**, est destinée au dépôt et à la diffusion de documents scientifiques de niveau recherche, publiés ou non, émanant des établissements d'enseignement et de recherche français ou étrangers, des laboratoires publics ou privés.



Distributed under a Creative Commons Attribution - NonCommercial 4.0 International License

1 A novel second-order sliding mode control of hybrid fuel
2 cell/super capacitors power system considering the
3 degradation of the fuel cell

4 Y.Zhou^a, H.Obeid^b, S.Laghrouche^a, M.Hilaireret^a, A.Djerdir^a

5 ^a*FEMTO-ST Institute, FCLAB, Université Bourgogne Franche-Comté, UTBM, CNRS,*
6 *Rue Ernest Thierry Mieg, F-90000 Belfort, France*

7 ^b*NORMANDIE UNIV, UNICAEN, LUSAC, 14000 Caen, France*

8 **Abstract**

9 This paper aims to design a novel control strategy of a single converter hybrid
10 power system including a Proton Exchange Membrane Fuel Cell (PEMFC)
11 and super capacitors for electric vehicle applications. The control objective
12 to be addressed in such systems is to smooth the current of PEMFC consider-
13 ing the transient power and sinusoidal disturbance from the load. Moreover,
14 in real-time applications, it is required to ensure the operation by taking
15 into account the component constraints and the degradation of PEMFC. To
16 achieve these goals, a robust nonlinear cascaded voltage control loop is de-
17 veloped in this paper. For the inner voltage loop, a second order twisting
18 controller with dynamic saturation scheme is adopted to ensure the conver-
19 gence of the DC bus voltage to its reference value as well as to attenuate the
20 oscillations on PEMFC current. For the outer voltage loop, a Proportional
21 Integral controller (PI) with anti-windup scheme is utilized to control the
22 super capacitors voltage at its desired value. Furthermore, in order to con-
23 sider the degradation of PEMFC in the controlled system, an estimation of
24 the degradation model parameters has been provided by Cubature Kalman
25 filter. Comparative Hardware-in-the-loop (HIL) tests between the proposed
26 control strategy and the traditional two PI controllers strategy for the hybrid
27 power system is performed. The results of HIL tests verified the effectiveness
28 of the proposed nonlinear control strategy.

29 *Keywords:* Hybrid electric vehicle, proton exchange membrane fuel cell
30 degradation, second order twisting controller, super capacitors,
31 Hardware-in-the-loop test bench

Preprint submitted to Energy Conversion and Management

November 21, 2020

32 1. Introduction

33 In the last few years, with the increasing pressure of energy crisis and
34 environmental protection, fuel cell technologies have received wide atten-
35 tion and application from all over the world [1–3]. Among the current fuel
36 cell technologies, the Proton Exchange Membrane Fuel Cell (PEMFC) is re-
37 garded as the most hopeful choice for vehicle and portable applications due
38 to the numerous advantages of high energy efficiency, low operating temper-
39 ature, no corrosive fluid hazards, and small size [4, 5]. In spite of these good
40 points, there are still some deficiencies caused by the inherent characteristics
41 of PEMFC [6, 7]. One of the main deficiencies of PEMFC is slow dynamic
42 due to the hydrogen delivery system. Thus, when facing a step demand of
43 load or the load with sudden perturbations, PEMFC will occur fuel starva-
44 tion phenomena, which will decrease the lifespan of membranes and influence
45 the performance of PEMFC [8]. For these transient loads mentioned above,
46 a fast dynamic auxiliary power source is necessary to be utilized. Compared
47 with battery, super capacitors (SCs) are considered as a better choice as aux-
48 iliary source in terms of high power density, good energy effectiveness and
49 high lifespan (superior than one million cycles). Furthermore, SCs are able
50 to work at even low temperature, such as $-20\text{ }^{\circ}\text{C}$ [9]. Therefore, SCs are
51 chosen as auxiliary power source while PEMFC is considered as the main
52 power source in this paper.

53 The architectures for hybrid fuel cell/SCs power system can be divided
54 into three categories: parallel, series and cascaded. Due to the benefits of
55 high reliability and low component stresses, parallel architecture is regarded
56 as the most suitable architecture [10, 11]. For parallel architectures of hybrid
57 fuel cell/SCs power system, there are three types of topologies [9, 12]. The
58 first type is fully-active topology, which consists of two DC/DC converters
59 and each converter is linked to a power source. The second type is passive
60 topology, in which no DC/DC converter is adopted. The main advantage of
61 the first type topology is flexible control performance while the disadvantage
62 is higher costs for expenses. For the second type topology, it costs less but
63 it has the lower controllability. Hence, taking into account a promising bal-
64 ance between the economy and control performance, the third type topology,
65 namely semi-active topology on the basis of a single converter is utilized in
66 this study.

67 Currently, there are various control strategies for hybrid multi-source
68 power system studied by other researchers, such as proportional integral (PI)
69 controller and passivity-based controller [13, 14]. However, among these pre-
70 vious researches on control strategies, the solution of suppressing disturbance
71 for a hybrid fuel cell/SCs power system with only one converter is not con-
72 sidered. Moreover, these mentioned control methods have not taken into
73 account the degradation phenomenon of the hybrid power system. When
74 the hybrid system operates, both the PEMFC and the super capacitors will
75 experience degradation in performance. In the long-term operation of the
76 PEMFC, the electrical resistance, exchange current, and limiting current of
77 the PEMFC will change [15]. Compared with PEMFC, the service life for
78 the super capacitors is longer to a large extent. Due to this fact, degradation
79 phenomenon of SCs is ignored in this study [16]. Therefore, the degradation
80 phenomenon of the PEMFC as well as the external disturbance should be
81 taken into account in the design of the control strategy to effectively improve
82 the dynamic response of the hybrid power system.

83 Sliding mode control approach is one of the most efficient methods for
84 controlling systems with parametric uncertainties and external disturbances
85 [17–21]. Among the sliding mode controllers, the twisting controller is the
86 conventional second order sliding mode control that is applied for perturbed
87 systems with relative degree two affected by bounded disturbance [22, 23].
88 However, this controller provides a discontinuous control signal. In order
89 to obtain a continuous control signal and still have finite time convergence,
90 the idea of relative degree extension can be used [24]. This idea consists in
91 considering the extra equation $\dot{u} = v$, where u is a real control input and v
92 is a virtual higher order sliding mode discontinuous control input.

93 The aim of this paper is to develop a robust control strategy for the
94 hybrid power system with a single converter considering the degradation
95 phenomenon of PEMFC and the external disturbance. This control strat-
96 egy should reject the sudden disturbance and decrease the oscillations on
97 fuel cell current, i.e. provide a smooth behavior of the fuel cell current.
98 To that purpose, and inspired by the idea of relative degree extension, our
99 strategy proposes the usage of twisting controller as virtual control input
100 to regulate the DC bus voltage to its reference value. Hence, this strategy
101 ensures the finite time convergence of the DC bus voltage to its reference
102 value while compensating the parametric uncertainty and the external dis-
103 turbance. Moreover, it provides a continuous control signal which leads to
104 smooth the fuel cell current and increase the lifespan of PEMFC. The main

105 contributions of this work are the following:

106 1. The degradation estimation of PEMFC is researched by the method of
107 Cubature Kalman Filter (CKF). The CKF accurately estimates the degra-
108 dation state and degradation rate for PEMFC. The estimated degradation
109 of PEMFC is applied to the control of the hybrid power system.

110 2. A robust cascaded voltage control loop is developed on the basis of
111 twisting controller and PI controller for the single converter hybrid power
112 system integrating the degradation of PEMFC. For protection purpose, the
113 constraints of fuel cell and super capacitors are taken into account in the
114 proposed control scheme.

115 3. The effectiveness of the proposed control strategy is validated by HIL
116 test experiment. Indeed, the HIL test results show that the proposed control
117 method has better performance than the traditional two PI controllers in
118 view of disturbance suppression in the hybrid fuel cell/SCs power system.

119 The organization of this paper is as follows: In section 2, the description
120 of the hybrid fuel cell/SCs power system based on a single converter is de-
121 tailed. In section 3, the degradation model of PEMFC based on the PEMFC
122 degradation experiment is firstly given. Then, the PEMFC degradation esti-
123 mation is made by CKF method. In section 4, the proposed control strategy
124 with limitation constraints for this hybrid power system is described. In
125 section 5, the HIL test results are illustrated to validate the effectiveness of
126 the proposed control strategy. Finally, in section 6, the main conclusions are
127 presented.

128 **2. Hybrid fuel cell/SCs power system**

129 *2.1. Configuration of hybrid fuel cell/SCs power system*

130 The topology of the hybrid fuel cell/SCs power system is presented in
131 Fig.1. The configuration characteristic is a parallel architecture on the ba-
132 sis of a single DC/DC converter, which has taken into account the balance
133 between the economy and control performance compared with other config-
134 urations.

135 As shown in Fig.1, in this hybrid power system, the fuel cell system which
136 provides the main power is linked to the DC bus directly and the SCs pack
137 which supplies the transient power is linked to the DC bus by a bidirectional
138 DC/DC converter.

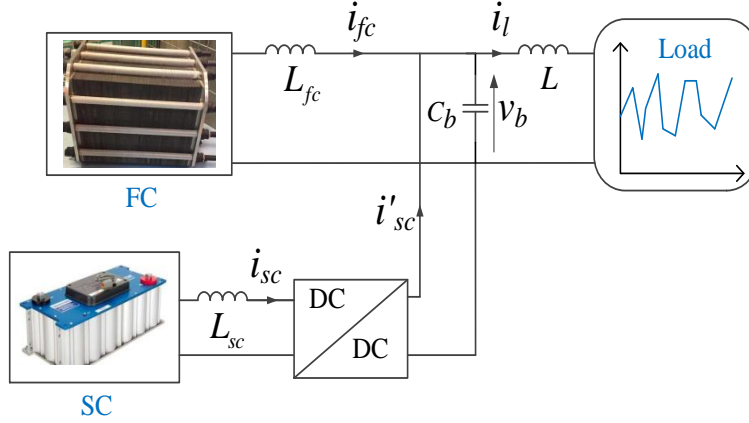

Figure 1: Hybrid system topology

139 *2.2. Model of PEMFC*

140 PEMFC is a kind of fuel cell that uses hydrogen fuel to react with air to
 141 generate electricity and heat. PEMFC is mainly developed for transport ap-
 142 plications [25]. Usually, a PEMFC stack is composed of multiple cells. Each
 143 cell includes proton exchange membrane, electrode, catalyst, gas diffusion
 144 layer, and bipolar plate [26].

145 The output characteristics of PEMFC can usually be represented by the
 146 polarization curve, as shown in Fig.2, according to [27]. When the output
 147 current is small, the output voltage of PEMFC is mainly affected by the
 148 activation polarization [28]. The speed of the activation reaction can be
 149 expressed by the exchange current of PEMFC. With the increase of the ex-
 150 change current, the electrode surface reaction will be more and more active
 151 and the activation over potential will grow smaller. When the output current
 152 is large, the output voltage of PEMFC is mainly affected by concentration
 153 polarization. The loss of voltage is mainly determined by the concentration
 154 of reactants and products [29]. The limiting current of PEMFC is usually
 155 used to indicate the intensity of the concentration polarization. The larger
 156 the limiting current is, the smaller the loss of voltage will be. Ohmic polar-
 157 ization is caused by the resistance of electrons through the electrode material
 158 and the connecting parts, and the protons pass through the membrane. The
 159 electrical resistance is usually adopted to indicate the intensity of the con-
 160 centration polarization. Therefore, the output voltage of PEMFC can be
 161 expressed as (1) [15].

$$V_{fc} = E_r - AT \ln\left(\frac{i_{fc}}{i_o}\right) - i_{fc}R_{fc} - BT \ln\left(\frac{i_{lim}}{i_{lim} - i_{fc}}\right), \quad (1)$$

162 where V_{fc} is the output voltage of PEMFC, i_{fc} is the current of PEMFC, E_r
 163 is the theoretical potential of PEMFC, i_o is the exchange current of PEMFC,
 164 i_{lim} is the limiting current of PEMFC, R_{fc} is the electrical resistance of
 165 PEMFC, A is the Tafel slope, B is the mass transfer constant, and T is the
 166 operating temperature of PEMFC.

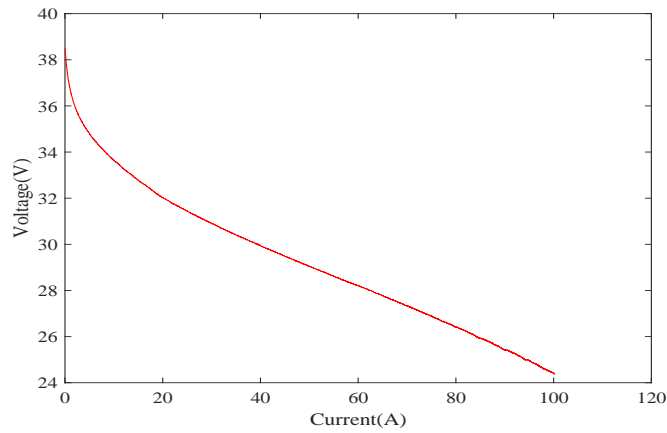

Figure 2: The polarization curve of PEMFC

167 2.3. Model of super capacitors

168 The SCs pack as a voltage source type electrical energy storage element
 169 has the advantages of high power density, long lifespan, short charging and
 170 discharging time, high reliability and so on. There are a variety of models for
 171 developing SCs pack in the existing literature [30]. In this paper, SCs pack
 172 is modeled by a voltage source connected to a pure inductor.

173 3. PEMFC degradation

174 3.1. PEMFC degradation experiment

175 The PEMFC degradation experiment is performed in the FCLAB [27], as
 176 shown in Fig.3. The membrane adopts Nafion membrane, and the electrode
 177 adopts the platinum nanoparticle catalyst. The PEMFC is operated under
 178 constant load current for 1000 h. The PEMFC operating conditions are
 179 shown in Table 1.

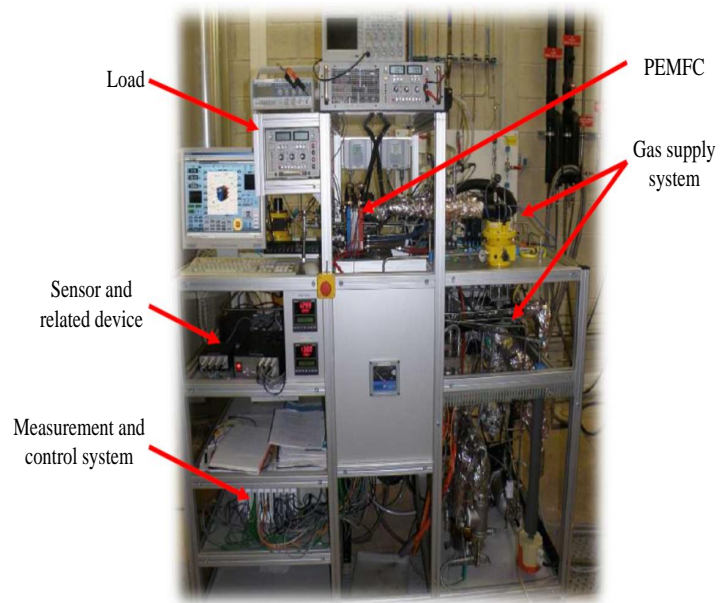

Figure 3: The PEMFC degradation testing platform

Table 1: The operating parameters of PEMFC

Parameter	Value
Number for cells	5
Active area	100 cm ²
Membrane thickness	25 μm
Platinum catalyst	0.2 mg/cm ²
GDL thickness	415 μm
Load current	70 A
Hydrogen pressure	1.3 bar
Temperature	54 °C
Relative humidity	52%

180 *3.2. PEMFC degradation model*

181 According to the literatures [31–33], resistance and limiting current vary
 182 greatly during the PEMFC degradation. The relationship between resistance
 183 and limiting current over time can be expressed as the following equations.

$$R_{fc}(t) = R_{fc}(0)(1 + \alpha(t)), \quad (2)$$

$$i_{lim}(t) = i_{lim}(0)(1 - \alpha(t)), \quad (3)$$

184

$$\alpha(t) = \beta t, \quad (4)$$

185 where α represents the state of health (the indicator of degradation of PEMFC),
 186 and β represents the speed of degradation.

187 *3.3. Degradation estimation based on Cubature Kalman Filter*

188 The nonlinear system is represented by the following equations.

$$x_{k+1} = f(x_k, u_k) + w_k, \quad (5)$$

$$y_{k+1} = h(x_{k+1}, u_k) + v_k, \quad (6)$$

189 where $x = [\alpha; \beta]$ is the system state, $y = [V_{fc}]$ is the output state of system,
 190 u_k is the input of system, f is the state transfer function from x_k to x_{k+1} , h
 191 represents the system measurement function, w_k and v_k represent the system
 192 process noise and system measurement noise respectively. The w_k and v_k are
 193 considered as the Gaussian noises with zero mean and covariance Q and R .

194 The CKF based on the spherical-radial cubature rule produces a set of
 195 cubature points to estimate the state of a nonlinear system [34, 35]. Since the
 196 cubature rule does not require derivatives, the CKF has less computational
 197 effort [36]. Compared with conventional nonlinear filters, CKF has higher
 198 filtering accuracy [34]. The basic process of CKF state estimation is shown
 199 below:

200 1). *Initialization: initialize state and covariance*

$$\hat{x}_0 = E[x_0], P_0 = Var[x_0]. \quad (7)$$

201 2). *Calculate cubature points*

$$P_k = S_k S_k^T, \quad (8)$$

202

$$x_k^i = S_k \gamma_i + \hat{x}_k, \quad i = 1, 2, \dots, 2n, \quad (9)$$

203 where n is the dimension of state variables, γ_i is a set of cubature points.

$$\gamma_i = \begin{cases} \sqrt{n} E_i, & i = 1, 2, \dots, n \\ -\sqrt{n} E_i, & i = n + 1, n + 2, \dots, 2n \end{cases} \quad (10)$$

204 where E_i is the unit matrix.205 3). *Cubature points propagation*

$$x_{k+1|k}^i = f(x_k^i, u_k). \quad (11)$$

206 4). *State prediction*

$$\hat{x}_{k+1|k} = \frac{1}{2n} \sum_{i=1}^{2n} x_{k+1|k}^i, \quad (12)$$

207

$$\bar{p}_k = \frac{1}{2n} \sum_{i=1}^{2n} x_{k+1|k}^i (x_{k+1|k}^i)^T - \hat{x}_{k+1|k} (\hat{x}_{k+1|k})^T + Q. \quad (13)$$

208 5). *Cubature points calculation*

$$\bar{p}_k = S_{k+1|k} S_{k+1|k}^T, \quad (14)$$

209

$$X_{k+1|k}^i = S_{k+1|k} \gamma_i + \hat{x}_{k+1|k}. \quad (15)$$

210 6). *Cubature points propagation*

$$y_{k+1}^i = h(X_{k+1|k}^i, u_k). \quad (16)$$

211 7). *Measurement update*

$$\hat{y}_{k+1} = \frac{1}{2n} \sum_{i=1}^{2n} y_{k+1}^i, \quad (17)$$

212

$$p_{yy} = \frac{1}{2n} \sum_{i=1}^{2n} y_{k+1}^i (y_{k+1}^i)^T - \hat{y}_{k+1} \hat{y}_{k+1}^T + R, \quad (18)$$

213

$$p_{xy} = \frac{1}{2n} \sum_{i=1}^{2n} X_{k+1|k}^i (y_{k+1}^i)^T - \hat{x}_{k+1|k} \hat{y}_{k+1}^T. \quad (19)$$

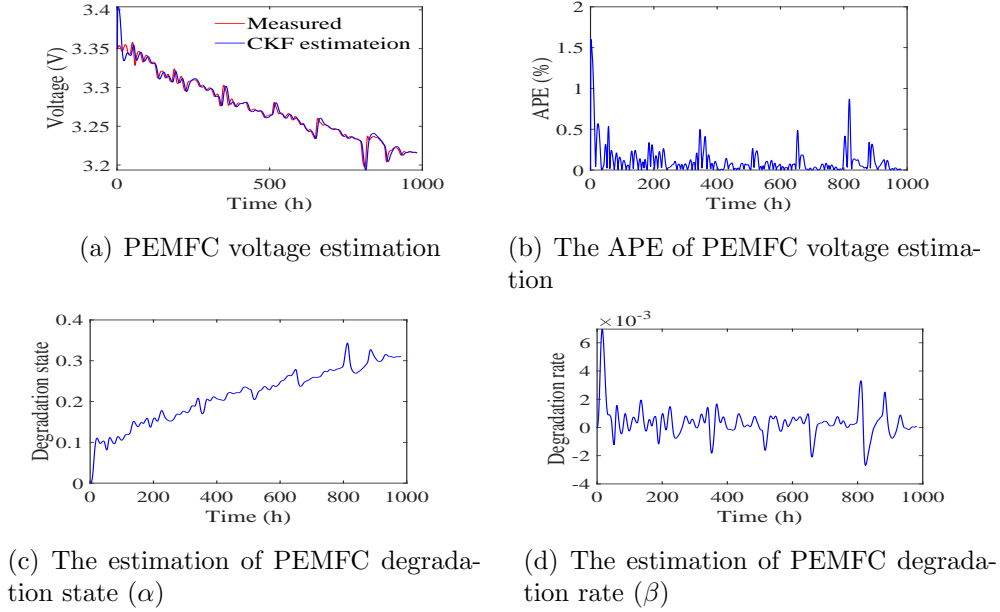

Figure 4: Degradation estimation based on CKF

214 8). *State and covariance update: Estimate the Kalman gain K , state \hat{x}_{k+1}*
 215 *and covariance P_{k+1}*

$$K = p_{xy}p_{yy}^{-1}, \quad (20)$$

216 $\hat{x}_{k+1} = \hat{x}_{k+1|k} + K(y_{k+1} - \hat{y}_{k+1}),$ (21)

217 $P_{k+1} = \bar{p}_k - Kp_{yy}K^T.$ (22)

218 The degradation state α and degradation rate β of the PEMFC degrada-
 219 tion model are estimated by the CKF. As shown in Fig.4(a), the estimated
 220 voltage is close to the measured voltage of PEMFC. As shown in Fig.4(b),
 221 the maximum Absolute Percentage Error (APE) between the measurement
 222 voltage and CKF estimated voltage is less than 1.8%. The mean APE be-
 223 tween the measurement voltage and CKF estimated voltage is about 0.11%.
 224 As shown in Fig.4(c), with the operation of the PEMFC, the degradation
 225 state of the PEMFC increases. As shown in Fig.4(d), the mean degradation
 226 rate is about 0.0003. The estimated degradation state and degradation rate
 227 are applied to design the control systems.

228 **4. Design of control strategy**

229 *4.1. Control Structure*

230 The control structure of hybrid fuel cell/SCs power system is illustrated
 231 in Fig.5. The proposed control strategy is on the basis of a cascaded control
 232 loop.

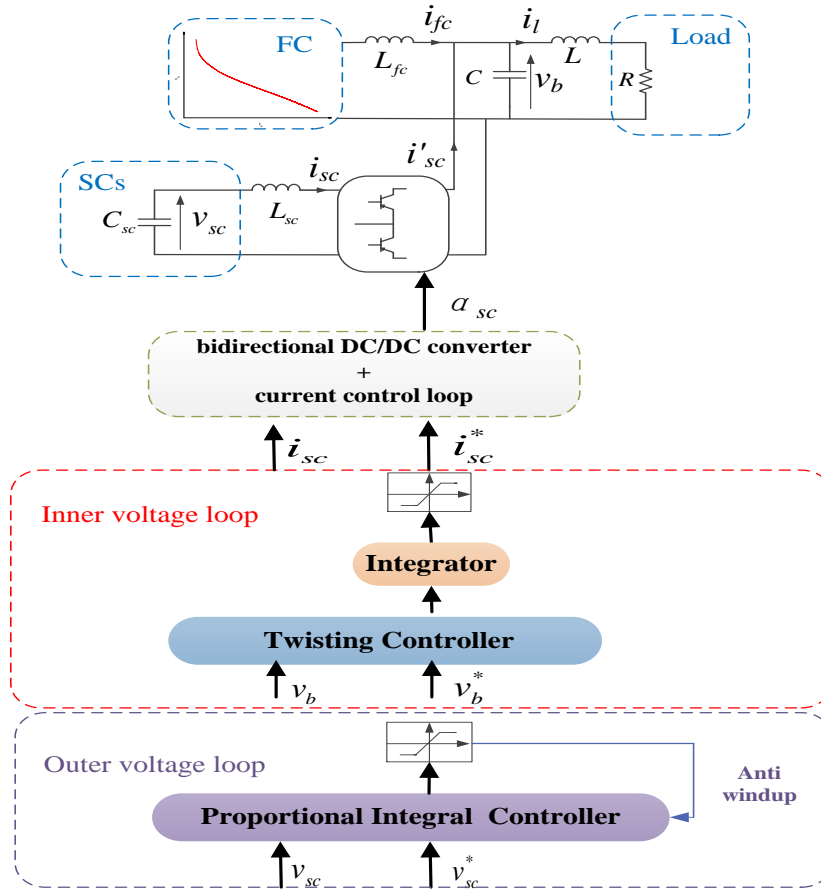

Figure 5: Control structure diagram

233 As shown in Fig.5, the SCs reference current i_{sc}^* is transmitted by the
 234 DC bus and the SCs current i_{sc} is regulated by the bidirectional DC/DC
 235 controller with its own current controller. In the inner voltage loop, a twisting
 236 controller with an integrator and saturation functions is proposed in order to
 237 guarantee the convergence of the voltage of the DC bus at its reference value,

238 while compensating the external perturbation; in the outer voltage loop, a
 239 PI controller with an anti-windup scheme is utilized in order to regulate the
 240 voltage of SCs at its nominal condition.

241 The complete hybrid fuel cell/ SCs system can be expressed as following
 242 equations:

$$\frac{d}{dt}v_b(t) = \frac{i_{fc}(t) + (1 - a_{sc}(t))i_{sc}(t) - i_l(t)}{C}, \quad (23)$$

$$\frac{d}{dt}v_{sc}(t) = -\frac{i_{sc}(t)}{C_{sc}}, \quad (24)$$

$$\frac{d}{dt}i_{sc}(t) = \frac{v_{sc}(t) - v_b(t)(1 - a_{sc}(t))}{L_{sc}}, \quad (25)$$

$$i_{fc}(t) = \frac{V_{fc}(t) - v_b(t)}{R_{fc}(t)}, \quad (26)$$

243 where a_{sc} is the duty cycle of the bidirectional DC/DC converter, $i_{fc}(t)$
 244 is the current of fuel cell, $i_{sc}(t)$ is the current of SCs, $i_l(t)$ is the current
 245 of the load, $v_{sc}(t)$ is the voltage of SCs and $v_b(t)$ is the DC bus voltage,
 246 with state space $x(t) = [v_b; v_{sc}; i_{sc}]^T$, control input $u(t) = a_{sc}$, measurements
 247 $y(t) = [i_{fc}; i_{sc}; i_l; v_b; v_{sc}]$.

248 Considering the degradation of fuel cell, according to the degradation
 249 model detailed in section 3, $V_{fc}(t)$ in equation (26) can be rewritten as fol-
 250 lowing equation:

$$V_{fc}(t) = E_r - AT \ln\left(\frac{i_{fc}(t)}{i_o}\right) - i_{fc}(t)R_{fc}(0)(1 + \alpha(t)) - BT \ln\left(\frac{i_{lim}(0)(1 - \alpha(t))}{i_{lim}(0)(1 - \alpha(t)) - i_{fc}(t)}\right), \quad (27)$$

251 where the degradation state $\alpha(t)$ can be expressed as βt , in which β represents
 252 the degradation speed of fuel cell.

253 In order to design the twisting controller for the inner voltage loop, the
 254 bandwidth of the bidirectional DC/DC converter current control loop is as-
 255 sumed as decoupled to the inner voltage loop. Thus, it can be deduced that
 256 the controller current of SCs is equal to the reference current of SCs which
 257 is calculated from the inner voltage loop on the basis of twisting controller.
 258 Under the previous assumption, the following equation can be obtained, as
 259 shown in equation (28).

$$L_{sc} \frac{d}{dt} i_{sc}(t) = 0. \quad (28)$$

260 Substitute equation (28) into the equation (25), then:

$$v_{sc}(t) - v_b(t)(1 - a_{sc}(t)) = 0. \quad (29)$$

261 The above equation can be represented as follows.

$$a_{sc}(t) = 1 - \frac{v_{sc}(t)}{v_b(t)}. \quad (30)$$

262 Thus, the expression of the DC bus voltage is shown as equation (31)
 263 and (32), in which $i'_{sc}(t)$ is the new input variable in this reduced system
 264 currently.

$$C \frac{d}{dt} v_b(t) = i_{fc}(t) + i'_{sc}(t) - i_l(t), \quad (31)$$

265 with

$$i'_{sc}(t) = \frac{v_{sc}(t)}{v_b(t)} i_{sc}(t). \quad (32)$$

266 4.2. Inner voltage controller

267 The main objective of the inner voltage loop is to regulate the DC bus
 268 voltage to its reference value while rejecting the external disturbance and
 269 taking into account the degradation of the PEMFC.

270 In this work, the inner voltage controller utilizes the idea of relative de-
 271 gree extension where the virtual control input is chosen as twisting controller.
 272 This controller is well-known by its robustness in presence of system uncer-
 273 tainty and unexpected fluctuations [37]. Indeed, it provides a discontinuous
 274 control signal and ensures the finite time convergence of the state variable
 275 and its derivative to the origin for systems with relative degree two [38, 39].
 276 It has been widely used in different areas, such as power systems, power
 277 converters, electrical drives and robot manipulators [40].

278 In the considered hybrid power system, the dynamics of the DC bus volt-
 279 age can be expressed as a first order disturbed system as shown in equation
 280 (31). Due to that and in order to implement the twisting controller algo-
 281 rithm, the idea of relative degree extension has been used. The application
 282 of this idea will be described now in detail.

283 Let us first define $\phi(t) = i_{fc}(t) + i'_{sc}(t) - i_l(t)$ as a new auxiliary state, then
 284 the dynamics of the DC bus voltage given by equation (31) can be expressed
 285 as

$$\begin{aligned} C \frac{d}{dt} v_b(t) &= \phi(t), \\ \dot{\phi}(t) &= v(t), \end{aligned} \quad (33)$$

286 where $v(t)$ is the new virtual control input to be designed.

287 Now, let us define the sliding variable $s_{vb}(t)$ and its derivative $s_\phi(t)$ for
 288 the DC bus voltage as follows

$$\begin{aligned} s_{vb}(t) &= C(v_b(t) - v_b^*(t)), \\ s_\phi(t) &= \phi(t) - C\dot{v}_b^*(t), \end{aligned} \quad (34)$$

289 where $v_b^*(t)$ is the reference DC bus voltage obtained from the outer voltage
 290 loop and that will be designed later. Taking the first derivative of $s_{vb}(t)$ and
 291 $s_\phi(t)$, we obtain

$$\begin{aligned} \dot{s}_{vb} &= s_\phi, \\ \dot{s}_\phi &= \delta(t) + v(t), \end{aligned} \quad (35)$$

292 where $\delta(t)$ is the total disturbance caused by parameter uncertainties, i.e.
 293 the degradation of the PEMFC and the external disturbance. For example,
 294 if $\ddot{v}_b^*(t)$ is not compensated, we would have $\delta(t) = -C\ddot{v}_b^*(t)$.

295 For system (35), the standard twisting control algorithm given by [22]

$$v(t) = -K_1 \text{sign}(s_{vb}) - K_2 \text{sign}(s_\phi), \quad (36)$$

296 drives both s_{vb} and s_ϕ to zero in a finite time, i.e. it provides the convergence
 297 of the DC bus voltage to its reference value if the control gains are chosen as
 298 $K_1 = \Upsilon$ and $K_2 = 0.5\Upsilon$ where $\Upsilon > 2\delta_{max}$ with $|\delta(t)| \leq \delta_{max}$.

299 The proof of the above statement using strict Lyapunov functions can be
 300 founded in [23, 41]. On the other hand, one can follow [22] and ensure the
 301 convergence of the twisting algorithm using a geometrical proof.

302 It should be noted that the application of this controller requires the
 303 assumption that the information of the load current is available. This as-
 304 sumption is frequently used in such domain as we can see in [4, 42].

305 *4.3. Outer voltage controller*

306 The main objective of the outer voltage loop focuses on controlling the
 307 SCs voltage by controlling the current of fuel cell indirectly and thereupon
 308 the DC bus voltage. As shown in Fig.5, the fuel cell current will be indi-
 309 rectly regulated by the variation of the DC bus voltage so as to keep the SCs
 310 current at its desired operating value. Referring to equation (1), the rela-
 311 tionship between $i_{fc}(t)$ and $v_b(t)$ is nonlinear. Thus, the outer voltage loop is
 312 considered to utilize a small-signal model approach, which means that near
 313 the operating point of fuel cell, the linearization is made for equation (1).
 314 Then, the variation relationship between $\delta i_{fc}(t)$ and $\delta v_b(t)$ can be presented
 315 as follows.

$$\delta i_{fc}(t) = -H\delta v_b(t), \quad (37)$$

316 where H is a positive parameter with the range of $[H_{min}, H_{max}]$.

317 The outer voltage controller is on the basis of PI controller, which is
 318 designed as follows.

$$v_b^* = k_p(v_{sc}^* - v_{sc}) + k_i \int (v_{sc}^* - v_{sc}) dt, \quad (38)$$

319 where k_p is the gain of the proportional term and k_i is the gain of the integral
 320 term.

321 *4.4. Limitation constraints*

322 In order to ensure the security of fuel cell and SCs, some limitation con-
 323 straints are taken into account in the proposed control strategy. These con-
 324 straints are integrated as dynamic saturation functions for the inner and the
 325 outer voltage loops.

326 In this paper, the constraint of SCs current is a dynamic saturation pro-
 327 cess, which can be illustrated in Fig.6.

328 The security voltage range of SCs is presented in equation (39). Within
 329 this security range, the security thresholds of SCs reference voltage are de-
 330 fined as equation (40) so as to guarantee the safe operation of SCs in charge
 331 mode and in discharge mode.

$$v_{sc} \in [v_{sc.min}, v_{sc.max}] \quad (39)$$

$$v_{sc}^* \in [v_{sc.low}, v_{sc.high}] \quad (40)$$

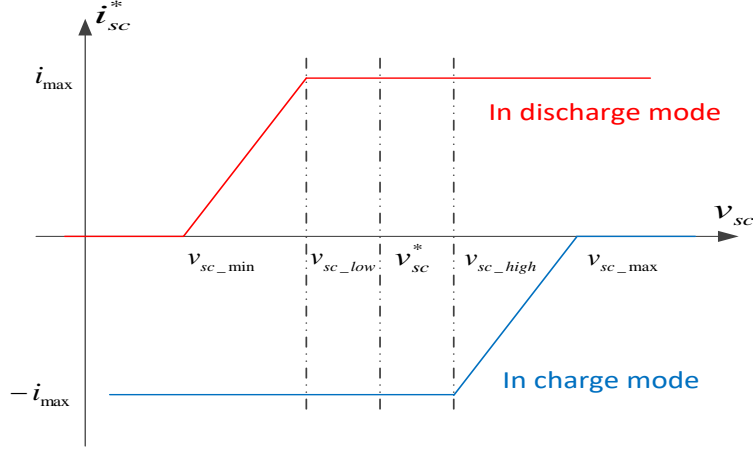

Figure 6: Limitation constraints of SCs current

332 In Fig.6, the red curve shows the SCs operates in discharge mode. If
 333 SCs voltage reaches v_{sc_low} , the absolute value of SCs reference current will
 334 decrease very soon until SCs voltage reaches v_{sc_min} . On the other hand, the
 335 blue curve shows the SCs operates in charge mode. When the SCs voltage
 336 reaches v_{sc_high} , the absolute value of SCs reference current will drop rapidly
 337 until SCs voltage reaches v_{sc_max} .

338 The limitations of SCs reference current mentioned above are presented
 339 as mathematical expressions equation (41) and (42). These two constraints
 340 are integrated in the saturation scheme of the inner voltage loop so as to
 341 avoid the occurrence of integral saturation.

$$i_{sc_max_cha} = i_{max} \cdot \max \left(-1, \min \left(0, \frac{v_{sc} - v_{sc_max}}{v_{sc_max} - v_{sc_high}} \right) \right) \quad (41)$$

$$i_{sc_max_dis} = i_{max} \cdot \min \left(1, \max \left(0, \frac{v_{sc} - v_{sc_min}}{v_{sc_low} - v_{sc_min}} \right) \right) \quad (42)$$

342 Moreover, the constraints of fuel cell current are integrated in the anti-
 343 windup scheme of the outer voltage loop in order to prevent the integral satu-
 344 ration. Due to the fact that the fuel cell is linked to the load directly, the cur-
 345 rent of fuel cell cannot be controlled directly. Therefore, the DC bus voltage
 346 is adjusted between the dynamic security thresholds $[v_{b_min_dyn}, v_{b_max_dyn}]$, so
 347 as to limit the fuel cell discharge current in the security range $[v_{b_min}, v_{b_max}]$,
 348 as shown in the following equations.

$$v_{b_max_dyn} = v_b^* + K_{i_{fc}} i_{fc}(t), \quad (43)$$

$$v_{b_min_dyn} = v_b^* + K_{i_{fc}}(i_{fc}(t) - i_{fc_max_dis}). \quad (44)$$

349 5. HIL test results

350 The proposed control strategy for the single converter hybrid fuel cell/SCs
 351 power system taking into consideration the PEMFC degradation is validated
 352 by a HIL test bench. This test bench consists of two dSPACE DS1104 real-
 353 time board cards as shown in Fig.7. One dSPACE is used as hardware
 354 controller to implement the proposed control strategy and to validate its fea-
 355 sibility in real time. On the other hand, the other one is utilized as emulator
 356 to emulate the single converter hybrid fuel cell/SCs power system. For the
 357 realization of the HIL test bench, we have used a sampling frequency of 10
 358 kHz for both dSPACE cards [43]. The degradation rate estimated in section
 359 3 is adopted in the HIL test system. For SCs, the initial reference voltage
 360 v_{sc_ref} is set as 125V, v_{sc_min} and v_{sc_low} are set as $0.5v_{sc_ref}$ and $0.75v_{sc_ref}$
 361 respectively, v_{sc_max} and v_{sc_high} are set as 136V and 131V respectively. For
 362 fuel cell, the discharge limitation current $i_{fc_max_dis}$ is set as 80A. For DC bus
 363 voltage, the security range is set as [26V,38V].

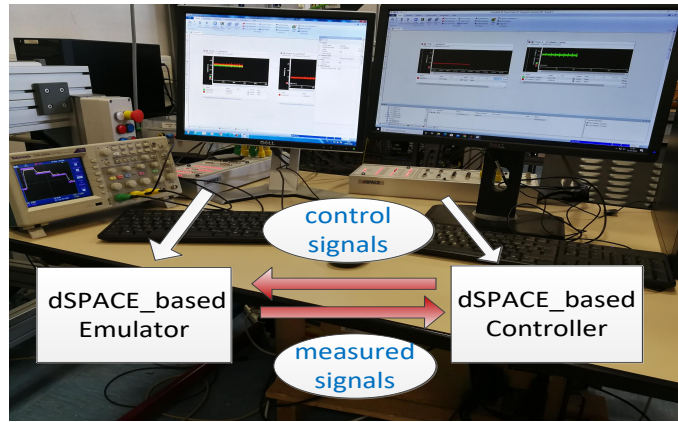

Figure 7: Scheme of HIL test system

364 In this section, the HIL test results are carried out by connecting the
 365 load affected by perturbations to the hybrid fuel cell/SCs power sources.

366 The load current curve adopted in this HIL test is a superposition of a step
367 demand current curve and a sinusoidal perturbation current curve. The
368 frequency and amplitude of the sinusoidal perturbation current are 7.5Hz
369 and 3A respectively.

370 5.1. HIL test results of the proposed control strategy

371 The HIL test results of the proposed control strategy for hybrid fuel
372 cell/SCs power system are shown in Fig.8 and Fig.9. According to these
373 two figures, after utilizing the proposed control strategy, the perturbations
374 on fuel cell current have been attenuated to a large extent due to the fact
375 that SCs absorb the transient and sinusoidal perturbations effectively. The
376 control strategy proposed in this paper can smooth the behavior of fuel cell
377 current, which benefits to the lifespan of PEMFC.

378 Fig.8 presents the condition in nominal mode, in which all of the current
379 and voltage values are in the allowed range. The dynamic DC bus voltage
380 thresholds keep constant all the time, which means the saturation function
381 is not activated. As shown in Fig.8(a),(c),(d), at the time of 10s and 140s,
382 with the sudden increase of the load current, SCs operate as the auxiliary
383 power source discharges rapidly and provide the current in transient process.
384 Subsequently, the fuel cell with lower dynamic operates as the main power
385 source. On the other hand, when the load current decreases suddenly at the
386 time of 70s and 210s, the mode of SCs changes to the charge mode quickly.
387 After that, fuel cell works as the main power source. Moreover, the value
388 of SCs voltage is regulated at the desired security operating range and the
389 convergence of DC bus voltage is validated for the proposed control method.

390 Fig.9 presents the condition when the fuel cell discharge current reaches
391 the limitation threshold. In this condition, the saturation function is acti-
392 vated so as to protect the fuel cell. As shown in Fig.9(c), from 10s to 70s,
393 the fuel cell current is limited at $i_{fc_max_dis}$, namely the value of 80A.

394 5.2. Comparison with HIL test results of two PI controllers method

395 In order to make further analysis of the proposed control strategy, the
396 HIL tests of the same hybrid fuel cell/SCs power system with two PI con-
397 trollers are implemented as well. In other words, the HIL tests are made after
398 replacing the twisting controller with the integrator in inner voltage loop by a
399 traditional PI controller and the outer voltage loop adopts PI controller still.
400 Fig.10 presents the comparison HIL test results of fuel cell current between
401 the traditional method on the basis of two PI controllers and the proposed

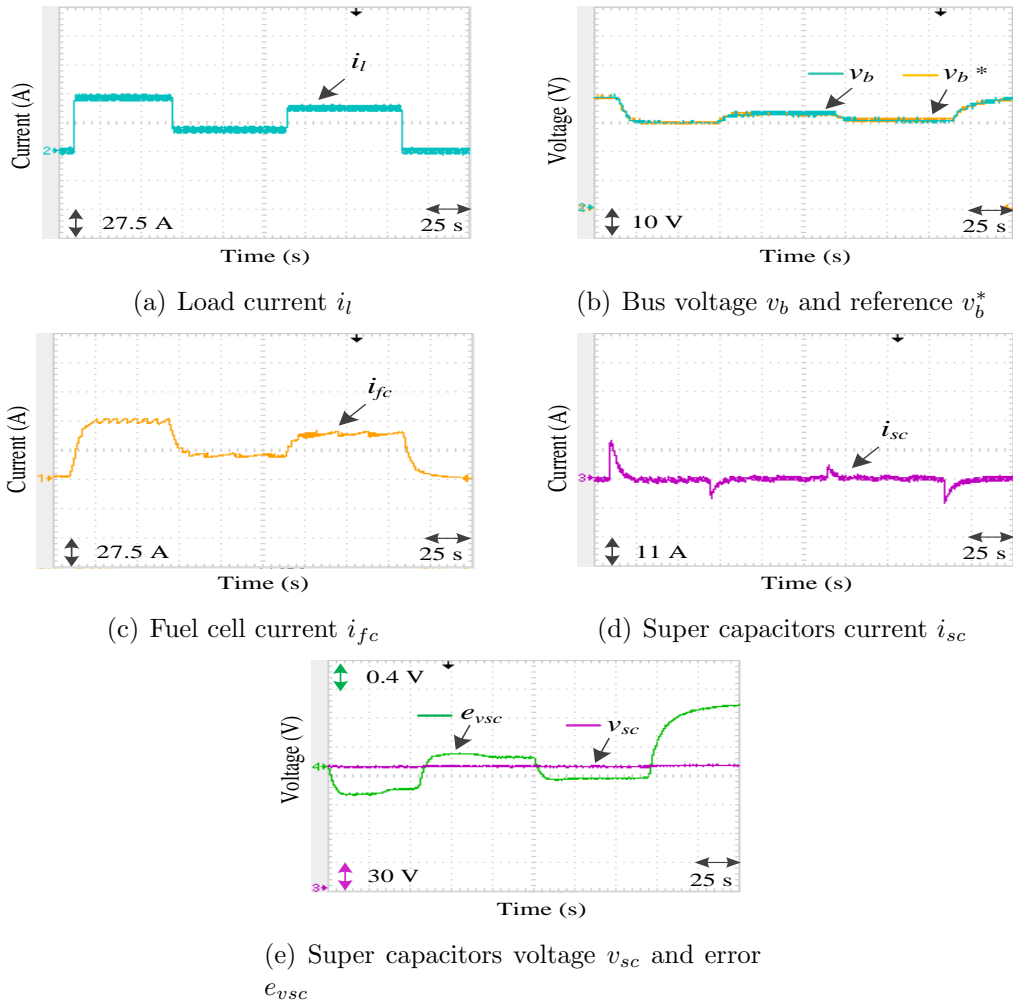

Figure 8: HIL test results in nominal mode

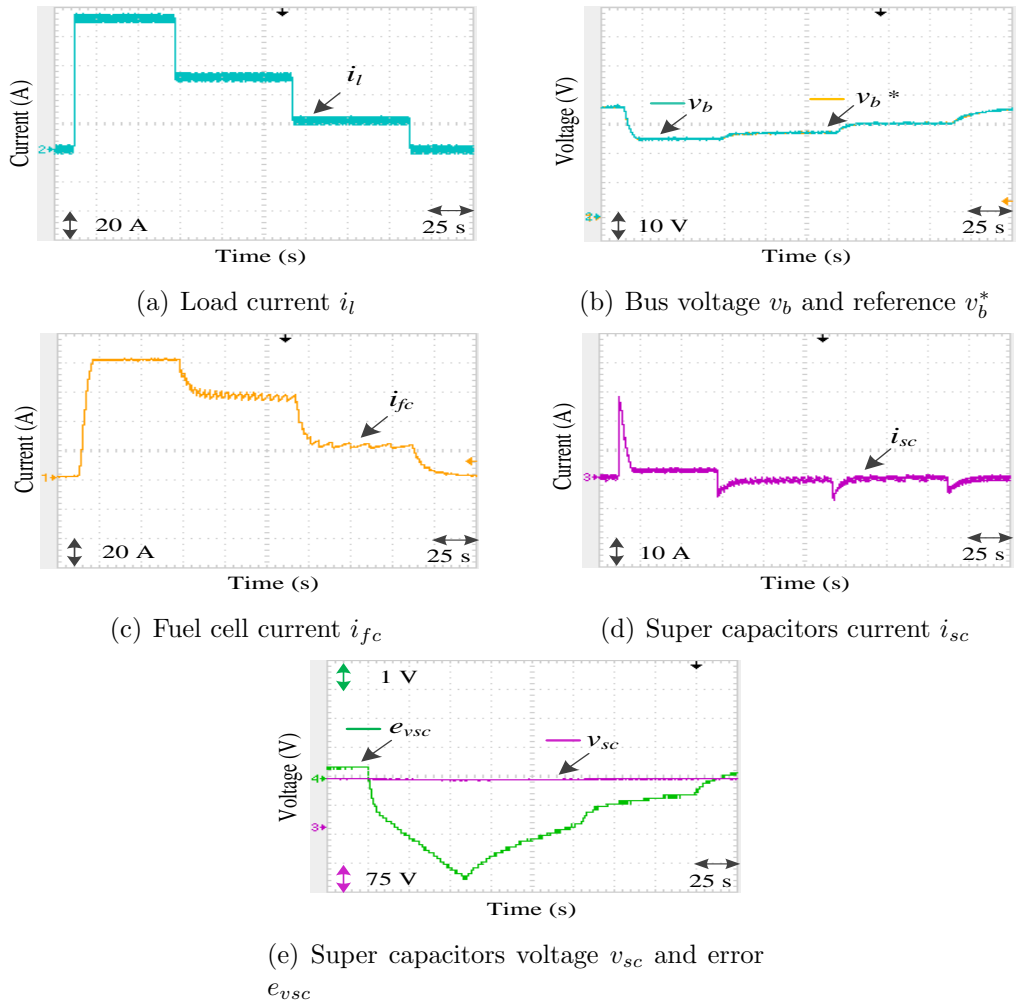

Figure 9: HIL test results in discharge limitation mode

402 control method which is based on one twisting controller used in inner volt-
403 age loop and one PI controller used in the outer loop. It can be seen that the
404 oscillations of fuel cell current by the proposed method are smaller than two
405 PI method. For proposed method, the oscillation amplitude of the sinusoidal
406 oscillations on the fuel cell current is 0.165A; for two PI method, the oscilla-
407 tion amplitude of the sinusoidal oscillations on the fuel cell current is 0.86A.
408 That is to say, the fuel cell current of the proposed method is smoother than
409 the method of two PI controllers.

410 The change of fuel cell current will bring challenges to fuel cell water
411 management, thermal management and gas management [44, 45]. Moreover,
412 the changing fuel cell current will accelerate the degradation of the fuel cell
413 membrane, catalyst and gas diffusion layer [45, 46]. For example, the chang-
414 ing current will cause the catalyst particles to become coarse and lead to the
415 change of the oxide coverage degree of platinum and carbon, and the surface
416 hydrophobicity [47, 48]. In addition, the durability comparison experiments
417 show that the degradation rate of fuel cells under constant current is lower
418 than that of fuel cells under dynamic current with oscillations [49]. Overall,
419 the smoother fuel cell current results in the lower degradation rate, which is
420 better for the lifespan of fuel cells. Hence, compared with two PI controllers
421 method, our proposed method can increase the lifespan of fuel cell better.

422 Therefore, the proposed method in this paper based on the combination
423 of twisting controller and PI controller is better than the control method
424 based on two PI controllers in terms of perturbation suppression.

425 6. Conclusion

426 In this paper, considering the degradation of PEMFC, a novel second
427 order sliding mode control strategy for hybrid fuel cell/super capacitors power
428 system on the basis of only one converter has been presented. In this hybrid
429 power system, fuel cell and super capacitors are performed as the main source
430 and auxiliary source respectively. The degradation state and degradation
431 rate of the PEMFC degradation model are estimated using the CKF method
432 and are taken into account in the hybrid system. In this hybrid system,
433 the proposed control strategy utilizes the twisting controller for the inner
434 voltage loop and the proportional integral controller for the outer voltage
435 loop. Moreover, some limitation constraints are taken into account so as to
436 protect and increase the lifespan of the hybrid power sources. Finally, the
437 effectiveness of the proposed control strategy is verified by HIL test bench.

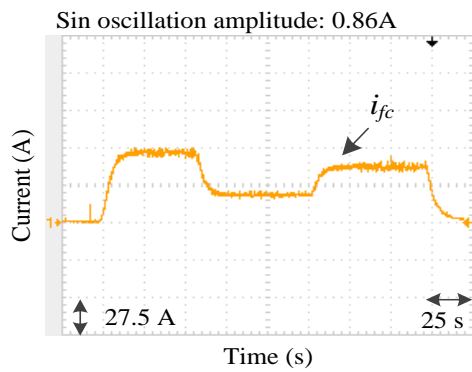

(a) 2PI - in nominal mode

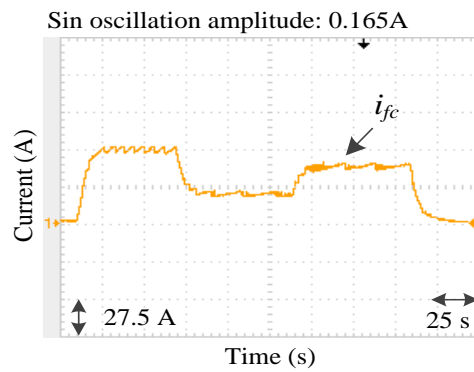

(b) Proposed method - in nominal mode

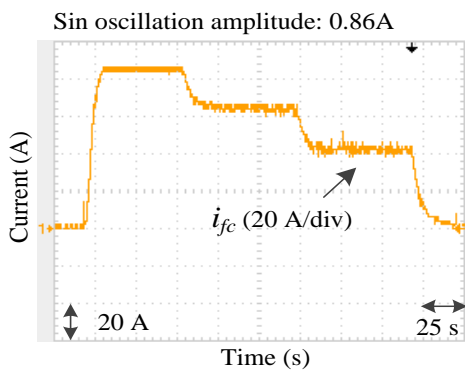

(c) 2PI - in discharge limitation mode

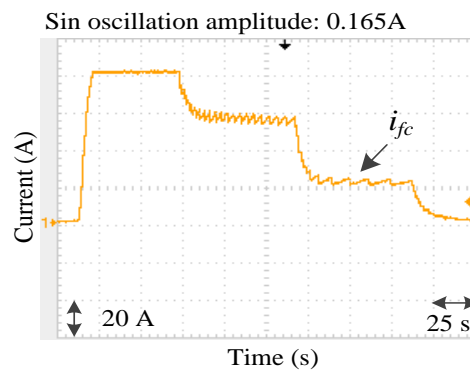

(d) Proposed method - in discharge limitation mode

Figure 10: Comparison of the proposed method and two PI controllers method - Fuel cell current i_{fc}

438 In future research work, there are two aspects which will be considered.
439 Firstly, consider to design the adaptive version of the current algorithm in
440 order to avoid overestimating the gains. Secondly, try to propose an algo-
441 rithm that does not need the information of load current which is considered
442 as an unknown perturbation.

443 References

- 444 [1] Toghyani, S., Afshari, E., Baniasadi, E.. Performance evaluation
445 of an integrated proton exchange membrane fuel cell system with ejec-
446 tor absorption refrigeration cycle. *Energy Conversion and Management*
447 2019;185:666–677.
- 448 [2] Kolli, A., Gaillard, A., De Bernardinis, A., Bethoux, O., Hissel, D.,
449 Khatir, Z.. A review on dc/dc converter architectures for power fuel cell
450 applications. *Energy Conversion and Management* 2015;105:716–730.
- 451 [3] Sorrentino, M., Cirillo, V., Nappi, L.. Development of flexible pro-
452 cedures for co-optimizing design and control of fuel cell hybrid vehicles.
453 *Energy Conversion and Management* 2019;185:537–551.
- 454 [4] Hilairret, M., Bethoux, O., Ghanes, M., Tanasa, V., Barbot, J.P.,
455 Normand-Cyrot, M.D.. Experimental validation of a sampled-data
456 passivity-based controller for coordination of converters in a fuel cell
457 system. *IEEE Transactions on Industrial Electronics* 2014;62(8):5187–
458 5194.
- 459 [5] Seyhan, M., Akansu, Y.E., Murat, M., Korkmaz, Y., Akansu, S.O..
460 Performance prediction of pem fuel cell with wavy serpentine flow chan-
461 nel by using artificial neural network. *International Journal of Hydrogen*
462 *Energy* 2017;42(40):25619–25629.
- 463 [6] Budak, Y., Devrim, Y.. Investigation of micro-combined heat and
464 power application of pem fuel cell systems. *Energy Conversion and*
465 *Management* 2018;160:486–494.
- 466 [7] Authayanun, S., Hacker, V.. Energy and exergy analyses of a stand-
467 alone ht-pemfc based trigeneration system for residential applications.
468 *Energy conversion and management* 2018;160:230–242.

- 469 [8] Chen, K., Laghrouche, S., Djerdir, A.. Degradation model of proton
470 exchange membrane fuel cell based on a novel hybrid method. *Applied*
471 *Energy* 2019;252:113439.
- 472 [9] Hilairret, M., Bethoux, O., Azib, T., Talj, R.. Interconnection and
473 damping assignment passivity-based control of a fuel cell system. In:
474 2010 IEEE International Symposium on Industrial Electronics. IEEE;
475 2010, p. 219–224.
- 476 [10] Tiefensee, F., Hilairret, M., Normand-Cyrot, D., Bethoux, O..
477 Sampled-data energetic management of a fuel cell/supercapacitor sys-
478 tem. In: 2010 IEEE Vehicle Power and Propulsion Conference. IEEE;
479 2010, p. 1–6.
- 480 [11] Mane, S., Kazi, F., Singh, N.. Fuel cell and ultra-capacitor based
481 hybrid energy control using ida-pbc methodology. In: 2015 International
482 Conference on Industrial Instrumentation and Control (ICIC). IEEE;
483 2015, p. 879–884.
- 484 [12] Azib, T., Bethoux, O., Remy, G., Marchand, C.. Structure and control
485 strategy for a parallel hybrid fuel cell/supercapacitors power source. In:
486 2009 IEEE Vehicle Power and Propulsion Conference. IEEE; 2009, p.
487 1858–1863.
- 488 [13] Talj, R., Ortega, R., Astolfi, A.. Passivity and robust pi control
489 of the air supply system of a pem fuel cell model. *Automatica*
490 2011;47(12):2554–2561.
- 491 [14] Hilairret, M., Bethoux, O.. A passive controller-observer for coordi-
492 nation of converters in a fuel cell system. In: 2011 IEEE International
493 Symposium on Industrial Electronics. IEEE; 2011, p. 2209–2214.
- 494 [15] Li, H., Ravey, A., NDiaye, A., Djerdir, A.. Online adaptive equivalent
495 consumption minimization strategy for fuel cell hybrid electric vehicle
496 considering power sources degradation. *Energy Conversion and Man-*
497 *agement* 2019;192:133–149.
- 498 [16] Li, H., Ravey, A., N’Diaye, A., Djerdir, A.. A novel equivalent
499 consumption minimization strategy for hybrid electric vehicle powered
500 by fuel cell, battery and supercapacitor. *Journal of Power Sources*
501 2018;395:262–270.

- 502 [17] Laghrouche, S., Plestan, F., Glumineau, A.. Higher order sliding mode
503 control based on integral sliding mode. *Automatica* 2007;43(3):531–537.
- 504 [18] Sanchez, T., Moreno, J.A., Fridman, L.M.. Output feedback contin-
505 uous twisting algorithm. *Automatica* 2018;96:298–305.
- 506 [19] Han, T., Hu, Q.. Robust autopilot design for STT missiles with multiple
507 disturbances using twisting control. *Aerospace Science and Technology*
508 2017;70:428–434.
- 509 [20] Boiko, I.M.. On frequency-domain criterion of finite-time conver-
510 gence of second-order sliding mode control algorithms. *Automatica*
511 2011;47(9):1969–1973.
- 512 [21] Shtessel, Y.B., Shkolnikov, I.A., Levant, A.. Smooth second-order slid-
513 ing modes: Missile guidance application. *Automatica* 2007;43(8):1470–
514 1476.
- 515 [22] Levant, A.. Sliding order and sliding accuracy in sliding mode control.
516 *International journal of control* 1993;58(6):1247–1263.
- 517 [23] Sánchez, T., Moreno, J.A.. Lyapunov functions for twisting and ter-
518 minal controllers. In: 2014 13th International Workshop on Variable
519 Structure Systems (VSS). IEEE; 2014, p. 1–6.
- 520 [24] Kamal, S., Moreno, J.A., Chalanga, A., Bandyopadhyay, B., Frid-
521 man, L.M.. Continuous terminal sliding-mode controller. *Automatica*
522 2016;69:308–314.
- 523 [25] Chen, K., Laghrouche, S., Djerdir, A.. Degradation prediction of
524 proton exchange membrane fuel cell based on grey neural network model
525 and particle swarm optimization. *Energy Conversion and Management*
526 2019;195:810–818.
- 527 [26] Jouin, M., Gouriveau, R., Hissel, D., Péra, M.C., Zerhouni, N..
528 Joint particle filters prognostics for proton exchange membrane fuel cell
529 power prediction at constant current solicitation. *IEEE Transactions on*
530 *reliability* 2015;65(1):336–349.

- 531 [27] Gouriveau, R., Hilairet, M., Hissel, D., Jemei, S., Jouin, M.,
532 Lechartier, E., et al. IEEE PHM 2014 data challenge: Outline, ex-
533 periments, scoring of results, winners. IEEE 2014 PHM Challenge, Tech
534 Rep 2014;.
- 535 [28] Larminie, J., Dicks, A., McDonald, M.S.. Fuel cell systems explained;
536 vol. 2. J. Wiley Chichester, UK; 2003.
- 537 [29] Wahdame, B., Candusso, D., François, X., Harel, F., Péra, M.C.,
538 Hissel, D., et al. Comparison between two pem fuel cell durability
539 tests performed at constant current and under solicitations linked to
540 transport mission profile. International Journal of Hydrogen Energy
541 2007;32(17):4523–4536.
- 542 [30] Wei, L., Wu, M., Yan, M., Liu, S., Cao, Q., Wang, H.. A re-
543 view on electrothermal modeling of supercapacitors for energy storage
544 applications. IEEE Journal of Emerging and Selected Topics in Power
545 Electronics 2019;7(3):1677–1690.
- 546 [31] Bressel, M., Hilairet, M., Hissel, D., Bouamama, B.O.. Remaining
547 useful life prediction and uncertainty quantification of proton exchange
548 membrane fuel cell under variable load. IEEE Transactions on Industrial
549 Electronics 2016;63(4):2569–2577.
- 550 [32] Bressel, M., Hilairet, M., Hissel, D., Bouamama, B.O.. Extended
551 kalman filter for prognostic of proton exchange membrane fuel cell. Ap-
552 plied Energy 2016;164:220–227.
- 553 [33] Liu, H., Chen, J., Hissel, D., Su, H.. Remaining useful life estimation
554 for proton exchange membrane fuel cells using a hybrid method. Applied
555 energy 2019;237:910–919.
- 556 [34] Arasaratnam, I., Haykin, S.. Cubature kalman filters. IEEE Transac-
557 tions on automatic control 2009;54(6):1254–1269.
- 558 [35] Haykin, S., Arasaratnam, I.. Cubature kalman filters. IEEE Trans
559 Autom Control 2009;54(6):1254–1269.
- 560 [36] Cui, B., Wei, X., Chen, X., Li, J., Li, L.. On sigma-point update of
561 cubature kalman filter for gnss/ins under gnss-challenged environment.
562 IEEE Transactions on Vehicular Technology 2019;68(9):8671–8682.

- 563 [37] Torres-González, V., Sanchez, T., Fridman, L.M., Moreno, J.A..
564 Design of continuous twisting algorithm. *Automatica* 2017;80:119–126.
- 565 [38] Rakhtala, S.M., Ahmadi, M.. Twisting control algorithm for the yaw
566 and pitch tracking of a twin rotor uav. *International Journal of Au-*
567 *tomation and Control* 2017;11(2):143–163.
- 568 [39] Zhang, L., Zhang, H., Obeid, H., Laghrouche, S.. Time-varying
569 state observer based twisting control of linear induction motor consid-
570 ering dynamic end effects with unknown load torque. *ISA transactions*
571 2019;93:290–301.
- 572 [40] Fridman, L., Moreno, J.A., Bandyopadhyay, B., Kamal, S., Chalanga,
573 A.. Continuous nested algorithms: The fifth generation of sliding mode
574 controllers. In: *Recent advances in sliding modes: From control to*
575 *intelligent mechatronics*. Springer; 2015, p. 5–35.
- 576 [41] Santiesteban, R., Fridman, L., Moreno, J.A.. Finite-time convergence
577 analysis for twisting controller via a strict lyapunov function. In: *2010*
578 *11th international workshop on variable structure systems (VSS)*. IEEE;
579 2010, p. 1–6.
- 580 [42] Hilairret, M., Ghanes, M., Béthoux, O., Tanasa, V., Barbot,
581 J.P., Normand-Cyrot, D.. A passivity-based controller for coordina-
582 tion of converters in a fuel cell system. *Control engineering practice*
583 2013;21(8):1097–1109.
- 584 [43] Zhang, Y., Xiong, R., He, H., Shen, W.. Lithium-Ion Battery Pack
585 State of Charge and State of Energy Estimation Algorithms Using a
586 Hardware-in-the-Loop Validation. *IEEE Transactions on Power Elec-*
587 *tronics* 2017;32(6):4421–4431.
- 588 [44] Chen, H., Zhao, X., Qu, B., Zhang, T., Pei, P., Li, C.. An eval-
589 uation method of gas distribution quality in dynamic process of proton
590 exchange membrane fuel cell. *Applied Energy* 2018;232:26–35.
- 591 [45] Ren, P., Pei, P., Li, Y., Wu, Z., Chen, D., Huang, S.. Degrada-
592 tion mechanisms of proton exchange membrane fuel cell under typical
593 automotive operating conditions. *Progress in Energy and Combustion*
594 *Science* 2020;80:100859.

- 595 [46] Borup, R.L., Davey, J.R., Garzon, F.H., Wood, D.L., Inbody, M.A..
596 Pem fuel cell electrocatalyst durability measurements. *Journal of Power*
597 *Sources* 2006;163(1):76–81.
- 598 [47] Heyd, D.V., Harrington, D.A.. Platinum oxide growth kinetics for
599 cyclic voltammetry. *Journal of Electroanalytical Chemistry* 1992;335(1-
600 2):19–31.
- 601 [48] Borup, R., Meyers, J., Pivovar, B., Kim, Y.S., Mukundan, R.,
602 Garland, N., et al. Scientific aspects of polymer electrolyte fuel cell
603 durability and degradation. *Chemical reviews* 2007;107(10):3904–3951.
- 604 [49] Ibrahim, M., Steiner, N.Y., Jemei, S., Hissel, D.. Wavelet-based
605 approach for online fuel cell remaining useful lifetime prediction. *IEEE*
606 *Transactions on Industrial Electronics* 2016;63(8):5057–5068.