



**HAL**  
open science

## Specification of an "Oriental" language and culture information server.

Elisabeth de Pablo, Peter Stockinger, Hammou Fadili, Philippe Ramirez

### ► To cite this version:

Elisabeth de Pablo, Peter Stockinger, Hammou Fadili, Philippe Ramirez. Specification of an "Oriental" language and culture information server. : The French demo-scenario of the ESPRIT IV research project "An Environment for a Virtual Hypermedia Factory" (VHF).. [Technical Report] Inalco; ESCoM-AAR (Equipe Sémiotique Cognitive et Nouveaux Médias - Archives Audiovisuelles de la Recherche); FMSH. 1997, pp.135. hal-03184860

**HAL Id: hal-03184860**

**<https://hal.science/hal-03184860>**

Submitted on 29 Mar 2021

**HAL** is a multi-disciplinary open access archive for the deposit and dissemination of scientific research documents, whether they are published or not. The documents may come from teaching and research institutions in France or abroad, or from public or private research centers.

L'archive ouverte pluridisciplinaire **HAL**, est destinée au dépôt et à la diffusion de documents scientifiques de niveau recherche, publiés ou non, émanant des établissements d'enseignement et de recherche français ou étrangers, des laboratoires publics ou privés.



Distributed under a Creative Commons Attribution - NonCommercial - NoDerivatives 4.0 International License

**ESPRIT PROJECT 22251****VHF  
An Environment for a Virtual Hypermedia Factory**

<b>Title:</b>	<b>The French Demo Scenario</b>
<b>Creation date:</b>	<b>January 10th, 1997</b>
<b>Release date:</b>	<b>January 21th, 1997</b>
<b>Author(s):</b>	Hammou Fadili Elisabeth de Pablo, Peter Stockinger Philippe Ramirez,
<b>Status:</b>	draft
<b>Classification:</b>	technical report
<b>Access Rights:</b>	restricted
<b>Version:</b>	01.01
<b>Work Package:</b>	WP2
<b>Authority:</b>	MSH + INALCO
<b>Distribution:</b>	VHF Consortium, EC

## Contents

<b>1 Document Control.....</b>	<b>4</b>
1.1 Abstract.....	4
1.2 Change history.....	4
1.3 Document cross reference.....	4
<b>2 General.....</b>	<b>4</b>
2.1 Scope.....	4
2.2 Introduction.....	5
2.3 Terms and abbreviations used.....	5
<b>3) General Presentation of the Underlying Cultural and Political Principles of the French Demo Scenario.....</b>	<b>6</b>
<b>4) "Translation" of the Expressed Information Needs and Requirements in Terms of Cultural (and Touristic) Information Services.....</b>	<b>12</b>
4.1) Requirements for the specification of cultural and touristic information services.....	12
4.2. The major types of cultural information services.....	15
<b>5. The Home-Page of the French Server "Orient".....</b>	<b>18</b>
5.1) Short presentation.....	18
5.2) The Start screen.....	18
5.2.1) The User's Point of View.....	18
5.2.2) The Interface Display Model.....	19
5.3) The Main Menu Screen.....	20
5.3.1) The User's Point of View.....	20
5.3.2) The Interface Display Model.....	20
<b>6) Encyclopaedic and/or Thematically Restricted Information services.....</b>	<b>21</b>
6.1) The "First Contacts" service.....	21
6.1.1) General definition of the "first contacts" service.....	21
6.1.2) scenarisation of the consultation of the "first contacts" service.....	24
6.1.3) interface display Model.....	25
6.1.4) implementation of the "first contacts" service.....	29
6.1.5) information and document gathering and maintenance of the "first contacts" service.....	30
6.1.6) control and quality evaluation of the "first contacts" service....	31
6.1.7) exploitation of the "first contacts" service.....	32
6.1.8) prospects and possible evolutions of the "first contacts" service.....	32

6.2) The "Thematic Booklets" service.....	33
6.2.1) General definition of the "thematic booklet" service.....	33
6.2.2) scenarisation of the consultation of the "thematic file" service.....	35
6.2.3) interface display Model.....	38
6.2.4) implementation of the "thematic booklet" service.....	43
6.2.5) information and document gathering and maintenance of the "thematic booklet" service.....	46
6.2.6) control and quality evaluation.....	46
6.2.7) exploitation of the "thematic booklet" service.....	47
6.2.8) prospects and possible evolutions of the "thematic booklet" service.....	47
6.3) The "Who is Who" service.....	49
6.3.1) General definition of the "who is who" service.....	49
6.3.2) scenarisation of the consultation of the "who is who" service.....	51
6.3.3) interface display Model.....	53
6.3.4) implementation of the "who is who" service.....	58
6.3.5) information and document gathering and maintenance of the "who is who" service.....	59
6.3.6) controle and quality evaluation of the "who is who" service....	59
6.3.7) exploitation of the "who is who" service.....	60
6.3.8) prospects and possible evolutions of the "who is who" service.....	60
<b>7) Travel and tourist service.....</b>	<b>61</b>
7.1) The "Tourists' Bag" service.....	61
7.1.1) General definition of the "tourists' bag" service.....	61
7.1.2) scenarisation of the consultation of the "tourists' bag" service.....	64
7.1.3) interface display Model.....	68
7.1.4) implementation of the "tourists' bag" service.....	77
7.1.5) information and document gathering and maintenance of the "tourists' bag" service.....	77
7.1.6) controle and quality evaluation of the "tourists' bag" service...	78
7.1.7) exploitation of the "tourists' bag" service.....	78
7.1.8) prospects and possible evolutions of the "tourists' bag" service.....	78
<b>8) The "News" Service.....</b>	<b>79</b>
8.1) The Specific News Service.....	79
8.1.1) General definition of the "news" service.....	79
8.1.2) scenarisation of the consultation of the "news" service.....	80

8.1.3) interface display model.....	82
8.1.4) implementation of the "news" service.....	84
8.1.5) information and document gathering and maintenance of the "news" service.....	85
8.1.6) controle and quality evaluation of the "news" service.....	85
8.1.7) exploitation of the "news" service.....	85
8.1.8) prospects and possible evolutions of the "news" service.....	86
<b>9) Services "Contacts of Countries and Cultures" .....</b>	<b>87</b>
9.1) the "asia in paris" service.....	87
9.1.1) General presentation of the "asia in paris" service.....	87
9.1.2) scenarisation of the consultation of the "Asia in Paris" service.....	90
9.1.3) Lay-out and interface displays.....	91
9.1.4) implementation of the "Asia in Paris" service.....	92
9.1.5) information and document gathering.....	92
9.1.6) controle and quality evaluation of the "Asia in Paris" service..	93
9.1.7) exploitation of the "Asia in Paris" service.....	93
9.1.8) prospects and possible evolutions of the "Asia in Paris" service.....	94
<b>10) Cultural Job &amp; Expertise Services.....</b>	<b>95</b>
10.1) The "Head Hunter" service.....	95
10.1.1) General definition of the "head hunter" service.....	95
10.1.2) scenarisation of the consultation of the "head hunter" service.....	101
10.1.3) Lay-out / Display model.....	107
10.1.4) implementation of the "head hunter" service.....	113
10.1.5) information and document gathering and maintenance of the "head hunter" service.....	115
10.1.6) controle and quality evaluation of the "head hunter" service.....	116
10.1.7) exploitation of the "head hunter" service.....	117
10.1.8) prospects and possible evolutions of the "head hunter" service.....	117

## 1. Document Control

### 1.1 Abstract

This document is the technical report describing the French demo scenario of the VHF project. It contains more particularly informations concerning:

- the different types of **cultural (and touristic) information services** that are planned to be implemented as well as
- a **life-cycle description** of each service.

### 1.2 Change history

This is the first version (version 01.01) of the technical report describing the French demo scenario for the VHF project.

### 1.3 Document cross reference

1. An environment for a Virtual Hypermedia Factory - Esprit project no. 22251 Technical Annex (version approved 29/05/96)
2. VHF rules and procedures - D2.7

## 2. General

### 2.1 Scope

This technical report gives a systematic description of the:

- 1) principal cultural (and touristic) information services that have been specified out of the preliminary user requirement analysis (cf. the corresponding technical user requirements and needs report)
- 2) a user oriented short "simulation" of the typical consultation scenario of each service
- 3) the interface display models of each service

- 4) the computational and implementational particularities of each service
- 5) the particularities concerning the life-cycles of each service (exploitation, quality control, information gathering and diffusion, ...).

## 2.2 **Terms and abbreviations used**

TA Technical Annex

WP Work Package

### 3) GENERAL PRESENTATION OF THE UNDERLYING CULTURAL AND POLITICAL PRINCIPLES OF THE FRENCH DEMO SCENARIO

Given the principal institutional interests of the French partners of the VHF consortium as well as of their network of principal VHF external partners (education & research, librairies, tourist operators, publishing houses, public administration, public documentation and information centers, ...), the pilot domain of the French demo scenario is based on the diffusion and valorization of their cultural and scientific heritage that concerns especially

- the relationships between French culture (broadly speaking) and non-European cultures and civilisations
- as well as the better understanding of these cultures and civilisations.

These two aspects have always constituted one of the major preoccupations in the French political and educational life since more than two centuries (given the permanent political, military, economical and cultural presence of France especially in Asia, Oceania, and Africa). They have given birth to specialized public educational and research institutions, public information and documentation centers as well as to the progressive emergence of a plethora of private librairies, publishing houses (for written as well as audio-visual documents), specialized mass medias, associations, specialized cultural heritage institutions such as museums, art galleries or again librairies, and so on.

Naturally, the constitution of these - in a *semiotic* and *sociological* sense - "**cultural resources**" has been highly stimulated because of the important French presence in the above quoted regions but also because of an important immigration from these regions especially to Paris.

Especially INALCO, the associated partner of the MSH, but also the MSH itself with its important library in anthropology, ethnology and art history and with its own publishing house as well as, finally, the several VHF external French partners, are one of the **principal actors** in the production collection,



diffusion and valorization of these cultural resources. Their tasks are important ones because they have to collect, produce and communicate relevant (in a broad sense) cultural and scientifically truthful informations not only inside an academic and research world but also for highly practical as well as politically and economically important purposes. Such purposes concern the satisfaction of general target groups as, for instance:

- the *French political and cultural representation* (cultural centers, ambassies, the institutions of the so-called "francophonie", the different representants of the so-called "cooperation", ...) in the concerned countries and regions,
- the *mass-media* (written and audio-visual press) that are highly dependent as far as relevant, (in a broad sense) cultural "background" informations are concerned,
- more specifically the (French) *SME* that - contrarily to the big public or private companies - are completely dependent on general but for their particular purpose relevant informations concerning not only a given country but more specifically the habitudes, the socio-cultural behaviour patterns, the general history, the consumption particularities, the trends, the laws, etc. in such a country,
- the "*cultural market*" (i.e. art galleries, book and video market, ...) for whom actual but also historically ascertained information of specific cultural domains are, naturally, of a vital interest
- the "*educational market*" broadly speaking (viz. including the educational book market, the para-scholar, professional learning and training facilities, ...) who have to produce appropriate learning tools based on qualitatively high, truthful but also user adapted cultural informations concerning the quoted regions,
- more *specialized professional sectors* (viz. authors, technical writers, translators, consulting firms in communication and international marketing,

...) who need need qualitatively high, truthful and back ground information concerning the quoted regions.

Given this general historical and political background and with respect to this background, the French partners of the VHF consortium have realized a systematic user needs and requirements analysis . The potential users of the French VHF server called ORIENT have been classified in **seven institutional user categories**, i.e.:

- 1) **libraries**,
- 2) **publishing and distribution houses**,
- 3) **museums**,
  
- 4) **information service centers** (= suppliers of contents),
- 5) **audio-visual industry & press**,
- 6) **touristic service centers** and **operators**,
- 7) the **educational, academic and research world**.

Furthermore, **three** principal **categories of final users** have been identified:

- 1) **tourists** (individual tourists, groups of tourists, tourists travelling "à la carte", business tourists, cultural tourists, winter/summer sport tourists,...);
- 2) **information consumers** (consumers of political, cultural, economic information, ...);
- 3) **students** largely speaking (including not students of universities but all categories of people engaged in some specific academic or professional curriculum)

For each category has been established:

- **typical situations** (i.e. "**scenes**" in the sense of the VHF consortium) in which (broadly speaking) cultural information are needed or required (i.e.

specific purposes, particular activities associated with the requested informations, ...) ,

- the **principal types of information** that are required (i.e. the "content" or again the principal **themes - slots** - to be satisfied ) ,

- the **privileged representation modalities** by the means of which the information for a requested theme (slot) is realized and distributed (viz. texts, graphics, animations, sound tracks, ...),

- the **privileged document types** or **genders** (viz. abstracts, leads, news, thematic booklets, vademecums, magazines, documentaries, portraits, ...),

- the **privileged medias** that support physically a document containing the information of a requested theme or slot (paper printed magazines, CD ROMs, ...)

In taking account these five principal criterias, a set of principal requirements for the specification of types of cultural information services has been elaborated (cf. **chapter 4.1: Requirements for the specification of cultural and touristic information services**).

These requirements have been broken down in five major types of cultural information services which will be discussed in **chapter 4.2.: The major types of cultural information services**).

Each major type of cultural information services is composed by one or more specific information services. In the chapters 6, 7, 8, 9 and 10 each one of them is systematically described - excepted three rather simple information services that are developed by the means of pre-existing codes and scenarios.

The **description of each cultural information service** that are, actually, under development for the realization of the French demo scenario, is organized as follows:

- 1) **Global presentation of the structure of the service**
- 2) **Presentation of a typical user scenario for the service**
- 3) **Interface Design and Lay Out Particularities**
- 4) **Computational Modelization and Implementation**
- 5) **Life Cycle (information collection and maintenance, quality control of the service, exploitation, possible evolutions of the service).**

One really important and central particularity of the identification, conception and realization of (broadly speaking) cultural information services consists in the fact that the reference domain by itself can be interpreted in **highly different ways**. In other words: it is evident that there do exist a high variety of very different interpretations of what "culture" and, a fortiori, "cultural heritage" is.

In this sense, the requirements and needs can be extremely different and evolutive as far as (on line) cultural information services are concerned. In order to be able - at least partially - to take into account this matter of fact, the proposed major and specific types of cultural information services are defined and organized in a highly **modular** and **open form**: for instance a particular component of one service can be partially used in another one, new services can be easily introduced within the already existing ones, and so on. The modular conception of the cultural information services implies, too, a privileged use of a **database technology**.

As far as the notion "**information service**" itself is concerned, it is also not a clearly defined one: one can consider it as a (more or less "intelligent", i.e. semantically rich) information consultation service but it can be considered, too, in an extended sense encompassing, for instance:

**electronic publishing facilities,**  
**facilities for (cooperative) distant working and/or learning,**  
**electronic market facilities,**  
**on-line and personnalized advertising facilities,**  
and so on.

As it will be shown in the following chapters, the notion of "information service" used for the definition of the French demo scenario is a broad one including several of the above quoted facilities.

As already mentioned above, the French partners of the VHF consortium have constituted a **network of institutional and individual partners, external** to the VHF consortium, that will accomplish the following functions:

- 1) document collection, acquisition (digitalization) and especially document maintenance,
- 2) user oriented quality control and validation of the services to be developped
- 3) specification of exploitation scenarios for the developped information services,
- 4) identification of new information services or again amelioration of the exosting ones
- 5) undertaking of more promotional activities.

The network is in constant evolution and it is therefore somewhat difficult to give a precise image of it but the following schema can be considered to possess at least an illustrative value:

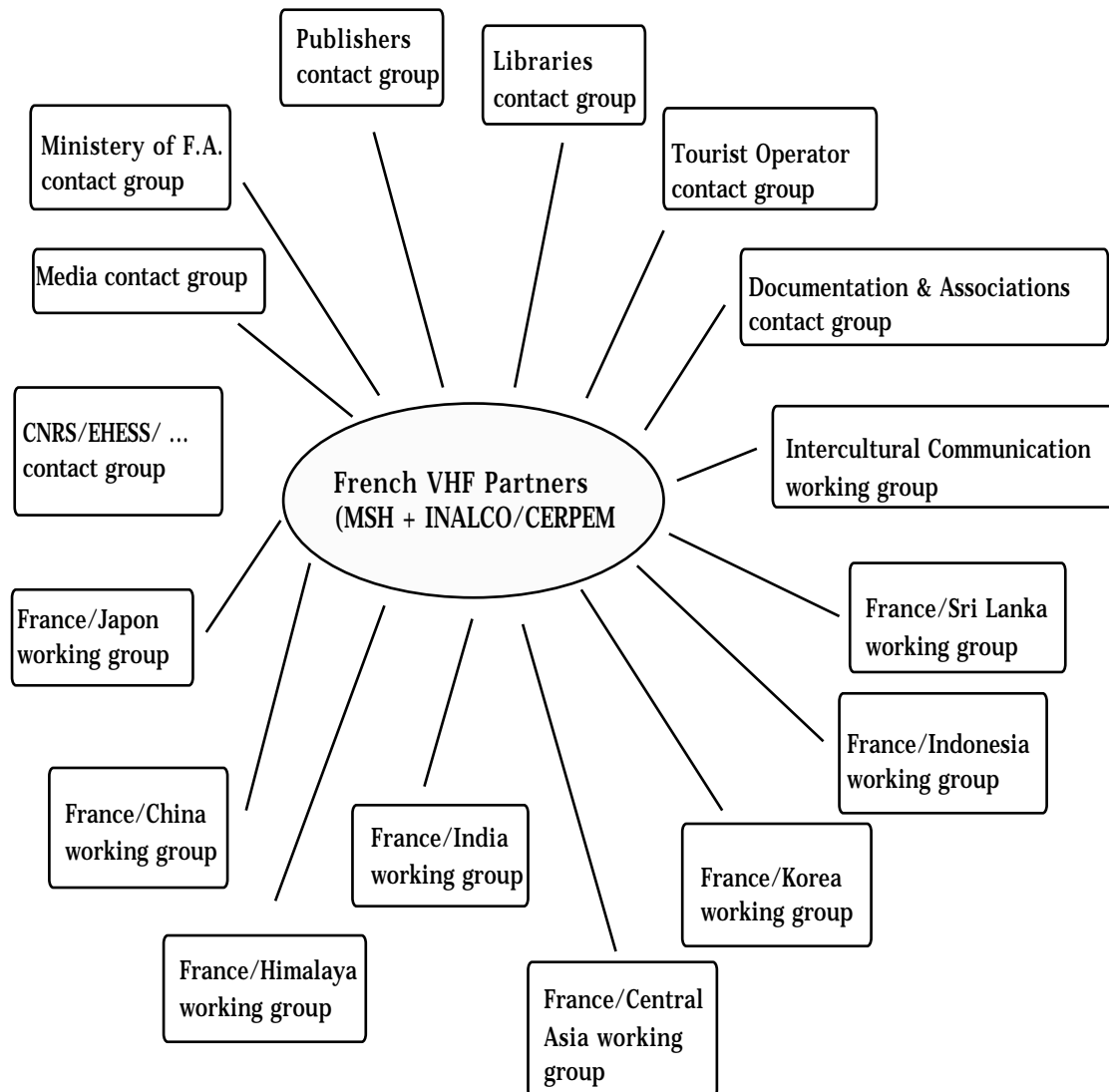

#### **4) "TRANSLATION" OF THE EXPRESSED INFORMATION NEEDS AND REQUIREMENTS IN TERMS OF CULTURAL (AND TOURISTIC) INFORMATION SERVICES**

##### **4.1) Requirements for the specification of cultural and touristic information services**

In taking into account the five principal criterias quoted above, the following ten major requirements for cultural information services have been established. Each requirement, alone or with one or more of the other requirements, constitutes the particular characteristics of a **concrete situation** (of a "**scene**" in the sense of the VHF consortium) in which a specific cultural information need emerges.

1) Specific information services that answer to particular informations **needs of the several categories of institutional users** (i.e.

publishers require actual informations about new titles, about the critics of a title by the cultural press of a country;

tourist operators require, besides practical information, general cultural informations of a country, little booklets about specific touristic sites, itineraries, ...;

the public administration as well as the medias ask for truthful information concerning personalities and social or cultural organizations, background informations, ...

the private companies require some specific and personnalized booklet containing these informations that could facilitate them to better understand their partners

etc.

2) Specific information services that answer to particular information **needs of different categories of final or end users** (i.e.:

a tourist requires general cultural (political, ...) information concerning a country, a region, a site, and so on

an author who, contrarily, asks for rather specific informations or who needs much more background informations

a translator who asks for linguistic or lexico-terminological informations

a business man who needs synthesis of the most important cultural and historical aspects of a country, ...).

3) Specific information services that answer to **basic informations needs** (i.e. to information needs - of tourists, business men, authors, publishers, ... - that can be fulfilled by some comprehensive, non-specialized syntheses of a culture, a country, a language, ...).

4) Specific information services that answer, contrarily, to rather precise and **specialized information needs** (concerning a specific theme - slot - which should be documented rather extensively by a multimedia material including texts, pictures, graphics, sound tracks, bibliographies, and so on).

5) Specific information services that have either a **thematic** or a **more encyclopaedic orientation** which highlights a country or a culture with the help of a set of different themes (for instance the presentation of a particular period in the history of literature with the help of themes such as "general historical background", "authors", "styles & schools", "the public", "critics", "influence", ...)

6) Specific information services that proposes a **multilingual acces** to the **documents** that constitute its database and which are - as far as texts and



oral documents are concerned - themselves **multilingual** (i.e. an access in French or English or German, ... to texts written in French or Chinese or Korean, ...)

7) Specific information services that are able to furnish "**hot**" **informations**, that is: thematically organized informations concerning actual cultural or other events in order to give the user (journalist, politician, business man, gallerist, ...) the possibility to react adequately to a given evolution in the "cultural market".

8) Specific information services that not only propose the thematically oriented and organized **exploration** of physically remoted and heterogeneous (textual, audio-visual, ...) document databases but also the **exchange** of such informations between users who are physically (and from a temporal point of view) separated as well as the (individual or collective) **electronic production** of "personalized" documents that answer a given information need or desire of a user.

9) Specific information services that propose a kind of an "**electronic market**" between people who possess a specific "**cultural competence**" (art specialist, specialist in literature, translator, linguist, writer, ...) and people who seek such a competence.

10) Specific information services that propose practical informations for the **exploitation** and **commercialization** of **cultural resources**.

#### **4.2.The major types of cultural information services**

In taking into account the principal ten above quoted requirements, the following five major types of cultural information services have been specified. Each one of them is composed by one or more specific cultural information services which are, actually, under developpement. As already mentioned above, each specific cultural information service will be described systematically in the chapters 6 to 10.

Here is the list of the five major types of cultural information services composed by one or more specific information services.

<p><b>I) SERVICES D'INFORMATIONS À VISÉE ENCYCLOPÉDIQUE ET À THÈME (ENCYCLOPAEDIC AND/OR THEMATIC RESTRICTED INFORMATION SERVICES)</b></p>
--

At the moment this category encompasses four more specific information services that have been identified by the user information needs analysis and which are, actually, under developpement:

**1) PREMIERS CONTACTS** - FIRST CONTACTS - (this service proposes general and basic informations of a culture, a country or again some civilization which do not presuppose any prior knowledge of the user).

**2) DOSSIERS THÉMATIQUES** - THEMATIC BOOKLETS - (this service proposes more or less specialized and problematized information for one specific requested theme - slot - in the cultural domain as well as the interactive constitution and electronic publishing of "personnalized" documents, viz. "booklets").

**3) QUI EST QUI** - WHO IS WHO - (this service proposes more or less general or particular information portraying a personality of the cultural, political, ...

life as well as the "interactive" electronic publishing of an electronic revue containing a requested portrait)

4) **HISTOIRE DE LA PRÉSENCE FRANÇAISE EN ASIE** - HISTORY OF THE FRENCH PRESENCE IN ASIA (as the title indicates already, this service proposes information concerning specific themes in the history of the French presence in Asia, especially in South-East Asia, in China and in Oceania)

## **II) SERVICES "TRAVAIL & CONSEIL "** (CULTURAL JOB & EXPERTISE SERVICES)

This service is actually composed by two more specific but extremely complementary ones:

1) **CHASSEUR DE TETES** - HEAD HUNTER - (this service proposes to facilitate the contacts between people who can offer special cultural competencies (translators, lexicologists, technical writers, authors, art specialists, ...) and people who look for such a competence in order to fulfill/to realize a specific task.

2) **VEILLE D'INFORMATION** - INFORMATION WATCH (this service proposes to someone who need some specific information to leave a message in a "box" of the service and to look for some specialists that could solve the information problem)

## **III) SERVICE ACTUALITÉS (NEWS SERVICE)**

This service is actually composed by one single specific news service:

1) **ACTUALITÉS** - NEWS - (this service proposes a thematically motivated and systematic access to these information sources such as mass medias that can deliver "hot" - actual- information.

## **IV) SERVICES VOYAGE & TOURISME (TRAVEL AND TOURIST SERVICE)**

This service is, too, composed by only one specific information service:

1) **VALISE POUR TOURISTES - TOURISTS' BAG** - (this service proposes not only general and useful information concerning travel, sojourn, specific offers, etc. but also predefined itineraries for a better understanding of some cultural heritage as well as the "interactive" publishing of a Tourist's Vademecum.

V) **SERVICES "AU CONTACT DES PAYS ET CULTURES"** (SERVICES "CONTACTS OF COUNTRIES AND CULTURES")

1) **ASIE À PARIS** - ASIA IN PARIS (this service proposes practical information concerning the cultural resources of the different communities of Asia in Paris)

2) **AFRIQUE À PARIS** - AFRICA IN PARIS - (this service proposes practical information concerning the cultural resources of the different communities of Africa in Paris)

3) **La FRANCE EN ASIE** - FRANCE IN ASIA - (this service proposes practical information concerning the cultural resources and the cultural presence of France in the different countries of the Asian continent)

---

Besides the above mentioned cultural information services, there exist again some specific ones which concern more particularly the VHF consortium and the French partners of the consortium  
 u Services d'Information permanents:

Informations concerning the "Virtual Hypermedia Factory (VHF - ESPRIT Project 22251)

Informations concerning the "Maison des Sciences de l'Homme"

Informations concerning the "Institut National des Langues et Civilisations Orientales"

Informations concerning more particularly the "Serveur ORIENT"

Informations concerning more particularly the methodological framework  
"SémioNet"

## **5. THE HOME-PAGE OF THE FRENCH SERVER "ORIENT"**

### **5.1) Short presentation**

The homepage of the French VHF server "Orient" is divided in two different "screens":

a first screen - i.e. the start screen - that welcomes the user and that identifies briefly the context of this server`

a second screen that constitutes the interface of the main menu of the proposed cultural information services.

### **5.2) The Start screen**

#### **5.2.1) The User's Point of View**

In arriving on the first screen of the French VHF server "ORIENT", the user:

will be informed about VHF, INALCO, MSH, the server "ORIENT" itself (people that work on its evolution, material, studies, ...) and the methodological framework SémioNet (description, publications, interests, ...)

will be requested to chose among several languages the language by the means of which he/she will access and explore the different information services

will be invited to send his/her suggestions to the people in charge of the maintenance of the server ORIENT



### 5.2.2) The Interface Display Model

This is the graphical interface display for the start screen:

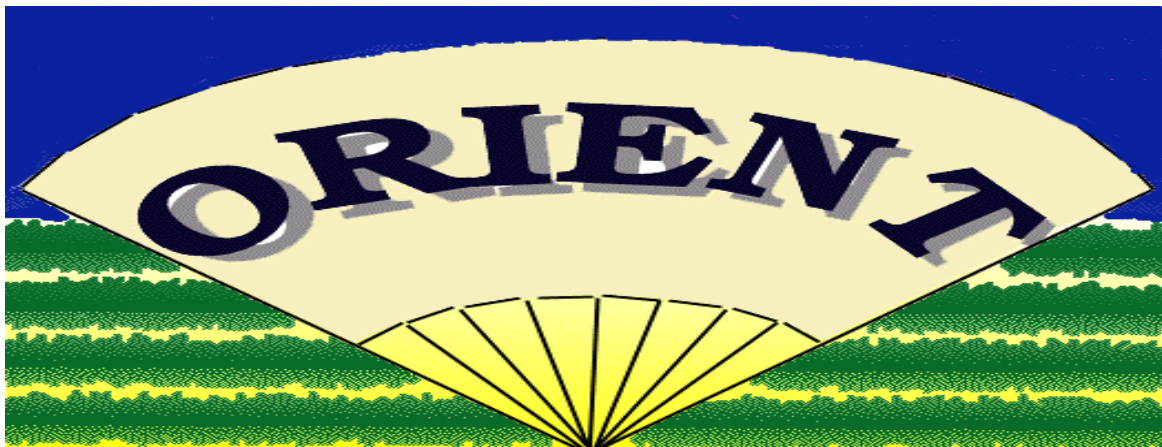

Bienvenue sur

“ ORIENT ”

Le serveur français du consortium européen

"An Environment for a Virtual Hypermedia Factory"

Programme ESPRIT N° 22251



Orient est un prototype en cours d'élaboration d'un serveur sur le monde oriental.

Ses pages s'étofferont dans les mois à venir.  
Revenez nous visiter régulièrement, et faites-nous part de vos remarques.



ORIENT est consultable dans les langues suivantes :



Faites votre choix

Entrez un mot clé pour accélérer votre exploration sur notre site

You can enter a key-word to explore our site

Indications de recherche

Vous recherchez :

Autres services :

- Accéder à un service FTP de VHF
- Participer à un groupe de discussion
- Accéder à un service telnet
- Accéder à un service gopher

Pour information :

Vous êtes le



ème visiteur de ce site

Téléphone : 01 49 54 22 30 - FAX : 01 49 54 21 83

Adresse : 54, Bd Raspail 75006 Paris

Pour vos commentaires envoyer un mail a : [fadili@msh-paris.fr](mailto:fadili@msh-paris.fr)

Copyright © 1997 VHF

### **5.3) The Main Menu Screen**

#### **5.3.1) The User's Point of View**

The main menu screen:

invites the user to activate the help&explanation module if this is his/her first consultation,

invites the user to chose among the five principal cultural information services

proposes the user to examine the permanent information services MSH, INALCO, VHF, ORIENT, SemioNet

#### **5.3.2) The Interface Display Model**

The screen is divided in two parts :

- \* all the services are placed on the left side of the screen (= stable & interactive part)
- \* the right side is reserved for the description and the presentation of the "sub-services" under a tree-hierarchy form (= moveable & interactive part).

The user is invited to click on one item of the left side, he will get the correspondant information on the right side.

The presentation of the sub-services is interactive, it allows the direct connexion to the named services.

This is the graphical interface display model for the principal menu screen:

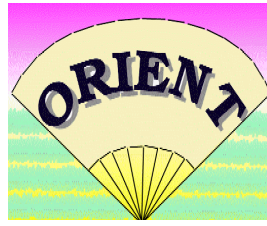
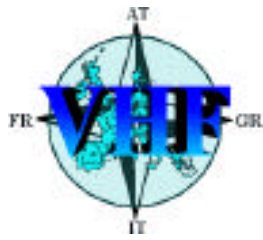

## Menu Principal



## **6) ENCYCLOPAEDIC AND/OR THEMATIC RESTRICTED INFORMATION SERVICES**

For the moment this category encompasses four more specific information services that have been identified by the user information needs analysis and which are, actually, under development: But its architecture is completely open. So, it is not difficult to introduce new encyclopaedic and/or more thematically restricted information services.

### **6.1) THE "FIRST CONTACTS" SERVICE**

#### **6.1.1) GENERAL DEFINITION OF THE "FIRST CONTACTS" SERVICE**

The First Contacts service is conceived as an essentially cultural (linguistic, political, economical, geographical, ...) information service that proposes to a user **without any specific knowledge, basic structured multimedia information** about different countries, regions or again culturally (and/or touristically) relevant sites (in the "Oriental World").

The necessity of this information service has been clearly shown by the results of the user needs and requirements analysis in which one of the most recurrent information problems has been this of a basic but systematic introduction in the cultural, political or again economical specificities of an "exotic" country or a region by the means of multimedia documents (i.e. not only by the means of texts, but also by the means of graphics, animations, sound tracks or again videos).

The targetted user groups are the following ones:

- **tourists** who prepare a travel or a sojourn in one of the concerned regions or countries
- **companies** and other **institutional users** that plan economical or financial exchanges with a concerned country and for whom the First Contact information service constitutes a kind of indispensable "general culture" for adequately approaching a foreign culture and foreign habitudes.
- **journalists** and people working in the **mass media** who need some "general but well documented ideas" about a cultural, political, ... context for which it is difficult to get such informations,
- undergraduate **students** of the concerned academic disciplines and all these who have temporarily to deal with a cultural, political, ... context recovered by this service

As it has been mentioned, the First Contact cultural information service is constituted by:

- basic
- structured
- multimedia information.

By "**basic information**", it is meant information that does not require any prior knowledge about a specific culture, political or economical system.

By "**multimedia information**" it is meant that a given theme - or thematic profile - such as "India: Culture > Danse" will be documented with the help of thematically relevant:

short texts

photos and other static illustrations

animations

and sound tracks.

By "**structured information**" it is meant the fact that the different multimedia information doesn't constitute one global file (or data) but several distinct files (or several distinct datas) which are assembled in the Information Exploration Screen (cf. infra) where the user can consult them within different autonomous scrollable frames.

The First Contact cultural information service is composed by the following components and modules:

- a) a Main Menu proposing to a user to choose in a geographic index or in an interactive map, a simple explication/help service and a discussion/idea exchange service,
- b) a Country (Region) Menu proposing the user to choose in the thematic (and linguistic) index
- c) a Exploration Menu set up by several independant frames in which can be consulted the relevant multimedia documents
- d) document databases (short texts, bibliographies, graphical informations, illustrations, some sound tracks, some video animations)
- e) a thematic index (see Annex I)
- f) a geographic index (see Annex II) and interactive geographic maps
- g) a linguistic index (see Annex V)
- h) a simple explication & help service for users who are consulting the first time the First Contact service
- i) a discussion/idea exchange forum

### **6.1.2) SCENARISATION OF THE CONSULTATION OF THE "FIRST CONTACTS" SERVICE**

A typical consultation of this service looks like this:

#### **1. First Contact Main Menu**

1.1) Short identification of this service

1.2) Invitation to the user to choose in the geographical index or on the interactive map

// if this is the first consultation for the user, invitation to the user to click on the explication & help service

1.3) The user chooses in the geographic index or on the interactive map

#### **2) Country Menu**

2.1) the choice of a country (or region) leads the user to the Country Menu: short identification of this menu

2.2) Invitation to the user to choose:

    in the thematic index (the thematic index selects these documents which are from a content point of view relevant to the user)

    in the linguistic index (the linguistic index selects these documents in the data base which are linguistically accessible to the user)

2.3) The user chooses in both indexes



### 3) Exploration Menu

3.1) This is the screen organized by three (or four) scrollable frames in which the multimedia documents appear (i.e. one frame for texts, a second frame for graphic information, a third frame for static illustrations, ...)

3.2) The user explores the relevant document datas (downloads them, ...)

#### 6.1.3) INTERFACE DISPLAY MODEL

##### 1. First Contact Main Menu Screen

This first display is composed by the following components:

1)- Recall of the general icons (= stable functions):

VHF interactive icon ---> program explanation connection

MSH interactive icon ---> institution home page connection

Inalco interactive icon ---> institution home page connection

Orient interactive logo icon ---> system home page connection

2)- A non interactive text of identification of this service

3)- A capture area operate in tandem with a scroll-down menu corresponding to the geographical index

4)- An interactive map (made of clickable areas)

5)- An interactive area to choose the language.

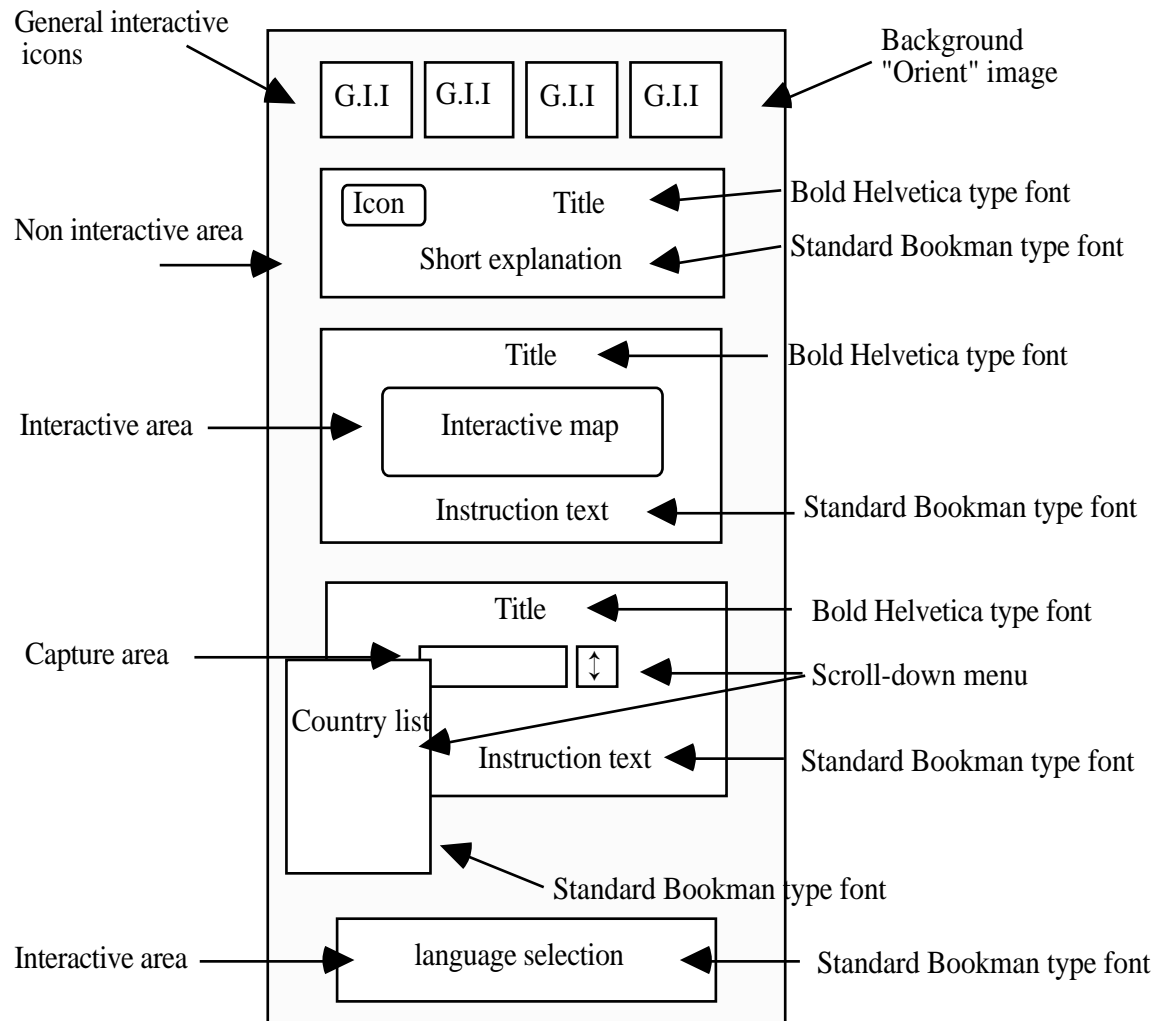

## 2. First Contact Country Menu Screen

This display is composed by the following components:

- 1)- Recall of the general icons (= stable functions)
- 2)- A non interactive text of identification
- 3)- A 3-D book representation = second step: the choice of the thematic.

The book is closed. In the front page is indicated the name of the country choice.

The book presents some interactive post-it. Each post-it corresponds to a thematic. Clicking on a post-it the book open theirs pages in an animated way.

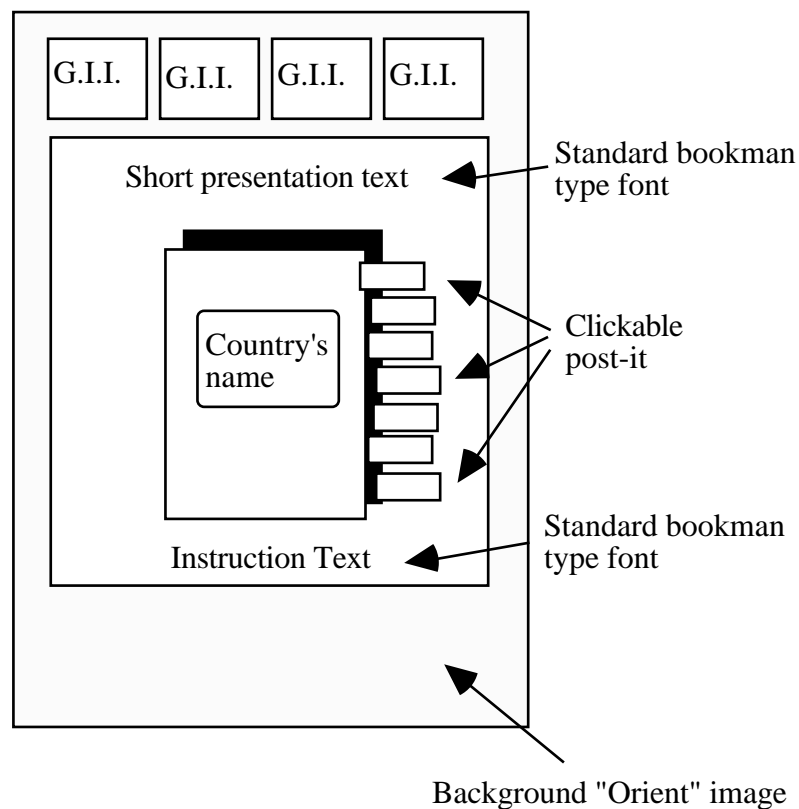

### 3. First Contact Document Exploration Menu Screen

#### Choice of a sub-thematic

This display is composed by the following components:

- 1)- Recall of the general icons (= stable functions)
- 2)- The book is open. The left page shows the name of the chosen thematic. The right page presents the sub-thematic clickable list.

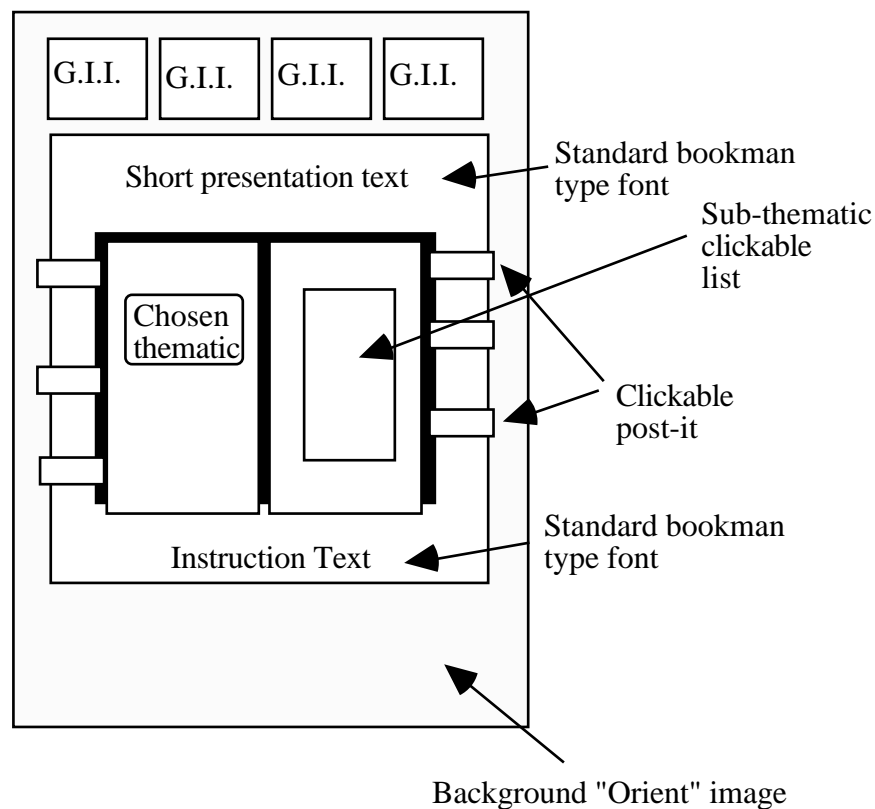

**Now the sub-thematic is chosen. The document exploration begin.**

This display is composed by the following components:

- 1)- Recall of the general icons (= stable functions)
- 2)- Three or four display frames.

Each frame is a "little window display" and have an adjustable size according to the data recording medium and, their number.

One display frame is composed by textual information (with scrollable function if necessary), another one by graphical information (with scrollable function if necessary), another by visual information (with scrollable function if necessary), another by an animated visual information (with video function if necessary).

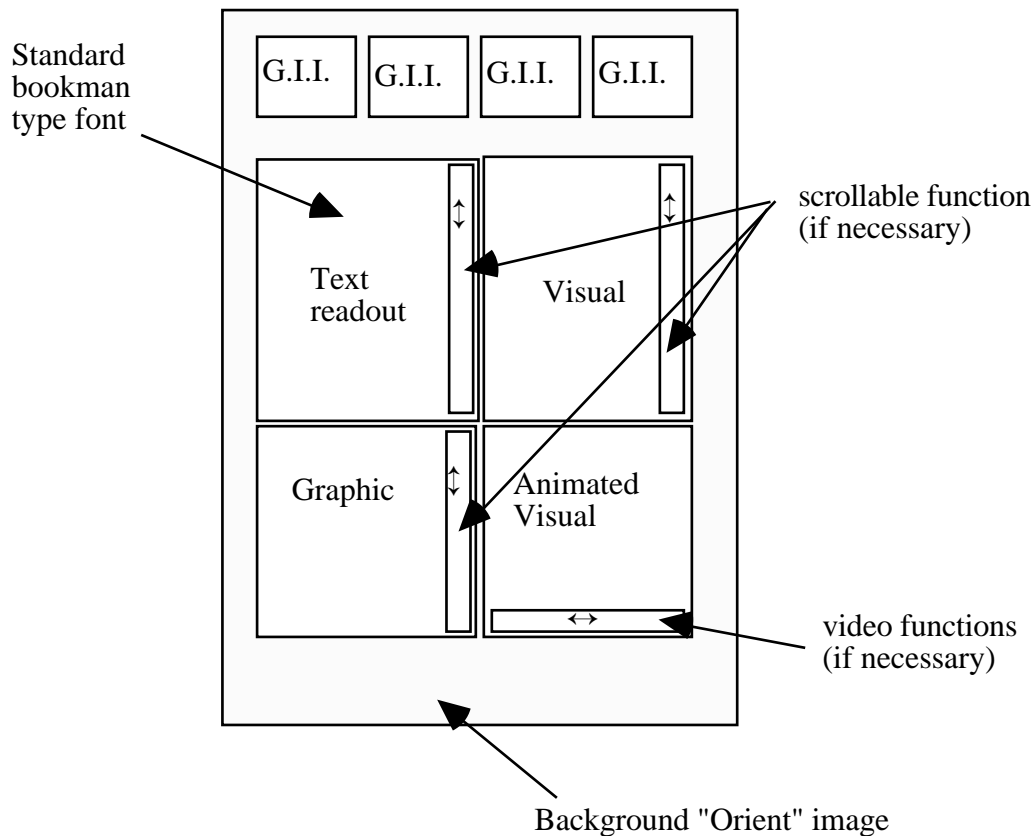

#### 4. First Contact Explication & Help Screen

This screen is very simple. Particularly the functional aspect has been put on focus.

This display is composed by the following components:

- 1)- Recall of the general icons (= stable functions)
- 2)- A non-interactive text given explanations and working modes about this service.

#### 6.1.4) IMPLEMENTATION OF THE "FIRST CONTACTS" SERVICE

The "first contacts service starts with an geographic map of Asia. The user chooses a country to consult; a thematic menu appears in which the

user can select a specific sub-menu. The system generates from these successive selections the corresponding document. We can use the

Frontpage MAP technics to implement the access by selecting regions in the geographic-map and in the associated thematic menu that gives access to the sub-themes menu as well as the HTML document to consult.

We could develop an other method for the consulting of the "first contacts service" by selecting from two scrolling menus the country and the theme(s) to consult. Submission buttons permit to execute the program that selects all documents in file format and display the result in HTML.

The script can be developed in Perl in order to facilitate files's management. All files are stored in the "FirstContact" directory and the script selects and displays documents according to the user's choice :

*Sub DisplayDocument (document)*

*if (them=geo and country = china)*

*DisplayDocument(geo-china)*

*if (them=his and country = china)*

*DisplayDocument(his-china)*

*...idem for all them*

*if (them=geo and country = japan)*

*DisplayDocument(geo-japan)*

*...for all them*

*if (them=geo and country = india)*

*DisplayDocument(geo-india)*

*...idem for all them*

*other countries*

*...idem for all countries*

The diagram shows a user interface with a rounded rectangular border. At the top left, the word 'Countries' is centered above a list of three items: 'China', 'Japan', and 'India'. At the top right, the word 'Themes' is centered above a list of three items: 'Geography', 'History', and 'etc.'. Below these two columns, centered horizontally, is a rectangular button labeled 'Submit'.

#### **6.1.5) INFORMATION AND DOCUMENT GATHERING AND MAINTENANCE OF THE "FIRST CONTACTS" SERVICE**

The First Contacts service is based on multimedia documents with a highly general and basic content. A set of multimedia documents such as:

- one or two short texts,
- between one and ten pictures
- maybe one short video
- maybe one short sound track
- maybe some statistical data

illustrate a particular theme (i.e. Indonesia: Vie Culturelle > Théâtre Javanais).

The different documents will be gathered by the several working groups that cooperate with the French VHF partners.

The selected documents will be checked by at least one specialist in order to guarantee a high quality of the content as well as of the representation modalities.

The selected documents will be digitalized and, for the moment, stored in appropriate file directories. But as soon as possible, the documents will be stored in a document database (SQL).

The maintenance of the documents will be accomplished, during the period of the VHF project, by domain specialists. After the end of the VHF project, new solutions have to be found.

The modifications of the First Contact service depends, naturally, on the results of the Control and quality evaluation of it.

#### **6.1.6) CONTROL AND QUALITY EVALUATION OF THE "FIRST CONTACTS" SERVICE**

The control and quality evaluation will be essentially based on the following technics and procedures:

- statistical evaluation of the frequentation and local exploitation of the service by the users during given test periods,

- evaluation of the suggestions send by the users to the information service manager,

- evaluation of this service by specialists and experts (content evaluation, evaluation of the ergonomy of the organization and the interface displays)

- comparative and concurrential evaluation of this service with other services that are more or less similar to it and that are proposed by other sites.

#### **6.1.7) EXPLOITATION OF THE "FIRST CONTACTS" SERVICE**

As it is a very basic and free service, "First contacts" as such may not be particularly income generating. However, the data included in its pages may be solicited for other services with a charge, such as online publishing on "Thematic booklet". Moreover, in the future, two versions of the "First contacts"



files could be developed. A first short and free-of-charge version, and a more detailed version with paying access.

#### **6.1.8) PROSPECTS AND POSSIBLE EVOLUTIONS OF THE "FIRST CONTACTS" SERVICE**

In the second phase of the VHF project, this service will be essentially the same but the following two major modifications can be envisaged:

1) creation of a more extensive document database including regions and themes that haven't been retained in the first phase;

2) "sophistication" in the sense of a higher personalisation of the graphic user interfaces and introduction of real multilingual access facilities to the documents.

## **6.2) THE "THEMATIC BOOKLETS" SERVICE**

### **6.2.1) GENERAL DEFINITION OF THE "THEMATIC BOOKLET" SERVICE**

The objective is to create a so-called "intelligent" customer able to assist an human user in the realisation of some repetitive tasks for the :

collection,

authoring,

and diffusion of cultural or culturally relevant information.

Such repetitive tasks concern more particularly:

- the targetted search of cultural or culturally relevant information in (remote and heterogeneous) databases;
- the creation of generic document structures (DTDs in the SGML terminology),
- the authoring of concrete document versions,
- the management of dynamic documents (i.e. documents of which the structure may change during a consultation).

The service itself is functionaly structured in three main modules and a fourth

- minor - one:

- the **information research module**
- the **information consultation module**
- the **document creation module.**
- the **help & explanation module.**

Its **core** is constituted by **several document databases** - each one contains a specific type of documents such as:

- 1) summaries (of scientific articles or books) and syntheses (i.e. texts that are used in the Premiers Contacts service)
- 2) general/encyclopedic articles
- 3) (extracts of) scientific publications
- 4) interviews
  
- 5) photos
- 6) drawings
- 7) maps
- 8) graphical information
- 9) music
- 10) speech
- 11) video
- 12) references (bibliographies, ...)

The **information research module** is composed by:

- 1) a **geographic place** (country, region, ...) **index**
- 2) a **thematic index** (corresponding to the content of the researched cultural or culturally relevant information)
- 3) an **index** of so-called **meta-information** (author, date, language, ..., chromatics, view point, angle, pictorial frame, ...).

By the means of these three types of indexes, the user is invited to specify his information request. For further informations concerning the three types of indexes, please consult annex I, II and III of this report.

In the **consultation module** the selected documents (texts, photos, drawings, videos, ...) are exhibited to the user who can:

- back up the document in its totality
- or back up specific parts of it.

The back up of (whole or parts of) documents containing the requested information will be limited:

- with respect to the specific copyrights that govern each document contained in the database,
- with respect to the **quantity** of the selected documents.

In the **document creation module** the backed up documents :

- are assembled following a pre-defined document structures (i.e.a "**booklet**" structure including several variations)
- and proposed to the user for specific modifications that need a new access to the document database or for downloading it.

The system proposes the booklet in a file form with a fixed-format ready for publishing and/or printing or, in a WEB page form with an active linking for all selected URLs.

This last option is interesting for the quick generation of specific WEB pages from distant databases (generating WEB from WEB). In the field of electronic publishing this service can be used like an universal client capable to create heterogeneous documents in a sequential form from the Net ready for publishing.

### **6.2.2) SCENARISATION OF THE CONSULTATION OF THE "THEMATIC FILE" SERVICE**

Typically, the consultation of this service takes place as follows:

#### **1) Main Menu of the "Thematic File" service**

The page is organized by several independant, scrollable frames each one containing a specific index file for the research of the relevant information.

1.1) Short identification of the "Thematic Booklet" service.

1.2) The user is invited:

- either to consult the help/explanation service that describes in a few words the thematic file service and the actions that the user is expected to do),
- or to start the information research phase.

1.3) The user is requested to specify his information request by the means of the:

- geographic place index **or** an interactive map ,
- **and** thematic index
- **and** index of meta-information.

## **2) Information Research Result Screen**

2.1) Short specification that this page exhibits the results of the documents containing the requested cultural information

2.2) Short invitation of the user to examine the results of the request

2.3) Sequential display of the results:

- short descriptive phrase (i.e. there are NN scientific articles that may concern your request; there are MM drawings that may concern your request, ...)
- invitation of the user to consult the documents (i.e. would you like to consult the NN scientific articles)

## **3) Thematic Booklet Document Exploration Menu**

3.1) Short specification that this page exhibits the documents (drawings, articles, ...) that may contain the request informations

3.2) Short invitation of the user to examine each document

3.3) Short recall for the user that he may:

- directly download the document,
- back up a copy of the whole document (for the creation of his booklet)
- back up a copy of a part of the document (for the creation of his booklet).

3.4) Short recall that only these documents may be downloaded or backed up which are not submitted to specific copyrights.

3.5) Short recall that only a certain quantity of documents can be backed up.

3.4) The documents are displayed; the user download and/or back up a copy of them.

3.5) The user wants to restart the information search phase (---> back to the main menu of this service).

#### 4) The Thematic Booklet Creation Menu

4.1) Short specification of this page containing the assembled documents that the user has backed up previously (i.e. in stage 3).

4.2) Invitation to the user to consult the proposed booklet.

4.3) Short summary of structure, content and volume of the booklet:

- **structure:** form and organization (chapters, ...)
- **content:** the backed up and assembled documents
- **volume:** the informational quantity represented by the whole instanciated booklet.

4.4) Display of the front page of the booklet and the - interactive - page of contents and invitation to the user to examine - sequentially or not - the booklet.

4.5) The user examines the assembled documents in the different chapters of the booklet.

4.6) The page in which a chapter of the proposed booklet is displayed, contains following "buttons":

- **ok** (the user agrees with the content of the displayed chapter)

- **modify** (the user will modify locally the displayed chapter)
- **request** (the user prefer to change the backed up document with another one and claims therefore for a new request in the database restricted to the type of the document under consideration).

4.7) At the end, the user is requested to download the booklet.

### **6.2.3) LAY OUT/INTERFACE DISPLAY MODEL**

#### **1. The Thematic Booklet Main Menu Screen**

This first display is composed by the following components:

- 1)- Recall of the general icons (= stable functions)
- 2)- A non interactive text of identification of this service
- 3)- Three capture areas operate in tandem with scroll-down menus corresponding to the geographical index, the thematic index and four specific meta-information indexes (one for textual information, one for static image and graphic information, one for video information, and one for sound information)



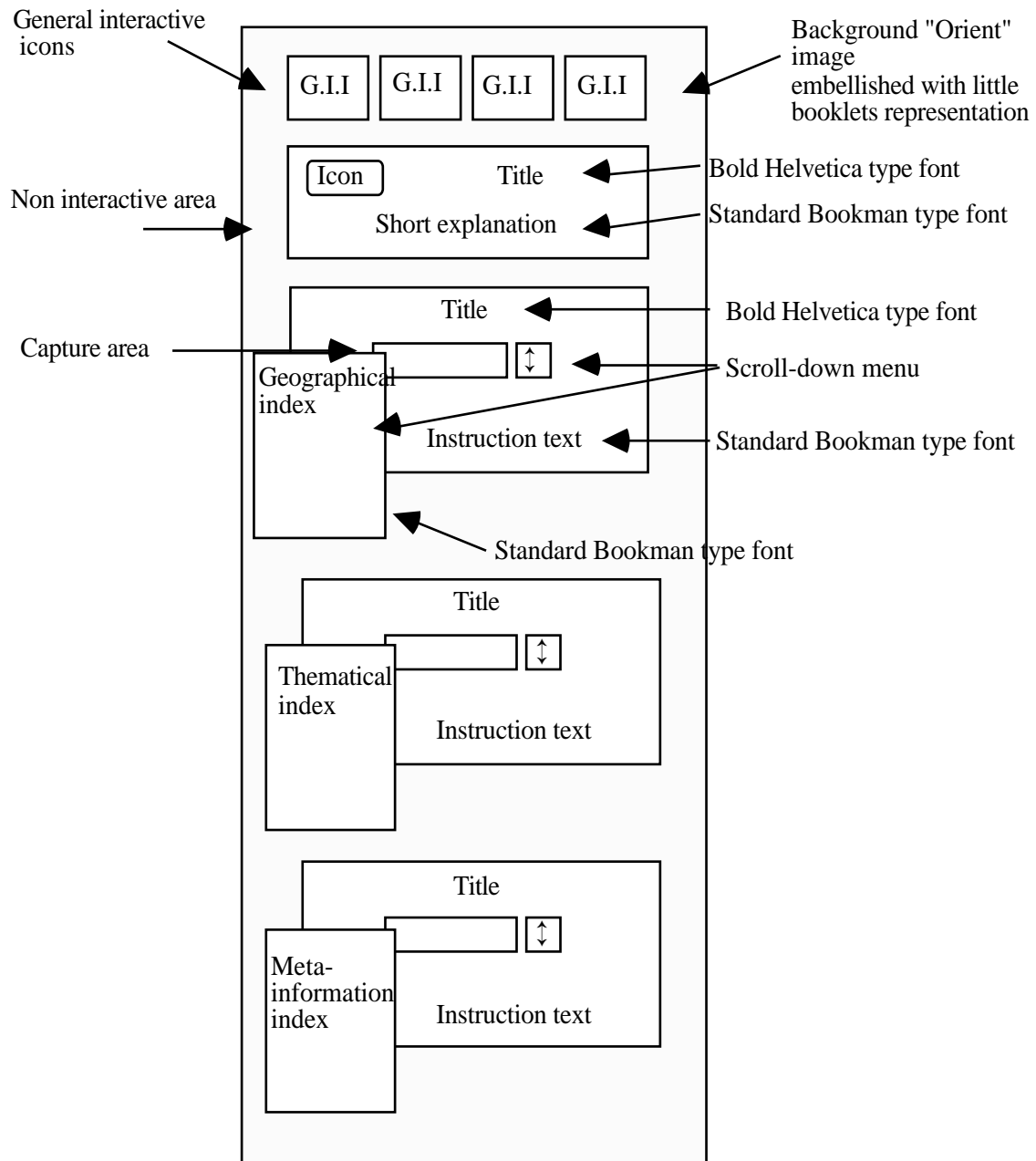

## 2. The Thematic Booklet Information Research Result Screen

This display is composed by the following components:

- 1)- Recall of the general icons (= stable functions):
- 2)- A space presenting the results of the first request

- 3)- An interactive text in the case of user wants to change his first chosen parameters
- 4)- A non interactive text describing the huge of information
- 5)- A clickable icon to consult the requested information

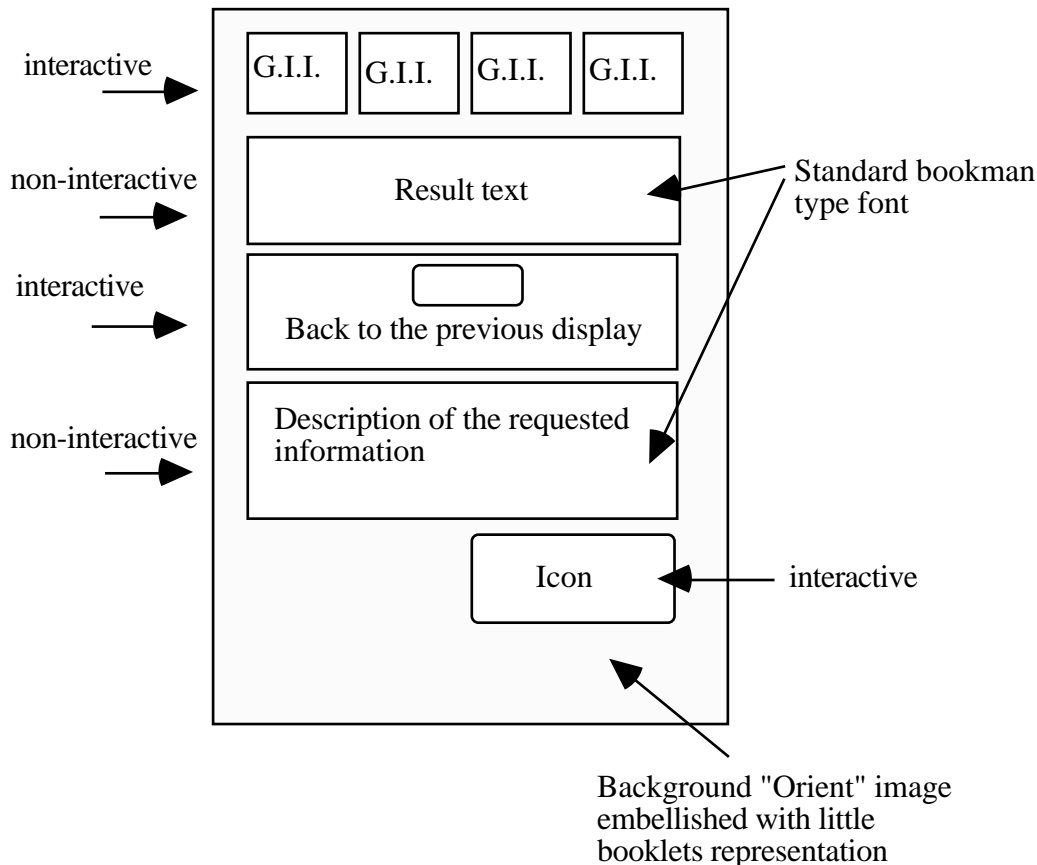

### 3. The Thematic Booklet Exploration Menu Screen

This display is composed by the following components:

- 1)- Recall of the general icons (= stable functions):
- 2)- Recall textual information space for: the specification, the functionalities, ...
- 3)- Some labeled folders presenting interactive data sheet forms (data sheet = viewing screen) with activate buttons
- 4)- A icon to go back to the Thematic Booklet Main Menu Screen

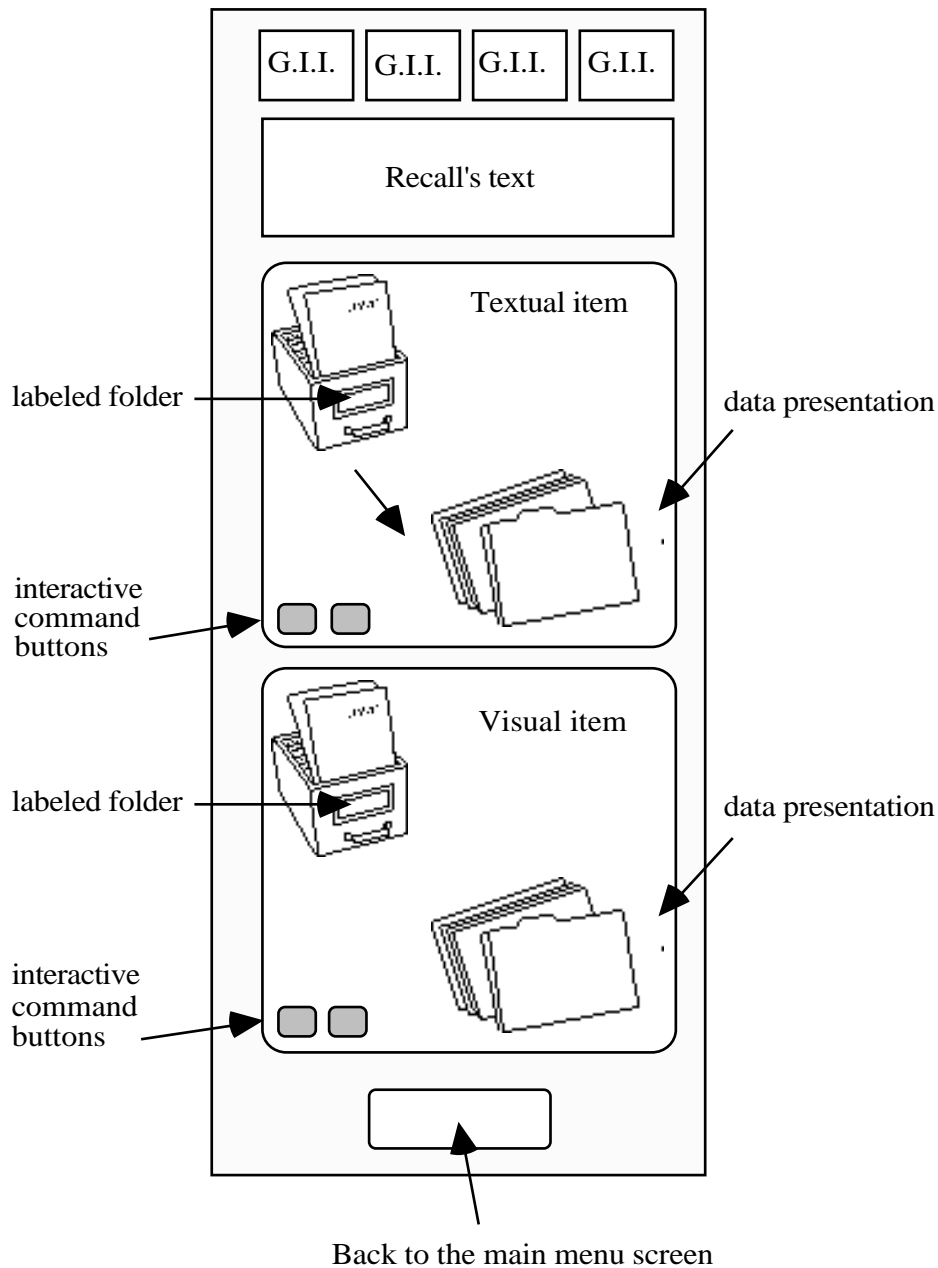

#### 4. The Thematic Booklet Document Creation Menu Screen

This display is composed by the following components:

- 1)- Recall of the general icons (= stable functions):
- 2)- A non-interactive specification text
- 3)- An interactive invitation to consultation

- 4)- A non-interactive text presenting the structure of the booklet
- 5)- Representation of the first page of the booklet under a spiral notebook form (following the file folder format) with interactive functions
- 6)- Presentation of the differents chapters under the notebook inner's pages format. Interactive buttons are attached at each page
- 7)- An interactive validation button to download the booklet.

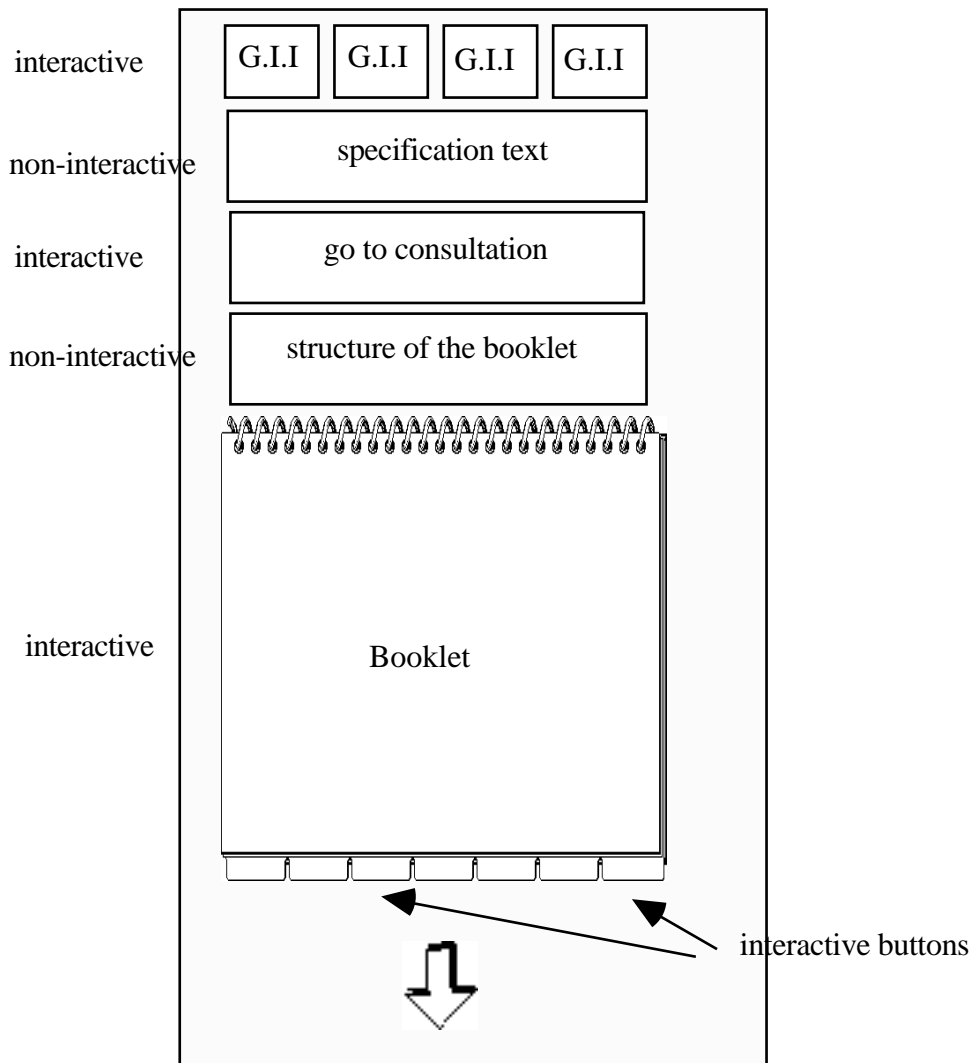

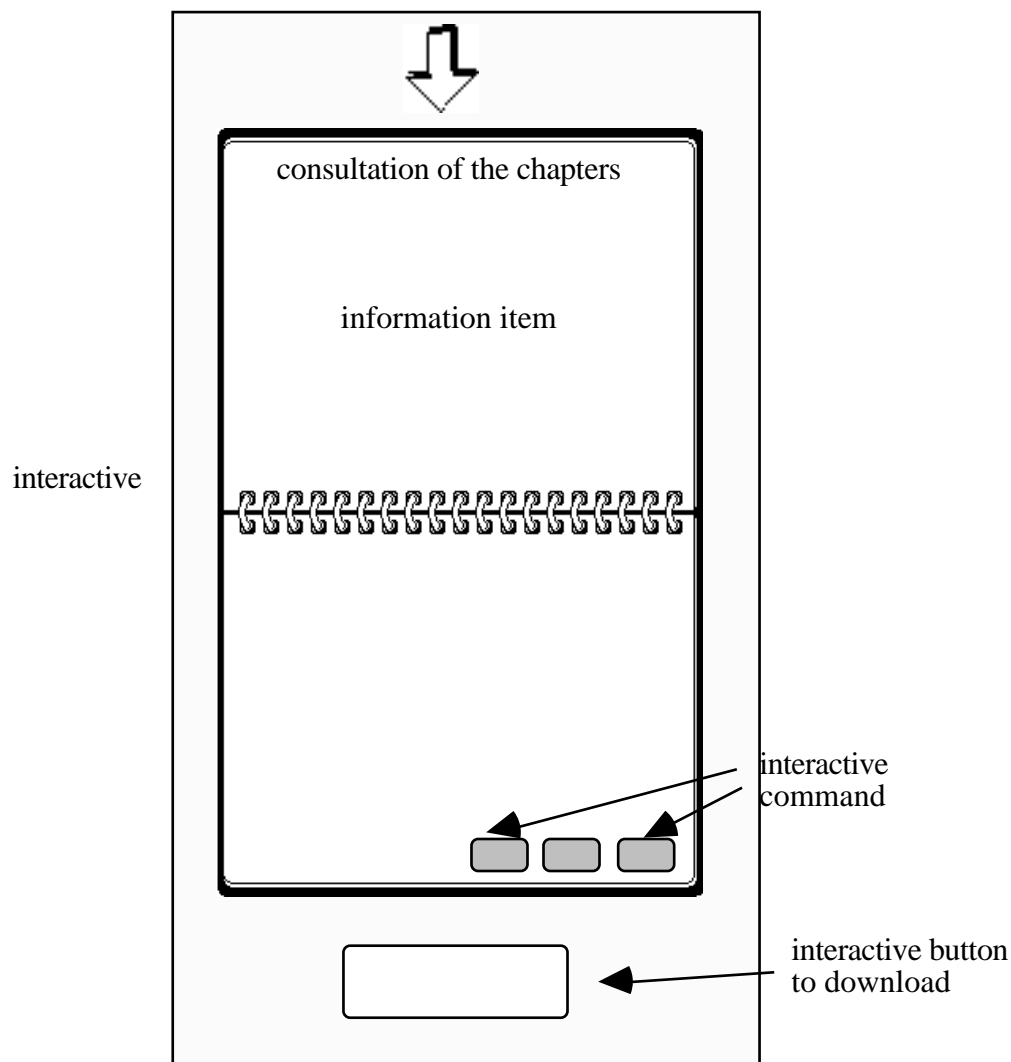

#### **6.2.4) IMPLEMENTATION OF THE "THEMATIC BOOKLET" SERVICE**

In this service all documents have to be correctly indexed in order to search them. The user can highly specify his search choice because of a set of fine grained parameters that represent the several kinds of documents.

The result is shown in HTML format with active links. The user can save and/or back up each consulted document and attribute it some specific place in a pre-defined document structure called the "thematic booklet": such places are, for instance: summary, synthesis, article, testimony, ...

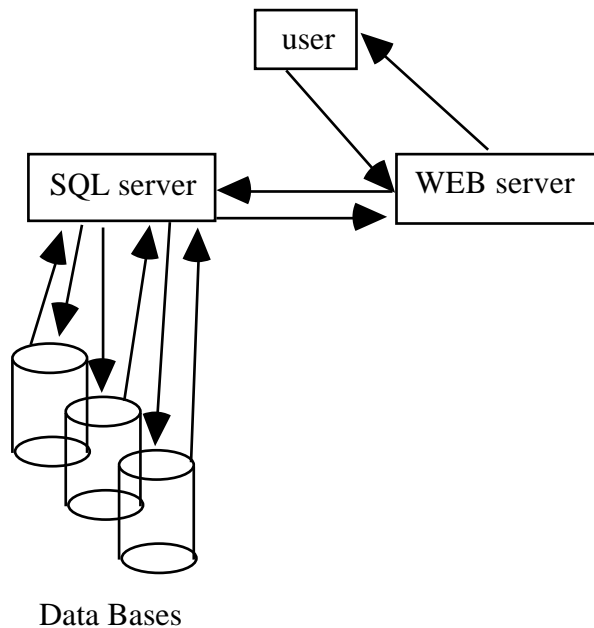

In order to implement this service an SQL data base will be developed with associated tables for each type of documents using sql instructions like :

```
CREATE TABLE document
(
    id_doc          id_doc
    doc             var_char(20)
    type           char(15)
    author         char(30)
    country       char(20)
    date          date
    source        text
    language     char(10)
    region       char(30)
    theme        char(40)
)
```

An HTML page reflects all offered tables in the service. The user can select in lists of parameters, submit his request and executes the corresponding program that permit to select documents from the data base with selected arguments.

We can use this type of SQL instruction:

```
SELECT doc,type, author, country...
FROM document
WHERE doc=" xxx ", date=" xx-xx-xx ",...
```

The result in array form can be converted in HTML page using assistant WEB SQL. User having at his disposition WEB, can consult and save the selected documents in "thematic booklets " in a particular format with several parts: Title, summary, body, photos, video, synthesis and bibliography.

At the beginning of the consultation the personal " thematique booklet " is empty; the user save his documents and constructs his files to publish step by step calling this type of function implemented in an procedural language like C++.

The function *INSERT(file, document, part)* inserts document in file at "part" position,

We can write:

```
if document.type=summary
    INSERT(file, document,summary)
if document.type=article
    INSERT(file, document,body)
if document.type=photo
    INSERT(file, document,body)
if document.type=animation
    INSERT(file, document,video)
if document.type=synthesis
    INSERT(file, document,synthesis)
if document.type=bibliography
    INSERT(file, document,bibliography)
```

At end of this operation, we can consult the “ thematic booklet ” according the selected saving format. We propose 3 mode to save:

Print format without animations

HTML format with summary and active links:

title

summary

body

photo

animations

synthesis

bibliography

CD-ROM format: with selected documents sequentially linked ready for publishing.

Other functions (reserved to users with updating system rights) are anticipated in this service; they can insert new records, delete others, creating new tables...using scripts calling SQL instructions like INSERT or DELETE...etc.

#### **6.2.5) INFORMATION AND DOCUMENT GATHERING AND MAINTENANCE OF THE "THEMATIC BOOKLET" SERVICE**

Similar to the First Contacts service, the Thematic Booklets service is also based on multimedia documentsbut which are from a quantitative point of view much more important and from a cognitive one much more specialized pesupposing already some basic knowledge.

The different documents will be gathered by the several working groups that cooperate with the French VHF partners.

The selected documents will be checked by at least one specialist in order to guarantee a high quality of the content as well as of the representation modalities.



The selected documents will be digitalized and stored in a document database (SQL).

The maintenance of the documents will be accomplished, during the period of the VHF project, by domain specialists. After the end of the VHF project, new solutions have to be found.

The modifications of the Thematic Booklet service depends, naturally, on the results of the Control and quality evaluation of it.

#### **6.2.6) CONTROL AND QUALITY EVALUATION**

Exactly as the First Contacts service, also the Thematic Booklet service will be controlled and evaluated with the help of the following technics and procedures:

- statistical evaluation of the frequentation and local exploitation of the service by the users during given test periods,

- evaluation of the suggestions send by the users to the information service manager,

- evaluation of this service by specialists and experts (content evaluation, evaluation of the ergonomy of the organization and the interface displays)

- comparative and concurrential evaluation of this service with other services that are more or less similar to it and that are proposed by other sites.

#### **6.2.7) EXPLOITATION OF THE "THEMATIC BOOKLET" SERVICE**

Being a service with a significant expertise and technical input, "Thematic Booklet" should correspond, sooner or later, to an appreciable economical reward.

Paying users may originate from the following categories :

- Publishers with a specialization on Asia, culture or encyclopedia.
- Scholars
- Teaching institutions who will be able to produce teaching material.
- Tourism industry with a cultural vocation.
- Press specialized on travel, tourism, culture, politics...

#### **6.2.8) PROSPECTS AND POSSIBLE EVOLUTIONS OF THE "THEMATIC BOOKLET" SERVICE**

During the second phase of the VHF project, the Thematic Booklet service will be developed essentially with respect to its content coverage and the quality of the documents proposed.

Efforts will be undertaken to define the "Thematic Booklet" service in the direction of a more **commercially** oriented service for the medias, scholar institutions, and cultural representation institutions of France abroad.

Finally, the interactive creation process of the booklet itself will be problematized again with respect especially to:

- the pre-defined document structure (i.e. would it be possible to conceive a real "semiotic authoring scenario" - analogically to authoring tools such as -Authorware or Director - in order to improve the content and layout quality of the booklet with respect to the different user profiles ?);

- the "intelligent" search of complementary informations in physically distant as well as heterogenous data bases by the means of statistical and probabilistic digit units collocalisation methods (a research cooperation is envisaged with one of the leading lexico- and infometric research groups of the CNRS).

### **6.3) THE "WHO IS WHO" SERVICE**

#### **6.3.1) GENERAL DEFINITION OF THE "WHO IS WHO" SERVICE**

"WHO IS WHO" is an information service that proposes basic and structured multimedia information about personalities in arts, politic, economy, sciences, etc. subjects.

This service has been especially put on focus by the user needs & requirements analysis. In fact, users complain about the lack of complete biographical information.

Through this service, user will be able to get:

- general multimedia information of the personality
- specialised multimedia information based on a strong point of the personality.

Targetted user groups are the following:

- **institutional users** that need some bibliography for "working" a foreign country
- **journalists** and people working in the **mass media** who need some general and particularly specialized informations about a cultural, political, ... person for which it is difficult to get such informations,
- undergraduate **students** and **academic people** who have to work on cultural, political, ... bibliography recovered by this service

The "who is who" information service is composed by the following components and modules:

a) a **personality research module** which compose the Main Menu. The latter proposes to a user to choose in a combinaison of indexes (name index, activity's sector index, country of origin index and period index) the references about one personality

- b) a **consultation module** which compose the Exploration Menu. The latter set up by several independant frames in which can be consulted the relevant multimedia documents
- c) a **creation module** composed by the the selected relevant information. The user is invited to create his **own "little magazine"** in a pre-formatted paper
- d) an **explanation & help module** which is directly accessible by the main menu and allows the connection to the others modules
- e) **Several document databases** (textual, non-animated visual, animated visual and, sound databases) constituting the core of the system
- f) a simple **explication & help service** for users who are consulting the first time the Who is who service.

The **personality research module** is composed by:

- 1) a **name index** (corresponding to the name of the personality according to an alphabetic list)
- 2) an **activity's sector index** (corresponding to the speciality's domain of the personality)
- 3) a **country index** (corresponding to origin of the personality)
- 4) a **period index** (corresponding to the live period of the personality)

The **consultation module** is composed by a choice between the selected documents (texts, photos, drawings, videos, ...).

So the user can: either consult the totality of the documents, or make his own selection between the different types of relevant information.

After the consultation the user can back up some selectioned documents with respect to the specific copyrights that govern each document contained in the database and create his own information sheet.

The **creation module** is composed by all the selected relevant information back up by the user in the consultation module. In this module, the user can create a kind of "little magazine. The system presents under a pre-formatted form the blank lay-out of one magazine's page. The user is invited to fill this model with his back up.

The **databases** are composed by the relevant information about one personality. Each medium support is taken into account.

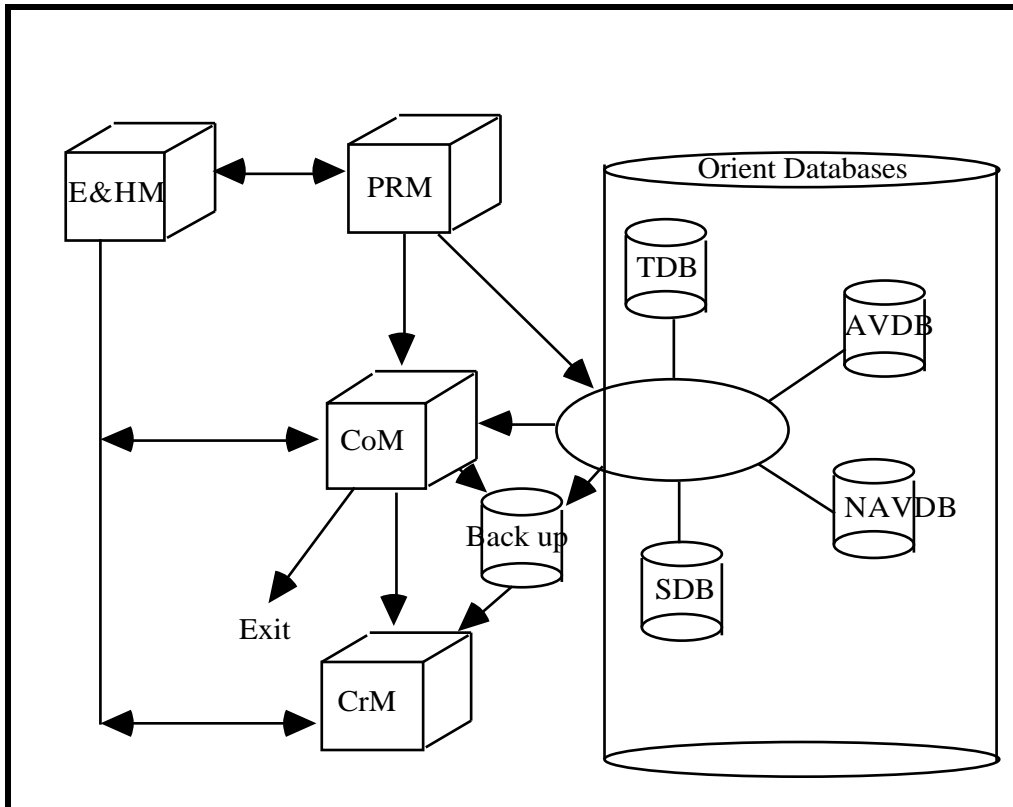

### 6.3.2) SCENARISATION OF THE CONSULTATION OF THE "WHO IS WHO" SERVICE

The consultation of this service takes place as follows:

#### **1) Main Menu of the "Who is who" service**

The page is organized by several independant capture areas each one containing a specific index file for the research of the relevant information.

1.1) Short identification of the "Who is who" service.

1.2) The user is invited:

- either to consult the help/explanation module that describes in a few words the service and the actions that the user is expected to do,
- or to start the information research on one personality.

1.3) The user is requested to specify his information request by the means of the:

- the Name index **or** by the means of the:
- Activity's sector index
- **and** Country of origin index
- **and** Period index.

## 2) "Consultation Module" Menu Screen

2.1) Short specification that this page exhibits the results of the documents containing the requested information

2.2) Sequential display of the results:

- either the user has directly found the name of the personality (through the name's index) so he gets the information about him,
- or he selected some parameters through the others indexes and he gets a new name's list which he can select the name of his choice.

2.3) Short invitation of the user to examine the documents (attached to one name)

2.4) The user explores the relevant document datas

This is the screen organized by three (or four) scrollable frames in which the multimedia documents appear (i.e. one frame for texts, a second frame for non-animated visual information, a third frame for animated information, a fourth frame for the aural information)

2.5) Short recall for the user that he may:

- directly download the document,
- back up a copy of the whole document (for the creation of his page's magazine)

back up a copy of a part of the document (for the creation of his page's magazine).

2.6) Short recall that only these documents may be downloaded or backed up which are not submitted to specific copyrights.

### **3) "Creation Module" Menu Screen**

2.1) Short specification

2.2) Visualization of the pre-formatted form in order to put the back up documents

2.3) Visualization of the back up documents into scrollable frames

2.4) Invitation to the user to fill up his own page's magazine with the back up documents.

### **4) "Explanation & Help Module" Module Screen**

2.1) General idea of the potentialities of the systems belonging to the "Who is who" service.

2.2) the user can:

- either get more explications about the procedures of all the service
- or access to the different module.

#### **6.3.3) THE LAY OUT/INTERFACE DISPLAY MODEL**

##### **1) Main Menu of the "Who is who" service**

This first display is composed by the following components:

- 1)- Recall of the general icons (= stable functions)
- 2)- A non interactive text of identification of this service
- 3)- Four capture areas operate in tandem with scroll-down menus corresponding to the name index, the activity's sector index, the country of origin index and the period index .

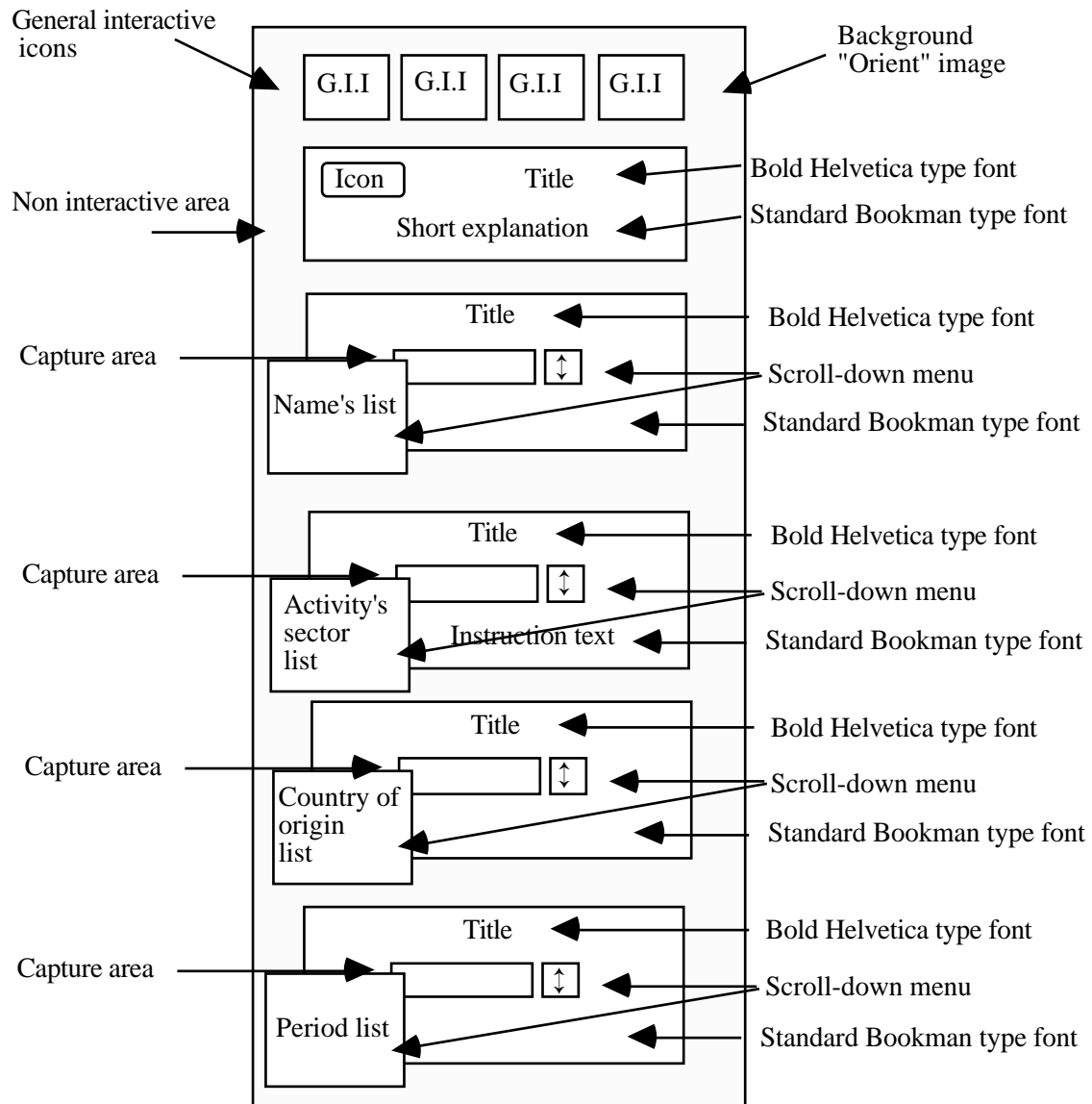

## 2) "Consultation Module" Menu Screen

This display is composed by the following components:



- 1)- Recall of the general icons (= stable functions)
- 2)- Short explanation of the results
- 3)- The user is invited:
  - either consult the documents
  - or select a name through a new scrollable menu
- 4)- The user is invited to consult the selected information as he read a magazine:
  - either the basic resume of the personality (representation of a "virtual page" of one magazine)
  - or specialised documents made by different medium (representation of the double-page of an electronic magazine (= e-magazine), in this case each medium support information is presented in one specific scrollable frame),
- 5)- Different control commands are available:
  - back up command,
  - connection to others services

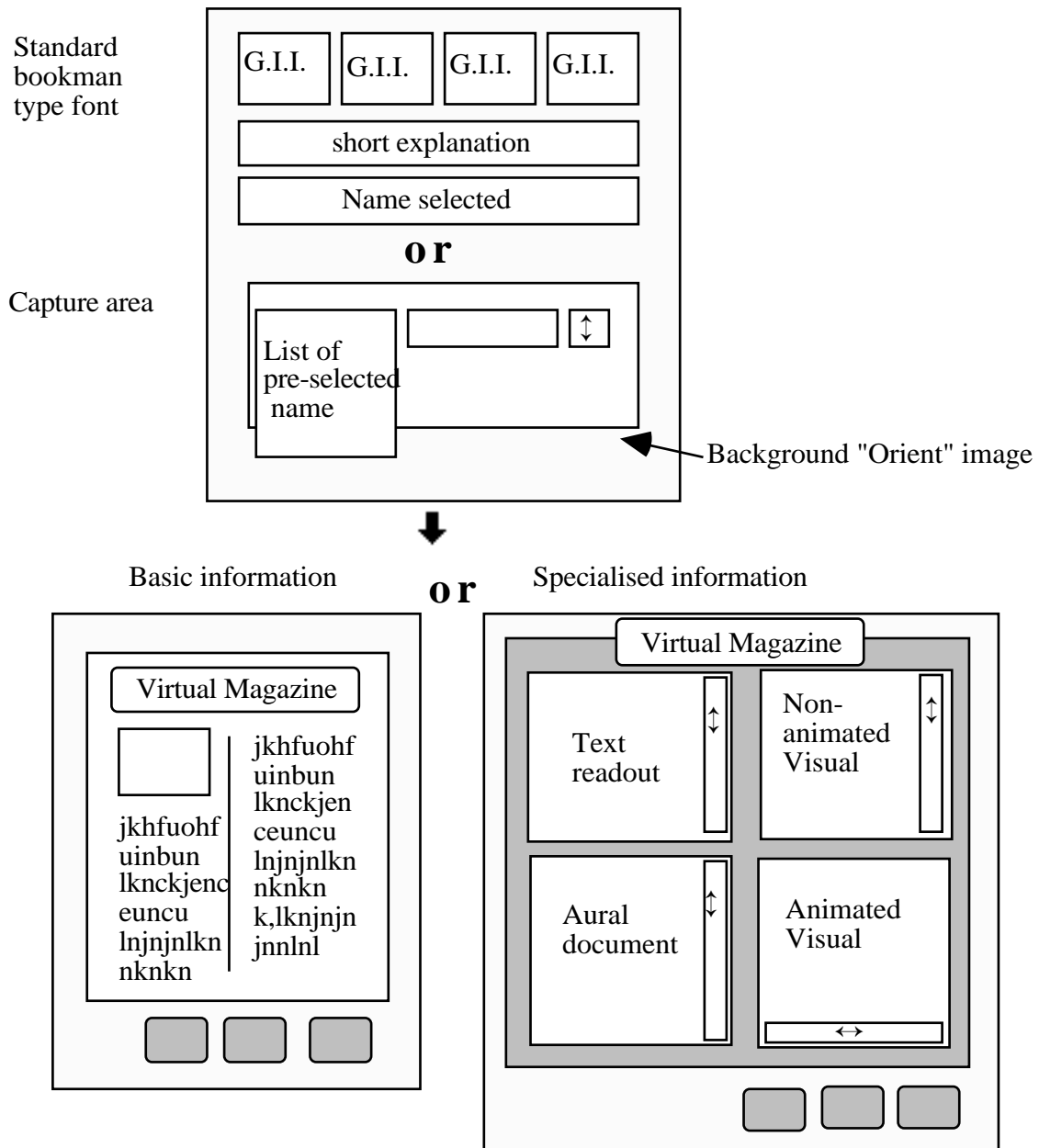

### 3) "Creation Module" Menu Screen

This display is composed by the following components:

- 1)- Recall of the general icons (= stable functions)
- 2)- Short explanation of the results

3)- The screen is divided in two different frames.

One frame is reserved for the consultation and the validation of the back up documents, the other one shows the presentation of the pre-formatted lay-out of the "little magazine".

4)- The user is invited to consult his back up documents

5)- The user is invited to valid his consultation in order to fill up his magazine's page with their back up documents

6)- The user is invited to download his "little magazine"

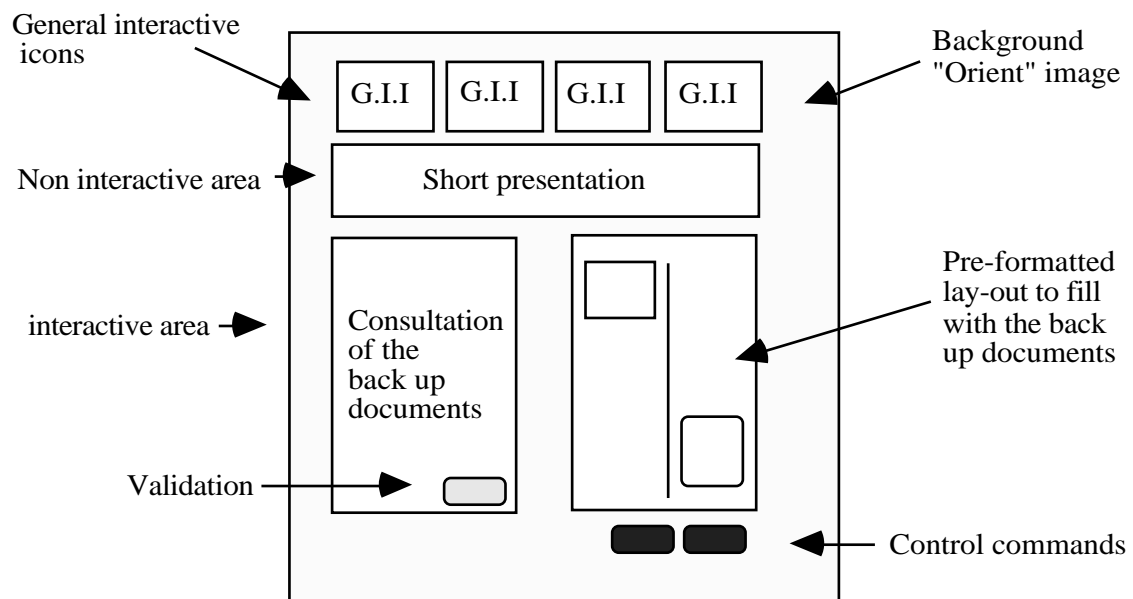

#### **4) "Explanation & Help Module" Module Screen**

This screen is very simple. Particularly the functional aspect has been put on focus.

This display is composed by the following components:

- 1)- Recall of the general icons (= stable functions)
- 2)- A non-interactive text given explanations and working modes about this service.
- 3)- Interactive command for the connection to the others modules.

#### 6.3.4) IMPLEMENTATION OF THE "WHO IS WHO" SERVICE

The "Who is who" is a dynamic service that evolves in two ways :

- Reaction to user's evenements like backround task when he chooses consultations themes and changes context. This task selects personalities in the select domain.

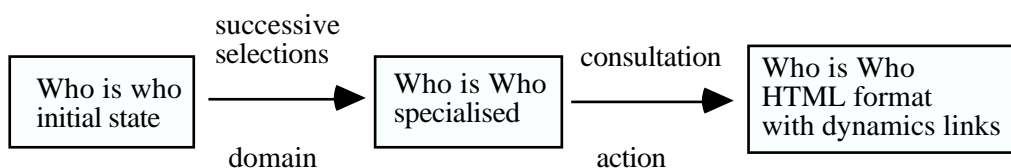

- At a given moment when the user decides to consult "who is who" in the sub-service, we active an search program that extracts and displays from the personalities data bases, all names, works and summaries.

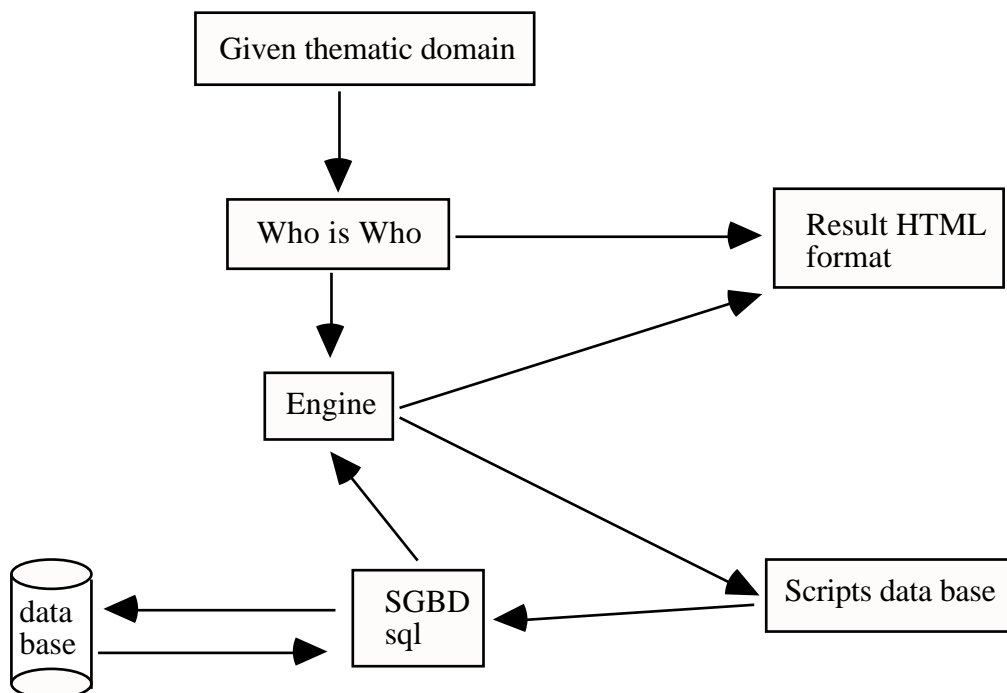

An data base corresponding to all personalities will be create according the SQL model. Specific scripts that execut user's choice will also be developped. The result will be displayed in HTML format with eventual dynamic links to summaries, works or home pages.

#### **6.3.5) INFORMATION AND DOCUMENT GATHERING AND MAINTENANCE OF THE "WHO IS WHO" SERVICE**

"Who is Who" files will be written by advanced students of the INALCO. These texts will be supplemented by pictures and bibliographical references coming from the resources of the libraries associated to the project. Many biographies or personnality focused articles are directly available among the numerous publications of the INALCO researchers.

Another information source are the different libraries of Paris such as the Bibliothèque Administrative specialized in this particular subject.

#### **6.3.6) CONTROLE AND QUALITY EVALUATION OF THE "WHO IS WHO" SERVICE**

Similarly to the prviously described information services, control and quality evaluation will be essentially based on the following technics and procedures:

- statistical evaluation of the frequentation and local exploitation of the service by the users during given test periods;
- evaluation of the suggestions send by the users to the information service manager;
- evaluation of this service by specialists and experts (content evaluation, evaluation of the ergonomy of the organization and the interface displays);

- comparative and concurrential evaluation of this service with other services that are more or less similar to it and that are proposed by other sites.

### **6.3.7) EXPLOITATION OF THE "WHO IS WHO" SERVICE**

As the "First Contacts" service, "Who is Who" is not primarily a free access service. However, two levels of access could be imagined, with detailed information being charged.

This apply particularly well to "Who is Who", as long as this service may be specially valuable for the press whenever a noticeable event occur and information on a particular personality is needed.

The "Who is Who" service will be developped especially for media and publisher purposes as well as for the "cultural management" (i.e. for decision makers of museums, art galleries, exposition halls, ...)

### **6.3.8) PROSPECTS AND POSSIBLE EVOLUTIONS OF THE "WHO IS WHO" SERVICE**

In the second phase of the VHF prpoject, the "Who is Who" service will be sespecially developed as far as the content level is concerned (i.e. collection and acquisition of data concerning personalities).

An other investigation will concern a more "intelligent" organization of the "Who is Who" journal in the sense that the pre-defined document structure should better mirror a specific gender structure called "**portrait**".

## 7) TRAVEL AND TOURIST SERVICE

### 7.1) THE "TOURISTS' BAG" SERVICE

#### 7.1.1) GENERAL DEFINITION OF THE "TOURISTS' BAG" SERVICE

The Tourists' Bag service proposes for the different categories of tourism (cultural tourism, business tourism, gastronomic tourism, sport tourism, family tourism, individual tourism, ...) several more practical information that:

- are useful for the good planification and realization of a travel especially in a country or region of Asia, Oceania or Africa,
- constitute an interesting and securing information package that accompanies specialized - thematic oriented - offers of tourist operators such as Terre d'Aventure - a French company that cooperates on this point with the French partners of the VHF consortium,
- permits - more generally - to study on-line, interactive advertising strategies for touristic sites as well as touristic operators.

The Tourist Bag service is composed by the following six cultural and tourist information modules:

1) The **Travel Preparation Module** (comprising information concerning general information concerning the country (region) < link to Premiers Contacts>

- application procedures: passports, visas,
- international travel connections
- tourist operators & agencies
- choice of a travel period
- costs & budget planning
- what to pack: toiletries, pharmaceuticals, cameras and film, ...
- what not to pack



expectable difficulties  
currency & payment facilities)

2) The **Sojourn Module** (comprising information concerning

health,  
security  
hotel accomodation,  
transportation facilities  
cultural sites (historical monuments, museums, religious places)  
alimentionation & gastronomy,  
postal service & telecommunications,  
daily life  
cultural events & exhibitions,  
communicating with people & social life,  
language basics  
shopping,  
fashion,  
souvenirs & presents,  
recreation  
...)

3) The **Special Tourist Information Module** (comprising information concerning

business travels  
sportive circuits  
cultural circuits  
family sojourns  
young people & students  
...)

4) The **Travel and Sojourn Offer Module** (of Terre d'Aventure) is essentially composed of a list of travel and sojourn offers (structured by the following criterias:

tourist operator,

country,  
 type  
 short general description  
 travel & sojourn planning details  
 season  
 price  
 extras)

5) The interactive **Tourists' Vademecum Creation** Module (this module looks like the Booklet Creation Module in the Thematic Booklet service:

- the user is invited to back up the relevant informations in the first three modules

- these informations will be assembled in a predefined document structure which is the characteristic structure of the Tourists Vademecum - a little, handy and personnalized document that contains these informations that the tourist considers himself to be relevant for his objectives,

- the predefined document structure contains also free places (spots) that are reserved for advertising information (of tourist operators, hotels, restaurants, regional or national tourist offices, ...)

6) The **Explication/Help Module** is a simple service for users who connect the first time to the Tourists' Bag service

7) The **Travellor Discussion & Exchange Forum Module** is a module in which people can:

- leave travel hints for other people (i.e. hints of how to travel well in the provinces in China, "insider" addresses, ...)

- leave questions and asks for help (travelling in a group, housing facilities, ...)

- leave suggestions to the manager of this service.

Furthermore, the Tourist Bag service is provided with:

- 1) an interactive geographic map (similarly to the the map in the First Contact service) by the means of which, the user can choose a specific country or region
- 2) a geographic index by the means of which, the user can choose a specific country or region,
- 3) a specialized thematic index for this service by the means of which the user can directly access to a required practical information
- 4) a key-word search engine.

The Tourist Bag service is linked to  
 the First Contact Service,  
 the News Service and  
 specialized touristic servers

### **7.1.2) SCENARISATION OF THE CONSULTATION OF THE "TOURISTS' BAG" SERVICE**

A typical consultation session will be accomplished through the following phases:

#### **1) Main Menu**

1.1) Short presentation of the service

1.2) The user is invited :

- either to click on the Explication & Help Module button (---> simple text)
- or to click on the Travellers' Discussion and Exchange Forum button (---> forum)
- or to click on the geographic index or on the interactive map in order to chose a destination country (or region)

1.3) The user choses a destination country

## **2) The Tourists'Bag Country Screen**

2.1) The Tourists'Bag country screen opens with a short presentation line ("Vous êtes ...")

2.2) A second line specifies the objective of this screen, i.e. the constitution of a useful "bag" of information for the tourist - bag which can be edited as a Vademecum for the personal use of the tourist.

2.3) In order to gather the information the user wants to obtain, he is invited :  
 either to click on the Travel Preparation Module button  
 or to click on the Sojourn Module button  
 or to activate the special tourist bag thematic index (cf. Annex IV).

2.4') The tourist clicks on the Travel Preparation button (---> cf. 3)

2.4'') The tourist clicks on the Sojourn button (---> cf. 5)

2.4''') The user clicks on the Travel and Sojourn Offer button (---> cf. 7)

2.4''''') The tourist clicks on the thematic index (---> cf. 9)

## **3) The Travel preparation Menu (for one specific country)**

3.1) Short presentation of this screen and its objectives ("Vous êtes ...")

3.2) Invitation of the user to choose among the different themes that constitute the Travel preparation module (which are exhibited on the screen as interactive buttons)

3.3) The user chooses

## **4) The Travellers Bag Information Exploration Screen**

4.1) Short presentation ("Vous êtes ...")

4.2) One or several scrollable frames in which the textual or visual information appears

4.3) Maybe: one thematically motivated links to the News Service in order to guarantee continuously up-dated information

4.4) One or more links to related specialized information servers in order to guarantee the user a rather complete information service on a specific theme

4.5) The user consults the information and back up these informations which are in the VHF server

### **5) The Sojourn Menu (for one specific country)**

5.1) Short presentation of this screen and its objectives ("Vous êtes ...")

5.2) Invitation of the user to choose among the different themes that constitute the Sojourn module (which are exhibited on the screen as interactive buttons)

5.3) The user chooses

### **6) The Travellers Bag Information Exploration Screen (bis)**

6.1) Short presentation ("Vous êtes ...")

6.2) One or several scrollable frames in which the textual or visual information appears

6.3) Maybe: one thematically motivated links to the News Service in order to guarantee continuously up-dated information

6.4) One or more links to related specialized information servers in order to guarantee the user a rather complete information service on a specific theme

6.5) The user consults the information and back up these informations which are in the VHF server

## **7) The Travel and Sojourn Offer Screen**

7.1) Short presentation of this screen and its objectives ("Vous êtes ...")

7.2) Invitation to the user to choose among:

tourist operators

types of offer

period

budget level

7.3) Invitation to the user to give a look especially to THAT offer(s) (i.e. offers of Terre d'Aventure, ...)

7.4) The user chooses

## **8) The Travellers Bag Information Exploration Screen (ter)**

8.1) Short presentation ("Vous êtes ...")

8.2) One or several scrollable frames in which the offers appear

8.3) One or more links to related specialized information servers in order to guarantee the user a rather complete information service on a specific offer

8.5) The user consults the information and backs up one or more offers

## **9) The Special Thematic Index Menu**

9.1) Short Presentation of this screen

9.2) (linear or planar) exposition of the different themes that constitute the Travel Preparation and Sojourn Module

9.3) The user chooses

## **10) The Travellers Bag Information Exploration Screen (ter)**

10.1) Short presentation ("Vous êtes ...")

10.2) One or several scrollable frames in which the (textual or visual) informations concerning a chosen theme appears

10.3) One or more links to related specialized information servers in order to guarantee the user a rather complete information service of a chosen theme

10.4) The user consults the information and backs up these informations which are stored in the VHF server

## **11) The Tourist's Vademecum Creation Menu**

11.1) Short specification of this page containing the assembled documents that the user has backed up previously .

4.2) Invitation to the user to consult the proposed vademecum.

4.3) Short summary of structure, content and volume of the vademecum

- **structure:** form and organization (chapters, ...)
- **content:** the backed up and assembled documents
- **advertising information:** the advertizing companies & institutions
- **volume:** the informational quantity represented by the whole instanciated vademecum.

4.4) Display of the front page of the vademecum and the - interactive - page of contents and invitation to the user to examine - sequentially or not - the vademecum.

4.5) The user examines the assembled documents in the different chapters of the vademecum.

4.6) The page in which a chapter of the proposed vademecum is displayed, contains following "buttons":

- **ok** (the user agrees with the content of the displayed chapter)
- **modify** (the user will modify locally the displayed chapter)

4.7) At the end, the user is requested to download the vademecum.

### **7.1.3) LAY OUT/INTERFACE DISPLAY MODEL**

#### **1) The Main Menu Screen**

This display is composed by the following components:

- 1)- Recall of the general icons (= stable functions):
- 2)- A non-interactive presentation text
- 3)- Two interactive buttons: one linked to the help module, the second to the forum module
- 4)- A capture area operate in tandem with a scroll-down menu corresponding to the geographical index
- 5)- An interactive map (made of clickable areas)



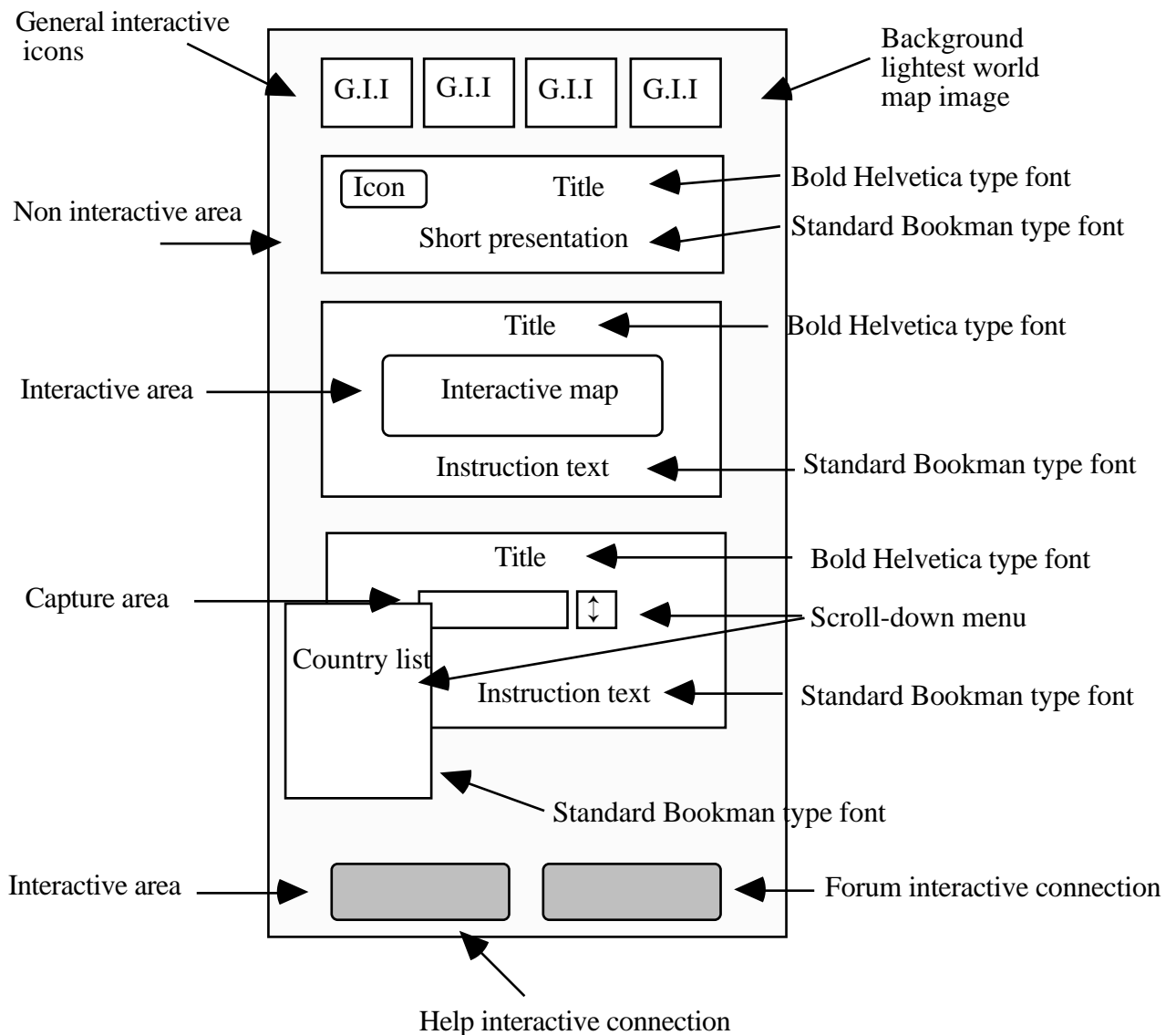

## 2) The Tourists' Bag Country Screen

This display is composed by the following components:

- 1)- Recall of the general icons (= stable functions):
- 2)- A non-interactive presentation line follow by the objectives  
An interactive traveller (animation) must choose between four "interactive bags":
- 3)- An interactive bag representation to go to "travel preparation"
- 4)- An interactive bag representation to go to "sojourn"

- 5)- An interactive bag representation to go to "travel & sojourn offer"
- 6)- An interactive bag representation to go to "thematic index"
- 7)- A non interactive country's visualization.

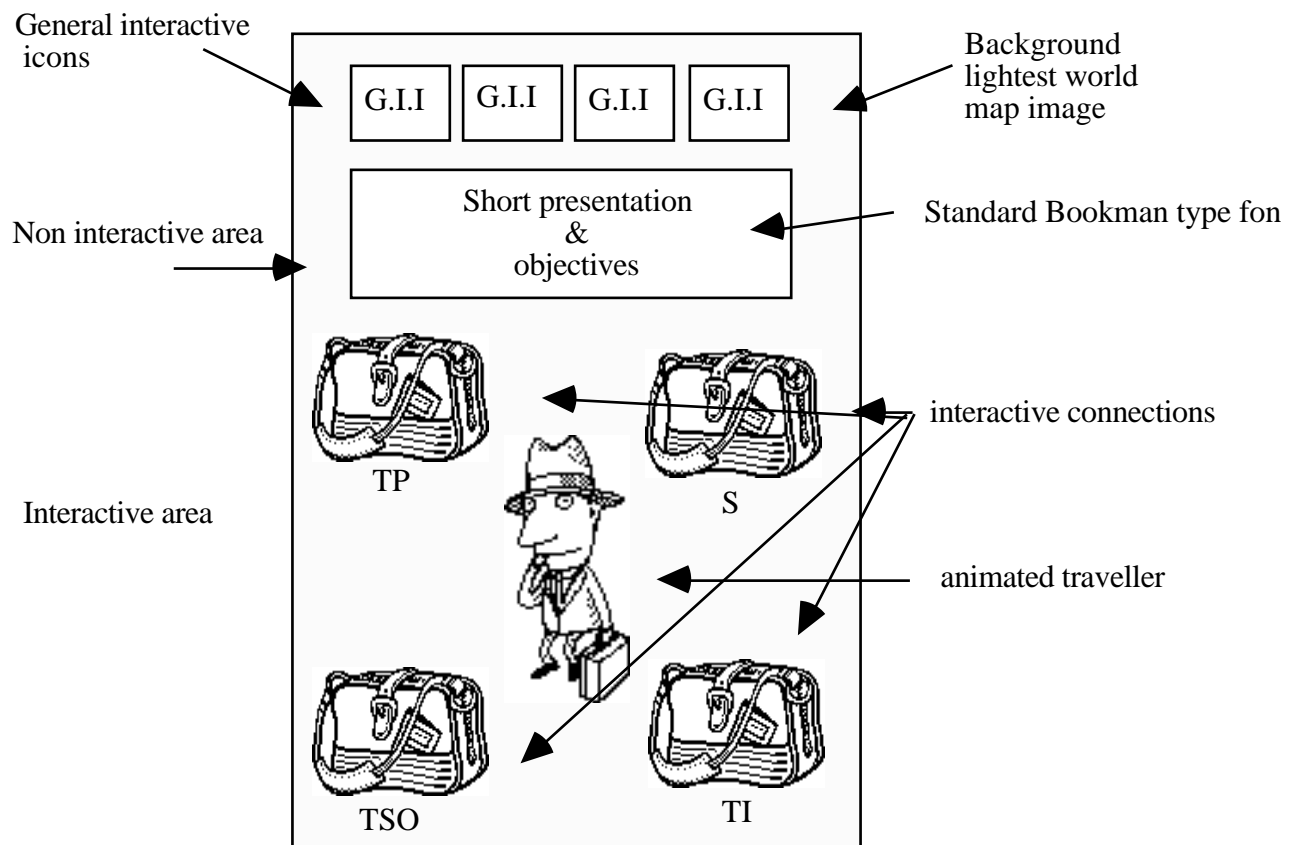

### 3) The Travel preparation Menu Screen (for one specific country)

This display is composed by the following components:

- 1)- Recall of the general icons (= stable functions):
  - 2)- A non-interactive specification text
  - 3)- (According to an animation, the selected bag is open and different objects come out. Each objects become an interactive component of the screen).
- Each component to be selected is a metaphor pictorial design representation of the thematic of the travel preparation module.

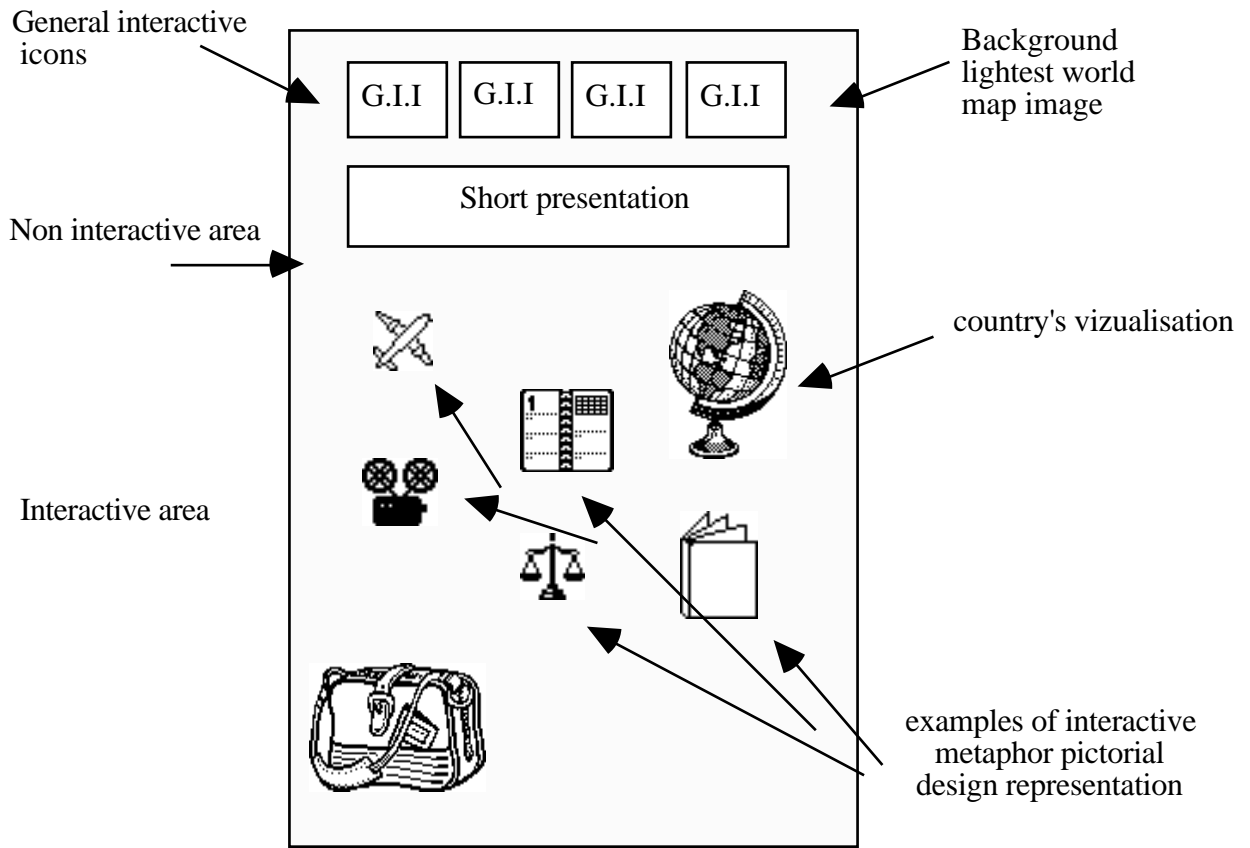

#### 4) The Travellers Bag Information Exploration Screen

This display is composed by the following components:

- 1)- Recall of the general icons (= stable functions):
  - 2)- A non-interactive specification text
  - 3)- Some interactive display frames showing the textual and visual references.
- Each display frames corresponds to one metaphor representation.  
The user can "explore", "download", ... and, come back.

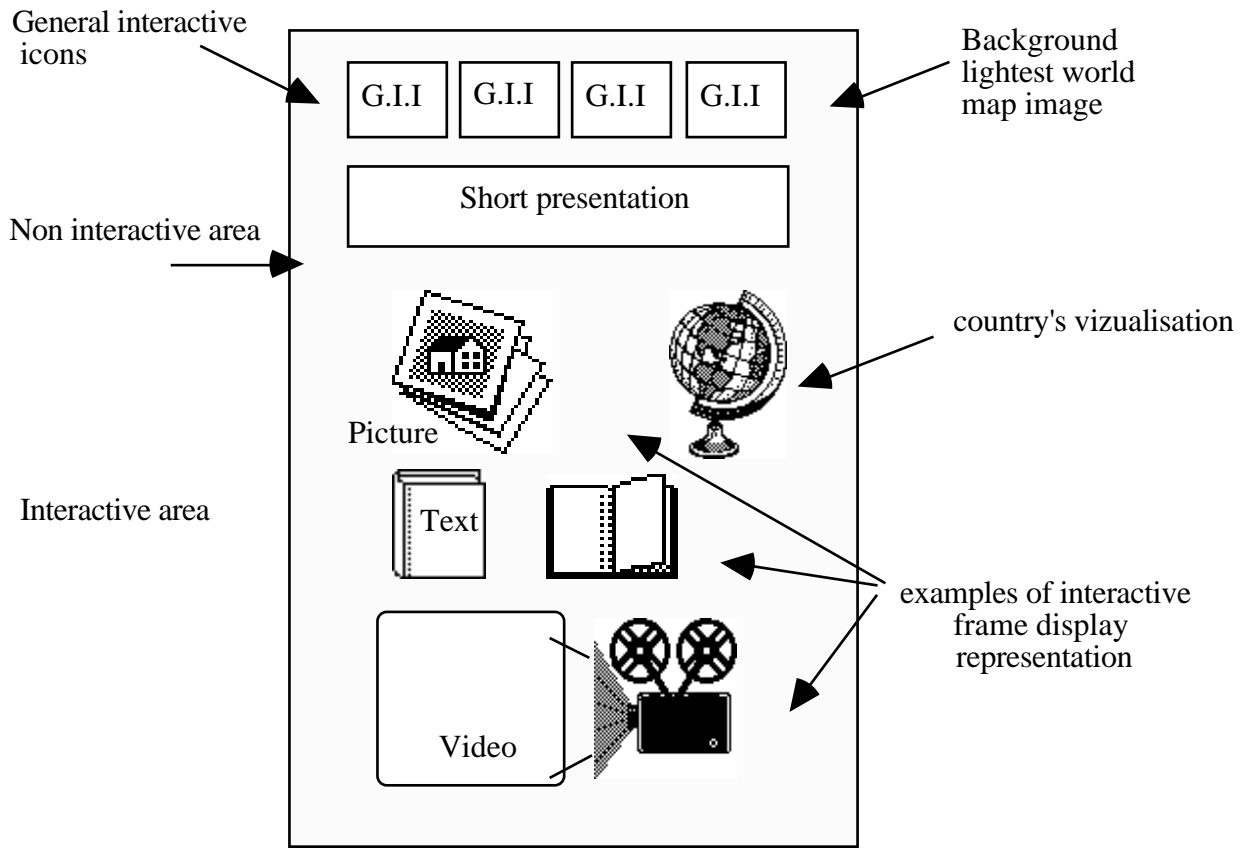

### 5) The Sojourn Menu Screen (for one specific country)

This display is composed by the following components:

- 1)- Recall of the general icons (= stable functions):
  - 2)- A non-interactive specification text
  - 3)- (According to an animation, the selected bag is open and different objects come out. Each objects become an interactive component of the screen). Each component to be selected is a metaphor pictorial design representation of the thematic of the sojourn menu.(Cf.supra)
  - 4)- A non interactive map representation of the selected country
  - 5)- Clicking on one interactive component, some interactive display frames come through to present the textual and visual references. Each display frames corresponds to one metaphor representation.
- The user can "explore", "download", ... and, come back. (Cf.supra).

## 6) The Travel and Sojourn Offer Screen

This display is composed by the following components:

- 1)- Recall of the general icons (= stable functions):
  - 2)- A non-interactive specification text
  - 3)- Some interactive references of the tourist operators (made by their advertising, their logo, etc.), the types of offer, the period and, the budget level come through the open bag. Each interactive icon aims to go to the consultation level
  - 4)- An interactive "New Offer" icon aims to link with "Terre d'aventure" server.
- 5)- Once user is down to the consultation level, he can choose on display frames their data references. Each display frames corresponds to one metaphor representation.
- The user can "explore", "download", ... and, come back. (Cf.supra).

## 7) The Special Thematic Index Menu Screen

This display is composed by the following components:

- 1)- Recall of the general icons (= stable functions):
  - 2)- A non-interactive specification text
  - 3)- Some interactive metaphor pictorial representation constitute the specific indexes with his capture areas.
- Clicking on one component, the index come through. The user make his choice between all the indexes.
- 4)- Some interactive display frames shows the result of the choice.
- Each frame is a "little window display" and have an adjustable size according to the data recording medium and, their number.
- One display frame is composed by textual information (with scrollable function if necessary), another one by graphical information (with scrollable function if necessary), another by visual information (with scrollable function if

necessary), another by an animated visual information (with video function if necessary).

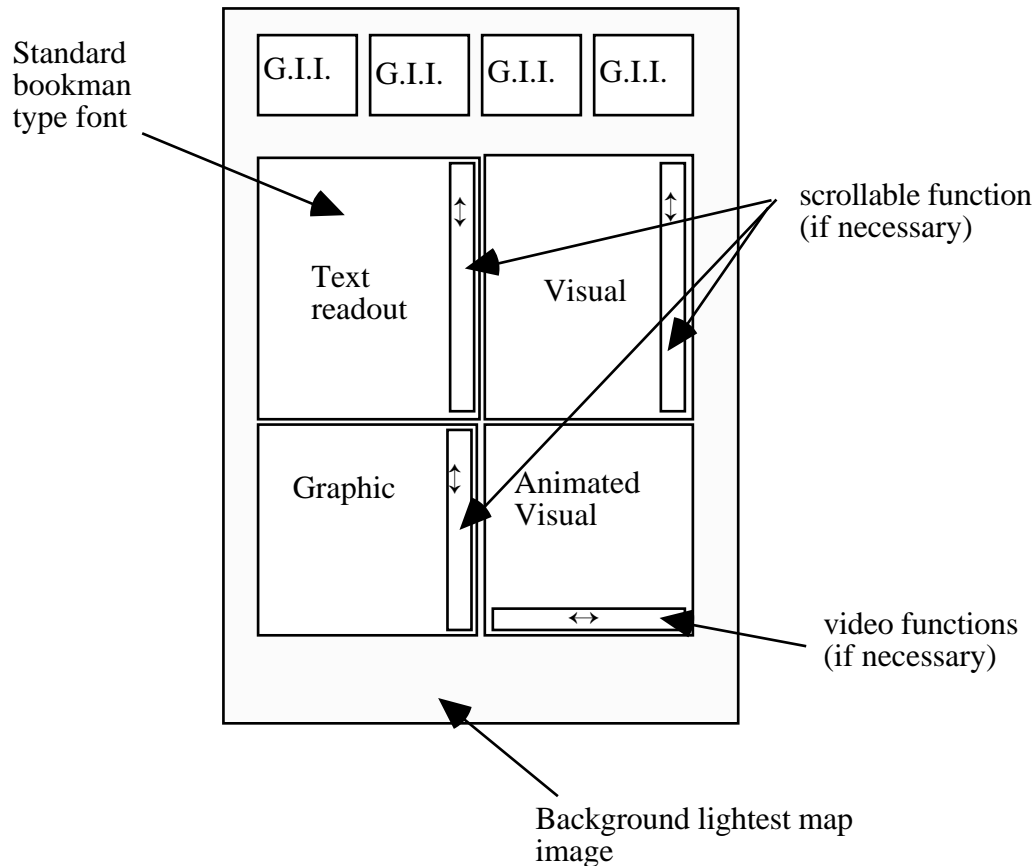

## 8) The Traveller Discussion & Exchange Forum Screen

This display is composed by the following components:

- 1)- Recall of the general icons (= stable functions):
- 2)- A non-interactive specification text
- 3)- Some interactive capture areas where user can leave either his travel hints or his questions.

These two capture areas are designed by two travel guide representation.

- 4)- An interactive icon aims to link with the manager of this service.

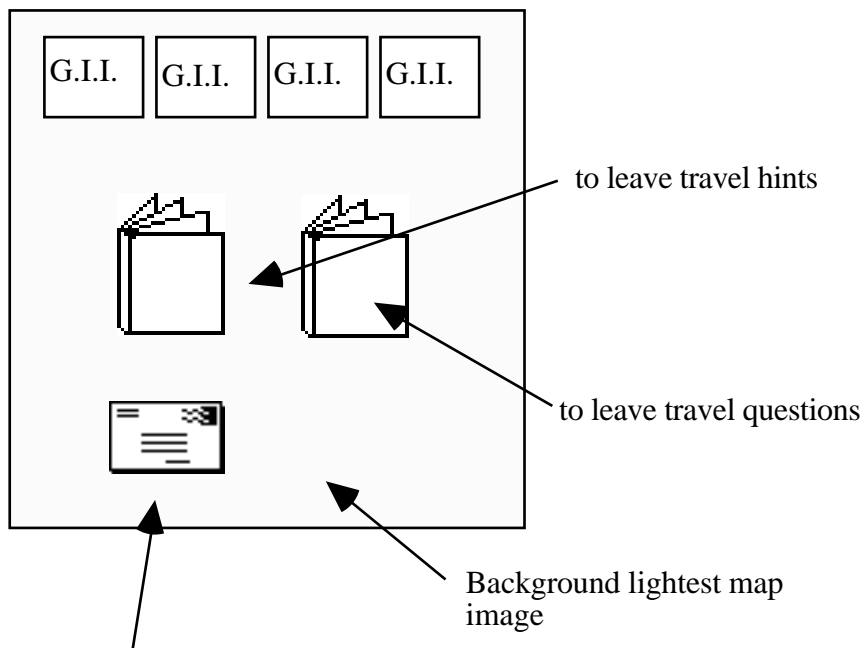

Connection to the manager service

## 9) The Vademecum Creation Screen

This display is composed by the following components:

- 1)- Recall of the general icons (= stable functions):
- 2)- A non-interactive specification text with the structure of the vademecum.
- 3)- An interactive invitation to consultation
- 4)- Representation of the first page of the booklet under a little rectangular spiral notebook form with interactive functions
- 5)- Presentation of the different chapters under the notebook inner's pages format. Interactive buttons are attached at each page
- 6)- An interactive validation button to download the vademecum.

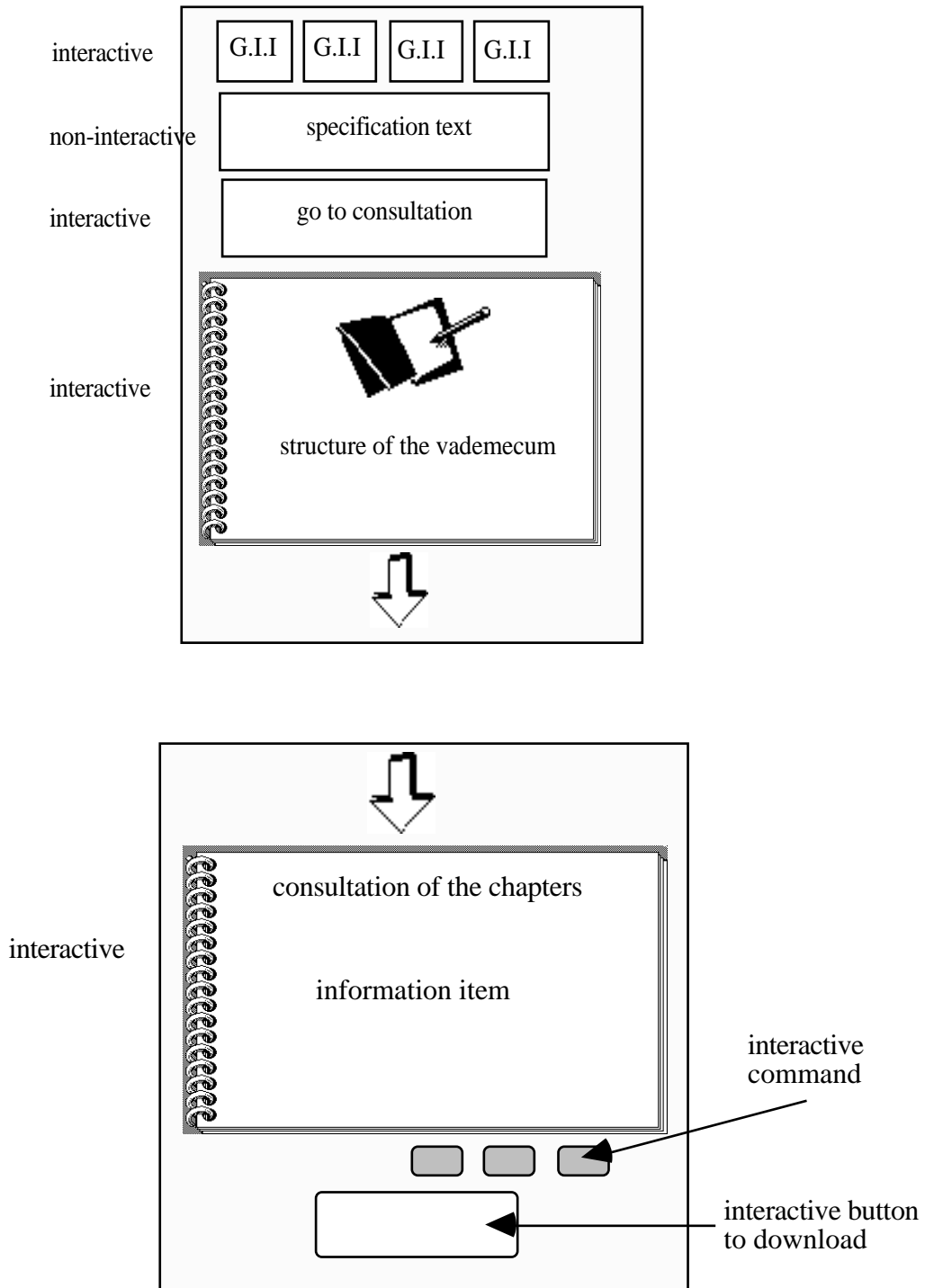



#### **7.1.4) IMPLEMENTATION OF THE "TOURISTS' BAG" SERVICE**

The implementation of this service is the same as that of the "thematic booklet" one. The user can select a country/region and the system gives all informations concerning his travel, sorts and inserts documents in a precise place in the constructing "tourists'bag" according the type of documents:

- Travel Preparation informations or,
- Sojourn
- Special Tourist Information
- Travel and Sojourn Offer.

We will creat data bases proper to these informations, and we can use the same program used in "thematic booklet" to collect informations from data bases and create bags in differents format like HTML or print.

#### **7.1.5) INFORMATION AND DOCUMENT GATHERING AND MAINTENANCE OF THE "TOURISTS' BAG" SERVICE**

Informations providing the core of "Tourists' bag" service will come both from resources available among the French VHF partners and from external sources.

Thus, informations pertaining for example to climate or political situation in a particular country will be extracted from the "First Contacts" files on this country.

Similarly, Inalco staff and students will provide particulars on travel conditions and tips, health, customs, a short travel language kit... Travel agencies associated to the project will be asked to provide data on transport (fares, timetables...) and bookshops/publishers a travel bibliography. Official regulations (visas, custom...) will be easily available from embassies and government information services.

### **7.1.6) CONTROLE AND QUALITY EVALUATION OF THE "TOURISTS' BAG" SERVICE**

Similarly to the previously described cultural information service, also this one will be controlled and evaluated with the help of the following technics and procedures:

- statistical evaluation of the frequentation and local exploitation of the service by the users during given test periods,
- evaluation of the suggestions send by the users to the information service manager,
- evaluation of this service by specialists and experts (content evaluation, evaluation of the ergonomy of the organization and the interface displays),
- comparative and concurrenial evaluation of this service with other services that are more or less similar to it and that are proposed by other sites.

### **7.1.7) EXPLOITATION OF THE "TOURISTS' BAG" SERVICE**

"Tourists' Bag" has a particular commercial vocation as it could be described as a **personnalized travel guide editor**.

Thus, in the short term, a system of payment will have to be considered. In this case, a particular attention should be taken on the maintenance of the service, in order to offer an appreciable level of reliability, both of the data (regular updates...) and the editing tools.

Potential customers may originate noty only from the tourists themselves but also from the tourism industry, as this service will enable travel agencies to edit travel informations to be included in their catalogs or provided to their customers and staff.

### **7.1.8) PROSPECTS AND POSSIBLE EVOLUTIONS OF THE "TOURISTS' BAG" SERVICE**

in the second phase of the VHF project, a specific emphasis will be given to the above mentioned personalized travel guide editor, i.e. to the conception and developpement of more sophisticated document structures in order to produce highly adaptable tourist guides.

## **8) THE "NEWS" SERVICE**

### **8.1) THE SPECIFIC NEWS SERVICE**

#### **8.1.1) GENERAL DEFINITION OF THE "NEWS" SERVICE**

This service proposes essentially thematically motivated and continuously up-dated links to specialized cultural, political and other information servers of mass media (written and audio-visual press, written and audio-visual publishing houses) that provide a user of this service with the most recent, relevant, general or more or less specialized informations concerning his request.

To each general theme (in the thematic file, cf. appendix I), corresponds:

- a selection of links to one or more servers of the written press
- a selection of links to one or more servers of the audio-visual press
- a selection of links to one or more servers of publishing houses
- a selection of links to one or more "institutional" servers

Given a theme - or again a "thematic profile" - such as:

"Chine: Musique > Opéra" and  
 "Langue: français, anglais, chinois",

the user will have the choice between several links to those servers that may satisfy his specific request.

Even if this service is, in its actual definition, not a very sophisticated one (as this is the case, for instance, for the Thematic Booklet service), it is - as the user needs and requirements analysis has clearly shown - a highly useful and desired one - :

- for students and researchers in order to complete and maintain their research problems and results,
- for journalists and writers in order to obtain quickly the most up-to-date relevant cultural informations they need in their job,
- for cultural institutions (museums, publishers, galleries, foreign national cultural centres such as the Maison de France, le Goethe Institut, ...) in order to follow the last evolutions in the cultural (political, ...) "market" for developing appropriate policies.

The News service is composed by:

- a) a main menu,
- b) a set of "country specific menus" that are selected in the main menu with the help of the geographic index or the interactive map,
- c) a thematic index (for selecting the links to the relevant servers)
- d) a geographic index (for selecting the country menu)
- e) an interactive map (for selecting the country menu)
- f) a language index (for selecting the links that are linguistically acceptable for a user)
- g) a structured list of activable server addresses
- h) a "media profile component" (i.e. a short description of the different publishing houses, tvs, newspapers, ...)
- i) a "control panel" for the use of this service (number of users, which links,
- j) a "proposition panel" (i.e. the invitation to the user to send remarks, ... concerning this service to the manager).

Naturally, the News service will be linked to:

- the Thematic Booklet service
- the First Contact service
- and the Tourist Bag service.

### **8.1.2) SCENARISATION OF THE CONSULTATION OF THE "NEWS" SERVICE**

From the user point of view, this service can be described as follows:

#### **1) Main Menu of the Service:**

1.1) Short description of what this service proposes:

thematically, geographically and linguistically selected news  
from written and/or audio-visual information sources

1.2) Invitation to the user to choose:

in the geographical index (or on the interactive map - the same as for the First Contact and Thematic Booklet service)

1.3) the user chooses a country/a region - the Country Screen appears

## **2) Country Screen:**

2.1) Short Presentation: "Vous êtes ..."

2.2) Similarly to the First Contact Service, the user is invited to choose:

in the thematic index (i.e. Vie Culturelle, Vie Politique, ...)

in the language index (i.e. "français", "anglais", ...)

2.3) The user chooses a theme - a thematic profile (i.e. Chine: Musique > Opéra) - and one or more natural languages in which he can communicate - the News Screen appears

## **3) News Screen**

3.1) Short Presentation: "Vous êtes ..."

3.2) The news screen possesses a standard structure/organisation (in the form of several, independant and scrollable frames):

one frame for the written press

one frame for the audio-visual press

one frame for the publishing houses

one frame for the institutional servers

in which he can choose sequentially specific links.

3.3) The user "scrolls" through the different fields and chooses to activate a specific link to a server in which he will consult one or more documents that are relevant to his initial request.

3.4) After having consulted (and maybe downloaded) the documents of a server, the user comes back and can continue to consult other servers...

### **8.1.3) INTERFACE DISPLAY MODEL**

#### **1 The "News" Main Menu Screen**

This first display is composed by the following components:

- 1)- Recall of the general icons (= stable functions):
- 2)- A non interactive text of identification of this service
- 3)- A capture area operate in tandem with a scroll-down menu corresponding to the geographical index
- 4)- An interactive map (made of clickable areas)

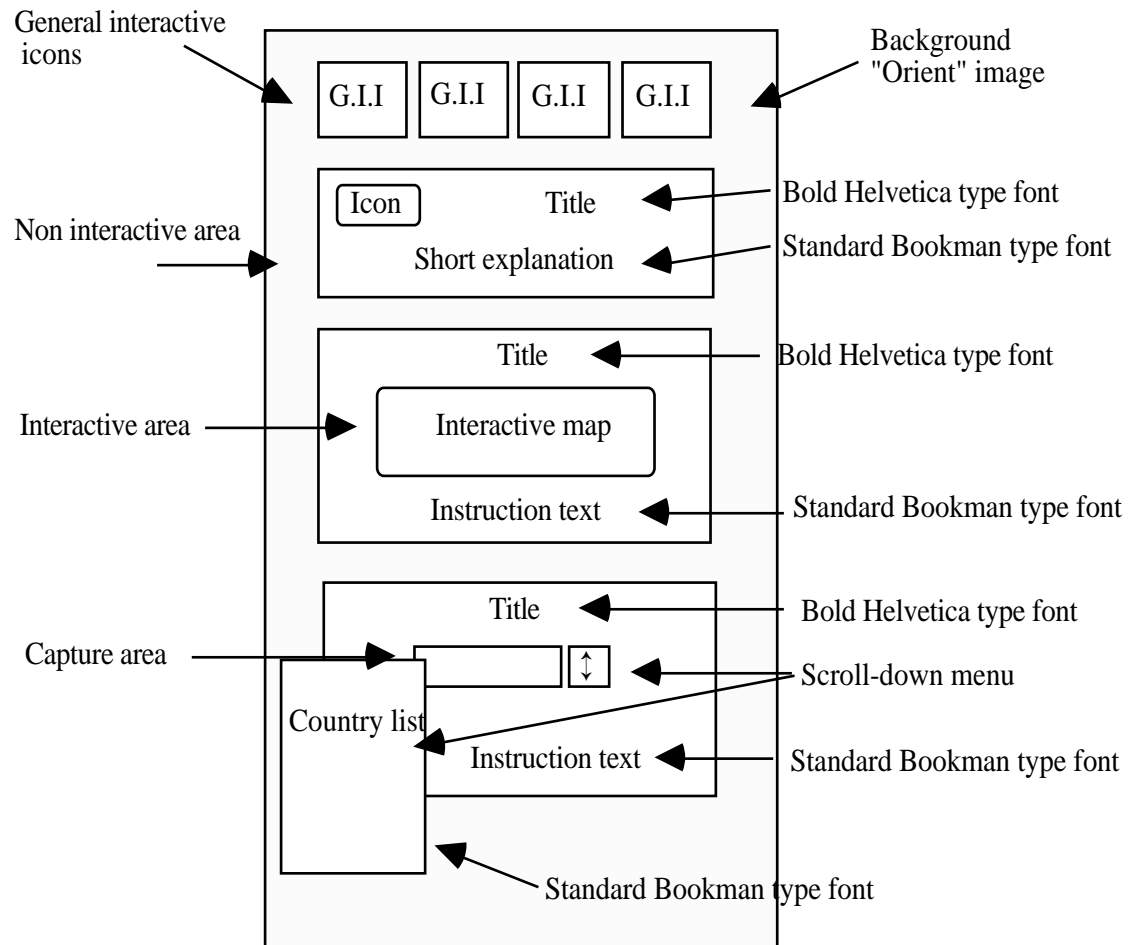

## 2 The Country Screen

This first display is composed by the following components:

- 1)- Recall of the general icons (= stable functions)
- 2)- A non-interactive presentation text
- 3)- Visualization of the country's map & name in a 3-D computer's room presenting some interactive capture areas to choose the thematic and the language.



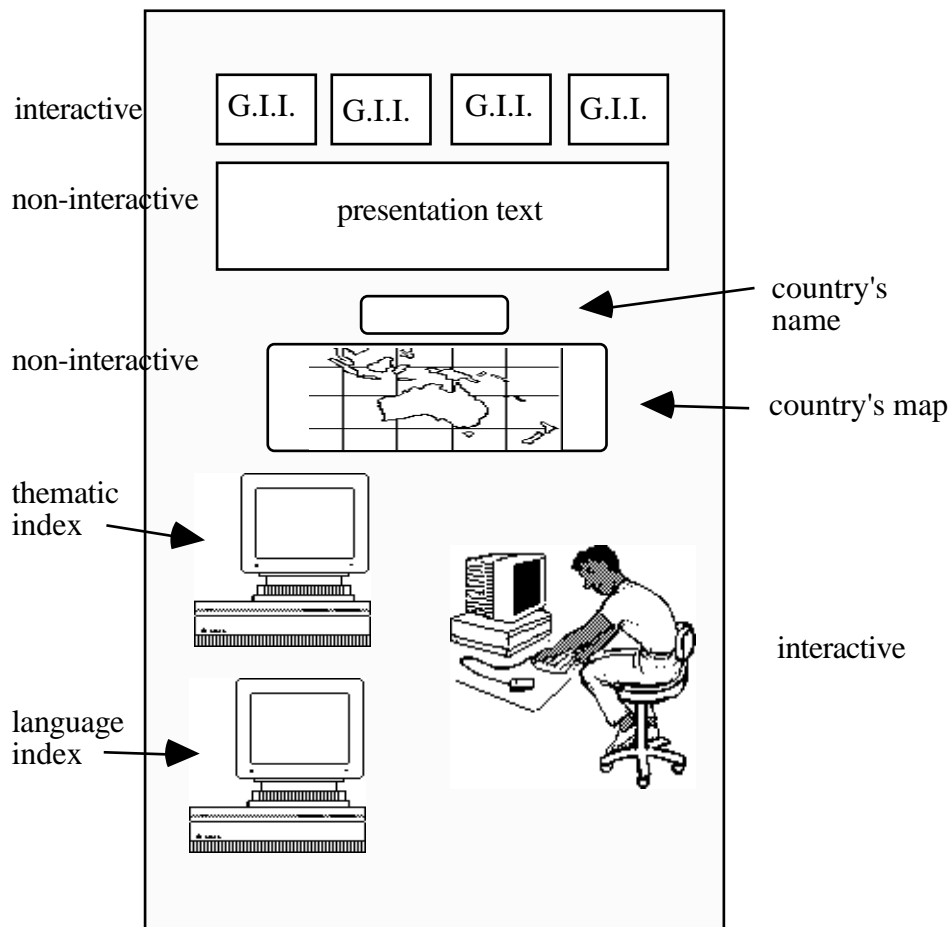

### 3) The News Screen

This first display is composed by the following components:

- 1)- Recall of the general icons (= stable functions):
- 2)- A non-interactive presentation text
- 3)- Some interactive display frames showing: the written press links, the audio-visual press links, the publishing houses links, the institutional servers links.

Each links references clickable. The user can "explore", "download", ... and, come back.

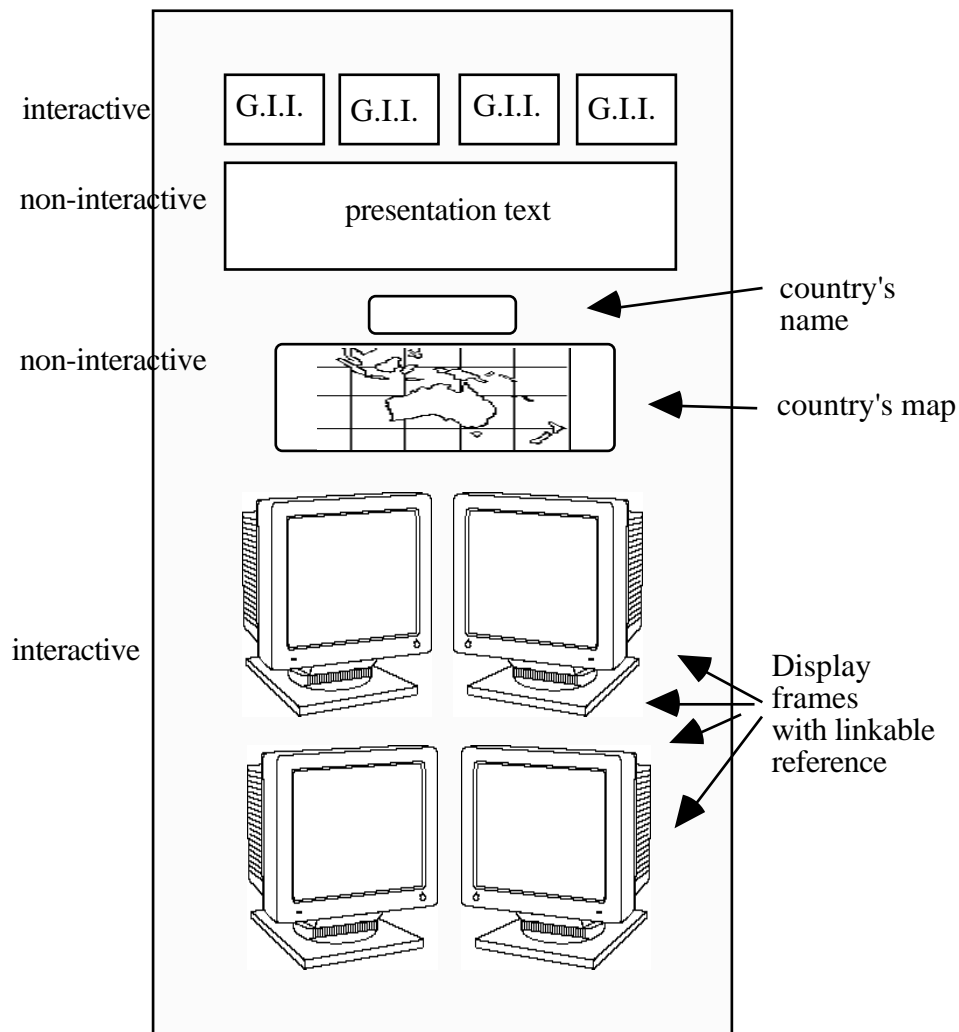

#### **8.1.4) IMPLEMENTATION OF THE "NEWS" SERVICE**

In order to be able to consult this service we will use frames technics for the visualization of all choices and answers that can be visualized.

According kind of documents answers: written press, audio-visual press, publishing houses and institutional servers; each document will be insered in corresponding frame with links to news servers.

#### **8.1.5) INFORMATION AND DOCUMENT GATHERING AND MAINTENANCE OF THE "NEWS" SERVICE**

As long as the "News" service is related to current events, its maintenance will require a high input from the staff in charge of the Web site.

Very precise maintenance protocols have to be defined, with, in a near future, a permanent in-charge working at full time on this task.

For the present time, reliable sources of informations, particularly in native languages (i.e. not accessible to the European public), are being identified.

#### **8.1.6) CONTROLE AND QUALITY EVALUATION OF THE "NEWS" SERVICE**

Similarly to the previously described cultural information service, also this one will be controlled and evaluated with the help of the following technics and procedures:

- statistical evaluation of the frequentation and local exploitation of the service by the users during given test periods,
- evaluation of the suggestions send by the users to the information service manager,
- evaluation of this service by specialists and experts (content evaluation, evaluation of the ergonomy of the organization and the interface displays),
- comparative and concurrential evaluation of this service with other services that are more or less similar to it and that are proposed by other sites.

### **8.1.7) EXPLOITATION OF THE "NEWS" SERVICE**

Like "Tourists' Bag", "News" service is particularly adapted to a commercial exploitation. On the condition that a high level of contents and reliability is assumed, a system of payment could be naturally introduced.

The first potential customers are obviously the journalists, but other categories may be also attracted, such as government information agencies.

As long as these are professional users, their satisfaction towards the service should be very regularly checked in order to make its contents correspond to their particular needs. As previously stated, this would incur a high input in terms of man-hours.

### **8.1.8) PROSPECTS AND POSSIBLE EVOLUTIONS OF THE "NEWS" SERVICE**

During the second phase of the VHF project, there will be undertaken especially one major qualitative improvement of this service, viz. the conception and realization of a **systematic on-line screening** of audio-visual and written information as well as its translation and adaptation for the sake of particular user groups that have subscribed to this service.

## **9) SERVICES "CONTACTS OF COUNTRIES AND CULTURES"**

The Asia in Paris and Africa in Paris services have the same structure and offer more or less the same type of informations. Thus in this report only the Asia in Paris service is dealt with.

### **9.1) THE "ASIA IN PARIS" SERVICE**

#### **9.1.1) GENERAL PRESENTATION OF THE "ASIA IN PARIS" SERVICE**

The Asia in Paris service should help to make known both the Asian communities based in Paris and the numerous resources dedicated to Asia in this city. Its creation respond to a double motivation : firstly, the complete absence of any website covering the Asian populations of France and secondly the fact that an important fraction (demographically and economically) of the European population originates from Asia, so these communities are one of the poorly known though real facets of today's Europe, particularly from the social and cultural points of view.

Target users encompass four broad categories :

- French and foreign tourists planning a trip to Paris.
- Economic operators (potential investors or customers) based in Europe or overseas, who may be interested by the activities of the Asian enterprises in Paris.
- Foreign scholars looking for informations on Asia in general and on the Asian diasporas in particular.
- Government and social workers, whether French, European or else, with a concern in immigration issues.

Contents would include the following topics :

- The Asian communities of Paris : introduction, basic data, history, geographical locations, economical activities, cultural and social activities.
- The Museums : museums and miscellaneous public places with a relation to Asia (gardens...).
- The Documentation : Libraries, bookshops, publishing houses specialized on Asia.
- Teaching and Research : Universities departments, research institutions, private schools and associations teaching Asian languages.
- The Restaurants : a selection of Asian restaurants in Paris.
- The Calendar : exhibitions, concerts, traditional festivals, in the coming months.
- Exchanges : a discussion forum on the Asian diasporas.
- Going East : embassies, travel agencies, tourist informations...

GENERAL SCHEME

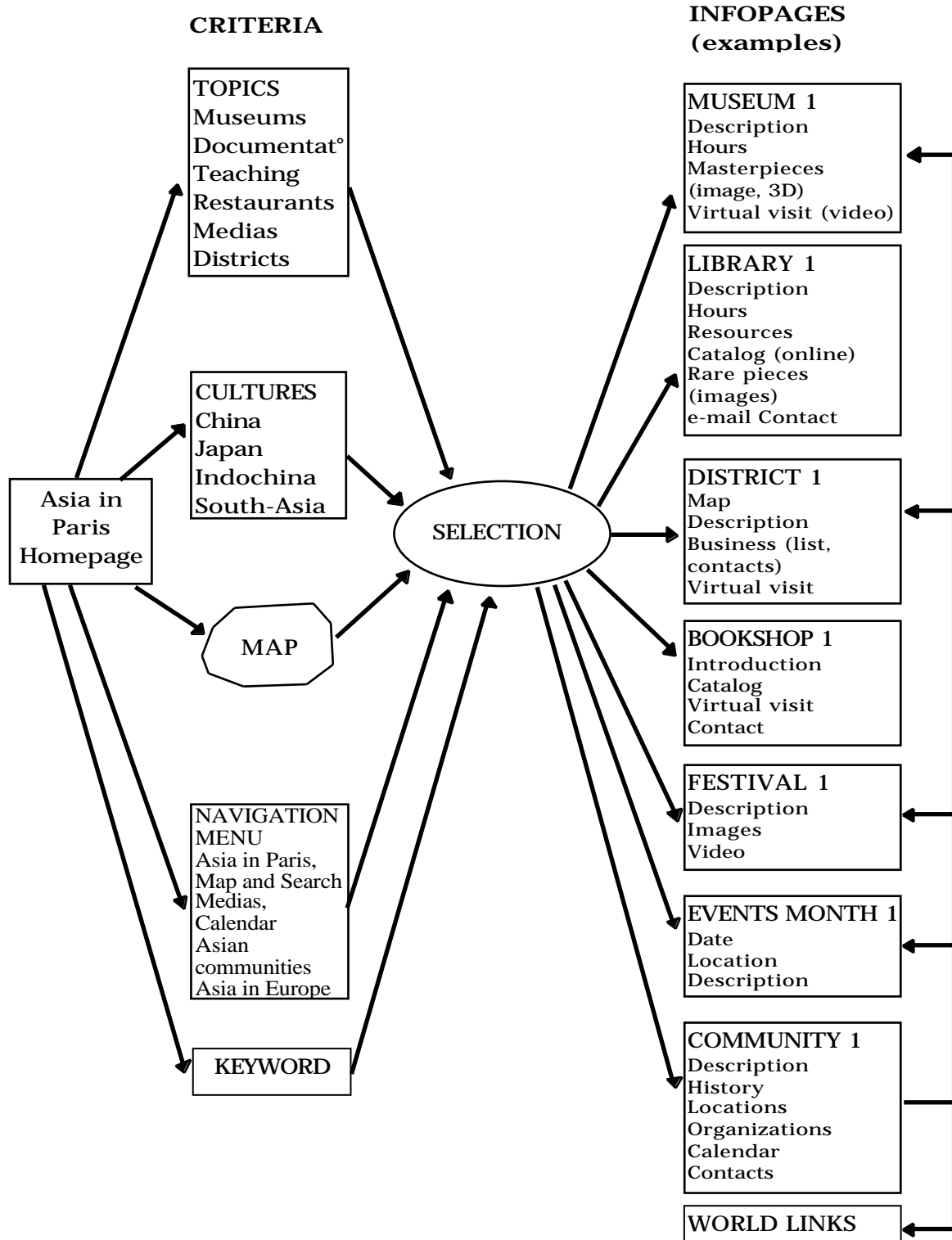

### **9.1.2) SCENARISATION OF THE CONSULTATION OF THE "ASIA IN PARIS" SERVICE**

Asia in Paris Main menu will be accessed from the Orient homepage. It will be bilingual, english and french, the user clicking on the "language" button of his choice.

The Asia in Paris menu will be centered on an interactive map of Paris and two interactive lists: "topics" and "cultures"

1. The user chooses both a certain topic (districts, museums, restaurants...) and culture (Japan, Indochina...). A list of related items are displayed (ex : museums related to China) with their locations appearing as a point on the Paris map. Selection may be precised or directly operated by entering a search keyword in the "search" field. On the opposite, the user may access directly (without selection) to a sub-menu page by clicking on one of the buttons of the "navigation menu": Asia in Paris, Map and Search, Medias, Calendar, Asian communities, Asia in Europe, Travel to Asia.

2a. The user clicks on one of the hypertexts, which leads him to the related page, for example one of the Museums of Paris related to China : he will be introduced to the museum (history, address, opening hours...) by a text and will find pictures of a certain number of artpieces. In certain cases, he will be able to look at one of these pieces in a 3D film or download a 3D file, to view it at his ease. In the case of the "Asian district of Paris", a map of the selected district will be displayed.

2b. In the sub-menu page, the user will find an extensive list of the related pages. As an example, in the page "Asian communities", he will find links to "Asian Districts of Paris", "Cambodians, Indians, Japanese...", "Trade", "Festivals"; etc.

3. In each page, the "navigation menu" will enable a direct shift to a different type of topics. Similarly, cross cultural access to similar pages will be offered : on the page dedicated to "Cambodian festivals", a contextual menu will enable a direct access to "Chinese festivals", "Indian festivals", etc. Should



the occasion arise, the user will be offered links to related websites in the world : in the India in Paris pages, a selection of India related sites in the UK.

**9.1.3) LAY-OUT AND INTERFACE DISPLAYS**

# Asia in Paris Homepage

This homepage will be accessible through Orient homepage.

ASIA IN PARIS   MAP AND SEARCH   MEDIAS   CALENDAR  
 ASIAN COMMUNITIES   ASIA IN EUROPE   TRAVEL TO ASIA

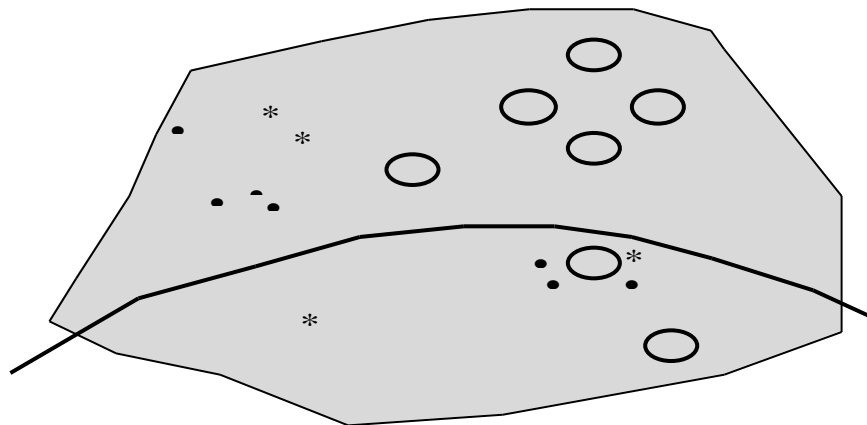

**Places**

- All
- Asian districts
- Museums and Gardens
- Libraries and Bookshops
- Learning
- Restaurants

**Cultures**

- All
- China
- Japan
- Indochina
- South-Asia (India, Sri Lanka, Pakistan)

**Search**

examples :  
 music,  
 cambodia,  
 ikebana,  
 bhudhism...

**Your Sdection**

(example for « museums » and « China »)

- **Musé Cenuschi**
- **Musé Guime**
- **ExpositionLa Cit dntedite » au GrandParis »**

Click on one of these items to get informations

#### **9.1.4) IMPLEMENTATION OF THE "ASIA IN PARIS" SERVICE**

For this service lists of places and cultures will be needed. All informations on each place (in a given culture) will be described.

To consult these informations we have two possibilities :

- The first is to choose (place-culture) and a program sorts all responses and gives possibility of consultation.
- The second is by a search engine that permits to consult this sub-service by keywords. We can use for this the index server locally in asia/africa directory.

#### **9.1.5) INFORMATION AND DOCUMENT GATHERING**

As data included in Asia in Paris are mostly related to actual institutions, they will be directly collected from these:

— Museums, libraries, bookshops and private companies will themselves provide a short notice on their activities and opening hours. Documentation centres could provide either an abstract of their catalogues or an access online to their databases.

— Asian organisations and companies : several Asian organizations ("associations") have been asked to send a description of their activities. Several directories of Asian companies and organizations based in France are available. With the agreement of their editors, they will be partially reproduced.

— General data on the Asian communities of Paris will be drawn from the few although valuable scientific publications adressing this topic.

— Demographic data will be drawn from the censuses of INSEE (National Census Institute).

— Pictures and videos on the Asian districts and museums will be taken directly by a team of INALCO students and specialized staff (CERPEM).

#### **9.1.6) CONTROLE AND QUALITY EVALUATION OF THE "ASIA IN PARIS" SERVICE**

Similarly to the already described cultural information services, also the Asia in Paris information service will be evaluated and controlled by the following procedures:

- statistical evaluation of the frequentation and local exploitation of the service by the users during given test periods;

- evaluation of the suggestions send by the users to the information service manager;

- evaluation of this service by specialists and experts (content evaluation, evaluation of the ergonomy of the organization and the interface displays);

- comparative and concurrential evaluation of this service with other services that are more or less similar to it and that are proposed by other sites.

#### **9.1.7) EXPLOITATION OF THE "ASIA IN PARIS" SERVICE**

Among the potential users of Asia in Paris service, some may prove particularly significant in economic terms :

— Asian or Asia related business companies would find in Asia in Paris a precious media for advertising ; presently, most of them rely only on specialized guides, and firstly on moth to ear advertisement.

— Government or public and private institutions (foundations...) may take a particular interest in the service Asia in Paris, as an information and communication media dedicated to a lesser known aspect of French culture and society. In the recent years for example, both the Ministry of Culture and Paris municipality have financially supported projects addressing the Asian community whether in cultural or social fields. Supplementary funds may be found from these sectors.

#### **9.1.8) PROSPECTS AND POSSIBLE EVOLUTIONS OF THE "ASIA IN PARIS" SERVICE**

During the second phase of the VHF project, the following experimental improvements will be taken into consideration:

teleshopping and tele-buying (cf. the related tasks coordinated by Intrasoft),  
interactive and personalized on-line advertising,  
virtual visits of (culturally interesting) places.

## **10) CULTURAL JOB & EXPERTISE SERVICES**

### **10.1) THE "HEAD HUNTER" SERVICE**

#### **10.1.1) GENERAL DEFINITION OF THE "HEAD HUNTER" SERVICE**

The " Head Hunter " service serve to exchange competences between people who would sell their ability and people who look for it : it is like an " exchange market " .

For this purpose, "Head Hunter" gives a collection of detailed informations :

- a) about the skills of the person who look after a job (in the cultural, linguistic, touristic, ... field),
- b) about the job definitions and the firm information chart who look for people.

The "Head Hunter" service is accessible from the main menu of Orient.

This service is organized in 4 main fields:

One is a field of explanation and orientation inside this service.(1. SE)

One is a field of "customer" registration.(2. RS)

The last two fields are reserved for consultation and discussion.(3. CS & 4. D/AS).

Regarding to the public consultation, each field work independently with respect to the others but in fact they are linked up.

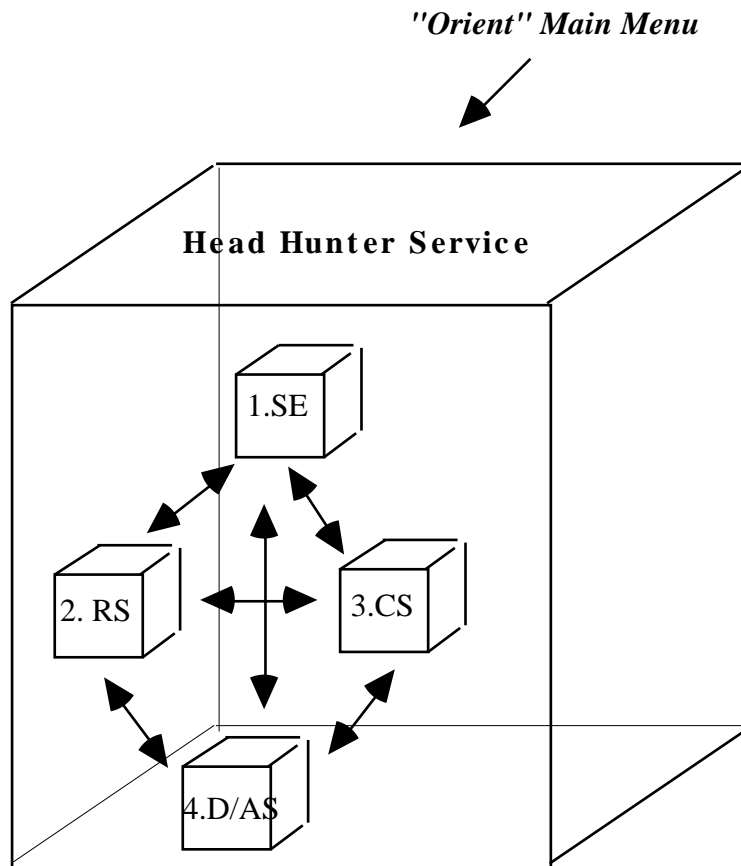

Each one of these fields is composed as follows:

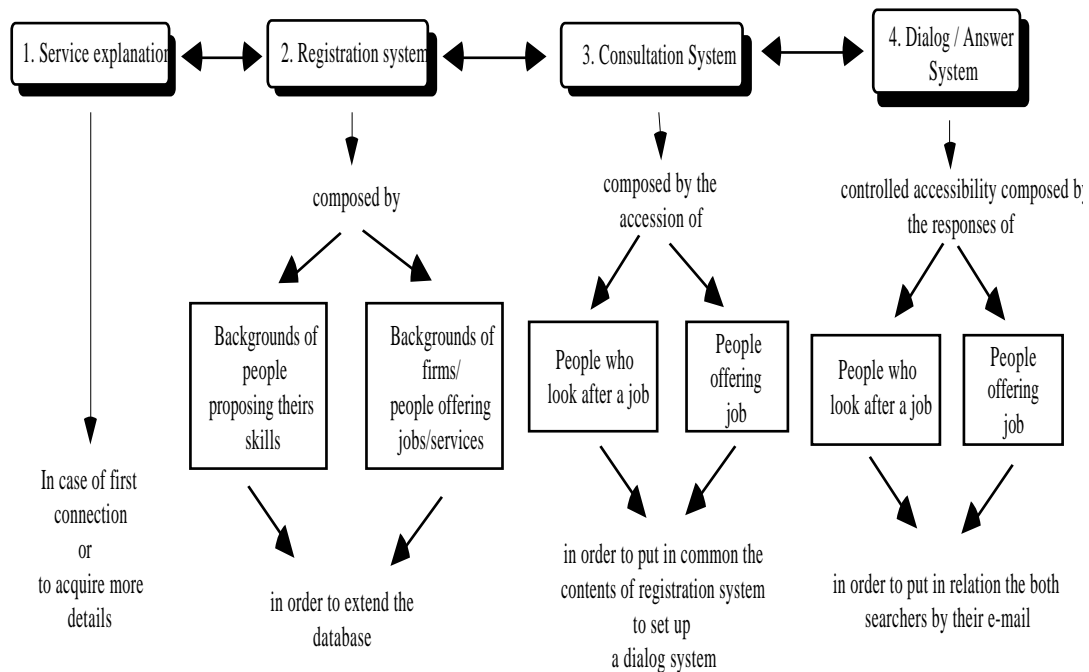

## 1. Service Explanation

This first field gives general explanations about the "Head Hunter" service; particularly in case of first connection but also in order to acquire more details about the registration and consultation procedures.

Direct connection to the others fields are available.

## 2. Registration System

### 2.a. Backgrounds of people proposing their skills

This field is composed by the references of people.

Each person must fill a multimedia document (text+visual) form sub-divided on 4 "chapters":

- Personal data
- Linguistic skills
- Domain skills
- Reference's country of abilities.

The content of the chapters must be completed as following :

- Personal data

Textual Data	Visual Data
Civil Status	Personal photo
Previous jobs / Professional experience	
Academic record	
Referees: personal and/or external referees	Viewing of documents, video composition of done jobs, ...
Free expression Goals and objectives / Interests / Related activities	Free composition (image or vidéo)

- Linguistic skills

Textual Data	Visual Data
Language qualifications (chinese, corean, etc.) to select on a drop-down menu	
Academic record / Additional education	
Job experiment	
Referees	Document visualization

- Domain skills

Textual Data	Visual Data
Key qualifications (economical, political, commercial, financial, translation-interpretation, journalism, ... ) to select on a drop-down menu	
Free-expression	Free composition

- Reference's country of abilities

Textual Data	Visual Data
--------------	-------------



Reference's countries (China, Japan, Taiwan, Hong-Kong, ...) to select on a drop-down menu	
Free-expression	Free composition

Each personal documents will be stored and ranked into a data base (cf. infra, **point 4** for more detailed explications).

### 2.B. Backgrounds of firms or people offering jobs/services

This field is composed by the references of firms/people.

Each person must fill a multimedia document form (text+visual) sub-divided on 5 "chapters":

- Personal data
- Job profile
- Domain skill
- Linguistic skill
- Reference's country.

The content of the chapters must be completed as following :

- Personal data

Textual Data	Visual Data
Civil status	Visual presentation (photos or video) more or less detailed of the company

- Job profile

Textual Data	Visual Data
Detailed description of the proposed job.	Viewing (photos or video) of differents aspects concerning the job: the surroundings, the existing team, ...

- Domain skill / key qualifications search

One or two domain (cultural, linguistic, touristic, economical, political, commercial, financial, journalism, ... ) to select on drop-down menu.

- Linguistic skill

One or two needed languages (chinese, corean, english, ...) to select on drop-down menu.

- Reference's country

One or two reference's countries (China, Japan, Taiwan, Hong-Kong, ...) to select on a drop-down menu.

Each documents will be stored and ranked into the data base. (cf. infra, **point 4** for more detailed explications).

### 3. Consultation System

#### 3.A. Job Proposal Consultation

This field allows the consultation of the whole job proposals contained in the registration system.

Searching method is very simple.

In order to access to a selectioned job item list, the user have to do a choice of searching

parameters among pre-defined criteria. These criteria correspond to the chapters of the registration documents.

For instance, consider the user (a specialist in corean language) searching some translation corean-french work. His first step will be put in focus at last two criteria (i.e: translation/interpretation in the domain skills parameters and, corean in the language skills parameters) in order to activate the data base. The system will determine a first general job item list.

Of course, more objects of the criteria grid will be filled more the job item list will be precised. (cf. infra, "**scenarisation**" for more detailed explications).

The user can read and select one or more jobs in the list and establish a dialog.

To establish a dialog is the second step of the consultation system.

After selecting one item, the user will be able to leave his response made by: his stored document and his e-mail reference. Later, when the answer processing will be done, he'll consult the dialog/answer system.

### 3.B. Background (Personal Resume) Consultation

This field allows the consultation of the backgrounds contained in the registration system.

Searching method is also developed on a simple method: in order to select special personal resume, the user have to do a choice among pre-defined criteria. These criteria correspond to the chapters of the registration document.

For instance, consider the user (french TV company) looking for an international reporter able to speak japanese. His step will be based on the same way as paragraph supra: more criteria filled get the more selected list .

After selecting an item, the user will be run the same procedure as seen before.

#### **4. Dialog / Answer System**

Only the registered people can have access to this dialog/answer system. In this sense, we can say it is a service with a controlled accessibility. (cf. 2) scenarisation).

The answer processing is the same for the both end-users. One reply message is attributed to each requesting.

##### 4.A. The answers to the job's searcher

The sytem proposes the name's visualization of all the job's searchers selected through the Consultation System.

To each name selected corresponds the name of the job's offer with his e-mail reference.

People who have his name selected can establish a direct dialog with the job's offer by connecting to his e-mail.

##### 4.B. The answers to the job's offer

This sytem proposes the name's visualization of all the job's offers selected through the Consultation System.

To each name selected correspond the name of the job's searcher with his e-mail.

People who have his name selected can establish a direct dialog with the job's searcher by connecting to his e-mail.

#### **10.1.2) SCENARISATION OF THE CONSULTATION OF THE "HEAD HUNTER" SERVICE**

The consultation take places as follows:

##### **1) "Head Hunter" service Main Menu Screen**

###### **1.1) Short identification of the service**

1.2) The user can:

- either consult the "Explanation system"
- or go to the "Registration system"
- or go to the "Consultation system"
- or go to the "Dialog/answer system".

## 2) "Explanation System" Screen

2.1) General idea of the potentialities of the systems belonging to the "Head Hunter" service.

2.2) the user can:

- either get more explications about the procedures of all the systems
- or access to the systems themselves.

General schema of the interactivity:

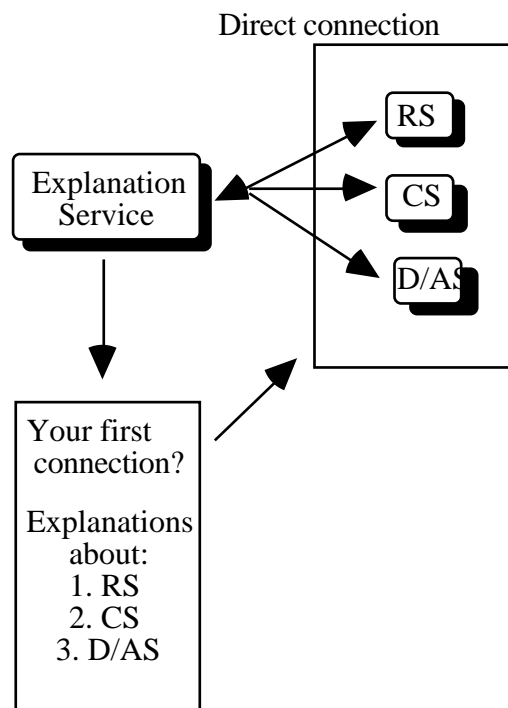

### **3) "Registration System" Screen**

3.1) Short specification on the objectives of this system

3.2) The user is invited to identify himself:

- either he is a job's searcher
- or a job's offer.

3.2.1) The user access to a capture grid (corresponding to his status).

He must fill it and validate it.

An enabling signal confirm the good registration of the grid in the database. The permit data write is done. A special key-word is attributed to the user. This key-word will allow him to establish a direct e-mail dialog in the dialog/answer system.

3.3) The user can access to the others systems.

General schema of the interactivity:

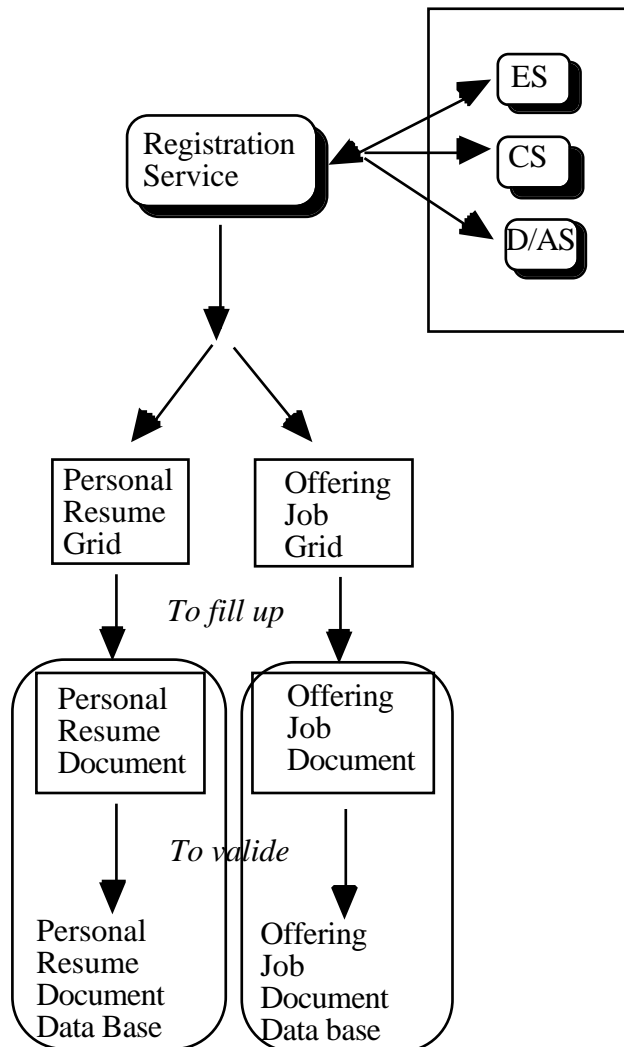

#### 4) "Consultation System" Screen

4.1) Short specification on the objectives of this system

4.2) The user is invited to identify himself:

- either he wants to consult the background database
- or the job proposal database.

4.2.1) The user access to different parameters to choose. These parameters have been established according to the different chapters of the registration documents. They are access key field to the database search program.

Only the validation of each parameter allows the validation and the run of the formatting program.

4.2.2) The user get his research item list.

He can either consult it or, select an item by clicking on it and get the whole information about it. If one item is particularly interesting for him, he can activate the reply message sending his own registered document, or only a part of it and leave his e-mail reference.

4.3) the user can access to the others systems.

General schema of the interactivity:



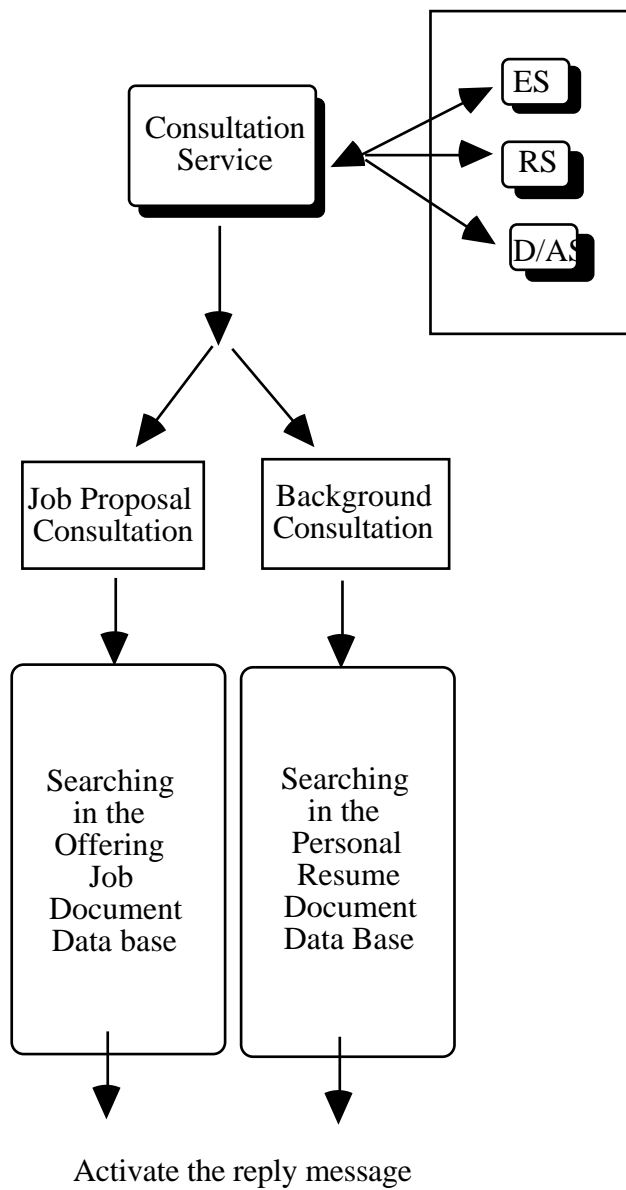

## 5) "Dialog/answer System" Screen

5.1) Short specification on the objectives of this system

5.2) The user is invited to identify himself:

- either he wants to consult the job's searcher reply message
- or the job's offer reply message.

5.2.1) With the key-word get in the registration system, the user can activate his answering list and set up a possible dialog. Consider he get a response from someone, he can either consult the registered document or/and establish the dialog by sending an e-mail. As soon as the e-mail is sent the private dialog started.

5.3) the user can access to the others systems.

General schema of the interactivity:

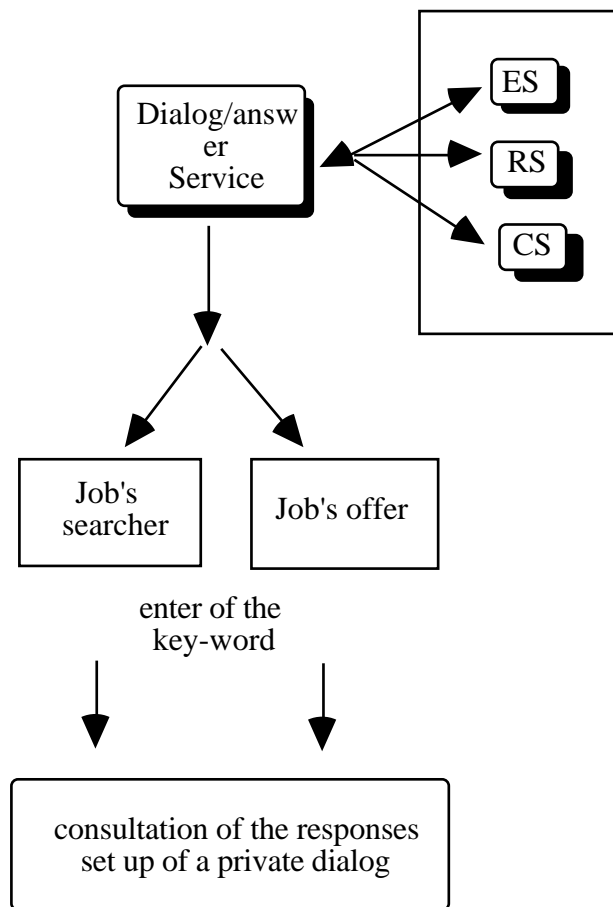

### 10.1.3) LAY-OUT / DISPLAY MODEL

#### 1. The Head Hunter Main Menu Screen

This first display is composed by the following components:

- 1)- Recall of the general icons (= stable functions):
- 2)- A non-interactive text corresponding to the short identification of the service
- 3)- A 3-D street representation shows some interactive areas to enter into the systems. Each interactive areas is represented by a little house.

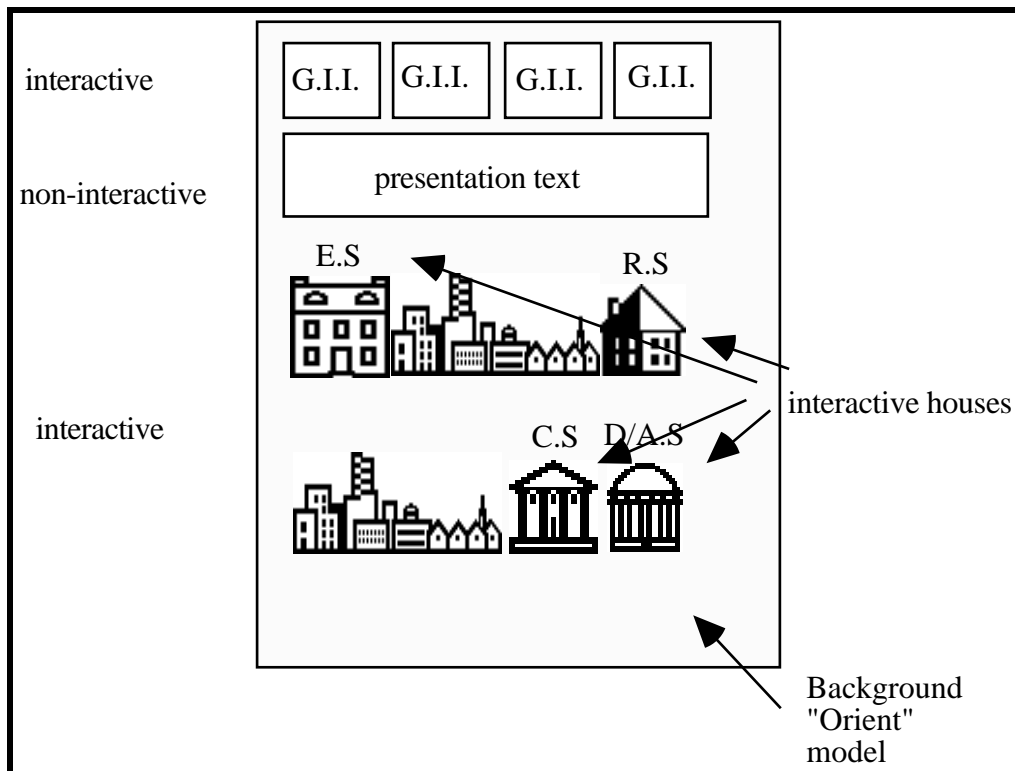

## 2. "Explanation System" Screen

This first display is composed by the following components:

- 1)- Recall of the general icons (= stable functions):
- 2)- A non-interactive text corresponding to the short presentation

The doors of the house's are open. User is now in the lobby. The whole functions are lobby's parts.

- 3)- An interactive question area : Your first connection ?
- 4)- An interactive area "Registration System" allowing the link with the named service.
- 5)- An interactive area "Consultation System" allowing the link with the named service
- 6)- An interactive area "Dialog/answer System" allowing the link with the named service

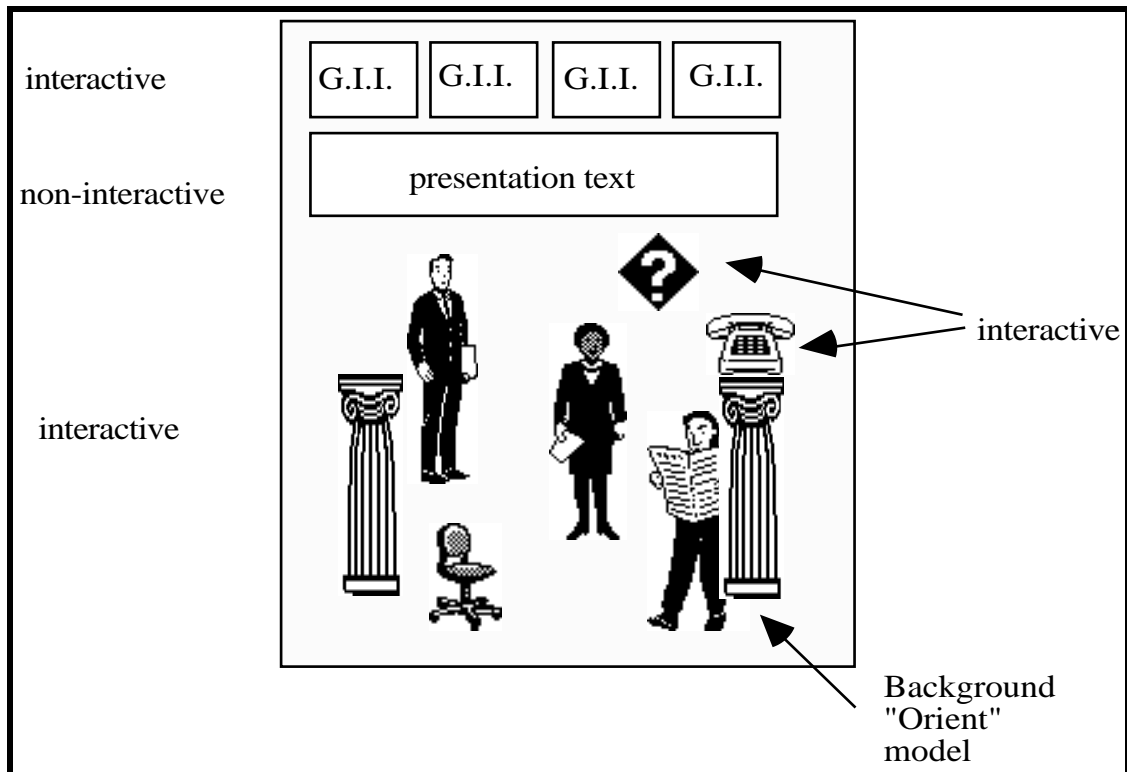

Clicking on the interactive question area, a new display come through coming from the interactive part of the lobby. This display is divided in 3 main vertical parts:

- definition of the Registration service, a presentation of the grids to fill, of the validation processing, of the key-word to get; interactive connection to the Registration service;
- definition of the Consultation service, a presentation of the parameters to choose, the working mode; interactive connection to Consultation service;
- definition of the Dialog/answer service, a presentation of the key-word processing, the answer polling mode; an interactive connection to the Dialog/answer service.

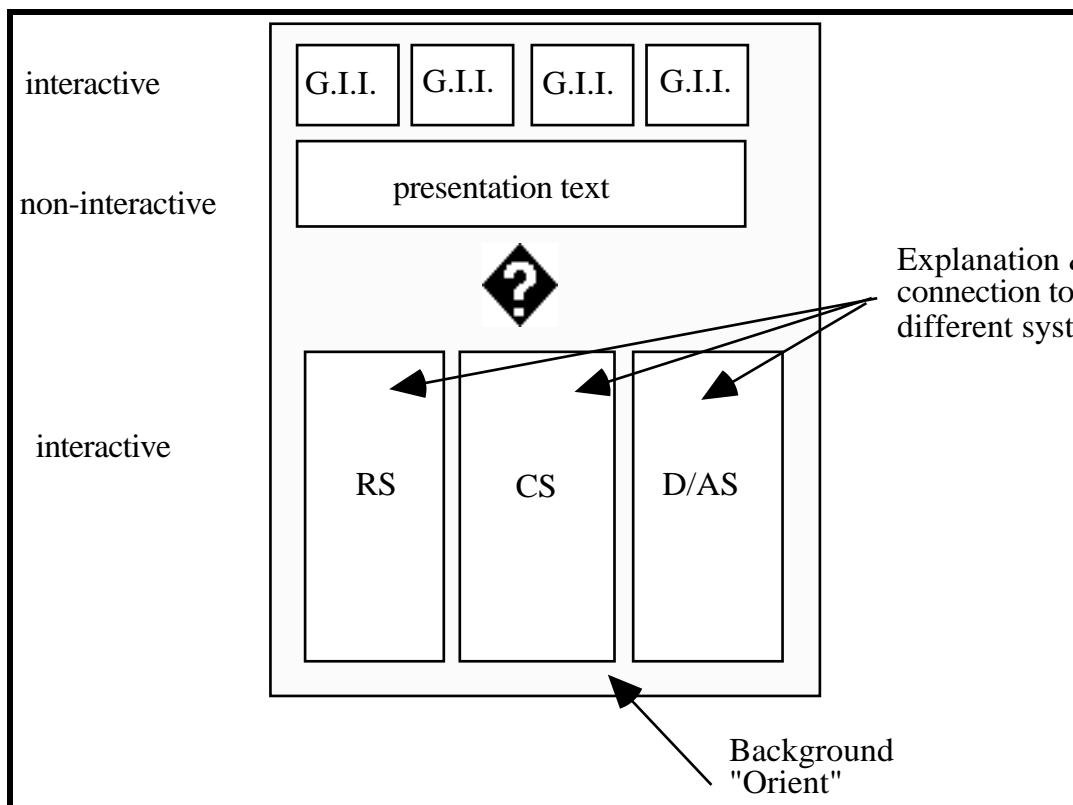

### 3. "Registration System" display model

This first display is composed by the following components:

- 1)- Recall of the general icons (= stable functions):
- 2)- A non-interactive text corresponding to the short presentation

The doors of the house's are open. User is now in the lobby. The whole functions are lobby's parts.

- 3)- An interactive text = to access to the "Personal resume" grid = document to fill up in order to be add in the data base
- 4)- An interactive text = to access to the "Offering jobs" grid = document to fill up in order to be add in the data base
- 5)- Some interative areas to go to the others systems

If user clicks on the "Personal resume", or in the "Offering job" option, he gets a new display composed by the grid to fill up.

The grid is divided in different chapters (cf. supra), each chapter is composed by a non interactive text which corresponds a space to fill with text and, according to the chapters some others spaces to fill with picture or video.

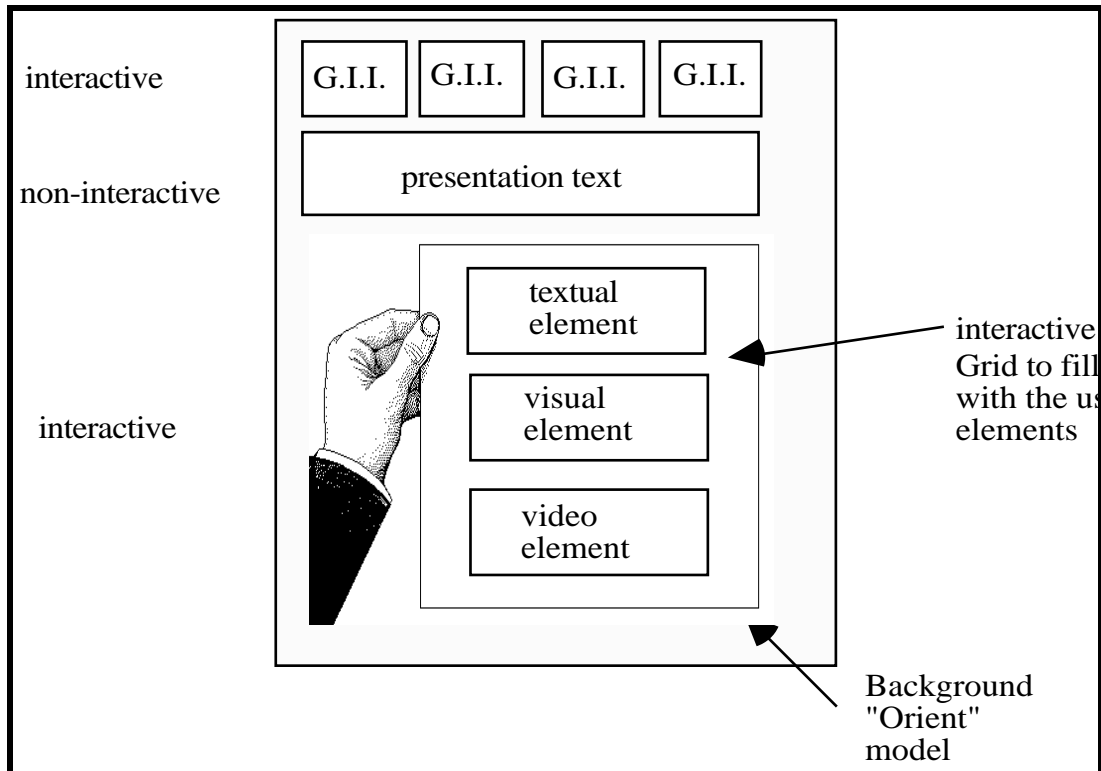

#### 4). "Consultation System" Screen

This first display is composed by the following components:

- 1)- Recall of the general icons (= stable functions):
- 2)- A non-interactive text corresponding to the short presentation

The doors of the house's are open. User is now in the lobby. The whole functions are lobby's parts.

- 3)- An interactive text = to access to the "Job Proposal Consultation"
- 4)- An interactive text = to access to the "Background Consultation"
- 5)- Some interactive areas to go to the others systems

If user clicks on "Job Proposal Consultation" or on "Background Consultation", he gets a new display where he'll process to a choice. Different capture areas with scrollable menus must be completed. Each areas correspond to one parameter.

When the parameters has been selected and valided, the system shows one item list.

Each part of this list is interactive. The user can consult it, get more informational animated or not documents, select one item and leave his own references.

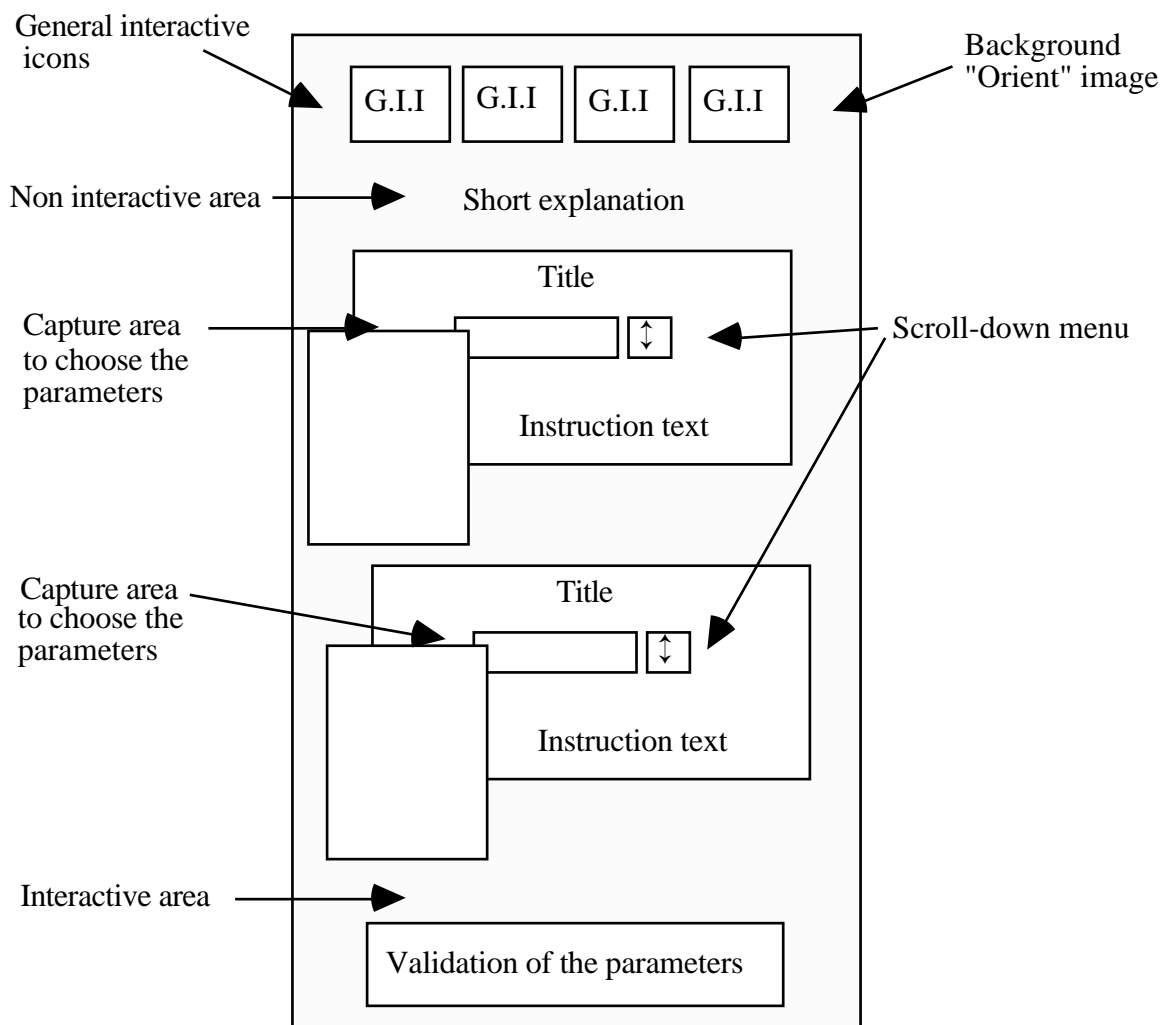



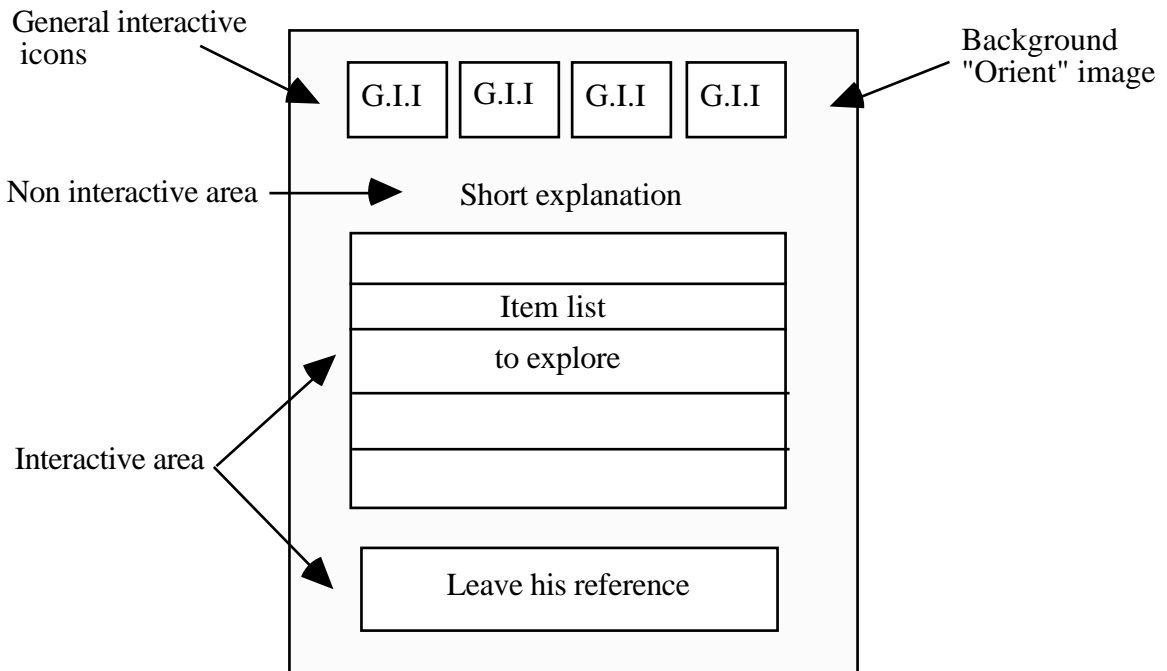

### 5). "Dialog/answer System" Screen

This first display is composed by the following components:

- 1)- Recall of the general icons (= stable functions):
- 2)- A non-interactive text corresponding to the short presentation
- 3)- An interactive space to fill with a special key-word
- 4)- Some interactive areas to go to the others systems

If user enter his pass key-word, he gets the dialog page screen.

Each ask or response are showed on a chronological list. In front of the job or CV reference, the e-mail reference is indicated. Directly clicking on the e-mail, user can connect himself to the seeker.

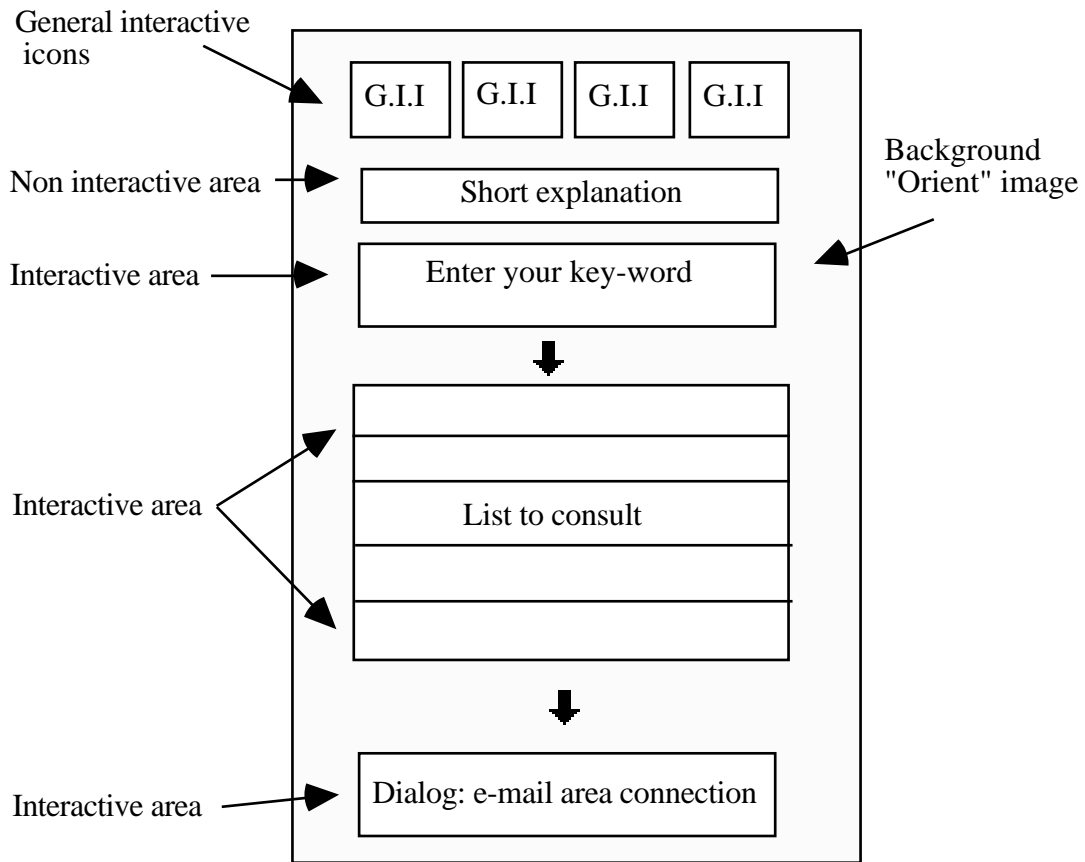

#### **10.1.4) IMPLEMENTATION OF THE "HEAD HUNTER" SERVICE**

This service will be composed by four sub-services that will be developed with the help of data base technologies :

*Explication service* : permits to explain functions of the other sub-services and gives possibility to acces.

*Registration service* : permits to enrich the backgrounds and job offers data bases thanks to two SQL requests programs for each type of operation.

*Consultation service* : composed by functions permitting to execute search operations. We can consult background or job offers generated by scripts from tables created by registration service.

*Dialog/answare system service* : for users registred, calls program that select positive offers in an array corresponding to each job the selected person.

#### **Technical description**

##### **Registration**

For this sub-service we will create two SQL tables destinated to receive inscriptions for each type of users.

-The first represents all informations of users, their resumes and their motivations.

-The second table represents all informations of job offers and person proposing.

##### **Vous pouvez vous inscrire**

*automatiquement en tant qu'utilisateur de HEAD HUNTER en remplissant et envoyant ce formulaire. Seuls les utilisateurs inscrits ont accès à HEAD HUNTER. Choisissez votre nom d'utilisateur (tel que votre nom) et un mot de passe personnels. Ils constitueront*

désormais vos clés d'accès à HEAD HUNTER. Ces informations seront placées dans une base de données d'inscription qui n'est accessible que par l'administrateur du site Web, et non par les utilisateurs normaux.

Une fois que votre inscription

aura réussi, le navigateur Web vous demandera de saisir votre nom d'utilisateur et votre mot de passe la première fois que vous accéderez à HEAD HUNTER. Le navigateur gardera ces informations en mémoire aussi longtemps qu'il fonctionnera ; ainsi vous pourrez accéder à n'importe quel document de HEAD HUNTER sans répondre de nouveau aux questions.

**Exemple de code HTML qui fera appel a un script inscription():**

```
<form method="POST" onsubmit="inscription()"

    <p><select name="Category" size="1">
      <option selected> Profession </option>
      <option> Student </option>
      <option> Professor </option>
      <option> Boss </option>
    </select> </p>

    <h3>Contact Information</h3>
    <pre>
    <em>   Name </em>
      <input type="text" size="35" maxlength="256"
name="Name">
    <em>   Profession </em>
      <input type="text" size="35" maxlength="256"
name="Title">
    <em>   Company/university </em>
      <input type="text" size="35" maxlength="256"
```

```

name="Company/university">
<em> Address </em>
  <input type="text" size="35" maxlength="256"
name="Address">
<em> Telephone </em>
  <input type="text" size="35" maxlength="256"
name="Telephone">
<em> FAX </em>
  <input type="text" size="35" maxlength="256"
name="FAX">

<em> E-mail </em>
  <input type="text" size="35" maxlength="256"
name="E-mail">
</pre>
<p><input type="submit" value="Submit Feedback">
<input
type="reset" value="Reset Form"> </p>
</form>

```

In the "head hunter " service a menu page will be created that gives acces to all sub-services. One dialog box/form (which could be generated by a java program for example) permits to receive backgrounds and calls executing scripts (here inscription) to update resumes table.

### Consultation

We anticipate two access on two HTML pages that will serve to consult repectively resumes and job offers. We can develop an program permitting to cerate an HTML document from table that we can consult on Internet. These access figure in the menu of " head hunter " service.

**Dialoge system**

In this sub-service an form permits to person to register selected resumes in data base corresponding to selected backgrounds. The programme creates an two dimensions array [offers, resumes] that affects for each job the selected resume. The result is generated by a program that converts this type of array to an HTML page consultable on internet by person registred in the " head hunter " service.

**10.1.5) INFORMATION AND DOCUMENT GATHERING AND MAINTENANCE OF THE "HEAD HUNTER" SERVICE**

The relevant information will be gathered from:

professionals of the "oriental world" (authors, journalists, translators, linguists, media specialists, historians, ...)

advanced students, researchers and teachers

person has his/her documents for one year in the data base. If he/she will not renew the demand to remain in the database, his/her documents will be destroyed after one year.

In order to guarantee a good quality of the job proposers, it is forseen that:

the introduction of someone's data in the database will be restricted to specific periods during the week,

a jury of specialists will check regularly the incoming demands,

a control system for checking the seriousness of people looking for competent people will be developped.

### **10.1.6) CONTROLE AND QUALITY EVALUATION OF THE "HEAD HUNTER" SERVICE**

Similarly to the already described cultural information services, also the Head Hunter information service will be evaluated and controlled by the following procedures:

- statistical evaluation of the frequentation and local exploitation of the service by the users during given test periods;
- evaluation of the suggestions send by the users to the information service manager;
- evaluation of this service by specialists and experts (content evaluation, evaluation of the ergonomy of the organization and the interface displays);
- comparative and concurrential evaluation of this service with other services that are more or less similar to it and that are proposed by other sites.

### **10.1.7) EXPLOITATION OF THE "HEAD HUNTER" SERVICE**

The Head Hunter service will be, during the period of the VHF project, a free service but it is clear that it will become, afterwards, a payable service.

The main target groups are, naturally, one the one hand students of oriental languages and civilisations and, on the other hand, companies who have to deal with some country or some culture in Asia or in Africa.

#### **10.1.8) PROSPECTS AND POSSIBLE EVOLUTIONS OF THE "HEAD HUNTER" SERVICE**

During the second phase of the VHF project, the Head Hunter service will be more fully developed in an "electronic exchange & work" service, viz. completed by different more specialized components and modules such as the collaborative working, the distant working, and so on.