



**HAL**  
open science

## **Lattice point of view for argumentation framework**

Mohammed Elaroussi, Lhouari Nourine, Mohammed Said Radjef

► **To cite this version:**

Mohammed Elaroussi, Lhouari Nourine, Mohammed Said Radjef. Lattice point of view for argumentation framework. 2021. <hal-03184819>

**HAL Id: hal-03184819**

**<https://hal.science/hal-03184819v1>**

Preprint submitted on 29 Mar 2021

**HAL** is a multi-disciplinary open access archive for the deposit and dissemination of scientific research documents, whether they are published or not. The documents may come from teaching and research institutions in France or abroad, or from public or private research centers.

L'archive ouverte pluridisciplinaire **HAL**, est destinée au dépôt et à la diffusion de documents scientifiques de niveau recherche, publiés ou non, émanant des établissements d'enseignement et de recherche français ou étrangers, des laboratoires publics ou privés.



HAL Authorization

# *Lattice point of view for argumentation framework*

Mohammed Elaroussi<sup>1</sup> Lhouari Nourine<sup>2</sup> Mohammed Said Radjef<sup>1</sup>

<sup>1</sup> *Unité de Recherche LaMOS. Faculté des Sciences Exactes. Université de Bejaia, 06000 Bejaia, Algeria*

<sup>2</sup> *Université Clermont Auvergne, CNRS, LIMOS, France*

---

The main purpose of this article is to develop a lattice point of view for the study of argumentation framework extensions. We first characterize self-defending sets of an argumentation framework by the closed sets of an implicational system that can be computed in polynomial time from the argumentation framework. On the other hand, for any implicational system  $\Sigma$  over the set of arguments, we associate an argumentation framework whose admissible sets are in bijection with closed sets of  $\Sigma$ . Second, we propose conflict-closed sets reduction rules, based on implicational system, to find out minimal subsets of vertex cover closed, while maintaining all potential admissible extensions as well as preferred extensions. Finally, based on a partition of the implicational system of an argumentation frameworks, we propose polynomial delay and space algorithm to enumerate admissible sets for a bipartite argumentation framework. This improves the exponential space complexity of previous algorithms.

**Keywords:** argumentation framework, admissible extensions, lattice, implicational system.

---

## 1 Introduction

The argumentation framework proposed by Dung (1995) consists of a set of arguments and an attack relationship between them, i.e. directed graph. Argumentation is a major subject of research within Artificial Intelligence and widely used in many fields, such as Logic, Philosophy, and Communication theory Bench-Capon and Dunne (2007); Rahwan and Simari (2009). In particular, the argumentation framework introduced by Dung (1995) is a powerful formalism for modeling and deciding argumentation problems, see Caminada and Amgoud (2007).

The concept of extension plays a key role in Dung's argumentation frameworks, where an extension is a set of arguments, which can "survive the conflict together". The main computational problems in argumentation framework are related to extensions and it is proved as intractable problems in literature, see Dunne and Bench-Capon (2001); Dvořák and Dunne (2017); Gaggl et al. (2020); Kröll et al. (2017).

To study abstract solution concept in cooperative game theory, Von Neumann and Morgenstern (2007) introduced the notion of kernel in directed graphs. The notion of semi-kernel was introduced by Neumann-Lara (1971). These two notions are in some way equivalent to stable or admissible extensions in argumentation frameworks work Coste-Marquis et al. (2005).

Dung (1995) shows that the families of self-defending sets are closed under union and thus the set of admissible extensions has a semi-lattice structure. However, the representation of admissible extensions by a lattice has not been developed in its own.

The main purpose of this article is to develop a lattice point of view for the study argumentation framework extensions. We first characterize self-defending sets of an argumentation framework by the closed sets of an implicational system that can be computed in polynomial time. On the other hand, for any implicational system  $\Sigma$  over the set of arguments we construct an argumentation framework whose admissible sets are in bijection with closed sets of  $\Sigma$ . Second, we propose polynomial delay and space algorithms for argumentation framework having a nice partition such as bipartite argumentation frameworks. We also revisit existing algorithms for particular classes of argumentation frameworks (such as even-cycle-free or bipartite) and explain them in terms of lattices. We hope that this work will bring another view of argumentation frameworks and vice versa.

## 2 Preliminaries

All objects considered in this paper are finite.

**Argumentation framework.** A finite argumentation framework proposed in Dung (1995) as a pair  $AF = \langle \mathcal{A}, \mathcal{R} \rangle$ , where  $\mathcal{A}$  is a set of arguments, and  $\mathcal{R}$  (attacks) is a binary relation on  $\mathcal{A}$ , i.e.  $\mathcal{R} \subseteq \mathcal{A} \times \mathcal{A}$ . For two arguments  $x$  and  $y$ , the meaning of  $(x, y) \in \mathcal{R}$  is that  $x$  represents an attack against  $y$ . An argumentation framework is conveniently represented by a directed graph  $AF = (\mathcal{A}, \mathcal{R})$ , called an *attack graph*, in which the vertices represent the arguments and the edges represent the attacks between arguments.

Given a set of arguments  $S$  of  $\mathcal{A}$ , we denote by  $S^+$ , the set of arguments attacked by  $S$ , i.e.  $S^+ = \{x \in \mathcal{A} \mid \text{exists } y \in S \text{ such that } (y, x) \in \mathcal{R}\}$ . Likewise, the set of arguments that attack at least one argument of  $S$  is denoted by  $S^- = \{x \in \mathcal{A} \mid \text{exists } y \in S \text{ such that } (x, y) \in \mathcal{R}\}$ . We say  $x \in \mathcal{A}$  is an unattacked argument in  $AF$  if and only if  $x^- = \emptyset$ . We denote by  $U = \{x \in \mathcal{A} \mid x^- = \emptyset\}$  the set of all unattacked arguments in  $AF$ .

An argument  $x \in \mathcal{A}$  is said to be *acceptable* with respect to a set of arguments  $S \subseteq \mathcal{A}$  if and only if for all  $y \in \mathcal{A}$  if  $(y, x) \in \mathcal{R}$  then exists  $z \in S$  such that  $(z, y) \in \mathcal{R}$ . A set  $S \subseteq \mathcal{A}$  of arguments is said to be *conflict-free* (independent set in the terminology of the graph theory) if and only if  $S \cap S^+ = \emptyset$ . The set of all conflict-free sets of  $AF$  is denoted by  $CF$ . A subset  $S \subseteq \mathcal{A}$  is a *vertex cover* of  $AF$  if and only if the complement  $\bar{S}$  is a conflict-free set of  $AF$ .

The conflict-free subsets of  $\mathcal{A}$  which are maximal with respect to the set inclusion are called *naive extensions* in Bondarenko et al. (1997). A set  $S \subseteq \mathcal{A}$  is said to be *self-defending* if and only if  $S^- \subseteq S^+$ . The set of all self-defending sets of  $AF$  is denoted by  $SD$ . Using the concepts of conflict-free and acceptability, Dung (1995) defines several extensions. A conflict-free set  $S \subseteq \mathcal{A}$  is said to be *admissible* if and only if it is self-defending, i.e.  $S^- \subseteq S^+$ . The set of all admissible sets of  $AF$  is denoted by  $ADM$ . The admissible subsets of  $\mathcal{A}$  which are maximal with respect to the set inclusion are called *preferred extensions*. The set of all preferred extensions is denoted by  $PREF$ . We refer the reader to Baroni et al. (2011); Dunne et al. (2015) for more discussion on other semantics.

**Partial order.** A partial order over a set  $X$  (or poset), denoted by  $P = (X, \leq)$ , is a binary relation  $\leq$  on  $X$  which is reflexive (for all  $x \in X$ ,  $x \leq x$ ), anti-symmetric ( for all  $x, y \in X$ , if  $x \leq y$  and  $y \leq x$ , then  $x = y$ ) and transitive (for all  $x, y, z \in X$ , if  $x \leq y$  and  $y \leq z$ , then  $x \leq z$ ). Two elements  $x$  and  $y$  of  $P$  are said to be comparable if  $x \leq y$  or  $y \leq x$ , otherwise they are said to be incomparable. An element  $u$  of  $P$  is called an upper bound of  $x$  and  $y$  if  $x \leq u$  and  $y \leq u$ ; it is called least upper bound of  $x$  and  $y$  if for every upper bound  $v$  of  $x$  and  $y$ ,  $u \leq v$ . It is worth noticing that two elements of a poset may or may

not have a least upper bound. The least upper bound is also known as supremum or join of  $x$  and  $y$ . The greatest lower bound is also known as infimum or meet of  $x$  and  $y$ , is defined dually.

**Lattice.** A finite lattice is a poset in which every two elements have a least upper bound and a greatest lower bound. A meet-semilattice (respectively, a join-semilattice) is a poset in which every two elements have a greatest lower bound (respectively, have a least upper bound). For more detail on lattices, see Davey and Priestley (2002); Grätzer (2011).

**Closure systems and implicational system.** A closure system  $\mathcal{F}$  over a set  $\mathcal{A}$  is a collection of subsets of  $\mathcal{A}$  closed under intersection and containing  $\mathcal{A}$ . An implicational system  $(\mathcal{A}, \Sigma)$  is a set  $\Sigma$  of implications of form  $X \rightarrow Y$  where  $X \subseteq \mathcal{A}$  and  $Y \subseteq \mathcal{A}$ .  $X$  is called the premise of  $X \rightarrow Y$ , and  $Y$  its conclusion. The size of  $\Sigma$  is the number of implications in  $\Sigma$ . It is denoted by  $|\Sigma|$ . Without loss of generality, we only consider implicational system where  $|Y| = 1$ . Let  $\Sigma = \{X_1 \rightarrow x_1, \dots, X_n \rightarrow x_n\}$  be an implicational system over a set  $\mathcal{A}$  and  $A \subseteq \mathcal{A}$ . The  $\Sigma$ -closure of  $A$ , denoted by  $A^\Sigma$ , is the smallest set containing  $A$  and satisfying:

$$\text{for all } 1 \leq j \leq n, X_j \subseteq A^\Sigma \text{ implies } x_j \in A^\Sigma.$$

The family of sets  $\mathcal{F}_\Sigma = \{A^\Sigma, A \subseteq \mathcal{A}\}$  is called a closure system (closed under intersection and containing  $\mathcal{A}$ ). The elements of  $\mathcal{F}_\Sigma$  are called closed sets of  $\Sigma$ . When ordered by inclusion,  $\mathcal{F}_\Sigma$  is a lattice, denoted by  $\mathcal{L}_\Sigma = (\mathcal{F}_\Sigma, \subseteq)$ . For more details on implicational system, see Bertet et al. (2018); Wild (2017).

**Enumeration algorithms.** An enumeration algorithm for extensions is an algorithm that takes an argumentation framework and lists all its extensions. We distinguish several kind of enumeration algorithms:

An enumeration algorithm is said to be output-polynomial if its running time is in polynomial time in the sizes of both the input and the output. It is said to be running in incremental-polynomial time if it moreover outputs the  $i^{\text{th}}$  solution in a time which is bounded by a polynomial in the size of the input plus  $i$ , for all  $i$ . If the running times before the first output, between any two consecutive outputs, and after the last output, are bounded by a polynomial in the size of the input, then the algorithm is said to be running with polynomial delay.

**Notations.** Let  $AF = \langle \mathcal{A}, \mathcal{R} \rangle$  be an argumentation framework. The complement of a set  $F \subseteq \mathcal{A}$  is denoted by  $\bar{F} = \mathcal{A} \setminus F$ . We denote by  $\mathcal{F}^c$  the set of complement of elements in  $\mathcal{F}$ . So  $SD^c$  is the set of complement of self-defending sets.

The following example illustrates the notion of extensions and their lattice structure.

**Example 1.** Let  $AF = \langle \mathcal{A}, \mathcal{R} \rangle$  be the argumentation framework corresponding to the attack graph depicted in Figure 1.

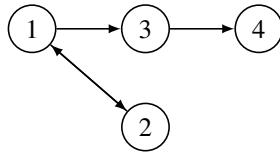

**Fig. 1:** Attack graph of  $AF$ .

The set of all conflict-free sets of  $AF$  is  $CF = \{\emptyset, \{1\}, \{2\}, \{3\}, \{4\}, \{1, 4\}, \{2, 3\}, \{2, 4\}\}$ . The sets  $\{1, 4\}$ ,  $\{2, 3\}$ , and  $\{2, 4\}$  are a naive extensions of  $AF$ .

The set of all self-defending sets of  $AF$  is  $SD = \{\emptyset, \{1\}, \{2\}, \{1, 2\}, \{1, 4\}, \{2, 3\}, \{1, 2, 3\}, \{1, 2, 4\}, \{1, 2, 3, 4\}\}$ .

The set of all admissible sets of  $AF$  is  $ADM = SD \cap CF = \{\emptyset, \{1\}, \{2\}, \{1, 4\}, \{2, 3\}\}$ . The two admissible sets  $\{1, 4\}, \{2, 3\}$  are preferred extensions of  $AF$ .

Figure 2 depict the lattice structure of the extensions of  $AF$ .

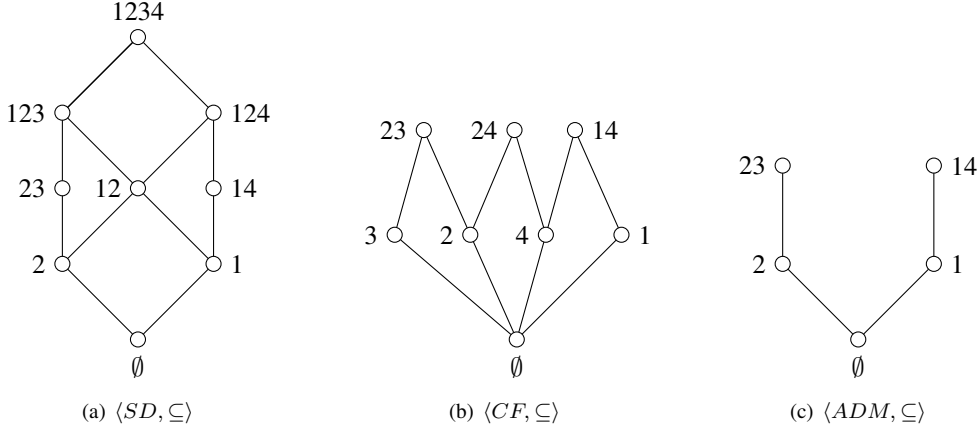

**Fig. 2:** From left to right: the lattice of  $SD$ , meet-semilattice of  $CF$  and meet-semilattice of  $ADM$ .

### 3 Argumentation framework vs implicational system

In this section, we are interested in representing an argumentation framework using implicational systems. First, we show that an implicational system  $\Sigma$  can be associated to any argumentation framework for which its self-defending sets are exactly the complement of closed sets of  $\Sigma$ . Then, we give an example of an implicational system for which there is no argumentation framework having the previous property. We also show that for any implicational system  $\Sigma$  there always exists an argumentation framework whose admissible sets are exactly the complement of closed sets of  $\Sigma$ . We are not able to characterize the class of attack graphs for which its set of admissible sets is a lattice.

#### 3.1 How to associate an implicational system to an argumentation framework

Let  $AF = \langle \mathcal{A}, \mathcal{R} \rangle$  be an argumentation framework. We describe a method to associate an implicational system  $\Sigma$  to the argumentation framework  $AF$ . Dung (1995) shows the family  $SD$  is closed under union (i.e.  $\forall X, Y \in SD, X \cup Y \in SD$ ) and contains the empty set, or equivalently  $SD^c$  is closed under intersection (i.e.  $\forall X, Y \in SD^c, X \cap Y \in SD^c$ ) and contains the set  $\mathcal{A}$ . Thus,  $SD^c$  is a closure system for which exists an implicational system  $\Sigma(\mathcal{A}, \mathcal{R})$  ( $\Sigma$  for short) whose closed sets are exactly  $SD^c$ . Moreover  $(SD^c, \subseteq)$  is a lattice.

Consider the implicational system  $\Sigma$  as follows:

$$\Sigma = \{y^- \rightarrow z \mid (y, z) \in \mathcal{R} \text{ and } (z, y) \notin \mathcal{R}\}. \quad (1)$$

The meaning of an implication  $y^- \rightarrow z$  is that: *a self-defending set not containing  $y^-$  it cannot contain  $z$* . Notice that for any  $x \in U^+$  we have  $\emptyset \rightarrow x$ , i.e. an argument attacked by an unattacked argument cannot belong to a self-defending set.

The following example illustrates the construction of  $\Sigma$ .

**Example 2.** Let  $AF = \langle \mathcal{A}, \mathcal{R} \rangle$  be the argumentation framework corresponding to the attack graph depicted in Figure 3(a). The resulting implicational system when applying the Formula 1 is  $\Sigma = \{\emptyset \rightarrow 3,$

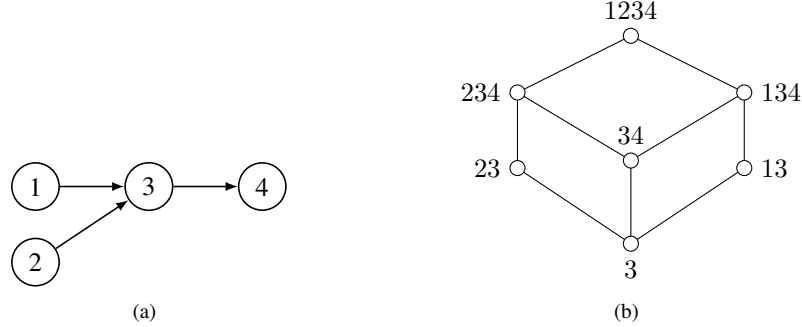

**Fig. 3:** On the left the attack graph of  $AF$ . On the right the corresponding lattice to  $\Sigma = \{\emptyset \rightarrow 3, 12 \rightarrow 4\}$ .

$12 \rightarrow 4\}$ . The closed sets of  $\Sigma$  is  $\mathcal{F}_\Sigma = SD^c = \{\{3\}, \{3, 4\}, \{2, 3\}, \{1, 3\}, \{1, 3, 4\}, \{2, 3, 4\}, \{1, 2, 3, 4\}\}$  and the set of all self-defending sets of  $AF$  is  $SD = \mathcal{F}_\Sigma^c = \{\emptyset, \{1\}, \{2\}, \{2, 4\}, \{1, 4\}, \{1, 2\}, \{1, 2, 4\}\}$ . Figure 3(b) shows the lattice  $\mathcal{L}_\Sigma$  corresponding to  $\Sigma = \{12 \rightarrow 4, \emptyset \rightarrow 3\}$ .

The following theorem shows that the set of all closed sets of  $\Sigma$  is equal to  $SD^c$ .

**Theorem 3.1.** Let  $AF = \langle \mathcal{A}, \mathcal{R} \rangle$  be an argumentation framework and  $\Sigma$  the implicational system constructed from  $AF$  using Formula 1. Then  $\mathcal{F}_\Sigma = SD^c$ .

**Proof:** First, we prove that  $\mathcal{F}_\Sigma \subseteq SD^c$ . Let  $F \in \mathcal{F}_\Sigma$  and suppose that  $F \notin SD^c$ . It implies that  $\bar{F} \notin SD$ . By definition of  $SD$ , we have  $\bar{F}^- \not\subseteq \bar{F}^+$ . Then exist  $z \in \bar{F}$  and  $y \in \mathcal{A}$  such that  $y^- \subseteq F$  and  $(y, z) \in \mathcal{R}$ , i.e.  $y$  attack  $z$ . Moreover,  $z$  does not attack  $y$ . So, by construction of  $\Sigma$ , we have  $y^- \rightarrow z \in \Sigma$ . This contradicts that  $F \in \mathcal{F}_\Sigma$ , since  $F$  contains  $y^-$  and not  $z$ .

Second, we prove that  $SD^c \subseteq \mathcal{F}_\Sigma$ . Let  $F \in SD^c$  and assume that  $F \notin \mathcal{F}_\Sigma$ . By the construct of  $\Sigma$  there exist  $y, z \in \mathcal{A}$  such that  $(y, z) \in \mathcal{R}, (z, y) \notin \mathcal{R}, y^- \subseteq F$  and  $z \notin F$ . Thus  $z \in \bar{F}$  and  $z$  is not defended against  $y$ . Hence  $\bar{F} \notin SD$ .  $\square$

Now, we give an example of implicational system  $\Sigma$  for which there is no argumentation framework whose set of all self-defending sets is equal to  $\mathcal{F}_\Sigma^c$ . We also show how to associate an argumentation framework to a given implicational system  $\Sigma$  while its admissible sets are exactly the complement of closed sets of  $\Sigma$ .

### 3.2 How to associate an argumentation framework to an implicational system

Consider an implicational system  $\Sigma = \{X_j \rightarrow x_j, j = 1, \dots, n\}$  over a finite set  $\mathcal{B}$ . First, we provide an example of implicational system  $\Sigma$  for which there is no argumentation framework satisfying  $\mathcal{F}_\Sigma^c = SD$ .

**Proposition 1.** Let  $\Sigma = \{1 \rightarrow 2, 2 \rightarrow 1\}$  be an implicational system over the set  $\mathcal{B} = \{1, 2\}$ . There is no argumentation framework  $AF = \langle \mathcal{A}, \mathcal{R} \rangle$  satisfying  $\mathcal{F}_\Sigma^c = SD$ .

**Proof:** We have  $\mathcal{F}_\Sigma^c = \{\emptyset, \{1, 2\}\}$ . Suppose that exists an argumentation framework  $AF = \langle \mathcal{A}, \mathcal{R} \rangle$ , satisfying  $\mathcal{F}_\Sigma^c = SD$ . Since  $\{1\}$  and  $\{2\}$  are not self-defending, there must exist arguments  $\alpha_1, \alpha_2 \in \mathcal{A}$  such that  $(\alpha_1, 1) \in \mathcal{R}$  and  $(\alpha_2, 2) \in \mathcal{R}$ . Moreover,  $\{1, 2\} \in SD$  implies that  $(1, \alpha_2) \in \mathcal{R}$  and  $(2, \alpha_1) \in \mathcal{R}$ . So  $\alpha_1$  and  $\alpha_2$  are not in  $\mathcal{B}$  and thus  $\mathcal{A} \setminus \mathcal{B} \neq \emptyset$ . Moreover any non empty subset  $S \subseteq \mathcal{A} \setminus \mathcal{B}$  is not self-defending, i.e.  $(\mathcal{A} \setminus \mathcal{B})^- \not\subseteq (\mathcal{A} \setminus \mathcal{B})^+$ . Since  $\{1, 2\} \subseteq (\mathcal{A} \setminus \mathcal{B})^+$  then, by definition of  $SD$  exist arguments  $\alpha, \alpha' \in \mathcal{A} \setminus \mathcal{B}$  such that  $(\alpha, \alpha') \in \mathcal{R}$  and  $\alpha^- = \emptyset$ . This cannot be hold since  $\{\alpha\} \notin SD$ . We obtain a contradiction with the fact that  $SD = \mathcal{F}_\Sigma^c$ .  $\square$

On the other hand, for any implicational system  $\Sigma$ , we can always associate an argumentation framework satisfying  $\mathcal{F}_\Sigma^c = ADM$ . The idea is that for any implication  $X_j \rightarrow x_j \in \Sigma$  we add an extra argument  $\alpha_j$  that attacks  $x_j$  and each argument  $z \in X_j$  attacks  $\alpha_j$ . We also add an arc  $(\alpha_j, \alpha_j)$  to avoid that  $\alpha_j$  is conflict-free.

The argumentation framework  $AF(\Sigma) = \langle \mathcal{A}, \mathcal{R} \rangle$ , associated to  $\Sigma$ , is obtained by the following formula.

$$\begin{aligned} \mathcal{A} &= \mathcal{B} \cup \{\alpha_1, \dots, \alpha_n\}, \\ \mathcal{R} &= \bigcup_{X_j \rightarrow x_j \in \Sigma} \left( \{(z, \alpha_j) \mid z \in X_j\} \cup \{(\alpha_j, x_j), (\alpha_j, \alpha_j)\} \right). \end{aligned} \quad (2)$$

The following example illustrates the previous construction.

**Example 3.** Let  $\Sigma = \{15 \rightarrow 3, 3 \rightarrow 1, 2 \rightarrow 4, 4 \rightarrow 2, \emptyset \rightarrow 2\}$  be an implicational system over the set  $\mathcal{B} = \{1, 2, 3, 4, 5\}$ . The attack graph of the argumentation framework  $AF(\Sigma) = \langle \mathcal{A}, \mathcal{R} \rangle$  constructed from  $\Sigma$  using Formula 2 is given in Figure 4.

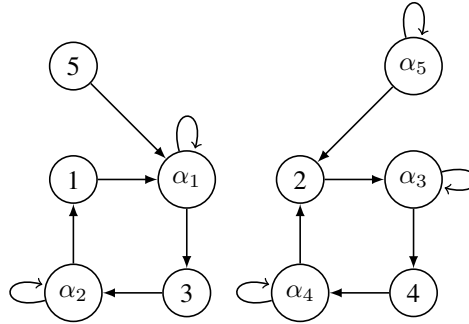

**Fig. 4:** The attack graph of  $AF(\Sigma)$ .

It is worth noticing that the argumentation framework constructed in Figure 4 does not satisfy  $\mathcal{F}_\Sigma^c = SD$ .

**Theorem 3.2.** *Let  $\Sigma = \{X_j \rightarrow x_j, j = 1, \dots, n\}$  be an implicational system over a finite set  $\mathcal{B}$  and  $AF(\Sigma) = \langle \mathcal{A}, \mathcal{R} \rangle$  the argumentation framework constructed from  $\Sigma$  using Formula 2. Then  $ADM = \mathcal{F}_\Sigma^c$ .*

**Proof:** By construction of  $AF$  we have  $\mathcal{B} \in CF$ , and an argument  $x_j \in \mathcal{B}$  is attacked by  $\alpha_j$  whenever exists  $X_j \rightarrow x_j \in \Sigma$ . Let  $F \subseteq \mathcal{B}$ . Then

$$\begin{aligned} \bar{F} \in ADM &\text{ iff } \bar{F} \in SD \\ &\text{ iff for all } X_j \rightarrow x_j \in \Sigma, x_j \notin \bar{F} \text{ or } X_j \cap \bar{F} \neq \emptyset \\ &\text{ iff for all } X_j \rightarrow x_j \in \Sigma, x_j \in F \text{ or } X_j \not\subseteq F \\ &\text{ iff } F \in \mathcal{F}_\Sigma. \end{aligned}$$

□

## 4 On the enumeration of extensions

In this section, we focus on the enumeration of all admissible extensions in an argumentation framework  $AF = \langle \mathcal{A}, \mathcal{R} \rangle$ . The following proposition gives the lattice point of view of admissible sets:

**Proposition 2.** *Let  $AF = \langle \mathcal{A}, \mathcal{R} \rangle$  be an argumentation framework,  $\Sigma$  its associated implication system and  $S \subseteq \mathcal{A}$ . Then the following assertions are equivalent:*

1.  $S$  is an admissible extension of  $AF$ ;
2.  $S$  is self-defending and conflict-free in  $AF$ ;
3.  $\bar{S}$  is a closed set of  $\Sigma$  and  $S$  conflict-free in  $AF$ ;
4.  $\bar{S}$  is a closed set of  $\Sigma$  and a vertex cover of  $AF$ .

**Remark 1.** *Notice that admissible sets of  $AF$  are also known as semi-kernel in a directed graph Neumann-Lara (1971).*

**Theorem 4.1.** *Dimopoulos and Torres (1996) The enumeration of admissible sets cannot be solved in polynomial time in the size of the input and the output unless  $P = NP$ .*

The problems of enumerating all admissible and preferred extensions and other extensions in argumentation frameworks have been considered in the literature (see, e.g. Bistarelli et al. (2015); Cerutti et al. (2018, 2014); Charwat et al. (2015); Nofal et al. (2014)).

However, there are few known tractable classes where both problems can be solved efficiently. When the argumentation framework  $AF$  is symmetric Coste-Marquis et al. (2005), the associated implicational system is empty and the enumeration of admissible extensions is equivalent to the enumeration of conflict-free sets of  $AF$ . In this case, admissible and preferred extensions can be listed in polynomial delay and space Johnson et al. (1988).

In the case where the argumentation framework does not contain even-length cycles (even-cycle-free argumentation framework), the preferred extension is unique Dunne and Bench-Capon (2001), and the enumeration of admissible sets is equivalent to the enumeration of closed sets of an implicational system which can be achieved in polynomial delay and space using the Next closure algorithm Ganter (2010). For bipartite argumentation frameworks, the enumeration of admissible sets can be solved in polynomial delay and exponential space, whereas the enumeration of preferred extensions is intractable, see Dunne (2007); Kröll et al. (2017).

For the enumeration of closed sets of an implicational system, a polynomial delay and space algorithm (known as Next-closure) is given in Ganter (2010). Thus, according to Theorem 3.1, the set  $SD^c$  can be listed in polynomial delay and space algorithm. Hence, the difficulty of enumerating admissible extensions (i.e.  $SD \cap CF$ ) comes from the fact that some self-defending sets of  $SD$  (may be exponential) are not conflict-free. Equivalently, there are closed sets in  $SD^c$  that are not set covers of the argumentation framework  $AF$ . The following section describes some properties that may reduce such closed sets in  $SD^c$  that are not vertex covers.

#### 4.1 Conflict-closed sets reduction

We propose conflict-closed sets reduction rules, based on implicational system, to find out minimal subsets of vertex cover closed, while maintaining all potential admissible extensions as well as preferred extensions. Let  $AF = \langle \mathcal{A}, \mathcal{R} \rangle$  be an argumentation framework and  $\Sigma$  its associated implicational system. We will build an implicational system, denoted by  $\Sigma_r$ , from  $\Sigma$  such that the size of  $\mathcal{F}_{\Sigma_r}$  is smaller than the size of  $\mathcal{F}_{\Sigma}$  and all admissible sets are preserved, i.e.  $\mathcal{F}_{\Sigma_r}^c \cap CF = ADM$ . The idea is to delete closed sets of  $\Sigma$  that are not vertex covers of  $AF$ , i.e. those closed sets that its complement contains an edge of  $\mathcal{R}$ . The set  $\Sigma_r$  is obtained from  $\Sigma$  by applying successively the following algorithm:

*Conflict reduction algorithm:*

- (a) *Self-Conflict:* If  $(x, x) \in \mathcal{R}$ , then add the implication  $\emptyset \rightarrow x$  to  $\Sigma_r$ ;
- (b) *Conflict Type 1:* If  $X \rightarrow x \in \Sigma$ , then in  $\Sigma_r$  replace  $X \rightarrow x$  by the set of implications  $\{X \setminus T \rightarrow z \mid z \in X^\Sigma \setminus (X \cup \emptyset^\Sigma), T = \{t \in X \mid \{t, z\} \notin CF\}\}$ ;
- (c) *Conflict Type 2:* If  $X \rightarrow x \in \Sigma$ , then in  $\Sigma_r$  replace the implication  $X \rightarrow x$  by  $X \setminus T \rightarrow x$ , where  $T = \{t \in X \mid x \in \Gamma(t)^\Sigma\}$  and  $\Gamma(t) = \{y \in \mathcal{A} \mid \{y, t\} \notin CF\}$ .

The following example illustrates the construction of  $\Sigma_r$  from  $\Sigma$ .

**Example 4.** Let  $AF = \langle \mathcal{A}, \mathcal{R} \rangle$  be the argumentation framework corresponding to the attack graph depicted in Figure 5. Its associated implicational system is  $\Sigma = \{4 \rightarrow 2, 1 \rightarrow 3, 45 \rightarrow 3, 18 \rightarrow 5, 45 \rightarrow 6, 5 \rightarrow 7, 6 \rightarrow 8\}$ . The set of all admissible set of  $AF$  is  $ADM = \{\emptyset, \{1\}, \{4\}, \{2, 4\}, \{4, 6\}, \{2, 4, 6\}\}$ .

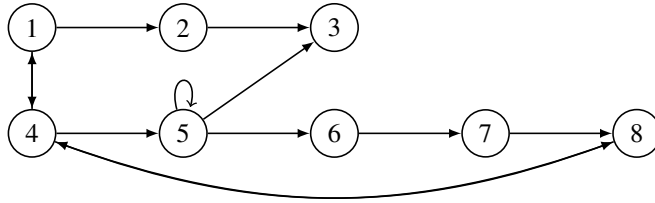

Fig. 5: Attack graph of  $AF$ .

We illustrate the application of the rules of the conflict reduction algorithm.

- *Self-Conflict:*  $(5, 5) \in \mathcal{R}$ , then the implication  $\emptyset \rightarrow 5$  is added to  $\Sigma_r$ .

- *Conflict Type 1:*  $45 \rightarrow 6 \in \Sigma$ ,  $\{4, 5\}^\Sigma \setminus \{4, 5\} = \{2, 3, 6, 7, 8\}$  and  $\{2, 5\} \notin CF$ ,  $\{3, 5\} \notin CF$ ,  $\{6, 5\} \notin CF$ ,  $\{7, 5\} \notin CF$ ,  $\{8, 5\} \notin CF$  and  $\{8, 4\} \notin CF$ . Then in  $\Sigma_r$  the implication  $45 \rightarrow 6$  is replaced by the implications  $4 \rightarrow 2$ ,  $4 \rightarrow 3$ ,  $4 \rightarrow 6$ ,  $4 \rightarrow 7$  and  $\emptyset \rightarrow 8$ .
- *Conflict Type 2:*  $45 \rightarrow 3 \in \Sigma$  and  $3 \in \Gamma(4)^\Sigma = \{1, 3, 5, 7, 8\}$  and  $3 \in \Gamma(5)^\Sigma = \{2, 3, 4, 5, 6, 7, 8\}$ . Then in  $\Sigma_r$  the implication  $45 \rightarrow 3$  is replaced by the implication  $\emptyset \rightarrow 3$ .

The constructed implicational system, using our algorithm, is  $\Sigma_r = \{4 \rightarrow 2, 4 \rightarrow 6, \emptyset \rightarrow 3, \emptyset \rightarrow 5, \emptyset \rightarrow 7, \emptyset \rightarrow 8\}$ . The complement of the closure system  $\mathcal{F}_{\Sigma_r}$  is  $\mathcal{F}_{\Sigma_r}^c = \{\emptyset, \{1\}, \{4\}, \{1, 4\}, \{2, 4\}, \{4, 6\}, \{1, 2, 4\}, \{1, 4, 6\}, \{2, 4, 6\}, \{1, 2, 4, 6\}\}$ .

**Theorem 4.2.** Let  $AF = \langle \mathcal{A}, \mathcal{R} \rangle$  be an argumentation framework,  $\Sigma$  its associated implication system and  $\Sigma_r$  its reduced implicational system. Then  $ADM \subseteq \mathcal{F}_{\Sigma_r}^c \subseteq \mathcal{F}_\Sigma^c$ .

**Proof:** To show that  $\mathcal{F}_{\Sigma_r}^c \subseteq \mathcal{F}_\Sigma^c$ , it suffices to show that  $\mathcal{F}_{\Sigma_r} \subseteq \mathcal{F}_\Sigma$ . We proceed by contradiction. Assume that exists  $F \in \mathcal{F}_{\Sigma_r}$  such that  $F \notin \mathcal{F}_\Sigma$ . Then exists at least an implication  $X \rightarrow x \in \Sigma$  not satisfied by  $F$ , i.e.,  $X \subseteq F$  and  $x \notin F$ . By construction of  $\Sigma_r$ , the implication  $X \rightarrow x$  is replaced by  $X \setminus T \rightarrow x$  in  $\Sigma_r$  (Conflict Type 2). As  $X \subseteq F$ , then  $X \setminus T \subseteq F$ . We have  $X \setminus T \subseteq F$  and  $x \notin F$ . Hence, the implication  $X \setminus T \rightarrow x$  is not satisfied by  $F$ , which is a contradiction.

Now we show that  $ADM \subseteq \mathcal{F}_{\Sigma_r}^c$ . As  $ADM \subseteq \mathcal{F}_\Sigma^c$  (see, Theorem 3.1) it suffices to show that for all  $F \in \mathcal{F}_\Sigma \setminus \mathcal{F}_{\Sigma_r}$ ,  $\bar{F} \notin CF$ . Let  $F \in \mathcal{F}_\Sigma \setminus \mathcal{F}_{\Sigma_r}$ , then there exists at least an implication  $X \rightarrow x$  in  $\Sigma_r$  such that  $X \subseteq F$  and  $x \notin F$ . By construction of  $\Sigma_r$ , the implication  $X \rightarrow x$  is added by one of three reduction rules:

1. *Self-Conflict:* then  $X = \emptyset$  and  $(x, x) \in \mathcal{R}$ . As  $x \notin F$ , then  $x \in \bar{F}$ . Hence,  $\bar{F} \notin CF$ ;
2. *Conflict Type 1:* then there exists  $T \subseteq \mathcal{A}$  such  $F$  satisfied the implication  $X \cup T \rightarrow z \in \Sigma$  with  $x \in (X \cup T)^\Sigma \setminus ((X \cup \emptyset^\Sigma) \cup T)$  and for all  $t \in T$ ,  $\{t, x\} \notin CF$ . Since  $X \subseteq F$  and  $x \notin F$ , we have  $(X \cup T) \not\subseteq F$  and thus  $T \not\subseteq F$ . Then exists  $y \in T$  with  $y \in \bar{F}$ . We deduce that  $\bar{F} \notin CF$  since  $\{y, x\} \subseteq \bar{F}$  and  $\{y, x\} \notin CF$ ;
3. *Conflict Type 2:* then there exists  $T \subseteq \mathcal{A}$  such  $F$  satisfied the implication  $X \cup T \rightarrow x \in \Sigma$  with for all  $t \in T$ ,  $x \in \Gamma(t)^\Sigma$  and  $\Gamma(t) = \{y \in \mathcal{A} \mid \{y, t\} \notin CF\}$ . As  $X \subseteq F$  and  $x \notin F$  then  $T \not\subseteq F$  and for all  $t \in T$ ,  $\Gamma(t) \not\subseteq F$ . Thus exist  $x', y' \in \bar{F}$  such that  $x' \in T$  and  $y' \in \Gamma(x')$ . We deduce that  $\bar{F} \notin CF$  since  $\{x', y'\} \notin CF$ .

Consequently, if  $F \in \mathcal{F}_\Sigma \setminus \mathcal{F}_{\Sigma_r}$ , then  $\bar{F} \notin CF$  and thus  $ADM \subseteq \mathcal{F}_{\Sigma_r}^c$ .  $\square$

It is worth noticing that the closure system of the implicational system constructed by the previous algorithm is not minimal as shown in Example 5.

**Example 5.** Let  $AF = \langle \mathcal{A}, \mathcal{R} \rangle$  be the argumentation framework corresponding to the attack graph depicted in Figure 6, and  $\Sigma = \{1 \rightarrow 3, 347 \rightarrow 6\}$  its associated implicational system. The constructed implicational system by the conflict reduction algorithm is equal to  $\Sigma$ . Let  $\Sigma' = \{1 \rightarrow 3, 47 \rightarrow 6\}$  be another implicational system associated to  $AF$ . By construction it is clear that  $\mathcal{F}_{\Sigma'} \subseteq \mathcal{F}_\Sigma$ . Therefore, the size of  $\mathcal{F}_{\Sigma'}$  is less than the size of  $\mathcal{F}_\Sigma$ . Now, let us show that  $\mathcal{F}_{\Sigma'}^c \cap CF = ADM$ . It suffices to show that if  $F \in \mathcal{F}_\Sigma$  and  $F \notin \mathcal{F}_{\Sigma'}$ , then  $\bar{F} \notin CF$ . Let  $F \in \mathcal{F}_\Sigma$  and suppose that  $F \notin \mathcal{F}_{\Sigma'}$ . Then,  $F$  does not satisfy

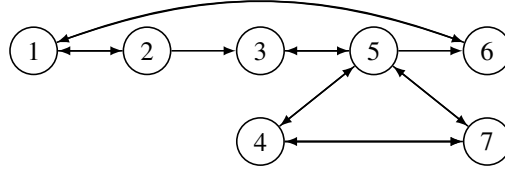

**Fig. 6:** Attack graph of  $AF$ .

the implication  $47 \rightarrow 6$ , i.e.  $\{4, 7\} \subseteq F$  and  $6 \notin F$ . We have  $F \in \mathcal{F}_\Sigma, 347 \rightarrow 6 \in \Sigma, \{4, 7\} \subseteq F$  and  $6 \notin F$  then  $3 \notin F$ . Since  $F \in \mathcal{F}_\Sigma, 1 \rightarrow 3 \in \Sigma$  and  $3 \notin F$ , then  $1 \notin F$ . As a result  $\{1, 3, 6\} \cap F = \emptyset$ . Thus,  $\{1, 3, 6\} \subseteq \bar{F}$  and as  $\{1, 6\} \notin CF$ , then  $\bar{F} \notin CF$ . We deduce that  $\mathcal{F}_\Sigma^c \cap CF = ADM$  and hence the closure system of the implicational system constructed by the conflict reduction algorithm is not minimal.

The conflict reduction algorithm reduces the number of closed sets of  $\Sigma$  that are not vertex covers by adding implications. One would ask the following question: is there a  $\Sigma_r$  such that  $\mathcal{F}_{\Sigma_r}^c = ADM$ ?

The answer to this question is not always positive. Since  $ADM$  is not closed under union in general, as shown in Example 6 or equivalently  $ADM^c$  is not closed under intersection. Therefore, the set of all admissible sets cannot be encoded by an implicational system.

**Example 6.** The set of all admissible sets of the argumentation framework depicted in Figure 6 is  $ADM = \{\emptyset, \{1\}, \{2\}, \{4\}, \{5\}, \{7\}, \{1, 4\}, \{1, 5\}, \{1, 7\}, \{1, 3\}, \{2, 4\}, \{2, 5\}, \{2, 7\}, \{4, 6\}, \{6, 7\}, \{2, 4, 6\}, \{2, 6, 7\}, \{1, 3, 7\}, \{1, 3, 4\}\}$ . Observe that  $\{1\}, \{2\} \in ADM$  but  $\{1\} \cup \{2\} = \{1, 2\} \notin ADM$  which prove that  $ADM$  is not closed under union in general.

Now, we give a characterization of argumentation frameworks for which  $\mathcal{F}_{\Sigma_r}^c = ADM$ , or all self-defending sets are admissible.

**Theorem 4.3.** An argumentation framework satisfies  $\mathcal{F}_{\Sigma_r}^c = ADM$  if and only if  $\mathcal{A} \setminus \emptyset^{\Sigma_r} \in CF$ .

**Proof:** Let us prove the necessary condition. Suppose that  $\mathcal{F}_{\Sigma_r}^c = ADM$ . We have by definition  $ADM \subseteq CF$ , then  $\mathcal{F}_{\Sigma_r}^c \subseteq CF$ . And as  $\mathcal{A} \setminus \emptyset^{\Sigma_r} \in \mathcal{F}_{\Sigma_r}^c$ , then it is conflict-free.

Now we prove the sufficient condition. It is clear that  $\emptyset^{\Sigma_r}$  is the unique minimal closed set in  $\mathcal{F}_{\Sigma_r}^c$ , thus its complement  $\mathcal{A} \setminus \emptyset^{\Sigma_r}$  is the unique maximal closed set in  $\mathcal{F}_{\Sigma_r}^c$ . Therefore, for all  $F \in \mathcal{F}_{\Sigma_r}^c, F \subseteq \mathcal{A} \setminus \emptyset^{\Sigma_r}$ . Suppose that  $\mathcal{A} \setminus \emptyset^{\Sigma_r} \in CF$ , then for all  $F \in \mathcal{F}_{\Sigma_r}^c, F \in CF$ . Thus,  $\mathcal{F}_{\Sigma_r}^c \subseteq CF$ . By Theorem 4.2,  $\mathcal{F}_{\Sigma_r}^c = ADM$ .  $\square$

Notice that if  $\mathcal{F}_{\Sigma_r}^c = ADM$  then the set  $ADM$  ordered under inclusion is a lattice. But to check if  $ADM$  ordered under inclusion is a lattice is equivalent to check if there is a unique preferred extension which has been shown coNP-complete Dvořák and Dunne (2017).

**Theorem 4.4.** Dvořák and Dunne (2017) It is coNP-complete to check if the set of all admissible sets of an argumentation framework ordered under inclusion is lattice.

The even-cycle-free argumentation frameworks satisfies the property  $\mathcal{F}_{\Sigma_r}^c = ADM$ .

**Definition 1.** An argumentation framework  $AF = \langle \mathcal{A}, \mathcal{R} \rangle$  is said to be an even-cycle-free argumentation framework if it does not contain even-length cycles.

**Theorem 4.5.** *If  $AF = \langle \mathcal{A}, \mathcal{R} \rangle$  is an even-cycle-free argumentation framework, then the reduced  $\Sigma_r$  satisfies  $\mathcal{F}_{\Sigma_r}^c = ADM$ .*

**Proof:** Let  $F \in \mathcal{F}_{\Sigma_r}^c$  by Theorem 4.2 and Theorem 3.1  $F \in SD$ . Suppose that  $F \notin CF$ . By definition of  $CF$ , there exist  $x_1, y_1 \in F$  such that  $(x_1, y_1) \in \mathcal{R}$ . Since  $AF$  is an argumentation framework without even-length cycles, then the case  $(y_1, x_1) \in \mathcal{R}$  does not hold, and so,  $F$  being a self-defending set must be some  $y_2 \in F$  such that  $(y_2, x_1) \in \mathcal{R}$ . By reasoning similarly for  $x_1$ , there exists some  $x_2 \in F$  such that  $(x_2, y_2) \in \mathcal{R}$ . Repeating this process, we identify a path  $P = x_k y_k \dots x_1 y_1$ . As  $AF$  is finite, then the path  $P$  must be finite with an unattacked argument or  $x_k = y_1$ , i.e.  $P$  is an odd-cycle. If  $P$  be finite with an unattacked argument, then there exists in  $F$  an argument attacked by unattacked argument, a contradiction with the fact that  $F$  is a self-defending set. Thus,  $P$  is an odd-cycle. It is thus clear that for all  $i \in \{1, \dots, k\}$ ,  $F \setminus x_i \notin SD$  and  $F \setminus y_i \notin SD$ . As  $\mathcal{F}_{\Sigma}^c = SD$  (see, Theorem 3.1) this implies that for all  $i \in \{1, \dots, k\}$ ,  $F \setminus x_i \notin \mathcal{F}_{\Sigma}^c$  and  $F \setminus y_i \notin \mathcal{F}_{\Sigma}^c$ . Then, for all  $i \in \{1, \dots, k\}$ ,  $\{x_i\}^{\Sigma} = P$ . By construction of  $\Sigma_r$ , the implications  $\emptyset \rightarrow y_i$ , with  $i = 1, \dots, k$ , belong to  $\Sigma_r$ . This contradicts the fact that  $F \in \mathcal{F}_{\Sigma_r}^c$ . We deduce the proof.  $\square$

**Remark 2.** *The idea of the proof of Theorem 4.5 comes from the proof in Dunne and Bench-Capon (2001).*

It is worth noticing that whenever  $\mathcal{F}_{\Sigma_r}^c = ADM$ , the set of all admissible sets ordered under inclusion is a lattice containing a unique maximal element which corresponds to a unique preferred extension.

In fact, there are argumentation frameworks satisfying  $\mathcal{F}_{\Sigma_r}^c = ADM$ , but are not even-cycle-free as shown in Example 7.

**Example 7.** *Let  $AF = \langle \mathcal{A}, \mathcal{R} \rangle$  be the argumentation framework corresponding to the attack graph depicted in Figure 7. The set of all admissible sets of  $AF$  is  $ADM = \{\emptyset, \{1\}, \{1, 3, 5, 7\}\}$  and its associated implicational system is  $\Sigma = \{12 \rightarrow 3, 67 \rightarrow 3, 28 \rightarrow 4, 3 \rightarrow 5, 4 \rightarrow 6, 58 \rightarrow 7, 6 \rightarrow 8\}$ . The*

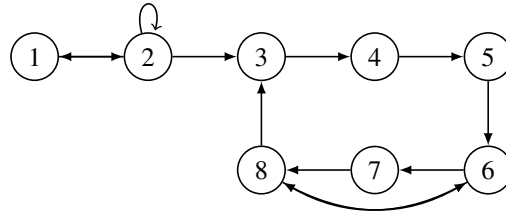

**Fig. 7:** Attack graph of  $AF$ .

constructed implicational system by the conflict reduction algorithm is  $\Sigma_r = \{\emptyset \rightarrow 2, \emptyset \rightarrow 4, \emptyset \rightarrow 6, \emptyset \rightarrow 8, 1 \rightarrow 3, 1 \rightarrow 5, 1 \rightarrow 7, 3 \rightarrow 5, 3 \rightarrow 7, 5 \rightarrow 3, 5 \rightarrow 7, 7 \rightarrow 3, 7 \rightarrow 5, 67 \rightarrow 3\}$ . The complement of  $\mathcal{F}_{\Sigma_r}$  is  $\mathcal{F}_{\Sigma_r}^c = \{\emptyset, \{1\}, \{1, 3, 5, 7\}\} = ADM$ . Observe that  $\mathcal{F}_{\Sigma_r}^c = ADM$  despite the fact that  $AF$  is not even-cycle-free argumentation framework.

As a consequence, there is polynomial delay and space algorithm to enumerate the set of all admissible extensions for argumentation frameworks satisfying  $\mathcal{F}_{\Sigma_r}^c = ADM$ . This can be achieved using the algorithm for enumerating closed sets of  $\Sigma$  in Ganter (2010).

**Theorem 4.6.** *The problem of enumerating all admissible extensions can be solved in polynomial delay and space for  $AF = \langle \mathcal{A}, \mathcal{R} \rangle$  with  $\mathcal{F}_{\Sigma_r}^c = ADM$ .*

## 4.2 Decomposition of argumentation framework

In this section, we are interested in decomposing an argumentation framework into smaller ones, and show how to enumerate admissible sets from the smaller ones. Consider an argumentation framework  $AF = \langle \mathcal{A}, \mathcal{R} \rangle$  and its associated implicational system  $\Sigma$ .

**Definition 2.** *A  $\Sigma$ -partition is a partition of the set of arguments  $\mathcal{A}$  into sets  $A_1$  and  $A_2$  (i.e.  $A_1 \cup A_2 = \mathcal{A}$  and  $A_1 \cap A_2 = \emptyset$ ) such that  $\Sigma_{A_1} \cup \Sigma_{A_2} = \Sigma$ , where  $\Sigma_{A_i} = \{X \rightarrow x \in \Sigma \mid X \cup \{x\} \subseteq A_i\}$  for  $i \in \{1, 2\}$  are disjoint.*

We use  $ADM[A_1]$  and  $ADM[A_2]$  to denote the set of admissible sets included in  $A_1$  and  $A_2$  respectively.

The following example illustrates a  $\Sigma$ -partition of an argumentation framework and its set of admissible sets.

**Example 8.** *Consider the argumentation framework depicted in Figure 8(a) and its associated implicational system  $\Sigma = \{156 \rightarrow 3, 25 \rightarrow 3, 25 \rightarrow 4, 156 \rightarrow 4, \emptyset \rightarrow 6, 710 \rightarrow 9\}$ .*

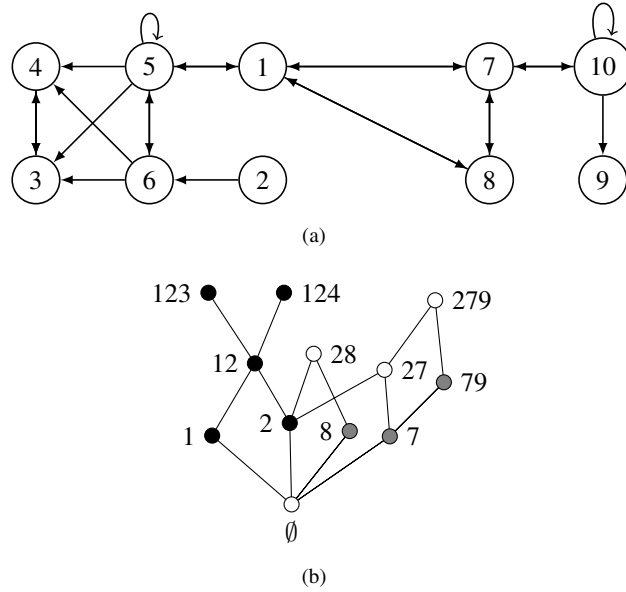

**Fig. 8:** (a) A partition of the argumentation framework into  $\{A_1 = \{1, 2, 3, 4, 5, 6\}, A_2 = \{7, 8, 9, 10\}\}$ ; (b): black dots stand for the admissible sets  $ADM[A_1]$ ; gray dots stand for the admissible sets  $ADM[A_2]$ ; and the uncoloured ones stand for the admissible sets  $F_1 \cup F_2$  such that  $F_1 \in ADM[A_1]$  and  $F_2 \in ADM[A_2]$ .

Consider the partition  $A_1 = \{1, 2, 3, 4, 5, 6\}$  and  $A_2 = \{7, 8, 9, 10\}$  and their associated implicational systems  $\Sigma_{A_1} = \{156 \rightarrow 3, 25 \rightarrow 3, 25 \rightarrow 4, 156 \rightarrow 4, \emptyset \rightarrow 6\}$  and  $\Sigma_{A_2} = \{7 \rightarrow 10 \rightarrow 9\}$ . We have  $ADM[A_1] = \{\emptyset, \{1\}, \{2\}, \{1, 2\}, \{1, 2, 3\}, \{1, 2, 4\}\}$  and  $ADM[A_2] = \{\emptyset, \{7\}, \{8\}, \{7, 9\}\}$ . Figure 8(b) depicts the meet-semilattice of the set of all admissible sets.

Given a  $\Sigma$ -partition of an argumentation framework  $AF$ , we give a characterization of the set of all admissible sets of  $AF$ .

**Theorem 4.7.** *Let  $AF = \langle \mathcal{A}, \mathcal{R} \rangle$  be an argumentation framework and  $\{A_1, A_2\}$  a  $\Sigma$ -partition of  $\mathcal{A}$ . Then a subset  $F \in ADM$  if and only if there exist  $F_1 \in ADM[A_1]$  and  $F_2 \in ADM[A_2]$ , such that  $F_1 \cup F_2 = F \in CF$ .*

**Proof:** Suppose that  $F \in ADM$  and  $F_1 = F \cap A_1$  and  $F_2 = F \cap A_2$ . Then, by definition,  $F \in CF$ , and by Theorem 3.1,  $F \in \mathcal{F}_\Sigma^c$ . Without loss of generality, we show that  $F_1 \in ADM[A_1]$ . Clearly,  $F_1 \in CF$  since  $F \in CF$ . We prove that  $\bar{F}_1 \in \mathcal{F}_{\Sigma_{A_1}}$  by contradiction. Suppose that  $\bar{F}_1 \notin \mathcal{F}_{\Sigma_{A_1}}$ . So there is an implication  $X \rightarrow x \in \Sigma_{A_1}$  such that  $X \subseteq \bar{F}_1 \subseteq A_1$ ,  $x \in A_1$  and  $x \notin \bar{F}_1$ . Since  $\bar{F} \cap A_1 = \bar{F}_1$  and  $\bar{F} \in \mathcal{F}_{\Sigma_{A_1}}$ , we have  $X \subseteq \bar{F}$  and  $x \in \bar{F}$ . Therefore,  $x \notin F$  and  $x \notin F_1$  and thus  $x \in \bar{F}_1$  which contradicts the hypothesis.

Now suppose that  $F \in CF$ ,  $F_1 \in ADM[A_1]$  and  $F_2 \in ADM[A_2]$ . It suffices to prove that  $F \in \mathcal{F}_\Sigma^c$  since  $F \in CF$ . Let  $X \rightarrow x \in \Sigma$  and  $X \subseteq \bar{F}$ , and since  $\Sigma_{A_1}$  and  $\Sigma_{A_2}$  is a partition of  $\Sigma$ , we suppose that  $X \rightarrow x \in \Sigma_{A_1}$ . Since  $F_1 \in ADM[A_1]$  and  $X \subseteq \bar{F}_1$ , then  $\bar{F}_1 \in \mathcal{F}_{\Sigma_{A_1}}$ , and thus  $x \in \bar{F}_1$ . Therefore,  $x \in F_1$  and  $x \notin F$ . We conclude that  $x \in \bar{F}$  which shows that  $\bar{F} \in \mathcal{F}_\Sigma$  and thus  $F \in ADM$ .  $\square$

Now, we describe an algorithm to enumerate the admissible sets of an argumentation having a  $\Sigma$ -partition  $\{A_1, A_2\}$  as follows: first we enumerate the admissible sets of  $ADM[A_2]$  (According to Theorem 4.7,  $ADM[A_2]$  corresponds to  $F_1 = \emptyset$ ). Then, for each non-empty admissible sets  $F_1 \in ADM[A_1]$  and  $F_2 \in ADM[A_2]$  output  $F_1 \cup F_2$  only if  $F_1 \cup F_2 \in CF$ .

**Theorem 4.8.** *Let  $AF = \langle \mathcal{A}, \mathcal{R} \rangle$  be an argumentation framework and  $\{A_1, A_2\}$  a  $\Sigma$ -partition of  $\mathcal{A}$ . If there are polynomial delay and polynomial space algorithms to enumerate  $ADM[A_1]$  and  $ADM[A_2]$ , then there is an incremental polynomial time and polynomial space algorithm to enumerate all admissible sets of  $AF$ .*

**Proof:** We first enumerate the admissible sets of  $\Sigma_{A_2}$  corresponding to  $F_1 = \emptyset$  in polynomial delay. Now, we enumerate  $ADM[A_1]$  in polynomial delay, and for each  $F_1 \in ADM[A_1]$  such that  $F_1 \neq \emptyset$ , we re-executed the algorithm to enumerate all admissible sets in  $ADM[A_2]$ . For each  $F_2 \in ADM[A_2]$  we check if  $F_1 \cup F_2 \in CF$ . So the total time spent for each  $F_1 \in ADM[A_1]$  is bounded by a polynomial in the size of  $ADM[A_2]$  which is less than the number of admissible sets already outputted. It is worth noticing that  $F_1$  will be outputted since  $\emptyset \in ADM[A_2]$ , i.e. the output is increasing.

Since the algorithms to enumerate  $ADM[A_1]$  and  $ADM[A_2]$  use polynomial space, the proposed algorithm do not use extra space.  $\square$

The strategy described before does not lead to a polynomial delay and space algorithm to enumerate all admissible sets of such argumentation framework. Indeed, for each admissible set of  $\Sigma_{A_1}$ , we enumerate all admissible sets of  $\Sigma_{A_2}$ , while many of them fail to be conflict-free. Note that a subset of arguments  $S \subseteq \mathcal{A}$  is said to be an admissible set of  $\Sigma$  if and only if  $S$  is conflict-free in  $AF$  and  $\bar{S}$  is a closed set of  $\Sigma$ . In the following, we describe a strategy similar to the one given by Kröll et al. (2017) to enumerate admissible sets of bipartite argumentation frameworks.

Let  $F_1 \in ADM[A_1]$ . We denote by  $M(F_1) = \{x \in A_2 \mid \text{for all } y \in F_1, \{x, y\} \in CF\}$  the subset of  $A_2$  containing all arguments that have no conflict with  $F_1$ . It is easy to observe that  $M$  is a conflict-free set whenever  $A_2$  is. But, in general the set is not conflict-free as illustrated by the following example.

**Example 9.** *Continuing with Example 8. Consider  $F_1 = \emptyset \in ADM[A_1]$ . Then  $M(\emptyset) = A_2$  which is not conflict-free as  $(7, 8) \in \mathcal{R}$ .*

We denote by  $\Sigma(F_1) = \{M(F_1) \cap X \rightarrow x \mid X \rightarrow x \in \Sigma_{A_2} \text{ and } x \in M(F_1)\}$  the projection of the implicational system  $\Sigma_{A_2}$  over the set  $M(F_1)$ .

**Proposition 3.** *Let  $F_1 \in ADM[A_1]$  and  $F_2 \subseteq M(F_1)$ . Then,  $F_1 \cup F_2 \in ADM$  if and only if  $F_2$  is an admissible set of  $\Sigma(F_1)$ .*

**Proof:** Let  $F_1 \in ADM[A_1]$  and  $F_2 \subseteq M(F_1)$ . Suppose that  $F_1 \cup F_2 \in ADM$ . Since  $F_2 \in CF$ , it suffices to show that  $M(F_1) \setminus F_2$  is closed by  $\Sigma(F_1)$ . Let  $X \rightarrow x \in \Sigma(F_1)$  such that  $X \subseteq M(F_1) \setminus F_2$ . By construction of  $\Sigma(F_1)$  there exists an implication  $Y \rightarrow x \in \Sigma_{A_2}$  such that  $X = Y \cap M(F_1)$ . Since  $Y \subseteq A_2$ , we have  $Y \subseteq A_2 \setminus F_2$  and thus  $x \in A_2 \setminus F_2$ . Moreover by construction of  $\Sigma(F_1)$ ,  $x \in M(F_1)$  and thus  $x \in M(F_1) \setminus F_2$ . Hence,  $F_2$  is closed by  $\Sigma(F_1)$ .

Conversely, suppose that  $F_2$  is an admissible set of  $\Sigma(F_1)$ . Then  $F_2 \in CF$ , and by construction of  $M(F_1)$ , we have  $F_1 \cup F_2 \in CF$ . According to Theorem 4.7, it suffices to show that  $F_2 \in ADM[A_2]$ . We prove that  $A_2 \setminus F_2$  is closed by  $\Sigma_{A_2}$ . Let  $Y \rightarrow x \in \Sigma_{A_2}$  such that  $Y \subseteq A_2 \setminus F_2$ . As  $F_2 \subseteq M(F_1) \subseteq A_2$ , then  $X = Y \cap M(F_1) \subseteq M(F_1) \setminus F_2$  and by construction of  $\Sigma(F_1)$ ,  $X \cap M(F_1) \rightarrow x \in \Sigma(F_1)$ . Since  $M(F_1) \setminus F_2$  is closed by  $\Sigma(F_1)$ , we have  $x \in M(F_1) \setminus F_2$ . Therefore,  $x \in A_2 \setminus F_2$  which shows that  $A_2 \setminus F_2$  is closed by  $\Sigma_{A_2}$ . We conclude that  $F_2 \in ADM[A_2]$  since  $F_2 \in CF$ .  $\square$

According to Proposition 3, if the admissible sets of  $\Sigma(F_1)$  can be enumerated in polynomial delay and space for every admissible set  $F_1 \in ADM[A_1]$ , then there is a polynomial delay and space algorithm to enumerate all admissible sets of  $\Sigma$ . In the following, we consider cases for which the enumeration of admissible sets can be done in polynomial delay and space.

In the rest of this section, we consider the case, where  $A_2$  is a conflict-free set. We show that  $ADM$  can be obtained by copy of intervals of  $ADM[A_2]$ .

**Proposition 4.** *Dunne et al. (2013) Let  $F_1 \in ADM[A_1]$  such that  $M(F_1)$  is conflict-free. Then, there exists a unique maximal admissible set  $F_2^*$  of  $\Sigma(F_1)$ , and for any  $F_2$  such that  $M(F_1) \setminus F_2$  is closed by  $\Sigma(F_1)$ , we have  $F_1 \cup F_2 \in ADM$ .*

**Proof:** Let  $F_1 \in ADM[A_1]$  such that  $M(F_1)$  is conflict-free. We first show that  $M(F_1)$  contains a unique maximal admissible set  $F_2^*$  of  $\Sigma(F_1)$ . Since  $M(F_1)$  is conflict-free, we only show that  $M(F_1) \setminus F_2^*$  is the minimal closed set of  $\Sigma(F_1)$ . Clearly, the smallest closed set corresponds to  $\emptyset^{\Sigma(F_1)}$  and, thus,  $F_2^* = M(F_1) \setminus \emptyset^{\Sigma(F_1)}$  is the maximal admissible set.

Now let  $F_2$  such that  $M(F_1) \setminus F_2$  is closed by  $\Sigma(F_1)$ . Since  $F_2 \subseteq M(F_1)$ , then  $F_2$  is conflict-free and hence  $F_2$  is an admissible set of  $\Sigma(F_1)$ . Using Proposition 3, we deduce that  $F_1 \cup F_2 \in ADM$ .  $\square$

Let  $F_1 \in ADM[A_1]$  and  $F_2^*$  be the maximal admissible set of  $\Sigma(F_1)$  such that  $F_1 \cup F_2^* \in ADM$  (see Proposition 4). We denote by  $[F_1, F_1 \cup F_2^*]$  the set of all admissible sets of  $\Sigma(F_1)$  augmented by  $F_1$ . The following theorem shows that the set  $ADM$  can be obtained from  $ADM[A_2]$  by duplication of intervals.

**Theorem 4.9.** *Let  $AF = \langle \mathcal{A}, \mathcal{R} \rangle$  be an argumentation framework and  $\{A_1, A_2\}$  a  $\Sigma$ -partition of  $\mathcal{A}$  such that  $A_2$  is conflict-free. Then  $ADM = \bigcup_{F_1 \in ADM[A_1]} [F_1, F_1 \cup F_2^*]$  where  $F_2^*$  is the maximal admissible set of  $\Sigma(F_1)$ .*

**Proof:** Clearly for any  $F_1 \in ADM[A_1]$  we have  $[F_1, F_1 \cup F_2^*] \subseteq ADM$ . So it suffices to show that any  $F \in ADM$  that contains exactly  $F_1$  (i.e.  $F \cap A_1 = F_1$ ) belongs to  $[F_1, F_1 \cup F_2^*]$ . Let  $F \in ADM$  such that  $F \cap A_1 = F_1$  and  $F \cap A_2 = F_2$ . Then, by Theorem 4.7, we have  $F_1 \in ADM[A_1]$  and  $F_2 \in ADM[A_2]$ . Since  $F$  is conflict-free, then  $F_2 \subseteq M(F_1) \subseteq A_2$ . By the hypothesis,  $A_2$  is conflict-free and thus  $M(F_1)$  is conflict-free. Using Proposition 4, there is a unique maximal admissible set  $F_2^* \subseteq M(F_1)$  such that  $F_1 \cup F_2^* \in ADM$ . So  $F_2 \subseteq F_2^*$  and, hence,  $F \in [F_1, F_1 \cup F_2^*]$ .  $\square$

Following Theorem 4.9, the enumeration of admissible sets for an argumentation having a  $\Sigma$ -partition  $\{A_1, A_2\}$  with  $A_2$  a conflict-free set, works as follows: for each  $F_1 \in ADM[A_1]$ , compute its corresponding maximal admissible set  $F_2^* \in ADM[A_2]$ . Then, output all  $F_1 \cup F_2$ , where  $F_2 \in [\emptyset, F_2^*]$ .

**Theorem 4.10.** *Let  $AF = \langle \mathcal{A}, \mathcal{R} \rangle$  be an argumentation framework and  $\{A_1, A_2\}$  a partition of  $\mathcal{A}$ . If  $A_2$  is a conflict-free set and there is a polynomial delay and space algorithm to enumerate admissible sets in  $ADM[A_1]$ , then there is one to enumerate  $ADM$  in polynomial delay and space.*

**Proof:** Suppose we have a polynomial delay and space algorithm to enumerate the set of admissible sets  $ADM[A_1]$ . So, for each outputted  $F_1 \in ADM[A_1]$ , we use the algorithm in Ganter (2010) to enumerate in polynomial delay all closed sets of  $\Sigma(F_1)$ . And for any closed set  $F$  of  $\Sigma(F_1)$ , we output  $F_1 \cup (M(F_1) \setminus F)$ . So, the time spent between two admissible sets is bounded by a polynomial without extra space.

The correction of the proposed algorithm follows from Proposition 4 and Theorem 4.9. Indeed, since  $A_2$  is conflict-free, any  $F_1 \cup (M(F_1) \setminus F)$  outputted by the algorithm is conflict-free and, by Proposition 4, is an admissible set. Moreover any admissible set is outputted, since by Theorem 4.9 any admissible set  $F$  containing exactly  $F_1$ , we have  $F \cap A_2$  an admissible set of  $\Sigma(F_1)$ .  $\square$

As a consequence, we obtain a polynomial delay and space algorithm to enumerate admissible sets of a bipartite argumentation framework, which improve the space complexity of Kröll et al. (2017).

**Corollary 1.** *There is a polynomial delay and space algorithm to enumerate admissible extensions of a bipartite argumentation framework.*

## 5 Conclusion

In this paper, we have characterized the set of self-defending sets of an argumentation framework by closed sets of an implicational system. Furthermore, we have shown how to associate to any implicational system  $\Sigma$  an argumentation framework while its admissible sets are exactly the complement of closed sets of  $\Sigma$ . We have also shown that the enumeration of admissible sets is equivalent to the enumeration of closed sets that are also vertex covers of the attack graph. Then we have proposed a conflict-closed sets reduction rules to reduces the number of closed sets where their complements have a conflict that leads us to enumerate the set of admissible sets in polynomial delay whenever  $\mathcal{F}_\Sigma^c = ADM$ . Inspired by the work in Kröll et al. (2017) for bipartite attack graphs, we have developed a general decomposition approach for the enumeration of admissible sets.

For future work, we are interested in characterizing argumentation framework for which the set of admissible sets can be enumerated in polynomial delay. For example, if the indegree of the attack graph is bounded by 1, then the implicational system is unit and thus the lattice is distributive.

## Acknowledgements

The second author is supported by the French government IDEX ISITE initiative 16-IDEX-0001 (CAP 20-25).

## References

- P. Baroni, M. Caminada, and M. Giacomin. An introduction to argumentation semantics. *Knowledge Engineering Review*, 26(4):365, 2011.
- T. J. Bench-Capon and P. E. Dunne. Argumentation in artificial intelligence. *Artificial Intelligence*, 171(10-15):619–641, 2007.
- K. Bertet, C. Demko, J.-F. Viaud, and C. Guérin. Lattices, closures systems and implication bases: A survey of structural aspects and algorithms. *Theoretical Computer Science*, 743:93–109, 2018.
- S. Bistarelli, F. Rossi, and F. Santini. A comparative test on the enumeration of extensions in abstract argumentation. *Fundamenta Informaticae*, 140(3-4):263–278, 2015.
- A. Bondarenko, P. M. Dung, R. A. Kowalski, and F. Toni. An abstract, argumentation-theoretic approach to default reasoning. *Artificial Intelligence*, 93(1-2):63–101, 1997.
- M. Caminada and L. Amgoud. On the evaluation of argumentation formalisms. *Artificial Intelligence*, 171(5-6):286–310, 2007.
- F. Cerutti, M. Giacomin, and M. Vallati. Algorithm selection for preferred extensions enumeration. In *Computational Models of Argument: Proceedings of COMMA 2014*, pages 221–232. IOS Press, 2014.
- F. Cerutti, M. Vallati, and M. Giacomin. On the impact of configuration on abstract argumentation automated reasoning. *International Journal of Approximate Reasoning*, 92:120–138, 2018.
- G. Charwat, W. Dvořák, S. A. Gaggl, J. P. Wallner, and S. Woltran. Methods for solving reasoning problems in abstract argumentation—a survey. *Artificial Intelligence*, 220:28–63, 2015.
- S. Coste-Marquis, C. Devred, and P. Marquis. Symmetric argumentation frameworks. In *European Conference on Symbolic and Quantitative Approaches to Reasoning and Uncertainty*, pages 317–328. Springer, 2005.
- B. A. Davey and H. A. Priestley. *Introduction to lattices and order*. Cambridge University Press, 2002.
- Y. Dimopoulos and A. Torres. Graph theoretical structures in logic programs and default theories. *Theoretical Computer Science*, 170(1-2):209–244, 1996.
- P. M. Dung. On the acceptability of arguments and its fundamental role in nonmonotonic reasoning, logic programming and n-person games. *Artificial Intelligence*, 77(2):321–357, 1995.

- P. E. Dunne. Computational properties of argument systems satisfying graph-theoretic constraints. *Artificial Intelligence*, 171(10-15):701–729, 2007.
- P. E. Dunne and T. J. Bench-Capon. Complexity and combinatorial properties of argument systems. *University of Liverpool, Department of Computer Science (ULCS), Technical report*, 2001.
- P. E. Dunne, W. Dvořák, and S. Woltran. Parametric properties of ideal semantics. *Artificial Intelligence*, 202:1–28, 2013.
- P. E. Dunne, W. Dvořák, T. Linsbichler, and S. Woltran. Characteristics of multiple viewpoints in abstract argumentation. *Artificial Intelligence*, 228:153–178, 2015.
- W. Dvořák and P. E. Dunne. Computational problems in formal argumentation and their complexity. *Journal of Logics and their Applications*, 4(8):2557–2622, 2017.
- S. A. Gaggl, T. Linsbichler, M. Maratea, and S. Woltran. Design and results of the second international competition on computational models of argumentation. *Artificial Intelligence*, 279:103193, 2020.
- B. Ganter. Two basic algorithms in concept analysis. In *International conference on formal concept analysis*, pages 312–340. Springer, 2010.
- G. Grätzer. *Lattice theory: foundation*. Springer Science & Business Media, 2011.
- D. S. Johnson, M. Yannakakis, and C. H. Papadimitriou. On generating all maximal independent sets. *Information Processing Letters*, 27(3):119–123, 1988.
- M. Kröll, R. Pichler, and S. Woltran. On the complexity of enumerating the extensions of abstract argumentation frameworks. In *Proceedings of the 26th International Joint Conference on Artificial Intelligence*, pages 1145–1152. AAAI Press, 2017.
- V. Neumann-Lara. Seminúcleos de una digráfica. *Anales del Instituto de Matemáticas*, 2, 1971.
- S. Nofal, K. Atkinson, and P. E. Dunne. Algorithms for decision problems in argument systems under preferred semantics. *Artificial Intelligence*, 207:23–51, 2014.
- I. Rahwan and G. R. Simari. *Argumentation in artificial intelligence*, volume 47. Springer, 2009.
- J. Von Neumann and O. Morgenstern. *Theory of games and economic behavior (commemorative edition)*. Princeton university press, 2007.
- M. Wild. The joy of implications, aka pure horn formulas: mainly a survey. *Theoretical Computer Science*, 658:264–292, 2017.