



HAL
open science

An original experimental method for measuring friction coefficient during tribofilm formation by accumulating free sliding oscillating responses

Amal Hriouech, Joël Perret-Liaudet, Maria-Isabel De Barros Bouchet, Michel Belin, Pierre Charles

► To cite this version:

Amal Hriouech, Joël Perret-Liaudet, Maria-Isabel De Barros Bouchet, Michel Belin, Pierre Charles. An original experimental method for measuring friction coefficient during tribofilm formation by accumulating free sliding oscillating responses. 2021. hal-03180360

HAL Id: hal-03180360

<https://hal.science/hal-03180360>

Preprint submitted on 25 Mar 2021

HAL is a multi-disciplinary open access archive for the deposit and dissemination of scientific research documents, whether they are published or not. The documents may come from teaching and research institutions in France or abroad, or from public or private research centers.

L'archive ouverte pluridisciplinaire **HAL**, est destinée au dépôt et à la diffusion de documents scientifiques de niveau recherche, publiés ou non, émanant des établissements d'enseignement et de recherche français ou étrangers, des laboratoires publics ou privés.

An original experimental method for measuring friction coefficient during tribofilm formation by accumulating free sliding oscillating responses

Amal Hriouech^{a,b,*}, Joël Perret-Liaudet^{a,*}, Maria-Isabel De Barros Bouchet^a, Michel Belin^a and Pierre Charles^b

^aUniv Lyon, École centrale de Lyon, Laboratoire de Tribologie et Dynamique des Systèmes, LTDS UMR 5513, ECL, ENISE, ENTPE, CNRS, F-69134, Écully, France

^bPSA, Centre Technique de Vélizy, F-78140, Vélizy, France

ARTICLE INFO

Keywords:
measurement
friction
dynamic
lubricant additive

Abstract

A new experimental approach is proposed to investigate the friction behaviour and highlight the relationship with the tribofilm formation. It is based on the accumulation of several free dynamic responses of a single-degree-of-freedom damped oscillating system on the same sliding surfaces. By analysing the decreasing amplitude of the damped free dynamic responses and their associated energy decays, it is not only possible to describe the evolution of the tribological behaviour, but also to accurately identify velocity-dependent and velocity-independent friction contributions as the gradually formation of tribofilm. To demonstrate the relevance of this original technique, two tribosystems were studied, each lubricated with either base oil or formulated one, and by comparing the results with those obtained by a conventional linear tribometer.

1. Introduction

Friction is a complex phenomenon that occurs in many daily and industrial applications. It can represent an advantage or a drawback, depending on the domain. Nevertheless, a controlled friction is undoubtedly one of the ultimate goals of modern technology. Lowering friction/wear of tribological systems are among the current challenges for many industries: internal combustion engines, transmission systems, bearings, *etc.*

In order to reduce friction in mechanical systems that operate under extreme conditions, there are several parameters that can be considered. We can mention without being exhaustive, contact pressure, surface finishing, lubrication with the use of formulated lubricants. In literature, it is shown the great interest of chemical additives added to the lubricant base oil. In fact, additives react with surfaces and produce a tribochemical film that facilitates the sliding of the surfaces in contact by reducing friction and wear [1–4]. This tribochemical film is simply called tribofilm. Up to now, there has been much more emphasis by researchers on tribofilm formation, kinetics of their creation and removal, their characteristics and the factors that affect them. To achieve optimal tribological performance, it is also important to investigate the evolution of the induced friction coefficient during tribofilm formation.

Currently, the conventional tribometers, mainly linear or rotative, evaluate the friction and its evolution by a continuous measurement of the tangential force during tribofilm formation. The friction coefficient is generally defined as the ratio of the mean measured tangential force to the mean nor-

mal force measured through force transducers. Nevertheless, it is difficult to obtain accurate measurements of the friction when the shear strength at interface regions becomes very low, because of the force transducers limited precision [5, 6]. Moreover, this classical approach yields an overall value of the friction coefficient without giving any information about the dependence of tribological behaviour with velocity and acceleration from a single experiment.

Otherwise, an original experimental device has been developed at our LTDS Lab. which is called the dynamic oscillating tribometer (or the oscillating relaxation tribometer). It is dedicated to quantify the friction into different contributions without measuring any tangential force and with high accuracy, especially in the case of low friction [7, 8]. This original apparatus is also described by its ability to access certain nonlinear properties of the dissipative friction force, which, in some cases, are neither purely viscous nor purely velocity-independent. It is based on the analysis of the dynamic free response of a single degree-of-freedom mechanical oscillator and the friction characteristics are deduced from the energy decay induced by friction damping. The smaller the damping, the larger the number of oscillations and therefore the more accurate the estimation of the friction coefficient value.

So, to overcome the limitations of the conventional tribometer, we suggest an original method to evaluate friction behaviour during the tribofilm formation based on LTDS's dynamic oscillating tribometer. This latter allows very quick measurements, typically, of a duration of few seconds. This duration is not sufficient to activate the lubricant additives to form a tribofilm. So we propose to accumulate several repetitive free responses on the same friction track in order to allow additives reacting and forming the tribofilm gradually.

*Corresponding authors

✉ hriouech.amal@gmail.com (A. Hriouech);
joel.perret-liaudet@ec-lyon.fr (J. Perret-Liaudet)

In this context, the main objective of this paper is to show that we are able to follow the evolution of the friction behaviour of tribosystems over time. Also, we reveal that friction behaviour can be characterized in a robust and accurate way as well as highlighting the impact of lubricating additives. The paper is organized as follows. In section 2, description of the experimental apparatus and friction parameters identification are presented. In section 3, details of the proposed method are described. In section 4, experimental tests with a lubricated tribological system corresponding to steel surfaces are investigated to show the efficiency of the proposed method. Concluding and remarks are discussed in section 5.

2. Experimental set-up and theoretical analysis

As suggested in the introduction, the proposed experimental method is based on the use of a previously introduced dynamic oscillating tribometer, described in the following subsection.

2.1. The dynamic oscillating tribometer

The dynamic oscillating tribometer consists in a purely sliding contact between a spherical pin and a flat surface. Fig. 1 represents the mechanical system. The spherical pin is clamped to a moving mass attached to the extremity of steel bi-cantilever beams. The spherical pin oscillates horizontally from 1 mm out-of-equilibrium initial position imposed by an electromagnet. In other words, the electromagnet is used to initiate the motion and when it is deactivated, the spherical pin oscillates freely on the horizontal plane. Oscillations amplitude decreases until the stop induced by energy dissipation generated by the friction forces. The moving mass is weighted 0.034 kg, and the bi-cantilever beams stiffness is estimated 864 N m^{-1} leading to a natural frequency f_0 equal to 25.4 Hz. With the initial displacement equal to $X = 1 \text{ mm}$, the initial velocity is null when the oscillator is released and the maximum value of velocity reaches $V_{max} = 2\pi f_0 X = 159 \text{ mm s}^{-1}$. The material used and the linkages between mechanical parts are selected to minimize the internal damping of the system. This damping was measured without contact neither nor lubricant meniscus [8]. For this study, its damping ratio is verified to be equal to 0.0013.

The normal load is applied from micrometric vertical relative displacement of the plane and remains constant during the oscillatory test. Vertical displacement can be ranging from 0 to 0.5 mm allowing variation of the applied normal load from 0 to 0.5 N. Particular attention was paid during the design of the device to ensure the parallelism between the spherical pin motion and the flat, and to minimize the variation of the normal load.

The oscillating dynamic response is identified using a laser vibrometer Polytec OFV-5000 based on Doppler principle. It allows the measurement of the free response velocity with a resolution equal to $0.015 \mu\text{m s}^{-1}$. A photograph of the apparatus is shown in Fig. 2.

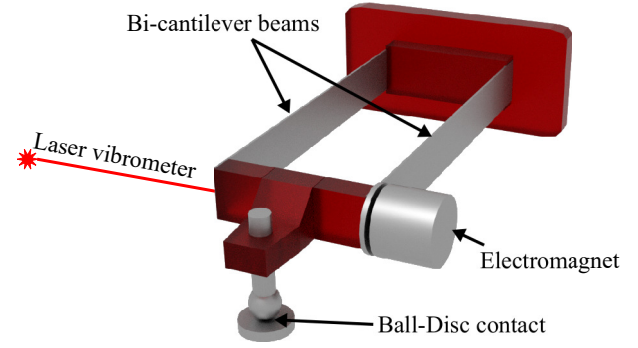

Fig. 1: Schematic of the dynamic oscillating tribometer.

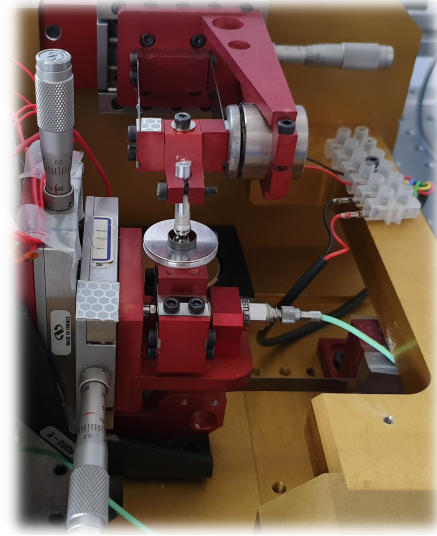

Fig. 2: Photograph of the dynamic oscillating tribometer.

2.2. Mechanical system and theoretical analysis

The mechanical system can be accurately modelled by a single-degree-of-freedom mass-spring system. As shown in Fig. 3, it consists of a mass m attached to a linear spring of stiffness k . The moving mass slides freely on a fixed rigid frame. A normal load N is applied to the contact interface resulting in a friction force T opposite to the motion. Conveniently, one can include internal damping on force T . The motion of the free oscillating system is then governed by the following equation:

$$m\ddot{x} + kx = -T \quad (1)$$

where x represents the displacement of the mass and \ddot{x} is the corresponding acceleration.

In sliding condition, the friction force T is proportional to the normal load N , via the kinetic friction coefficient μ :

$$T = \mu(\dot{x}) N \quad (2)$$

The friction coefficient μ is assumed to be as an odd function of the sliding velocity \dot{x} with:

$$\mu(-\dot{x}) = -\mu(\dot{x}) \quad (3)$$

According to the dissipative nature of friction, μ must satisfy:

$$\mu(\dot{x}) > 0, \quad \forall \dot{x} > 0 \quad (4)$$

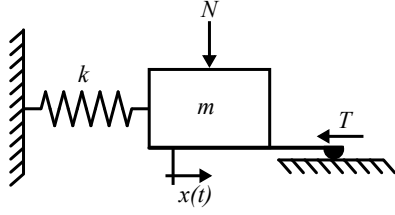

Fig. 3: Single-degree-of-freedom system.

In order to model μ , a pseudo-polynomial function is chosen and it is introduced as a power series of the sliding velocity \dot{x} , including the sign function [9]. Its general form is represented as follows:

$$\mu(\dot{x}) = (p_0 + p_2\dot{x}^2 + \dots) \operatorname{sgn}(\dot{x}) + (p_1\dot{x} + p_3\dot{x}^3 + \dots) \quad (5)$$

where the sign function, $\operatorname{sgn}(\dot{x})$, preserves the odd property of the friction coefficient. Remains that the kinetic friction coefficient μ takes not only the friction but also the internal damping of the system. By introducing the undamped natural frequency $\omega = \sqrt{\frac{k}{m}}$, Eq. (1) can be rewritten as the following final equation:

$$\ddot{x} + \omega^2 x = -\sigma \mu(\dot{x}) \quad (6)$$

where $\sigma = \frac{N}{m}$ is the reduced normal load.

2.3. Friction parameters identification from a single oscillating free response

In order to identify the kinetic friction parameters μ , modelled by Eq. (5), that is to say the coefficients p_j , we will consider the decaying envelope of the dynamic free response related to the energy dissipation due to friction.

In literature, different approaches are available for analysing the oscillating response [10–14], but the most common and most widely used are those based on the Krylov-Bogoliubov averaging method. We adopted this method for its significant accuracy [15, 16]. This method assumes that the displacement has the following form:

$$x(t) = A(t) \cos(\omega t + \phi(t)) = A \cos(\phi) \quad (7)$$

where $A(t)$ and $\phi(t)$ are the amplitude and the phase of the free response of the oscillator. The averaging method assumes slowly variation over time of $A(t)$ and $\phi(t)$ regards to the period $\frac{2\pi}{\omega}$. With this assumption and by averaging out the variations of ϕ over a period, the slow variations of $A(t)$ and $\phi(t)$ are governed by the following equations:

$$\dot{A} = \frac{\sigma}{2\pi\omega} \int_{-\pi}^{\pi} \sin \phi \mu(-A\omega \sin \phi) d\phi \quad (8a)$$

$$\dot{\phi} = \frac{\sigma}{2\pi\omega A} \int_{-\pi}^{\pi} \cos \phi \mu(-A\omega \sin \phi) d\phi \quad (8b)$$

After the integration process and taking into account the odd property of μ , Eq. (8) leads to:

$$\dot{A} = \frac{-\sigma}{\pi\omega} \sum_{j=0}^n [p_j \omega^j W_{j+1} A^j] = \sum_{j=0}^n a_j A^j \quad (9a)$$

$$\dot{\phi} = 0 \quad (9b)$$

where

$$W_{j+1} = \int_0^{\pi} \sin^{j+1} \phi d\phi \quad (10)$$

and

$$a_j = p_j \omega^j W_{j+1} \quad (11)$$

Following this process, the three first constants a_j are $a_0 = -2\sigma p_0 / \pi\omega$, $a_1 = -\sigma p_1 / 2$ and $a_2 = -4\omega\sigma p_2 / 3\pi$.

By considering the experimental data, the procedure of friction coefficient identification can be obtained from the successive steps: (i) measurement of the experimental envelope, $A_{\text{exp}}(t)$, obtained from the velocity free response, (ii) polynomial fitting $A_{\text{fit}}(t)$ to $A_{\text{exp}}(t)$, (iii) calculation of the time derivative $\dot{A}_{\text{fit}}(t)$, (iv) polynomial fitting $\dot{A}_{\text{fit}}(A_{\text{fit}})$, and finally (v) identification of coefficients a_j and p_j , and then friction coefficient given from Eq. (5). Finally, more details and general trends on the behaviour of the decreasing oscillations can be found in [9, 17].

2.4. Example

In order to illustrate the dynamic oscillating tribometer and apply the friction identification method, we present an experiment with a steel/steel contact lubricated by pure glycerol $\text{C}_3\text{H}_8\text{O}_3$. The experiment takes place at room temperature 25°C . A normal load of 50 mN was applied ensuring a mean contact pressure of 270 MPa.

The obtained experimental velocity response is displayed in Fig. 4a. The dynamic response shows a decaying envelope that is neither linear (Coulomb friction) nor exponential (viscous friction). The envelop starts with a convex form ($\dot{A} > 0$) and finishes with a concave form ($\dot{A} < 0$) until the oscillatory system reaches the equilibrium state. From this envelope, the friction coefficient has been identified using the theoretical analysis presented above.

Fig. 4b shows the evolution of the equivalent friction coefficient μ versus the velocity envelope. To accurately describe the response envelope form and then estimate the friction coefficient, a quadratic friction law is introduced. By taking into consideration this law, the identification of the friction parameters made it possible to find: $p_0 = 0.0731$, $p_1 = -0.1314$, $p_2 = 0.1131$. Practically, the convex part of the envelope corresponds to the increasing of friction with velocity, whereas the concave part corresponds to the decreasing of friction.

In the end, our dynamic oscillating tribometer allowed to analyse a large number of tribosystems, based on the identification technique presented here, or similar approaches [18–21].

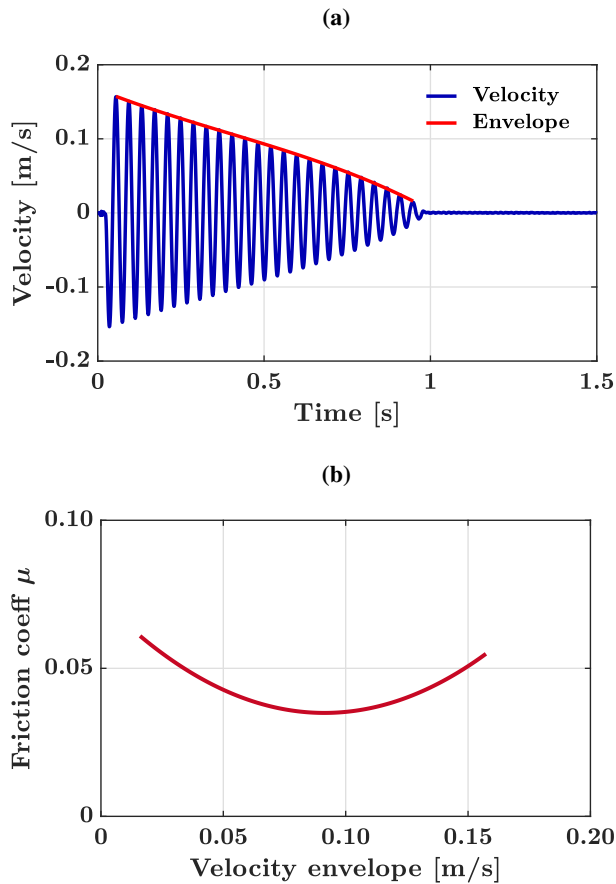

Fig. 4: (a) Velocity-time free response and (b) friction coefficient as a function of the amplitude of the envelope estimated by considering quadratic friction law with pure glycerol, normal load 50 mN, temperature 25 °C.

3. New experimental protocol for tribofilm formation

Based on the theoretical background reported in the above section and using the dynamic oscillating tribometer, we propose an original alternative way that allows to form tribofilm and to characterize the induced friction coefficient into different contributions. In order to form a tribofilm in a lubricated contact, it is necessary to ensure some operating conditions allowing the reactivity of lubricant with rubbing surfaces. In particular, a sufficient accumulated sliding distance is required. The dynamic oscillating tribometer allows very quick measurements of few seconds. During this quick measurement, the sliding distance is typically of 20 mm if 10 oscillations are observed before the extinction of the free dynamic response. So, one single test is insufficient to activate the lubricant components and form a tribofilm. Consequently, we propose to accumulate an appropriate number of repetitive free dynamic responses on the same friction track and without changing any operating condition. By this way, we accumulate sliding distance which is a prerequisite for activating the lubricant components, and consequently gradually forming a tribofilm.

Through experimental tests, we will demonstrate the ca-

pability of the suggested protocol to follow the evolution of the tribological response of the tribosystem, in particular the formation of the tribofilm over time, with a distance as long as necessary. In addition, we benefit the advantages of the oscillating tribometer to measure the low friction and distinguish the contribution independent of the sliding velocity from that depending on the sliding velocity as the tribofilm is formed.

4. Experimental results and discussion

4.1. The tribosystem under study

As we mentioned above, the experimental approach chosen for this study is to show the effectiveness of the new method in terms of the tribofilm formation and the assess of induced friction. Therefore, we performed experiments by adopting this latter approach and we compare with the results obtained in same conditions using a classical reciprocating linear tribometer [22]. This classical tribometer consists in a pure-sliding reciprocating motion between a ball and a flat plane. A photograph of the tribometer and a schematic representation of the contact are given in Fig. 5. The normal load is applied from a micrometric vertical displacement of the ball holder and remains constant during the friction test. The friction coefficient is deduced from the friction force generated between the ball and the disc during the test, which is measured by a piezoelectric force transducer placed against the heater block supporting the lower specimen holder. For this tribometer, an average friction coefficient for each sliding cycle was calculated from the instantaneous friction force measured during a cycle. This average coefficient is calculated without taking into account the values at turning-up points. For these experiments, the maximal amplitude of the sinusoidal sliding velocity is 9 mm s⁻¹ with 1 Hz for the frequency. The duration of tests is 3000 cycles and the length of the friction track is 2.9 mm. Under these operating conditions, the lubrication regime corresponds to a boundary/mixed regime.

For both tribometers, the experimental samples consist on a steel AISI 52100 spherical pin sliding on a steel AISI 52100 flat surface. Friction pairs had a mirror surface finish with arithmetic average roughness $R_a = 30$ nm (samples are supplied by bearings manufacturer and their roughness is checked in our laboratory). Before experiments, both the balls and flats were cleaned in ultrasonic heptane bath for 15 min to remove surface contamination. Two lubricants were used for this study to show the ability of tribometers to describe the tribofilm formation in the presence or not of additives. The first one is a base oil, with a viscosity of 6.6 cSt at 100 °C and 31.4 cSt at 40 °C. The second one is a fully-formulated oil, with viscosity of 8.3 cSt at 100 °C and 43.5 cSt at 40 °C. Values of viscosity for both lubricants are provided by the supplier. 80 μ L of each lubricant is added to lubricate the contact in each test. The temperature for all friction tests is maintained at 80 °C and 270 MPa initial average contact pressure is applied by adjusting the normal load. The viscosity of both lubricants at 80 °C is estimated by Walther's formula and is equal to 9.9 cSt for base oil and

12.8 cSt for formulated oil. Finally, each test was reproduced three times with the both tribometers, under strictly identical conditions. Good repeatability was always observed.

4.2. The classical tribometry results

To highlight the interest of the dynamic oscillating tribometry approach, we previously present in this section the friction behaviour of the investigated tribosystems obtained from the classical tribometer.

Fig. 6 shows the measured evolution of the friction coefficient versus the number of sliding cycles for base oil and fully formulated oil, performed with the linear tribometer. Starting from the graph, the evolution of the friction coefficient for both lubricants reveals two stages; the first one corresponds to the formation of the tribochemical film, and the second one to the maintenance of this film [23]. For base oil, the friction coefficient increases and then stabilizes at 0.15, whereas that of the fully-formulated decreases significantly and stabilizes quickly at a value of 0.04. The difference between these evolutions is related to the nature of the tribofilms formed by lubricants. The fully formulated oil contains additives that form a film on the contact surfaces by tribochemical reaction reducing the friction.

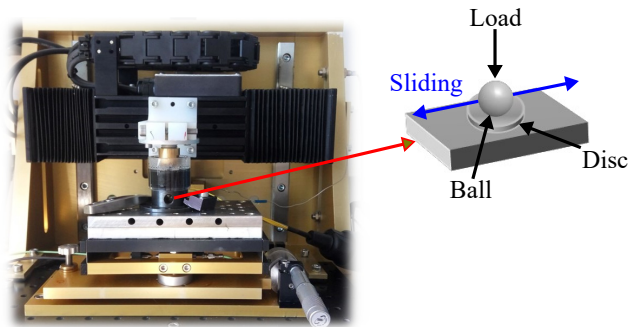

Fig. 5: Photograph of the linear tribometer and schematic of the contact.

This classical approach can describe the evolution of the friction coefficient in function of the sliding distance, but does not give any information about the dependence of tribological behaviour with velocity. For dynamic systems that change instantaneously the velocity, the dynamic tribometer combined with the new experimental protocol seems relevant to accurately describe friction behaviour and tribofilm formation.

4.3. Results of the proposed new method

Results presented in this subsection are obtained with the dynamic oscillating tribometer and by applying the new experimental protocol proposed in section 3.

All tests are carried out under the same operating conditions as for the linear tribometer. Each test results in many free dynamic velocity responses. A 1000 successive velocity free responses or runs for each test appear to be sufficient for ensuring the tribofilm formation as shown by the XPS analysis performed after the end of tests (Fig. 1 and 2, Supplementary material). The envelope of maximum velocity is

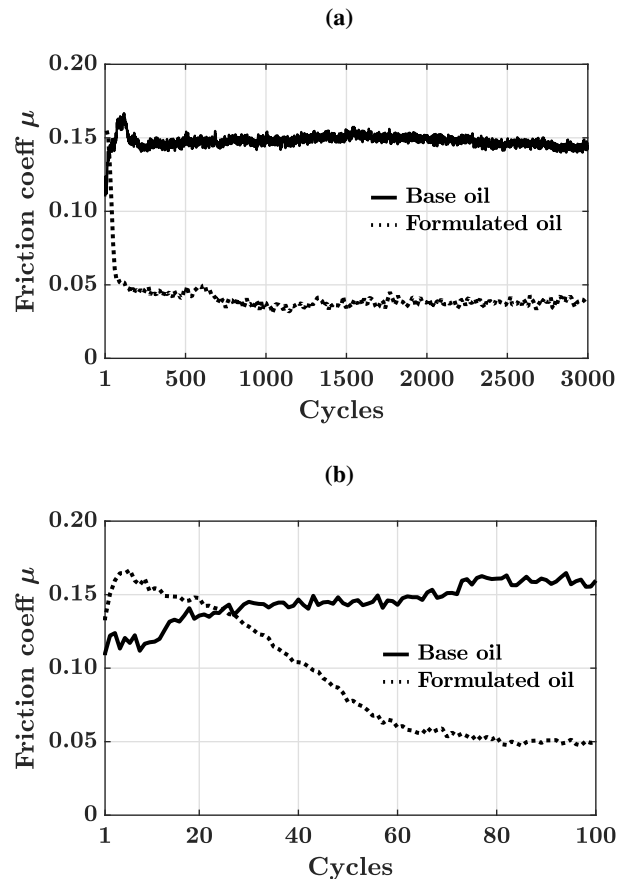

Fig. 6: Evolution of the friction coefficient as a function of cycles number for steel/steel contact lubricated with base and formulated oil, pressure 271 MPa, temperature 80 °C, (a) whole test, (b) zoom on the first 100 cycles.

extracted from each response in order to deduce the friction characteristics using the identification method presented in subsection 2.3. Order of pseudo polynomial laws used to model friction is verified afterwards and the quantification of friction contributions is established.

In the following, $\dot{x}_i(t)$ and μ_i will design velocity-time response and friction coefficient, respectively, with i representing the index of the i -th run or free response.

Fig. 7 displays the velocity free responses $\dot{x}_i(t)$ obtained with base oil for $i = 1, 50, 100, 200$ and 1000. Similar experiments have been carried out with formulated oil, as presented by Fig. 8. For both experiments, the measured natural frequency (25.4 Hz) does not vary with amplitude of the dynamic response which implies that the nonlinear characteristics of the system are related only to the friction forces.

Comparing Fig. 7 to Fig. 8, it is observed that the energy dissipation during tribotest lubricated with base oil is more significant than that lubricated with formulated oil; this can be easily seen from the number of oscillations. The oscillations observed before the signal extinction is found to be close to 7, so much lower than with formulated oil (33 for the 1000-th run). The higher the dissipation the lower the number of oscillations before equilibrium. We also notice,

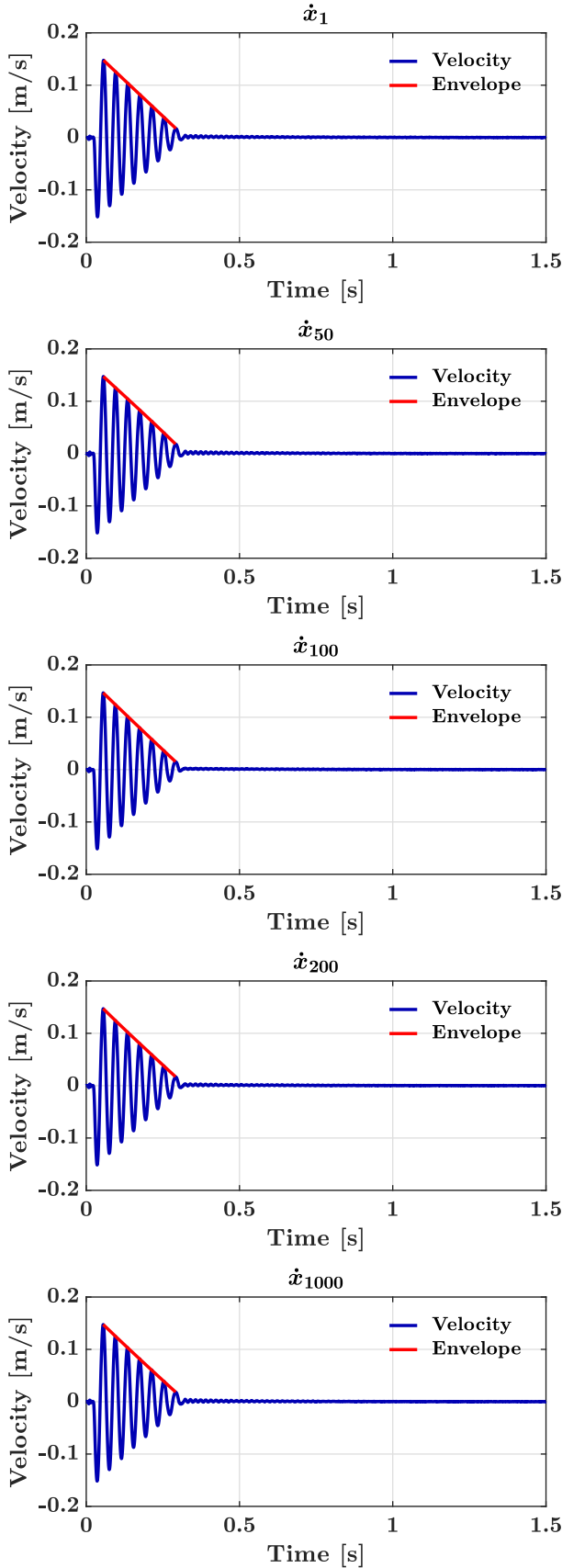

Fig. 7: Velocity free responses for steel/steel contact lubricated with base oil, pressure 271 MPa, temperature 80 °C for $i = 1, 50, 100, 200$ and 1000.

in the case of base oil lubrication, that whatever is the free response, the number of oscillations remains constant and the decaying envelope is a straight constant line. This indicates the absence of evolution of the interface material and that the energy dissipation is due to Coulomb type friction. This is coherent with the fact that the base oil does not tribochemically react on sliding surfaces so tribofilm formation does not occur and, therefore, the tribological behaviour remains invariant.

Unlike the contact lubricated with base oil, the number of oscillations of contact lubricated by formulated oil significantly increases with the accumulation of velocity free responses (see Fig. 8). It can be seen that this significant increase in the number of oscillations occurs rapidly after 50 runs. Therefore, we can conclude that the additives present in the oil react tribochemically quickly on steel surfaces reducing the friction and thus energy dissipation. Moreover, the shape of the envelope of velocity free responses shows a decay that is neither linear nor exponential. It means that velocity-dependent and velocity-independent friction contributions coexist in the contact.

In order to make these qualitative observations more explicit, friction coefficient is quantified. It is performed from each velocity free response envelope by considering a pseudo polynomial expansion (see Eq. (4)) at order 2, that is to say by considering the following law:

$$\mu_i(\dot{x}) = p_{0(i)} \text{sgn}(\dot{x}) + p_{1(i)} \dot{x} + p_{2(i)} \dot{x}^2 \text{sgn}(\dot{x}) \quad (12)$$

It is recalled that $p_{0(i)}$ corresponds to a velocity-independent contribution and $p_{1(i)}$ and $p_{2(i)}$ are the components of a velocity-dependent contribution.

Fig. 9 and Fig. 10 show the evolution of friction coefficient μ_i as a function of the velocity envelope for a representative set of velocity free responses \dot{x}_i (11 curves are presented out of 1000), for base and formulated oil respectively.

As expected, for contact lubricated by base oil, the friction coefficient is found to be almost constant, i.e., independent of velocity. Its magnitude is the same for all responses which confirms that there is no evolution of tribological behaviour of base oil. Furthermore, the friction values (around 0.15) obtained are in good agreement with that obtained with the linear tribometer.

Contrary to the case of oil base, the friction coefficient for the case of the contact lubricated by formulated oil is not only marked by a constant value independent of velocity envelope. More precisely, it is noticed that the slopes of the curves, $p_{1(i)}$, are closely the same for all the velocity free responses, with a negligible quadratic components $p_{2(i)}$ after $i = 20$. This indicates the presence of a viscous contribution. Further, the velocity-independent contribution $p_{0(i)}$ decreases with the accumulation of \dot{x}_i , for i lower than 100, to a stabilized value after $i = 100$. The progressive decrease of friction for the first 100 values of \dot{x}_i (shown in Fig. 10b) can be explained by the tribofilm formation. This latter is gradually formed during the first velocity free responses, resulting in a significant reduction of friction, attributed to

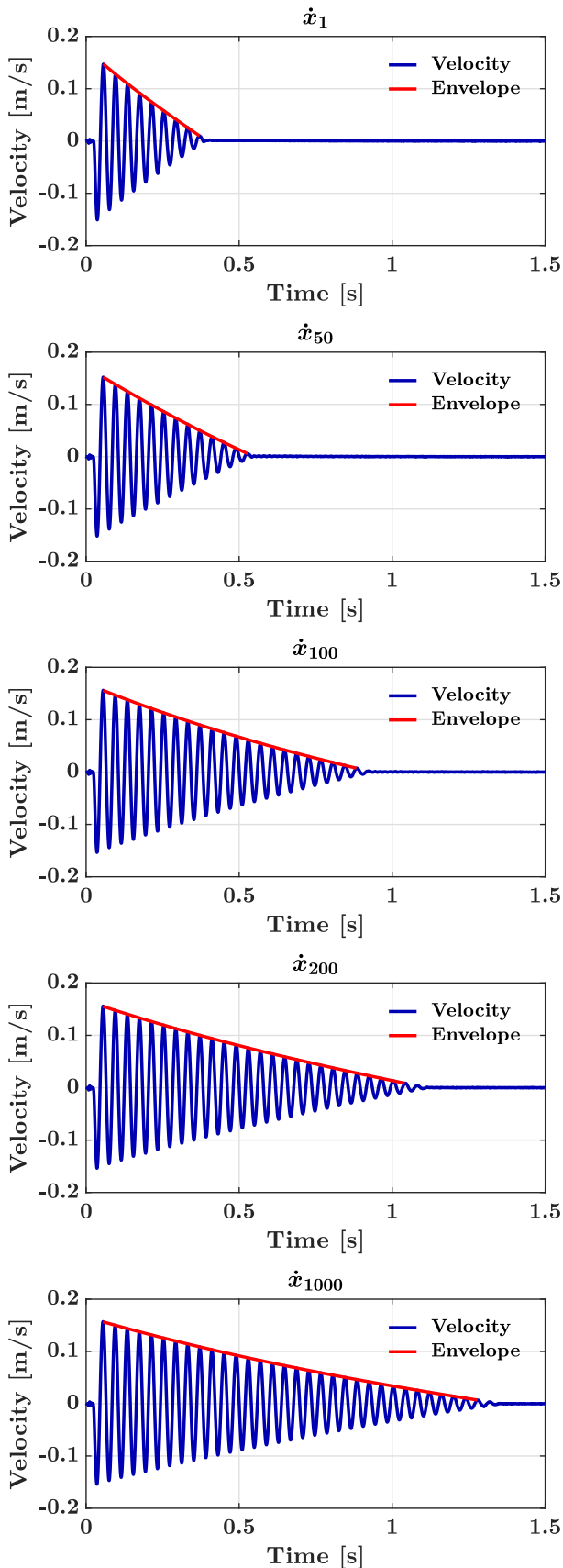

Fig. 8: Velocity free responses for steel/steel contact lubricated with formulated oil, pressure 271 MPa, temperature 80 °C for $i = 1, 50, 100, 200$ and 1000.

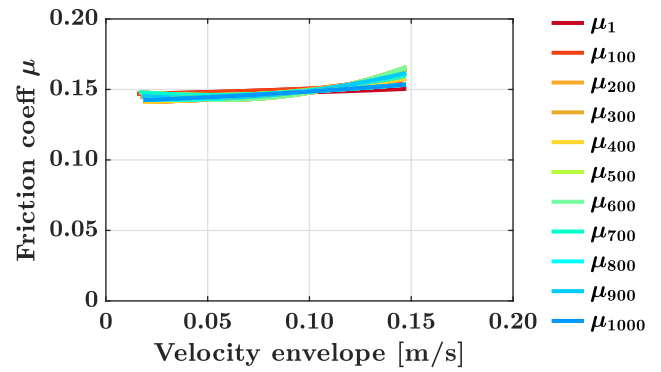

Fig. 9: Friction coefficient law of steel/steel contact lubricated with base oil, pressure 271 MPa, temperature 80 °C.

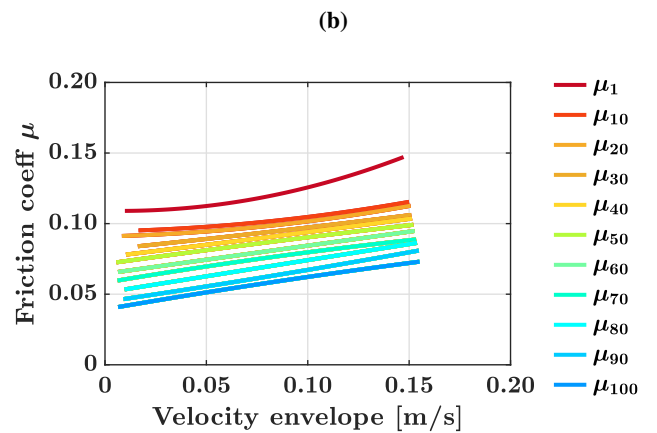
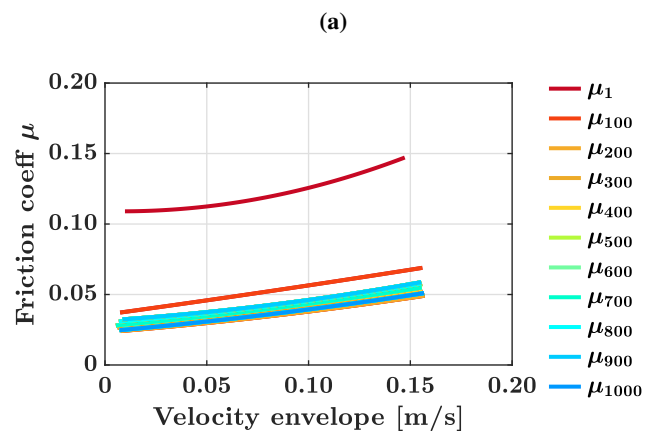

Fig. 10: Friction coefficient law of steel/steel contact lubricated with formulated oil, pressure 271 MPa, temperature 80 °C, (10a) whole test, (10b) zoom on the first 100 cycles.

the Coulomb type friction part. Comparing with the linear tribometer, we find that there is a good agreement in terms of friction values, but the kinetics of the tribofilm formation is different.

There are numerous factors that influence the kinetics of tribofilm formation, such as additives nature and quantity, contact temperature, velocity, pressure, etc. In the context of this study, the two tribometers are operating under the same

conditions, only their kinematics are different. This difference in kinematics may explain the difference of tribofilm formation kinetics. In order to compare these kinetics, one can estimate, for the both tribometric techniques, the accumulated distance slipped by the ball.

For the conventional reciprocating linear tribometer, the ball slips the same distance in each cycle (round trip). So, the total slipped distance d_{LT} is given by:

$$d_{LT} = 2N_T L \quad (13)$$

where N_T is the total number of cycles and L is the peak-to-peak amplitude of cycles that is equal the length of friction track.

For the dynamic oscillating tribometer, the distance slipped by the ball during a cycle decreases from the maximum amplitude $4X$ to zero. Remember that X is the initial displacement out of equilibrium. Assuming for the purpose of the estimate, a linear decaying amplitude response, a weighting of $1/2$ must be applied. Consequently, the total slipped distance d_{DT} can be getting close to:

$$d_{DT} \approx \frac{4X \sum_{j=1}^r n_j}{2} = 2X N_O \quad (14)$$

where r is the number of runs or individual velocity-time responses, n_j is the number of oscillations of the j -th velocity-time response and N_O is the total number of oscillations.

Using equations (13) and (14), the slipped distances can be compared. For the linear tribometer, if we consider that the tribofilm is completely formed at cycle number 100 (see Fig. 6b), the estimated slipped distance d_{TL} is around 0.6 m. For the dynamic oscillating tribometer, if we consider that it is completely formed after 100 free velocity responses (see Fig. 10) which corresponds to 1350 oscillations, we obtain for the estimated slipped distance d_{TD} a value close to 2.7 m. Therefore, the dynamic oscillating tribometer requires more slipped distance to form tribofilm.

However, by considering the frequencies of each tribometer, the time necessary to form tribofilm with the linear tribometer is of 100 seconds (100 cycles at 1 Hz) and for the dynamic oscillating tribometer, it is of 50 seconds (1350 cycles at around 25.4 Hz). So, although the distance slipped by the ball of the oscillating tribometer is greater than that of the linear tribometer, the experimental time of tribofilm formation is roughly equivalent for both tribometers.

4.4. Friction characteristics in the light of energy decay rates

In order to quantify velocity-independent and velocity-dependent friction contributions, a suitable way, possible with our proposed experimental technique, is to consider the energy decay rate of each free damped response related to the vibrational power being dissipated by friction. Indeed, the energy decay curve contains all the knowledge on damping properties, and then on friction characteristics.

Under the work-energy principle:

$$\Delta E|_{t_i}^{t_f} = W_f < 0 \quad (15)$$

where $E = \frac{1}{2}(kx^2 + m\dot{x}^2)$ is the total mechanical energy, $\Delta E|_{t_i}^{t_f}$ represents change in this energy between initial time t_i and final time $t_f > t_i$ and W_f is the net work done by friction (and residual damping) forces. By noting that the elastic potential energy $E_p = 0$ at every peak of the oscillating free velocity response, the dissipated net work W_f can be directly well estimated between two times $t_1 < t_2$ corresponding to two velocity peaks $V_1 > V_2$. The net work, represented by \hat{W}_f , is obtained as follows:

$$\hat{W}_f = \frac{1}{2}m(V_2^2 - V_1^2) < 0 \quad (16)$$

In addition, we introduce the same work done by friction forces, but evaluated by considering the retained friction law Eq. (12), represented now by \tilde{W}_f and given as follows:

$$\tilde{W}_f = -N \int_{t_1}^{t_2} (p_0 \text{sgn}(\dot{x}) \dot{x} + p_1 \dot{x}^2 + p_2 \text{sgn}(\dot{x}) \dot{x}^3) dt \quad (17)$$

Consequently, comparing measured \hat{W}_f to measured \tilde{W}_f which must be equal, allows to verify the relevance of the expansion order, here order 2, chosen to describe the pseudo-polynomial friction law. In addition, velocity-independent and velocity-dependent friction contributions can be simply quantified by splitting \tilde{W}_f as follows:

$$\tilde{W}_f = \tilde{W}_{\text{ind}} + \tilde{W}_{\text{dep}} \quad (18)$$

with

$$\tilde{W}_{\text{ind}} = -N \int_{t_1}^{t_2} p_0 \dot{x} \text{sgn}(\dot{x}) dt \quad (19)$$

$$\tilde{W}_{\text{dep}} = -N \int_{t_1}^{t_2} (p_1 \dot{x}^2 + p_2 \text{sgn}(\dot{x}) \dot{x}^3) dt \quad (20)$$

\tilde{W}_{ind} and \tilde{W}_{dep} represents velocity-independent and velocity-dependent friction contributions, respectively.

Considering complete oscillating responses from the initial time to the equilibrium ones, the total work achieved by friction has the same level as the initial elastic potential energy, that is to say the same value $\frac{1}{2}kX^2$. So, applying procedure on complete responses allows to discriminate the respective weight of the two contributions, certainly but without quantifying absolute levels. To avoid this lack of knowledge, it is better to measure work per single damped oscillation, that is:

$$\hat{W}_f^{(j)} = \frac{1}{2}m(V_{j+1}^2 - V_j^2) \quad (21)$$

where V_{j+1} and V_j are two successive velocity peak amplitudes respectively measured at times t_{j+1} and t_j . Similarly, we can measure

$$\tilde{W}_f^{(j)} = \tilde{W}_{\text{ind}}^{(j)} + \tilde{W}_{\text{dep}}^{(j)} \quad (22)$$

with:

$$\tilde{W}_{ind}^{(j)} = -N \int_{t_j}^{t_{j+1}} p_0 \dot{x} \text{sgn}(\dot{x}) dt \quad (23)$$

$$\tilde{W}_{dep}^{(j)} = -N \int_{t_j}^{t_{j+1}} p_1 \dot{x}^2 + p_2 \text{sgn}(\dot{x}) \dot{x}^3 dt \quad (24)$$

Of course, these quantities vary during the decaying oscillating responses. So, to follow friction contributions in relation with the tribofilm formation, we introduced mean values of works per oscillations for each complete damped oscillating responses. Finally, the associated averaged-per-oscillation dissipated energies, represented here by letter $\hat{\epsilon}_f$ and taken positive, can be expressed as follows:

$$\hat{\epsilon}_f = \frac{-\hat{W}_f}{2f_0(t_f - t_i)} = \frac{-m(V_f^2 - V_i^2)}{2f_0(t_f - t_i)} \quad (25)$$

$$\tilde{\epsilon}_{ind} = \frac{N \int_{t_i}^{t_f} p_0 \dot{x} \text{sgn}(\dot{x}) dt}{f_0(t_f - t_i)} \quad (26)$$

$$\tilde{\epsilon}_{dep} = \frac{N \int_{t_i}^{t_f} p_1 \dot{x}^2 + p_2 \text{sgn}(\dot{x}) \dot{x}^3 dt}{f_0(t_f - t_i)} \quad (27)$$

$$\tilde{\epsilon}_f = \tilde{\epsilon}_{ind} + \tilde{\epsilon}_{dep} \quad (28)$$

where V_i is the first peak velocity amplitude observed at time t_i , and V_f is the latest peak velocity amplitude observed at time t_f . Similarly, the relevance of the expansion order chosen for friction law Eq. (12) can be checked and contributions analysed.

Fig. 11 shows the evolution of $\hat{\epsilon}_f$, compared to $\tilde{\epsilon}_f$, and also the velocity-dependent contribution $\tilde{\epsilon}_{dep}$, as a function of accumulated oscillations obtained during the successive free responses. For both base and formulated oils, Fig. 11a and 11b respectively, $\hat{\epsilon}_f$ and $\tilde{\epsilon}_f$ are totally equal. This confirms that the order 2 of expansion of the law used to model friction, Eq. (12), is appropriate and accurately describe the dissipated energy of both tribotests. Regarding $\tilde{\epsilon}_{dep}$ almost null for base oil, we can conclude in this case that friction is essentially velocity-independent, like a Coulomb friction behaviour. In addition, we clearly confirm that there is no tribofilm formation and no change in the friction behaviour by accumulating oscillating responses. In contrast, we can see that $\tilde{\epsilon}_{dep}$ is mostly constant with a value of $5 \mu\text{J}$ for the formulated oil, revealing a velocity-dependent contribution similar to viscous frictional behaviour. We can also conclude that this contribution is not affected by the tribofilm formation. Indeed, the drastic change of the dissipated energy, from $45 \mu\text{J}$ to $15 \mu\text{J}$ is essentially due to the velocity-independent contribution reduction. In other words, $\tilde{\epsilon}_{ind}$ is reduced by 75% from its initial value when $\tilde{\epsilon}_{dep}$ remains constant. Finally, the benefit of tribofilm formation can be well observed and quantified by the proposed new experimental method. This is clear by comparing dissipated energies between oil base test with an almost constant $60 \mu\text{J}$ level and formulated oil with a stabilized $15 \mu\text{J}$ level.

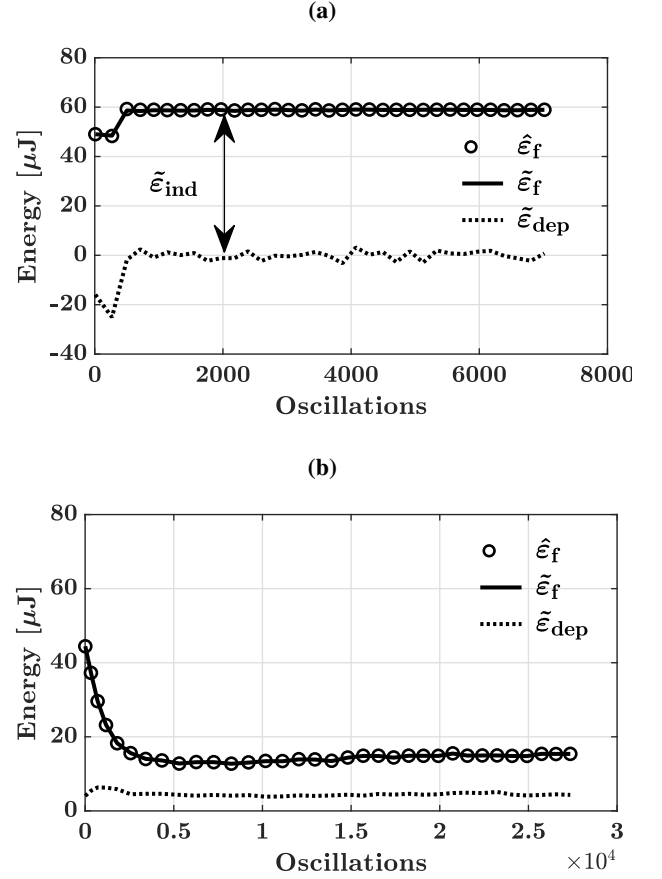

Fig. 11: Averaged-per-oscillation dissipated energies $\hat{\epsilon}_f$, $\tilde{\epsilon}_f$ and $\tilde{\epsilon}_{dep}$ as a function of accumulated oscillations; (a) steel/steel contact lubricated with base oil, (b) and with formulated oil; contact pressure 271 MPa, temperature 80 °C.

5. Conclusion

A new experimental approach is presented in this paper in order to generate tribofilm on sliding surfaces, while allowing original analysis of the friction force at any stage of its formation. The introduced technique is based on the following principles:

- Using an original previously designed oscillating dynamic tribometer, fast measurements of the friction force are realized without invasive transducer. One can notice that measurements remain very effective even for very low friction levels which is a major objective of the tribofilms formation.
- Moreover, by analysing the obtained free dynamic responses and the associated friction force, this oscillating tribometer is able to quantify the sliding velocity-dependent contributions of friction.
- Tribofilm formation is generated by performing repetitive runs of free dynamic responses on the same friction track without changing the tribological conditions.

To validate the proposed experimental approach, we realized a set of experiments using a sliding ball-plane contact lubricated with either base oil or formulated oil. By comparing the results with that obtained from a classical linear tribometer, a good consistency of the new technique is shown. In particular, we have demonstrated the ability of the innovative methodology proposed hereby to create tribofilms. It is important to note that this can be done at a same experimental duration with that necessary for classic experiments.

The ability to discriminate the contributions related to the dependency of friction behaviour on the instantaneous velocity appears to be a definite advantage of the introduced approach. Furthermore, these contributions can be clearly analysed in the light of energy dissipation leading to interpret the direct effect of tribofilm on consumption and so on.

Finally, by using the oscillating dynamic tribometer, we notice that the lower the dissipation forces, the higher the number of oscillations, and thus the more accurate the low friction measurement. Consequently, our innovative approach appears to be a very effective and suitable technique for future studies on the performance of new lubricant formulations in the perspective of green energies.

6. Acknowledgments

The author would like to thank Dr. Yassine El Assami for assistance and helpful discussions during the completion of this work and also Dr. Fida Majdoub for reading this manuscript.

7. Supplementary material

Supplementary material related to this article can be found in the online version.

References

- [1] H. A. Spikes, Film-forming additives - direct and indirect ways to reduce friction, *Lubrication Science* 14 (2002) 147–167.
- [2] M. De Barros, J. Bouchet, I. Raoult, T. Le Mogne, J. Martin, M. Kasrai, Y. Yamada, Friction reduction by metal sulfides in boundary lubrication studied by XPS and XANES analyses, *Wear* 254 (2003) 863–870.
- [3] J.-M. Martin, C. Grossiord, T. Le Mogne, J. Igarashi, Transfer films and friction under boundary lubrication, *Wear* 245 (2000) 107–115.
- [4] A. Morina, A. Neville, M. Priest, J. Green, ZDDP and MoDTC interactions and their effect on tribological performance – tribofilm characteristics and its evolution, *Tribology Letters* 24 (2006) 243–256.
- [5] D. L. Burris, W. G. Sawyer, Addressing Practical Challenges of Low Friction Coefficient Measurements, *Tribology Letters* 35 (2009) 17–23.
- [6] T. L. Schmitz, J. E. Action, J. C. Ziegert, and, W. G. Sawyer, The Difficulty of Measuring Low Friction: Uncertainty Analysis for Friction Coefficient Measurements, *Journal of Tribology* 127 (2005) 673–678.
- [7] E. Rigaud, J. Perret-Liaudet, M. Belin, L. Joly-Pottuz, J.-M. Martin, An original dynamic tribotest to discriminate friction and viscous damping, *Tribology International* 43 (2010) 320–329.
- [8] M. Belin, M. Kakizawa, E. Rigaud, J. M. Martin, Dual characterization of boundary friction thanks to the harmonic tribometer: Identification of viscous and solid friction contributions, *Journal of Physics: Conference Series* 258 (2010) 012008.
- [9] F. Majdoub, J. Perret-Liaudet, M. Belin, J. Martin, Decaying law for the free oscillating response with a pseudo-polynomial friction law: Analysis of a superlow lubricated friction test, *Journal of Sound and Vibration* 348 (2015) 263–281.
- [10] N. Levinson, A Second Order Differential Equation with Singular Solutions, *Annals of Mathematics* 50 (1949) 127–153.
- [11] W. S. Loud, Periodic Solutions of a Perturbed Autonomous System, *Annals of Mathematics* 70 (1959) 490–529.
- [12] R. E. Mickens, *Oscillations in Planar Dynamic Systems*, World Scientific, 1996.
- [13] B. Wu, H. Zhong, Summation of perturbation solutions to nonlinear oscillations, *Acta Mechanica* 154 (2002) 121–127.
- [14] C. Lim, B. Wu, A new analytical approach to the Duffing-harmonic oscillator, *Physics Letters A* 311 (2003) 365–373.
- [15] N. N. Bogoliubov, I. A. Mitropol'skii, J. A. Mitropol'skij, Y. A. Mitropolsky, *Asymptotic Methods in the Theory of Non-linear Oscillations*, CRC Press, 1961.
- [16] A. H. Nayfeh, D. T. Mook, *Nonlinear Oscillations*, John Wiley & Sons, 2008.
- [17] F. Majdoub, Innovative measurement of ultra-low friction - Analysis of dynamic free responses characterized by damped oscillatory motion, N° d'ordre : 2013-56, PhD Thesis (2013).
- [18] F. Majdoub, M. Belin, J. Martin, J. Perret-Liaudet, M. Kano, K. Yoshida, Exploring low friction of lubricated DLC coatings in no-wear conditions with a new relaxation tribometer, *Tribology International* 65 (2013) 278–285.
- [19] F. Majdoub, J. M. Martin, M. Belin, J. Perret-Liaudet, R. Iovine, Effect of Temperature on Lubricated Steel/Steel Systems With or Without Fatty Acids Additives Using an Oscillating Dynamic Tribometer, *Tribology Letters* 54 (2014) 171–181.
- [20] E. Rigaud, D. Mazuyer, J. Cayer-Barrioz, An Interfacial Friction Law for a Circular EHL Contact Under Free Sliding Oscillating Motion, *Tribology Letters* 51 (2013) 419–430.
- [21] A. Hriouech, M. Belin, J. Perret-Liaudet, M.-I. D. Barros, M. Diaby, An original tribometer coupling a free-oscillation dynamic tribotest with a conventional linear reciprocating tribometer, *Proceedings of the World Tribology Conference 2017, WTC'2017* (2017) 4.
- [22] M. Guibert, B. Nauleau, P. Kapsa, E. Rigaud, Design and manufacturing of a reciprocating linear tribometer, in: *Tribologie et couplages multiphysiques: actes des Journées internationales de tribologie (JIFT 2006)*, PPUR presses polytechniques, Lille, 2006, pp. 55–64.
- [23] H. Ji, M. A. Nicholls, P. R. Norton, M. Kasrai, T. W. Capehart, T. A. Perry, Y.-T. Cheng, Zinc-dialkyl-dithiophosphate antiwear films: dependence on contact pressure and sliding speed, *Wear* 258 (2005) 789–799.