



HAL
open science

Hybrid passive-active vibration control of composite beams

Marcelo Areias Trindade, B. Petitjean, O. Hernandez, Roger Ohayon

► **To cite this version:**

Marcelo Areias Trindade, B. Petitjean, O. Hernandez, Roger Ohayon. Hybrid passive-active vibration control of composite beams. 13th International Conference on Adaptive Structures and Technologies, ICAST 2002, Oct 2002, Potsdam, Germany. hal-03179627

HAL Id: hal-03179627

<https://hal.science/hal-03179627v1>

Submitted on 12 Jan 2024

HAL is a multi-disciplinary open access archive for the deposit and dissemination of scientific research documents, whether they are published or not. The documents may come from teaching and research institutions in France or abroad, or from public or private research centers.

L'archive ouverte pluridisciplinaire **HAL**, est destinée au dépôt et à la diffusion de documents scientifiques de niveau recherche, publiés ou non, émanant des établissements d'enseignement et de recherche français ou étrangers, des laboratoires publics ou privés.

HYBRID PASSIVE-ACTIVE VIBRATION CONTROL OF COMPOSITE BEAMS

Marcelo A. Trindade¹, Benoit Petitjean², Octavio Hernandez², Roger Ohayon³

ABSTRACT

Through the use of hybrid active-passive damping treatments it is possible to combine the well-known reliability, low cost and robustness of viscoelastic damping treatments and the high performance, modal selective and adaptive piezoelectric active control. Several configurations of hybrid damping treatments have already been reported in the literature. They differ mainly by the relative positions of viscoelastic treatments, sensors and piezoelectric actuators. The objective of this work is to provide a brief review of the literature concerning experimental studies on hybrid passive (viscoelastic) - active (piezoelectric) damping treatments of beams. Then, experimental results are presented and used to validate a finite element model proposed in a previous work, with special attention to an accurate prediction of viscoelastic damping frequency-dependence and piezoelectric materials sensor aspect. It is shown that the finite element model is effective in predicting both viscoelastic and piezoelectric materials vibration characteristics. Once validated, it is used to provide the optimised configurations for piezo embedded composite beams. Then, new experimental results are obtained.

INTRODUCTION

Bonded or embedded piezoelectric materials for sensing and control of flexible structures have been largely studied in the past two decades. For the active control of small amplitude vibrations of very flexible structures, they lead to lightweight, adaptive and high performance control systems. However, it is well known that active controllers are very sensitive to variations and uncertainties of system parameters. Hence, adding some passive damping to the structure may lead to more reliable and robust performances. On the other hand, purely passive damping treatments generally lead to reliable, low cost and robust structural vibration control. These can be achieved by covering part of the structure with constrained or unconstrained layers of viscoelastic materials. Nevertheless, the efficiency of such treatments is dependent on the volume of material used so that their performance is generally limited by weight and size constraints. Hence, adding active vibration control may improve damping while respecting structural constraints.

Recently, research has been directed to the simultaneous use of piezoelectric and viscoelastic materials to provide reliable, robust, adaptive and effective damping treatments. Depending on the relative positions of the viscoelastic layer and the piezoelectric actuator, the passive and active actions can operate either separately or simultaneously. However, most of the research in this area has been focused on simultaneous actions. Only recently separate active and passive control mechanisms have been analysed.

¹ Laboratory of Dynamics and Vibration, Pontificia Universidade Catolica do Rio de Janeiro (PUC-Rio), rua Marquês de São Vicente, 225, 22453-900 Rio de Janeiro, Brazil.

² EADS CCR - Corporate Research Center, Advanced Structure Engineering Department; 12, rue Pasteur BP76, 92152 Suresnes Cedex, France.

³ Structural Mechanics and Coupled Systems Laboratory, Conservatoire National des Arts et Métiers CNAM, 2, rue Conté, 75003 Paris, France.

The relatively large number of papers in the area of hybrid active-passive damping is due to the high potential of industrial applications and the multidisciplinary questions raised by such systems. In fact, these multi-physics systems involve some complexities that could be listed as: i) Modelling of laminated piezoelectric structures due to the electromechanical coupling introduced by the piezoelectric sensors and actuators bonded on or embedded in the structure (Rahmoune, Benjeddou, Ohayon and Osmont, 1998); ii) Providing realistic models of viscoelastic materials, since their properties vary with operating temperature and frequency, amplitude and type of excitation (Mead, 1999; Trindade, Benjeddou and Ohayon, 2000); iii) Development of active control algorithms well adapted for damped structures and, if possible, taking advantage of the passive damping. The reference (Trindade and Benjeddou, 2002) give a review synthesis of those topics. Here, the focus is on experimental studies presented in the open literature.

An literature analysis shows that the hybrid constrained layer treatments are generally applied to very thin structures, thus very flexible. This has justified the choice of a Bernoulli-Euler (Kirchoff) model for the host structures on the major part of the studies published. In addition, studies related to beam structures generally consider cantilever beams.

The hybrid treatments themselves are generally very thin covering about 63% of the host structure, increasing the thickness and the volume of the resulting structure by 58% and 33% respectively. It is known that constrained layer treatments are more effective when the bending stiffness of the constraining layer is of the same order as that of the host structure. However, the bending stiffness was generally taken as only 32% of that of the host structure. This is clearly due to the thickness limitations of an added treatment to existing structures. On the other hand, the added active control effectiveness to a pure passive constrained layer treatment of hybrid treatments allows to overcome part of this limitation.

The viscoelastic layers considered in these hybrid treatments are generally very thin. This is justified by several facts. First, passive constrained layer treatments are normally more effective to control several vibration modes when using very thin viscoelastic layers. Second, it is known that active constrained layer treatments suffer from lost transmissibility between the actuator and the host structure due to the softness of the viscoelastic layer. The thickness-to-length ratio of the viscoelastic layers is also generally very small, around 0,1%. However, due to the structure construction, these layers are normally subjected to shear strains and hence they cannot be modelled as Bernoulli-Euler beams.

The majority of the publications show very simple control strategies applied to hybrid damping treatments, such as piezoelectric control voltages proportional to the displacement or the velocity of a particular point of the structure. Some authors (Azvine, Tomlinson and Wynne, 1995; Badre-Alam, Wang and Gandhi, 1999; Crassidis, Baz and Wereley, 2000) have preferred to measure the displacement, with an optical sensor for instance, of some point in the structure and evaluate numerically the corresponding velocity. The main advantage of such simple control strategies is that they can be implemented through an analogical circuit, with no need of complex analogical-digital processing.

The following paper is organised as follows : First, several experimental validations are presented in comparison to the numerical predictions. They are relative to passive configurations, where a host beam is fitted with constrained layer damping treatments.

In a second part, sandwich beams with embedded shear piezoceramic patches are designed, manufactured and tested. Their behaviour as hybrid passive-active structures is verified, using the patches in turn as sensors and as actuators. Control of a sinusoidal excitation is achieved.

PASSIVE EXPERIMENTAL VALIDATION

Several experiments, which are described in Table 1, were considered in a sequence in order to validate each particular characteristic of the finite element model proposed in a previous work (Trindade, Benjeddou and Ohayon, 2001).

Table 1: Description of the tested configurations.

ID	Thickness host beam(mm)	Core thickness (mm)	Thickness constraining beam(mm)
Beam #1	2 mm reference aluminium beam		
Beam #2	1,2	0,1016 Viscoelastic (4 mil)	0,8
Beam #3	1,2	0,254 Viscoelastic (10 mil)	0,8
Beam #4	1,6	0,127 Viscoelastic (5 mil)	0,254

The frequency response function of these four configurations were measured by three accelerometers bonded on the host structure which was subjected to a transversal impulsive force. The experimental set up is shown in Figure 1. The eigenfrequencies, natural modes and damping factors were also evaluated and compared to the numerical ones.

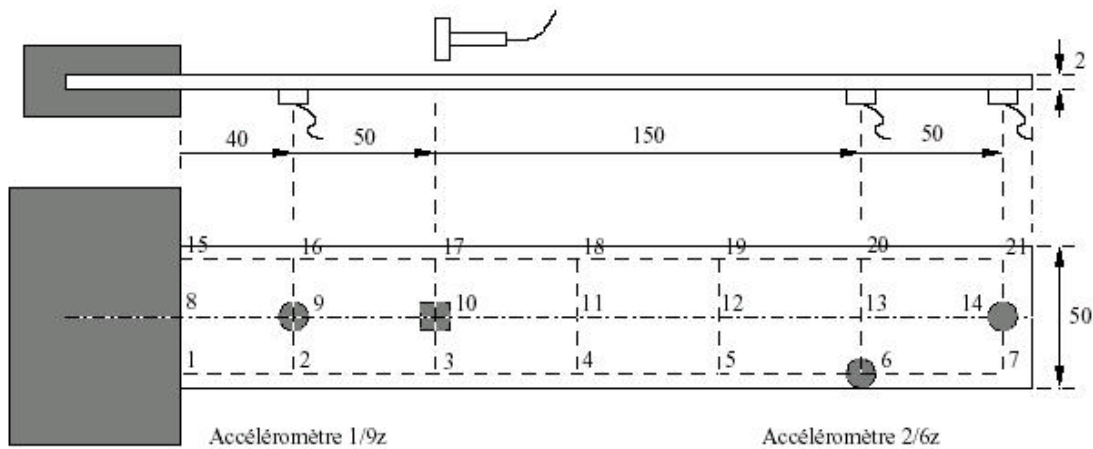

Figure 1 : Passive experimental set up

RESULTS

The measured eigenfrequencies of the Beam #1 were used to updated the finite element model, in particular the Young's modulus and mass density. After evaluation, they were found to be 63.7956 GPa and 2695.1 kg m⁻³. The eigenfrequencies and damping factors measured and evaluated are presented in Table 2.

Table 2: Eigenfrequencies in Hz (damping factors in %) of the six first bending modes of the aluminium cantilever beam.

Experimental					
16.8 (1.5)	108 (0.3)	302 (0.4)	591 (0.3)	988 (0.6)	1490 (0.5)
Numerical					
17.5 (1.5)	109 (0.3)	306 (0.4)	601 (0.3)	993 (0.6)	1484 (0.5)
Error %					
4.0 (0.0)	1.3 (0.0)	1.5 (0.0)	1.6 (0.0)	0.5 (0.0)	-0.4 (0.0)

With the updated properties, the numerical frequency response functions were compared to the measured ones. The numerical results match well with experimental results, as shown in Figure 2. Notice

that the measured damping factors were used for the numerical evaluation of the frequency response. It is interesting to note that the damping factor for the mode 1 is much higher than the others which is probably due to external causes as boundary conditions and acoustical coupling. Considering that the acoustical damping is not changed by the damping treatment, only the viscoelastic damping will be considered in the following comparisons.

The updated properties of the host aluminium beam were then used for the second experiment with the Beam #2 configuration. The viscoelastic material properties are updated through a curve fitting of the frequency response function measured by the accelerometer 2/6z to find out an appropriate set of ADF parameters (Lesieutre and Bianchini, 1995). However, the results show that the finite element model overestimates the damping factors since some differences between the numerical and experimental results can be observed in this frequency response function. The procedure was then redone by curve fitting the frequency response function, the eigenfrequencies and the damping factors.

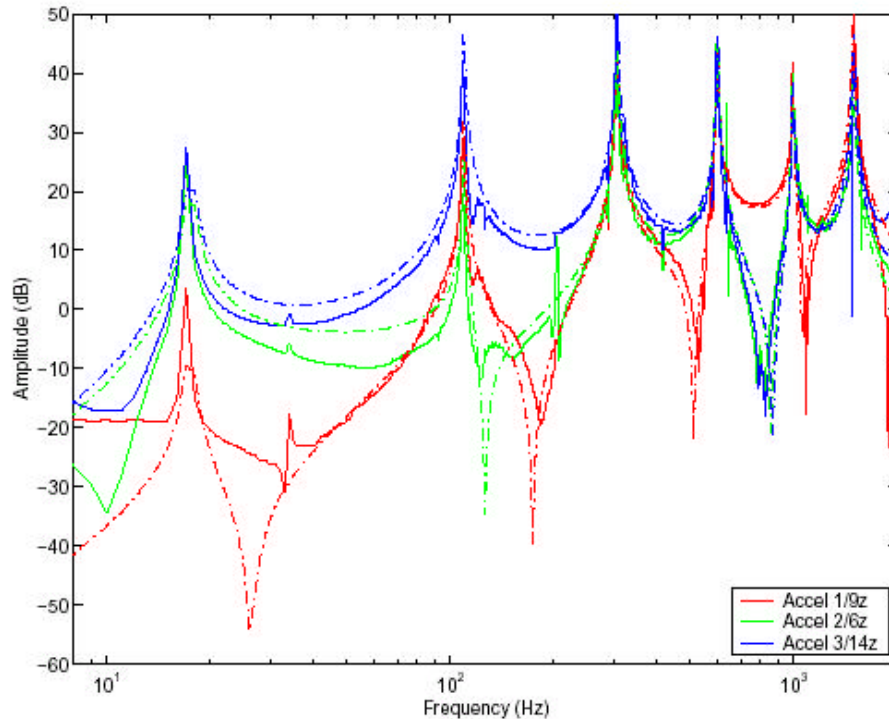

Figure 2: Experimental (solid) and numerical (dot-dashed) frequency response functions of the host aluminium cantilever beam.

One may observe in Table 3 that the eigenfrequencies and modal damping factors match well with experimental results. The updated ADF parameters are shown in Table 4.

Table 3: Eigenfrequencies (damping factors) of the aluminium-viscoelastic-aluminium cantilever beam(1.2 mm - 4 mil - 0.8 mm)

Experimental						
16.5 (5.9)	100 (11.1)	268 (13.4)	496 (13.5)	785 (15.8)	1180 (14.8)	1570 (17.1)
Numerical						
17.6 (5.7)	100 (11.8)	269 (14.1)	501 (15.4)	795 (16.6)	1154 (16.8)	1577 (15.9)
Error %						
6.6 (-2.3)	0.5 (6.6)	0.4 (1.3)	1.0 (14.4)	1.3 (5.2)	-2.2 (13.8)	0.4 (-6.8)

Table 4: ADF parameters updated through the curve fitting of the frequency response function, eigenfrequencies and damping factors.

G_0 (MPa)	Δ_1	Δ_2	Δ_3	Δ_4	Ω_1 (rad/s)	Ω_2 (rad/s)	Ω_3 (rad/s)	Ω_4 (rad/s)
0.18	0.84	3.80	10.46	64.86	22.24	274.55	1945.38	15704.18

The comparison of the experimental and numerical frequency response functions is shown in Figure 3. One can observe that they match well for the accelerometers 2/6z and 3/14z, but not for the accelerometer 1/9z. This may be explained by the fact that, due to its location near the clamped end, there is a high static contribution for the response measured by this accelerometer.

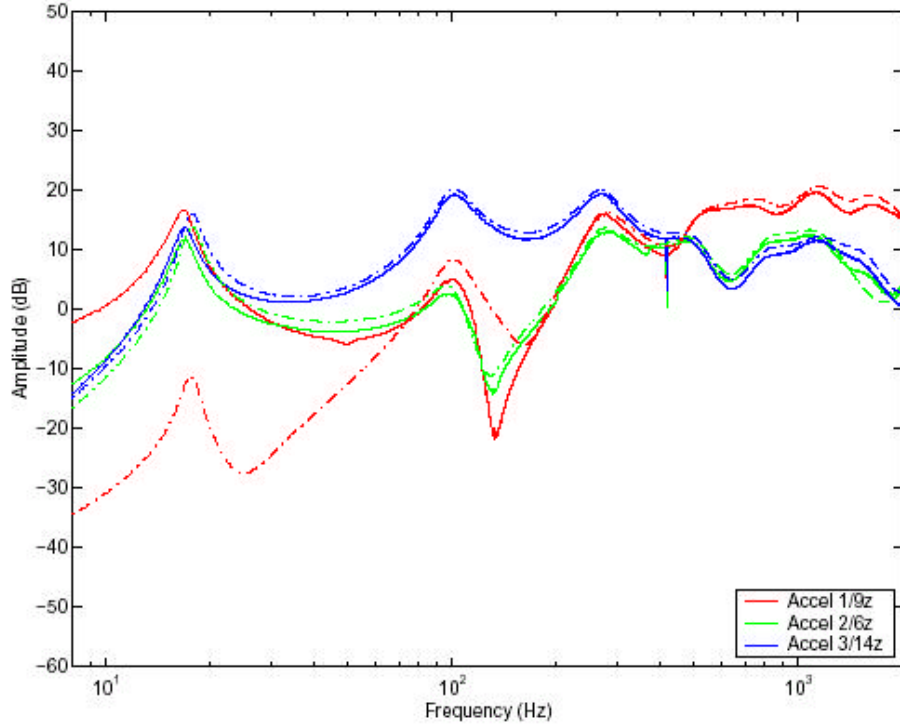

Figure 3: Experimental (solid) and numerical (dot-dashed) frequency response functions of the aluminium-viscoelastic-aluminium cantilever beam #2.

The results for the third beam configuration (Beam #3) were compared without any further updating. The properties of the aluminium beam are those evaluated with Beam #1 configuration and the properties of the viscoelastic material are those evaluated with Beam #2 configuration. Table 5 shows the experimental and numerical eigenfrequencies and damping factors for the multilayer beam #3. The damping factors for the first five modes match well with the experimental ones, but those for the modes 6 and 7 are overestimated by the model. This is due to the fact that these modes present a strong bending-torsion coupling, which is not represented by the model.

Table 5: Eigenfrequencies (damping factors) of the multilayer beam aluminium-viscoelastic-aluminium (1.2 mm - 10 mil - 0.8 mm).

Experimental						
15.3 (11.5)	86 (16.0)	227 (16.6)	419 (18.8)	663 (17.3)	983 (13.6)	1340 (12.2)
Numerical						
17.5 (11.0)	91 (16.5)	239 (18.4)	435 (18.0)	681 (17.1)	984 (16.2)	1347 (14.8)
Error %						
14.4 (-4.7)	6.2 (3.2)	5.3 (10.8)	3.9 (-4.5)	2.8 (-0.9)	0.1 (19.3)	0.5 (21.0)

Although some bending and torsion modes are highly coupled, the comparison of the experimental and numerical frequency response functions, observed in Figure 4, show that the model is capable of predicting the behaviour of the aluminium-viscoelastic-aluminium (1.2 mm - 10 mil - 0.8 mm) with a satisfactory accuracy.

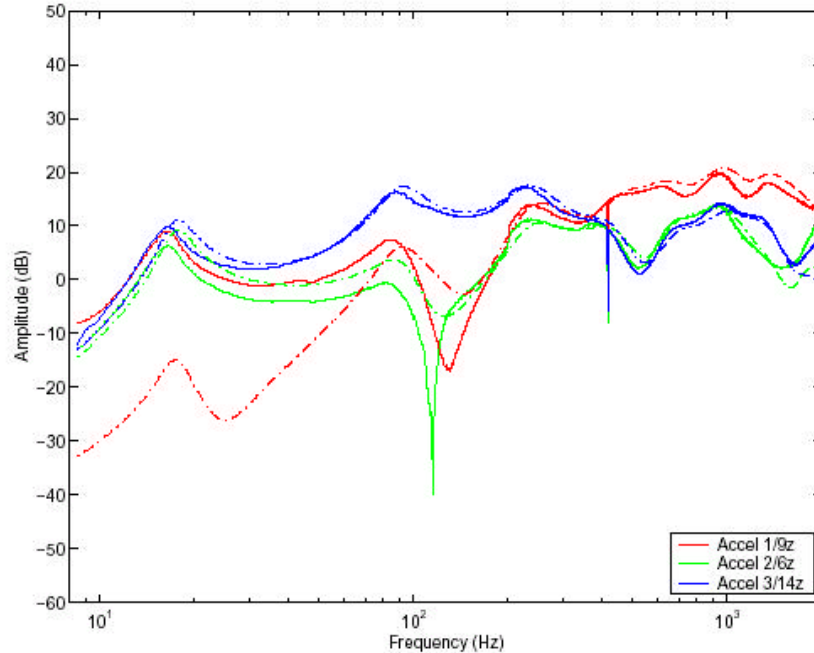

Figure 4: Experimental (solid) and numerical (dot-dashed) frequency response functions of the aluminium-viscoelastic-aluminium cantilever beam #3.

The use of a commercially available damping treatment is also used to evidence the advantages of the custom made damping treatments. The host aluminium beam is thus covered by the Damping Foil DF2552. Table 6 shows that the Beam #4 is much less damped than the others.

Table 6: Eigenfrequencies (damping factors) of the multilayer beam aluminum-DF2552 (1.6 mm - 5 mil - 10 mil).

Experimental						
15.6 (3.0)	99 (4.2)	273 (5.1)	525 (4.7)	859 (6.0)	1270 (6.1)	1750 (3.7)
Numerical						
17.1 (4.5)	99 (8.6)	268 (9.9)	506 (10.3)	813 (10.6)	1192 (10.2)	1642 (9.3)
Error %						
9.7 (48.5)	0.2 (105.1)	-1.8 (94.0)	-3.6 (120.2)	-5.4 (76.0)	-6.2 (67.7)	-6.2 (151.9)

A steel cantilever beam of dimensions 300mmx50mmx2 mm with a bonded piezoelectric sensor ACXQP20N was considered to test the piezoelectric feature of the finite element model. The material properties of the steel beam are: Young's modulus 201 GPa and mass density 7860 kg m⁻³. The ACXQP20N is composed of an ensemble of two piezoceramic patches embedded in an epoxy matrix.

Hence, the identification of its properties was achieved through the consideration of a virtual piezoceramic patch with the dimensions of the real sensor and respecting the force-to-displacement and voltage-to-force ratios of the real sensor. The main properties of the virtual patch are given in Table 7. In order to validate the beam-sensor coupling, we measured the frequency response function of the cantilever beam subjected to a transversal impulsive force, applied at 62 mm of the clamped end. The response was measured through two accelerometers, one placed at 10 mm of the free end of the beam (accel 1) and the other at 37 mm of the clamped end (accel 2), and also through the piezoelectric sensor.

Using the properties listed in Table 7, it was observed that the experimental and numerical frequency response function did not match well.

Table 7: Properties of the virtual piezoelectric patch corresponding to the real piezoelectric transducer ACXQP20N.

Thickness	0.7620 mm (30 mil)
Length	50.8 mm
Distance to clamped end	11.7 mm
Young's modulus	25.2 GPa
Mass density	4901.7 kg m ³
Piezoelectric constant e_{31}	25.4 C m ²
Dielectric constant ϵ_{33}	3.54 10^{-8} F m ⁻¹

Therefore, an update procedure was performed to find out the piezoelectric e_{31} and dielectric ϵ_{33} constants. The responses of the three sensors (piezoelectric sensor, accel 1 and accel 2) were used for curve fitting. The following values were found: $e_{31} = 25,4$ C m² and $\epsilon_{33} = 9,72 \cdot 10^{-8}$ F m⁻¹. The frequency response functions using these updated values are shown in Figure 5. One may observe that they match very well.

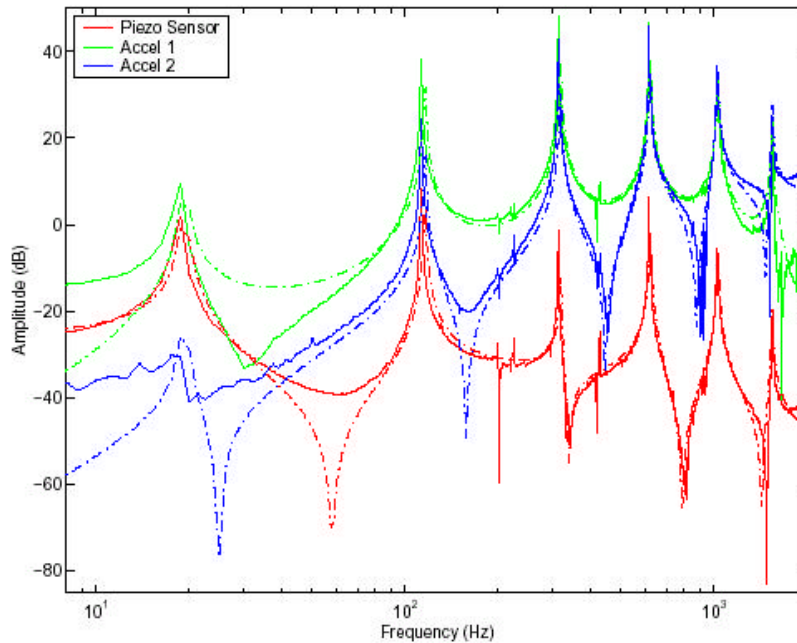

Figure 5: Experimental (solid) and numerical (dot-dashed) frequency response functions of the steel cantilever beam with piezo sensor ACXQP20N.

This verifies the good agreement between the numerical model results and the experimental ones. That is the reason why this numeric model was used to define the new beam configurations. The thickness of each beam and shear piezo position were optimised with this model in Trindade, 2000, providing the new configurations listed in table 8.

Table 8 : Descriptions of the optimised configurations

ID	Thickness host beam(mm)	Core thickness (mm)	Thickness constraining beam(mm)
Beam #5	1,6	0,254 Viscoelastic (10 mil)	0,4
Beam #6	1,6	0,254 Viscoelastic + Shear Piezo (10 mil)	0,4
Beam #7	1	0,254 Foam Layer + Shear Piezo (10 mil)	1

EXPERIMENTS ON SANDWICH BEAMS WITH EMBEDDED SHEAR ACTUATORS

First, we would like to highlight the inherent difficulties in the manufacture of structures with embedded shear piezo actuators. The critical points of this process were to assure a good stress transmission between the piezoelectric patch surfaces and the aluminium beams and also to be able of supplying an electric signal to the integrated piezoelectric patch.

A different experimental set up from that for the passive case was used for these new configurations. The excitation was handled by a shaker attached to the composite beam near the clamped end while the structure response was measured with an accelerometer placed at the beam's tip, Figure 6.

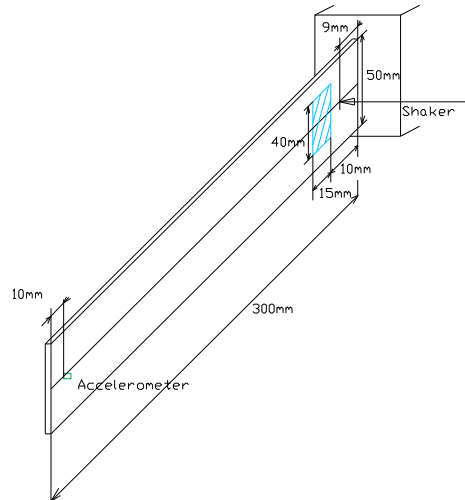

Figure 6 : Active experimental set up

The first experiment consisted in exciting the beam with the shaker and measuring the response with the piezo acting as sensor. The objective was to verify the correct integration of the shear piezo patch. Both frequency response functions are represented in Figure 7 confirming the previous objective. One may observe the added damping by the viscoelastic layer is quite effective compared to the foam configuration beam.

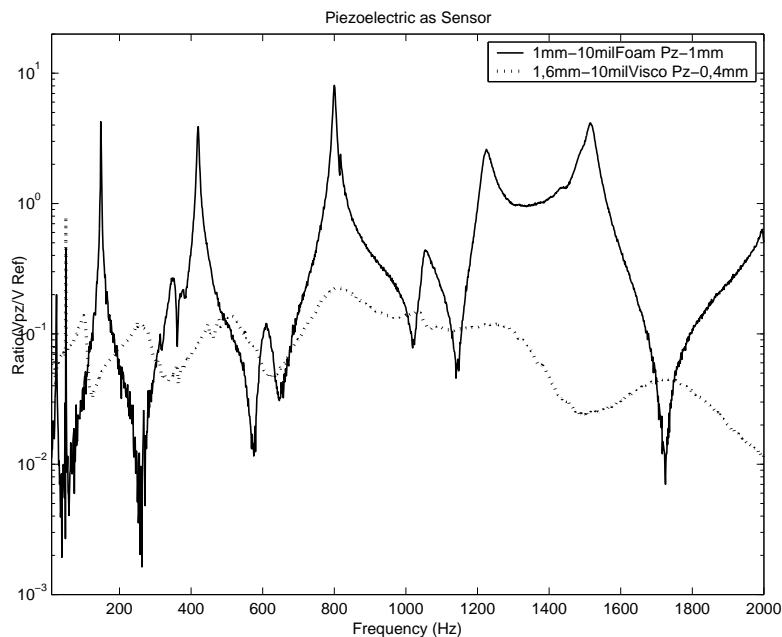

Figure 7 : Transfer function between Piezo and Shaker voltage (V_p/V_{ex}) (blue: beam #6, green: beam #7)

The next experiment was carried out using a feedforward controller based on an LMS algorithm (Nelson & Elliot, 1993). The objective was to minimise the structure response measured by an accelerometer when exciting the beam with the shaker controlled by a sine-on-random signal (sine at 500Hz).

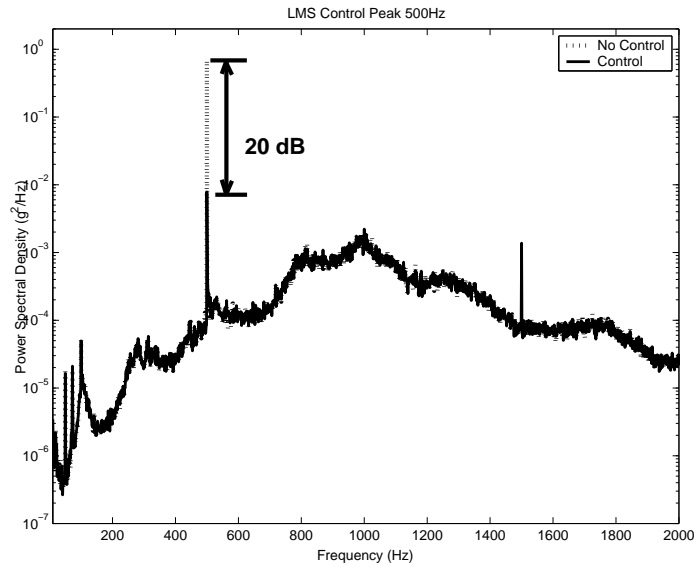

Figure 7 : Power spectral density of beam #6

The 20 dB diminution shows the performance of the shearing piezo patch (despite of the appearance of another peak at 1500 Hz), while the viscoelastic damping reduces the structure response to random excitation. No numerical validation was done for this experiment.

CONCLUSION

A brief review of the open literature concerning experimental studies on hybrid passive (viscoelastic) - active (piezoelectric) damping treatments of beams was presented. Then, several experimental results were presented in a sequence in order to validate each particular characteristic of the finite element model.

The results have shown that the experimental and numerical frequency response functions match well for all cases. In particular, the viscoelastic frequency dependence using the ADF model and the piezoelectric sensing features of the model were validated. The identification of the piezoelectric sensor properties was achieved by using a virtual piezoceramic patch with updated properties.

The well fitted results from the numerical model gave enough confidence in order to rely on its results from the optimisation of the new configurations. Despite of the difficulties, the manufacturing of these embedded shear piezo structures was successfully done. First results were obtained, and showed the capability of shearing piezoelectric actuators in attenuating an excitation at a given frequency while the viscoelastic layer diminishes the structure response over a frequency range.

ACKNOWLEDGEMENT

This work has been supported by the DGA-Ministry of Defense.

REFERENCES

- Azvine, B., Tomlinson, G.R., and Wynne, R. Use of active constrained-layer damping for controlling resonant vibration. *Smart Materials and Structures*, **4**(1):1–6, 1995.
- Badre-Alam, A., Wang, K.W., and Gandhi, F. Optimization of enhanced active constrained layer (EACL) treatment on helicopter flexbeams for aeromechanical stability augmentation. *Smart Materials and Structures*, **8**(2):182–196, 1999.
- Crassidis, J., Baz, A., and Wereley, N. H_∞ control of active constrained layer damping. *Journal of Vibration and Control*, **6**(1):113–136, 2000.
- Lesieutre, G.A. and Bianchini, E. Time domain modelling of linear viscoelasticity using anelastic displacement fields. *Journal of Vibration and Acoustics*, **117**(4):424–430, 1995.
- Mead, D.J. *Passive Vibration Control*. John Wiley & Sons, New York, 1999.
- Nelson & Elliot. *Active control of sound*. Academic Press 1992.
- Rahmoune, M., Benjeddou, A., Ohayon, R., Osmont, D. *New Thin Piezoelectric Plate Models*. *Journal of Intelligent Material Systems and Structures*, **9**(12): 1017-1029, 1998
- Trindade, M.A. and Benjeddou, A. Hybrid active-passive damping treatments using viscoelastic and piezoelectric materials: review and assessment. *Journal of Vibration and Control*, **8**(6), 2002.
- Trindade, M.A., Benjeddou, A., and Ohayon, R. Finite element modelling of hybrid active-passive vibration damping of multilayer piezoelectric sandwich beams. part 1: Formulation and part 2: System analysis. *International Journal for Numerical Methods in Engineering*, **51**(7):835–864, 2001.
- Trindade, M.A., Benjeddou, A., and Ohayon, R. Modeling of frequency-dependent viscoelastic materials for active-passive vibration damping. *Journal of Vibration and Acoustics*, **122**(2):169–174, 2000.
- Trindade, M. Contrôle hybride actif-passif des vibrations de structures pour des matériaux piézo-électriques et viscoélastiques: poutres sandwich/multicouches intelligentes; Doctoral Dissertation, CNAM, Paris, France, 2000
- Wang, G. and Wereley, N.M. Frequency response of beams with passively constrained damping layers and piezo-actuators. In Davis, L.P., ed., *Smart Structures & Materials 1998: Passive Damping and Isolation*, SPIE, Bellingham, vol. **3327**, pp. 44–60, 1998.