



HAL
open science

3D Finite element modelling of novel strengthening solutions for RC wall/slab connections

Magdalini Titirla, Antoine Chalot, Laurent Michel, Emmanuel Ferrier

► To cite this version:

Magdalini Titirla, Antoine Chalot, Laurent Michel, Emmanuel Ferrier. 3D Finite element modelling of novel strengthening solutions for RC wall/slab connections. *Ingegneria sismica - International Journal of Earthquake Engineering*, 2020, 3, pp.67-83. hal-03177084

HAL Id: hal-03177084

<https://hal.science/hal-03177084>

Submitted on 14 Apr 2021

HAL is a multi-disciplinary open access archive for the deposit and dissemination of scientific research documents, whether they are published or not. The documents may come from teaching and research institutions in France or abroad, or from public or private research centers.

L'archive ouverte pluridisciplinaire **HAL**, est destinée au dépôt et à la diffusion de documents scientifiques de niveau recherche, publiés ou non, émanant des établissements d'enseignement et de recherche français ou étrangers, des laboratoires publics ou privés.

3D FINITE ELEMENT MODELLING OF NOVEL STRENGTHENING SOLUTIONS FOR RC WALL/SLAB CONNECTIONS

Magdalini D. Titirla¹, Antoine Chalot², Laurent Michel² and Emmanuel Ferrier²

¹ Laboratoire de Mécanique des Structures et des Systèmes Couplés (LMSSC), Conservatoire National des Arts et Métiers (CNAM), Paris, France

² Laboratoire des Matériaux Composites pour la Construction (LMC2), Université LYON 1, Villeurbanne, France

SUMMARY: *The aim of this study is to create a nonlinear FE model able to predict the mechanical behavior of RC wall/slab connections strengthened by using Carbon Fiber Reinforced Polymers. The experimental mechanical behavior of 4 full scale RC wall/slab connections with a reference join and 3 strengthened by FRP are investigated from members of our researcher team. The 3D finite-element micromodel of the RC wall/slab connections is conducted utilizing the FE software ABAQUS, reproducing the actual geometry of the experiments, as well as the same boundary conditions and loading as in the experimental program. The analytical investigation is carried out through an extended comparative parametric study and is focused on the quantitative influence of certain simplified modelling assumptions and several critical modelling parameters on the response of the system. The accuracy of the 3D model was assessed against the experimental results.*

KEYWORDS: *Composite, FRP, Finite element model, Joins RC structures*

1 Introduction

The safety of constructions is one of the major priorities of engineering globally, as well as the upgrade of the existing structures because of their deterioration, ageing, environmental induced degradation, a lack of maintenance, or the need to meet current design requirements. In order to achieve these goals and minimise the effects of an earthquake, several strengthening techniques and studies have been developed. The most common in a concrete structure is by adding concrete and steel jacketing of the concrete frame elements [Tsonos et al., 1992, Lu et al., 2012, Colajanni et al., 2020]. Another more modern technique is by adding devices that can increase the strength of the structure and dissipate a large percentage of the seismic energy without belonging to the supporting structure of the constructions, or by adding base isolation with some aspects, like the cost and the practical implementation, need to take into control [Soong and Spencer, 2002, Symans et al., 2008, Latour and Rizzano, 2019]. Finally, the other direction is by strengthening the joints, with inclined steel reinforcement in shear-critical joints [Engindeniz et al., 2005, Karayannis and Sirkelis, 2008] or by using Fiber Reinforced Polymers (FRP) [El-Amoury and Ghobarah, 2002, Antonopoulos and Triantafillou, 2003, Ferraioli and Di Lauro, 2009, Akguzel et al., 2012, Titirla et al., 2017; 2018a].

In the present work, attention is focusing on the bonded fiber reinforced polymers (FRP) composites for seismic retrofitting RC structures and specially in the connections between beam-columns or columns-slab. Lee et al [Lee et al., 2010] proposed the strengthening of the interior beam-column joints with CFRP layers wrapped around the column and joints. The experimental results show that the beam-column joints strengthened with CFRP can increase their structural stiffness, strength, energy dissipation capacity and the ductility of the joint. In another study for interior beam-column joints, Ma et al. [Ma et al., 2017] experimentally

studied the strengthening of full-scale interior subassemblies with slab and transverse beams with different CFRP retrofitting schemes. Esmaeeli et al [Esmaeeli et al., 2017] focused their study to a seismic strengthening of shear deficient joints of 3D reinforced concrete (RC) corner beam-column connections. Their technique is composed of a combination of GFRP sheets and a steel cage. The test results of this technique revealed a noticeable improvement in the seismic response of the strengthened specimen.

In order to demonstrate the effectiveness of these strengthening solutions, there are either the experimental or the numerical researches. Considering the numerical research, two different approaches have been followed: (i) the macromodels, based on the physical understanding of each solution [Montuori et al. 2016, Montuori et al. 2019a], and (ii) the micromodels, based on a finite element (FE) representation. FE models play a key role in the ordinary design process of new structures and in the assessment of existing ones [Brownjohn et al., 2001, Titirila et al., 2018b, Montuori et al., 2019b, Montuori et al 2019c].

The Finite Element Method (FEM) has become the most popular method in both research and industrial numerical simulations, as it takes into consideration material laws, contact interface conditions and others parameters, which lead to the exact response of the strengthening solutions. Several algorithms, with different computation-al costs, are implemented in the finite elements codes, such as ABAQUS [Simulia, 2012], which is commonly used software for finite element analysis.

In the present work attention is focused on the mechanical behavior of 4 full scale specimens with a reference joint and 3 strengthened by FRP, proposed and investigated by Chalot et al [Chalot et al., 2018]. The aim of this study is to create a FE model able to predict the mechanical behavior of RC wall/slab connections by using Carbon Fiber Reinforced Polymers. The numerical analyses is conducted utilizing the FE software ABAQUS [Simulia, 2012]. The 3D FEM model geometry reproduced the actual geometry of the experiments, as well as the simulation used the same boundary conditions and loading as in the experimental program. The study is focussed on a set of systematic procedures for finite element model calibration and parametric evaluation that enable robust simulation of the RC wall/slab connections under monotonic and cyclic loading with high fidelity using explicit time-stepping time-history analysis methods. The accuracy of the 3D model was assessed against the experimental results and the validated model was subsequently used to generalize the experimental findings and to study the effects of various parameters. In this way, results come out that are harder to obtain experimentally. The obtained results reveal the overall mechanical behavior of the RC wall/slab connections reinforced by using Carbon Fiber Reinforced Polymers.

2 Short description of the investigated connections

In the present section, a short description of the 4 large scale specimens with a reference joint and 3 strengthened joints by FRP is given. The reference joint, referred to herein as RC, is a common wall/slab T connection, which in a real structure, is the junction between vertical side RC wall and RC floor. It was composed of a wall element with a thickness of 16 cm, a length of 100 cm and a width of 50 cm. The slab element was equal to 9 cm thick for a length of 100 cm (Figure 1a). The longitudinal reinforcement of the wall was consisted of 2x3 ϕ 10 steel bars, and 2x8 ϕ 10 steel bars in the transverse direction, while in the slab there were 2x9 ϕ 6 steel bars in longitudinal direction and 2x7 ϕ 6 steel bars in the transverse direction.

The first strengthening solution, mention as RC1-CFRP, composed of 3 FRP strips of 60 mm wide and 600 mm long in each side of the wall, glued on the slab with spacing between strips of 40 mm (Figure 1b). The next one, mention as RC1-CFRP-Ali38-At, (Figure 1c) have been consisted of the same composite strips of the RC1-CFRP specimen, as well as (i) anchor wisps to the wall-slab connection and (ii) anti-buckling anchor wisps with an angle of 20° in

the joint have been added. The last one, referred as RC1-CFRP-ALc38-At, (Figure 1d) was similar to RC1-CFRP-Ali38-At with the exception that the anchor wisps are continuous to the right of the node.

The concrete was a C30/37 with the average experimental compressive strength equal to $f_{cm} = 36.7$ MPa with a standard deviation of ± 1.1 MPa. The experimental splitting tensile strength of concrete was equal to $f_{ct} = 5.0$ MPa with a standard deviation of ± 0.5 MPa.

The steel rebar had the grade of S500B. The 10 mm diameter steel rebar (D10) was tested in tensile. Their elastic strength was $f_y = 545$ MPa with a standard deviation of ± 22 MPa, their ultimate strength was $f_u = 599$ MPa with a standard deviation of ± 21 MPa. Their tensile modulus was $E_s = 202$ GPa and their ultimate strain is $\epsilon_{su} = 2.9\%$.

The FRP strips were an externally bounded Carbon Fiber Reinforced Polymer (CFRP), called as Foreva® FRP and marketed by FREYSSINET. In addition, it consisted of a bi-directional Carbon / Carbon textile with a 70/30 ratio, the matrix was two-component epoxy glue. It had a thickness of $t_f = 0.48$ mm, a tensile strength of $f_f = 1700$ MPa and its tensile modulus is $E_f = 105$ GPa. The epoxy resin had a tensile strength of $f_r = 27$ MPa and a tensile modulus of $E_r = 2.3$ GPa. The 20 mm anchors consisted of an assembly of 38 carbone wires, each of this wire has an ultimate load of $P_f = 2.6$ kN. All the mechanical properties have been controlled during the manufacturing process.

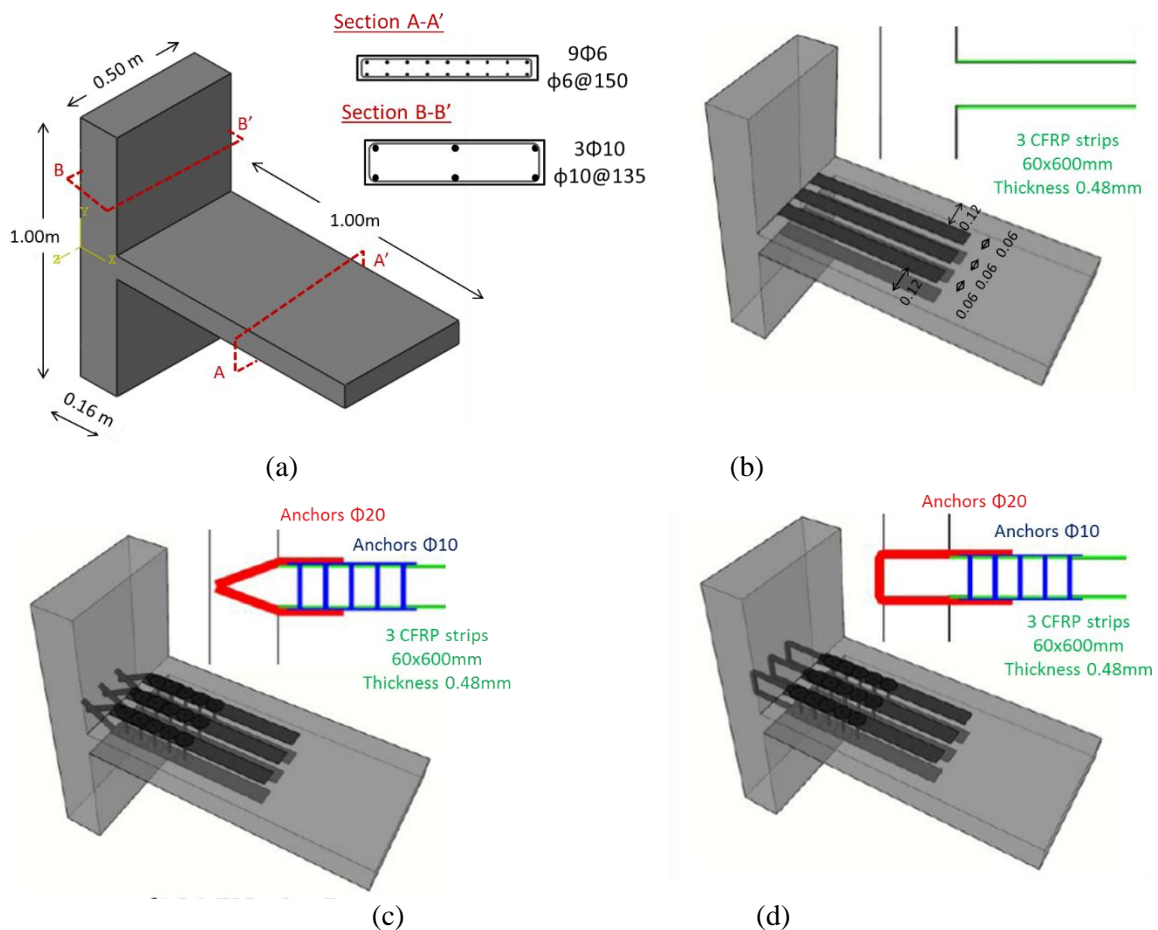

Figure 1. Details of the four RC wall/slab connections.

3 Experimental study

Full-scale RC wall/slab connections (the reference and the strengthened) were experimentally investigated under monotonic loading. The RC wall/slab connections tested at a 90° rotation in order to focus our attention only on the connections in quasi-static tests and all the details are illustrated in Figure 2. The experimental set ups were conducted at the Laboratory of Composite Materials for Constructions (LMC2) at the University Claude Bernard Lyon 1. A hydraulic actuator operating in displacement control mode with a speed of 30 mm/min (fixed to a strong wall) was attached to the top of the slab using a specially designed clamping device. The displacement at the top of the slab increased gradually until the stroke of the actuator reached or until clear connection failure was observed. The load cell incorporated in the actuator was used to record the applied load at the top of the slab. The wall was fixed in the strong floor with the help of fixing blocks in both the horizontal and vertical directions. Nine linear variable differential transformers (LVDT) were positioned on each specimen and measured the corresponding displacement at different positions in the specimen (see Figure 2). Six strain gauges (nos. 1 to 6) measure the deformation values of the steel rebars inside the joint, while other three strain gauges (nos. 7 to 9) measure the deformations of the CFRP reinforcement (for the strengthening connections). The specimen details of the experiment are presented by Chalot et al [Chalot et al., 2018].

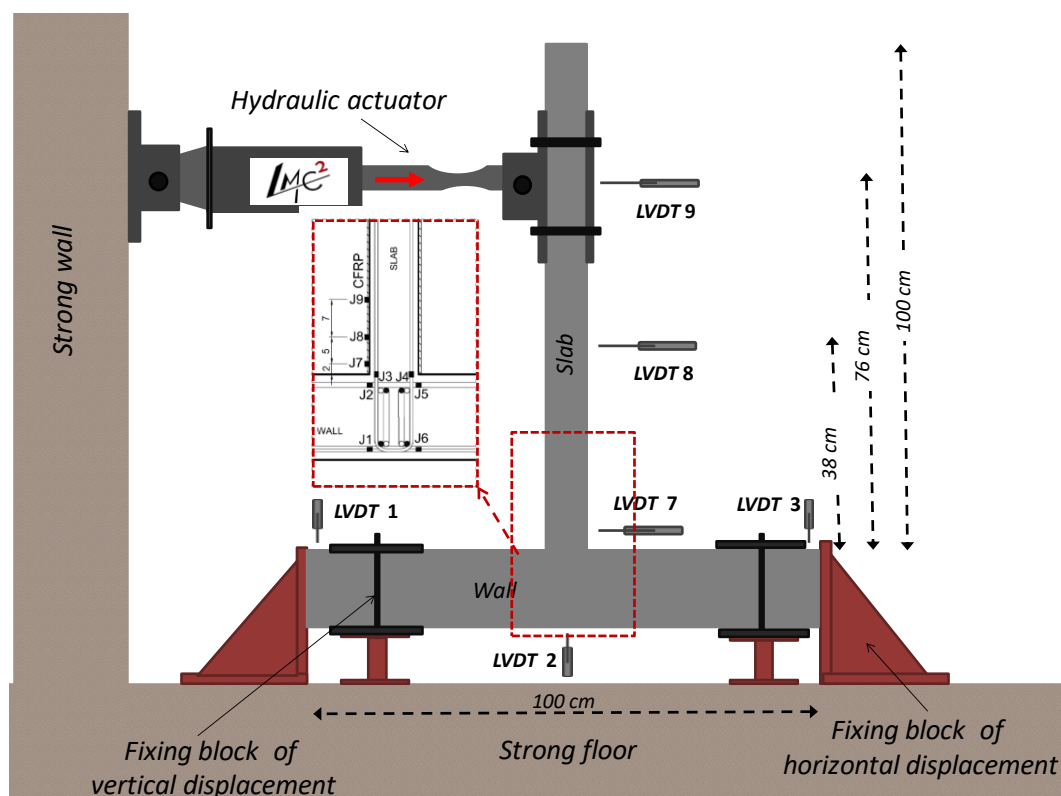

Figure 2 - Details of the experimental setup

4 Finite element simulation

The numerical analyses were conducted utilizing the FE software ABAQUS. The Finite Element Method (FEM) has become the most popular method in both research and industrial numerical simulations, as it takes into consideration material laws, contact interface conditions and other parameters, which lead to the exact response of the strengthening solutions. The majority of the research used the Finite Element Method in order to create a

reliable tool for the simulation of their study (devices/connections) to reduce the cost of the experiments in a parametric study [Doudoumis, 2007, Nip et al., 2010, Larbi et al., 2012, Manos et al., 2014, Titirla et al., 2015, Larbi and Deü, 2019, Titirla et al., 2019a]. The study is focused on a set of systematic procedures for finite element model calibration and parametric evaluation that enable robust simulation of the RC wall/slab connections under monotonic and cyclic loading with high fidelity using explicit time-stepping time-history analysis methods.

4.1 Three-dimensional finite element models

The finite elements analysis calibration study included analytical modelling of the RC wall/slab connections. The 3D FEM model geometry reproduced the actual geometry of the experiments, as well as the simulation used the same boundary conditions and loading as in the experimental program (see Fig. 3).

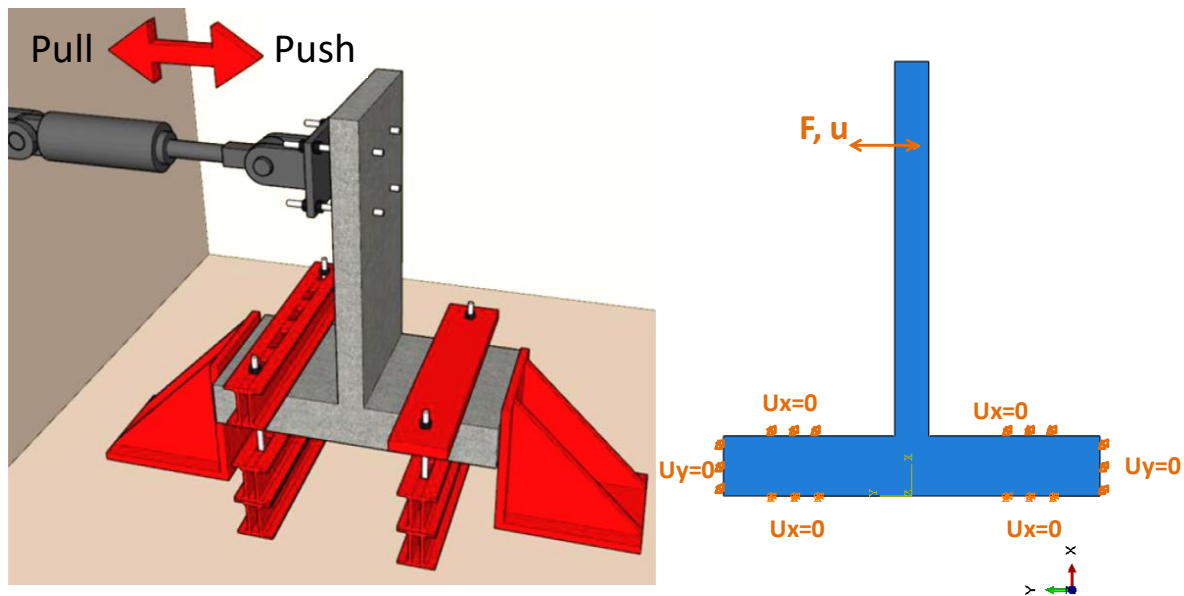

Figure 3 - Load position and boundary conditions of (i) the experimental set up, (ii) the FE model of the RC wall/slab connections

Several simulations have been conducted to identify the best meshing. Wall and slab were meshed using 3D reduced integration solid element C3D8R (eight-node bricks), for the steel rebars 3D wire elements were used with “beam behavior”, while the FRP sheets were idealized as planar finite element and their actual thickness were utilized as a section property. Normally, a higher mesh density provides for higher accuracy but also increases the computational time without improving substantially the accuracy of the results, therefore, a trade-off between time and accuracy becomes crucial [Simulia, 2012]. The final mesh has 10244 elements for the RC1-REF model, 13424 for the RC1-CFRP model, 15296 elements for the RC1-CFRP-Ali38-At and 14628 elements for the RC1-CFRP-ALc38-At and the numerical results were a solution that correlated with the experimental results. In Figure 4, the FEM model used for the RC wall/slab connections is presented with the details of the steel rebars and the FRP in each connection.

A standard test had been carried out, in order to establish the basic material properties of all the materials (concrete, steel rebars and CFRP). These experimentally derived material properties were utilized in the subsequent numerical study.

The response of the concrete is described in the elastic and plastic field with the use of the ‘Concrete Damaged–Plasticity’ (CDP) model, which accounts the plasticity of the concrete

without neglecting the damage storage, typical of brittle-materials. The uni-axial concrete behavior, both in tension and compression, has been built based on the ‘Fracture Energy Theory’ [Lee and Fenves, 1988, Krätzig and Pölling, 2004, Alfarah et al., 2017, Earij et al., 2017]. The damaged plasticity model for concrete available in the ABAQUS material library was adapted to model concrete response, since it has been shown to perform satisfactorily in similar applications [Malm, 2009]. The values adopted for the relevant material parameters, namely the angle of dilation h , the eccentricity, the ratio of equibiaxial to uniaxial compressive stress f_{b0}/f_{c0} , the ratio of the second stress invariant on the tensile meridian to that on the compressive meridian at initial yield K_c and the viscosity parameter were 40, 0.1, 1.16, 0.666 and 0 respectively and were all within the range encountered in literature [Obaidat et al., 2010]. In accordance with similar studies [Obaidat et al., 2010, Titirla et al., 2019b], the stress strain response of concrete in compression was derived according to Saenz [Saenz, 1964], whilst the tension stiffening response was defined in terms of tensile stress and axial deformation according to Cornelissen et al. [Cornelissen et al., 1986], assuming a fracture energy equal to 0.06.

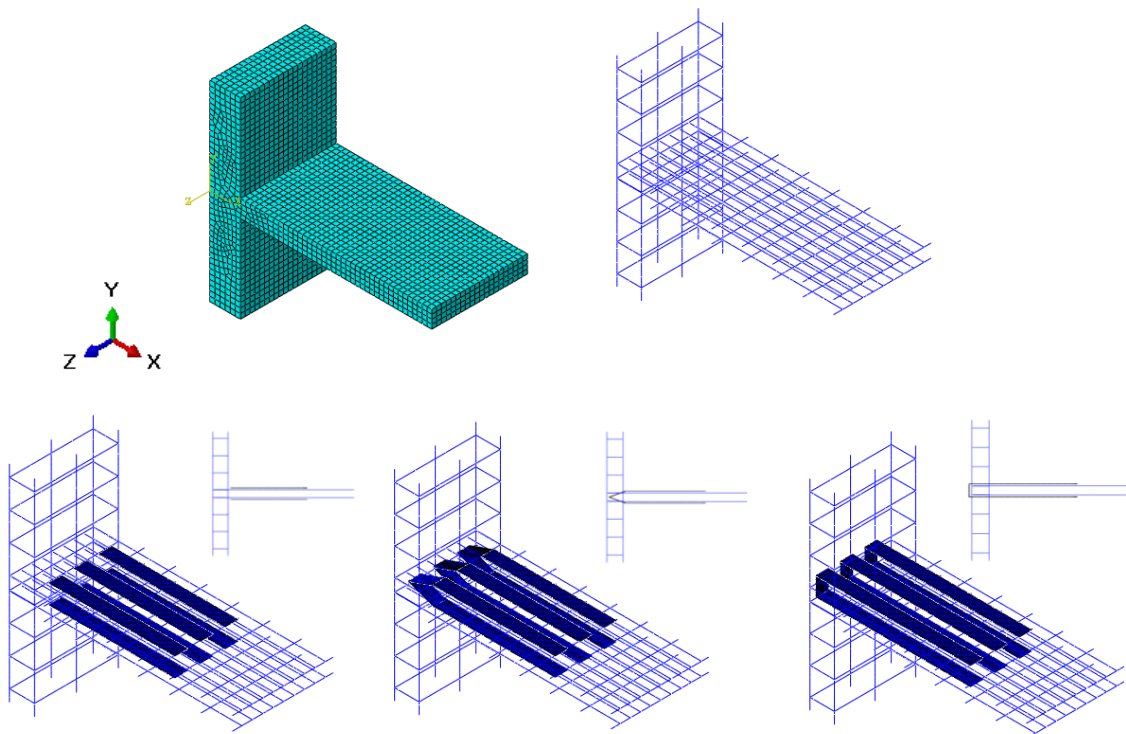

Figure 4 - The FEM model used for the RC wall/slab connections and details of steel rebars and FRP in each connection

The uniaxial stress–strain correlation of the steel rebars were modeled as elastic with Young’s modulus (E_s) and Poisson’s ratio (ν) at typical values of 200 GPa and 0.3, respectively. Plastic behavior was defined in a tabular form, including yield stress and corresponding plastic strain. The experimentally obtained stress (σ_{nom})-strain (ϵ_{nom}) curves for the rebars was converted into the true stress (or Cauchy) (σ_{true})- logarithmic plastic strain (ϵ_{pl}) format and was further utilized in order to define the material response.

The CFRP sheets were assumed orthotropic under plane stress conditions and the material properties reported in Figure 5d were adopted. Moreover, damage and failure of the FRPs was explicitly modelled by adopting the Hashin damage model [Hashin, 1983] incorporated in ABAQUS. Only tensile failure in the principal direction was considered, whilst other failure modes were considered irrelevant to the present study.

The surfaces in contact between the concrete wall/slab and the FRP were modelled as perfect tie connection due to (i) the existence of the anchors of $\Phi 10$ (10 wires), as well as (ii) in the experimental results there was no debonding of the CFRP strip.

Due to severe convergence problems typically associated with strongly nonlinear response and with materials exhibiting non-monotonic stress–strain response [Simulia, 2012, Crisfield and Wills, 1988], such as concrete and cohesive elements, the explicit dynamics solver ABAQUS/EXPLICIT was employed to perform the nonlinear analyses. Quasi-static response was achieved by specifying a slow displacement rate and checking that the kinetic energy was smaller than 2% of the internal energy for the greatest part of the analysis.

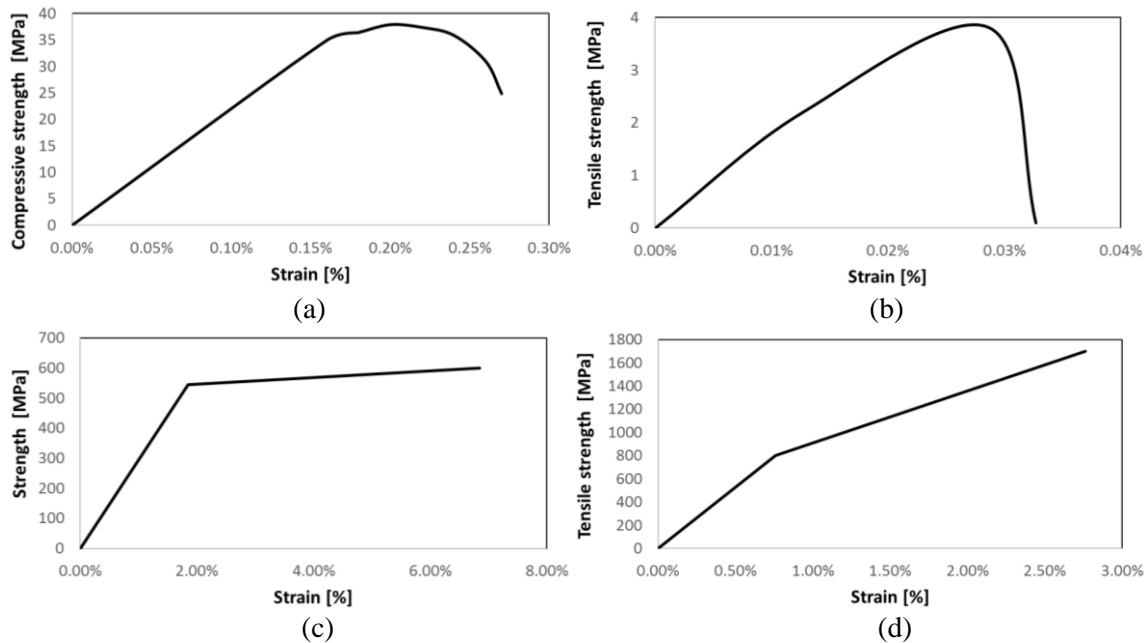

Figure 5 - Stress-strain law of (a) concrete (compressive), (b) concrete (tensile), (c) steel rebars, (d) FRP

4.2. Validation and verification

A flowchart for carrying out the FEM analysis procedure is presented in Fig. 6. As it is previously mentioned, experimental stress-strain curves of the material's behavior were converted into the true stress-strain curves and were inserted in ABAQUS [Simulia, 2012]. At the beginning, the 3D –FEM of the RC connection was modeled (meshing, boundary conditions, and loading procedure) and compared against the monotonic experimental data, which was presented in Section 2. Implicit analyses were carried out using Newton-Raphson equilibrium iterations that are augmented with automatic sub-incrementation. Next step was to rerun the previous monotonic experimental data with explicit dynamic analyses in order to calibrate explicit solution (e.g., explicit parameters, loading amplitude). These parameters are adjusted to control the simulation and to achieve convergence and/or acceptable results. At the end of this procedure, all the metrics for evaluating the kinetic energy and energy balance, and for verifying the quasi-static responses have been investigated. This model (RC1-REF) has been used to validate the response of the first strengthening connection (RC1-CFRP). Finally, the calibrated model was used in the validation/verification of the two others strengthening connections (RC1-CFRP-Ali38-At, RC1-CFRP-ALc38-At) using Explicit Dynamic Analysis. These results are compared against the previous experimental results. As a result, the validation of the numerical simulation is based on the measured behavior of two (2) half-scale reinforced concrete wall slab connection, without and with the FRP strips, while the accuracy of this model was verified with two (2) full-scale reinforced concrete wall slab connection that employed more complicated strengthening solutions with FRP strips.

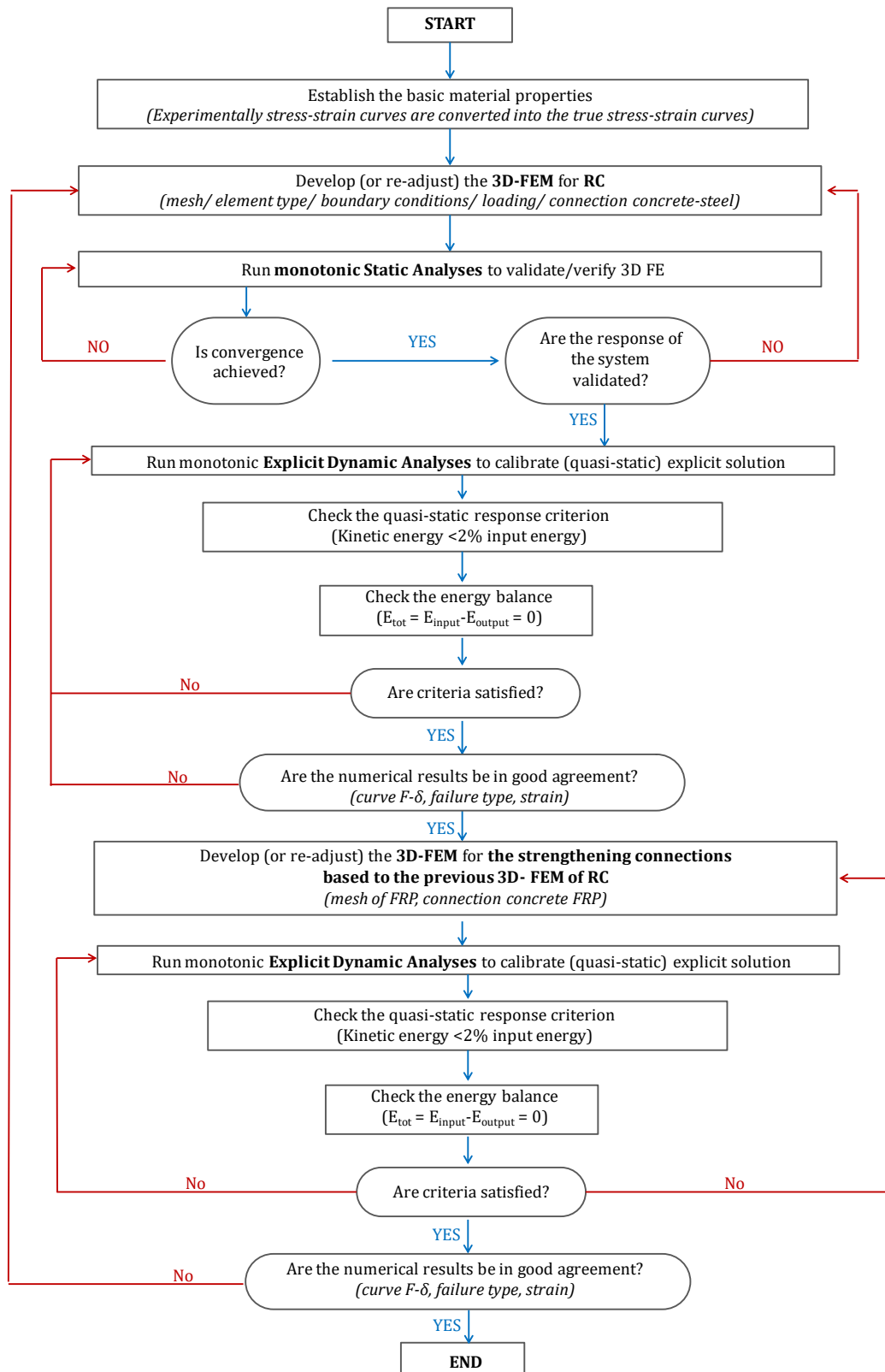

Figure 6 - Proposed Cyclic Explicit Dynamic (CED) analysis procedure for validate the response of the RC wall/slab connections

5 Results and discussion

5.1. Moment rotation curves

The moment rotation curves for the four investigated connection types, both numerical and experimental, is presented in Figure 7. The FEM predicted values for the moment and rotation are in very good agreement with the corresponding experimental ones. The comparisons between the FEM analyses and the experiments show that the proposed FEM model is capable of reproducing the inelastic response of the RC wall/slab connection. Therefore, it is a reliable tool for the simulation of the hysteretic behavior of the RC wall/slab connection and the strengthening solutions with FRP and can be used in further studies in order to investigate the effect of various parameters.

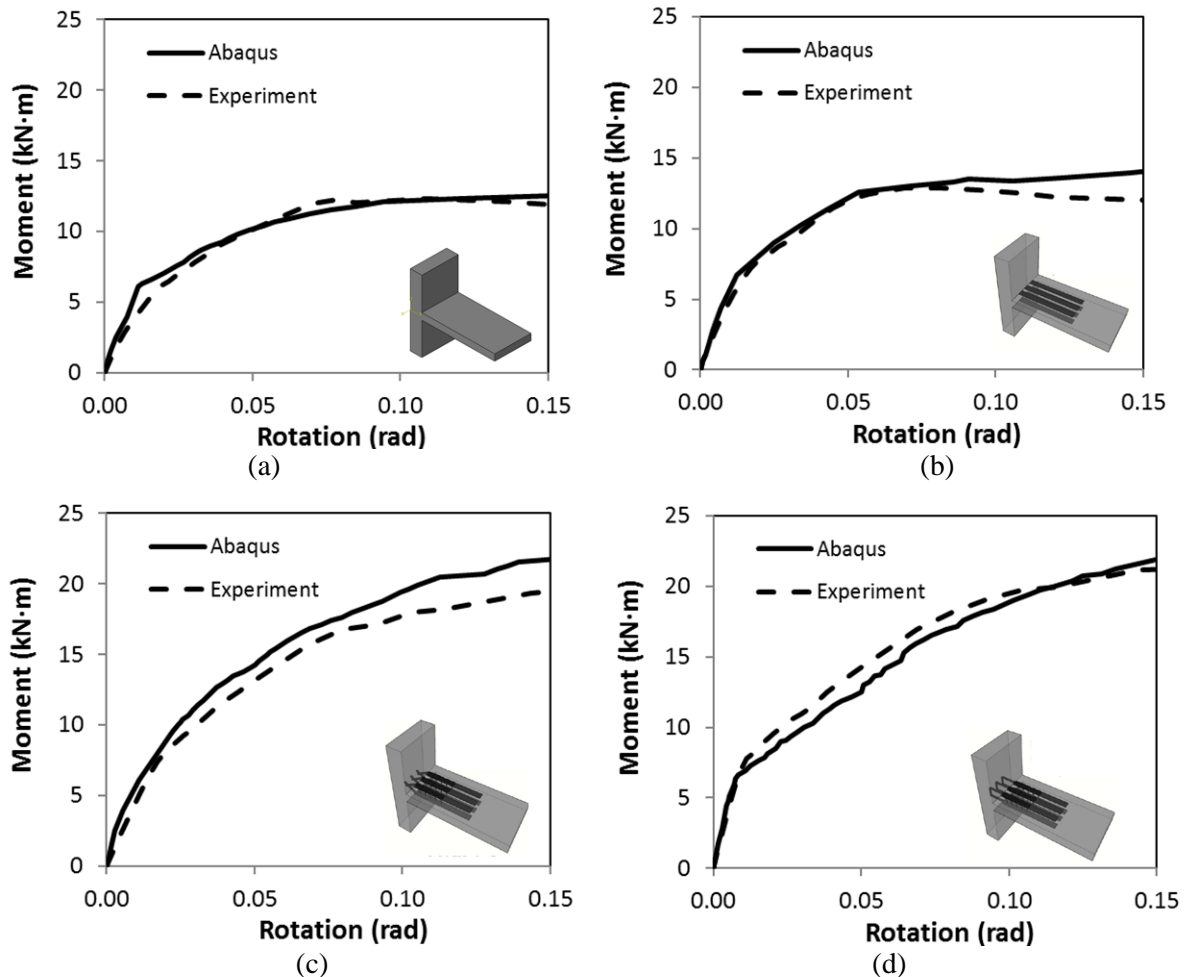

Figure 7- Numerical vs experimental load displacement curves, (a) RC1-REF, (b) RC1-CFRP, (c) RC1-CFRP-Ali38-At, (d) RC1-CFRP-ALc38-At

5.2. Failure mode

In Figure 8 the experimental and numerical deformation and crack pattern for the wall/slab connection after the failure are presented. The results of numerical analysis were compared with the quasi-static performance of the tested wall-slab connection RC1-REF and its crack pattern. In summary, the modes of real failure and FE model are similar and the quality of the results is satisfactory.

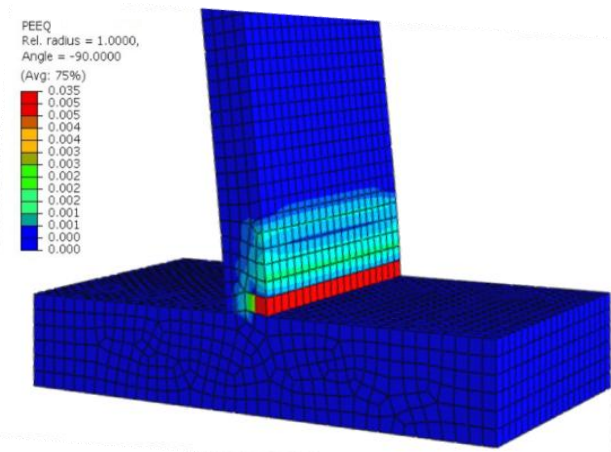

Figure 8 - Experimental and numerical deformation and crack pattern for specimen RC1-REF

5.3. Strain

In this section, the evolution of strain in steel rebars and FRP sheets in comparison with the load curves, for both experimental and numerical results, is illustrated. The position of each gauge was presented in the Section 3 (see Figure 2). Figure 9a shows the deformation of the longitudinal rebars in the slab of the specimen RC1-REF, while Figure 9b the deformation of the longitudinal rebars in the wall of the specimen RC1-REF.

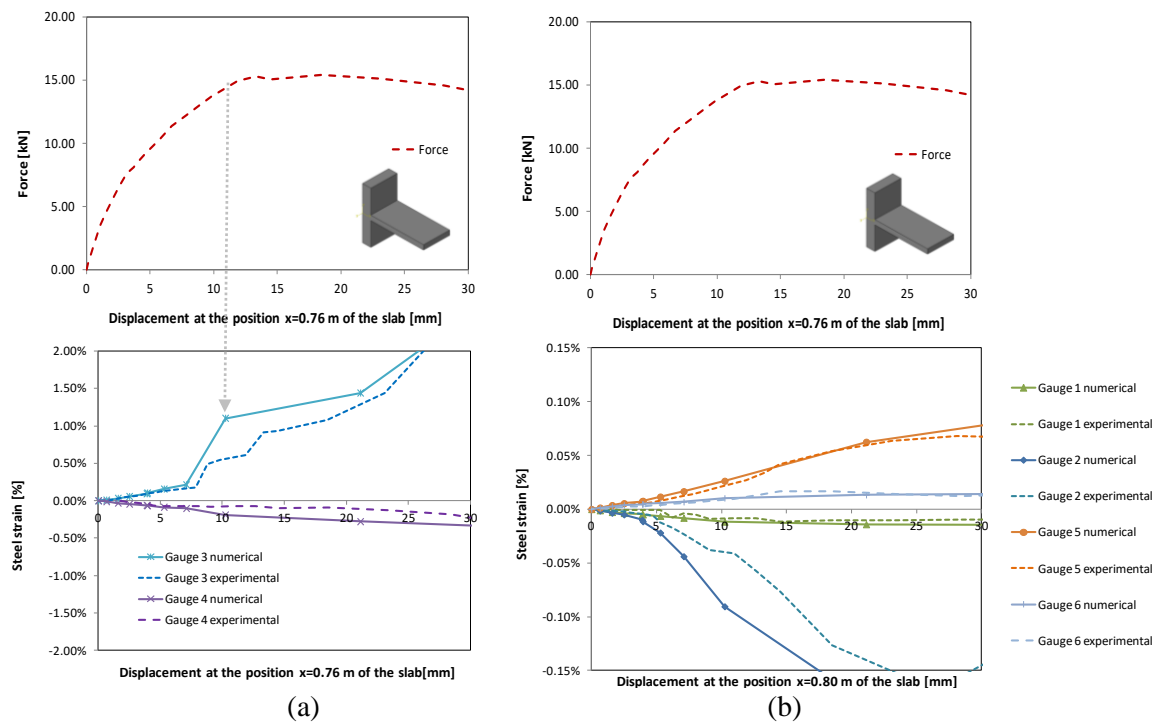

Figure 9- Experimental and numerical strain for specimen RC1-REF

Figure 10a shows the deformation of the longitudinal rebars in the slab of the specimen RC1-CFRP-ALc38-At, Figure 10c the deformation of the longitudinal rebars in the wall of the same specimen, while Figure 10e the deformation of the FRP sheets. In addition, Figure 10b shows the deformation of the longitudinal rebars in the slab of the specimen RC1-CFRP-Ali38-At, Figure 10d the deformation of the longitudinal rebars in the wall of the same specimen, while Figure 10f the deformation of the FRP sheets. We can notice that the FEM

predicted values for the deformation are in very good agreement with the corresponding experimental ones.

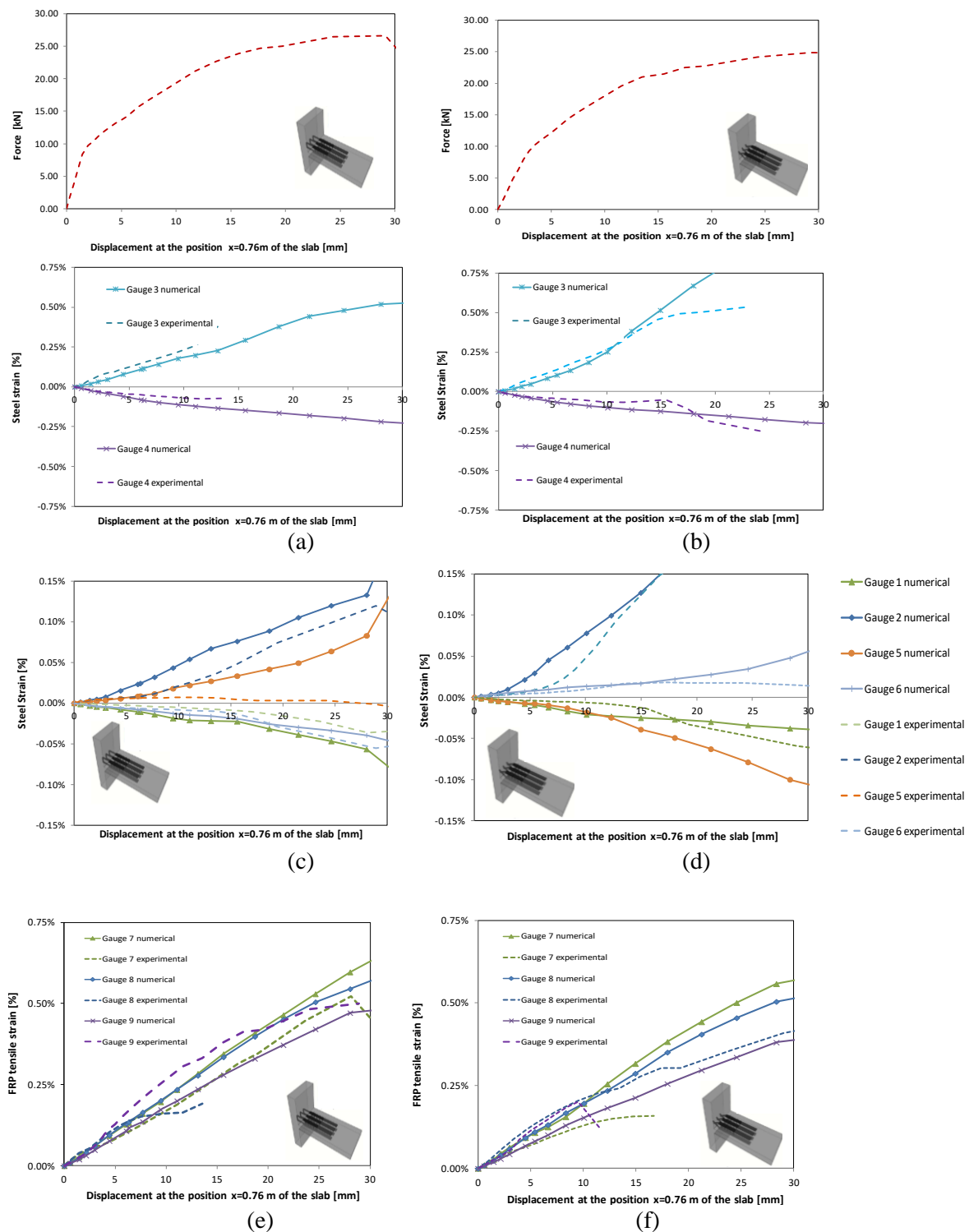

Figure 10 - Comparison of experimental and numerical strain (Steel and FRP) for the RC1-CFRP-ALc38-At and RC1-CFRP-Ali38-At wall/slab connections

The success of the deployed numerical simulation is fully demonstrated by comparing the shape of the moment-rotation curves, the failure mode and the stain of the steel rebars with the experimental ones. From the above, it must be seen that the accurate numerical prediction of the behaviour is the result of all these features that were built into the numerical model

together with the accurate representation of all the individual material features which were established by careful testing prior to the numerical simulation. The successful FE models, accurately capturing the basic structural response in terms of ultimate load and moment, failure modes and overall load–displacement response, have been developed and discussed.

6 Conclusions

The mechanical behavior of RC wall/slab connections by using Carbon Fiber Reinforced Polymers, was experimentally investigated and developed in the Laboratory of Composite Materials for the constructions at the University Claude Bernard Lyon 1 [Chalot et al, 2018; Titirla et al, 2019b]. The aim of the current study was to create a reliable numerical model to access the mechanical response of the investigated joints. Based on the findings of the present investigation, we are able to draw the following conclusions:

1. The successful numerical simulation of the strengthening RC wall slab connections with FRP sheets, which enhances the efficiency of these FRP sheets applied in the joint (RC1-CFRP-ALc38-At and RC1-CFRP-Ali38-At), was demonstrated by this study.
2. The success of the deployed numerical simulation is fully demonstrated by comparing the shape of the moment-rotation curves, the failure mode and the stain of the steel rebars with the experimental ones.
3. From the above, it must be seen that the accurate numerical prediction of the behaviour is the result of all these features that were built into the numerical model together with the accurate representation of all the individual material features which were established by careful testing prior to the numerical simulation. The successful FE models, accurately capturing the basic structural response in terms of ultimate load and moment, failure modes and overall load–displacement response, have been developed and discussed.
4. Based on the validated FE numerical models presented here, further research is underway to identify the key features affecting overall structural response and thus to optimize the structural arrangement of the investigated novel anchoring method (RC1-CFRP-ALc38-At and RC1-CFRP-Ali38-At) in terms of strength and ductility.

A further goal is to use the proposed FE model in further studies in order to investigate the effect of various parameters to a larger scale such a RC-frame. In order to complete this study, a more in-depth study of the mechanical behavior of the longitudinal anchors may be carried out, by quantifying precisely the effect of the number of threads and the angle of the anchor. Finally, it could be possible to investigate the dynamic response of these wall/slab connections.

7 Acknowledgements

The authors would like to acknowledge the French National Research agency ANR project ‘ILISBAR’ for funding the present study. The authors also thank the staff members of the Laboratory of Composite Materials for Construction LMC2 (E. Janin and N. Cottet) for their technical support.

References

- Akguzel, U., Pampanin, S. (2012). Assessment and Design Procedure for the Seismic Retrofit of Reinforced Concrete Beam-Column Joints using FRP Composite Materials. *Journal of Composites for Construction*,16:21–34.
- Alfarah, B., López-Almansa, F., Oller, S. (2017). New methodology for calculating damage variables evolution in Plastic Damage Model for RC structures. *Engineering Structures*,132:70–86.
- Antonopoulos, CP., and Triantafillou, Th. (2003). Experimental Investigation of FRP-Strengthened RC Beam-Column Joints. *Journal of Composites for Construction*, 7:39–49.
- Brownjohn, JMW., Xia, PQ., Hao, H., Xia, Y. (2001). Civil structure condition assessment by FE model updating: methodology and case studies. *Finite Elements in Analysis and Design*,37(10):761-775.
- Chalot, A., Michel, L., Ferrier, E., Caggegi, C., Reboul, N., Grazide, C. (2018). Mechanical characterization of a RC wall-slab joist reinforced by FRP under alternating cyclic loading. CICE 2018, Paris, France.
- Colajanni, P., La Mendola, L., Monaco, A., Pagnotta, S. (2020). Dissipative connections of rc frames with prefabricated steel-trussed-concrete beams. *Ingenieria sismica- International Journal of Earthquake Engineering*.
- Cornelissen, HAW., Hordjik, DA., Reinhardt, HW.(1986). Experimental determination of crack softening characteristics of normal weight and lightweight concrete. *HERON*,31(2):45–66.
- Crisfield, MA., Wills, J. (1988). Solution strategies and softening materials. *Comput Methods Appl Mech Eng*, 66(3):267–89.
- Doudoumis, IN. (2007). Finite element modelling and investigation of the behaviour of elastic infilled frames under monotonic loading. *Eng Struct*,29–6:1004–24.
- Earij, A., Alfano, G., Cashell, K., Zhou, X. (2017). Nonlinear three-dimensional finite-element modelling of reinforced-concrete beams: computational challenges and experimental validation. *Engineering Failure Analysis* 82:92–115.
- El-Amoury, T., Ghobarah, A. (2002). Seismic rehabilitation of beam-column joint using GFRP sheets. *Engineering Structures*,24:1397–407.
- Engindeniz, M., Kahn, LF., Zureick ,AH. (2005). Repair and strengthening of reinforced concrete beam-column joints: state of the art. *ACI Struct J*,2:187–97.
- Esmaeeli, E., Danesh, F., Tee, KF., Eshghi, S. (2017). A combination of GFRP sheets and steel cage for seismic strengthening of shear-deficient corner RC beam-column joints. *Composite Structures*, 159:206–219.
- Ferraioli, M., Di Lauro, G. (2009). Seismic performance of a mixed rc-masonry building strengthened with fiber composites. *Ingenieria Sismica-International Journal of Earthquake Engineering*.
- Hashin, Z. (1983). Analysis of composite materials – a survey. *J Appl Mech, Trans ASME*, 50(3):481–505.
- Karayannis, CG., Sirkelis, GM. (2008). Strengthening and rehabilitation of RC beam column joints using carbon-FRP jacketing and epoxy resin injection. *Earthquake Eng Struct Dynam*,37(5):769–90.
- Krätzig, W.B., Pölling, R. (2004). An elasto-plastic damage model for reinforced concrete with minimum number of material parameters. *Computers & Structures*,82(15):1201–1215.
- Larbi, W., Deü, J-F. (2019). Reduced order finite element formulations for vibration reduction using piezoelectric shunt damping. *Applied Acoustics*,147:111-120.
- Larbi, W., Deü, J-F., Ohayon, R. (2012). Finite element formulation of smart piezoelectric composite plates coupled with acoustic fluid. *Composite Structures*,94(2):501-509.

- Latour, M., Rizzano, G. (2019). A proposal for the design of seismic resistant precast concrete industrial buildings through application of energy dissipaters in the cladding walls. *Ingegneria Sismica - International Journal of Earthquake Engineering*,36(1):86-98.
- Lee, J., Fenves, G.L. (1988). Plastic-Damage Model for Cyclic Loading of Concrete Structures”, in *Journal of Engineering Mechanics*,124 (8):892–900.
- Lee, W.T, Chiou, Y.J, Shih, M.H. (2010). Reinforced concrete beam–column joint strengthened with carbon fiber reinforced polymer. *Composite Structures*,92:48–60.
- Lu, X., Urukup, TH., Li, S., Lin, F. (2012). Seismic behavior of interior RC beam-column joints with additional bars under cyclic loading. *Earthquakes Struct*,3 (1):35–57.
- Ma, C., Wang, D., Wang, Z. (2017). Seismic retrofitting of full-scale RC interior beam-column-slab subassemblies with CFRP wraps. *Composite Structures*,159:397–409.
- Malm, R. (2009). Predicting shear type crack initiation and growth in concrete with non-linear finite element method. PhD thesis, Department of Civil and Architectural Engineering, Royal Institute of Technology (KTH) Stockholm.
- Manos, G.C., Theofanous, M., Katakalos, K. (2014). Numerical simulation of the shear behaviour of reinforced concrete rectangular beam specimens with or without FRP-strip shear reinforcement. *Advances in Engineering Software*,67, 47-56.
- Montuori, R., Nastri, E., Piluso, V. (2016). Modelling of floor joists contribution to the lateral stiffness of RC buildings designed for gravity loads (2016) *Engineering Structures*, 121, pp. 85-96
- Montuori, R., Nastri, E., Palese, M.I., Piluso, V. (2019a). The effect of floor joists on the elastic and inelastic behavior of R.C frames (2019) *Engineering Structures*, 196, art. no. 109267, .
- Montuori, R., Nastri, E., Piluso, V. (2019b). Problems of modeling for the analysis of the seismic vulnerability of existing buildings, *Ingegneria Sismica - International Journal of Earthquake Engineering*,36:53-85.
- Montuori, R., Nastri, E., Palese, M.I., Piluso, V. (2019c) Comparison among different software for the evaluation of moment-curvature of R.C. Columns (2019) *Computers and Concrete*, 24 (3), pp. 259-269.
- Nip, KH., Gardner, L., Elghazouli, AY. (2010). Cyclic testing and numerical modelling of carbon steel and stainless steel tubular bracing members. *Eng Struct*,32(2):424–41.
- Obaidat, YT., Heyden, S., Dahlblom, O. (2010). The effect of CFRP and CFRP/concrete interface models when modeling retrofitted RC beams with FEM. *Compos Struct*,92(6):1931–8.
- Saenz, LP. (1964). Discussion of “equation for the Stress–strain curve for concrete” by Desayi P, Krishnan S. *ACI J*,61:1229–35.
- Simulia. (2012). Analysis user's manual volume IV. Simulia, analysis user's manual. vol.IV. Providence: Dassault Systèmes.
- Soong, TT., Spencer, Jr.BF. (2002). Supplemental energy dissipation: state-of-the-art and state-of-the-practice. *Eng Struct*,24:243–59.
- Symans, MD., Charney, FA., Whittaker, AS., Constantinou, MC., Kircher, CA., Johnson, MW.(2008). Energy dissipation systems for seismic applications: current practice and recent developments. *J Struct Eng*,134(3–1).
- Titirla, M.D., and Papadopoulos P. (2015). Finite element investigation of a new seismic energy absorption device through simultaneously yield and friction. *COMPADYN 2015*. In: 5th ECCOMAS thematic conference on computational methods in structural dynamics and earthquake engineering, Crete Island, Greece; May 2015.

- Titirla, M., Katalalos, K., Zuccaro, G., Frabbrocino, F. (2017). On the mechanical response of an innovative energy dissipation device. *Ingegneria Sismica - International Journal of Earthquake Engineering*,2:126-138.
- Titirla, M., Michel, L., Ferrier, E. (2018a). Mechanical behavior of hybrid floor panels to timber columns joints. 9th International Conference on Fibre-Reinforced Polymer (FRP) Composites in Civil Engineering (CICE 2018), Paris, France.
- Titirla, M., Papadopoulos, P., Doudoumis, I. (2018b). Finite element modelling of an innovative passive energy dissipation device for seismic hazard mitigation. *Engineering Structures*,168:218-228.
- Titirla, M., Michel, L., Ferrier, E. (2019a). Innovative connections between hybrid floor panels and timber columns able to reduce the deflection of the panel's big span. Proceedings of the 7th International Conference on Computational Methods in Structural Dynamics and Earthquake Engineering, COMPDYN 2019. Hersonissos, Crete, Greece.
- Titirla, M., Chalot, A., Michel, L., Ferrier, E. (2019b). Finite element modelling of RC wall/slab connections reinforced by using carbon fiber reinforced polymers. Proceedings of the 7th International Conference on Computational Methods in Structural Dynamics and Earthquake Engineering, COMPDYN 2019. Hersonissos, Crete, Greece.
- Tsonos, A-DG., Tegos, IA., Penelis, GG.(1992). Seismic resistance of type 2 exterior beam column joints reinforced with inclined bars. *ACI Structural Journal*,89(1):307–30.