

ABCD asymptotic expansion for lattice Boltzmann schemes and application to compressible Navier Stokes equations

François Dubois*

Colloque des sciences mathématiques du Québec
Friday 19 March 2021

* Conservatoire National des Arts et Métiers, Paris
en délégation CNRS au Centre de recherches mathématiques,
Université de Montréal

Kármán vortices behind a cylinder

2

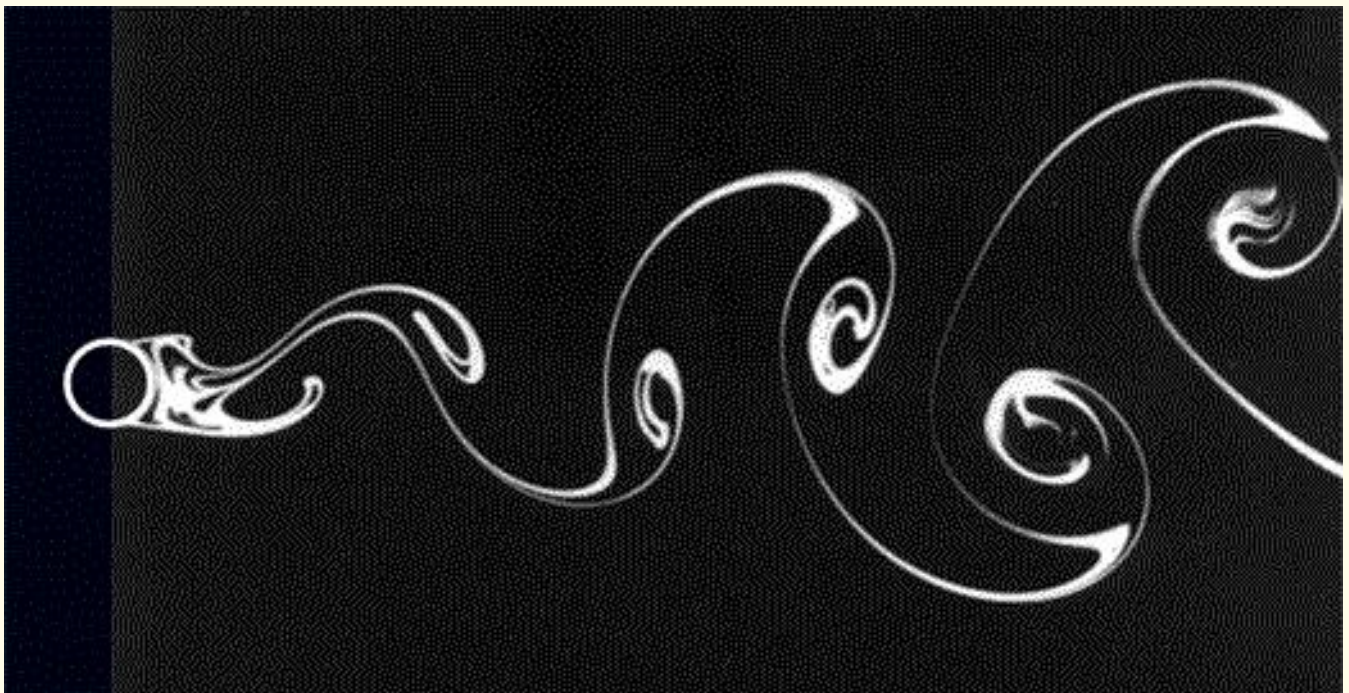

Milton Van Dyke (1922 - 2010)

An album of fluid motion, 1982

Wing tip vortex



Boeing 777

eltamiz.com

Kármán vortices induced by Capo Verde islands

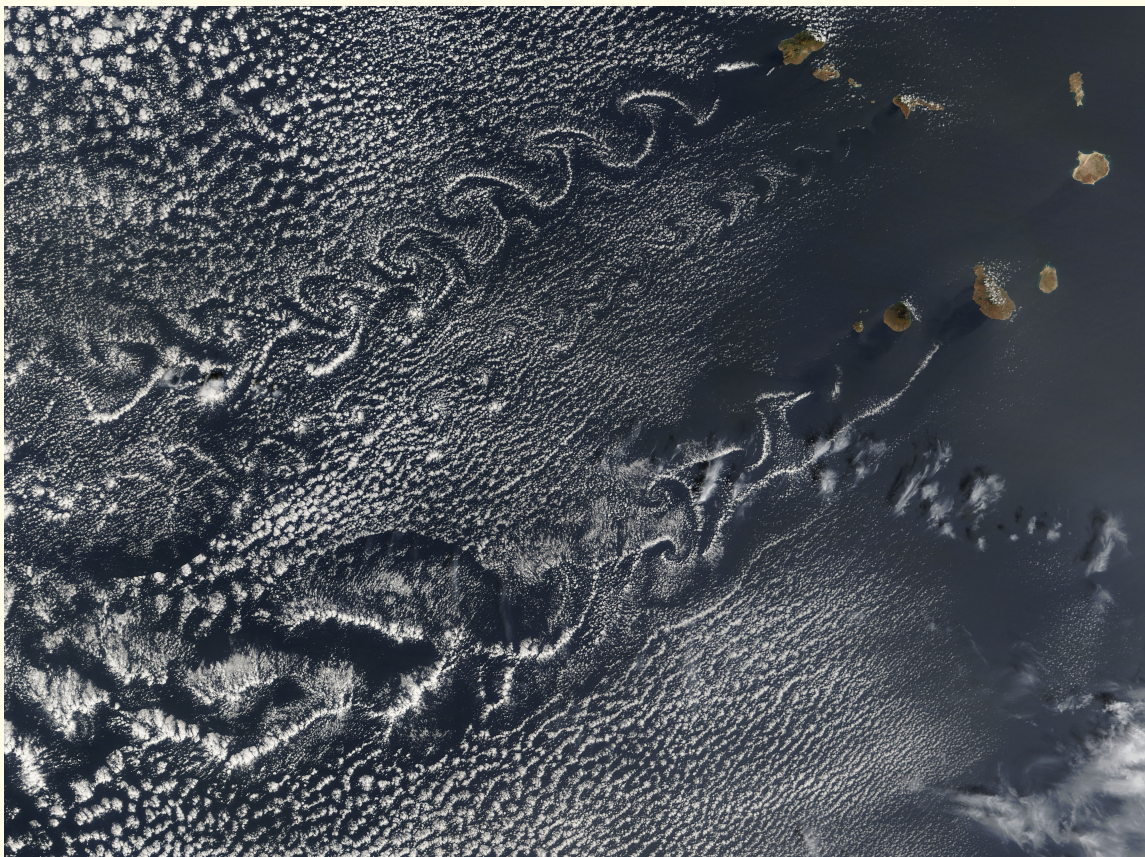

january 2005

visibleearth.nasa.gov

Very perturbed Kármán vortex street

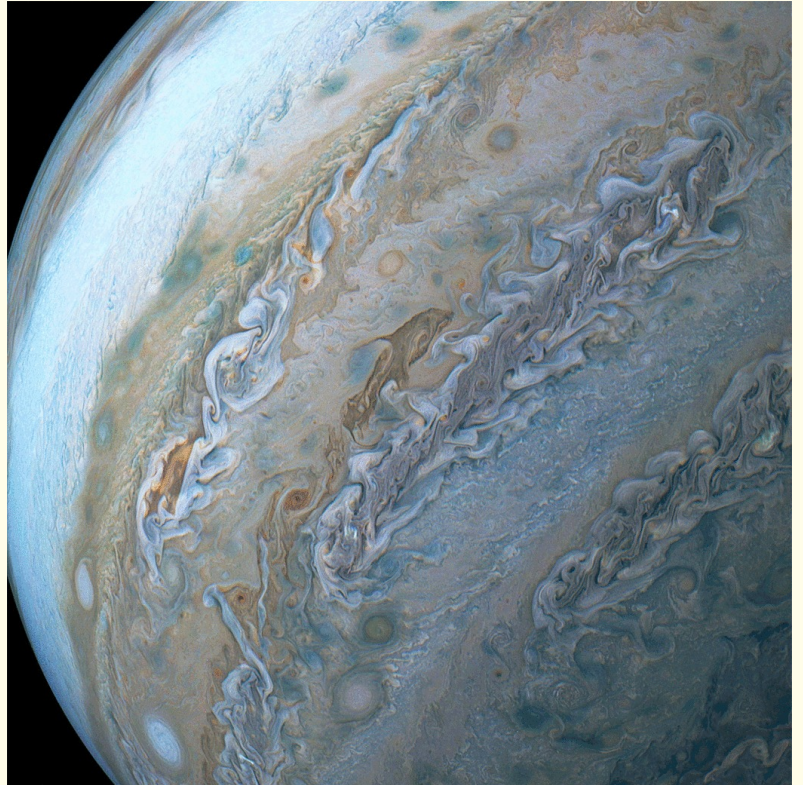
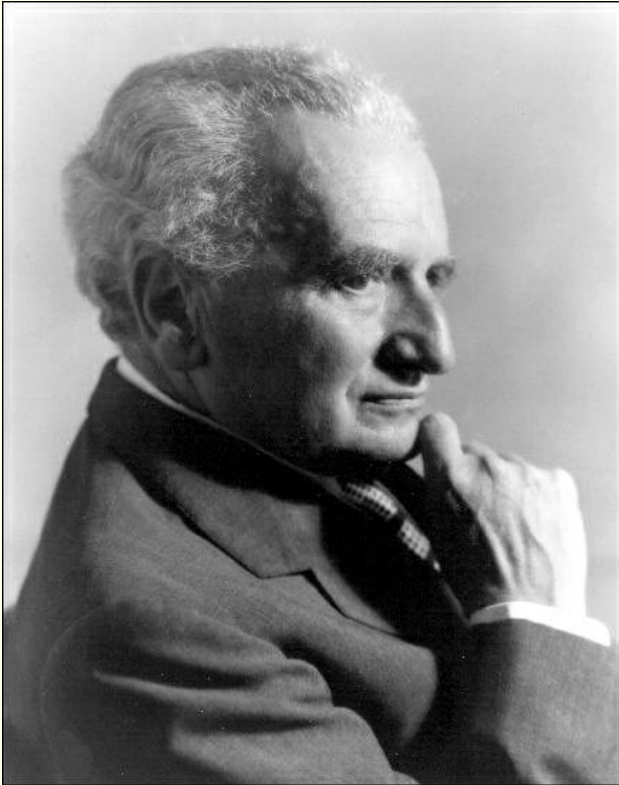

Théodore von Kármán (1881 - 1963)
allanellenberger.com

Jupiter, Juno space probe, 2018
nasa.gov

Fluid vortices by Leonardo da Vinci (1452 - 1519)



Windsor Castle, Royal Library, RL 12660v

Pressure and discovery of vacuum

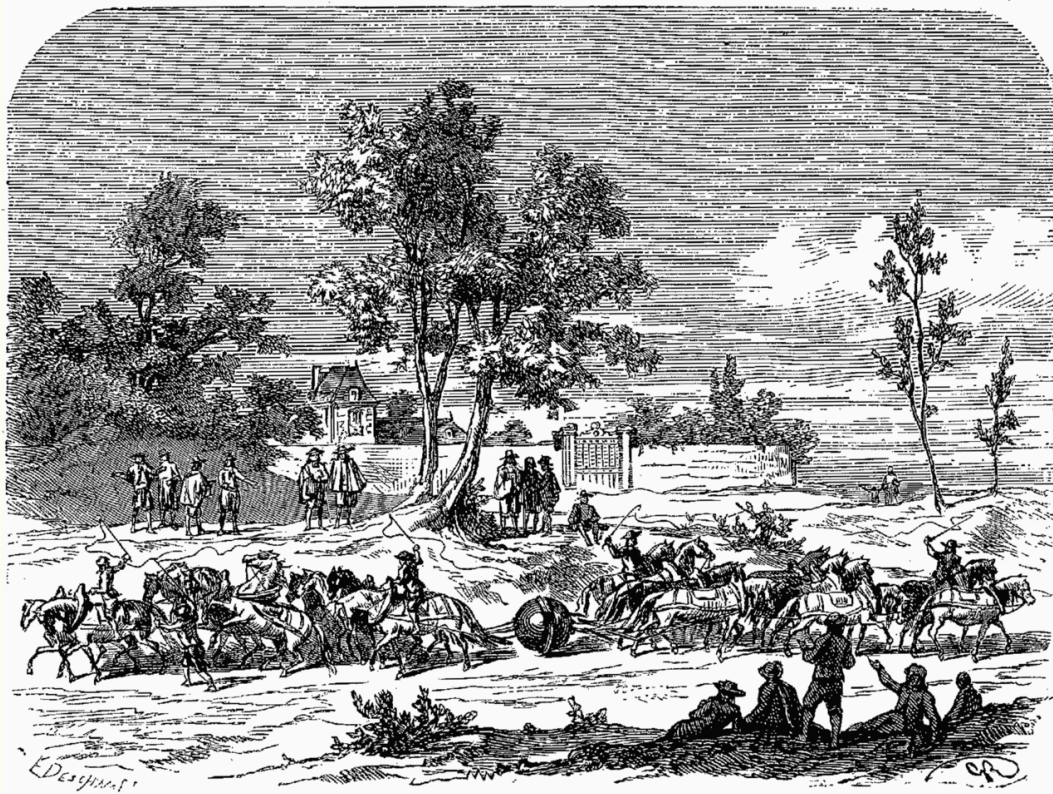

Blaise Pascal (1623 - 1662)

Magdeburg hemispheres (1654)
[wikimedia.org](https://www.wikimedia.org)

Conservation of energy

$$\frac{1}{2} |u|^2 + g z + \frac{p}{\rho} = \text{constante}$$



Daniel Bernoulli (1700 - 1782)

[wikipedia](https://www.wikipedia.org)

Perfect fluid equations

$$\frac{\partial W_k}{\partial t} + \sum_{\alpha} \frac{\partial}{\partial x_{\alpha}} [F_k^{\alpha}(W)] = 0$$



Leonhard Euler (1707 - 1783)

wikipedia

Paradox about the existence of lift and drag



Jean Le Rond d'Alembert (1717 - 1783)

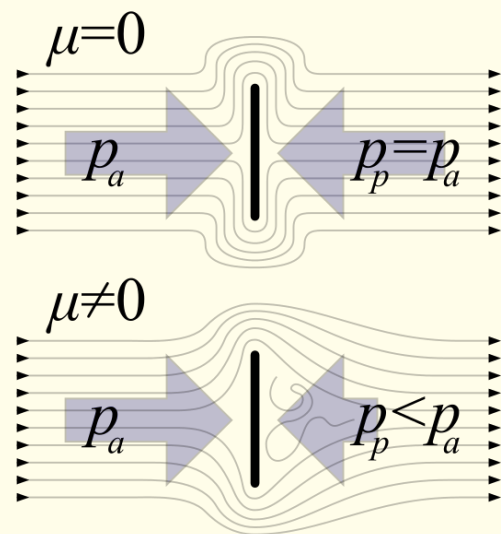

wikipedia

Navier - Stokes equations (1830)

$$\frac{\partial W_k}{\partial t} + \sum_{\alpha} \frac{\partial}{\partial x_{\alpha}} [F_k^{\alpha}(W) + G_k^{\alpha}(W, \nabla W)] = 0$$

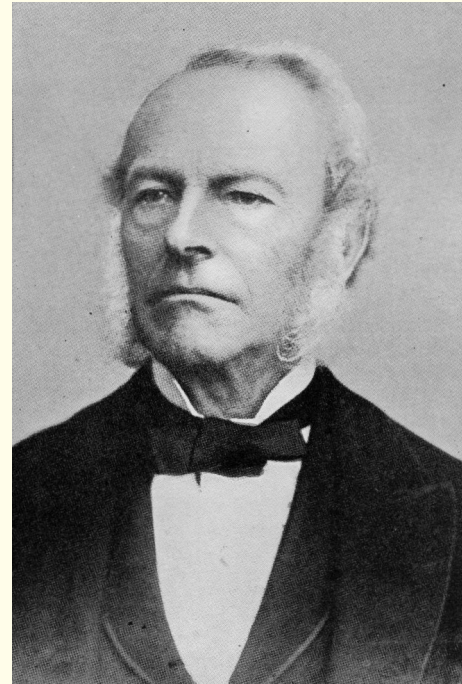

wikipedia

Claude Henri Navier
(1785 - 1836)

wikipedia

George Stokes
(1819 - 1903)

Boundary layer (1904)

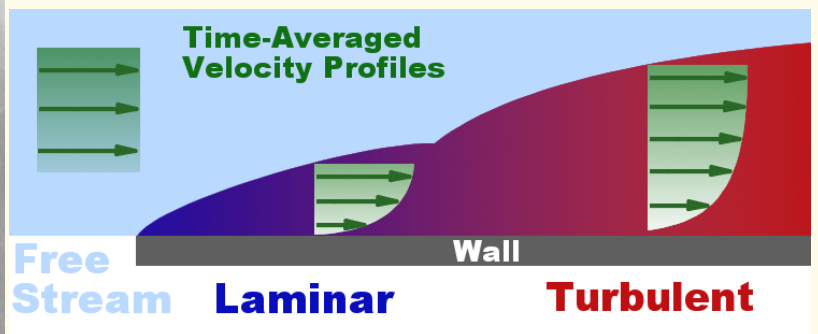

wikipedia

Ludwig Prandtl (1875 - 1953)

Maxwell - Boltzmann equilibrium (1872)

13

velocity distribution at thermodynamic equilibrium

$$f^{\text{eq}}(\mathbf{v}) = \rho \left(\frac{\beta}{2\pi} \right)^{\frac{3}{2}} \exp \left(- \frac{\beta}{2} |\mathbf{v} - \mathbf{u}|^2 \right), \quad \beta = \frac{1}{k_B T}$$

the **temperature T** is a parameter

to describe the **variance** of the velocity distribution

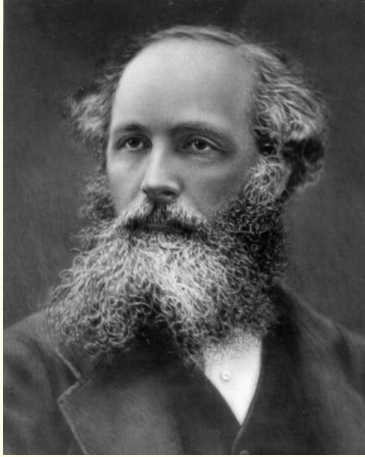

James Clerk Maxwell
(1831 - 1879)

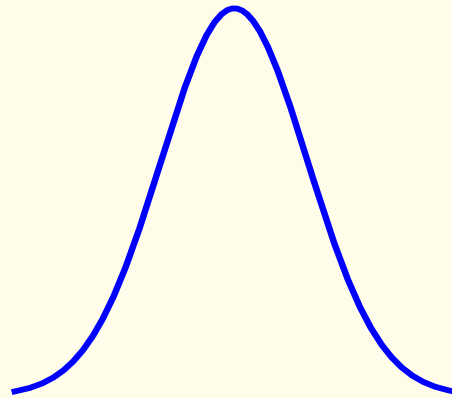

Carl Friedrich Gauss
(1777 - 1855)

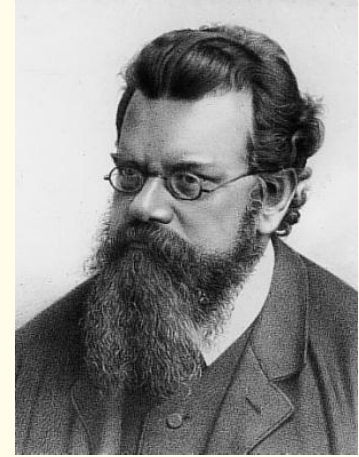

Ludwig Boltzmann
(1844 - 1906)

Outlook

14

Boltzmann equation

Discrete velocities ; Chapman-Enskog expansion ; D1Q3 example

Lattice gas cellular automata

Lattice Boltzmann scheme

Collide-stream ; Boundary conditions ; Applications

Asymptotic analysis

Taylor vs. exponential ; Discrete "ABDC" at fourth order

Isothermal Navier-Stokes

D2Q9, D2Q13, D3Q19, D3Q27, D3Q33 and D3Q27-2

Navier-Stokes with energy conservation

D2Q13, D2Q17, D2V17, D3Q33 and D3Q27-2

Conclusion

Boltzmann equation (1872)

15

Kinetic theory of gases of Maxwell and Boltzmann

At position x up to the infinitesimal dx ,

and for a velocity v up to dv , $dm = f(v) dx dv$

the gas mass dm is described by a distribution f :

$$dm = f(t, x, v) dx dv$$

$f(t, x, v)$: velocity distribution

Time evolution : Boltzmann equation

$$\frac{\partial f}{\partial t} + v \cdot \nabla_x f = Q(f), \quad x \in \mathbb{R}^3, \quad v \in \mathbb{R}^3, \quad t > 0$$

First moments of the distribution f

$$\rho = \int_{\mathbb{R}^3} f(v) dv, \quad \rho u = \int_{\mathbb{R}^3} v f(v) dv, \quad \rho E = \int_{\mathbb{R}^3} \frac{1}{2} |v|^2 f(v) dv$$

Boltzmann equation : advection and collision

16

$$\frac{\partial f}{\partial t} + v \cdot \nabla_x f = Q(f)$$

free advection with velocity v

left hand side $\frac{\partial f}{\partial t} + v \cdot \nabla_x f$

collisions inside the gas

right hand side $Q(f)$

dilute gas: "two-point" collisions

$Q(f)$ is a quadratic function of the distribution f

Analysis of microscopic collisions:

conservation of mass, momentum and energy

$$\text{mesoscopic consequence: } \int_{\mathbb{R}^3} Q(f) \left(1, v, \frac{1}{2} |v|^2\right)^t dv = 0$$

Consider this hypothesis inside the Boltzmann equation:

the "conserved" quantities $W = (\rho, \rho u_\alpha, \rho E)^t$

satisfy conservation law

$$\frac{\partial W_k}{\partial t} + \sum_\alpha \frac{\partial}{\partial x_\alpha} (F_k^\alpha(f)) = 0$$

Chapman - Enskog expansion (1915)

$$f(v) = f^{eq}(v) + \varepsilon f^1(v) + \dots$$

formal derivation of the Navier-Stokes equations



Sydney Chapman
(1888 - 1970)

www.npg.org.uk

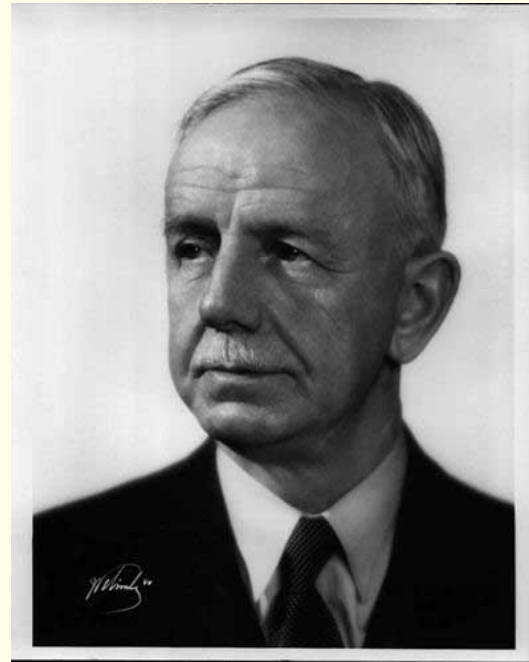

David Enskog
(1884 - 1947)

www.mech.kth.se

"BGK" approximation (1954)

$$\frac{\partial f}{\partial t} + v \cdot \nabla_x f = -\frac{1}{\tau} (f - f^{eq})$$

collision time $\tau \approx \varepsilon$



Prabhu Lal Bhatnagar
(1912 - 1976)

math.iisc.ernet.in



Eugene Gross
(1926 - 1991)

alchetron.com



Max Krook
(1913 - 1985)

[wikipedia](https://en.wikipedia.org/wiki/Max_Krook)

Discrete velocities (1957)

$$\frac{\partial u}{\partial t} + \frac{\partial u}{\partial x} = v^2 - u^2, \quad \frac{\partial v}{\partial t} - \frac{\partial v}{\partial x} = u^2 - v^2$$

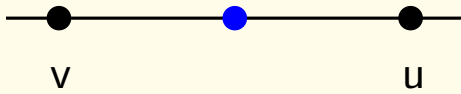

ro.wikipedia.org

Torsten Carleman (1892-1949)

Problèmes mathématiques dans la théorie cinétique des gaz

Mittag-Leffler Institute, Stockholm, 1957

Discrete velocities (1964, 1969)

$$\frac{\partial f_i}{\partial t} + v_i \cdot \nabla_x f_i = Q_i(f_0, f_1, \dots, f_{q-1}), \quad 0 \leq i < q$$



James Broadwell
(1921-2018)

www.nae.edu



Renée Gatignol
(born in 1939)



Henri Cabannes
(1923 - 2016)

ljll.math.upmc.fr

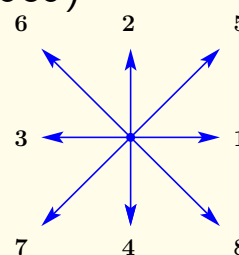
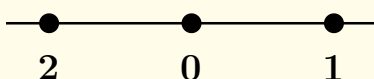

Moments

21

$$\frac{\partial f_i}{\partial t} + v_i \cdot \nabla_x f_i = \frac{1}{\varepsilon} Q_i(f), \quad 0 \leq i < q$$

$m = M f$: vector of moments $m \in \mathbb{R}^q$:

constant invertible matrix M ("d'Humières matrix", 1992)

$$m_k \equiv \sum_{0 \leq j < q} M_{kj} f_j, \quad 0 \leq k < q$$

N conservation laws ($1 \leq N < q$)

the N first moments of the collision kernel are equal to zero:

$$\sum_{0 \leq j < q} M_{kj} Q_j(f) = 0, \quad \forall f \in \mathbb{R}^q, \quad 0 \leq k < N$$

divide the vector of moments into two families: $m \equiv \begin{pmatrix} W \\ Y \end{pmatrix}$

N conservation laws for **macroscopic** variables W

$$\frac{\partial W_k}{\partial t} + \sum_{1 \leq \alpha \leq d} \sum_{0 \leq j < q} M_{kj} v_j^\alpha \frac{\partial f_j}{\partial x_\alpha} = 0, \quad 0 \leq k < N$$

$q - N$ nonconserved moments or **microscopic** variables Y

Equilibrium states

22

equilibrium states f^{eq} defined by the conditions $Q(f^{\text{eq}}) = 0$

characterized with a regular vector field $\Phi : \mathbb{R}^N \rightarrow \mathbb{R}^{q-N}$

$$f^{\text{eq}} = M^{-1} \begin{pmatrix} W \\ \Phi(W) \end{pmatrix}$$

the vector field $W \mapsto Y^{\text{eq}} \equiv \Phi(W)$ defines the equilibrium states

hypothesis: the jacobian matrix $dQ(f^{\text{eq}})$ at equilibrium

is **diagonalizable with real eigenvalues and real eigenvectors**

there exists a diagonal matrix $Z = \text{diag} \left(\frac{1}{\tau_1}, \dots, \frac{1}{\tau_{q-N}} \right)$
of order $q - N$, $\tau_\ell > 0$ such that

$$M dQ(f^{\text{eq}}) M^{-1} = - \begin{pmatrix} 0 & 0 \\ 0 & Z \end{pmatrix}$$

the jacobian operator $dQ(f^{\text{eq}})$

admits the matrix M^{-1} as a matrix of eigenvectors

the associated eigenvalues are all non positive

Momentum-velocity operator

23

momentum-velocity operator matrix

$$\Lambda = M \operatorname{diag} \left(\sum_{1 \leq \alpha \leq d} v^\alpha \partial_\alpha \right) M^{-1}$$

$q \times q$ operator matrix

composed by first-order space differential operators

advection operator seen in the space of moments

block decomposition of the momentum-velocity operator matrix

associated to the decomposition $m = \begin{pmatrix} W \\ Y \end{pmatrix}$

$$\Lambda \equiv \begin{pmatrix} A & B \\ C & D \end{pmatrix}$$

A : $N \times N$ first order space operator matrix

B : $N \times (q - N)$ first order space operator

C : $(q - N) \times N$ first order space operator

D : $(q - N) \times (q - N)$ first order operator

Boltzmann-BGK system with discrete velocities

24

Bhatnagar-Gross-Krook type hypothesis

the state f is close to equilibrium f^{eq}

collision kernel Q approximated by its first order

expansion around the equilibrium state:

$$Q(f) \simeq Q(f^{\text{eq}}) + dQ(f^{\text{eq}}).(f - f^{\text{eq}})$$

condition $Q(f^{\text{eq}}) = 0$

Boltzmann-BGK system with discrete velocities

$$\frac{\partial f_j}{\partial t} + \sum_{1 \leq \alpha \leq d} v_j^\alpha \frac{\partial f_j}{\partial x_\alpha} = \frac{1}{\varepsilon} dQ_j(f^{\text{eq}}).(f - f^{\text{eq}}), \quad 0 \leq j < q$$

f^{eq} is a function of the particle distribution f

$$W_k \equiv \sum_{0 \leq j < q} M_{kj} f_j, \quad 0 \leq k < N, \quad f^{\text{eq}} = M^{-1} \begin{pmatrix} W \\ \Phi(W) \end{pmatrix}$$

system of two coupled partial differential equations

$$\frac{\partial W}{\partial t} + A W + B Y = 0$$

$$\frac{\partial Y}{\partial t} + C W + D Y = -\frac{1}{\varepsilon} Z (Y - \Phi(W))$$

Chapman-Enskog expansion

$$\begin{aligned} \frac{\partial W}{\partial t} + A W + B Y &= 0 \\ \frac{\partial Y}{\partial t} + C W + D Y &= -\frac{1}{\varepsilon} Z (Y - \Phi(W)) \end{aligned}$$

As ε tends to zero,

the conserved moments W satisfy the asymptotic system of partial differential equations

$$\frac{\partial W}{\partial t} + \Gamma_1(W) + \varepsilon \Gamma_2(W) = O(\varepsilon^2)$$

the microscopic moments Y

can be expanded around the equilibrium

$$Y = \Phi(W) + \varepsilon Z^{-1} \Psi_1(W) + O(\varepsilon^2)$$

interlaced relations

$$\Gamma_1(W) = A W + B \Phi(W)$$

$$\Psi_1(W) = d\Phi(W) \cdot \Gamma_1(W) - (C W + D \Phi(W))$$

$$\Gamma_2(W) = B Z^{-1} \Psi_1(W), \quad (Z^{-1})_j = \tau_j$$

reformulation of a classical expansion
see e.g. Gatignol (1975)

D1Q3

scale velocity $\lambda > 0$

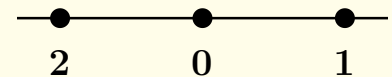

conserved moments W

density $\rho = f_0 + f_1 + f_2$

momentum $J = \lambda f_1 - \lambda f_2 \equiv \rho u$

non conserved moment Y

energy $e = \lambda^2 (-2 f_0 + f_1 + f_2)$

matrix M such that $m \equiv M f$: $M = \begin{pmatrix} 1 & 1 & 1 \\ 0 & \lambda & -\lambda \\ -2\lambda^2 & \lambda^2 & \lambda^2 \end{pmatrix}$

momentum-velocity operator matrix matrix

$$\Lambda = M \begin{pmatrix} 0 & 0 & 0 \\ 0 & \partial_x & 0 \\ 0 & 0 & -\partial_x \end{pmatrix} M^{-1} = \begin{pmatrix} 0 & \partial_x & 0 \\ \frac{2}{3} \lambda^2 \partial_x & 0 & \frac{1}{3} \partial_x \\ 0 & \lambda^2 \partial_x & 0 \end{pmatrix}$$

D1Q3 (ii)

27

$$W = (\rho, \rho u)^t, \quad Y = e$$

equilibrium value of the non conserved moment

$$e^{eq} = \Phi(W) = 3 \rho u^2 + \rho \lambda^2 \alpha$$

$$\Gamma_1 = A W + B \Phi = \begin{pmatrix} \partial_x(\rho u) \\ \partial_x(\rho u^2 + \frac{\lambda^2}{3}(\alpha + 2)\rho) \end{pmatrix}$$

Euler equations !

$$\partial_t \rho + \partial_x(\rho u) = O(\varepsilon)$$

$$\partial_x(\rho u) + \partial_x(\rho u^2 + p) = O(\varepsilon)$$

$$\text{pressure law : } p = \frac{\lambda^2}{3}(\alpha + 2)\rho$$

$$\text{sound velocity } c_0 = \lambda \sqrt{\frac{\alpha+2}{3}}$$

$$\begin{aligned} \Psi_1(W) &= d\Phi(W) \cdot \Gamma_1(W) - (C W + D \Phi(W)) \\ &= -(1 - \alpha) \rho \lambda^2 \partial_x u + 3 u [(u^2 + (1 + \alpha) \lambda^2) \partial_x \rho + 3 \rho u \partial_x u] \end{aligned}$$

D1Q3 (iii)

28

$$\Psi_1(W) = -(1 - \alpha) \rho \lambda^2 \partial_x u + 3 u [(u^2 + (1 + \alpha) \lambda^2) \partial_x \rho + 3 \rho u \partial_x u]$$

$$\Gamma_2(W) = B Z^{-1} \Psi_1(W), \quad Z^{-1} = \tau, \quad B = \begin{pmatrix} 0 \\ \frac{1}{3} \partial_x \end{pmatrix}$$

$$\Gamma_2(W) = \begin{pmatrix} 0 \\ \frac{1}{\tau} \partial_x \psi_1 \end{pmatrix} = \begin{pmatrix} 0 \\ \tau \partial_x [\frac{1-\alpha}{3} \rho \lambda^2 \partial_x u + R_x] \end{pmatrix}$$

$$\text{discrepancy } R_x = u [(u^2 + (1 + \alpha) \lambda^2) \partial_x \rho + 3 \rho u \partial_x u]$$

Navier-Stokes equations

$$\partial_t \rho + \partial_x(\rho u) = O(\varepsilon^2)$$

$$\partial_x(\rho u) + \partial_x(\rho u^2 + p) - \varepsilon \partial_x [\mu \partial_x u] = O(\varepsilon^2) + \varepsilon \tau \partial_x R_x$$

$$\text{viscosity } \mu = \frac{1-\alpha}{3} \rho \lambda^2 \tau$$

Computers and molecular physics (1970's)

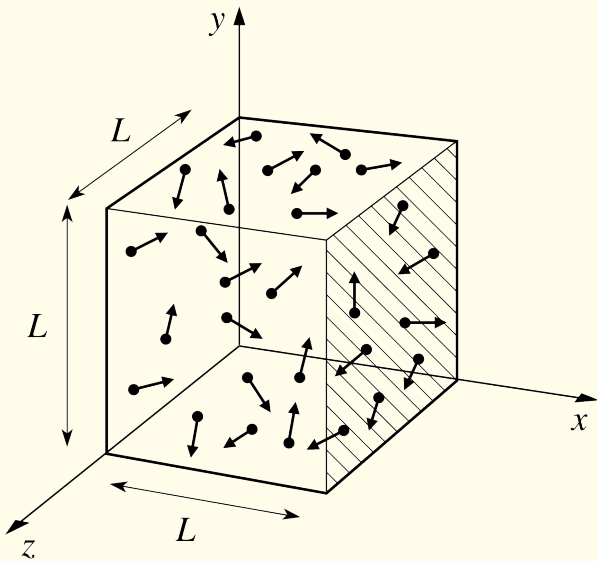

socratic-org.png



wikipedia

doing Physics directly with bits ?

Lattice gas cellular automata

first idea (Jean Hardy, Yves Pomeau, Olivier de Pazzis, 1973)

two space dimensions **square lattice**

evolution of the lattice field: follow the velocity field!

boolean variables

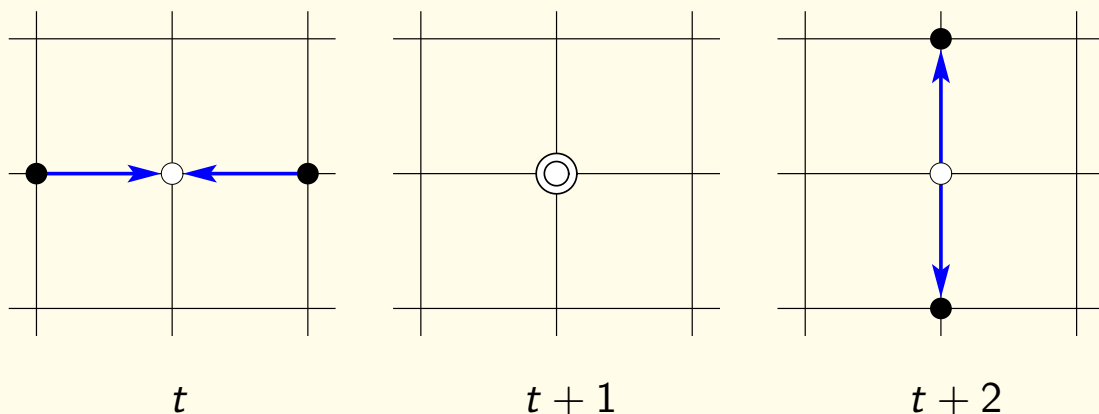

discrete dynamics of a frontal collision

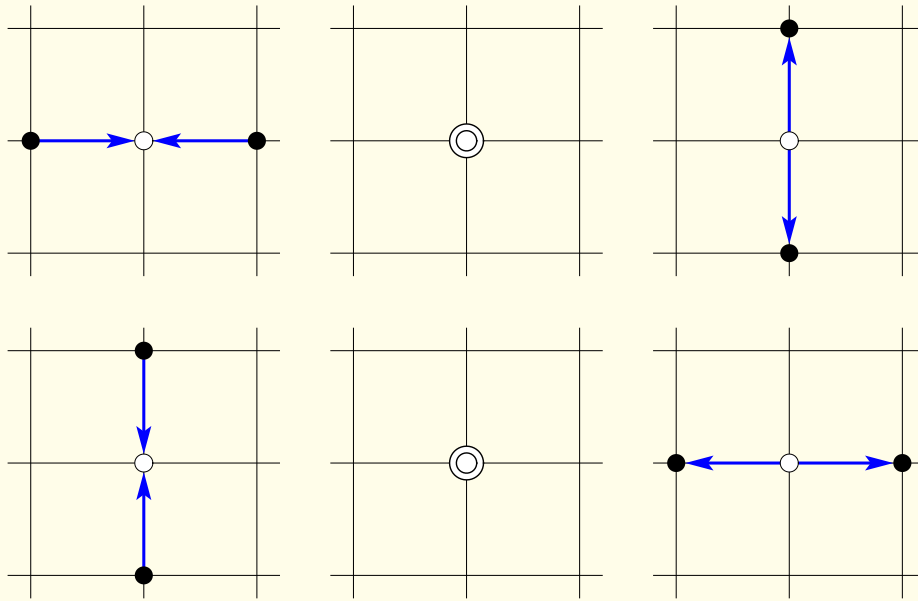

qualitativement correct model:

conservation of mass and momentum

quantitatively inexact model:

the pressure tensor is no longer isotropic!



Uriel Frisch
(born in 1940)

n.oca.eu

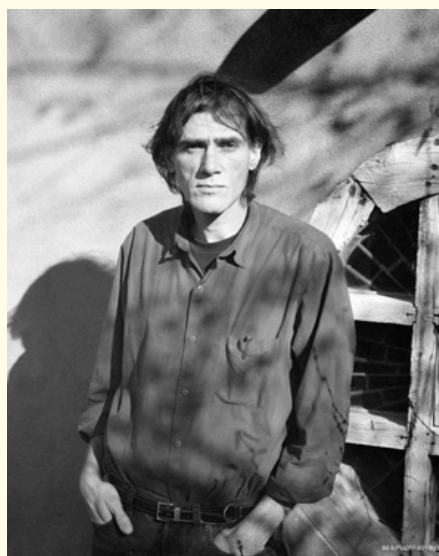

Brosl Hasslacher
(1941 - 2005)

cnls.lanl.gov



Yves Pomeau
(born in 1942)

epje.epj.org

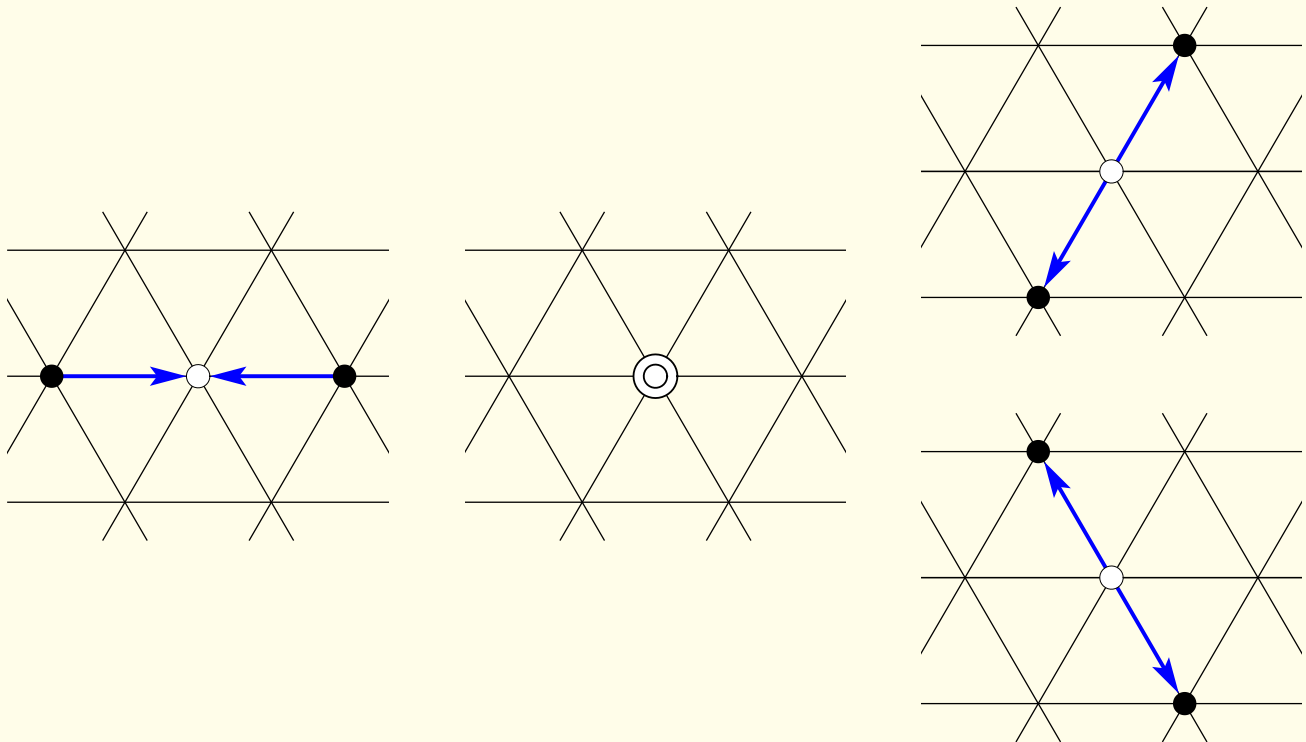

the final state is randomly selected among the two possibles

1392

C. R. Acad. Sc. Paris, t. 301, Série II, n° 20, 1985

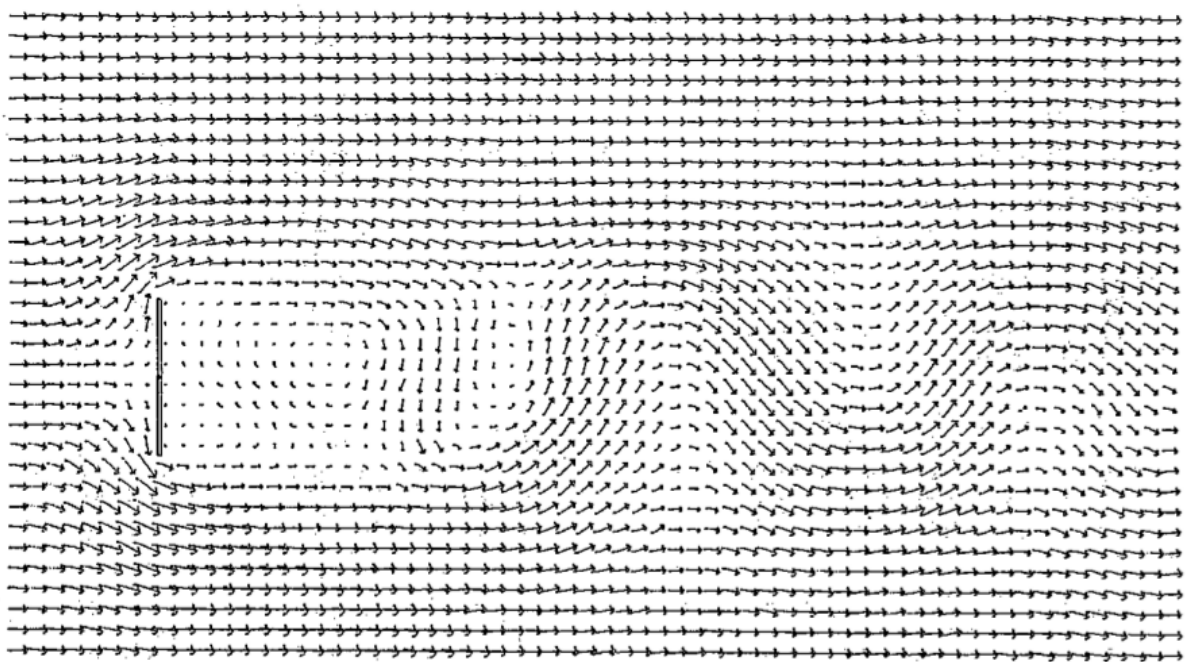

Fig. 1. — Écoulement autour d'une plaque mince pour un nombre de Reynolds de l'ordre de 70, après 5000 pas de temps. Les flèches représentent la direction et le module du flux aux nœuds d'un maillage 64×32 .

3D numerical simulation with a lattice gas (1986-1988) 35

scheme conception : D. d'Humières, P. Lallemand, U. Frisch

simulation : J.-P. Rivet, M. Hénon, U. Frisch, D. d'Humières

huge lattice : computation of the collision table very delicate

utilisation of the most powerful computer of the period



Cray 2 computer (1987-1993)

craysupercomputers.com

Lattice gas

36

regular **hexagonal** lattice for two space dimensions

complex dynamics of collisions

random draw of the collision

intrinsic noise

physically realistic **isotropic** hydrodynamics limit

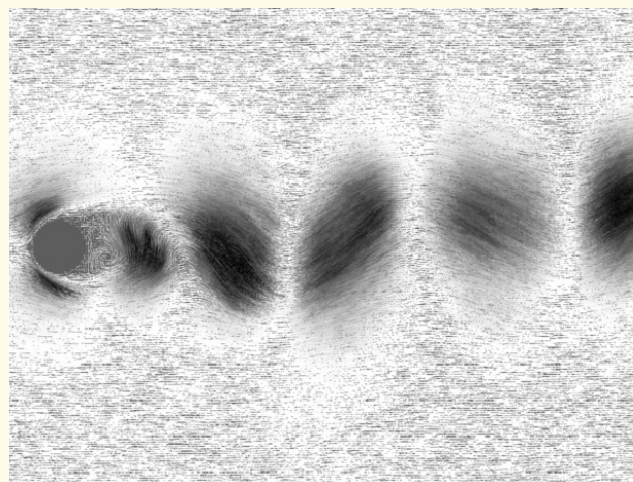

Anatoly Malevanets et Raymond Kapral, *Europhysics Letters*, 1998

Macroscopic, mesoscopic, microscopic

three different possible scales

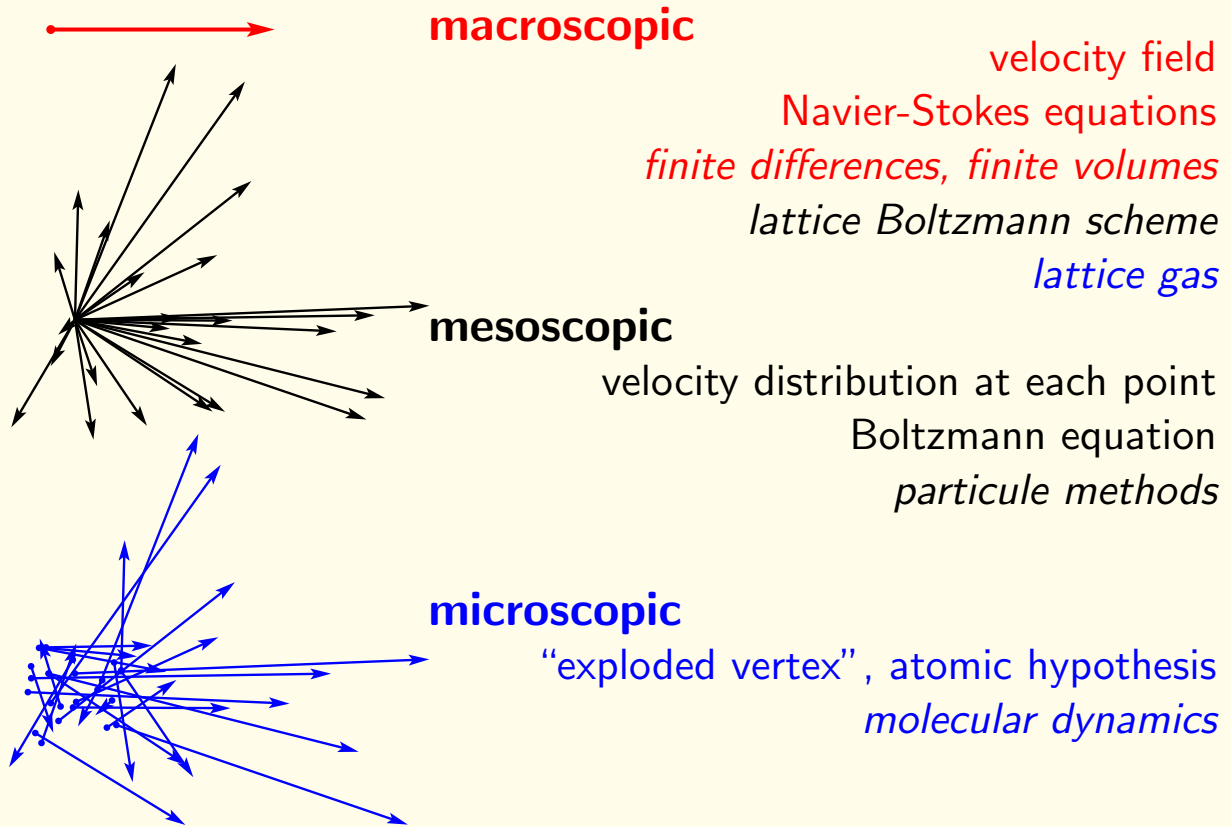

Lattice Boltzmann schemes (1989)

discrete form of the Boltzmann - BGK equation



Francisco Higuera
 (born in 1957)



Sauro Succi
 (born in 1954)



Roberto Benzi
 (born in 1952)

Lattice Boltzmann schemes (ii)

discrete velocities constrained by the discrete lattice

for each vertex x of the lattice, and for each velocity v_j

coherence between positions, velocities and time step Δt

$x + v_j \Delta t$ is still a lattice vertex

population at time t : $f_j(x, t)$, $0 \leq j < q$

node x of the lattice, velocity v_j

equilibrium distribution $f_j^{eq}(x, t)$

BGK type collision operator

$$\frac{1}{\varepsilon} dQ_j(f^{eq}).(f - f^{eq}), 0 \leq j < q$$

discrete Boltzmann - BGK evolution

between times t and $t + \Delta t$:

$$f_j(x + v_j \Delta t, t + \Delta t) = f_j(x, t) + \frac{\Delta t}{\varepsilon} dQ_j(f^{eq}).(f - f^{eq})$$

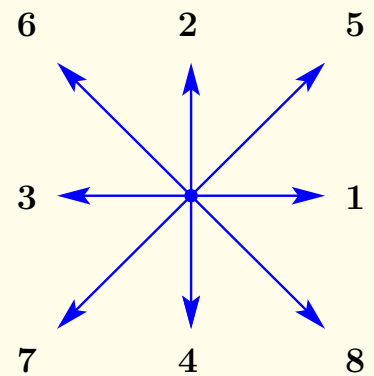

Polynomial equilibrium (1992)

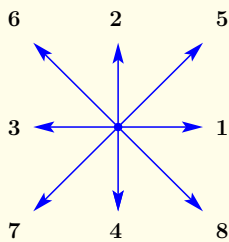

$$f_j^{eq}(\rho, u) = \rho \omega_j \left[1 + 3 \frac{u \cdot e_j}{\lambda} + \frac{9}{2} \left(\frac{u \cdot e_j}{\lambda} \right)^2 - \frac{3}{2} \frac{|u|^2}{\lambda^2} \right]$$

$$\omega_0 = \frac{4}{9}, \omega_j = \frac{1}{9}, j = 1, 2, 3, 4$$

$$\omega_j = \frac{1}{36}, j = 5, 6, 7, 8$$



Yue Hong Qian
(born in 1964)



Dominique d'Humières
(born in 1949)

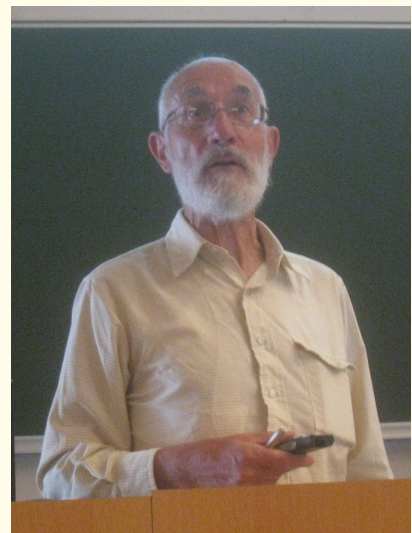

Pierre Lallemand
(born in 1940)

Multiple Relaxation Times Lattice Boltzmann scheme

41

Two steps for one time iteration

(i) **Nonlinear relaxation**

the particle distribution f is modified **locally**

into a new distribution f^*

d'Humières matrix M for moments: $m \equiv M f$, $m \equiv \begin{pmatrix} W \\ Y \end{pmatrix}$

conserved variables W ; after relaxation, $W^* = W$

microscopic moments Y

equilibrium value: $Y^{\text{eq}} = \Phi(W)$

after relaxation: $Y^* = Y + S(Y^{\text{eq}} - Y)$, $m^* = \begin{pmatrix} W \\ Y^* \end{pmatrix}$

(ii) **Linear advection**

method of characteristics when it is **exact** !

Compact description of the lattice Boltzmann scheme:

$$f_j(x, t + \Delta t) = f_j^*(x - v_j \Delta t, t)$$

Necessary conditions for stability

42

$$Y^* = Y + S(\Phi(W) - Y)$$

we deduce

$$Y^* - \Phi(W) = (I - S)(Y - \Phi(W))$$

natural stability condition: $\|I - S\| \leq 1$

id est

$$0 \leq s_j \leq 2, \quad 0 \leq j < q - N$$

over-relaxation $1 < s_j < 2$

widely used in the community of lattice Boltzmann schemes

to take into account **very low viscosities**

in fluid mechanics

Advection step

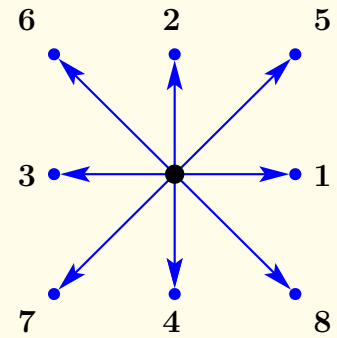

second step of advection

method of characteristics applied

in the very particular case when it is exact

in one time step each particle distribution f_j

exactly transported from the node $x - v_j \Delta t$ of the lattice \mathcal{L} to the vertex $x \in \mathcal{L}$

the advection step occurs with a Courant-Friedrichs-Lewy number

$cfl \equiv 1$ for all discrete velocities v_j

Boundary conditions for the D2Q9 scheme

- D2Q9 scheme for internal node x .

Evolution of populations f_i :

$$f_i(x, t + \Delta t) = f_i^*(x - v_i \Delta t, t), \quad 0 \leq i \leq 8,$$

where * denotes post-collision quantities.

- Bottom boundary

The values $f_i^*(x - v_i \Delta t)$ for $i \in \{2, 5, 6\} \equiv \mathcal{B}$ are unknown.

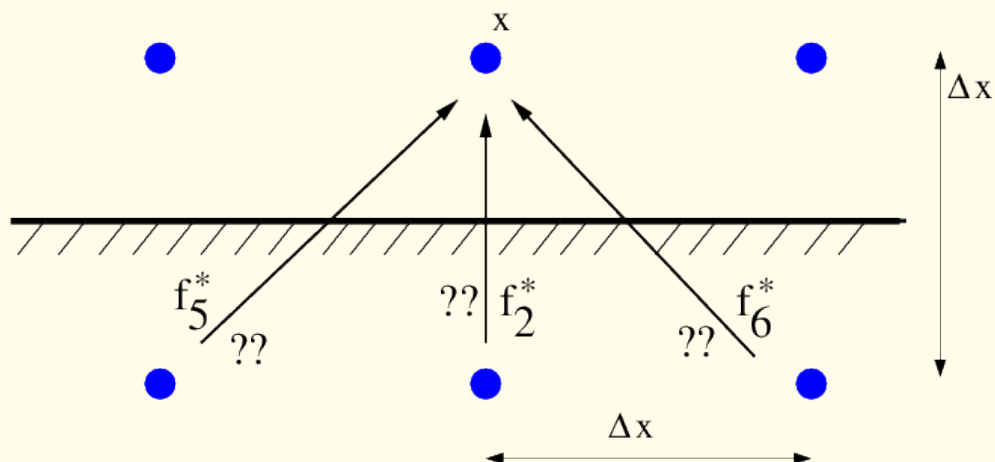

Bounce-back boundary conditions

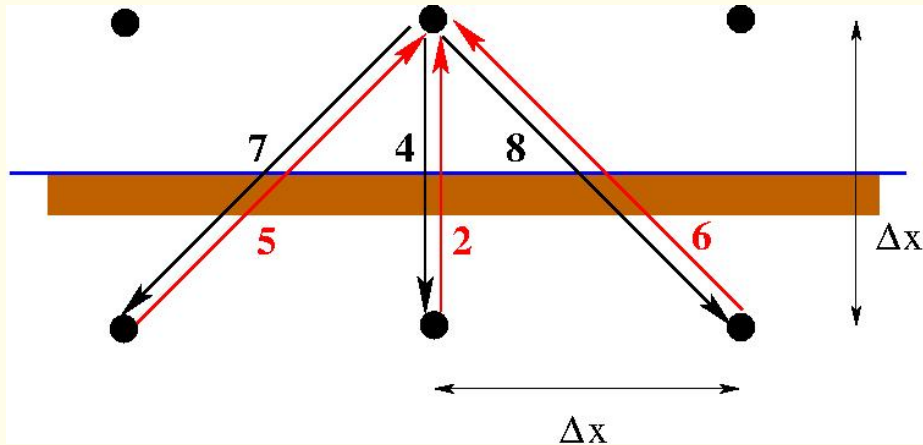

given u_0 on the boundary (and ρ_0 also...)

$$f_2(x_1, x_2, t + \Delta t) = f_4^*(x_1, x_2, t) + \frac{2}{3\lambda} \rho_0 u_0$$

$$f_5(x_1, x_2, t + \Delta t) = f_7^*(x_1, x_2, t) + \frac{1}{6\lambda} \rho_0 (u_0 + v_0)$$

$$f_6(x_1, x_2, t + \Delta t) = f_8^*(x_1, x_2, t) + \frac{1}{6\lambda} \rho_0 (-u_0 + v_0).$$

Curved two-dimensional boundary

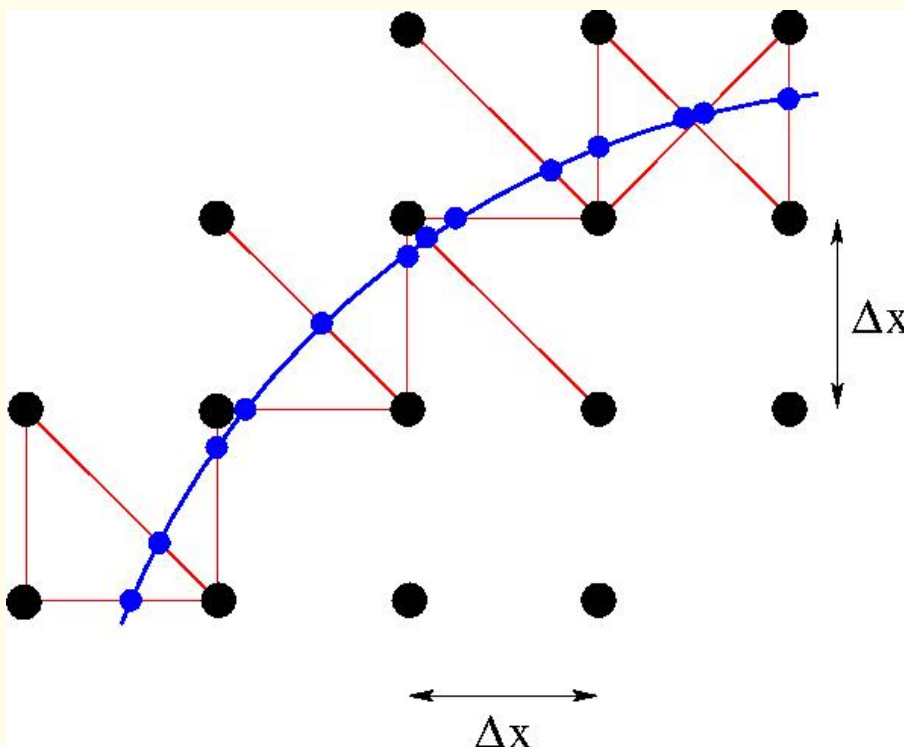

curved boundary: take into account all the red links

Bouzidi - Firdaouss - Lallemand boundary condition (2001)

Two-dimensional Bouzidi boundary conditions

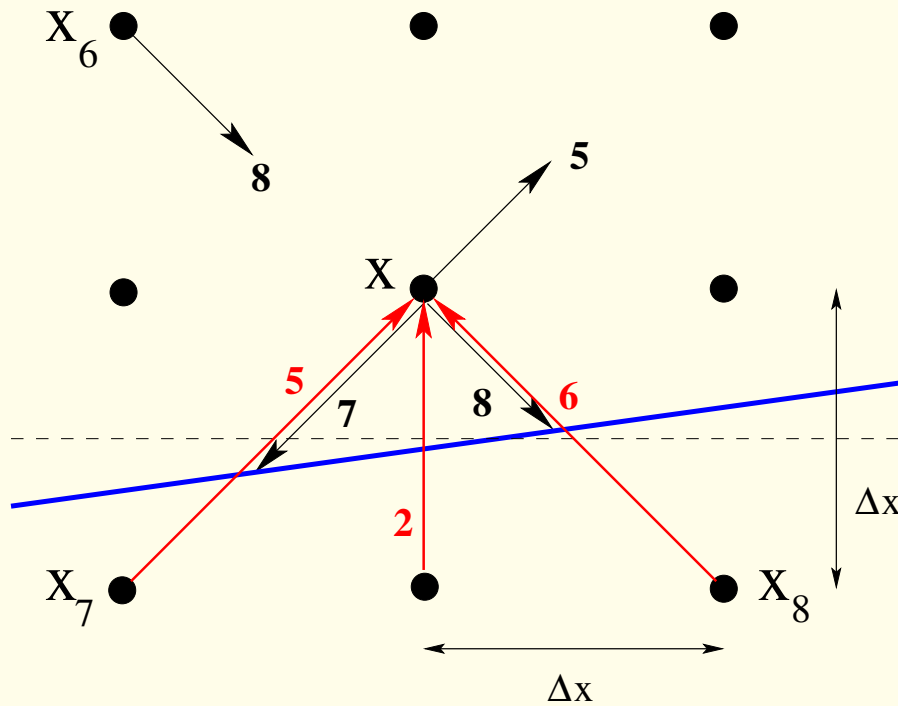

example with $\xi_7 > \frac{1}{2}$ and $\xi_8 < \frac{1}{2}$

$$f_5(x, t + \Delta t) = \frac{1}{2\xi_7} \left[f_7^*(x, t) + \frac{1}{6\lambda} \rho_0 (u_0 + v_0) \right] + \left(1 - \frac{1}{2\xi_7} \right) f_5^*(x, t)$$

$$f_6(x, t + \Delta t) = \left[2\xi_8 f_8^*(x, t) + (1 - 2\xi_8) f_8^*(x_6, t) \right] + \frac{1}{6\lambda} \rho_0 (-u_0 + v_0)$$

Stokes problem in a circle

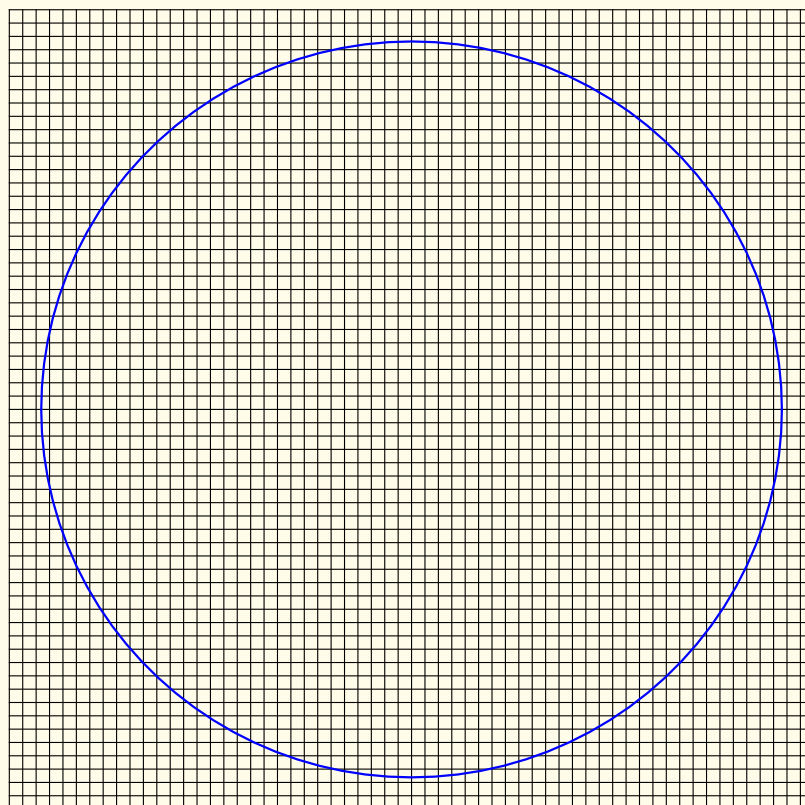

radius = 27.62 viscosity = 0.04

Stokes problem in a circle (ii)

49

$t = 0$: initial condition with a rigid rotation

After 500 time steps :

measure of the tangential velocity distribution
for all the vertices inside the circle

D2Q9 MRT lattice Boltzmann scheme

Experiment 1 : [finite volume](#) boundary conditions

presented at the 3th ICMMES meeting, Hampton, 2006

Experiment 2 : [Bouzidi-Firdaous-Lallemand](#) boundary conditions

[Comparison](#) with the theoretical velocity (sum of Bessel functions)

Stokes problem in a circle (iii)

50

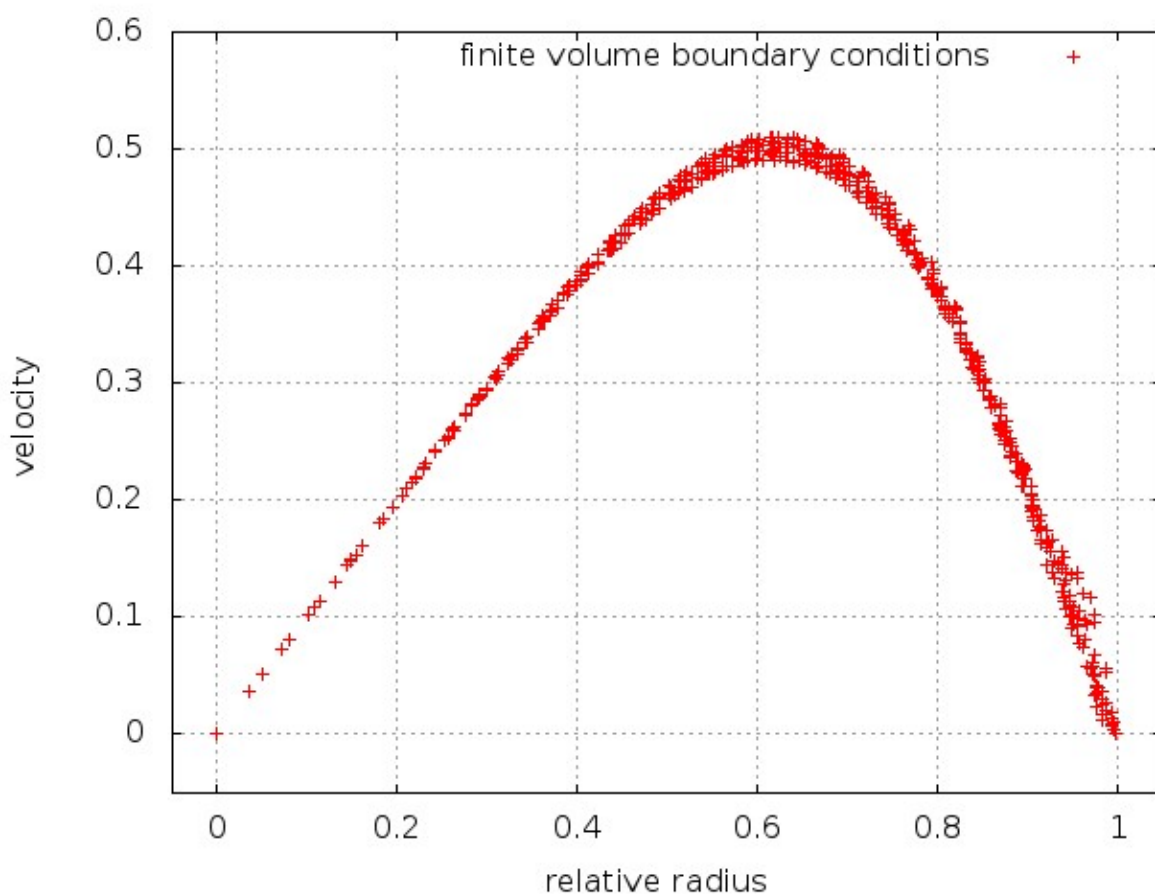

Stokes problem in a circle (iv)

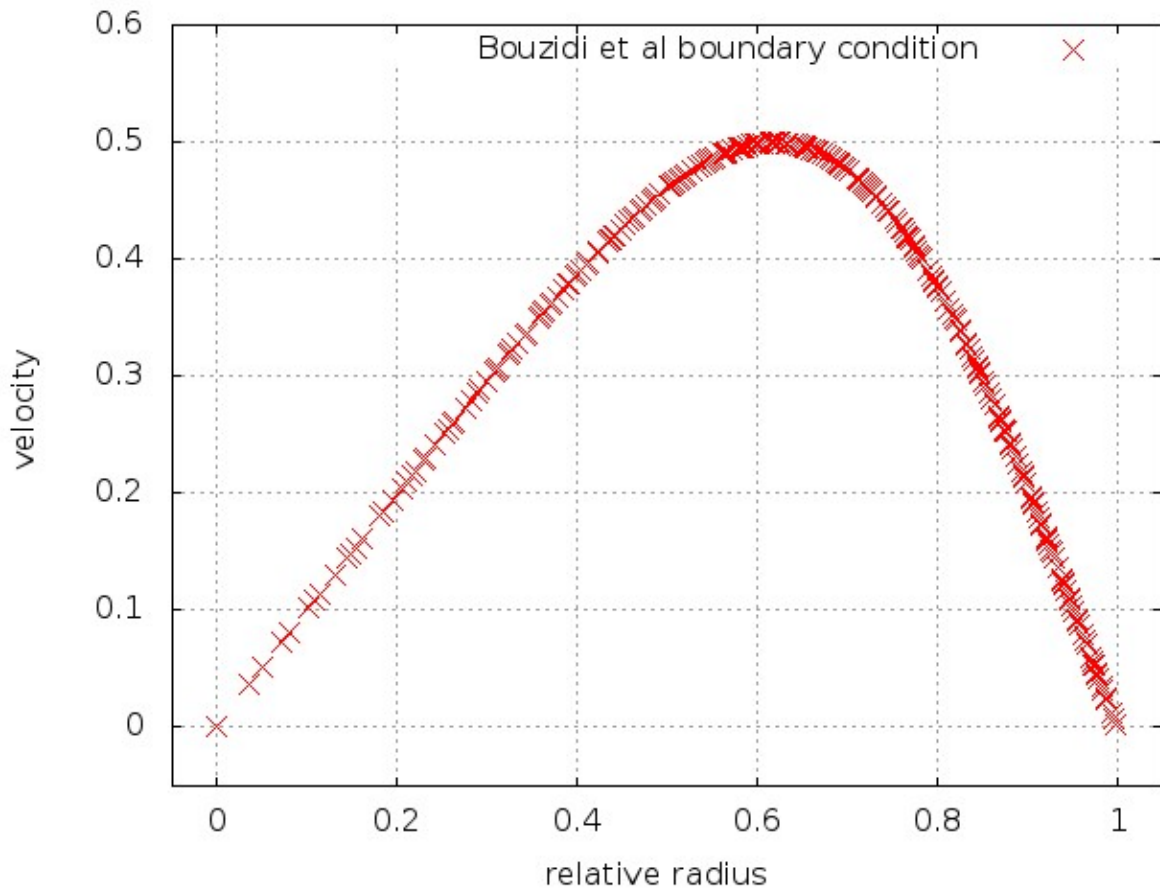

Stokes problem in a circle (v)

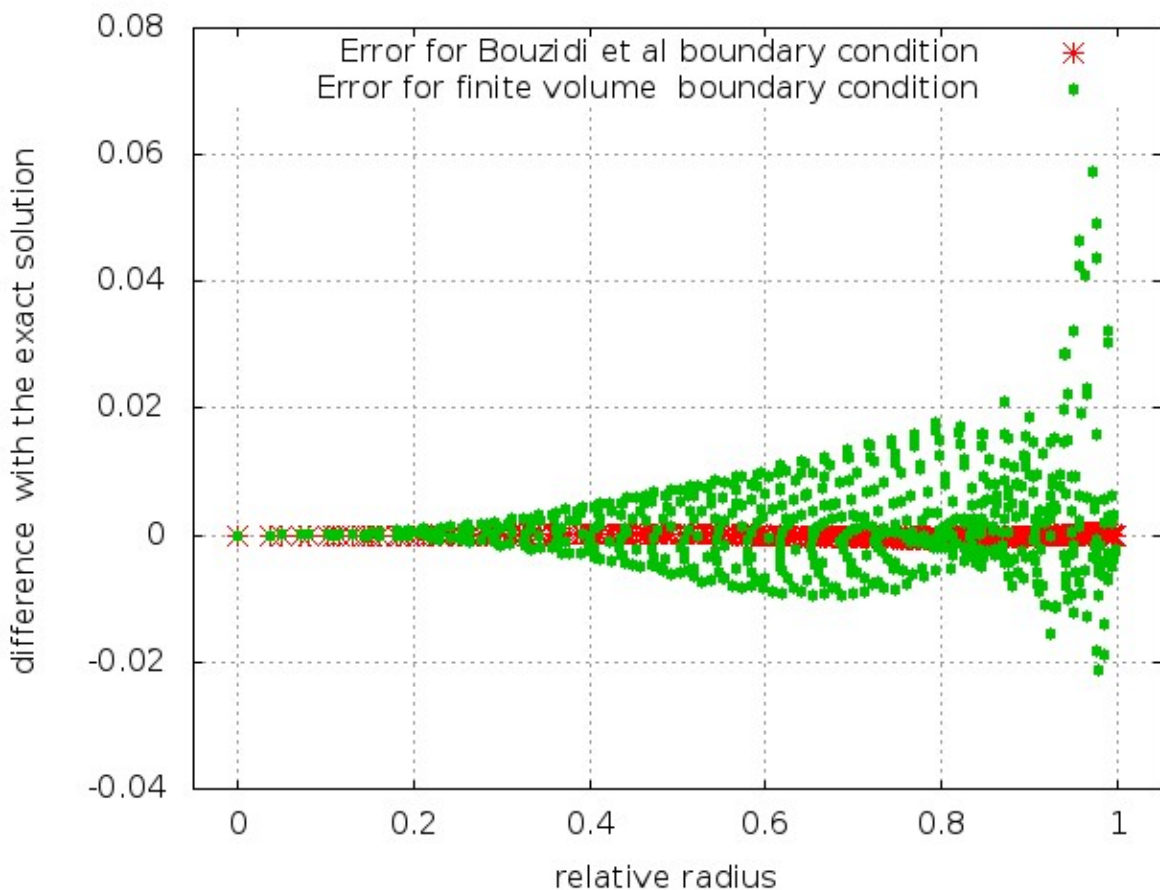

Stokes problem in a circle (vi)

53

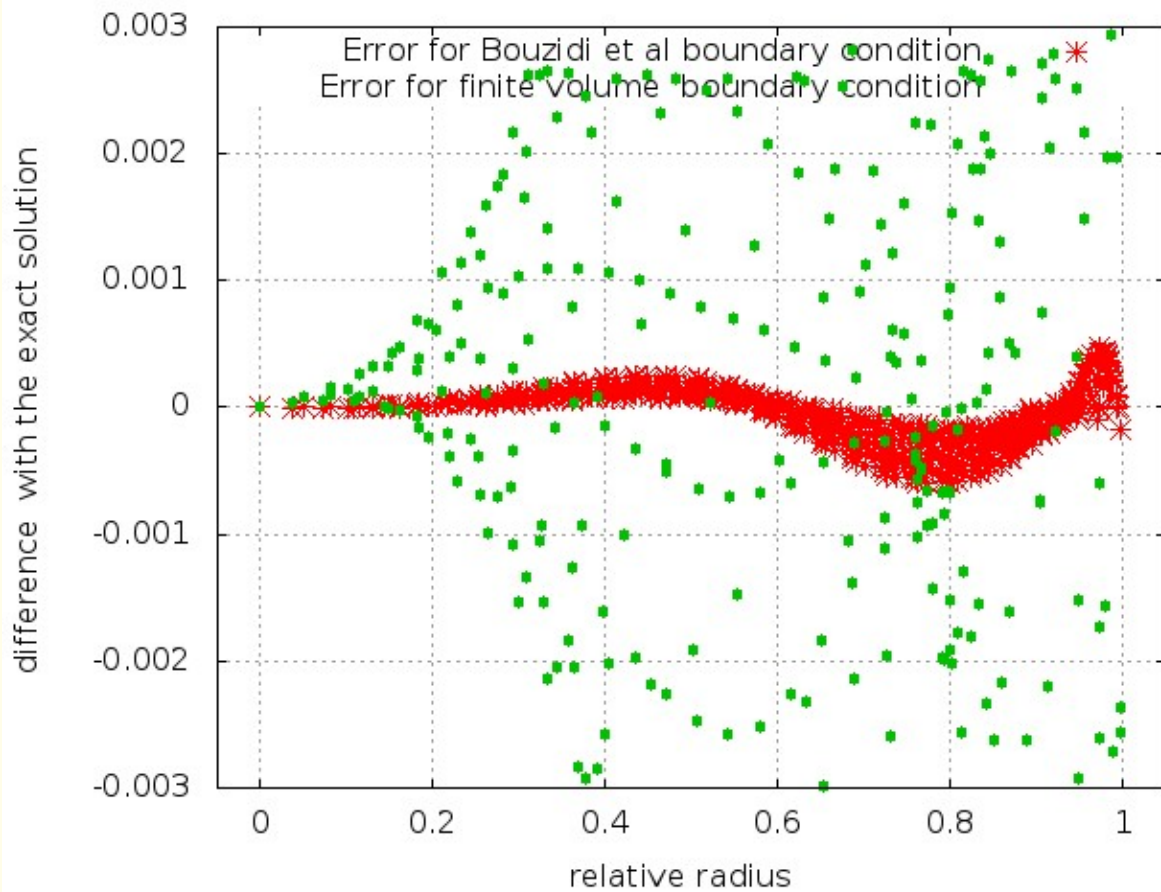

Flows in porous media

54

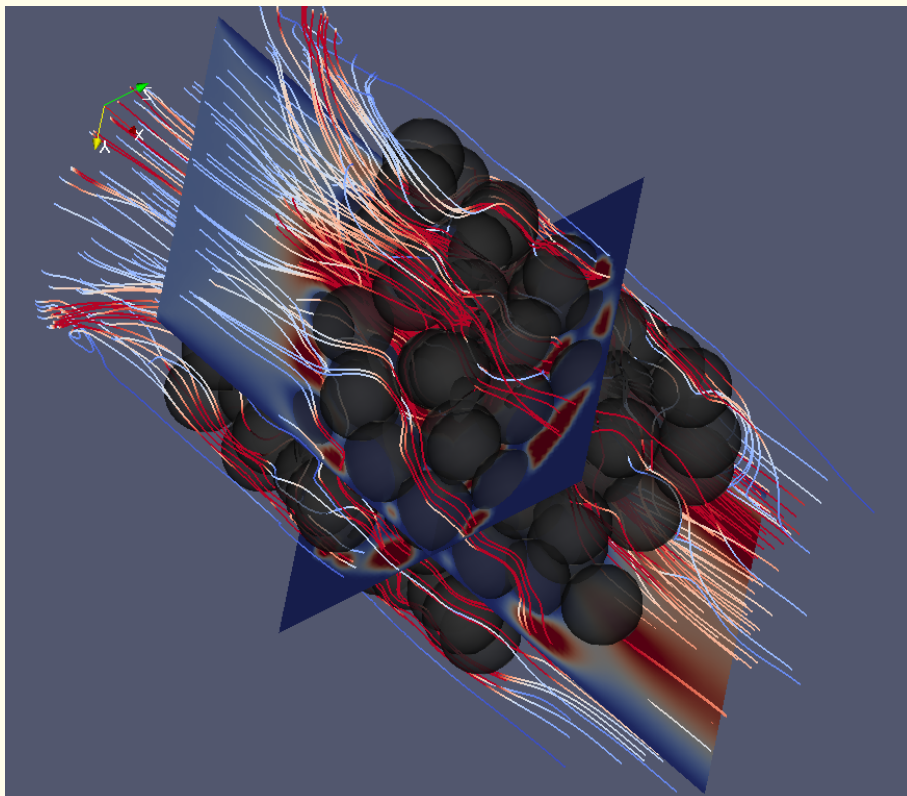

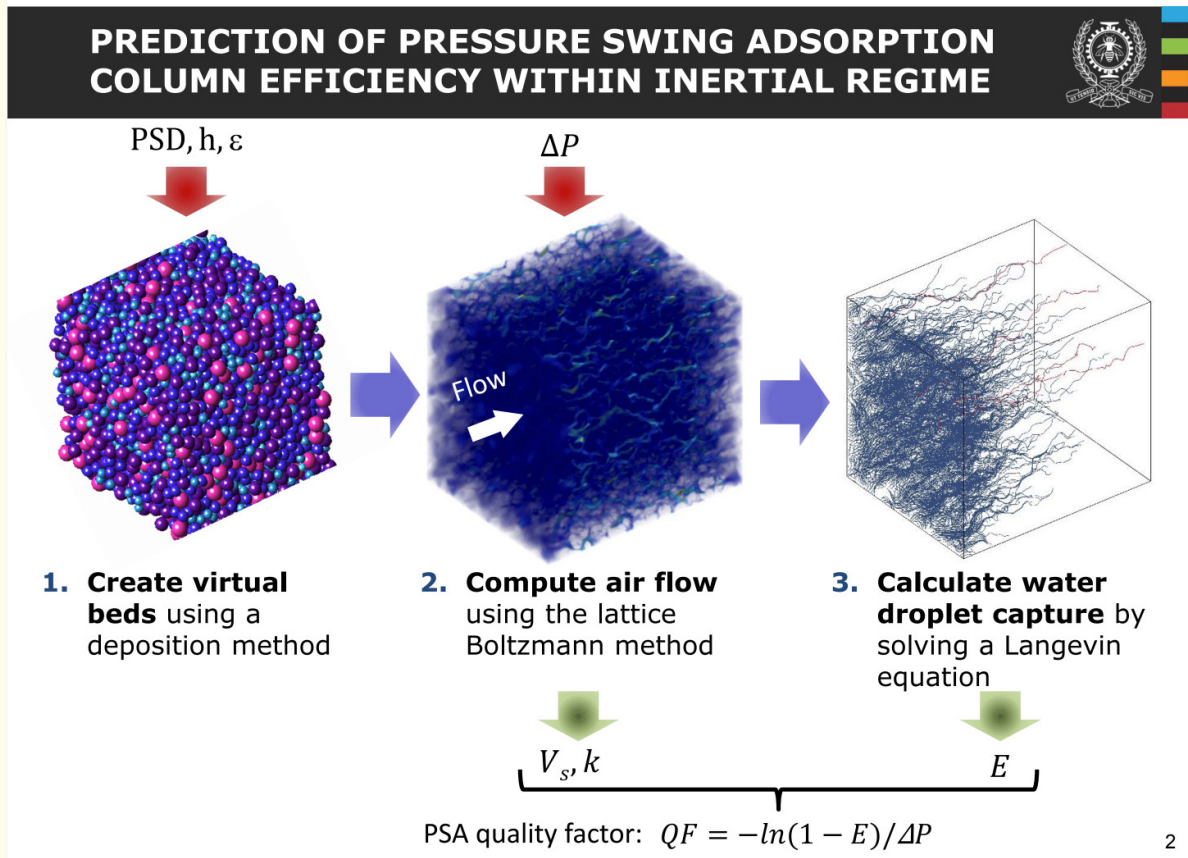

David Vidal (Polytechnique Montréal), Banff, EPIC workshop, 2016

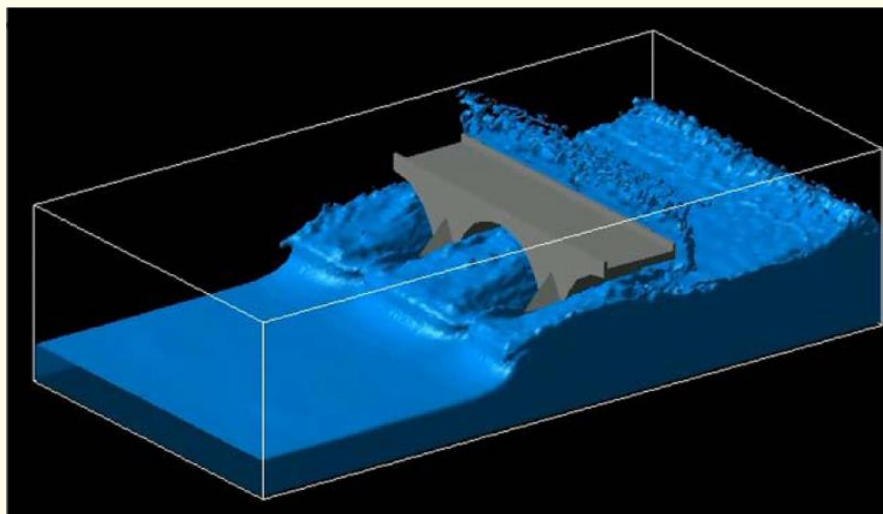

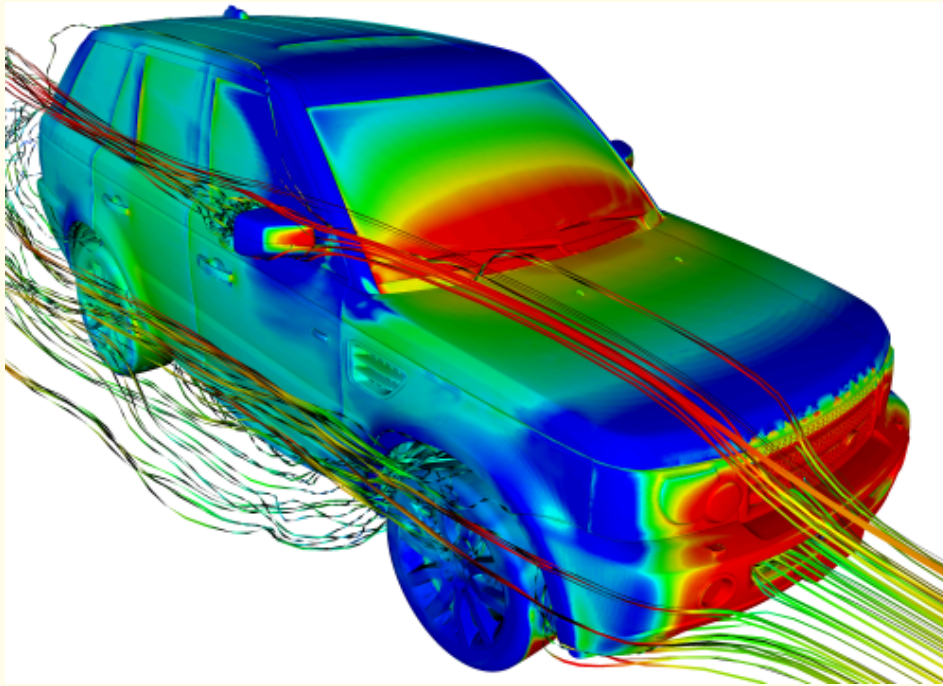

www.prweb.com

“Powerflow” software (EXA, Boston, USA)

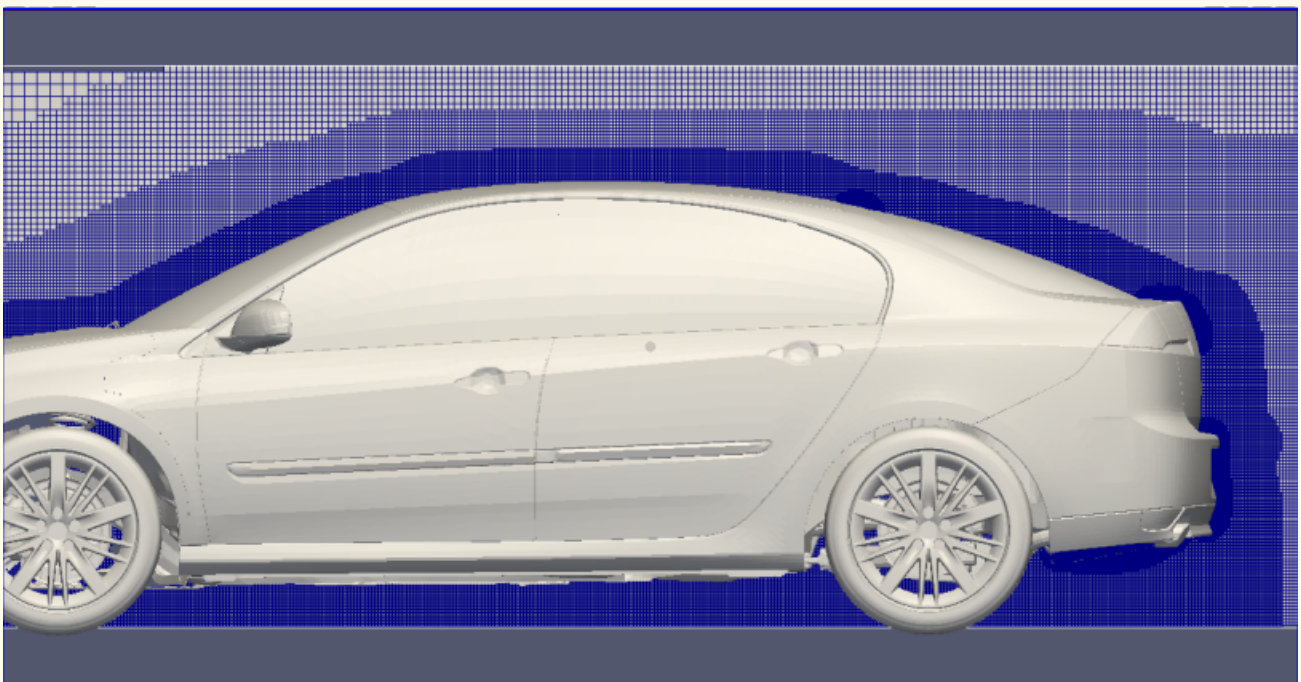

lyoncalcul.univ-lyon1.fr

186 surfaces generate 2.3 millions of triangles

10 levels of mesh refinement (octree) size of the smallest mesh: 1.25 mm

88.6 millions of meshes, 300 000 time iterations

LaBS-ProLB: aerodynamics software (Renault, 2013)

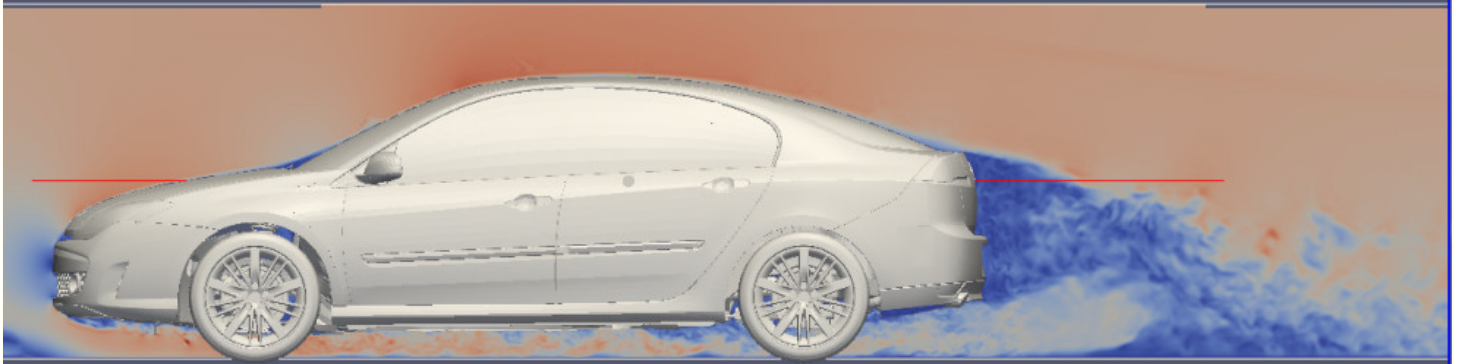

instantaneous velocity

m2p2.fr

LaBS-ProLB : aérodynamique (Renault, 2013)

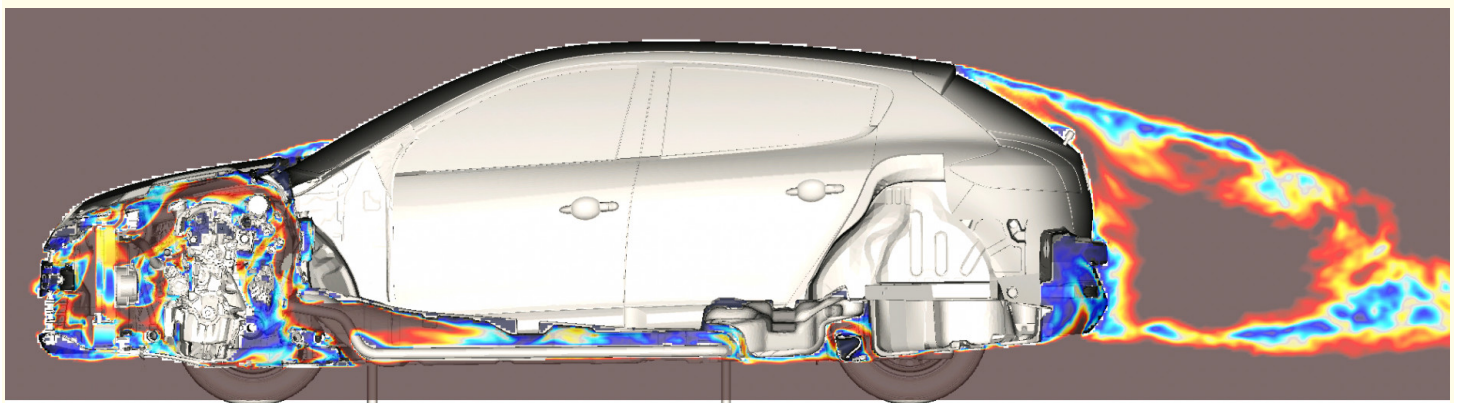

with the internal flow

m2p2.fr

Wind tunnel or supercomputing ?



www.soufflerie2a.com



static.techspot.com

Exa's Powerflow software

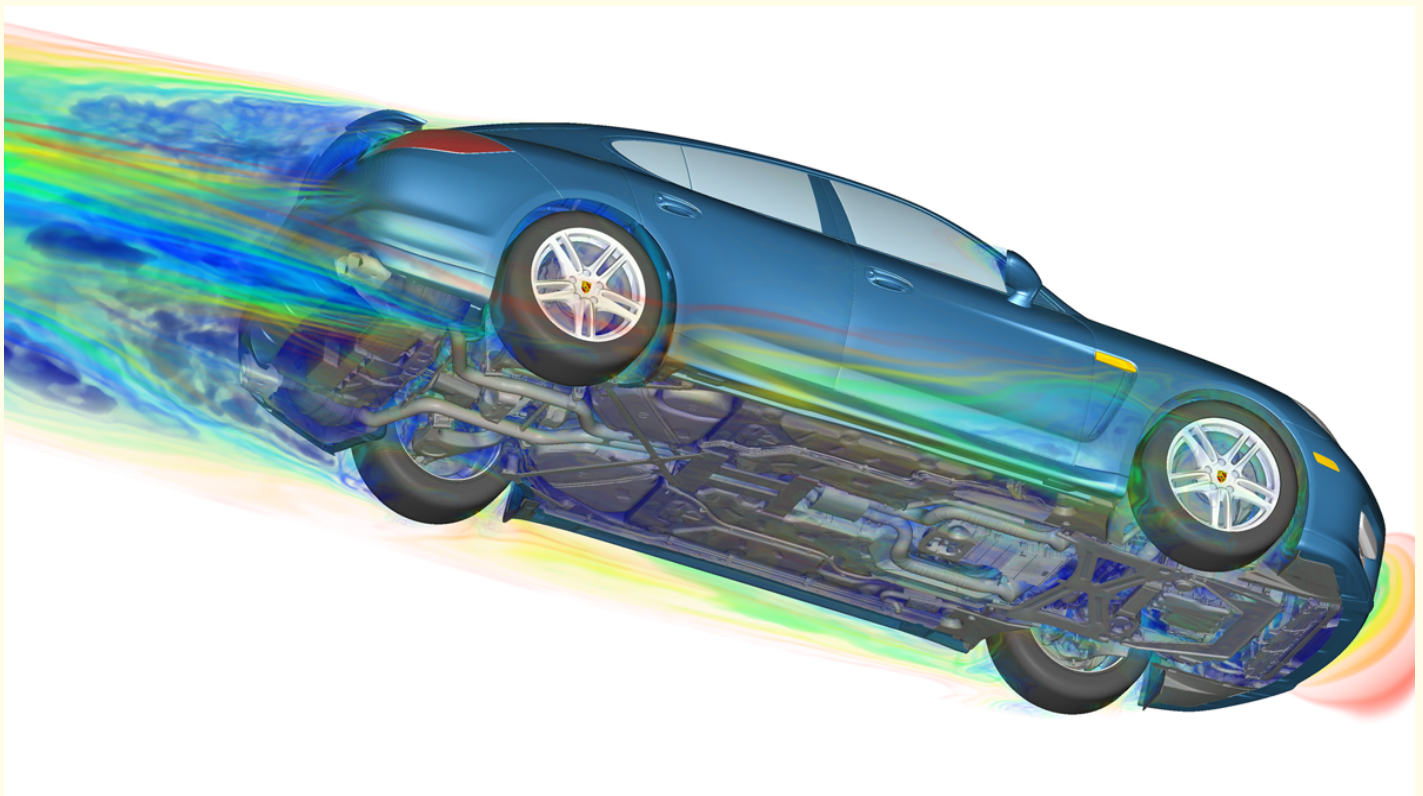

Porsche Panamera underbody (2011)

www.prweb.com

LaBS-ProLB: landing gear (Airbus, 2013)

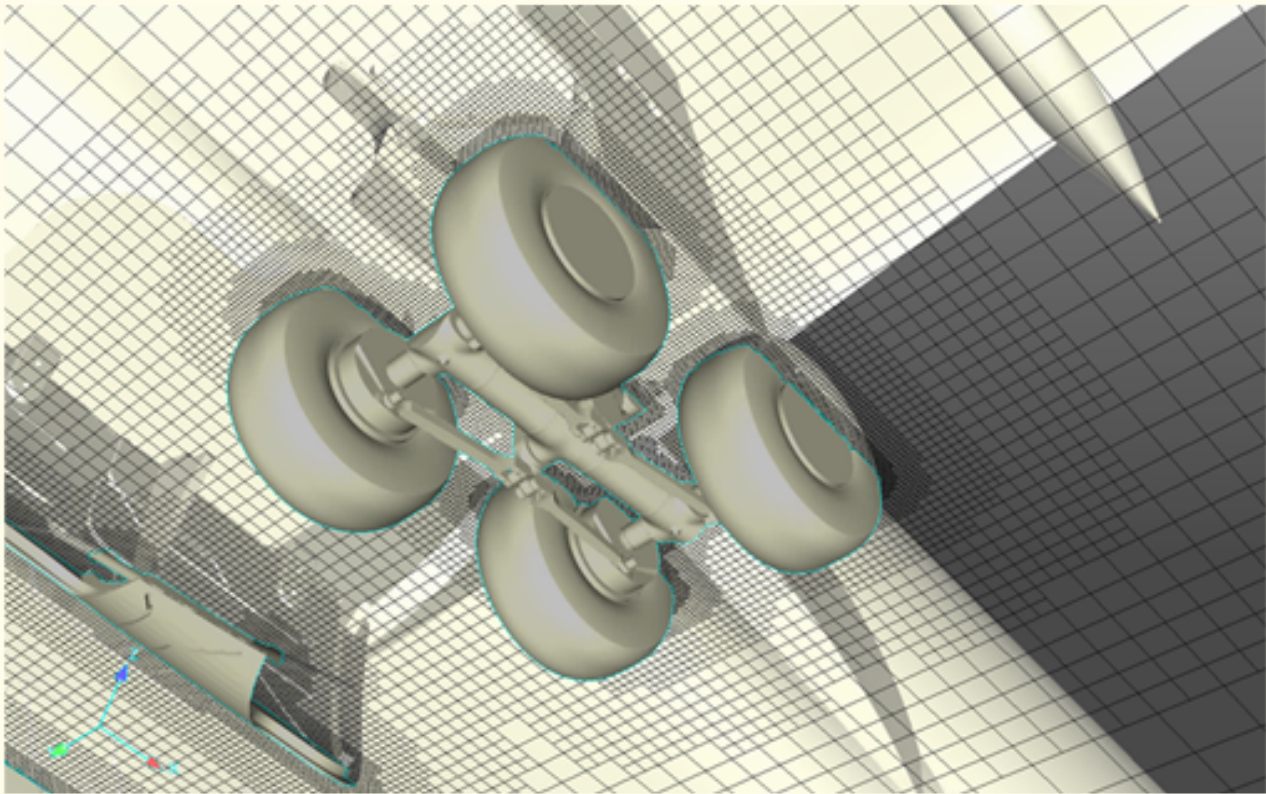

mesh

prolb-cfd.com

LaBS-ProLB: landing gear (Airbus, 2013)

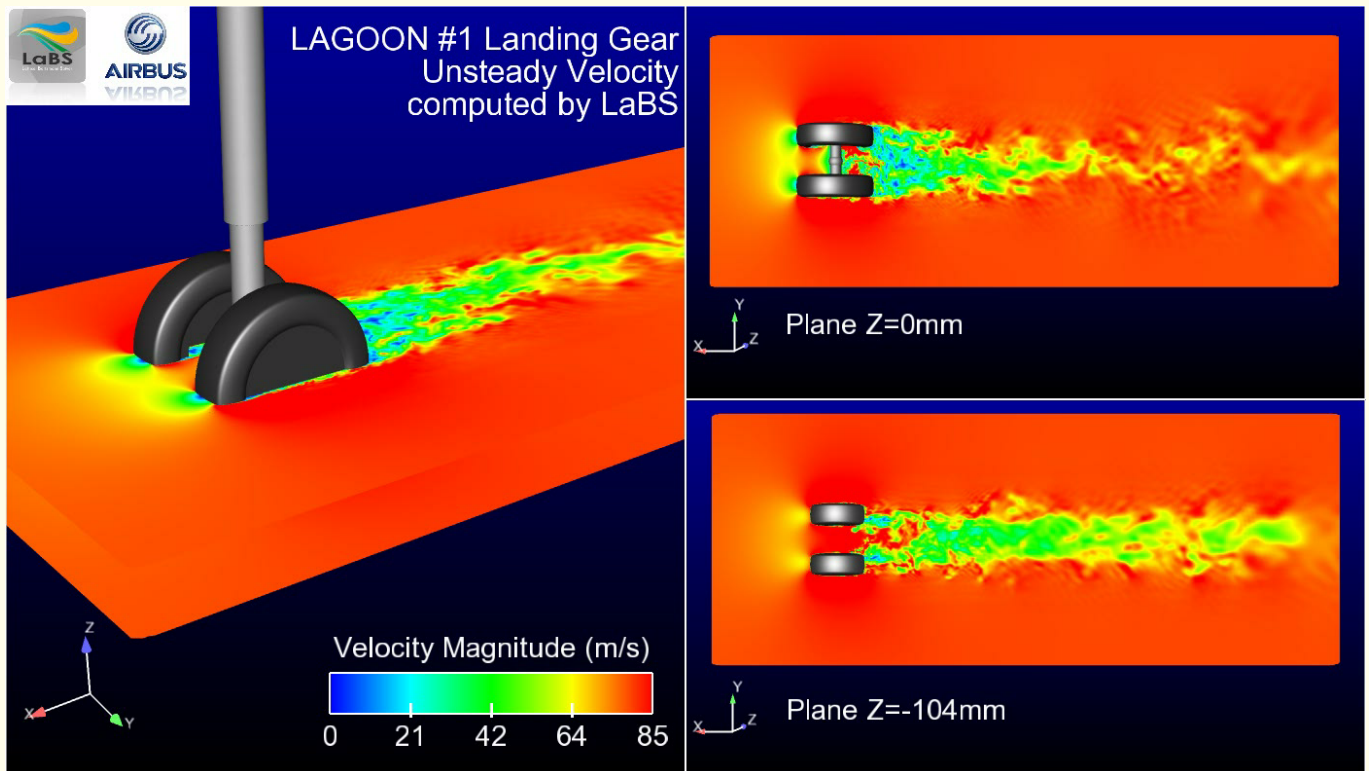

ProLB (LaBS) software (2017)

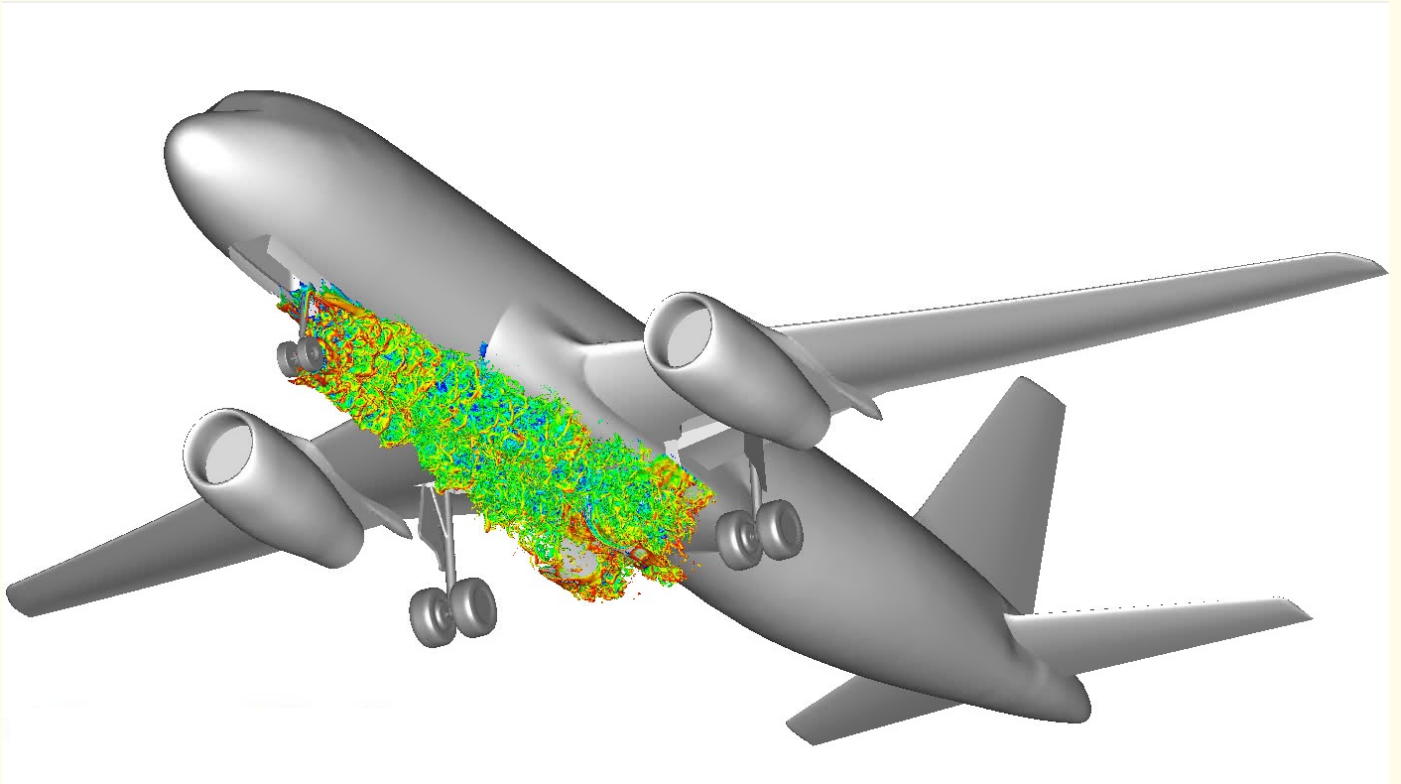

landing gear of an Airbus

www.wmaker.net

Exa's Powerflow software (2017)

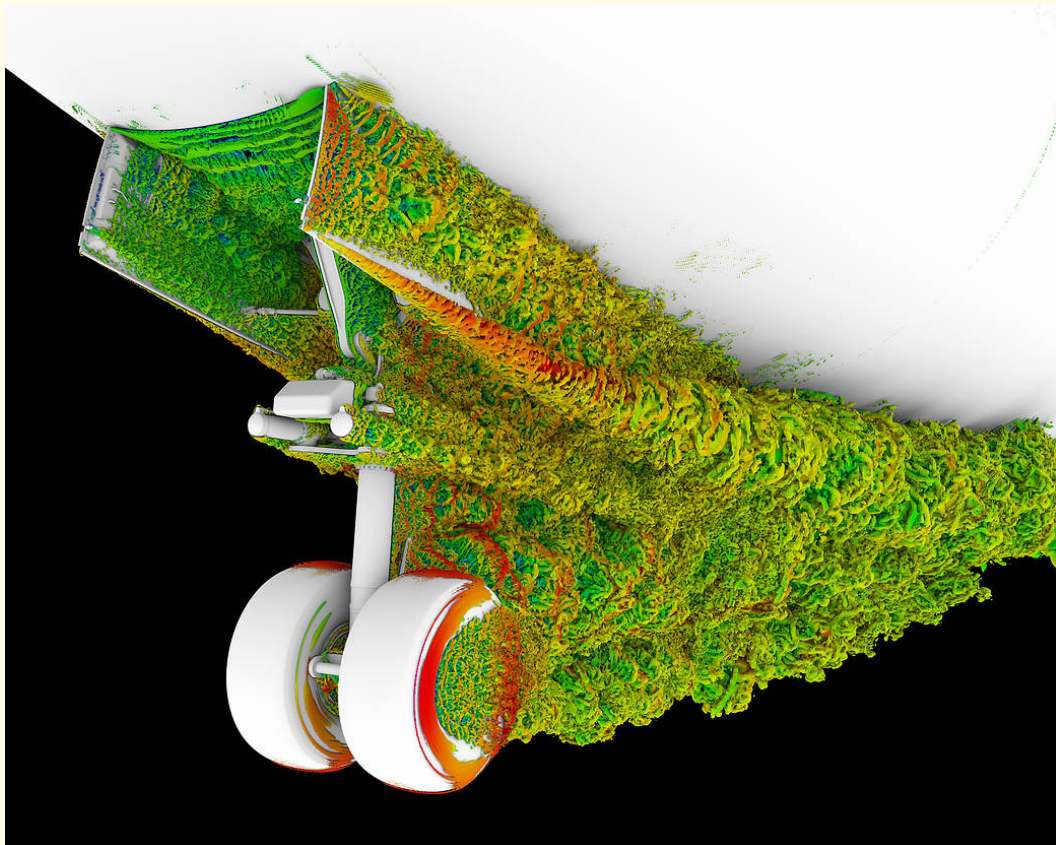

complex vortex structure under the Boeing 777

www.nasa.gov

Exa's Powerflow software



Hudong Chen (in 2008)

The engineers do not need mathematicians !

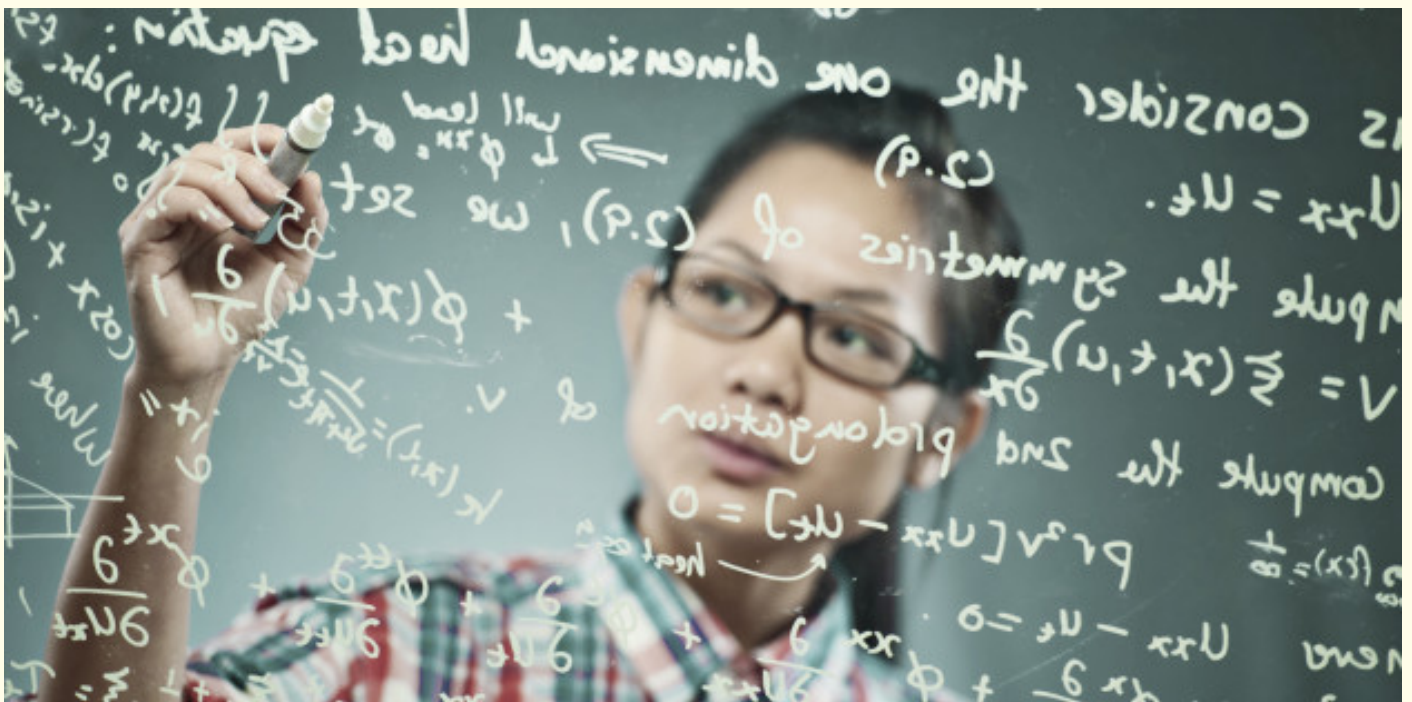

Lattice Boltzmann scheme

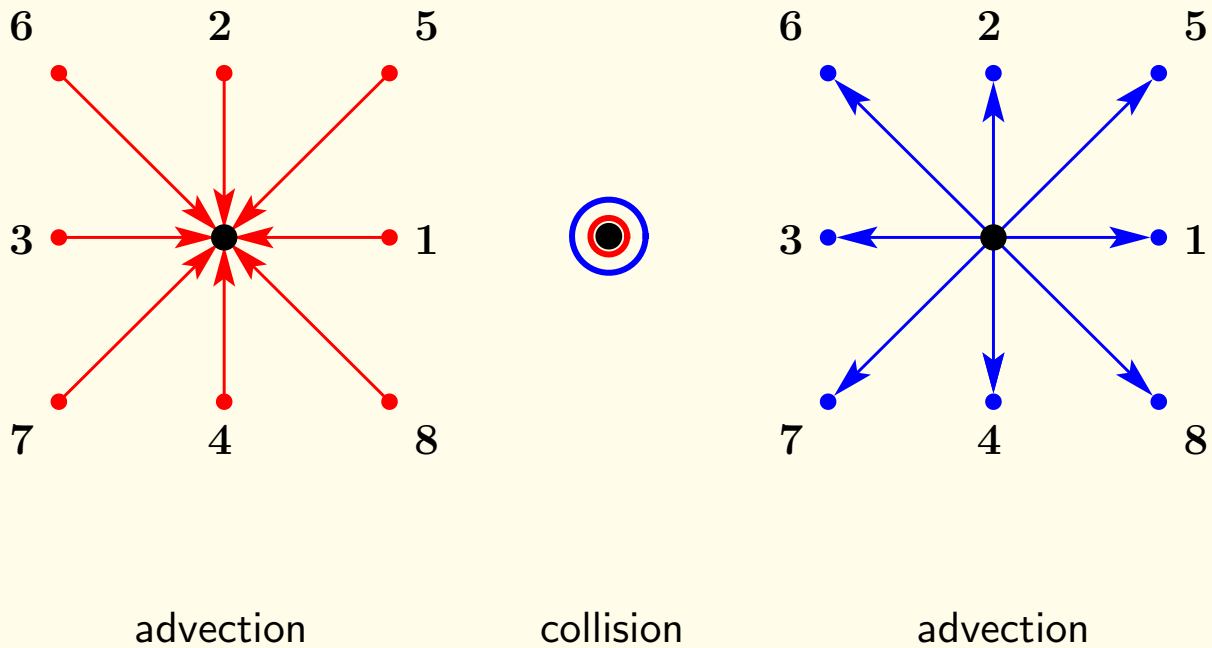

Multiple Relaxation Times Lattice Boltzmann scheme

Two steps for one time iteration

(i) **Nonlinear relaxation**

the particle distribution f is modified **locally** into a new distribution f^*

d'Humières matrix M for moments: $m \equiv M f$, $m \equiv \begin{pmatrix} W \\ Y \end{pmatrix}$

conserved variables W ; after relaxation, $W^* = W$

microscopic moments Y

equilibrium value: $Y^{eq} = \Phi(W)$

after relaxation: $Y^* = Y + S(Y^{eq} - Y)$, $m^* = \begin{pmatrix} W \\ Y^* \end{pmatrix}$

(ii) **Linear advection**

method of characteristics when it is **exact** !

Compact description of the lattice Boltzmann scheme:

$$f_j(x, t + \Delta t) = f_j^*(x - v_j \Delta t, t)$$

Taylor formula and exponential operator

71

Taylor formula for a regular function

$$\varphi(x+h) = \varphi(x) + \frac{d\varphi}{dx} h + \frac{1}{2} \frac{d^2\varphi}{dx^2} h^2 + \dots + \frac{1}{k!} \frac{d^k\varphi}{dx^k} h^k + \dots$$

exponential of an operator

$$\exp(\psi) = I + \psi + \frac{1}{2} \psi^2 + \dots + \frac{1}{k!} \psi^k + \dots$$

exponential of the nonbounded operator $\psi = \frac{d}{dx}$

$$\exp\left(\frac{d}{dx}\right) = I + \frac{d}{dx} + \frac{1}{2} \frac{d^2}{dx^2} + \dots + \frac{1}{k!} \frac{d^k}{dx^k} + \dots$$

exponential of the nonbounded operator $\psi = h \frac{d}{dx}$

$$\exp\left(h \frac{d}{dx}\right) = I + h \frac{d}{dx} + \frac{h^2}{2} \frac{d^2}{dx^2} + \dots + \frac{h^k}{k!} \frac{d^k}{dx^k} + \dots$$

Taylor formula as an exponential : $\varphi(x+h) = \exp\left(h \frac{d}{dx}\right) \varphi(x)$

Exact exponential expansion

72

$$f_j(x, t + \Delta t) = f_j^*(x - v_j \Delta t, t)$$

$$\begin{aligned} m_k(x, t + \Delta t) &= \sum_j M_{kj} f_j^*(x - v_j \Delta t, t) \\ &= \sum_j M_{kj} \sum_\ell (M^{-1})_{j\ell} m_\ell^*(x - v_j \Delta t, t) \\ &= \sum_j M_{kj} \sum_\ell m_\ell^*(x - v_j \Delta t, t) (M^{-1})_{j\ell} \\ &= \sum_\ell \sum_j M_{kj} \exp\left(-\Delta t \sum_\alpha v_j^\alpha \partial_\alpha\right) m_\ell^*(x, t) (M^{-1})_{j\ell} \\ &= \sum_\ell \left[\sum_j M_{kj} \exp\left(-\Delta t \sum_\alpha v_j^\alpha \partial_\alpha\right) (M^{-1})_{j\ell} \right] m_\ell^*(x, t) \\ &= \sum_\ell \exp\left(-\Delta t \sum_j M_{kj} \sum_\alpha v_j^\alpha \partial_\alpha (M^{-1})_{j\ell}\right) m_\ell^*(x, t) \\ &= \sum_\ell \exp(-\Delta t \Lambda)_{k\ell} m_\ell^*(x, t) = \left(\exp(-\Delta t \Lambda) m^*(x, t) \right)_k \end{aligned}$$

Exact exponential expansion (ii)

73

$$\Lambda = M \operatorname{diag} \left(\sum_{1 \leq \alpha \leq d} v^\alpha \partial_\alpha \right) M^{-1}$$

$$\exp(-\Delta t \Lambda) = I - \Delta t \Lambda + \frac{\Delta t^2}{2} \Lambda^2 + \dots + (-1)^k \frac{\Delta t^k}{k!} \Lambda^k + \dots$$

important elementary remark to simplify the final result

block decomposition $\Lambda \equiv \begin{pmatrix} A & B \\ C & D \end{pmatrix}$

$$\Lambda^2 = \Lambda \Lambda \equiv \begin{pmatrix} A_2 & B_2 \\ C_2 & D_2 \end{pmatrix}$$

$$\text{with } \begin{pmatrix} A_2 & B_2 \\ C_2 & D_2 \end{pmatrix} = \begin{pmatrix} A & B \\ C & D \end{pmatrix} \begin{pmatrix} A & B \\ C & D \end{pmatrix}$$

$$\begin{aligned} A_2 &= A^2 + B C \\ B_2 &= A B + B D \\ C_2 &= C A + D C \\ D_2 &= C B + D^2 \end{aligned}$$

“ABCD” method

74

$$\Lambda = M \operatorname{diag} \left(\sum_{1 \leq \alpha \leq d} v^\alpha \partial_\alpha \right) M^{-1} \equiv \begin{pmatrix} A & B \\ C & D \end{pmatrix}$$

$$m(x, t + \Delta t) \equiv \begin{pmatrix} W \\ Y \end{pmatrix} (x, t + \Delta t) = \exp(-\Delta t \Lambda) m^*(x, t)$$

$$W^* = W, \quad Y^* = Y + S(\Phi(W) - Y)$$

asymptotic hypothesis: non-conserved moments

$$Y = \Phi(W) + \Delta t S^{-1} \Psi_1 + O(\Delta t^2)$$

emerging partial differential equations

$$\partial_t W + \Gamma_1 + \Delta t \Gamma_2 = O(\Delta t^2)$$

Γ_j : vector obtained after j space derivations

of the conserved moments W and the equilibrium $\Phi(W)$

general nonlinear ABCD algorithm at second order

$$\Gamma_1 = A W + B \Phi(W)$$

$$\Psi_1 = d\Phi(W) \cdot \Gamma_1 - (C W + D \Phi(W))$$

$$\Gamma_2 = B \Sigma \Psi_1 \quad \text{with } \Sigma \text{ the Hénon matrix: } \Sigma \equiv S^{-1} - \frac{1}{2} I$$

A important remark on the effect of the discretization

75

Continuous Chapman-Enskog expansion

$$\partial_t W + \Gamma_1 + \varepsilon \Gamma_2 = O(\varepsilon^2)$$

$$Y = \Phi(W) + \varepsilon Z^{-1} \Psi_1(W) + O(\varepsilon^2)$$

$$(Z^{-1})_j = \tau_j$$

$$\Gamma_1 = A W + B \Phi(W)$$

$$\Psi_1 = d\Phi(W) \cdot \Gamma_1 - (C W + D \Phi(W))$$

$$\varepsilon \Gamma_2 = \varepsilon B Z^{-1} \Psi_1,$$

Discrete ABCD method

$$\partial_t W + \Gamma_1 + \Delta t \Gamma_2 = O(\Delta t^2)$$

$$Y = \Phi(W) + \Delta t S^{-1} \Psi_1 + O(\Delta t^2)$$

$$(S^{-1})_j = \frac{1}{s_j} \equiv \frac{\tau_j}{\Delta t}$$

$$\Gamma_1 = A W + B \Phi(W)$$

$$\Psi_1 = d\Phi(W) \cdot \Gamma_1 - (C W + D \Phi(W))$$

$$\Delta t \Gamma_2 = \Delta t B \Sigma \Psi_1$$

$$\Sigma = S^{-1} - \frac{1}{2} I$$

Hénon matrix (1987)



Michel Hénon (1931-2013)

espace-turing.fr

Fourth order expansion

76

asymptotic expansion for the microscopic moments

$$Y = \Phi(W) + S^{-1} (\Delta t \Psi_1(W) + \Delta t^2 \Psi_2(W) + \Delta t^3 \Psi_3(W)) + O(\Delta t^4)$$

partial differential equation for the conserved moments

$$\partial_t W + \Gamma_1(W) + \Delta t \Gamma_2(W) + \Delta t^2 \Gamma_3(W) + \Delta t^3 \Gamma_4(W) = O(\Delta t^4)$$

third order terms

$$\Psi_2(W) = \Sigma d\Psi_1(W) \cdot \Gamma_1(W) + d\Phi(W) \cdot \Gamma_2(W) - D \Sigma \Psi_1(W)$$

$$\Gamma_3(W) = B \Sigma \Psi_2(W) + \frac{1}{12} B_2 \Psi_1(W) - \frac{1}{6} B d\Psi_1(W) \cdot \Gamma_1(W)$$

fourth order terms

$$\Psi_3(W) = \Sigma d\Psi_1(W) \cdot \Gamma_2(W) + d\Phi(W) \cdot \Gamma_3(W) - D \Sigma \Psi_2(W)$$

$$+ \Sigma d\Psi_2(W) \cdot \Gamma_1(W) + \frac{1}{6} D d\Psi_1(W) \cdot \Gamma_1(W)$$

$$- \frac{1}{12} D_2 \Psi_1(W) - \frac{1}{12} \partial^2 \Psi_1(W) \cdot \Gamma_1(W)$$

$$\Gamma_4(W) = B \Sigma \Psi_3(W) + \frac{1}{4} B_2 \Psi_2(W) + \frac{1}{6} B D_2 \Sigma \Psi_1(W)$$

$$- \frac{1}{6} A B \Psi_2(W) - \frac{1}{6} B (d\gamma_1(W) \cdot \Gamma_2(W)$$

$$+ d\gamma_2(W) \cdot \Gamma_1(W)) - \frac{1}{6} B \Sigma \partial^2 \Psi_1(W) \cdot \Gamma_1(W)$$

FD, Asymptotic Analysis, to appear.

Lattice Boltzmann for fluids...

mass

momentum

energy



Antoine Lavoisier
(1743 - 1794)

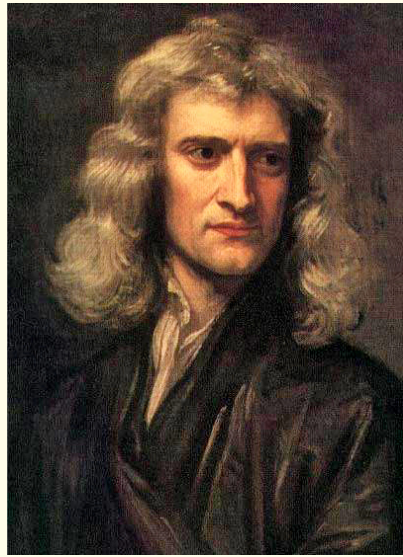

Isaac Newton
(1642 - 1727)

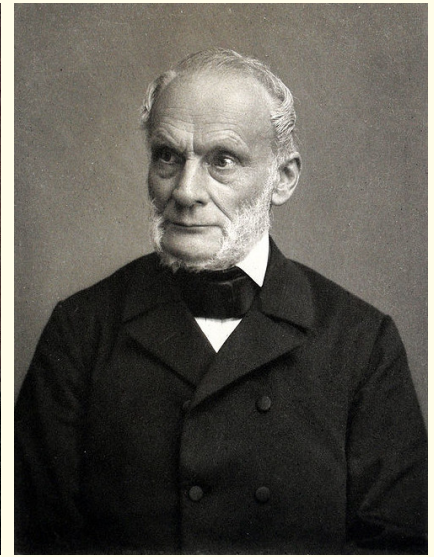

Rudolf Clausius
(1822 - 1888)

wikipedia

D2Q9

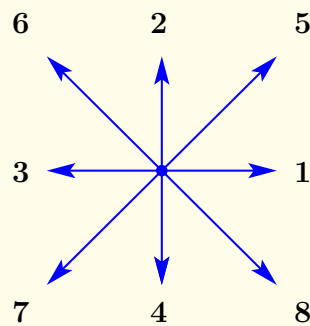

$$\lambda = \frac{\Delta x}{\Delta t}$$

$$M = \begin{bmatrix} 1 & 1 & 1 & 1 & 1 & 1 & 1 & 1 & 1 \\ 0 & \lambda & 0 & -\lambda & 0 & \lambda & -\lambda & -\lambda & \lambda \\ 0 & 0 & \lambda & 0 & -\lambda & \lambda & \lambda & -\lambda & -\lambda \\ -4\lambda^2 & -\lambda^2 & -\lambda^2 & -\lambda^2 & -\lambda^2 & 2\lambda^2 & 2\lambda^2 & 2\lambda^2 & 2\lambda^2 \\ 0 & \lambda^2 & -\lambda^2 & \lambda^2 & -\lambda^2 & 0 & 0 & 0 & 0 \\ 0 & 0 & 0 & 0 & 0 & \lambda^2 & -\lambda^2 & \lambda^2 & -\lambda^2 \\ 0 & -2\lambda^3 & 0 & 2\lambda^3 & 0 & \lambda^3 & -\lambda^3 & -\lambda^3 & \lambda^3 \\ 0 & 0 & -2\lambda^3 & 0 & 2\lambda^3 & \lambda^3 & \lambda^3 & -\lambda^3 & -\lambda^3 \\ 4\lambda^4 & -2\lambda^4 & -2\lambda^4 & -2\lambda^4 & -2\lambda^4 & \lambda^4 & \lambda^4 & \lambda^4 & \lambda^4 \end{bmatrix} \begin{matrix} \rho \\ J_x \\ J_y \\ \epsilon \\ xx \\ xy \\ q_x \\ q_y \\ h \end{matrix}$$

the lines of this invertible matrix are chosen orthogonal

D2Q9 (ii)

79

Momentum-velocity operator matrix $\Lambda \equiv M \text{diag}(\sum_{\alpha} v^{\alpha} \partial_{\alpha}) M^{-1}$
 $1 \leq \alpha \leq 2 = \text{space dimension}$

Block decomposition $\Lambda \equiv \begin{pmatrix} A & B \\ C & D \end{pmatrix}$

Operator matrix Λ for the isothermal D2Q9 scheme

ρ	J_x	J_y	ε	xx	xy	q_x	q_y	h	
0	∂_x	∂_y	0	0	0	0	0	0	ρ
$\frac{2\lambda^2}{3} \partial_x$	0	0	$\frac{1}{6} \partial_x$	$\frac{1}{2} \partial_x$	∂_y	0	0	0	J_x
$\frac{2\lambda^2}{3} \partial_y$	0	0	$\frac{1}{6} \partial_y$	$-\frac{1}{2} \partial_y$	∂_x	0	0	0	J_y
0	$\lambda^2 \partial_x$	$\lambda^2 \partial_y$	0	0	0	∂_x	∂_y	0	ε
0	$\frac{\lambda^2}{3} \partial_x$	$-\frac{\lambda^2}{3} \partial_y$	0	0	0	$-\frac{1}{3} \partial_x$	$\frac{1}{3} \partial_y$	0	xx
0	$\frac{2\lambda^2}{3} \partial_y$	$\frac{2\lambda^2}{3} \partial_x$	0	0	0	$\frac{1}{3} \partial_y$	$\frac{1}{3} \partial_x$	0	xy
0	0	0	$\frac{\lambda^2}{3} \partial_x$	$-\lambda^2 \partial_x$	$\lambda^2 \partial_y$	0	0	$\frac{1}{3} \partial_x$	q_x
0	0	0	$\frac{\lambda^2}{3} \partial_y$	$\lambda^2 \partial_y$	$\lambda^2 \partial_x$	0	0	$\frac{1}{3} \partial_y$	q_y
0	0	0	0	0	0	$\lambda^2 \partial_x$	$\lambda^2 \partial_y$	0	h

First order partial differential equations

80

at first order $\Gamma_1 = A W + B \Phi(W)$

$$\Gamma_1 = \begin{cases} \partial_x J_x + \partial_y J_y \\ \frac{2}{3} \lambda^2 \partial_x \rho + \frac{1}{6} \partial_x \Phi_{\varepsilon} + \frac{1}{2} \partial_x \Phi_{xx} + \partial_y \Phi_{xy} \\ \frac{2}{3} \lambda^2 \partial_y \rho + \frac{1}{6} \partial_y \Phi_{\varepsilon} - \frac{1}{2} \partial_y \Phi_{xx} + \partial_x \Phi_{xy} \end{cases}$$

first order terms of the Navier-Stokes equations (Euler equations)

$$\begin{cases} \partial_t \rho + \partial_x J_x + \partial_y J_y \\ \partial_t J_x + \partial_x \left(\frac{J_x^2}{\rho} + p \right) + \partial_y \left(\frac{J_x J_y}{\rho} \right) \\ \partial_t J_y + \partial_x \left(\frac{J_x J_y}{\rho} \right) + \partial_y \left(\frac{J_y^2}{\rho} + p \right) \end{cases}$$

identify the two expressions ($J_x \equiv \rho u$, $J_y \equiv \rho v$)

$$\begin{cases} \Phi_{\varepsilon} = 6p - 4\lambda^2 \rho + 3\rho(u^2 + v^2) \\ \Phi_{xx} = \rho(u^2 - v^2) \\ \Phi_{xy} = \rho u v \end{cases}$$

D2Q9 : towards second order equations

81

Φ : vector of moments at equilibrium

$$\Phi = (\Phi_\epsilon, \Phi_{xx}, \Phi_{xy}, \Phi_{qx}, \Phi_{qy}, \Phi_h)^t$$

$$\Psi_1 = d\Phi(W) \cdot \Gamma_1 - (C W + D \Phi(W)) \in \mathbb{R}^6$$

viscous fluxes $-\Delta t \Gamma_2 = -\Delta t B \Sigma \Psi_1 =$ physical fluxes ?

$$= \begin{cases} 0 \\ \partial_j \tau_{xj} \equiv \partial_x (2\mu \partial_x u + (\zeta - \mu)(\partial_x u + \partial_y v)) + \partial_y (\mu(\partial_x v + \partial_y u)) \\ \partial_j \tau_{yj} \equiv \partial_x (\mu(\partial_x v + \partial_y u)) + \partial_y ((\zeta - \mu)(\partial_x u + \partial_y v) + 2\mu \partial_y v) \end{cases}$$

try to avoid unphysical terms in $\partial_x \rho$ and $\partial_y \rho$

from the second order fluxes : **no solution** :-)

Linear system, $2 \times 2 \times 2 \times 3 = 24$ equations, $3 \times 2 = 6$ unknowns

discrepancy reduced to third order terms in velocity

if $\rho(\rho) = \frac{\lambda^2}{3} \rho$: isothermal fluid with $c_s = \frac{\lambda}{\sqrt{3}}$

$$\text{if } \Phi_{qx} = -\rho \lambda^2 u + 3\rho(u^2 + v^2)u$$

$$\Phi_{qy} = -\rho \lambda^2 v + 3\rho(u^2 + v^2)v$$

D2Q9 : towards second order equations (ii)

82

Given vector Φ of moments at equilibrium

$$\Phi_\epsilon = 3\rho(u^2 + v^2) - 2\lambda^2 \rho, \quad \Phi_{xx} = \rho(u^2 - v^2), \quad \Phi_{xy} = \rho u v$$

$$\Phi_{qx} = -\rho \lambda^2 u + 3\rho(u^2 + v^2)u, \quad \Phi_{qy} = -\rho \lambda^2 v + 3\rho(u^2 + v^2)v$$

Hénon matrix $\Sigma = \text{diag}(\sigma_e, \sigma_x, \sigma_x, *, * *)$

With $\mu = \frac{\lambda}{3} \rho \sigma_x \Delta x$ and $\zeta = \frac{\lambda}{3} \rho \sigma_e \Delta x$, we have

$$-\Delta t \Gamma_2 = \begin{pmatrix} 0 \\ \partial_j \tau_{xj} \\ \partial_j \tau_{yj} \end{pmatrix}$$

$$-\sigma_x \Delta t \partial_x \begin{pmatrix} 0 \\ u^3 \partial_x \rho - v^3 \partial_y \rho + 3\rho(u^2 \partial_x u - v^2 \partial_y v) \\ -v^3 \partial_x \rho - u^3 \partial_y \rho - 3\rho(u^2 \partial_y u + v^2 \partial_x v) \end{pmatrix}$$

$$-\sigma_x \Delta t \partial_y \begin{pmatrix} 0 \\ -v^3 \partial_x \rho - u^3 \partial_y \rho - 3\rho(u^2 \partial_y u + v^2 \partial_x v) \\ -u^3 \partial_x \rho + v^3 \partial_y \rho + 3\rho(-u^2 \partial_x u + v^2 \partial_y v) \end{pmatrix}$$

D2Q13

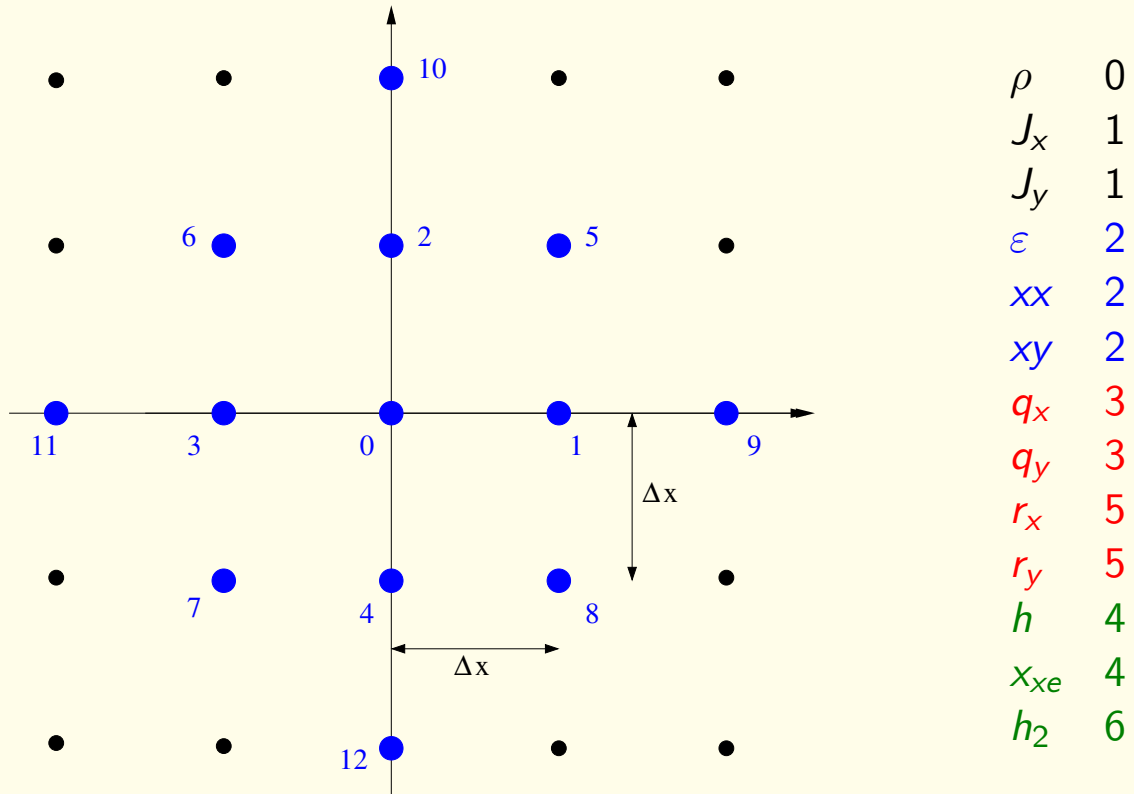

D2Q13: momentum-velocity operator matrix Λ

$$\Lambda = \begin{bmatrix}
 \rho & J_x & J_y & \epsilon & xx & xy & q_x & q_y & r_x & r_y & h & x_{xe} & h_2 \\
 0 & * \partial_x & * \partial_y & 0 & 0 & 0 & 0 & 0 & 0 & 0 & 0 & 0 & 0 \\
 * \partial_x & 0 & 0 & * \partial_x & * \partial_x & * \partial_y & 0 & 0 & 0 & 0 & 0 & 0 & 0 \\
 * \partial_y & 0 & 0 & * \partial_y & * \partial_y & * \partial_x & 0 & 0 & 0 & 0 & 0 & 0 & 0 \\
 0 & * \partial_x & * \partial_y & 0 & 0 & 0 & * \partial_x & * \partial_y & 0 & 0 & 0 & 0 & 0 \\
 0 & * \partial_x & * \partial_y & 0 & 0 & 0 & * \partial_x & * \partial_y & * \partial_x & * \partial_y & 0 & 0 & 0 \\
 0 & * \partial_y & * \partial_x & 0 & 0 & 0 & * \partial_y & * \partial_x & * \partial_y & * \partial_x & 0 & 0 & 0 \\
 0 & 0 & 0 & * \partial_x & * \partial_x & * \partial_y & 0 & 0 & 0 & 0 & * \partial_x & * \partial_x & 0 \\
 0 & 0 & 0 & * \partial_y & * \partial_y & * \partial_x & 0 & 0 & 0 & 0 & * \partial_y & * \partial_y & 0 \\
 0 & 0 & 0 & 0 & * \partial_x & * \partial_y & 0 & 0 & 0 & 0 & * \partial_x & * \partial_x & * \partial_x \\
 0 & 0 & 0 & 0 & * \partial_y & * \partial_x & 0 & 0 & 0 & 0 & * \partial_y & * \partial_y & * \partial_y \\
 0 & 0 & 0 & 0 & 0 & 0 & * \partial_x & * \partial_y & * \partial_x & * \partial_y & 0 & 0 & 0 \\
 0 & 0 & 0 & 0 & 0 & 0 & * \partial_x & * \partial_y & * \partial_x & * \partial_y & 0 & 0 & 0 \\
 0 & 0 & 0 & 0 & 0 & 0 & 0 & 0 & * \partial_x & * \partial_y & 0 & 0 & 0
 \end{bmatrix}$$

D2Q13: first order equations

85

$$\partial_t \rho + \partial_x J_x + \partial_y J_y = 0 \qquad \partial_t \rho + \partial_x J_x + \partial_y J_y = 0$$

$$\partial_t J_x + \partial_x \left(\frac{14}{13} \lambda^2 \rho + \frac{1}{26} \Phi_\varepsilon + \frac{1}{2} \Phi_{xx} \right) + \partial_y \Phi_{xy} = 0$$

$$\partial_t J_x + \partial_x (\rho u^2 + p) + \partial_y (\rho u v) = 0$$

$$\partial_t J_y + \partial_x \Phi_{xy} + \partial_y \left(\frac{14}{13} \lambda^2 \rho + \frac{1}{26} \Phi_\varepsilon - \frac{1}{2} \Phi_{xx} \right) = 0$$

$$\partial_t J_y + \partial_x (\rho u v) + \partial_y (\rho v^2 + p) = 0$$

then $\frac{14}{13} \lambda^2 \rho + \frac{1}{26} \Phi_\varepsilon + \frac{1}{2} \Phi_{xx} = \rho u^2 + p,$

and $\frac{14}{13} \lambda^2 \rho + \frac{1}{26} \Phi_\varepsilon - \frac{1}{2} \Phi_{xx} = \rho v^2 + p$

and $\Phi_{xx} = \rho(u^2 - v^2), \Phi_{xy} = \rho u v$

$\frac{28}{13} \lambda^2 \rho + \frac{1}{13} \Phi_\varepsilon = \rho(u^2 + v^2) + 2p$

then $\Phi_\varepsilon = 13 \rho(u^2 + v^2) + 26p - 28 \lambda^2 \rho$

The equilibrium values of the moments of **degree two** are fixed with the first order **Euler** equations

D2Q13 : second order equations

86

Φ : vector of moments at equilibrium

$$\Phi = (\Phi_\varepsilon, \Phi_{xx}, \Phi_{xy}, \Phi_{qx}, \Phi_{qy}, \Phi_{rx}, \Phi_{ry}, \Phi_h, \Phi_{xxe}, \Phi_{h2})^t$$

conservative first order fluxes

$$\Gamma_1 = \begin{bmatrix} \partial_x J_x + \partial_y J_y \\ \partial_x (\rho u^2 + p) + \partial_y (\rho u v) \\ \partial_x (\rho u v) + \partial_y (\rho v^2 + p) \end{bmatrix}$$

$$\Psi_1 = d\Phi(W) \cdot \Gamma_1 - (C W + D \Phi(W)) \in \mathbb{R}^6$$

viscous fluxes $-\Delta t \Gamma_2 = -\Delta t B \Sigma \Psi_1 =$ physical fluxes ?

$$= \begin{bmatrix} 0 \\ \partial_j \tau_{xj} \equiv \partial_x (2\mu \partial_x u + (\zeta - \mu)(\partial_x u + \partial_y v)) + \partial_y (\mu(\partial_x v + \partial_y u)) \\ \partial_j \tau_{yj} \equiv \partial_x (\mu(\partial_x v + \partial_y u)) + \partial_y ((\zeta - \mu)(\partial_x u + \partial_y v) + 2\mu \partial_y v) \end{bmatrix}$$

Linear system of $2 \times 2 \times 2 \times 3 = 24$ equations
for $3 \times 4 = 12$ partial derivatives

D2Q13 : second order equations (ii)

after identification, we find :

$\rho = \lambda^2 c_s^2 \rho$ and the parameter c_s is not constrained

$\Phi_{qx} = \rho (u^2 + v^2 + 4 \lambda^2 c_s^2 - 3 \lambda^2) u$

$\Phi_{qy} = \rho (u^2 + v^2 + 4 \lambda^2 c_s^2 - 3 \lambda^2) v$

$\Phi_{rx} = \rho \left(-\frac{7}{6} \lambda^2 u^2 - 7 \lambda^2 v^2 - \frac{21}{2} \lambda^4 c_s^2 + \frac{31}{6} \lambda^4 \right) u$

$\Phi_{ry} = \rho \left(-7 \lambda^2 u^2 - \frac{7}{6} \lambda^2 v^2 - \frac{21}{2} \lambda^4 c_s^2 + \frac{31}{6} \lambda^4 \right) v$

$\mu = \rho \sigma_x \lambda c_s^2 \Delta x$

$\zeta = \rho \sigma_e \lambda c_s^2 \Delta x$

ok compared to a pure human algebraic calculus (april 2015)

D3Q19

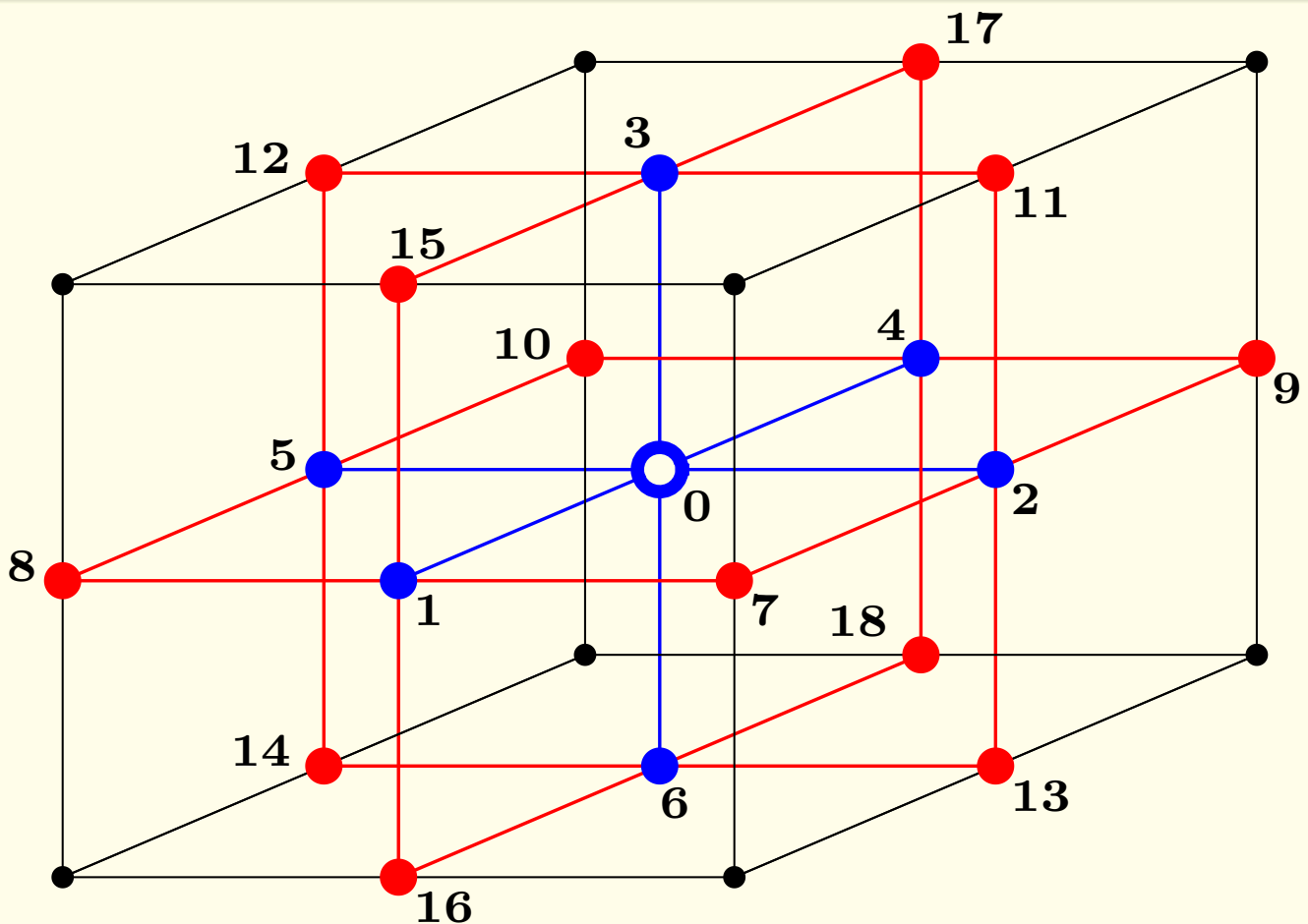

D3Q19 : non null elements of the Λ matrix

0	*	*	*	0	0	0	0	0	0	0	0	0	0	0	0	0	0	0	0
*	0	0	0	*	*	0	*	0	*	0	0	0	0	0	0	0	0	0	0
*	0	0	0	*	*	*	*	*	0	0	0	0	0	0	0	0	0	0	0
*	0	0	0	*	*	*	0	*	*	0	0	0	0	0	0	0	0	0	0
0	*	*	*	0	0	0	0	0	0	*	*	*	0	0	0	0	0	0	0
0	*	*	*	0	0	0	0	0	0	*	*	*	0	*	*	0	0	0	0
0	0	*	*	0	0	0	0	0	0	0	*	*	*	*	*	0	0	0	0
0	*	*	0	0	0	0	0	0	0	*	*	0	*	*	0	0	0	0	0
0	0	*	*	0	0	0	0	0	0	0	*	*	0	*	*	0	0	0	0
0	*	0	*	0	0	0	0	0	0	*	0	*	*	0	*	0	0	0	0
0	0	0	0	*	*	0	*	0	*	0	0	0	0	0	0	0	*	*	0
0	0	0	0	*	*	*	*	*	0	0	0	0	0	0	0	0	*	*	*
0	0	0	0	*	*	*	0	*	*	0	0	0	0	0	0	0	*	*	*
0	0	0	0	0	0	*	*	0	*	0	0	0	0	0	0	0	0	0	*
0	0	0	0	0	*	*	*	*	0	0	0	0	0	0	0	0	0	0	*
0	0	0	0	0	*	*	0	*	*	0	0	0	0	0	0	0	0	*	*
0	0	0	0	0	0	0	0	0	0	*	*	*	0	0	0	0	0	0	0
0	0	0	0	0	0	0	0	0	0	*	*	*	0	*	*	0	0	0	0
0	0	0	0	0	0	0	0	0	0	0	*	*	*	*	*	0	0	0	0

D3Q19 : moments

ρ 4 conserved
 j_x, j_y, j_z

ε 6 of degree 2 : fit the Euler equations
 xx, ww
 xy, yz, zx

q_x, q_y, q_z 6 to fit the viscous terms ?
 $x yz$
 $y zx$
 $z xy$

hh 3 without any influence
 xx_e, ww_e

D3Q19 : recovering first order isothermal equations

91

isothermal flow : $p \equiv c_s^2 \rho$

$$\Phi_\varepsilon = 19 \rho (u^2 + v^2 + w^2) - 30 \rho \lambda^2 + 57 \rho c_s^2$$

$$\Phi_{xx} = 2 \rho u^2 - \rho v^2 - \rho w^2$$

$$\Phi_{ww} = \rho v^2 - \rho w^2$$

$$\Phi_{xy} = \rho u v$$

$$\Phi_{yz} = \rho v w$$

$$\Phi_{zx} = \rho w u$$

Then
$$\begin{aligned} \partial_t \rho + \operatorname{div}(\rho \mathbf{u}) &= O(\Delta x) \\ \partial_t(\rho \mathbf{u}) + \operatorname{div}(\rho \mathbf{u} \otimes \mathbf{u}) + \nabla p &= O(\Delta x) \end{aligned}$$

the value of the sound velocity is not imposed at this step

D3Q19 : recovering second order equations...

92

at first order relative to velocity...

In particular, the relation $c_s = \frac{\lambda}{\sqrt{3}}$ is mandatory

A total of $3 \times 3 \times 4 \times 3 = 108$ equations to solve to identify the second order terms of the Navier Stokes equations

3 equations for momentum

3 conservation terms per equation : $\partial_x[**]$, $\partial_y[**]$ and $\partial_z[**]$

4 nonconserved variables ρ , u , v and w

3 partial derivatives ∂_x , ∂_y and ∂_z per variable

Expressions that concentrate the error to high order velocity terms

$$\Phi_{qx} = 5 \rho u (u^2 + v^2 + w^2) - \frac{2}{3} \rho u \lambda^2$$

$$\Phi_{qy} = 5 \rho v (u^2 + v^2 + w^2) - \frac{2}{3} \rho v \lambda^2$$

$$\Phi_{qz} = 5 \rho w (u^2 + v^2 + w^2) - \frac{2}{3} \rho w \lambda^2$$

$$\Phi_{x\ yz} = \rho u (v^2 - w^2), \quad \Phi_{y\ zx} = \rho v (w^2 - u^2)$$

$$\Phi_{z\ xy} = \rho w (u^2 - v^2)$$

A total of 61 equations remain unsolved

D3Q19 : recovering second order equations... (ii)

relaxation of second order moments

$$\begin{aligned} \varepsilon^* &= \varepsilon + s_e (\Phi_\varepsilon - \varepsilon), & xx^* &= xx + s_x (\Phi_{xx} - xx) \\ ww^* &= ww + s_x (\Phi_{ww} - ww), & xy^* &= xy + s_x (\Phi_{xy} - xy) \\ yz^* &= yz + s_x (\Phi_{yz} - yz), & zx^* &= zx + s_x (\Phi_{zx} - zx) \end{aligned}$$

Hénon relations : $\sigma_x \equiv \frac{1}{s_x} - \frac{1}{2}, \quad \sigma_e \equiv \frac{1}{s_e} - \frac{1}{2}$

shear viscosity $\mu = \frac{1}{3} \rho \sigma_x \Delta t (\lambda^2 + O(|\mathbf{u}|^2))$

bulk viscosity $\zeta = \frac{2}{9} \rho \sigma_e \Delta t (\lambda^2 + O(|\mathbf{u}|^2))$

tensor of viscosities

$$\begin{aligned} \tau_{xx} &= 2\mu \partial_x u + \left(\zeta - \frac{2}{3}\mu\right) \operatorname{div} \mathbf{u} \\ \tau_{yy} &= 2\mu \partial_y v + \left(\zeta - \frac{2}{3}\mu\right) \operatorname{div} \mathbf{u}, & \tau_{zz} &= 2\mu \partial_z w + \left(\zeta - \frac{2}{3}\mu\right) \operatorname{div} \mathbf{u} \\ \tau_{xy} &= \mu (\partial_x v + \partial_y u), & \tau_{yz} &= \mu (\partial_y w + \partial_z v), & \tau_{zx} &= \mu (\partial_z u + \partial_x w) \end{aligned}$$

Approximative isothermal Navier-Stokes equations at second order

$$\partial_t \rho + \operatorname{div}(\rho \mathbf{u}) = O(\Delta x^2)$$

$$\partial_t(\rho \mathbf{u}) + \operatorname{div}(\rho \mathbf{u} \otimes \mathbf{u}) + \nabla p - \Delta t \operatorname{div} \tau = \Delta x O(|\mathbf{u}|^3) + O(\Delta x^2)$$

D3Q27

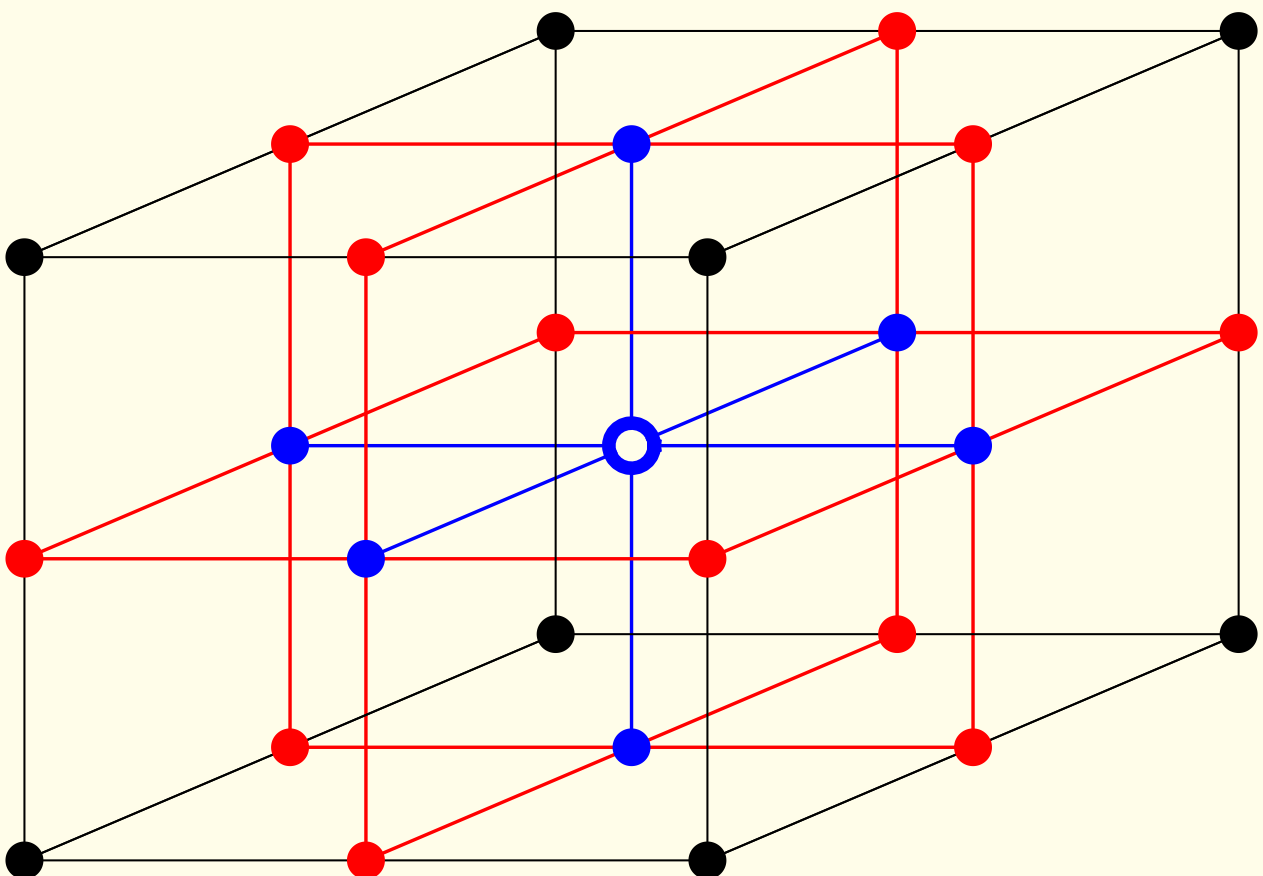

D3Q27 : recovering first order isothermal equations

97

isothermal flow : $p \equiv c_s^2 \rho$

$$\Phi_\epsilon = \rho(u^2 + v^2 + w^2) - 2\rho\lambda^2 + 3\rho c_s^2$$

$$\Phi_{xx} = 2\rho u^2 - \rho v^2 - \rho w^2$$

$$\Phi_{ww} = \rho v^2 - \rho w^2$$

$$\Phi_{xy} = \rho uv$$

$$\Phi_{yz} = \rho vw$$

$$\Phi_{zx} = \rho wu$$

Then

$$\partial_t \rho + \operatorname{div}(\rho \mathbf{u}) = O(\Delta x)$$

$$\partial_t(\rho \mathbf{u}) + \operatorname{div}(\rho \mathbf{u} \otimes \mathbf{u}) + \nabla p = O(\Delta x)$$

the value of the sound velocity is not imposed at this step
essentially analogous to the D3Q19 case...

D3Q27 : recovering second order equations...

98

The relation $c_s = \frac{\lambda}{\sqrt{3}}$ is now imposed

A total of $3 \times 3 \times 4 \times 3 = 108$ equations to solve to identify

Nonisotropic expressions for high order velocity terms errors

$$\Phi_{qx} = 3\rho u(u^2 + v^2 + w^2) - 2\rho u\lambda^2$$

$$\Phi_{qy} = 3\rho v(u^2 + v^2 + w^2) - 2\rho v\lambda^2$$

$$\Phi_{qz} = 3\rho w(u^2 + v^2 + w^2) - 2\rho w\lambda^2$$

$$\Phi_{x\ yz} = \rho u(v^2 - w^2) - \rho u^3$$

$$\Phi_{y\ zx} = \rho v(w^2 - u^2) + \rho v^3$$

$$\Phi_{z\ xy} = \rho w(u^2 - v^2) - \rho w^3$$

Approximative isothermal Navier-Stokes equations at second order

$$\partial_t \rho + \operatorname{div}(\rho \mathbf{u}) = O(\Delta x^2)$$

$$\partial_t(\rho \mathbf{u}) + \operatorname{div}(\rho \mathbf{u} \otimes \mathbf{u}) + \nabla p - \Delta t \operatorname{div} \tau = \Delta x O(|\mathbf{u}|^3) + O(\Delta x^2)$$

A total of 33 equations remain unsolved

(45 with the isotropic version!)

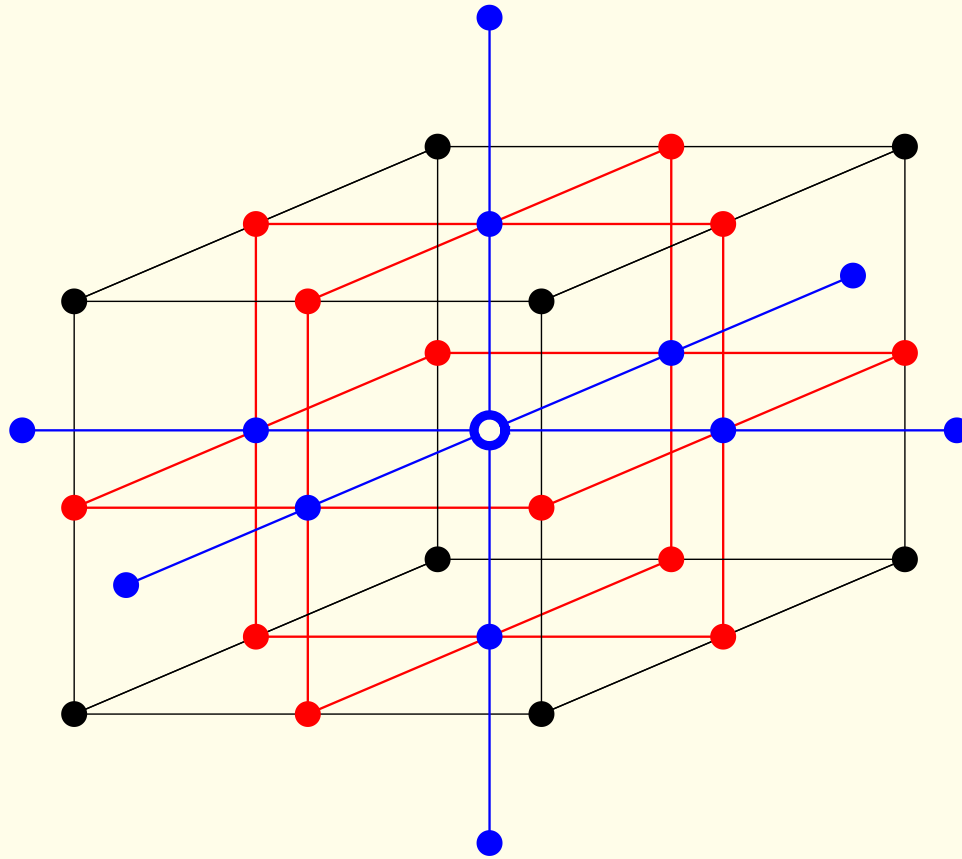

D3Q33 : moments

ρ, j_x, j_y, j_z

4 conserved

ε

6 of degree 2 : fit the Euler equations

xx, ww

xy, yz, zx

q_x, q_y, q_z

13 to fit the viscous terms

$x yz, y zx, z xy$

xyz

r_x, r_y, r_z

t_x, t_y, t_z

xx_e, ww_e

10 without any influence

xx_h, ww_h

xy_e, yz_e, zx_e

$hh, h2, h4$

D3Q33 : second order partial differential equations

103

the 108 equations are completely solved !

algebraic nonlinear expressions for high order moments

$$\begin{aligned}
\Phi_{qx} &= 13 \rho u (u^2 + v^2 + w^2) - 37 \rho u \lambda^2 + 65 \rho u c_s^2 \\
\Phi_{qy} &= 13 \rho v (u^2 + v^2 + w^2) - 37 \rho v \lambda^2 + 65 \rho v c_s^2 \\
\Phi_{qz} &= 13 \rho w (u^2 + v^2 + w^2) - 37 \rho w \lambda^2 + 65 \rho w c_s^2 \\
\Phi_{x\ yz} &= \rho u (v^2 - w^2) \\
\Phi_{y\ zx} &= \rho v (w^2 - u^2) \\
\Phi_{z\ xy} &= \rho w (u^2 - v^2) \\
\Phi_{xyz} &= \rho u v w \\
\Phi_{rx} + \frac{38}{13} \frac{1}{\lambda^2} \Phi_{tx} &= -\frac{161}{39} \rho u^3 \lambda^2 - \frac{345}{13} \rho u (v^2 + w^2) \\
&\quad + \frac{1265}{39} \rho u \lambda^4 - \frac{2553}{39} \rho u \lambda^2 c_s^2 \\
\Phi_{ry} + \frac{38}{13} \frac{1}{\lambda^2} \Phi_{ty} &= -\frac{161}{39} \rho v^3 \lambda^2 - \frac{345}{13} \rho v (w^2 + u^2) \\
&\quad + \frac{1265}{39} \rho v \lambda^4 - \frac{2553}{39} \rho v \lambda^2 c_s^2 \\
\Phi_{rz} + \frac{38}{13} \frac{1}{\lambda^2} \Phi_{tz} &= -\frac{161}{39} \rho w^3 \lambda^2 - \frac{345}{13} \rho w (u^2 + v^2) \\
&\quad + \frac{1265}{39} \rho w \lambda^4 - \frac{2553}{39} \rho w \lambda^2 c_s^2
\end{aligned}$$

D3Q33 : second order partial differential equations (ii) 104

relaxation of second order moments

$$\begin{aligned}
\varepsilon^* &= \varepsilon + s_e (\Phi_\varepsilon - \varepsilon), \quad xx^* = xx + s_x (\Phi_{xx} - xx) \\
ww^* &= ww + s_x (\Phi_{ww} - ww), \quad xy^* = xy + s_x (\Phi_{xy} - xy) \\
yz^* &= yz + s_x (\Phi_{yz} - yz), \quad zx^* = zx + s_x (\Phi_{zx} - zx)
\end{aligned}$$

Hénon relations : $\sigma_x \equiv \frac{1}{s_x} - \frac{1}{2}$, $\sigma_e \equiv \frac{1}{s_e} - \frac{1}{2}$ shear viscosity $\mu = \rho c_s^2 \lambda \sigma_x \Delta x$ bulk viscosity $\zeta = \frac{2}{3} \rho c_s^2 \lambda \sigma_e \Delta x$

tensor of viscosities

$$\begin{aligned}
\tau_{xx} &= 2 \mu \partial_x u + \left(\zeta - \frac{2}{3} \mu\right) \operatorname{div} \mathbf{u} \\
\tau_{yy} &= 2 \mu \partial_y v + \left(\zeta - \frac{2}{3} \mu\right) \operatorname{div} \mathbf{u} \\
\tau_{zz} &= 2 \mu \partial_z w + \left(\zeta - \frac{2}{3} \mu\right) \operatorname{div} \mathbf{u} \\
\tau_{xy} &= \mu (\partial_x v + \partial_y u), \quad \tau_{yz} = \mu (\partial_y w + \partial_z v), \quad \tau_{zx} = \mu (\partial_z u + \partial_x w)
\end{aligned}$$

Isothermal Navier-Stokes equations satisfied at second order :-)

$$\partial_t \rho + \operatorname{div}(\rho \mathbf{u}) = \mathcal{O}(\Delta x^2)$$

$$\partial_t(\rho \mathbf{u}) + \operatorname{div}(\rho \mathbf{u} \otimes \mathbf{u}) + \nabla p - \Delta t \operatorname{div} \tau = \mathcal{O}(\Delta x^2)$$

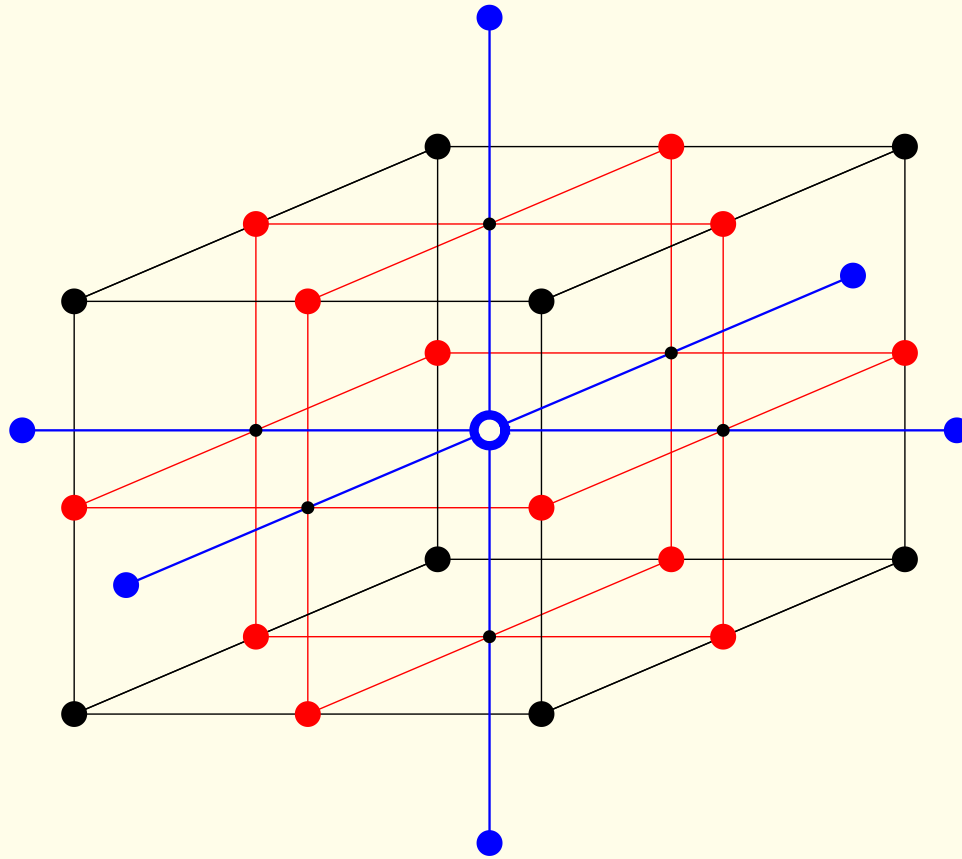

ρ, j_x, j_y, j_z 4 conserved

ε 6 of degree 2 : fit the Euler equations

xx, ww

xy, yz, zx

q_x, q_y, q_z 10 to fit the viscous terms

$x yz, y zx, z xy$

xyz

r_x, r_y, r_z

hh 7 without influence on the Navier-Stokes equations

xx_e, ww_e

xy_e, yz_e, zx_e

h^2

D3Q27-2 allows to recover isothermal Navier Stokes ! 107

isothermal flow : $\rho \equiv c_s^2 \rho$, c_s is a priori **not imposed**

$$\Phi_\epsilon = 3\rho(u^2 + v^2 + w^2) - 8\rho\lambda^2 + 9\rho c_s^2$$

$$\Phi_{xx} = 2\rho u^2 - \rho v^2 - \rho w^2$$

$$\Phi_{ww} = \rho v^2 - \rho w^2$$

$$\Phi_{xy} = \rho uv, \quad \Phi_{yz} = \rho vw, \quad \Phi_{zx} = \rho wu$$

$$\Phi_{qx} = \rho u(u^2 + v^2 + w^2) - 3\rho u\lambda^2 + 5\rho u c_s^2$$

$$\Phi_{qy} = \rho v(u^2 + v^2 + w^2) - 3\rho v\lambda^2 + 5\rho v c_s^2$$

$$\Phi_{qz} = \rho w(u^2 + v^2 + w^2) - 3\rho w\lambda^2 + 5\rho w c_s^2$$

$$\Phi_{x\ yz} = \rho u(v^2 - w^2)$$

$$\Phi_{y\ zx} = \rho v(w^2 - u^2)$$

$$\Phi_{z\ xy} = \rho w(u^2 - v^2)$$

$$\Phi_{xyz} = \rho uvw$$

$$\Phi_{rx} = \rho\lambda^2(5\lambda^2 - 9c_s^2)u - \rho\lambda^2 u(u^3 + 3v^2 + 3w^2)$$

$$\Phi_{ry} = \rho\lambda^2(5\lambda^2 - 9c_s^2)v - \rho\lambda^2 v(v^3 + 3w^2 + 3u^2)$$

$$\Phi_{rz} = \rho\lambda^2(5\lambda^2 - 9c_s^2)w - \rho\lambda^2 w(w^3 + 3u^2 + 3v^2)$$

viscosities $\mu = \rho c_s^2 \sigma_x \Delta t$, $\zeta = \frac{2}{3} \rho c_s^2 \sigma_e \Delta t$

Navier - Stokes with conservation of energy 108

... in one space dimension

conserved variables $\rho, J \equiv \rho u, E = \frac{1}{2} \rho u^2 + \rho e$

polytropic perfect gas $p = (\gamma - 1) \rho e, e = c_v T, \gamma = \frac{c_p}{c_v}$

Prandtl number $Pr = \frac{\mu c_p}{\kappa}$

mass conservation $\partial_t \rho + \partial_x(\rho u) = 0$

momentum conservation $\partial_t(\rho u) + \partial_x(\rho u^2 + p) - \partial_x(\mu \partial_x u) = 0$

energy conservation

$$\partial_t E + \partial_x(E u + p u) - \partial_x(\mu u \partial_x u) - \frac{\gamma}{Pr} \partial_x(\mu \partial_x e) = 0$$

Fourier law of heat dissipation $-\frac{\gamma}{Pr} \partial_x(\mu \partial_x e)$

viscous work $\partial_x(\mu u \partial_x u)$

De Vahl Davis thermal test case for natural convection 109

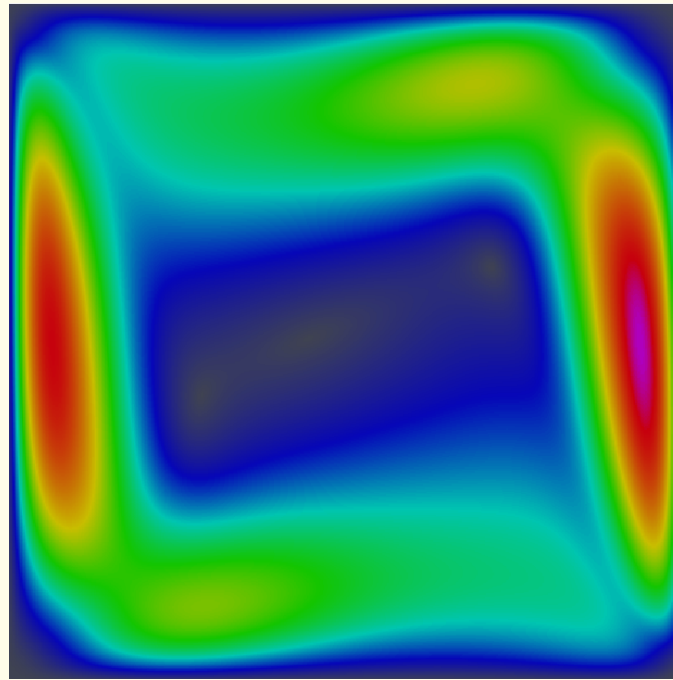

Rayleigh number = 10^5 , Prandtl number = 0.71

D2Q13 lattice Boltzmann scheme with a **single particle distribution**

Iso-velocity curves for the modulus of the fluid speed

[Pierre Lallemand and FD, CiCP, 2015]

D2Q13

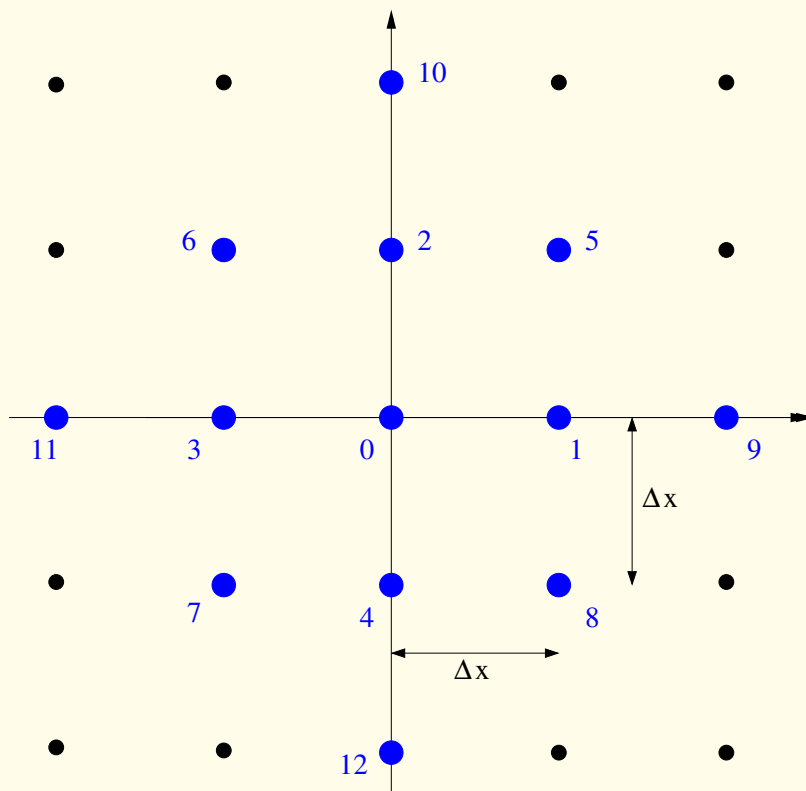

ρ	0
J_x	1
J_y	1
ε	2
xx	2
xy	2
q_x	3
q_y	3
r_x	5
r_y	5
h	4
x_{xe}	4
h_2	6

D2Q13: first order equations

113

$$\partial_t \rho + \partial_x J_x + \partial_y J_y = 0 \qquad \partial_t \rho + \partial_x J_x + \partial_y J_y = 0$$

$$\partial_t J_x + \partial_x \left(\frac{14}{13} \lambda^2 \rho + \frac{1}{26} \varepsilon + \frac{1}{2} \Phi_{xx} \right) + \partial_y \Phi_{xy} = 0$$

$$\partial_t J_x + \partial_x (\rho u^2 + p) + \partial_y (\rho u v) = 0$$

$$\partial_t J_y + \partial_x \Phi_{xy} + \partial_y \left(\frac{14}{13} \lambda^2 \rho + \frac{1}{26} \varepsilon - \frac{1}{2} \Phi_{xx} \right) = 0$$

$$\partial_t J_y + \partial_x (\rho u v) + \partial_y (\rho v^2 + p) = 0$$

$$\partial_t \varepsilon + 11 \lambda^2 (\partial_x J_x + \partial_y J_y) + 13 (\partial_x \Phi_{qx} + \partial_y \Phi_{qy}) = 0$$

$$\partial_t E + \partial_x (E u + p u) + \partial_y (E v + p v) = 0$$

then $\frac{14}{13} \lambda^2 \rho + \frac{1}{26} \varepsilon + \frac{1}{2} \Phi_{xx} = \rho u^2 + p, \quad \Phi_{xy} = \rho u v$

$\frac{14}{13} \lambda^2 \rho + \frac{1}{26} \varepsilon - \frac{1}{2} \Phi_{xx} = \rho v^2 + p \quad \text{and} \quad \Phi_{xx} = \rho (u^2 - v^2)$

Lattice Boltzmann : $\frac{28}{13} \lambda^2 \rho + \frac{1}{13} \varepsilon = \rho (u^2 + v^2) + 2p$ is conserved

Physics : $E \equiv \frac{1}{2} \rho (u^2 + v^2) + e$ is conserved

then $p = \rho e, \quad \gamma = 2$ and $\varepsilon = 26 E - 28 \lambda^2 \rho$

$$\Phi_{qx} = \frac{1}{13} \varepsilon u + 2 p u - \frac{11}{13} \lambda^2 \rho u, \quad \Phi_{qy} = \frac{1}{13} \varepsilon v + 2 p v - \frac{11}{13} \lambda^2 \rho v$$

D2Q13: towards second order equations

114

Φ : vector of moments at equilibrium

$$\Phi = (\Phi_{xx}, \Phi_{xy}, \Phi_{qx}, \Phi_{qy}, \Phi_{rx}, \Phi_{ry}, \Phi_h, \Phi_{xxe}, \Phi_{h2})^t$$

$$\Psi_1 = d\Phi(W) \cdot \Gamma_1 - (C W + D \Phi(W)) \in \mathbb{R}^9$$

viscous fluxes $-\Delta t \Gamma_2 = -\Delta t B \Sigma \Psi_1 = \text{physical fluxes ?}$

$$= \begin{bmatrix} 0 \\ \partial_j \sigma_{xj} \equiv \partial_x (2 \mu \partial_x u + (\zeta - \mu) (\partial_x u + \partial_y v)) + \partial_y (\mu (\partial_x v + \partial_y u)) \\ \partial_j \sigma_{yj} \equiv \partial_x (\mu (\partial_x v + \partial_y u)) + \partial_y ((\zeta - \mu) (\partial_x u + \partial_y v) + 2 \mu \partial_y v) \\ 26 [\partial_j (u_i \sigma_{ij}) + \frac{\gamma}{Pr} (\partial_x (\mu \partial_x e) + \partial_y (\mu \partial_y e))] \end{bmatrix}$$

$$\Phi_{rx} = \frac{31}{6} \rho \lambda^4 u + \frac{7}{6} \lambda^2 (u^2 + 6 v^2) \rho u - \frac{21}{2} e u$$

$$\Phi_{ry} = \frac{31}{6} \rho \lambda^4 v + \frac{7}{6} \lambda^2 (6 u^2 + v^2) \rho v - \frac{21}{2} e v$$

$$\Phi_h = 140 \lambda^4 \rho - 361 \lambda^2 \rho e - \frac{361}{2} \lambda^2 \rho (u^2 + v^2) + \frac{77}{2} \rho (u^2 + v^2)^2 + 308 (u^2 + v^2 + e) e$$

$$\Phi_{xxe} = -\frac{65}{12} \lambda^2 \rho (u^2 - v^2) + \frac{17}{12} \rho (u^4 - v^4) + \frac{17}{2} \rho (u^2 + v^2)$$

important remaining discrepancies !

viscosities: $\mu = 2 \rho e \sigma_x \Delta t, \quad \zeta = \mu$

D2Q17

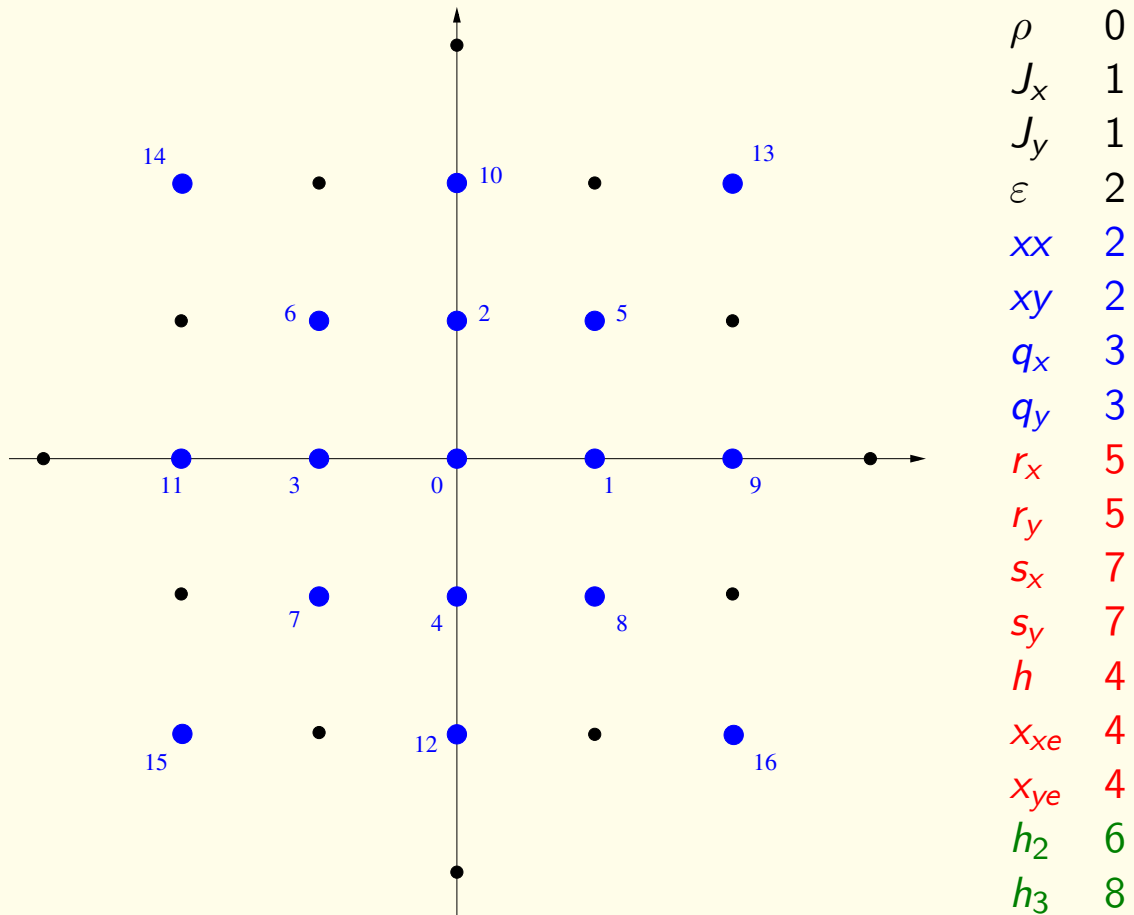

D2Q17 : non null elements of the Λ matrix

0	*	*	0	0	0	0	0	0	0	0	0	0	0	0	0	0
*	0	0	*	*	*	0	0	0	0	0	0	0	0	0	0	0
*	0	0	*	*	*	0	0	0	0	0	0	0	0	0	0	0
0	*	*	0	0	0	*	*	0	0	0	0	0	0	0	0	0
0	*	*	0	0	0	*	*	*	*	*	*	0	0	0	0	0
0	*	*	0	0	0	*	*	*	*	*	*	0	0	0	0	0
0	0	0	*	*	*	0	0	0	0	0	0	*	*	*	0	0
0	0	0	*	*	*	0	0	0	0	0	0	*	*	*	0	0
0	0	0	0	*	*	0	0	0	0	0	0	*	*	*	*	0
0	0	0	0	*	*	0	0	0	0	0	0	0	*	*	*	*
0	0	0	0	*	*	0	0	0	0	0	0	0	*	*	*	*
0	0	0	0	0	0	*	*	*	*	0	0	0	0	0	0	0
0	0	0	0	0	0	*	*	*	*	*	*	0	0	0	0	0
0	0	0	0	0	0	*	*	*	*	*	*	0	0	0	0	0
0	0	0	0	0	0	0	0	*	*	*	*	0	0	0	0	0
0	0	0	0	0	0	0	0	0	0	*	*	0	0	0	0	0

D2Q17: first order equations

117

$$\partial_t \rho + \partial_x J_x + \partial_y J_y = 0 \qquad \partial_t \rho + \partial_x J_x + \partial_y J_y = 0$$

$$\partial_t J_x + \partial_x \left(\frac{30}{17} \lambda^2 \rho + \frac{1}{34} \varepsilon + \frac{1}{2} \Phi_{xx} \right) + \partial_y \Phi_{xy} = 0$$

$$\partial_t J_x + \partial_x (\rho u^2 + p) + \partial_y (\rho u v) = 0$$

$$\partial_t J_y + \partial_x \Phi_{xy} + \partial_y \left(\frac{30}{17} \lambda^2 \rho + \frac{1}{34} \varepsilon - \frac{1}{2} \Phi_{xx} \right) = 0$$

$$\partial_t J_y + \partial_x (\rho u v) + \partial_y (\rho v^2 + p) = 0$$

$$\partial_t \varepsilon + \frac{109}{3} \lambda^2 (\partial_x J_x + \partial_y J_y) + \frac{17}{3} (\partial_x q_x + \partial_y q_y) = 0$$

$$\partial_t E + \partial_x (E u + p u) + \partial_y (E v + p v) = 0$$

$$\text{then } \frac{30}{17} \lambda^2 \rho + \frac{1}{34} \varepsilon + \frac{1}{2} \Phi_{xx} = \rho u^2 + p, \qquad \Phi_{xy} = \rho u v$$

$$\frac{30}{17} \lambda^2 \rho + \frac{1}{34} \varepsilon - \frac{1}{2} \Phi_{xx} = \rho v^2 + p \quad \text{and} \quad \Phi_{xx} = \rho (u^2 - v^2)$$

$$\frac{60}{17} \lambda^2 \rho + \frac{1}{17} \varepsilon = \rho (u^2 + v^2) + 2p \quad \text{is conserved}$$

$$\text{then } p = \rho e \quad \text{and} \quad \gamma = 2$$

$$\text{then } \varepsilon = 34 E - 60 \lambda^2 \rho$$

D2Q17: first order equations (ii)

118

$$\varepsilon = 34 E - 60 \lambda^2 \rho, \quad p = \frac{1}{34} \varepsilon - \frac{1}{2} \rho (u^2 + v^2) + \frac{30}{17} \lambda^2 \rho \rho e$$

$$\partial_t \varepsilon + \frac{109}{3} \lambda^2 (\partial_x J_x + \partial_y J_y) + \frac{17}{3} (\partial_x q_x + \partial_y q_y) = 0$$

$$\partial_t (34 E - 60 \lambda^2 \rho) + \partial_x (\varepsilon u + 34 p u) + \partial_y (\varepsilon v + 34 p v) = 0$$

$$\text{then } \Phi_{qx} = \frac{6}{17} \varepsilon u + \frac{71}{17} \lambda^2 \rho u - 3 \rho (u^2 + v^2) u$$

$$\Phi_{qy} = \frac{6}{17} \varepsilon v + \frac{71}{17} \lambda^2 \rho v - 3 \rho (u^2 + v^2) v$$

Φ : vector of moments at equilibrium

$$\Phi = \begin{pmatrix} \Phi_{xx}, \Phi_{xy}, \Phi_{qx}, \Phi_{qy} \\ \Phi_{rx}, \Phi_{ry}, \Phi_{sx}, \Phi_{sy}, \Phi_h, \Phi_{xxe}, \Phi_{xye} \\ \Phi_{h2}, \Phi_{h3} \end{pmatrix}$$

D2Q17: second order equations

Linear system of $3 \times 2 \times 2 \times 4 = 48$ equations
for $4 \times 7 = 28$ partial derivatives

Possible reconstruction of the nonlinear functions :

$$\Phi_{sx} + \frac{31}{2} \lambda^2 \Phi_{rx} = \frac{221}{4} \rho \lambda^6 u - \frac{101}{4} \rho \lambda^4 u^3 + \frac{27}{2} \rho \lambda^4 u v^2 - \frac{249}{4} \rho \lambda^4 u e$$

$$\Phi_{sy} + \frac{31}{2} \lambda^2 \Phi_{ry} = \frac{221}{4} \rho \lambda^6 v - \frac{101}{4} \rho \lambda^4 v^3 + \frac{27}{2} \rho \lambda^4 u^2 v - \frac{249}{4} \rho \lambda^4 v e$$

$$\Phi_h = 620 \rho \lambda^4 + \frac{109}{2} \rho (u^2 + v^2)^2 + 436 \rho (u^2 + v^2) e + 436 \rho e^2 - \frac{969}{2} \rho \lambda^2 (u^2 + v^2 + 2e)$$

$$\Phi_{xxe} = -\frac{65}{12} \rho \lambda^2 (u^2 - v^2) + \frac{17}{12} \rho (u^4 - v^4) + \frac{17}{2} \rho (u^2 - v^2) e$$

$$\Phi_{xye} = -\frac{65}{12} \rho \lambda^2 u v + \frac{17}{24} \rho (u^2 + v^2) u v$$

Viscosities: $\mu = \rho e \sigma_x \Delta t$ and $\zeta = 0$

Satisfy the relation $\sigma_x = \sigma_q$

Prandtl number : $Pr = 1$

and all the equations are satisfied :-)

D2V17 of Philippi and Hegele

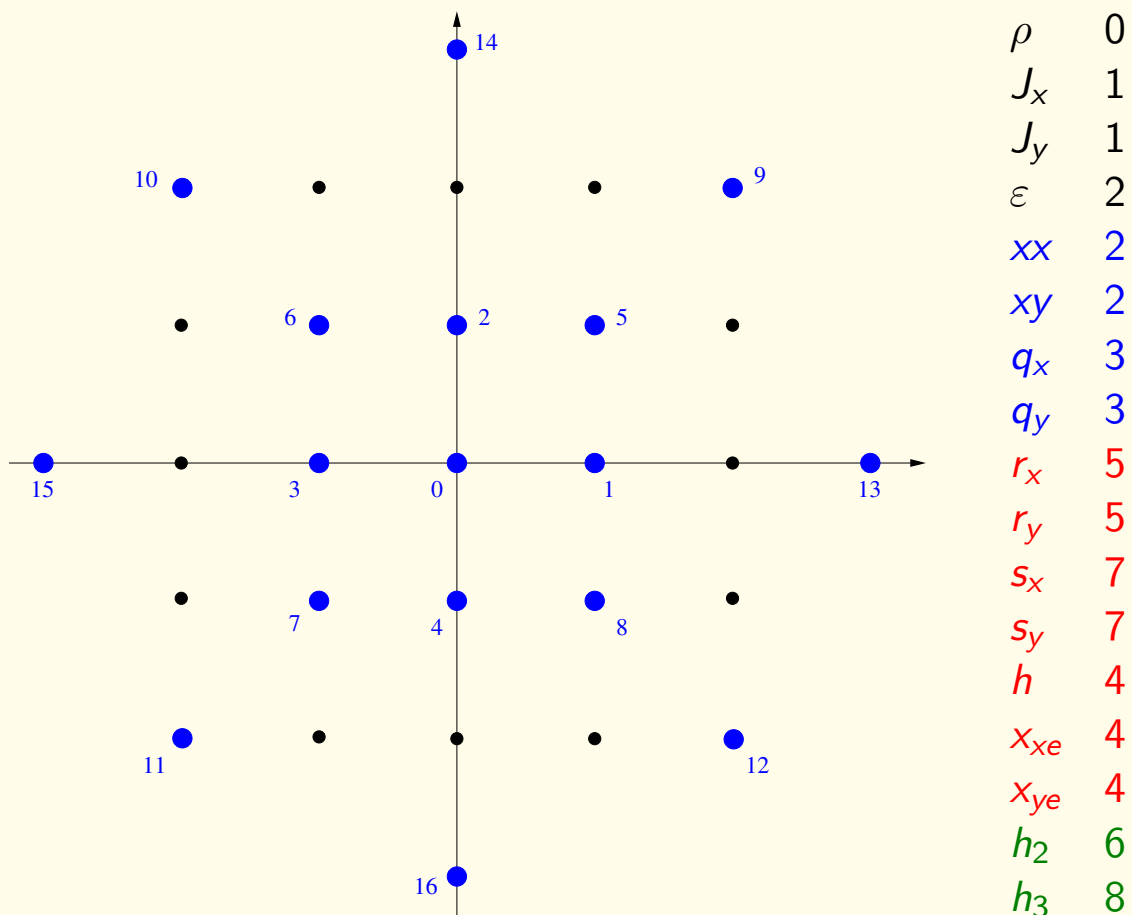



Paulo-Cesar Philippi
PUC-PR
Curitiba (Paraná)



Luis Hegele
Santa Catarina State Univ.
Florianopolis

D2V17 : non null elements of the Λ matrix

0	*	*	0	0	0	0	0	0	0	0	0	0	0	0	0	0
*	0	0	*	*	*	0	0	0	0	0	0	0	0	0	0	0
*	0	0	*	*	*	0	0	0	0	0	0	0	0	0	0	0
0	*	*	0	0	0	*	*	0	0	0	0	0	0	0	0	0
0	*	*	0	0	0	*	*	*	*	*	*	0	0	0	0	0
0	*	*	0	0	0	*	*	*	*	*	*	0	0	0	0	0
0	0	0	*	*	*	0	0	0	0	0	0	*	*	*	0	0
0	0	0	*	*	*	0	0	0	0	0	0	*	*	*	0	0
0	0	0	0	*	*	0	0	0	0	0	0	*	*	*	*	0
0	0	0	0	*	*	0	0	0	0	0	0	*	*	*	*	0
0	0	0	0	*	*	0	0	0	0	0	0	0	*	*	*	*
0	0	0	0	0	0	*	*	*	*	0	0	0	0	0	0	0
0	0	0	0	0	0	*	*	*	*	*	*	0	0	0	0	0
0	0	0	0	0	0	*	*	*	*	*	*	0	0	0	0	0
0	0	0	0	0	0	0	0	*	*	*	*	0	0	0	0	0
0	0	0	0	0	0	0	0	0	0	*	*	0	0	0	0	0

D2V17: first order equations

123

$$\begin{aligned}
\partial_t \rho + \partial_x J_x + \partial_y J_y &= 0 & \partial_t \rho + \partial_x J_x + \partial_y J_y &= 0 \\
\partial_t J_x + \partial_x \left(\frac{1}{2} \Phi_{xx} + \frac{1}{34} \varepsilon + \frac{40}{17} \rho \lambda^2 \right) + \partial_y \Phi_{xy} &= 0 & \partial_t J_x + \partial_x (\rho u^2 + p) + \partial_y (\rho u v) &= 0 \\
\partial_t J_y + \partial_x \Phi_{xy} + \partial_y \left(-\frac{1}{2} \Phi_{xx} + \frac{1}{34} \varepsilon + \frac{40}{17} \rho \lambda^2 \right) - \frac{1}{2} \Phi_{xx} &= 0 & \partial_t J_y + \partial_x (\rho u v) + \partial_y (\rho v^2 + p) &= 0 \\
\partial_t \varepsilon + \frac{95}{2} \lambda^2 (\partial_x J_x + \partial_y J_y) + \frac{17}{2} (\partial_x \Phi_{qx} + \partial_y \Phi_{qy}) &= 0 & \partial_t E + \partial_x (E u + p u) + \partial_y (E v + p v) &= 0
\end{aligned}$$

Then

$$\begin{aligned}
\frac{1}{2} \Phi_{xx} + \frac{1}{34} \varepsilon + \frac{40}{17} \rho \lambda^2 &= \rho u^2 + p \\
-\frac{1}{2} \Phi_{xx} + \frac{1}{34} \varepsilon + \frac{40}{17} \rho \lambda^2 &= \rho v^2 + p \\
\Phi_{xy} = \rho u v \quad \text{and} \quad \Phi_{xx} &= \rho (u^2 - v^2) \\
\frac{1}{34} \varepsilon + \frac{40}{17} \rho \lambda^2 &= \frac{1}{2} \rho (u^2 + v^2) + p \\
\text{so } \frac{1}{2} \rho (u^2 + v^2) + p &\text{ must be conserved and } \gamma = 2 \\
\text{in consequence, } \frac{1}{34} \varepsilon + \frac{40}{17} \rho \lambda^2 &= E \equiv \frac{1}{2} \rho (u^2 + v^2) + p e \\
\varepsilon &= 34 E - 80 \lambda^2 \rho
\end{aligned}$$

D2V17: first order equations (ii)

124

$$\begin{aligned}
\varepsilon &= 34 E - 80 \lambda^2 \rho = 17 \rho (u^2 + v^2) + 34 \rho e - 80 \rho \lambda^2 \\
\partial_t \varepsilon + \frac{95}{2} \lambda^2 (\partial_x J_x + \partial_y J_y) + \frac{17}{2} (\partial_x \Phi_{qx} + \partial_y \Phi_{qy}) &= 0 \\
\partial_t E + \partial_x (E u + p u) + \partial_y (E v + p v) &= 0 \\
\partial_t \varepsilon + \partial_x (\varepsilon u + 34 p u) + \partial_y (\varepsilon v + 34 p v) &= 0
\end{aligned}$$

then

$$\begin{aligned}
\frac{95}{2} \lambda^2 J_x + \frac{17}{2} \Phi_{qx} &= \varepsilon u + 34 p u \\
\frac{95}{2} \lambda^2 J_y + \frac{17}{2} \Phi_{qy} &= \varepsilon v + 34 p v
\end{aligned}$$

and

$$\begin{aligned}
\Phi_{qx} &= \frac{2}{17} \varepsilon u + 4 p u - \frac{95}{17} \lambda^2 J_x \\
\Phi_{qy} &= \frac{2}{17} \varepsilon v + 4 p v - \frac{95}{17} \lambda^2 J_y \\
\Phi_{qx} &= (2 |\mathbf{u}|^2 + 8 e - 15 \lambda^2) \rho u \\
\Phi_{qy} &= (2 |\mathbf{u}|^2 + 8 e - 15 \lambda^2) \rho v
\end{aligned}$$

D2V17: second order equations

125

Reconstruction of the nonlinear functions :

$$\Phi_{rx} + \frac{5}{3} \lambda^2 \Phi_{sx} = \frac{1}{9} \rho \lambda^2 u^3 - \frac{8}{3} \rho \lambda^2 u v^2 - \frac{7}{3} \rho \lambda^2 u e + \frac{35}{9} \rho \lambda^4 u$$

$$\Phi_{ry} + \frac{5}{3} \lambda^2 \Phi_{sy} = -\frac{8}{3} \rho \lambda^2 u^2 v + \frac{1}{9} \rho \lambda^2 v^3 - \frac{7}{3} \rho \lambda^2 v e + \frac{35}{9} \rho \lambda^4 v$$

$$\Phi_h = \frac{19}{2} \rho (u^2 + v^2)^2 + 76 \rho (u^2 + v^2) e - \frac{185}{2} \rho \lambda^2 (u^2 + v^2) + 76 \rho e^2 - \frac{185}{2} \rho \lambda^2 e + 100 \rho \lambda^4$$

$$\Phi_{xxe} = \frac{41}{36} \rho (u^4 - v^4) + \frac{41}{6} \rho (u^2 - v^2) e - \frac{365}{36} \rho \lambda^2 (u^2 - v^2)$$

$$\Phi_{xye} = \frac{17}{24} \rho (u^2 + v^2) u v + \frac{17}{4} \rho u v e - \frac{65}{12} \rho \lambda^2 u v$$

viscosities: $\mu = \rho e \sigma_x \Delta t$ and $\zeta = 0$

satisfy the relation $\sigma_x = \sigma_q$

Prandtl number : $Pr = 1$

as for the D2Q17 lattice Boltzmann scheme

D3Q33

126

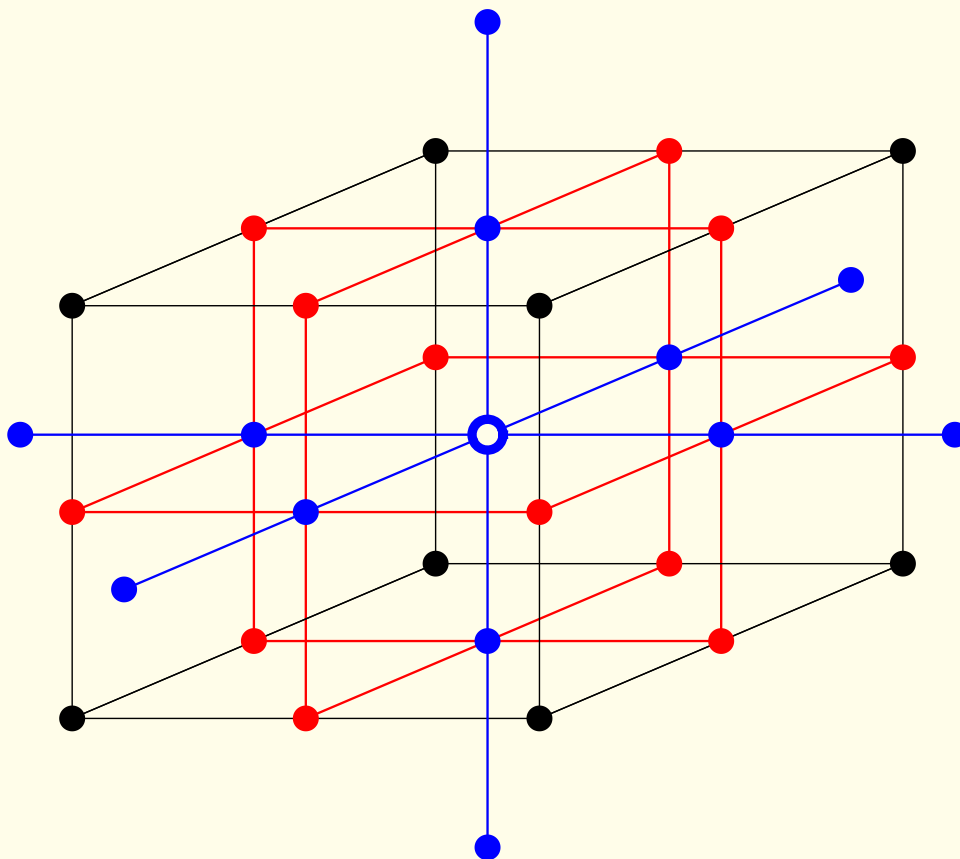

D3Q33 : moments

$\rho, j_x, j_y, j_z, \varepsilon$ 5 conserved

xx, ww 8 to fit the Euler equations

xy, yz, zx

q_x, q_y, q_z

$x yz, y zx, z xy$ 16 to fit the viscous terms

xyz

r_x, r_y, r_z

t_x, t_y, t_z

xx_e, ww_e

xy_e, yz_e, zx_e

hh

xx_h, ww_h 4 without any influence

h^2, h^4

D3Q33 : first order equations

$$\partial_t \rho + \partial_x J_x + \partial_y J_y + \partial_z J_z = 0 \qquad \partial_t \rho + \partial_x J_x + \partial_y J_y + \partial_z J_z = 0$$

$$\begin{aligned} \partial_t J_x + \partial_x \left(\frac{1}{3} \rho |\mathbf{u}|^2 + \frac{1}{3} \Phi_{xx} + \frac{2}{3} \rho e \right) + \partial_y \Phi_{xy} + \partial_z \Phi_{zx} &= 0 \\ \partial_t J_x + \partial_x (\rho u^2 + p) + \partial_y (\rho u v) + \partial_z (\rho u w) &= 0 \end{aligned}$$

$$\begin{aligned} \partial_t J_y + \partial_x \Phi_{xy} + \partial_y \left(\frac{1}{3} \rho |\mathbf{u}|^2 - \frac{1}{6} \Phi_{xx} + \frac{1}{2} \Phi_{ww} + \frac{2}{3} \rho e \right) + \partial_z \Phi_{yz} &= 0 \\ \partial_t J_y + \partial_x (\rho u v) + \partial_y (\rho v^2 + p) + \partial_z (\rho v w) &= 0 \end{aligned}$$

$$\begin{aligned} \partial_t J_z + \partial_x \Phi_{zx} + \partial_y \Phi_{yz} + \partial_z \left(\frac{1}{3} \rho |\mathbf{u}|^2 - \frac{1}{6} \Phi_{xx} - \frac{1}{2} \Phi_{ww} + \frac{2}{3} \rho e \right) &= 0 \\ \partial_t J_z + \partial_x (\rho u w) + \partial_y (\rho v w) + \partial_z (\rho w^2 + p) &= 0 \end{aligned}$$

$$\begin{aligned} \partial_t \varepsilon + \partial_x (3 \Phi_{qx} + \rho u \lambda^2) + \partial_y (3 \Phi_{qy} + \rho v \lambda^2) + \partial_z (3 \Phi_{qz} + \rho w \lambda^2) &= 0 \\ \partial_t E + \partial_x (E u + p u) + \partial_y (E v + p v) + \partial_z (E w + p w) &= 0 \end{aligned}$$

$$\text{then } \begin{cases} \frac{1}{3} \rho |\mathbf{u}|^2 + \frac{1}{3} \Phi_{xx} + \frac{2}{3} \rho e = \rho u^2 + p \\ \frac{1}{3} \rho |\mathbf{u}|^2 - \frac{1}{6} \Phi_{xx} + \frac{1}{2} \Phi_{ww} + \frac{2}{3} \rho e = \rho v^2 + p \\ \frac{1}{3} \rho |\mathbf{u}|^2 - \frac{1}{6} \Phi_{xx} - \frac{1}{2} \Phi_{ww} + \frac{2}{3} \rho e = \rho w^2 + p \end{cases}$$

so $p = \frac{2}{3} \rho e, \gamma \equiv \frac{c_p}{c_v} = \frac{5}{3}$ and $\varepsilon = 22 E - 26 \lambda^2 \rho$

$$E = \frac{1}{2} \rho |\mathbf{u}|^2 + \rho e$$

D3Q33 : necessary relations for the equilibria

129

$$\Phi_{xx} = \rho(2u^2 - v^2 - w^2), \quad \Phi_{ww} = \rho(v^2 - w^2)$$

$$\Phi_{xy} = \rho uv, \quad \Phi_{yz} = \rho vw, \quad \Phi_{zx} = \rho wu$$

$$\Phi_{qx} = (13|\mathbf{u}|^2 + \frac{130}{3}e - 37\lambda^2)\rho u$$

$$\Phi_{qy} = (13|\mathbf{u}|^2 + \frac{130}{3}e - 37\lambda^2)\rho v$$

$$\Phi_{qz} = (13|\mathbf{u}|^2 + \frac{130}{3}e - 37\lambda^2)\rho w$$

[15 equations]

$$\Phi_{xyz} = \rho u(v^2 - w^2), \quad \Phi_{yzx} = \rho v(w^2 - u^2), \quad \Phi_{zxy} = \rho w(u^2 - v^2)$$

$$\Phi_{xyz} = \rho uvw$$

$$\Phi_{rx} + \frac{38}{13\lambda^2}\Phi_{tx} = -\rho\lambda^2 u \left(\frac{161}{39}u^2 + \frac{345}{13}(v^2 + w^2) \right) - \frac{1702}{39}\rho\lambda^2 ue + \frac{1265}{39}\rho\lambda^4 u$$

$$\Phi_{ry} + \frac{38}{13\lambda^2}\Phi_{ty} = -\rho\lambda^2 v \left(\frac{161}{39}v^2 + \frac{345}{13}(w^2 + u^2) \right) - \frac{1702}{39}\rho\lambda^2 ve + \frac{1265}{39}\rho\lambda^4 v$$

$$\Phi_{rz} + \frac{38}{13\lambda^2}\Phi_{tz} = -\rho\lambda^2 w \left(\frac{161}{39}w^2 + \frac{345}{13}(u^2 + v^2) \right) - \frac{1702}{39}\rho\lambda^2 we + \frac{1265}{39}\rho\lambda^4 w$$

D3Q33 : Equilibria for second order equations

130

$4 \times 3 \times 3 \times 5 = 180$ equations to solve
for $5 \times 16 = 80$ partial derivatives

$$\Phi_{xxe} = \rho(2u^2 - v^2 - w^2) \left(38|\mathbf{u}|^2 + \frac{266}{3}e - 38\lambda^2 \right)$$

$$\Phi_{wwe} = \rho(v^2 - w^2) \left(38|\mathbf{u}|^2 + \frac{266}{3}e - 38\lambda^2 \right)$$

$$\Phi_{xye} = \rho uv (3|\mathbf{u}|^2 + 14e - 8\lambda^2)$$

$$\Phi_{yze} = \rho vw (3|\mathbf{u}|^2 + 14e - 8\lambda^2)$$

$$\Phi_{zxe} = \rho wu (3|\mathbf{u}|^2 + 14e - 8\lambda^2)$$

$$\Phi_{hh} = \rho \left(\frac{69}{2}|\mathbf{u}|^4 + 230(|\mathbf{u}|^2 + e)e - \frac{325}{2}\lambda^2(|\mathbf{u}|^2 + 2e) + 152\lambda^4 \right)$$

the equilibrium functions Φ_{xxh} , Φ_{wwh} , Φ_{h2} , Φ_{h4}

are undetermined

satisfy the relation $\sigma_x = \sigma_q$

viscosities: $\mu = \frac{2}{3}\rho e \sigma_x \Delta t$ and $\zeta = 0$

Prandtl number : $Pr = 1$

Surprising D3Q27-2

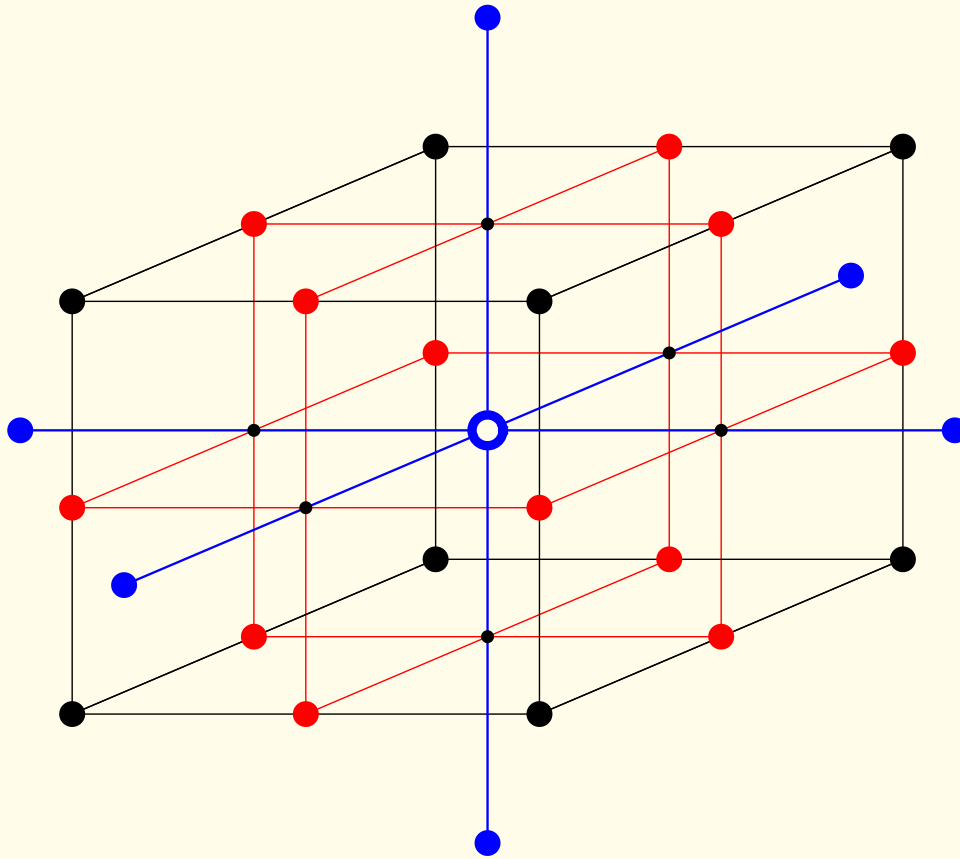

D3Q27-2 : moments

- $\rho, j_x, j_y, j_z, \varepsilon$ 5 conserved
- xx, ww 8 to fit the Euler equations
- xy, yz, zx
- q_x, q_y, q_z
- $x\ yz, y\ zx, z\ xy$ 13 to fit the viscous terms
- xyz
- r_x, r_y, r_z
- hh
- xx_e, ww_e
- xy_e, yz_e, zx_e
- h^2 1 without influence on the Navier-Stokes equations

D3Q27-2 : Euler equations

133

$$\partial_t \rho + \partial_x J_x + \partial_y J_y + \partial_z J_z = 0 \quad \partial_t \rho + \partial_x J_x + \partial_y J_y + \partial_z J_z = 0$$

$$\partial_t J_x + \partial_x \left(\frac{1}{3} \Phi_{xx} + \frac{1}{9} \varepsilon + \frac{8}{9} \rho \lambda^2 \right) + \partial_y \Phi_{xy} + \partial_z \Phi_{zx} = 0$$

$$\partial_t J_x + \partial_x (\rho u^2 + p) + \partial_y (\rho u v) + \partial_z (\rho u w) = 0$$

$$\partial_t J_y + \partial_x \Phi_{xy} + \partial_y \left(-\frac{1}{6} \Phi_{xx} + \frac{1}{2} \Phi_{ww} + \frac{1}{9} \varepsilon + \frac{8}{9} \rho \lambda^2 \right) + \partial_z \Phi_{yz} = 0$$

$$\partial_t J_y + \partial_x (\rho u v) + \partial_y (\rho v^2 + p) + \partial_z (\rho v w) = 0$$

$$\partial_t J_z + \partial_x \Phi_{zx} + \partial_y \Phi_{yz} + \partial_z \left(-\frac{1}{6} \Phi_{xx} - \frac{1}{2} \Phi_{ww} + \frac{1}{9} \varepsilon + \frac{8}{9} \rho \lambda^2 \right) = 0$$

$$\partial_t J_z + \partial_x (\rho u w) + \partial_y (\rho v w) + \partial_z (\rho w^2 + p) = 0$$

$$\partial_t \varepsilon + \partial_x (3 \Phi_{qx} + \rho u \lambda^2) + \partial_y (3 \Phi_{qy} + \rho v \lambda^2) + \partial_z (3 \Phi_{qz} + \rho w \lambda^2) = 0$$

$$\partial_t E + \partial_x (E u + p u) + \partial_y (E v + p v) + \partial_z (E w + p w) = 0$$

$$\text{then } \begin{cases} \frac{1}{3} \Phi_{xx} + \frac{1}{9} \varepsilon + \frac{8}{9} \rho \lambda^2 = \rho u^2 + p \\ -\frac{1}{6} \Phi_{xx} + \frac{1}{2} \Phi_{ww} + \frac{1}{9} \varepsilon + \frac{8}{9} \rho \lambda^2 = \rho v^2 + p \\ -\frac{1}{6} \Phi_{xx} - \frac{1}{2} \Phi_{ww} + \frac{1}{9} \varepsilon + \frac{8}{9} \rho \lambda^2 = \rho w^2 + p \end{cases}$$

$$\frac{1}{3} \varepsilon + \frac{8}{3} \rho \lambda^2 = \rho |\mathbf{u}|^2 + 3p = 2E - 2\rho e + 3p$$

$$\text{so } p = \frac{2}{3} \rho e, \quad \gamma \equiv \frac{c_p}{c_v} = \frac{5}{3} \quad \text{and} \quad \varepsilon = 6E - 8\lambda^2 \rho$$

D3Q27-2 : necessary relations for the equilibria

134

$$\Phi_{xx} = \rho (2u^2 - v^2 - w^2), \quad \Phi_{ww} = \rho (v^2 - w^2)$$

$$\Phi_{xy} = \rho u v, \quad \Phi_{yz} = \rho v w, \quad \Phi_{zx} = \rho w u$$

$$\Phi_{qx} = (|\mathbf{u}|^2 + \frac{10}{3} e - 3\lambda^2) \rho u$$

$$\Phi_{qy} = (|\mathbf{u}|^2 + \frac{10}{3} e - 3\lambda^2) \rho v$$

$$\Phi_{qz} = (|\mathbf{u}|^2 + \frac{10}{3} e - 3\lambda^2) \rho w$$

[15 equations]

fit the Navier Stokes with conservation of energy at second order :

solve 180 equations for the partial derivatives

$$\Phi_{x yz} = \rho u (v^2 - w^2)$$

$$\Phi_{y zx} = \rho v (w^2 - u^2)$$

$$\Phi_{z xy} = \rho w (u^2 - v^2)$$

$$\Phi_{xyz} = \rho u v w$$

$$\Phi_{rx} = \left(-(u^2 + 3v^2 + 3w^2) - 6\lambda^2 e + 5\lambda^4 \right) \rho u$$

$$\Phi_{ry} = \left(-(u^2 + 3v^2 + 3w^2) - 6\lambda^2 e + 5\lambda^4 \right) \rho v$$

$$\Phi_{rz} = \left(-(u^2 + 3v^2 + 3w^2) - 6\lambda^2 e + 5\lambda^4 \right) \rho w$$

D3Q27-2 available for thermal Navier - Stokes !

$4 \times 3 \times 3 \times 5 = 180$ equations to solve
for $5 \times 13 = 65$ partial derivatives

$$\Phi_{xxe} = \rho (2u^2 - v^2 - w^2) \left(\frac{9}{8} |\mathbf{u}|^2 + \frac{21}{4} e - \frac{17}{4} \lambda^2 \right)$$

$$\Phi_{wwe} = \rho (v^2 - w^2) \left(\frac{9}{8} |\mathbf{u}|^2 + \frac{21}{4} e - \frac{17}{4} \lambda^2 \right)$$

$$\Phi_{xye} = \rho uv (3|\mathbf{u}|^2 + 14e - 8\lambda^2)$$

$$\Phi_{yze} = \rho vw (3|\mathbf{u}|^2 + 14e - 8\lambda^2)$$

$$\Phi_{zxe} = \rho wu (3|\mathbf{u}|^2 + 14e - 8\lambda^2)$$

$$\Phi_{hh} = \rho (3|\mathbf{u}|^4 + 20(|\mathbf{u}|^2 + e)e - 15\lambda^2(|\mathbf{u}|^2 + 2e) + 16\lambda^4)$$

the equilibrium function is determined for all microscopic moments

satisfy the relation $\sigma_x = \sigma_q$

viscosities: $\mu = \frac{2}{3} \rho e \sigma_x \Delta t$ and $\zeta = 0$

Prandtl number : $Pr = 1$

Summary for fluids with lattice Boltzmann schemes

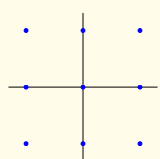
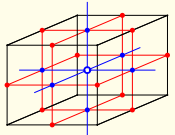
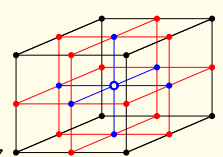
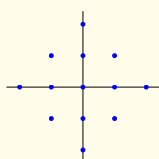
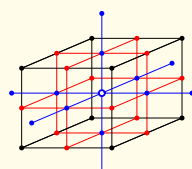
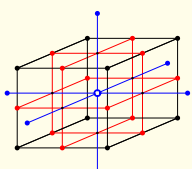
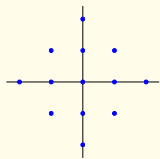
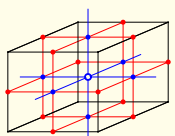
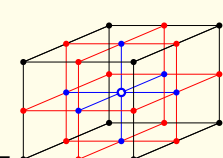
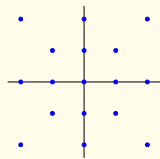
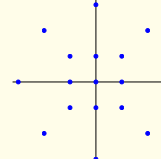
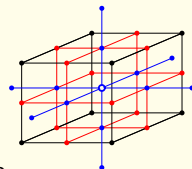
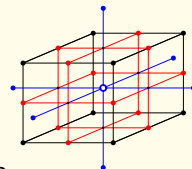
energy	no	yes
without	 <p>D2Q9</p>  <p>D3Q19</p>  <p>D3Q27</p>	 <p>D2Q13</p>  <p>D3Q33</p>  <p>D3Q27-2</p>
with	 <p>D2Q13</p>  <p>D3Q19</p>  <p>D3Q27</p>	 <p>D2Q17</p>  <p>D2V17</p>  <p>D3Q33</p>  <p>D3Q27-2</p>



SageMath : free open-source mathematics software system
licensed under the GNU General Public License.

It builds on top of many existing open-source packages:

NumPy, SciPy, matplotlib, Sympy, Maxima, GAP, FLINT, R, ...

www.sagemath.org

Stability, or ... the devil is in the details!

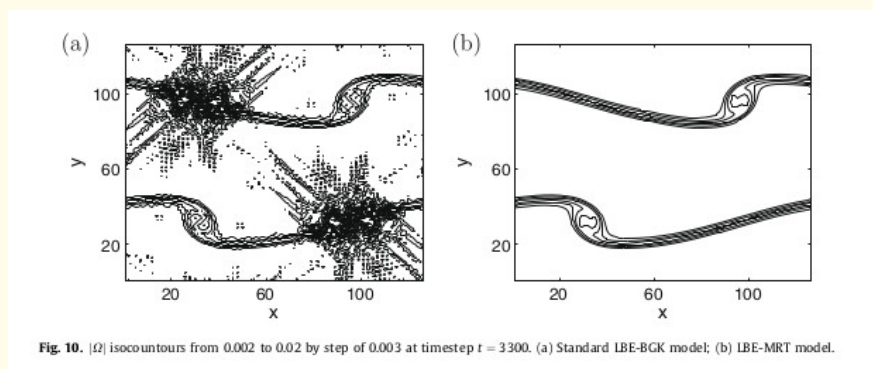

D. Ricot, S. Marié, P. Sagaut, C. Bailly

(*Journal of Computational Physics*, 2009)

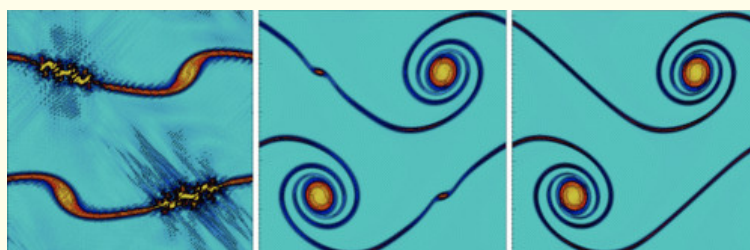

S. Hosseini, N. Darabiha, D. Thévenin (*Physical Review E*, 2019)

Lattice Boltzmann schemes

139

very simple numerical method

for the approximation of fluid dynamics equations
with an **explicit** algebraic formulas

- ;-) precise : **perfect advection** for the velocities of the lattice
- reduced time delay for mesh generation
- very efficient with **Graphics Processing Units**

Nvidia processor

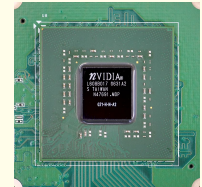

- ;-(conservation of energy difficult to satisfy
- what kind of mathematical convergence**
if the discretization step Δt tends to zero ?
- empirical stability** in nonlinear situations

pylbm (Univ. Paris-Saclay and Ecole Polytechnique)

140

github.com/pylbm
pylbm.readthedocs.io



Benjamin Graille

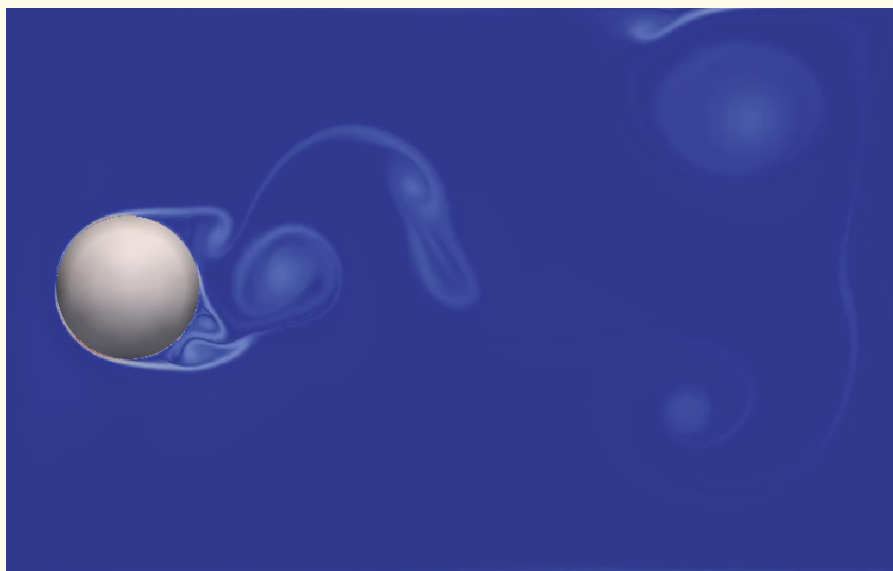

Loïc Gouarin

Thank you for your attention !

