

2018 IEEE 2nd International Electrical and Energy Conference (CIEEC)

# Different Possibilities of Multiphase Drives Functioning in Constant Power Region

Dr. Ngac Ky NGUYEN, Dr. Hussein ZAHR, Duc Tan VU and Prof. Eric SEMAIL

Arts et Métiers ParisTech

Laboratory of Electrical Engineering and Power Electronics (L2EP), Lille, France

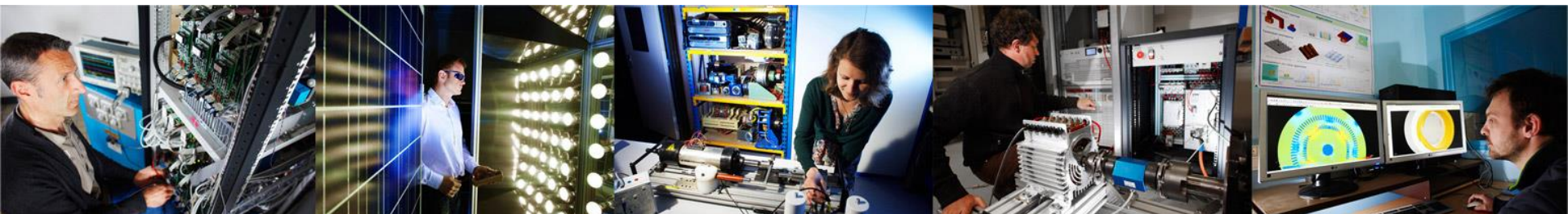

- I. Introduction & Context
- II. Three-phase Drives Vs Multiphase Ones
- III. Multiphase - Possibility at High Speed  
(Constant Power Region)
  1. Pole Changing
  2. Different Stator Winding Connections
- IV. Conclusion

# Introduction & Context

Hybrid and Full electric automotive applications

Electrical machines requirements

- High efficiency
- Low cost
- High torque density
- Easy manufacturing

Fault tolerance capability or low voltage (48V)

Wide speed range

rotor with **PM**

Stator with tooth concentrated winding

Number of phases > 3

- Dahlander circuit
- Winding configuration
- Saliency ratio

Electronic pole commutation

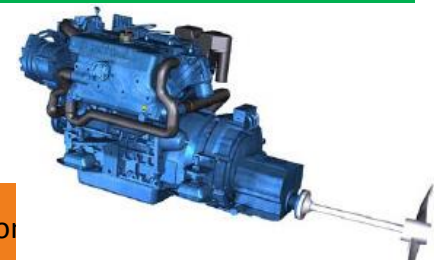
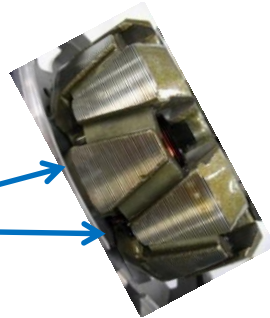

# Introduction & Context

4

## Advantages of 5-phase machines (PM + Tooth concentrated windings)

➤ **Acceptable current/phase** for low voltage high power (48V/15kW):

- ✓ **No transistor** in parallel
- ✓ **Smaller cables** leading to an easy connection

➤ **Additional degrees of freedom** for vector control

- ✓ **Improving constant power** functionality
- ✓ **High torque quality** with non-sinusoidal currents

✓ Increase **fault-tolerance capabilities**

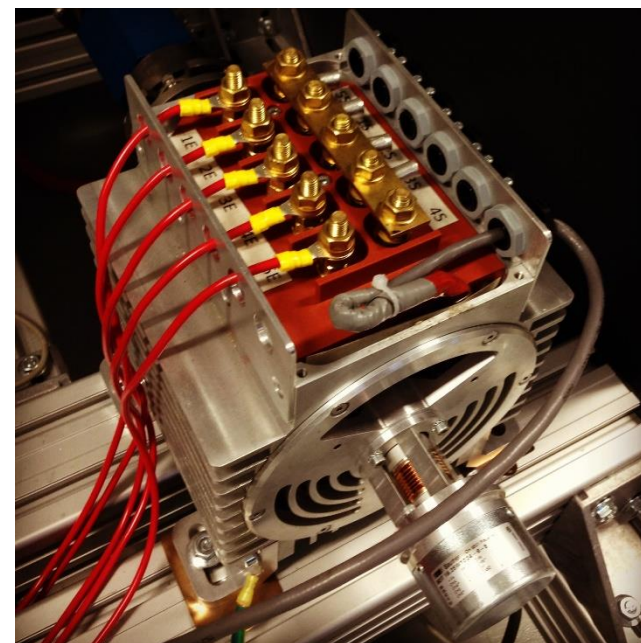

MHYGALE Project, L2EP Laboratory, Lille, France

- I. Introduction & Context
- II. Three-phase Drives Vs Multiphase Ones
- III. Multiphase - Possibility at High Speed  
(power constant region)
  - 1. Pole Changing
  - 2. Different Stator Winding Connections
- IV. Conclusion

# Multiphase Decomposition Theory

## GENERALIZED VECTORIAL FORMALISM THEORY

In the **new base**, the voltage and electromagnetic torque are expressed as:

$$\vec{v} = \sum_{k=1}^n \vec{v}_k^d = \sum_{k=1}^n \left( R_s \vec{i}_k^d + \Lambda_k \frac{d\vec{i}_k^d}{dt} + \vec{e}_k^d \right) \quad C_\Sigma = \sum_{k=1}^n C_k^d = \sum_{k=1}^n \frac{\vec{e}_k^d \cdot \vec{i}_k^d}{\Omega}$$

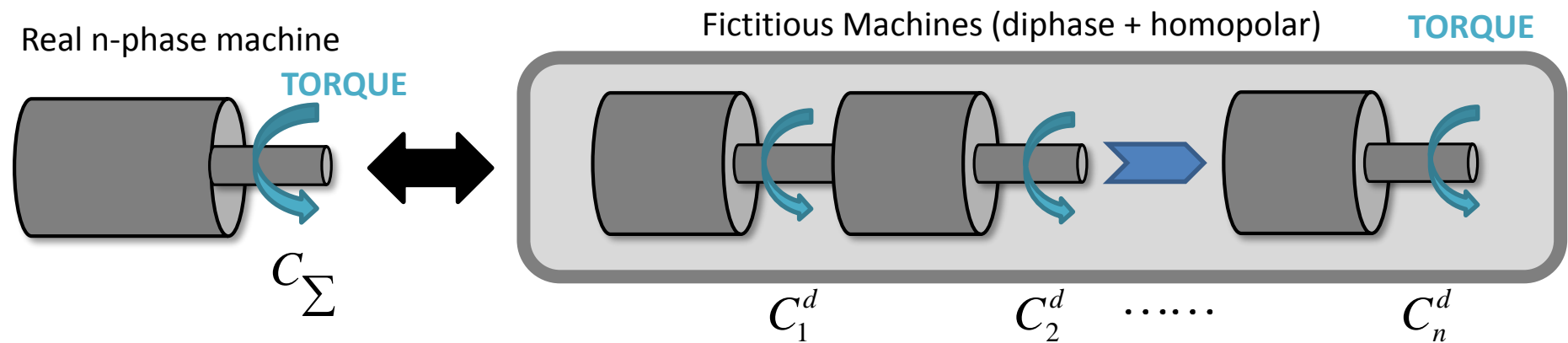

Shape of the back-EMF  
(sinusoidal/trapezoidal or others)



Fictitious machines

Leads to

# Multiphase Decomposition Theory

## 3-phase PMSM

Real 3-phase machine

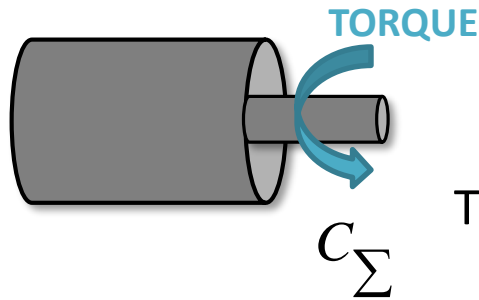

Transformation  
(Concordia,  
Clarke, etc.)

Fictitious Machines (1 diphase + 1 homopolar)

**MM**

**HM**

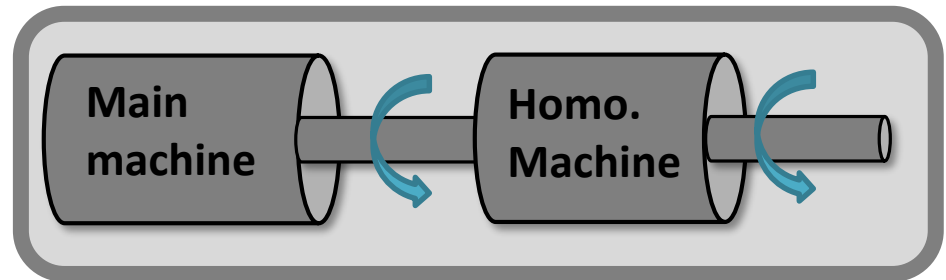

$h = 1, 5, 7, 11, \dots$   
 $h \neq 3k$

$h = 3, 6, 9, \dots$   
 $h = 3k$

$h$  : odd harmonic rank

(even harmonics are ignored)

Main machine (MM) : diphase ( $\Lambda_1 = \Lambda_2$ )

Homo. Machine: monophasé ( $\Lambda_0$ )

$\Lambda_i$  Eigenvalues  
of inductance matrix

### Notes

- Wye connection: current of homopolar machine  $i_0=0$   $C_0=0$

- All **harmonics**, different from  $3 \cdot k$ , are **regrouped** in the **main machine** and **INTERACT** between them (currents (time) and back-EMFs (space))



# Multiphase Decomposition Theory

## 5-phase PMSM

Fictitious Machines (2 diphase + 1 homopolar)

Real 5-phase machine

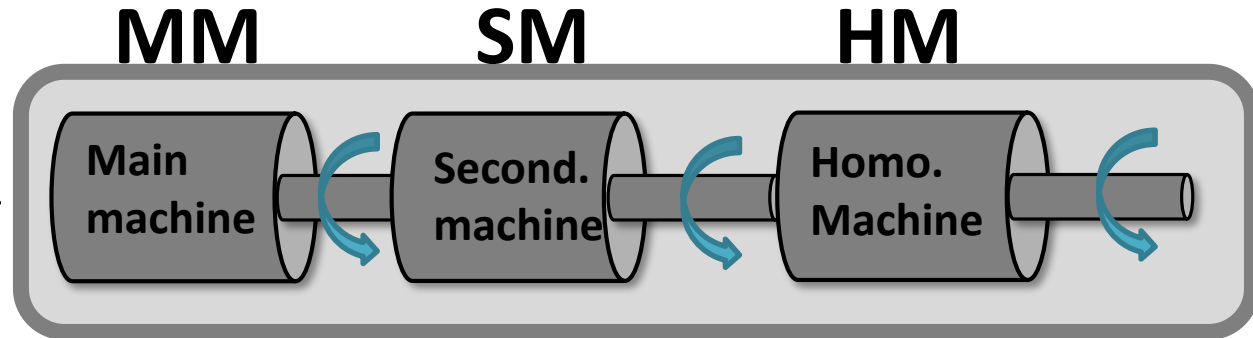
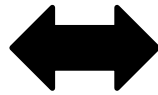
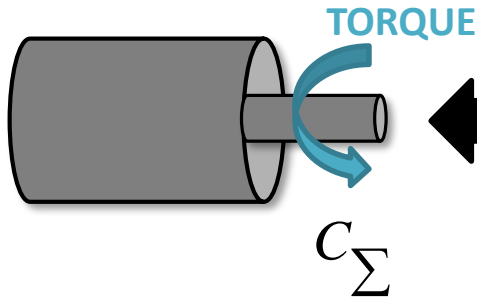

$h = 1, 9, 11, \dots$   
 $h = 5k \pm 1$

$h = 3, 7, \dots$   
 $h = 5k \pm 2$

$h = 5, 15, \dots$   
 $h = 5k$

$h$  : harmonic rank of the back-EMF

+ : direct rotating vector

- : inverse rotating vector

**Main machine (MM) : diphase ( $\Lambda_1 = \Lambda_2$ )**

**Second. Machine (SM): diphase ( $\Lambda_3 = \Lambda_4$ )**

**Homo. Machine: monophase ( $\Lambda_0$ )**

### Notes

- Wye connection: current of homopolar machine

$$i_0 = 0 \quad C_0 = 0$$

- Separation of some harmonics into two decoupled frames  $\rightarrow$  **Interesting point**



# Multiphase Decomposition Theory

## 5-phase PMSM

MM : 1st harmonic  
SM : 3th harmonic

Torque can be created by injecting the 1st and the 3th harmonic of currents

Real 5-phase machine

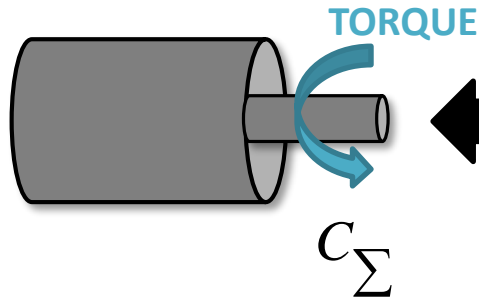

Fictitious Machines (2 diphase + 1 homopolar)

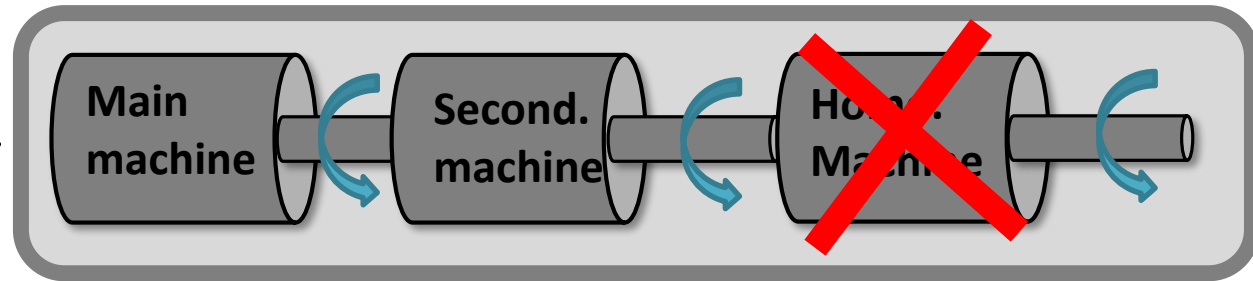

$h = 1, 9, 11, \dots$

$p$  pairs of poles

$h = 3, 7, \dots$

$3p$  pairs of poles

$h = 5, 15, \dots$   
 $h = 5k$

### Classical solutions:

- **Secondary machine torque** contribution is between **10% and 25%**
- **Weak secondary machine** → Low Torque

**New solution**

### « Bi-harmonic » machine

Enhance SM, so **MM** and **SM** have the **same torque** contribution

- I. Introduction & Context
- II. Three-phase Drives Vs Multiphase Ones
- III. Multiphase - Possibility at High Speed  
(Power Constant Region)
  - 1. Pole Changing
  - 2. Different Stator Winding Connections
- IV. Conclusion

# 1. Pole Changing

**Mechanical** commutations of windings (Dahlander)

$$n = \frac{120f}{p} \text{ (rpm)}$$

Change number of pole pairs **electronically**

[1] for induction motors,  
[2] for 5-phase PMSM

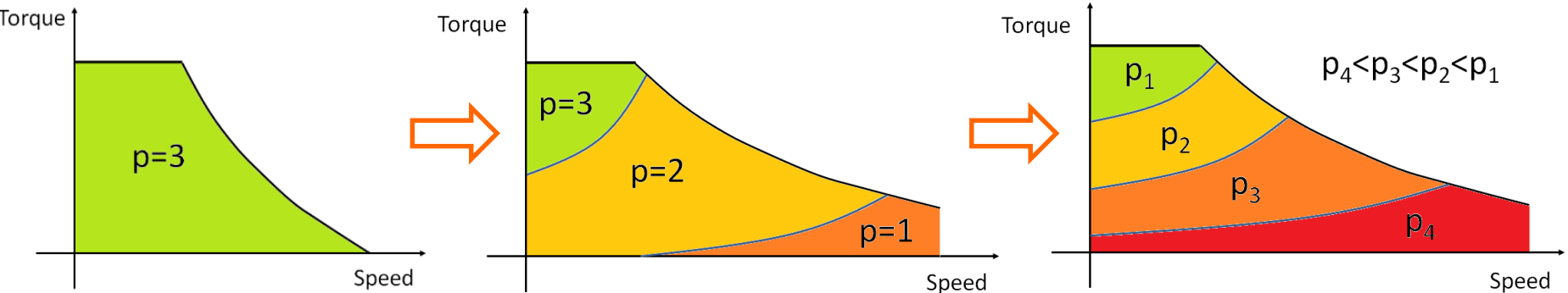
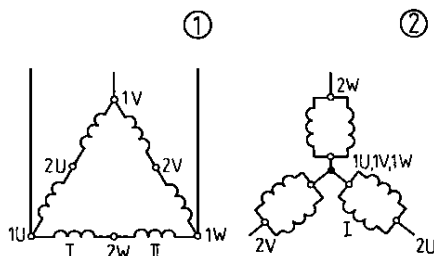

*Electronic pole changing with multiphase machines to extend the speed range*

[1] G. Dajaku, F. Bachheibl, A. Patzak, and D. Gerling, "Intelligent stator cage winding for automotive traction electric machines," EVS28 International Electric Vehicle Symposium and Exhibition, Korea, 5/2015.

[2] J. Gong, H. Zahr, E. Semail, M. Trabelsi, B. Aslan, and F. Sculler, "Design Considerations of Five-Phase Machine with Double p/3p Polarity," IEEE Transactions on Energy Conversion, pp. 1-1, 2018.

# 1. Pole Changing

## ISCAD : Intelligent Stator Cage Drive

Stator cage winding

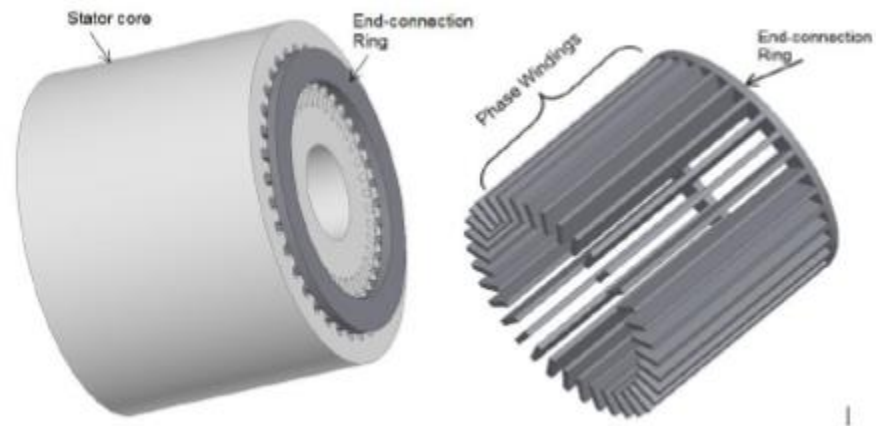

- Intelligent Stator → Each slot is one phase
- Modification (by controlling 60 legs) of Slot/pole according to operating points for maximizing the efficiency
- High fault-tolerant capability
- Double-polarity possibility to increase the performance

The m-phase stator winding supplied with multiphase inverter

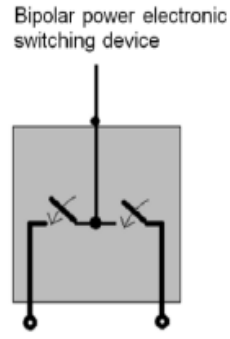
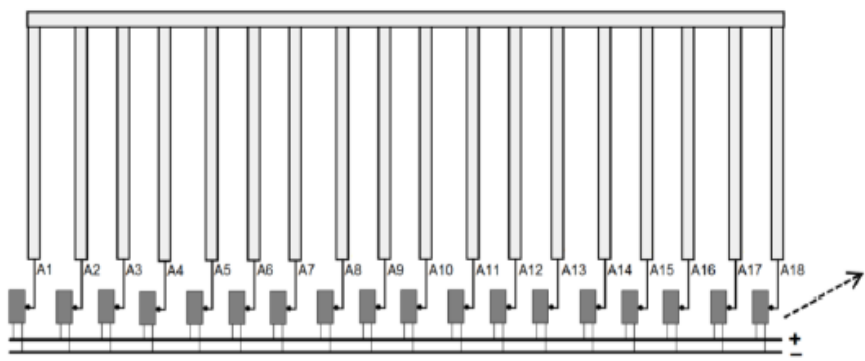

**60 stator slots/ 73 rotor slots  
(Induction machine)**

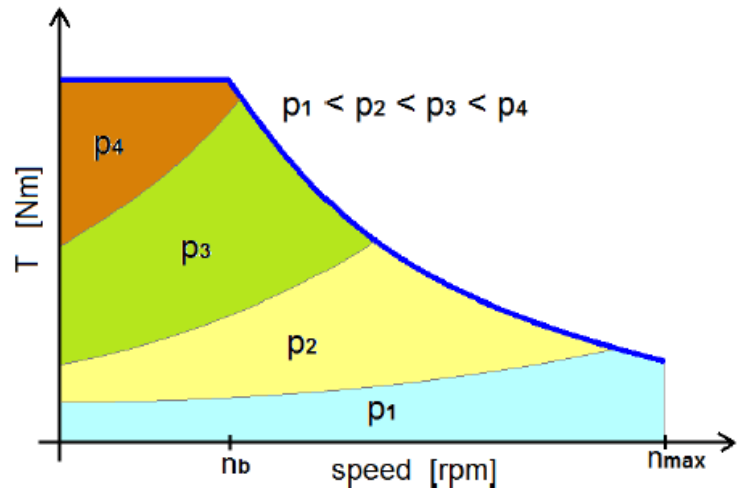

[1] G. Dajaku, F. Bachheibl, A. Patzak, and D. Gerling, "Intelligent stator cage winding for automotive traction electric machines," EVS28 International Electric Vehicle Symposium and Exhibition, Korea, 5/2015.

# 1. Pole Changing

## Structure with interior magnets

- Redistribution of flux between 1<sup>st</sup> & 3<sup>rd</sup> harmonic
- Introducing holes between poles

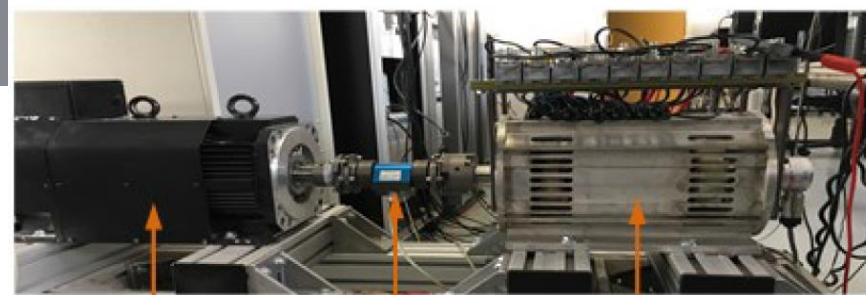
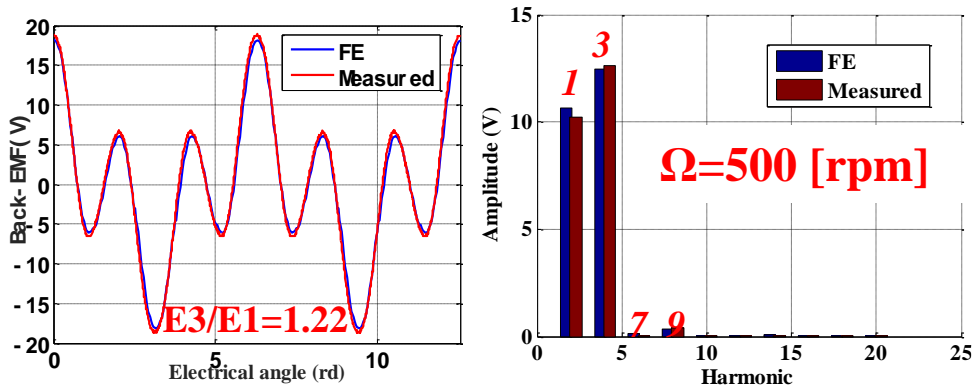

Load 3-Φ PMSM      Torque sensor      5-Φ bi-harmonic PMSM Prototype

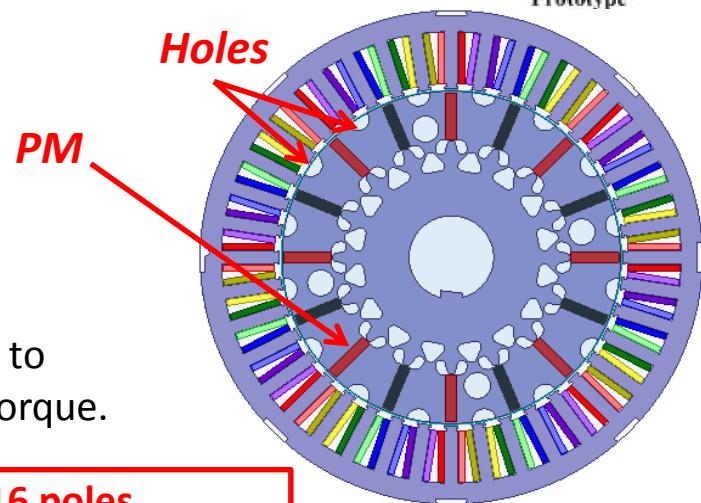

Equivalent potentiality between the 1<sup>st</sup> and the 3<sup>rd</sup> harmonic to produce torque → **two degrees of freedom** for control of the torque.

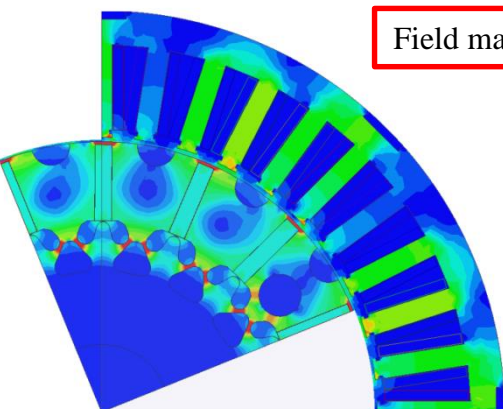

Field map for  $J = 10A/mm^2$

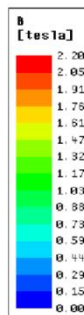

**40 slots / 16 poles  
bi-harmonic machine  
(½ slot per pole per phase) [3][4]**

[3] H. Zahr, J. Gong, E. Semail and F. Scullier, "Comparison of Optimized Control Strategies of a High-Speed Traction Machine with Five Phases and Bi-harmonic Electromotive Force," *Energies* 2016, Vol. 9, No. 12, pp. 1-19.

[4] B. Aslan and E. Semail, "New 5-phase concentrated winding machine with bi-harmonic rotor for automotive application," *2014 International Conference on Electrical Machines (ICEM)*, Berlin, 2014, pp. 2114-2119

# 1. Pole Changing

## MTPA strategy and **Constraint on Voltage** at High Speed

**Torque vs Speed**

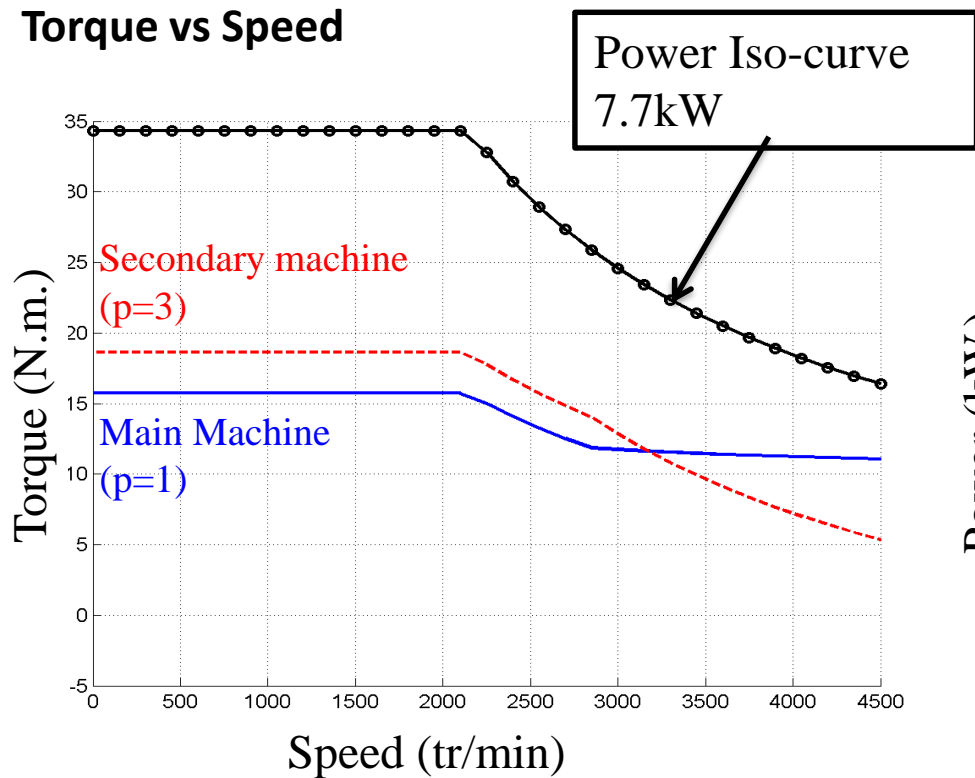

**Power vs Speed**

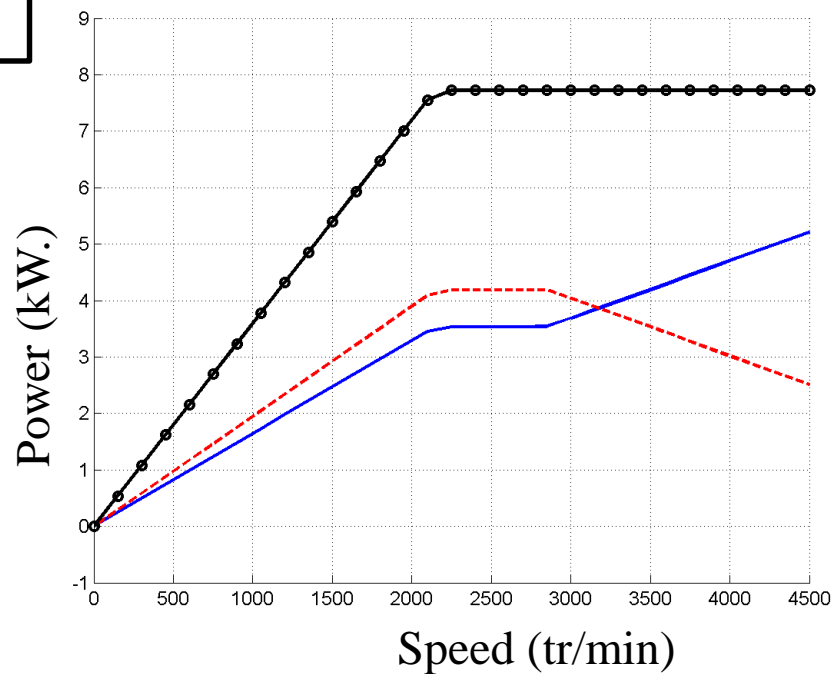

# 1. Pole Changing

## Maximum Torque Per Primary Machine (MTPPM)

Torque Vs Speed

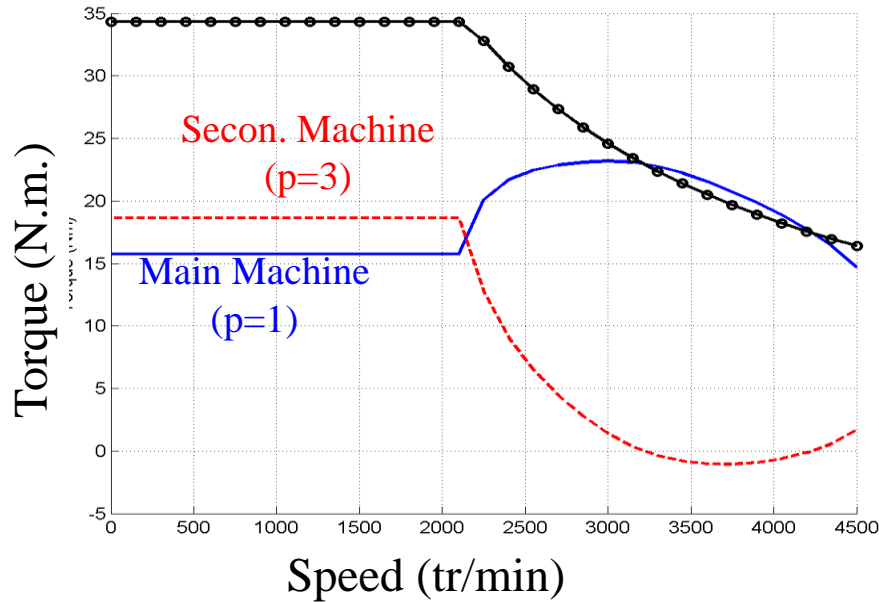

Power Vs Speed

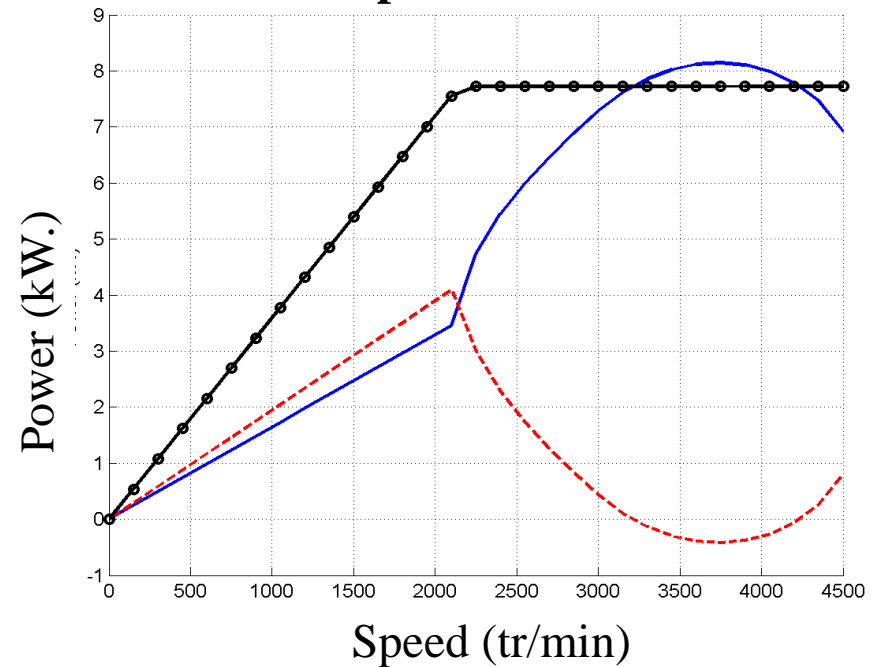

**Second. Machine** is operating as a **generator** for keeping the **voltage under limit**

Functioning at **high speed** is very **different** with **three-phase** drives since there are **more degrees of freedom**



# 2. Different Stator Winding Connections

N-phase machine  $\longrightarrow$   $(N+1)/2$  configurations

Number of phases	Possibilities of stator configuration
3	2 : Wye and Delta
5	3: Wye, Pentagon and Pentacle
:	:
N	$(N+1)/2$

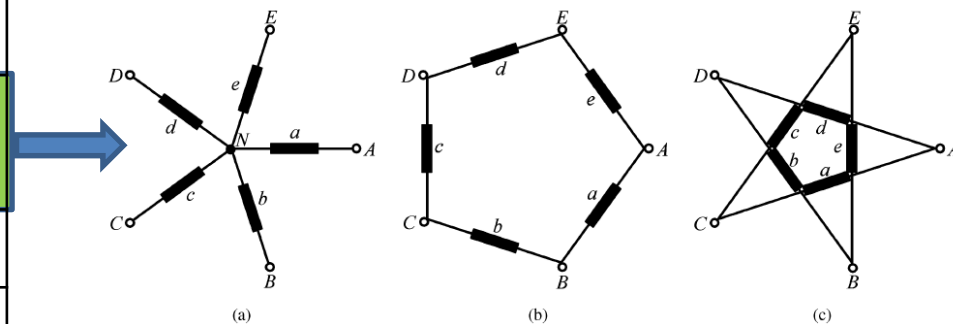

D. Dujic, M. Jones, and E. Levi, "Analysis of Output Current-Ripple RMS in Multiphase Drives Using Polygon Approach," *IEEE Trans. on Power Electronics*, vol. 25, no. 7, pp. 1838-1849, 2010.

## 2. Different Stator Winding Connections

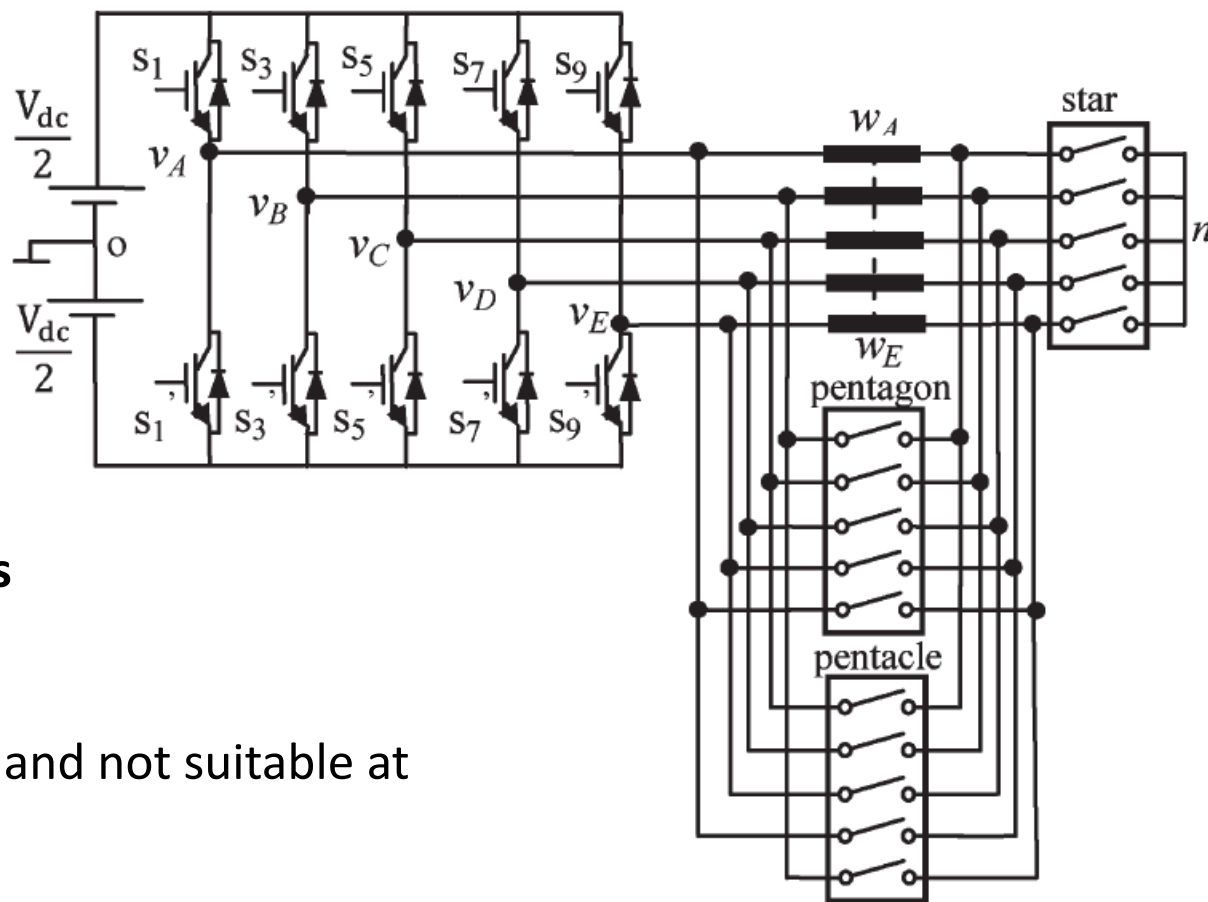

### Magnetic Contactors

- Time delay
- Bulky
- “Hard” switching and not suitable at high speed

S. Sadeghi, L. Guo, H. A. Toliyat and L. Parsa, “Wide Operational Speed Range of Five-Phase Permanent Magnet Machines by Using Different Stator Winding Configurations”, *IEEE Trans. Industrial Electronics*, Vol. 59, No. 6, 2012.

# 2. Different Stator Winding Connections

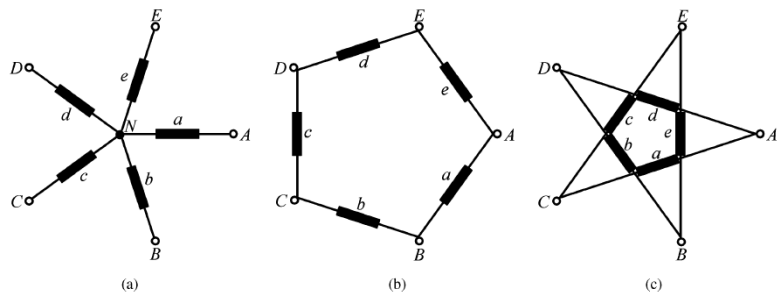

$|V_a| = V_m$      
  $|V_a| = 1,2 * V_m$      
  $|V_a| = 1,9 * V_m$

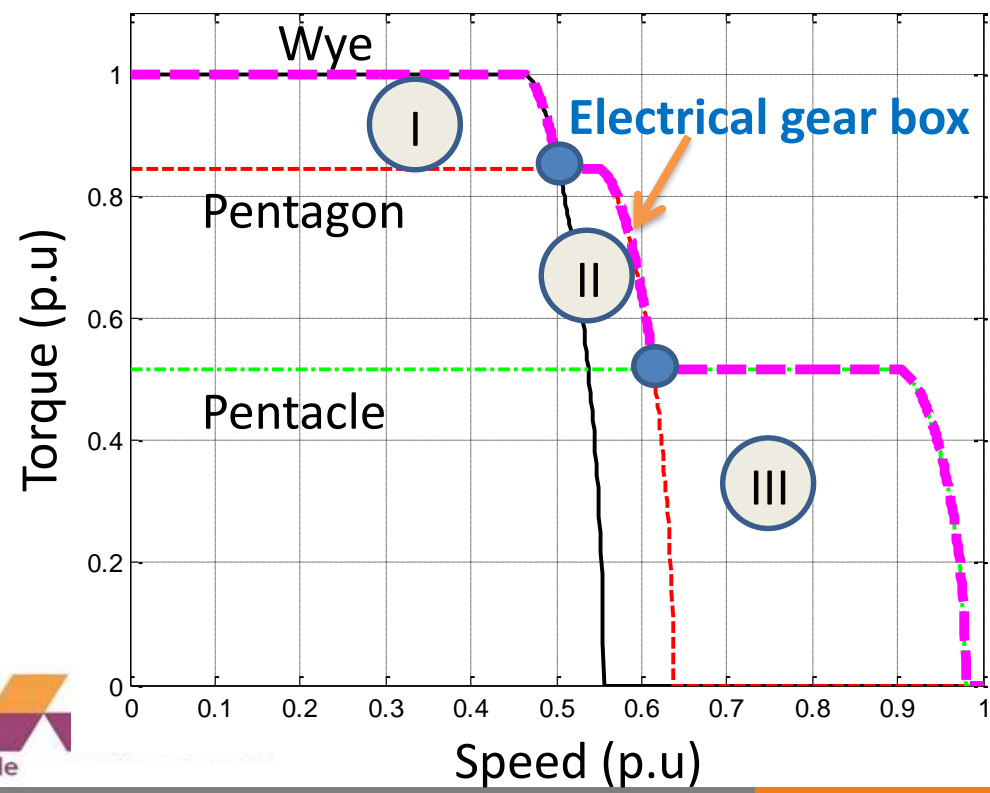

**Objective**



**Electrical Gear Box (EGB)**

**How we can change these stator configurations by power electronics control ?**



**5-phase open-end winding structure**

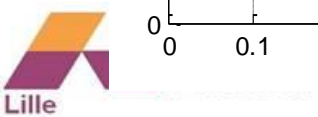

# 2. Different Stator Winding Connections

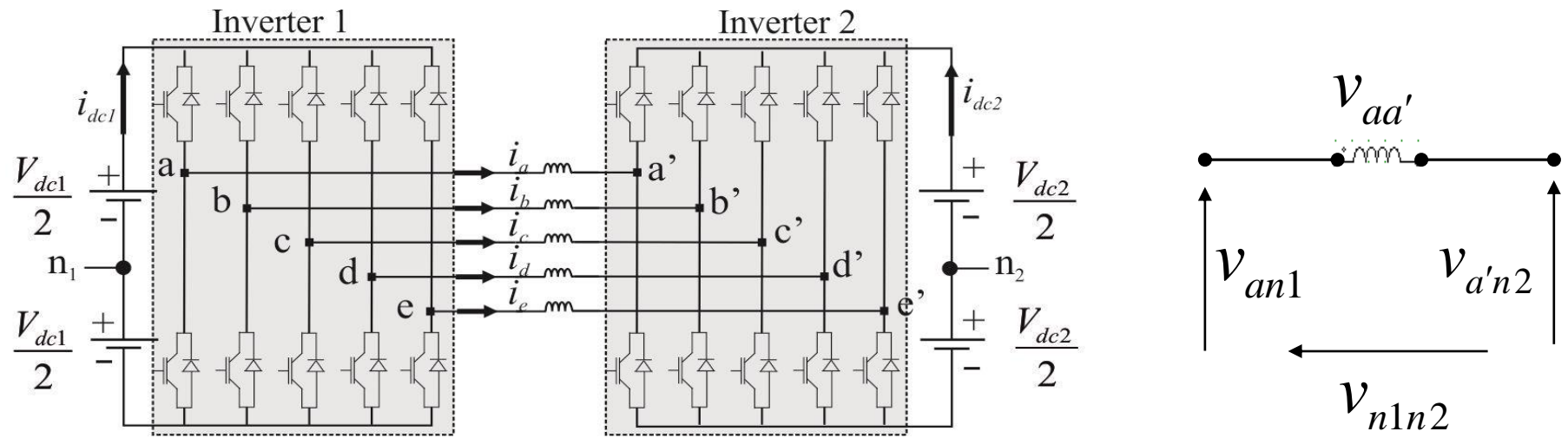

$$\mathbf{v}_{abcde} = \mathbf{v}_{abcde-INV1} - \mathbf{v}_{abcde-INV2} + \mathbf{v}_{abcde-n_1n_2}$$

where

$$\mathbf{v}_{abcde} = \begin{bmatrix} v_{aa'} & v_{bb'} & v_{cc'} & v_{dd'} & v_{ee'} \end{bmatrix}^T$$

$$\mathbf{v}_{abcde-INV1} = \begin{bmatrix} v_{an_1} & v_{bn_1} & v_{cn_1} & v_{dn_1} & v_{en_1} \end{bmatrix}^T$$

$$\mathbf{v}_{abcde-INV2} = \begin{bmatrix} v_{a'n_2} & v_{b'n_2} & v_{c'n_2} & v_{d'n_2} & v_{e'n_2} \end{bmatrix}^T$$

$$\mathbf{v}_{abcde-n_1n_2} = \begin{bmatrix} v_{n_1n_2} & v_{n_1n_2} & v_{n_1n_2} & v_{n_1n_2} & v_{n_1n_2} \end{bmatrix}^T$$

Hypothesis : Sinusoidal and balanced phase voltages:

$$\mathbf{v}_{abcde} = \mathbf{A} \cdot \mathbf{v}_{abcde-INV1} - \mathbf{v}_{abcde-INV2}$$

where

$$\mathbf{A} = \frac{1}{5} \begin{bmatrix} 4 & -1 & -1 & -1 & -1 \\ -1 & 4 & -1 & -1 & -1 \\ -1 & -1 & 4 & -1 & -1 \\ -1 & -1 & -1 & 4 & -1 \\ -1 & -1 & -1 & -1 & 4 \end{bmatrix}$$



# 2. Different Stator Winding Connections

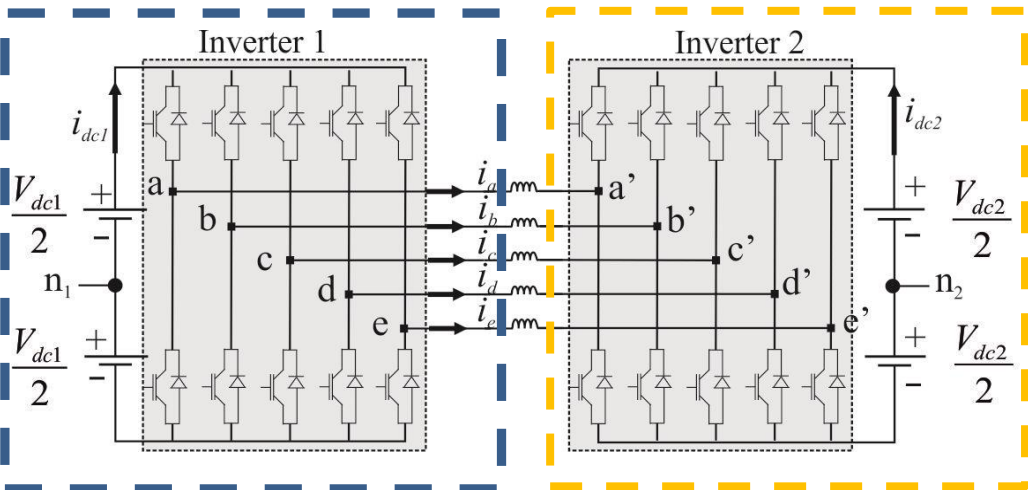

$$\mathbf{v}_{abcde} = \mathbf{A} \cdot \mathbf{v}_{abcde-INV1} - \mathbf{v}_{abcde-INV2}$$

For phase a:

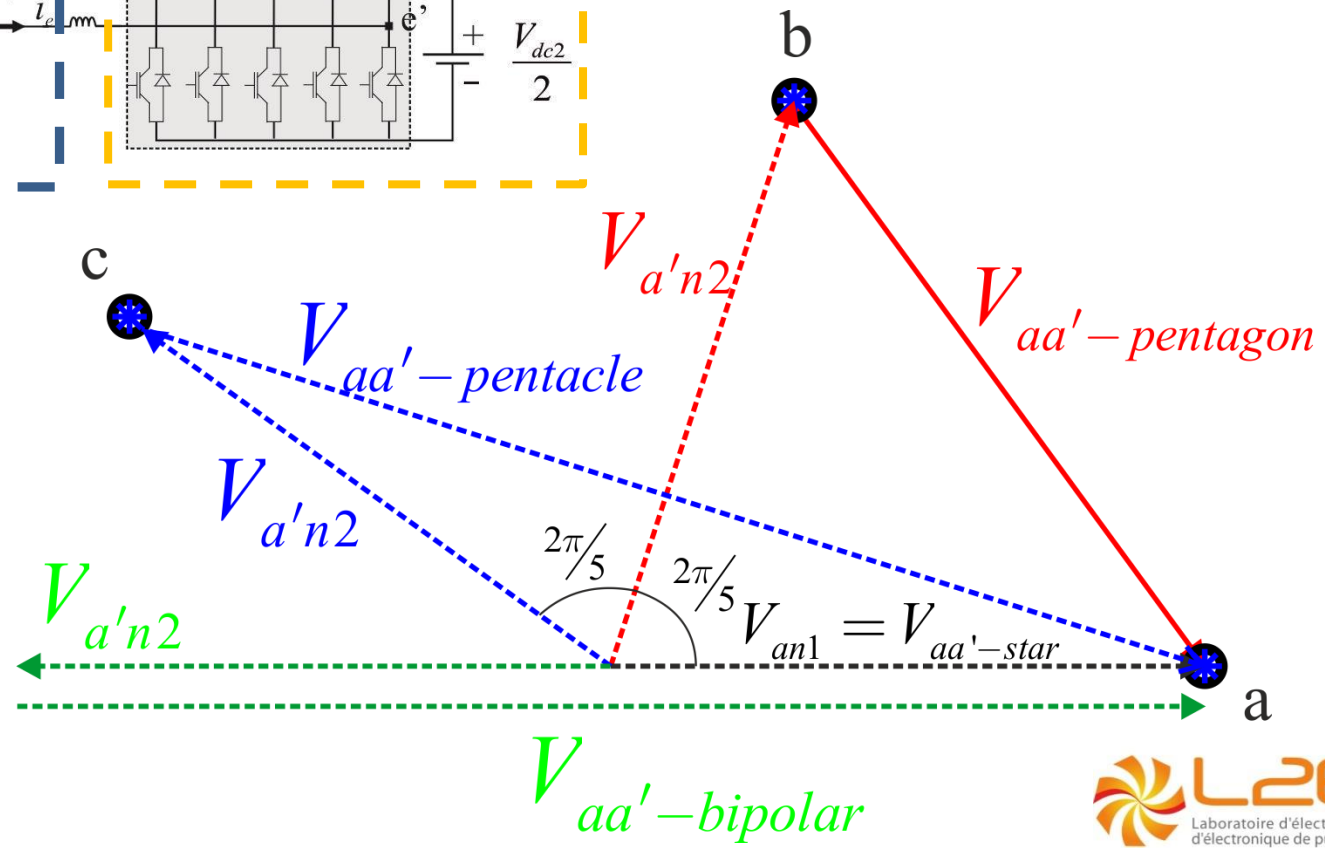

## 2. Different Stator Winding Connections

$\alpha_1 - \beta_1$  frame of voltage

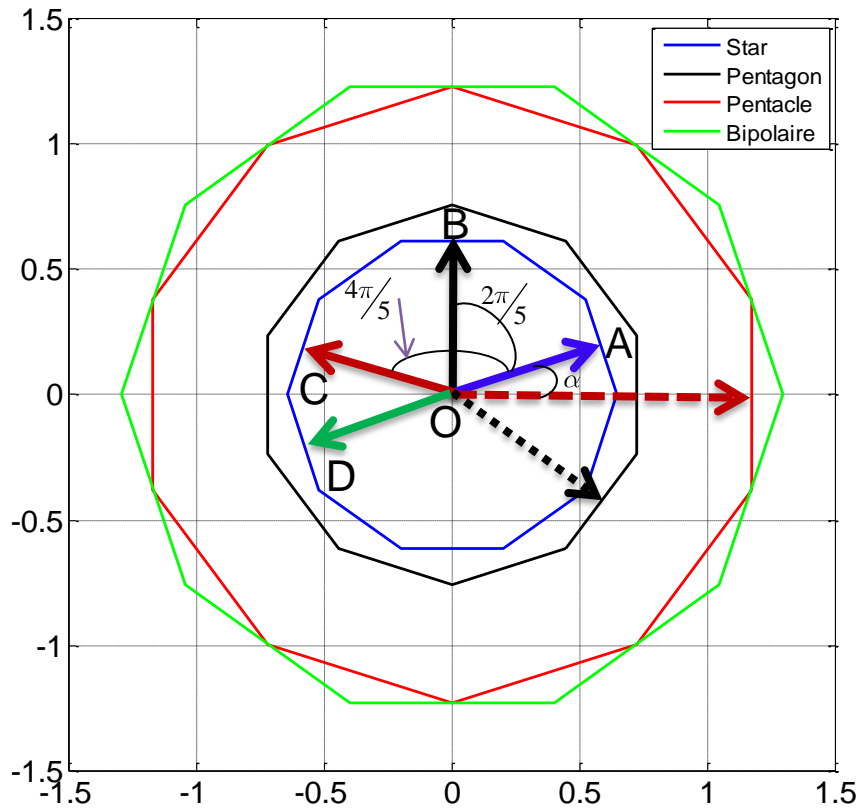

### Wye-Connection

$$V_{INV-1} = V^* \underline{\alpha} \quad V_{INV-2} = 0$$

### Pentagon Connection:

$$V_{INV-1} = V^* \underline{\alpha} \quad V_{INV-2} = V^* \left[ \alpha + \frac{2\pi}{5} \right]$$

### Pentacle Connection:

$$V_{INV-1} = V^* \underline{\alpha} \quad V_{INV-2} = V^* \left[ \alpha + \frac{4\pi}{5} \right]$$

### Bipolaire Connection :

$$V_{INV-1} = V^* \underline{\alpha} \quad V_{INV-2} = V^* \left[ \alpha + \pi \right]$$

# 2. Different Stator Winding Connections

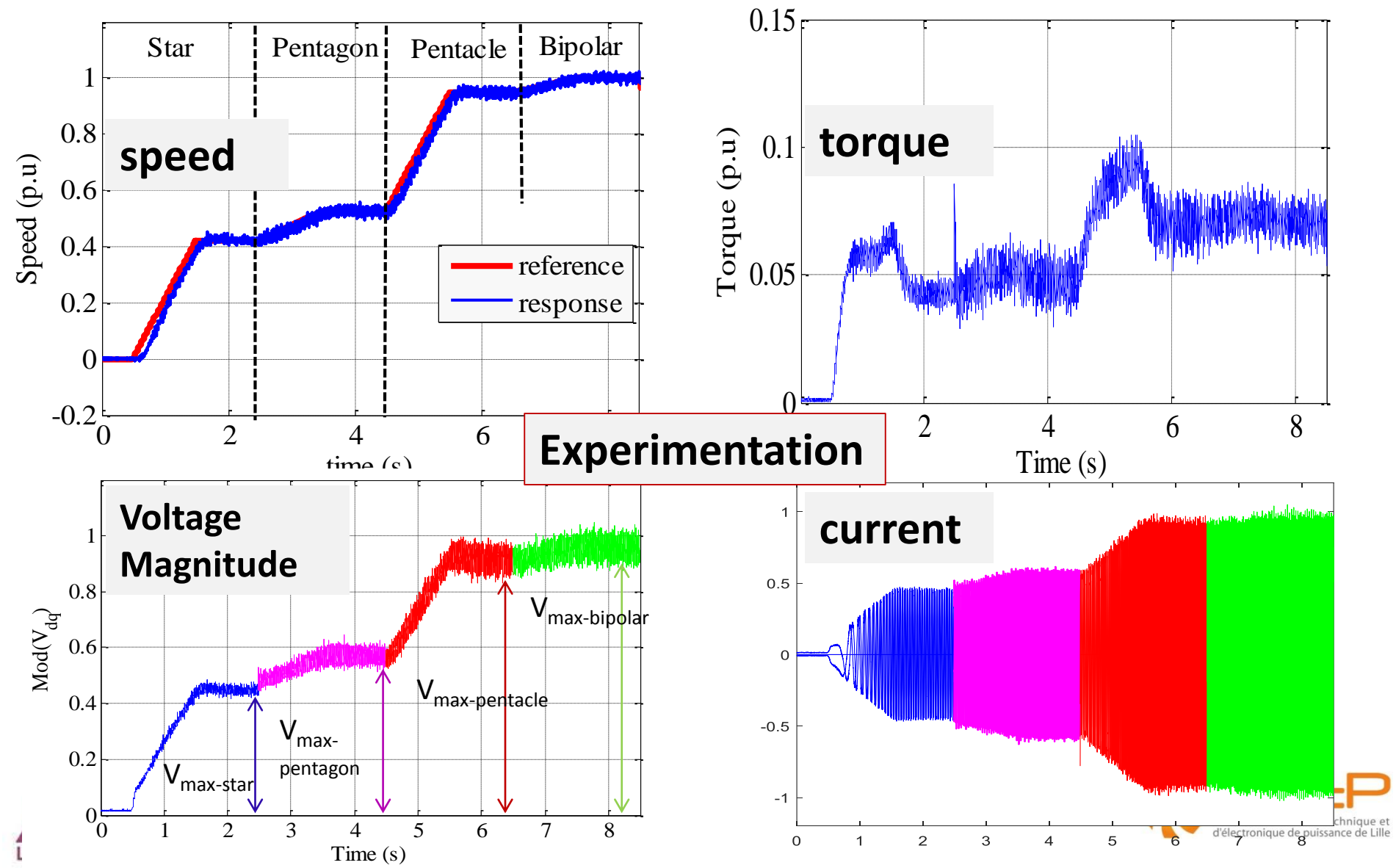



- I. Introduction & Context
- II. Three-phase Drives Vs Multiphase Ones
- III. Multiphase - Possibility at High Speed  
(power constant region)
  - 1. Pole Changing
  - 2. Different Stator Winding Connections
- IV. Conclusion**

# Conclusion

24

- ✓ Properties of multiphase machines have been presented
- ✓ Different possibilities of multiphase drives for functioning at high speed
- ✓ Validation

## Multiphase Drive Experimental Platform of L2EP Lab., Lille, France.

**Two 7-phase generators, Two 5-phase PMSM drives, Two 6-phase PMSM drives;**  
Power Supplies and Electronic Loads: 5 to 15 kW 12V, 48V to 500 V;  
Rapid prototyping control: **Dspace 1005, 1006, MicroLabox, Opal-RT**



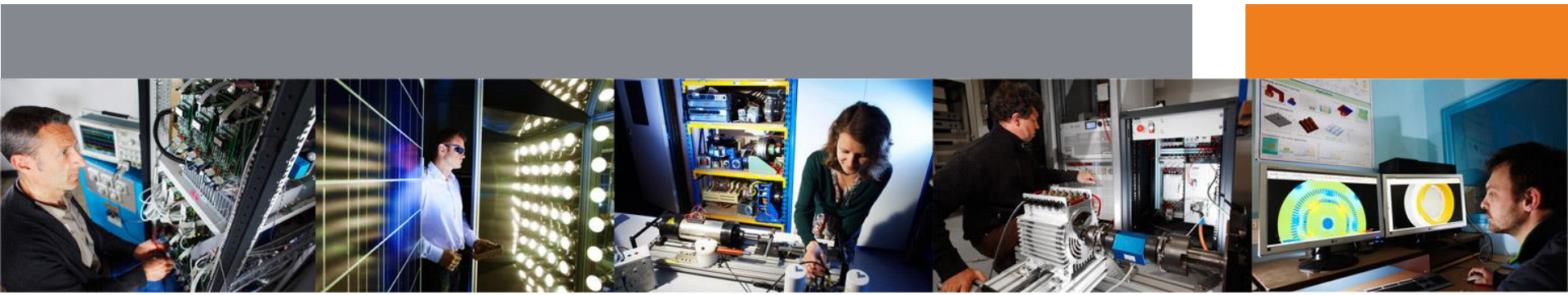

Thank you for your attention

[Eric.SEMAIL@ensam.eu](mailto:Eric.SEMAIL@ensam.eu)

[Ngacky.NGUYEN@ensam.eu](mailto:Ngacky.NGUYEN@ensam.eu)



## II. Bi-harmonic machine Design: Stator

**Tooth-Coil concentrated winding are used .**

### **Advantages**

- Shorter end-windings → more useful copper → more efficient machine.
- Higher filling factor: 20% more
- Simpler winding structure (easy manufacturing, maintenance, and recycling).

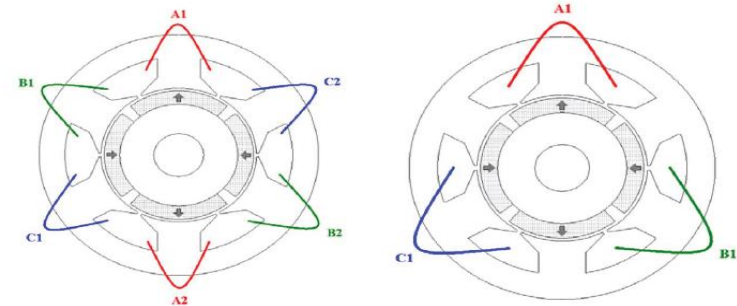

**Solution for high frequencies:**  
Combinations family with **Spp= 0,5**  
slot per pole and per phase.: Low  
MMF harmonic content, Less  
undesired effects (noise, PM losses).

### **Winding topology: (slot/pole combinaison):**

Bad choice of slot/pole combinaison → MMF with a lot of MMF harmful harmonics and sub-harmonics and mechanical vibration → Rotor eddy current losses can be induced especially at high frequencies → Demagnetization of magnets is possible.



**3-Phase  
12 slots / 8  
poles 2010  
TOYOTA  
Prius  
Generator**

# II. Bi-harmonic machine Design: Stator

5-Phase combination: 40 slots / 16 poles (1/2 slot per pole per phase)

➤ Low level of parasitic effects (with 1<sup>st</sup> harmonic)

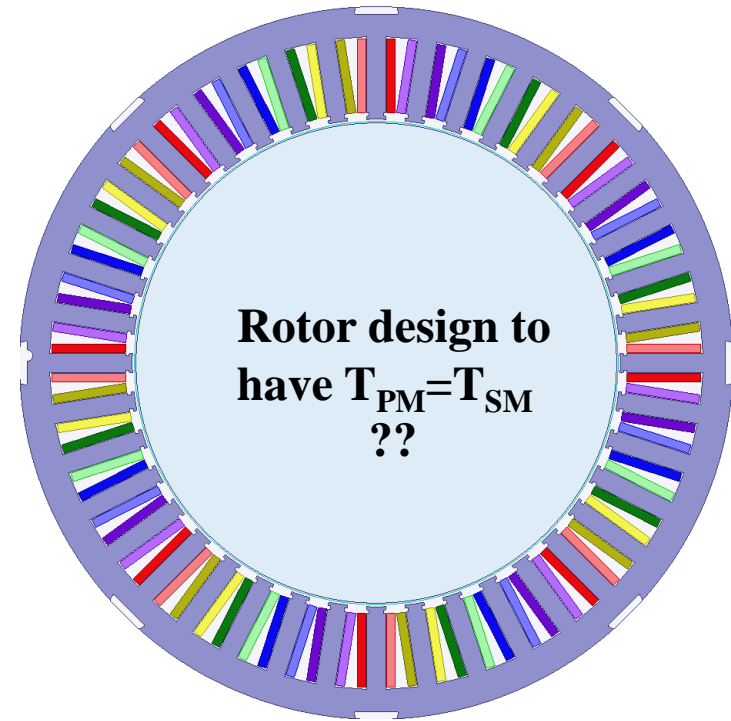
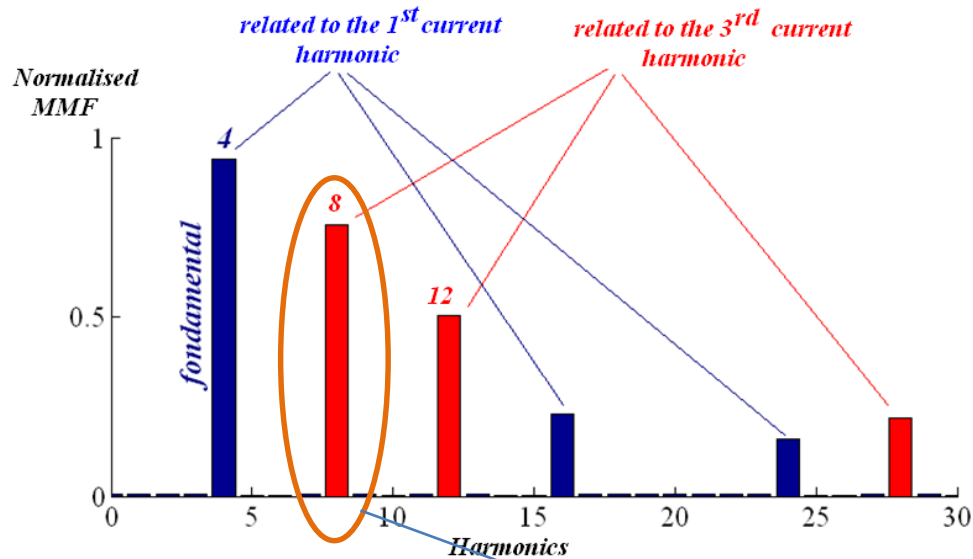

➤ Weak 1<sup>st</sup> harmonic winding factor  $(\xi_w)_1 = 0.588$

➤ High 3<sup>rd</sup> harmonic winding factor  $(\xi_w)_3 = 0.95$

**Possible Weak points:**  
 → small winding factor of first harmonic.  
 → one subharmonic (8) when supplied with 3 harmonic.



## II. Bi-harmonic machine Design: Rotor

**Structure with interior magnets is used.**

### Advantages

- flux concentration which boosts torque and improve torque density.
- Large flux weakening area due to the possibility to obtain higher value of  $L_d$
- Reluctant torque in addition to torque from Permanent Magnet, which improve machine compactness.

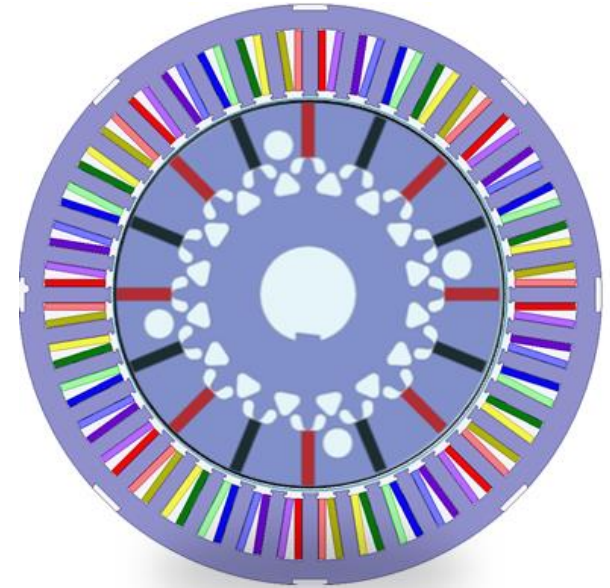

**Extra protection of magnets from the MMF harmonics**  
→ **Low magnet losses expected in this machine.**

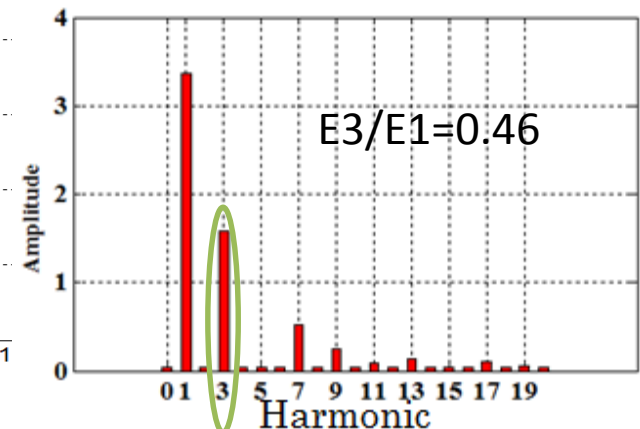
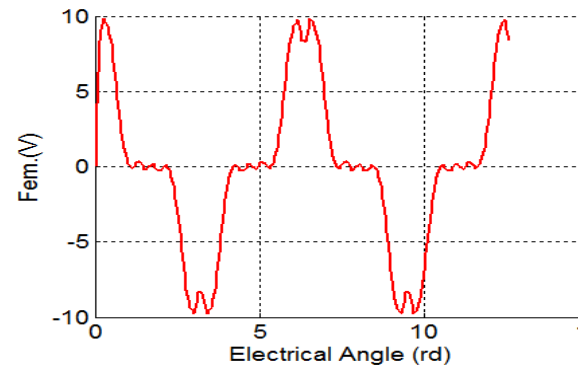

**Low potentiality of the third harmonic to produce torque**  
→ **TO MODIFY THE ROTOR TO OVERCOME THIS**

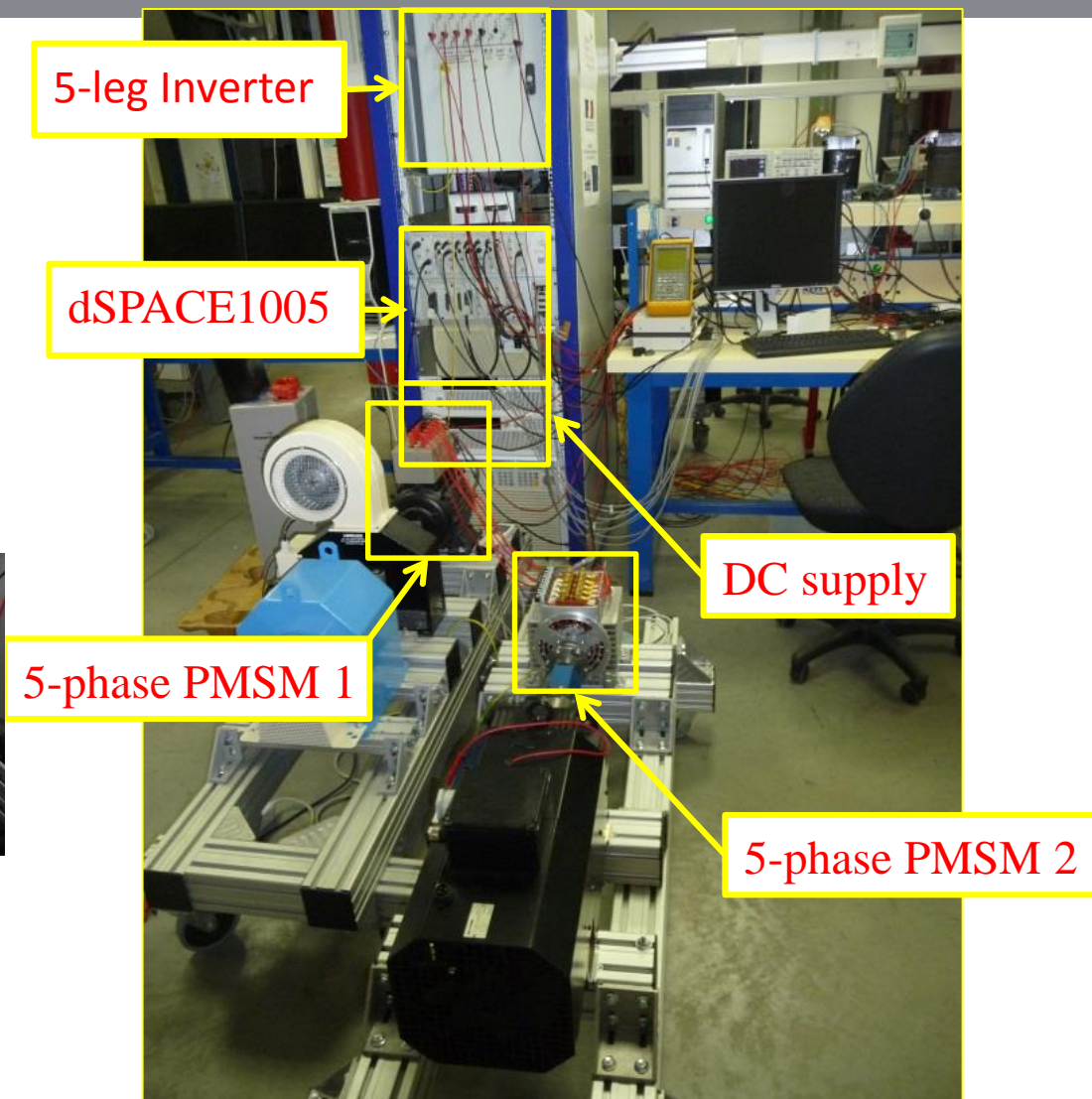

Fig. 1. Laboratory experimental test-bench



dSPACE and 2 DC sources

Open-end five-phase machine

Five-bridge inverter (one side)

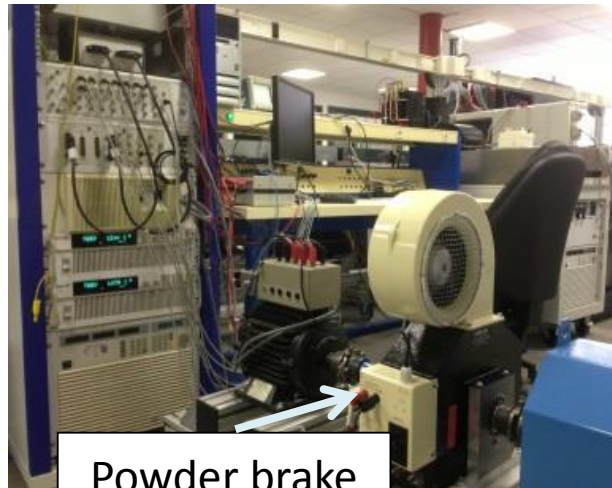

Powder brake

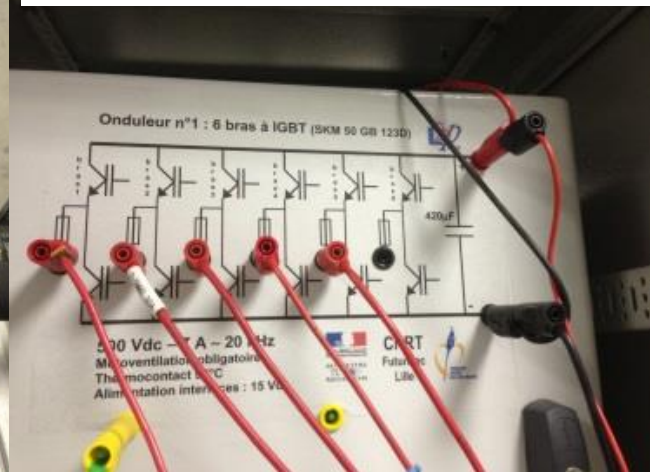
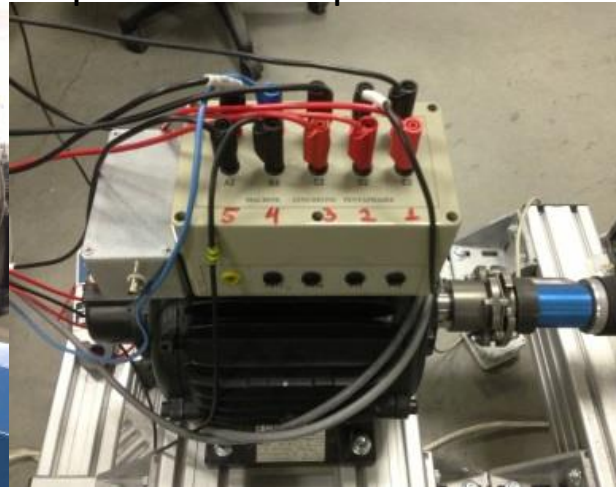

Laboratory experimental platform setup

## 5-phase machine parameters

Phase resistance:  $R=2.24 \Omega$ Inductance :  $L_{1d}=3.2 \text{ mH}$ Inductance  $L_{1q}=3.2 \text{ mH}$ Inductance  $L_{3d}=0.9 \text{ mH}$ Inductance  $L_{3q}=0.9 \text{ mH}$ 

$$k_{emf-1} = E_1 / \Omega = 0.32 \text{ (V.s.rad}^{-1}\text{)}$$

Maximum torque  $T_{em-max} = 20 \text{ N.m}$ Maximum speed  $\Omega_{max} = 2500 \text{ rpm}$ Bus voltage  $V_{bus}=70 \text{ V}$ Maximum phase current  $I_{max}=15 \text{ A}$

### V.B.3. Caractéristiques couple /vitesse dans les espaces fictifs

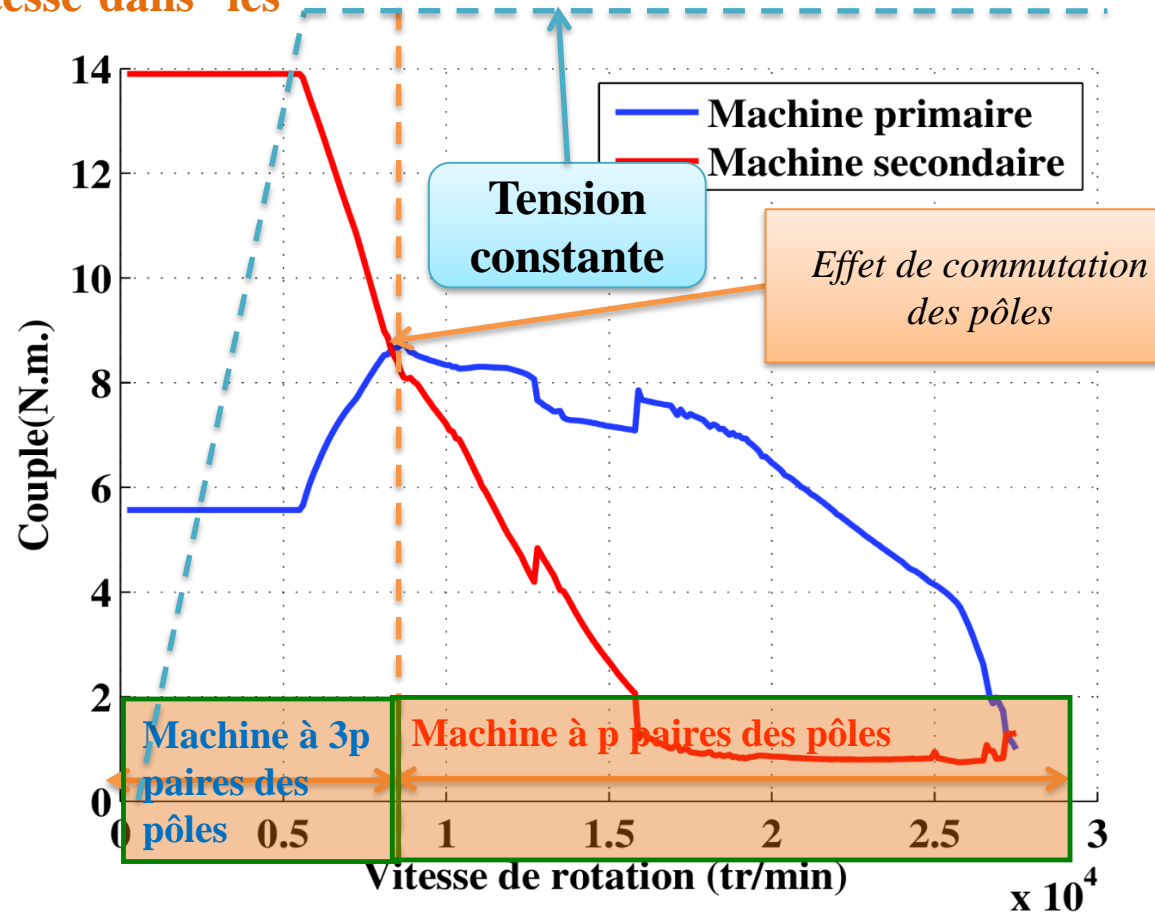
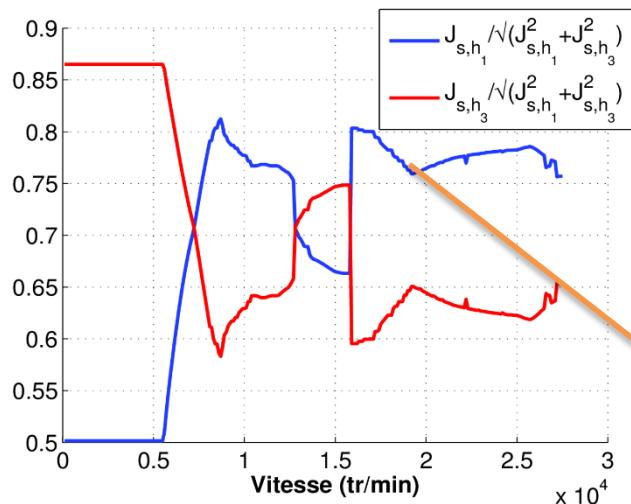
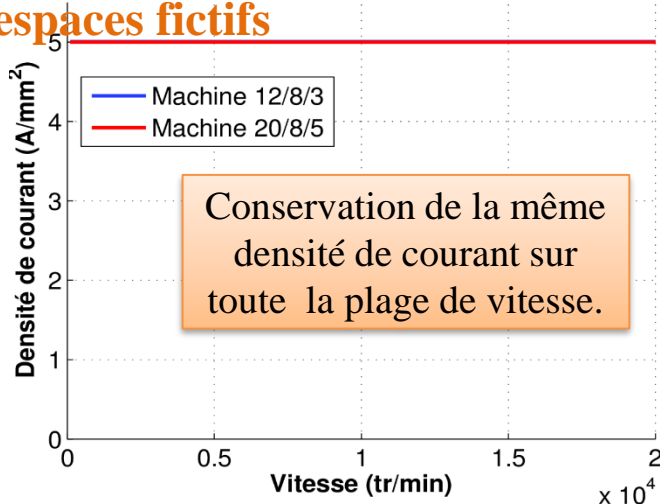

Contrairement au défluxage classique des machines triphasées, on agit sur la répartition de courant entre les machines fictives.

# Multiphase Decomposition Theory

## 5-phase PMSM

MM : 1st harmonic  
SM : 3th harmonic

Torque can be created by injecting the 1st and the 3th harmonic of currents

Real 5-phase machine

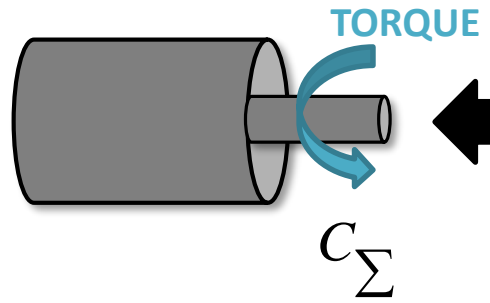

Fictitious Machines (2 diphas + 1 homopolar)

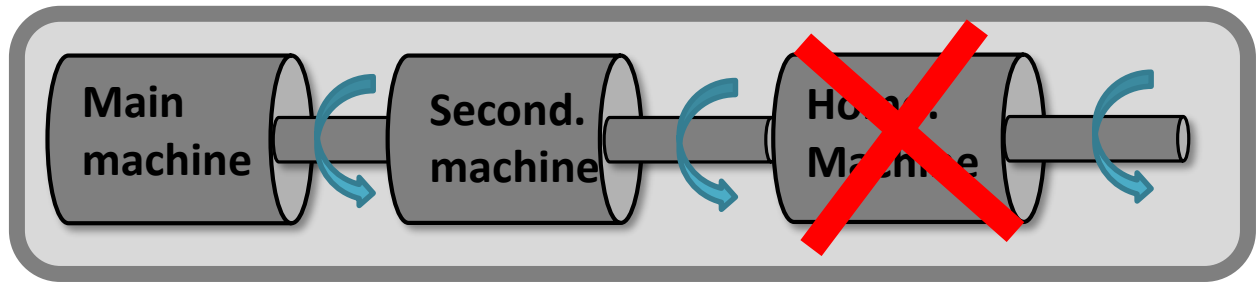

$h = \textcircled{1}, 9, 11, \dots$   
 $h = 5k \pm 1$

$h = \textcircled{3}, 7, \dots$   
 $h = 5k \pm 2$

$h = 5, 15, \dots$   
 $h = 5k$

Voltages  $V_{abcde}$

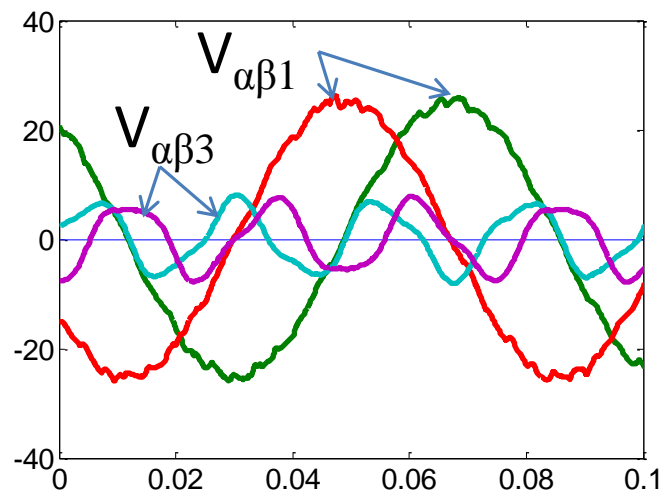
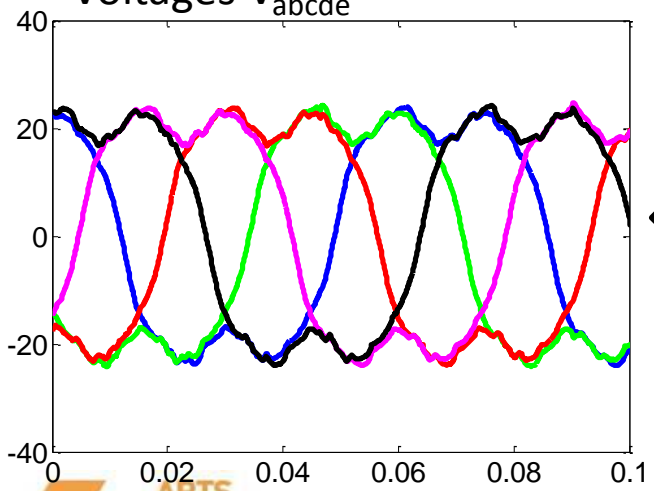

Voltages in decoupled base

# 2. Different Stator Winding Connections

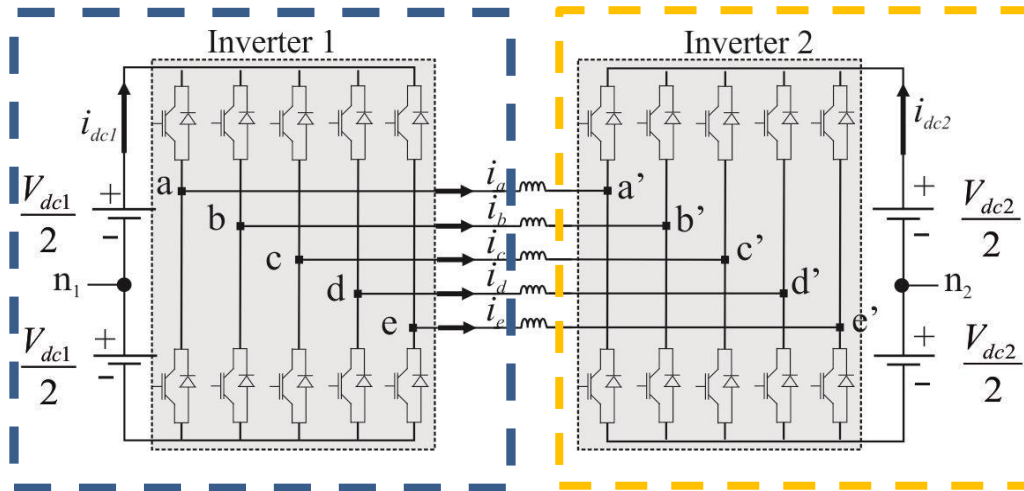

For all configurations, the **1<sup>st</sup> Inverter** is controlled as :

$$\mathbf{v}_{abcde-INV1} = \begin{bmatrix} v_{an_1} & v_{bn_1} & v_{cn_1} & v_{dn_1} & v_{en_1} \end{bmatrix}^T = V \begin{bmatrix} \sin \theta & \dots & \sin \left( \theta - \frac{8\pi}{5} \right) \end{bmatrix}^T$$

For **the 2<sup>nd</sup> Inverter**:

WYE  $\mathbf{v}_{abcde-INV2} = [0 \ 0 \ 0 \ 0 \ 0]^T$  (1)

PENTAGON  $\mathbf{v}_{abcde-INV2} = [v_{bn_1} \ v_{cn_1} \ v_{dn_1} \ v_{en_1} \ v_{an_1}]^T$  (2)

PENTACLE  $\mathbf{v}_{abcde-INV2} = [v_{cn_1} \ v_{dn_1} \ v_{en_1} \ v_{an_1} \ v_{bn_1}]^T$  (3)

BIPOLAR  $\mathbf{v}_{abcde-INV2} = -[v_{an_1} \ v_{bn_1} \ v_{cn_1} \ v_{dn_1} \ v_{en_1}]^T$  (4)

**SIMPLE**

