



**HAL**  
open science

# Vectorial Modeling and Control of Multiphase Machines with Non-salient Poles Supplied by an Inverter

Xavier Kestelyn, Eric Semail

► **To cite this version:**

Xavier Kestelyn, Eric Semail. Vectorial Modeling and Control of Multiphase Machines with Non-salient Poles Supplied by an Inverter. Jean-Paul Louis. Control of Non-conventional Synchronous Motors, Wiley, pp.161-206, 2012, 9781848213319. 10.1002/9781118603208.ch5 . hal-03170453

**HAL Id: hal-03170453**

**<https://hal.science/hal-03170453v1>**

Submitted on 16 Mar 2021

**HAL** is a multi-disciplinary open access archive for the deposit and dissemination of scientific research documents, whether they are published or not. The documents may come from teaching and research institutions in France or abroad, or from public or private research centers.

L'archive ouverte pluridisciplinaire **HAL**, est destinée au dépôt et à la diffusion de documents scientifiques de niveau recherche, publiés ou non, émanant des établissements d'enseignement et de recherche français ou étrangers, des laboratoires publics ou privés.

## Chapter 5

# Vectorial Modeling and Control of Multiphase Machines with Non-salient Poles Supplied by an Inverter

### 5.1. Introduction and presentation of the electrical machines we will study

This chapter is devoted to the modeling and control of electrical machines with at least two independent statoric currents. The star-coupled three-phase machine without a neutral terminal and the triangle-coupled three-phase machine are the most basic ones. More precisely, this chapter aims to emphasize the particularities created by a number of independent currents greater than two with respect to the classic three-phase machine.

To reach this goal, we will restrict ourselves to machines fulfilling certain hypotheses:

- constant magnetic air-gap (without variable reluctance effect);
- without magnetic saturation effect;
- built regularly, i.e. it is impossible to discriminate against phases as all of the phases are characterized by the same technological realisation.

In practice, these hypotheses allow us to deal with at least two large families of machines:

- synchronous machines with surface-mounted magnets;

– squirrel-cage induction machines.

Obviously real machines do not perfectly fulfill the hypotheses, but we will assume that the phenomena induced by the non-fulfilling of these hypotheses generate second-order phenomena that can be implicitly compensated for by robust control.

For control, squirrel-cage induction machines can be distinguished from synchronous machines with magnets, mainly because the magnetization of the machine is entirely controlled by the inverter supplying the stator. In fact, for synchronous machines with magnets, part of the magnetic field within the machine is not controlled by the supply. Hence, the study of the control of synchronous machines has more constraints than that of induction machines. For this reason, we will restrict the study in this chapter to that of synchronous machines with permanent magnets. The particularity of these machines lies in the number of phases and taking both space and time harmonics into account. This problem of the impact of harmonics on control has already been tackled in the case of three-phase synchronous machines with trapezoidal electromotive forces in [GRE 94] and [LOU 10]. In this chapter, we emphasize the originality induced by increasing the number of phases.

Finally, from among the machines studied we can also distinguish between several subfamilies by focusing on the connections that can be observed between the different coils of the statoric phases:

– machine without coupling between phases: each phase that has two connection terminals is generally supplied by a monophasic H inverter;

– simple star machine:  $n$  coils constituting the  $n$  phases are connected by a common point, the neutral terminal of the machine;

– multi-star machine:  $k$  stars we will be connected to  $n/k$  coils by a common point. We will therefore have  $k$  neutral points;

– machine with polygonal coupling:  $n$  coils constituting the  $n$  phases are connected in series. For the three-phase machines, we refer to this as triangle coupling.

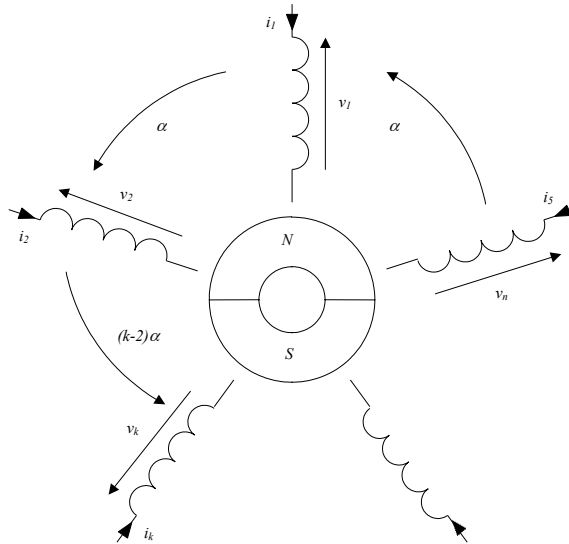
This chapter will only deal with the control of independent phase machines and simple star machines. The five-phase machine will be the reference example allowing easy generalization to  $n$ -phase machines from the vectorial formulation chosen.

**5.2. Control model of synchronous machines with permanent magnets and supplied by an inverter**

The following hypotheses and notations will be used to model the machine:

- the  $n$  phases are identical and shifted by an angle  $\alpha = 2\pi/n$ , and  $p$  is the number of pole pairs of the machine;
- the machine has smooth poles and is not saturated.

Figure 5.1 represents a two-pole  $n$ -phase machine in which variable  $g$  (a voltage, current, flux, etc.) is written  $g_k$  with respect to phase  $k$ .



**Figure 5.1.** Symbolic representation of a synchronous two-pole  $n$ -phase machine

**5.2.1. Characteristic spaces and generalization of the notion of an equivalent two-phase machine**

5.2.1.1. Equations in the natural basis of the stator and general vectorial expression

A Euclidean vectorial space  $E^n$  of dimension  $n$  as well as an orthonormal basis  $B^n = \{\vec{x}_1^n, \vec{x}_2^n, \dots, \vec{x}_n^n\}$  is combined with the  $n$ -phase machine. This is referred to as

natural, since the coordinates of vector  $\vec{g}$  in this basis are measurable variables  $g_k$  of stator phases:

$$\vec{g} = g_1 \vec{x}_1^n + g_2 \vec{x}_2^n + \dots + g_n \vec{x}_n^n = \sum_{k=1}^n g_k \vec{x}_k^n \quad [5.1]$$

Thus, the following vectors can be defined:

– voltage:  $\vec{v} = v_1 \vec{x}_1^n + v_2 \vec{x}_2^n + \dots + v_n \vec{x}_n^n$ ;

– current:  $\vec{i} = i_1 \vec{x}_1^n + i_2 \vec{x}_2^n + \dots + i_n \vec{x}_n^n$ ;

– linked flux:  $\vec{\phi} = \phi_1 \vec{x}_1^n + \phi_2 \vec{x}_2^n + \dots + \phi_n \vec{x}_n^n$ .

By considering the resistance  $R_s$  of a stator phase, we can determine a single voltage vectorial equation that gathers the scalar voltage equations of each phase:

$$\vec{v} = R_s \vec{i} + \left( \frac{d\vec{\phi}}{dt} \right)_{/B^n} \quad [5.2]$$

From the hypothesis of non-saturation, equation [5.2] can be written as:

$$\vec{v} = R_s \vec{i} + \left( \frac{d\vec{\phi}_{ss}}{dt} \right)_{/B^n} + \left( \frac{d\vec{\phi}_{sr}}{dt} \right)_{/B^n} \quad [5.3]$$

In [5.3], the term  $\left( \frac{d\vec{\phi}_{ss}}{dt} \right)_{/B^n}$  is due to the contribution of stator currents, while  $\left( \frac{d\vec{\phi}_{sr}}{dt} \right)_{/B^n}$  is due to the contribution of the rotor (permanent magnets or inductor coil for a synchronous machine, and rotor coils or bars for an induction machine).

In the case of a synchronous machine with smooth poles, equation [5.3] is more classically written as:

$$\vec{v} = R_s \vec{i} + \lambda \left( \left( \frac{d\vec{i}}{dt} \right)_{/B^n} \right) + \vec{e} \quad [5.4]$$

in which:

–  $\lambda$  is a linear application (or morphism) so that  $\lambda(\vec{i}) = \vec{\phi}_{ss}$ . This application is commonly written in natural basis  $B^n$  in the form of a symmetrical matrix ( $L_{xy} = L_{yx}$ ) detailed by equation [5.5]. This matrix, given the hypothesis of constructive regularity that leads to all phases being equivalent, is circulating, i.e. we get line  $n^\circ 2$  of the matrix from line  $n^\circ 1$  by simple shifting of one rank ( $L_{21} = L_{1n}$ ,  $L_{22} = L_{11}$ ,  $L_{23} = L_{12}$ , etc.);

$$[L_s^n] = \text{mat}(\lambda, B^n) = \begin{pmatrix} L_{11} & L_{12} & \cdots & L_{1n} \\ L_{21} & L_{22} & \cdots & L_{2n} \\ \vdots & \vdots & \ddots & \vdots \\ L_{n1} & L_{n2} & \cdots & L_{nn} \end{pmatrix} \quad [5.5]$$

–  $\vec{e} = \left( \frac{d\vec{\phi}_{sr}}{dt} \right)_{/B^n}$  is the electromotive forces (emfs) vector, which is written in the form of a function  $\vec{e}$  (speed-normalized emf) depending only on  $\theta$ , the relative position of the rotor with respect to the stator coils, and on speed  $\Omega$  of the rotor, see [5.6]:

$$\vec{e} = \Omega \vec{e}(\theta) \quad [5.6]$$

More than allowing synthetic writing, the vectorial relationships ease the calculations of powers and torque. The instantaneous power flowing through the machine is obtained by the simple scalar product of the voltage and current vectors:

$$p = \vec{v} \cdot \vec{i} = \sum_{k=1}^n v_k i_k \quad [5.7]$$

By replacing expression [5.4] of the voltage vector in equation [5.7], we get:

$$p = R_s (\vec{i})^2 + \lambda \left( \left( \frac{d\vec{i}}{dt} \right)_{/B^n} \right) \cdot \vec{i} + \vec{e} \cdot \vec{i} \quad [5.8]$$

Here, we recognize the following within the framework of the hypotheses:

–  $p_j = R_s (\vec{i})^2$ , the stator Joule losses;

–  $p_{mag} = \left( \lambda \left( \frac{d\vec{i}}{dt} \right)_{/B^n} \right) \cdot \vec{i}$ , the power linked to the magnetic energy stored;

–  $p_{em} = \vec{e} \cdot \vec{i}$ , the electromechanical power developed by the machine that lies in the origin of the creation of an electromagnetic torque  $c$ , expressed by:

$$c = \frac{p_{em}}{\Omega} = \frac{\vec{e} \cdot \vec{i}}{\Omega} = \vec{e} \cdot \vec{i} = \sum_{k=1}^n \varepsilon_n i_n \quad [5.9]$$

### 5.2.1.2. Determination of a decoupling basis

If vectorial relationship  $\vec{\phi}_{ss} = \lambda(\vec{i})$  between the stator flux and stator current vectors remains true whichever the basis of space  $E^n$  chosen, it is not true when it comes to matricial relationships between the coordinates of these vectors. The vector coordinates are obtained by projecting the vectors on the generating vectors of the basis. We can then understand that if we project the vectors in another basis, the relationships between the coordinates will change. The matrix that characterizes morphism  $\lambda$  in the natural basis is generally a full matrix. Therefore, couplings between the different phases that appear are not appreciated within the control framework.

If there is a basis in which the matrix of morphism  $\lambda$  is diagonal, we prefer to work in this basis when considering control. The coordinates in this basis of voltage, current and flux vectors are no longer measurable, but fictitious.

In the case of morphisms characterized by a symmetrical matrix (which is the case of  $\lambda$ ), we are assured of the existence of such bases that ensure decoupling of the different coordinates. Furthermore, these bases are orthogonal and the eigenvalues are real.

A basis can be determined by analyzing the inductance matrix  $[L_s^n]$ , the characteristic matrix of morphism  $\lambda$  between the stator flux and stator current vectors in the natural basis. In this basis, eigenvectors are associated with the eigenvalues  $\Lambda_k$  of morphism  $\lambda$ . We recall that eigenvalues  $\Lambda_k$  are the solutions to characteristic equation [5.10], in which  $[I_n]$  is the identity matrix of dimension  $n$ :

$$\det(\Lambda[I_n] - [L_s^n]) = 0 \quad [5.10]$$

The detailed calculation of these eigenvalues and the associated eigenvectors can be found in [SEM 00], and in an analogous form in [WHI 59].

In the new decoupling basis  $B^d = \{\bar{x}_1^d, \bar{x}_2^d, \dots, \bar{x}_n^d\}$ , characteristic matrix  $[L_s^d]$  of morphism  $\lambda$  is expressed:

$$[L_s^d] = \text{mat}(\lambda, B^d) = \begin{pmatrix} \Lambda_1 & 0 & \dots & 0 \\ 0 & \Lambda_2 & \dots & 0 \\ \vdots & \vdots & \ddots & \vdots \\ 0 & 0 & \dots & \Lambda_n \end{pmatrix} \quad [5.11]$$

Matrix  $[L_s^d]$  is obtained by classic basis change, as described by [5.12] with  $[T_{nn}]$  the matrix of basis change. We are reminded that obtaining the coefficients of matrix  $[T_{nn}]$  is easy since, by definition, each column of  $[T_{nn}]$  consists of coordinates, in the natural basis, of one of the new eigenvectors that constitute the orthonormal decoupling basis.

Things being as they are, in practice matrix  $[T_{nn}]$  is less useful than its inverse,  $[T_{nn}]^{-1}$ . In fact, it is relationship [5.13] that allows us to obtain the coordinates of a vector in the new decoupled basis as a function of coordinates in the natural basis.

Although obtaining  $[T_{nn}]^{-1}$  from  $[T_{nn}]$  is rarely, it is in our case, since the inverse matrix is identical to the transposed matrix:  $[T_{nn}]^{-1} = [T_{nn}]^t$ . This property comes from the fact that matrix  $[L_s^n]$  is symmetrical, which implies the orthogonality property of matrix  $[T_{nn}]$ .

Therefore each line of  $[T_{nn}]^{-1}$ , presented in [5.14], is also defined by coordinates in the natural basis and the eigenvectors that make up the new decoupling basis. We clarify that in equation [5.14]:  $\alpha = 2\pi/n$ ;  $c_k = \cos(k\alpha)$ ;  $s_k = \sin(k\alpha)$ ; if  $n$  is even,  $K = (n-2)\alpha/2$ ; if  $n$  is odd,  $K = (n-1)\alpha/2$  and we will omit the last line of the transformation matrix.

The analysis that has just been carried out aims to emphasize the specificity of  $[T_{nn}]$  or  $[T_{nn}]^{-1}$ , whose synthesis does not come from the aim to simplify calculation but directly from the analysis of the inductance matrix.

$$[L_s^d] = [T_{nn}]^{-1} [L_s^n] [T_{nn}] \quad [5.12]$$



$$\begin{pmatrix} \bar{x}_1^d \\ \bar{x}_2^d \\ \vdots \\ \bar{x}_n^d \end{pmatrix} = [T_{nm}]^{-1} \begin{pmatrix} \bar{x}_1^n \\ \bar{x}_2^n \\ \vdots \\ \bar{x}_n^n \end{pmatrix} \quad [5.13]$$

$$[T_{nm}]^{-1} = \sqrt{\frac{2}{n}} \begin{pmatrix} 1 & c_1 & c_2 & c_3 & \cdots & c_3 & c_2 & c_1 \\ 0 & s_1 & s_2 & s_3 & \cdots & -s_3 & -s_2 & -s_1 \\ 1 & c_2 & c_4 & c_6 & \cdots & c_6 & c_4 & c_2 \\ 0 & s_2 & s_4 & s_6 & \cdots & -s_6 & -s_4 & -s_2 \\ 1 & c_3 & c_6 & c_9 & \cdots & c_9 & c_6 & c_3 \\ 0 & s_3 & s_6 & s_9 & \cdots & -s_9 & -s_6 & -s_3 \\ \vdots & \vdots & \vdots & \vdots & \ddots & \vdots & \vdots & \vdots \\ 1 & c_K & c_{2K} & c_{3K} & \cdots & c_{3K} & c_{2K} & c_K \\ 0 & s_K & s_{2K} & s_{3K} & \cdots & -s_{3K} & -s_{2K} & -s_K \\ \frac{1}{\sqrt{2}} & \frac{1}{\sqrt{2}} & \frac{1}{\sqrt{2}} & \frac{1}{\sqrt{2}} & \cdots & \frac{1}{\sqrt{2}} & \frac{1}{\sqrt{2}} & \frac{1}{\sqrt{2}} \\ \frac{1}{\sqrt{2}} & \frac{-1}{\sqrt{2}} & \frac{1}{\sqrt{2}} & \frac{-1}{\sqrt{2}} & \cdots & \frac{-1}{\sqrt{2}} & \frac{1}{\sqrt{2}} & \frac{-1}{\sqrt{2}} \end{pmatrix} \quad [5.14]$$

Besides relationships [5.11] to [5.14], some properties of morphism  $\lambda$  are very useful. Given the circularity of inductance matrix  $[L_s^n]$ , the eigenvalues  $\Lambda_k$  of  $\lambda$  are generally “double”, i.e. we can associate two independent eigenvectors with them. Only one of the eigenvalues is “single” (i.e. associated with a single eigenvector) in the case of an odd number of phases  $n$ ; two are “single” in the case of an even number of phases  $n$ .

Thus, the latter properties allow us to justify the use of star couplings for machines with an odd number of phases and multi-star couplings for machines with an even number of phases when considering control. In fact, these couplings allow us to ensure that the currents associated with the single eigenvalues (also called homopolar currents) are rigorously kept at 0.

Finally, it is the presence of a double eigenvalue, better known as cyclical inductance, that has allowed us to introduce the notion of the equivalent two-phase machine, which well accepted in the three-phase case.

### 5.2.1.3. Equations in the decoupling basis and independent energy fluxes

In section 5.2.1.2 we have shown that it is possible to determine an orthonormal decoupling basis in which inductance matrix  $[L_s^d]$  is diagonal. Furthermore, we have assumed that the eigenvalues of this matrix were double, except for one single in the case odd  $n$  and two singles in the case even  $n$ .

The initial vectorial space can therefore be broken down into a sum of vectorial subspaces of one or two dimensions, each combined with an eigenvalue  $\Lambda_k$  of  $[L_s^d]$ , double or single. These subspaces, also referred to as eigenspaces of morphism  $\lambda$  are orthogonal because all the eigenvectors of morphism  $\lambda$  are orthogonal. A vector  $\vec{g}$  belonging to vectorial space  $E^n$  can then be broken down into a unique sum of vectors of one or two dimensions, each belonging to a vectorial Eigen subspace  $E^{se}$  of one or two dimensions. The  $E^{se}$  vectors are obtained by orthogonal projection of vector  $\vec{g}$  on each of subspaces  $E^{se}$ .

Applied to the voltage equation [5.4], this break down leads to the following equation, in which  $N$  is the number of subspaces,  $E^{se}$ :

$$\vec{v} = \sum_{m=1}^N \vec{v}_k^d = \sum_{m=1}^N \left( R_s \vec{i}_m^d + \Lambda_m \left( \frac{d\vec{i}_m^d}{dt} \right)_{/B^d} + \vec{e}_m^d \right) \quad [5.15]$$

If we now look for the electromagnetic torque using a power assessment, by recalling that Eigen subspaces  $E^{se}$  are orthogonal, we can find:

$$\begin{aligned} p &= \vec{v} \cdot \vec{i} = \left( \sum_{m=1}^N \vec{v}_k^d \right) \cdot \left( \sum_{m=1}^N \vec{i}_k^d \right) = \sum_{m=1}^N \left( \vec{v}_k^d \cdot \vec{i}_k^d \right) \\ &= \sum_{m=1}^N \left( R_s \left( \vec{i}_m^d \right)^2 + \Lambda_k \cdot \left( \frac{d\vec{i}_m^d}{dt} \right)_{/B^d} \cdot \vec{i}_m^d + \vec{e}_m^d \cdot \vec{i}_m^d \right) \end{aligned} \quad [5.16]$$

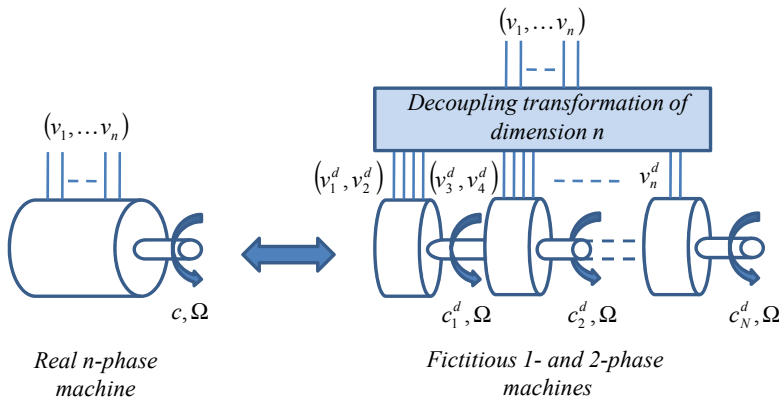
In [5.16] a term that associates with Joule losses appears, then another term with the storage of magnetic energy and finally a term with the electromechanical conversion. By expanding this last term according to equation [5.17], it appears that the total mechanical energy of the machine is the sum of  $N$  mechanical energies, each associated with a subspace,  $E^{se}$ . It is therefore possible to consider that the torque supplied by the real machine is the sum of torques supplied by  $N$  fictitious machines. Each of these machines is characterized by its resistance,  $R_s$ , its inductance,  $\Lambda_k$ , and its emf vector,  $\vec{e}_m^d$ . According to the dimension of the eigenspace with which it is associated, the fictitious machine will be monophasic or

two-phase. These machines all run at the same speed. They can therefore be considered mechanically coupled.

$$c = \sum_{m=1}^N c_m^d = \sum_{m=1}^N \frac{\vec{e}_m^d \cdot \vec{i}_m^d}{\Omega} = \sum_{m=1}^N \vec{e}_m^d \cdot \vec{i}_m^d \quad [5.17]$$

Figure 5.2 illustrates the equivalence between an  $n$ -phase machine and a set of fictitious monophase and two-phase machines.

It has to be noted that if we can find an infinity of  $T_{nn}$  type transformations, there one and only one break down into fictitious machines (mathematically, breaking down a vector on the eigenspaces of morphism  $\lambda$ ). This uniqueness is a key point of the vectorial approach with respect to matricial approaches using transformations of infinite number. Naturally this break down can also be applied to the three-phase case: the three-phase machine is *a priori* equivalent to two machines – one monophase and the other two-phase. We will see why only the two-phase machine is kept when the machine is star-coupled.



**Figure 5.2.** Equivalence between an  $n$ -phase machine and a set of fictitious one- and two-phase mechanically coupled machines

#### 5.2.1.4. Fundamental harmonic properties of fictitious machines

The concept of fictitious machines allows us to transform the real machine, whose phases are magnetically coupled, into a sum of magnetically decoupled one- and two-phase fictitious machines. In this section, we show that the variables

associated with a fictitious machine consist of a harmonic group of the real machine's variables. This aspect is fundamental when working out the control of a machine or during its design phase, particularly in the case of fault-tolerant machines. Each fictitious machine possesses its own features that need to be known for proper design and control.

#### 5.2.1.4.1. Characteristic harmonics groups

Let  $\vec{g}$  be a vector variable associated with the real machine. We assume that each of the vector variable coordinates has a period  $2\pi/p$ , i.e. it can be broken down into a Fourier series. We define  $\theta$  as the mechanical angle between the rotor and the stator.

$$\vec{g} = \sum_{k=1}^n g_k \vec{x}_k^n \quad [5.18]$$

with:

$$g_k = \sum_{h=1}^{\infty} g_h^{\max} \sin\left(h\left(p\theta - (k-1)\frac{2\pi}{n}\right)\right) \quad [5.19]$$

We calculate the coordinates of the vector variables associated with fictitious machines by projecting the vector variable on the different subspaces  $E^{sc}$  associated with fictitious machines. We will find the details of the calculations in [KES 03]. We only discuss the basic idea here.

Assuming that a subspace associated with fictitious machine number  $m$  ( $m \in \{1, N\}$ ) is generated by vectors  $\{\vec{x}_{2m-1}^d, \vec{x}_{2m}^d\}$  of decoupling basis  $B^d$ , defined by equation [5.13] and corresponding to the lines of matrix  $[T_m]^{-1}$  given by [5.14]. Equation [5.20] reminds us that projection  $\vec{g}_{2m-1}^d$  of vector variable  $\vec{g}$  is obtained by simple scalar products.

$$\vec{g}_{2m-1}^d = (\vec{g} \cdot \vec{x}_{2m-1}^d) \vec{x}_{2m-1}^d + (\vec{g} \cdot \vec{x}_{2m}^d) \vec{x}_{2m}^d = g_{2m-1}^d \vec{x}_{2m-1}^d + g_{2m}^d \vec{x}_{2m}^d \quad [5.20]$$

In [KES 03] and [SEM 04a] it is shown that the coordinates of the vector variable written in the basis generating a subspace (or fictitious machine) consist of a harmonics group of the variables of the real machine. With the presence of harmonics families, we find a result expressed by Klingshirn [KLI 83] within the framework of the supply of a multiphase asynchronous machine with inverter in full square wave mode in steady state.

Equations [5.21] and [5.22] give the expression of the coordinates of  $\vec{g}_{2m-1}^d$  in an Eigen subspace. In these equations, the harmonic ranks (assumed to be positive) that appear for  $m$  fictitious machines are  $h = nl + \sigma m$ , with  $\sigma = \{-1, 0, +1\}$  and  $l \in \mathbb{N}$ .  $\sigma$  allows us to take into account whether a vector is homopolar ( $\sigma = 0$ ), rotating in clockwise (direct) direction ( $\sigma = +1$ ) or anticlockwise (retrograde) direction ( $\sigma = -1$ ).

$$g_{2m-1}^d = \sqrt{\frac{n}{2} \left( \sum_{l=0}^{\infty} g_h^{\max} \sin(hp\theta) \right)} \quad \text{with } h = nl + \sigma m \quad [5.21]$$

$$g_{2m}^d = -\sqrt{\frac{n}{2} \left( \sum_{l=0}^{\infty} \sigma g_h^{\max} \cos(hp\theta) \right)} \quad \text{with } h = nl + \sigma m \quad [5.22]$$

Table 5.1 summarizes the harmonics groups associated with three-phase, five-phase and seven-phase machines. [SEM 03a] contains the case of the six-phase double-star machine, referred to as a double-star three-phase machine. The fictitious machine is the principal machine associated with the first harmonic. That machine associated with the second harmonic is secondary. The machine associated with the third harmonic, is the tertiary machine and that associated with harmonic  $n$  is homopolar. In the case of a monophasic fictitious machine ( $\sigma = 0$ ), we will replace

coefficient  $\sqrt{\frac{n}{2}}$  with  $\sqrt{n}$ .

	Three-phase machine	Five-phase machine	Seven-phase machine
Principal machine	$m=1, \sigma = \pm 1$ $h=1, 2, 4, 5, 7, \dots$	$m=1, \sigma = \pm 1$ $h=1, 4, 6, 9, 11, \dots$	$m=1, \sigma = \pm 1$ $h=1, 6, 8, 13, 15, \dots$
Secondary machine	Nonexistent	$m=2, \sigma = \pm 1$ $h=2, 3, 7, 8, 12, \dots$	$m=2, \sigma = \pm 1$ $h=2, 5, 9, 12, 16, \dots$
Tertiary machine	Nonexistent	Nonexistent	$m=3, \sigma = \pm 1$ $h=3, 4, 10, 11, 17, \dots$
Homopolar machine	$m=2, \sigma = 0$ $h=0, 3, 6, 9, \dots$	$m=3, \sigma = 0$ $h=0, 5, 10, 15, \dots$	$m=4, \sigma = 0$ $h=0, 7, 14, 21, \dots$

**Table 5.1.** Summary table of harmonic groups associated with three-phase, five-phase and seven-phase machines

For instance, harmonics 1 and 2 associated with a five-phase machine generate rotating vectors in the direct direction, 3 and 4 in the retrograde direction, 6 and 7 in the direct direction, etc.

We again find the well-known results for the three-phase machine. The odd harmonics of electromotive force of rank 5 (retrograde) and rank 7 (direct), by interaction with the first current harmonic, induce (direct) torque pulsations of rank 6. Similarly, the harmonics of rank 11 (retrograde) and 13 (direct) induce torque pulsations of rank 12.

For a five-phase machine, the harmonics of rank 9 (retrograde) and 11 (direct), by interaction with the first current harmonics, induce torque pulsations of rank 10. The harmonics of rank 7 (direct) and 13 (retrograde) interact with the harmonics of rank 3 (retrograde) to generate torque pulsations of rank 10.

It must be noticed that in general the harmonics of even ranks have a value of 0 except in the case of pole asymmetry. Therefore their case has not been developed.

#### 5.2.1.4.2. Relationship between emf harmonics and torque generated by a fictitious machine

If we apply the “real variables to decoupled variables” transformation to the emfs of a machine possessing  $n$  phases, we can formulate different remarks:

- If the emfs of the real machine are sinusoidal; only the principal fictitious machine has an emf. In this case, according to equation [5.17], only the fictitious machine can generate a torque.

- If the number of phases of the machine is odd, the emf harmonics of the real machine that has a rank multiple of the number of phases ( $h=an$ ,  $a$  integer) cannot generate a constant torque. In fact, these harmonics are assigned to the monophasic fictitious machine referred to as being homopolar. This remark partially justifies the quasi-systematic use of star coupling between the phases, which ensures 0 current in the homopolar machine.

- If the emfs of the real machine have odd harmonics whose rank  $h$  is less than or equal to the number of phases  $n$ , the fictitious machines have a sinusoidal emf (or some are 0 if  $h < n$ ).

- If the emfs of the real machine have more harmonics than the number of phases, there is at least one fictitious machine possessing non-sinusoidal emf.

We will notice that these remarks increase in importance when designing the control of the machine.

#### 5.2.1.4.3. Inductances and electrical time constants of fictitious machines: the impact of harmonics

If we can restrict ourselves to estimating (with suitable precision) the value of inductances of a three-phase machine with smooth poles, that is not saturated and is star coupled by considering that the magnetomotive forces are sinusoidal, it is imperative to take account of the magnetomotive force harmonics when estimating the inductances of a multiphase machine. In the opposite case, there will be considerable error in the estimation of electrical time constants associated with fictitious machines, the parameters necessary for proper design of the machine's supply system and in tuning the associated servo-systems.

Equation [5.23] reminds us of the analytical expression of the inductance between phases  $j$  and  $k$  by considering sinusoidal magnetomotive forces [LOU 04d, WHI 59]:

$$L_{jk} = \frac{2\mu_0 (k_s N_s)^2 DL}{\pi e} \cos(\delta_{jk}) + l_{leaks} \quad [5.23]$$

with:

- $\mu_0$ : permeability of air;
- $k_s$ : coil coefficient;
- $N_s$ : the number of turns of a coil (with  $p$  coils per phase);
- $D$ : the inner diameter of the stator;
- $L$ : the effective length of the stator;
- $e$ : the thickness of the magnetic air-gap (air + magnets);
- $\delta_{jk} = \frac{2\pi(j-k)}{n}$ : the angle separating phases  $j$  and  $k$ ; and
- $l_{leaks}$ : leakage inductances (generally considered zero-valued if  $j \neq k$ ).

In this case, the calculation of inductances associated with fictitious machines leads to the following conclusions:

- the inductance associated with the principal fictitious machine (or cyclical inductance) is  $A_1 = \frac{n}{2}L + l_{leaks}$ , with  $L$  being the self-inductance of a phase ( $j=k$  in equation [5.23]);

– the inductances associated with the other fictitious machines are  $\Lambda_m = I_{leaks}$ ,  $m \geq 2$ .

Thus, we can conclude that a multiphase machine with sinusoidal magnetomotive forces possessing few leaks is not a “good” machine in the way we mean when discussing a three-phase star-coupled machine. In fact, some fictitious machines have very weak inductances (because they are only equal to the leakages inductances) and will require the machine to be supplied with inverters with a very high chopping frequency. If this condition is not fulfilled, we observe large amplitude interference currents induced by the pulse width modulation (PWM).

Similarly, modeling a multiphase machine by assuming the systematic hypothesis that magnetomotive forces are sinusoidal can lead us to make quite significant errors in the evaluation of the inductances associated with fictitious machines [LOC 06, SEM 03b]. This error leads us to considerably overdimension the supply system and to mistune the correctors of associated currents.

If we take the magnetomotive force harmonics into account, we need to add the contribution due to the harmonics to the fundamental inductance expressed by equation [5.23]. The magnetic system being considered linear, we can apply a superposition theorem. The inductances associated with the real machine are then expressed by the following equation in which  $q$  are the magnetomotive force harmonic ranks that are kept:

$$L_{jk} = \sum_q L^q \cos(q\delta_{jk}) + I_{leaks} \quad [5.24]$$

In the particular case of concentrated coils with diametral pitch (located in only two notches and separated by a pole pitch), the harmonic inductance  $L^q$  is expressed by:

$$L^q = \frac{1}{q^2} \frac{2\mu_0 N_s^2 DL}{\pi e}, \quad q \text{ odd} \quad [5.25]$$

If we consider the magnetomotive force harmonics, the expression of inductance associated with  $m$  fictitious machines is given by:

$$\Lambda_m = \frac{n}{2} \sum_h L^h + I_{leakage} \quad [5.26]$$

According to the fictitious machine, the harmonic ranks  $h$  to consider keeping are recorded in Table 5.1. In equation [5.26], we are reminded that that  $h = nl + \sigma m$  with  $l$  being the integer and  $m$  the number of fictitious machines related.



According to equation [5.26], we conclude that the inductances associated with fictitious machines other than the principal fictitious machine, are not only equal to the leakage inductance but also to a particular group of harmonic inductances. Thus, the existence of magnetomotive force harmonics allows us to increase the electrical time constant of a fictitious machine and allows the use of a smaller chopping frequency when the machine is supplied by an inverter.

It is this multiharmonics approach that fundamentally distinguishes the results presented in this chapter from those presented in Chapter IX of [WHI 59], for which only a first harmonic approach was used to model multiphase machines. This first harmonic approach had as a corollary in that only the two-phase machine associated with the first harmonic was susceptible to torque generation and that the other two-phase and monophasic machines were reduced to circuits characterized by the leakage inductance of the machine and the stator resistance.

We remember with the proposed approach several fictitious machines can contribute to the generation of torque (average but also pulsating), but there are design constraints so that a multiphase machine can be supplied with inverters whose PWM frequency is not too high. Here, we must take into account the harmonics whose impact is no longer a second-order phenomenon with respect to supply by an inverter [SCU 09].

#### 5.2.1.4. Examples

##### 5.2.1.4.1. Three-phase machine

In this section, we consider a classic example of a three-phase synchronous machine with sinusoidal emf. It is equipped with distributed stator coils that generate a magnetomotive force with sinusoidal spatial distribution.

We associate a vectorial three-dimensional space with the machine that is equipped with an orthonormal natural basis  $B^n = \{\vec{x}_1^n, \vec{x}_2^n, \vec{x}_3^n\}$ . The vectorial voltage equation of this machine is given by equation [5.4], where the inductance matrix, characteristic of linear application  $\lambda$ , and the emf vectors are detailed by:

$$[L_s^n] = L \begin{pmatrix} 1 + \frac{l_{leaks}}{L} & \cos \frac{2\pi}{3} & \cos \frac{2\pi}{3} \\ \cos \frac{2\pi}{3} & 1 + \frac{l_{leaks}}{L} & \cos \frac{2\pi}{3} \\ \cos \frac{2\pi}{3} & \cos \frac{2\pi}{3} & 1 + \frac{l_{leaks}}{L} \end{pmatrix} \quad [5.27]$$

and:

$$\bar{e} = \varepsilon_{\max} \Omega \left( \sin(p\theta) \bar{x}_1^n + \sin\left(p\theta - \frac{2\pi}{3}\right) \bar{x}_2^n + \sin\left(p\theta - \frac{4\pi}{3}\right) \bar{x}_3^n \right) \quad [5.28]$$

If we apply the Concordia transformation expressed by [5.29], which is determined by equation [5.14] in the case where  $n = 3$ , the real machine of referenced variables (1,2,3) is broken down into two fictitious machines: a two-phase machine, referred to as the principal machine, referenced ( $\alpha, \beta$ ); and a homopolar monophasic machine, referenced  $z$ .

$$[T_{33}]^{-1} = \sqrt{\frac{2}{3}} \begin{pmatrix} 1 & \cos \frac{2\pi}{3} & \cos \frac{2\pi}{3} \\ 0 & \sin \frac{2\pi}{3} & -\sin \frac{2\pi}{3} \\ \frac{1}{\sqrt{2}} & \frac{1}{\sqrt{2}} & \frac{1}{\sqrt{2}} \end{pmatrix}, \begin{pmatrix} g_\alpha \\ g_\beta \\ g_z \end{pmatrix} = [T_{33}]^{-1} \begin{pmatrix} g_1 \\ g_2 \\ g_3 \end{pmatrix}, g = \{v, i, e\} \quad [5.29]$$

The expression of the vectors of the new basis is given as a function of the vectors of the natural basis by:

$$\begin{cases} \bar{x}_\alpha = \sqrt{\frac{2}{3}} \left( \bar{x}_1 + \cos \frac{2\pi}{3} \bar{x}_2 + \cos \frac{2\pi}{3} \bar{x}_3 \right) \\ \bar{x}_\beta = \sqrt{\frac{2}{3}} \left( \sin \frac{2\pi}{3} \bar{x}_2 - \sin \frac{2\pi}{3} \bar{x}_3 \right) \\ \bar{x}_z = \sqrt{\frac{1}{3}} (\bar{x}_1 + \bar{x}_2 + \bar{x}_3) \end{cases} \quad [5.30]$$

The vectorial voltage equations associated with the fictitious machines are given by:

$$\begin{cases} \bar{v}_{\alpha\beta} = R_s \bar{i}_{\alpha\beta} + \Lambda_{\alpha\beta} \left( \frac{d\bar{i}_{\alpha\beta}}{dt} \right)_{/B^n} + \bar{e}_{\alpha\beta} \\ \bar{v}_z = R_s \bar{i}_z + \Lambda_z \left( \frac{d\bar{i}_z}{dt} \right)_{/B^n} + \bar{e}_z \end{cases} \quad [5.31]$$

Finally, their characteristic variables are given by:

$$\begin{bmatrix} L_s^d \end{bmatrix} = \begin{bmatrix} \Lambda_{\alpha\beta} = \frac{3}{2}L + l_{leaks} & 0 & 0 \\ 0 & \Lambda_{\alpha\beta} & 0 \\ 0 & 0 & \Lambda_z = l_{leaks} \end{bmatrix} \quad [5.32]$$

and:

$$\begin{cases} \vec{e}_{\alpha\beta} = \sqrt{\frac{3}{2}} \varepsilon_{\max} \Omega (\sin(p\theta) \vec{x}_\alpha - \cos(p\theta) \vec{x}_\beta) \\ \vec{e}_z = 0 \vec{x}_z \end{cases} \quad [5.33]$$

Analysis of the characteristic variables of fictitious machines gives us information about their specificities. Only the principal fictitious machine can generate a torque, its emf being sinusoidal and non-zero. Its electrical time constant,  $\left(\frac{3}{2}L + l_{leakage}\right) / R_s$ , allows us to determine the chopping frequency of the associated inverter. The homopolar fictitious machine does not possess an emf and thus cannot generate a torque. Its supply can only generate losses. If it possessed a non-zero emf linked to the presence of harmonics of rank 3, it could admittedly generate a torque of non-zero mean value [GRE 94], but due to its monophasic feature it would have a significant pulsating component that would have to be compensated for by the two-phase machine. Finally, its electrical time constant, which would have a small value,  $l_{leaks} / R_s$ , that would demand supply from an inverter with a very high chopping frequency.

These conclusions bring an additional argument for a quasi-systematic coupling of three-phase machines. Such coupling will ensure the non-supply of the homopolar machine. The main economical argument is that we use three legs instead of six.

#### 5.2.1.4.1. Five-phase machine

In this section, we illustrate the notions previously introduced, by means of a five-phase synchronous machine with surface-mounted permanent magnets at the surface and concentrated coils with a diametral pitch. Figure 5.3 shows the machine before assembly and a diagram of a cut.

We associate a five-dimensional vectorial space equipped with a natural orthonormal basis  $B^n = \{\vec{x}_1^n, \vec{x}_2^n, \vec{x}_3^n, \vec{x}_4^n, \vec{x}_5^n\}$  with the machine. The vectorial voltage

equation of this machine is given by [5.4], where the inductance matrix, characteristic of linear application  $\lambda$ , and the emf vectors are detailed by equations [5.34] and [5.35]. We will note that  $L$  corresponds to the self-inductance of a phase,  $M_1$  to the mutual inductance between two phases dephased by  $2\pi/5$ , and  $M_2$  to the mutual inductance between two phases dephased by  $4\pi/5$ .

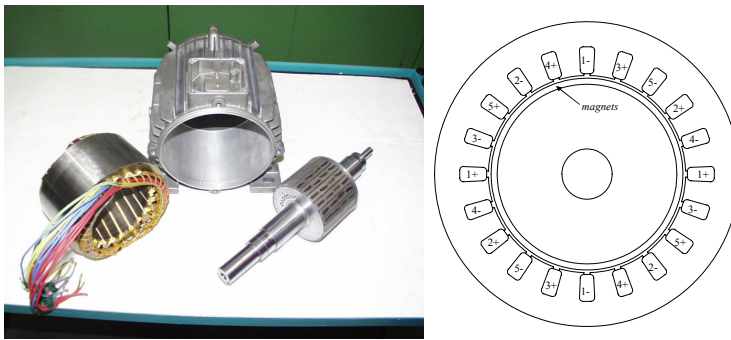


Figure 5.3. Views of the disassembled machine and of a cut

Finally, Table 5.2 gives the relative harmonic content of the emf of the five-phase machine considered.

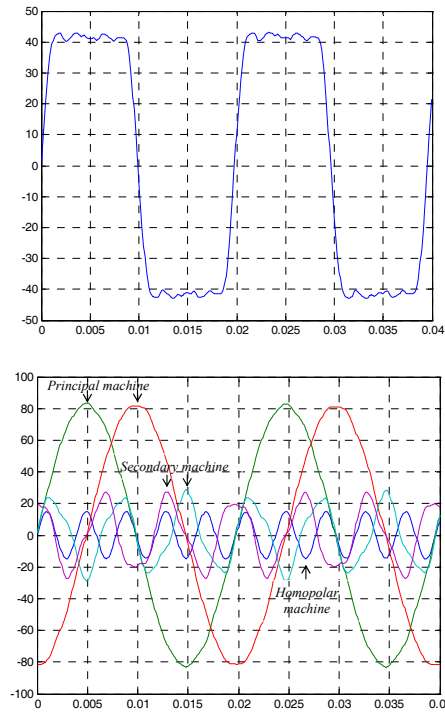
$$[L_s^n] = \begin{pmatrix} L & M_1 & M_2 & M_2 & M_1 \\ M_1 & L & M_1 & M_2 & M_2 \\ M_2 & M_1 & L & M_1 & M_2 \\ M_2 & M_2 & M_1 & L & M_1 \\ M_1 & M_2 & M_2 & M_1 & L \end{pmatrix} \quad [5.34]$$

$$\vec{e} = \Omega \cdot \sum_{k=1}^n \left( \sum_{h=1}^{\infty} \epsilon_{\max}^h \sin \left( h \left( p\theta - (k-1) \frac{2\pi}{n} \right) \right) \vec{x}_k^n \right) \quad [5.35]$$

Harmonics	$h = 1$	$h = 3$	$h = 5$	$h = 7$	$h = 9$
Relative rate	100%	28.5%	12.4%	5.1%	1.7%

Table 5.2. Relative harmonics content of the emf of the five-phase machine considered

By applying the Concordia transformation of the fifth dimension to the five-phase machine, we show that the real machine is equivalent to the association of three fictitious machines: a two-phase fictitious machine referred to as the “principal”, a two-phase fictitious machine referred to as “secondary” and a monophasic fictitious machine referred to as “homopolar”. Each of these fictitious machines is characterized by a harmonic group of variables associated with the real machine. We will find these groups with the help of Table 5.1.



**Figure 5.4.** The emf of the real machine (top) and of fictitious machines (bottom) at 1,500 rpm

We are initially interested in the partition property of emf harmonics among fictitious machines. Figure 5.4 shows a recording of one of the emfs of the real machine and emfs of the associated fictitious machines at 1,500 rpm. We check that the emf of fictitious machines are mainly composed of:

- fundamental and harmonic of rank 9 for the principal machine,
- harmonics of ranks 3 and 7 for the secondary machine; and
- harmonic of rank 5 for the homopolar machine.

We then conclude that each of these machines can supply a torque. Obviously, for a given amplitude of current in the fictitious machines, the torque generated is greater for the principal machine than for the secondary and homopolar machine.

We are now interested in the inductances associated with the fictitious machines. Equation [5.36] gives the inductance matrix  $[L_s^d]$  of the machine in the decoupling basis.  $\Lambda_p$ ,  $\Lambda_s$  and  $\Lambda_z$  represent the inductances associated with the principal, secondary and homopolar machines, respectively.

$$[L_s^d] = \begin{pmatrix} \Lambda_p & 0 & 0 & 0 & 0 \\ 0 & \Lambda_p & 0 & 0 & 0 \\ 0 & 0 & \Lambda_s & 0 & 0 \\ 0 & 0 & 0 & \Lambda_s & 0 \\ 0 & 0 & 0 & 0 & \Lambda_z \end{pmatrix} \quad [5.36]$$

If we only consider the fundamental component of the magnetomotive force, the inductances associated with the fictitious machines, whose calculations come from equation [5.23], are:

$$\begin{cases} \Lambda_p = 2.59mH \\ \Lambda_s = 0.348mH \\ \Lambda_z = 0.348mH \end{cases} \quad [5.37]$$

If we now take into account harmonics 1, 3 and 5 of the stator magnetomotive force, the inductances, stemming from the calculations from equations [5.24] and [5.25] become:

$$\begin{cases} \Lambda_p = 2.59mH \\ \Lambda_s = 0.597mH \\ \Lambda_z = 0.438mH \end{cases} \quad [5.38]$$

As shown in section 5.1.4.3, the hypothesis that only considers the fundamental component of the magnetomotive force leads to large errors in the

evaluation of inductances associated with the secondary and homopolar fictitious machines. When dimensioning the chopping frequency of the inverter, these errors lead to unnecessary oversizing of the machine's supply system, in particular the apparent power of the inverter. We will, however, notice that even by considering the harmonics, the ratio between the inductance of the principal machine and that of the secondary machine,  $\Lambda_p / \Lambda_s = 4.3$ , is still high in the case of this five-phase machine.

From another point of view, if we imagine that the machine had been designed to have low magnetic leakages and a single harmonic of magnetomotive force (and thus emf), the determination of the frequency of the PWM from the single time constant of the principal machine would lead to the observation of parasitic currents of very high amplitude in practice.

Finally, as long as the inductance linked to the homopolar machine is the smallest, the star coupling will ensure that there is no current, at least in the homopolar machine. It only remains to control the currents in the secondary machine.

### 5.2.2. *The inverter seen from the machine*

For the model of an  $n$ -leg inverter, this section will take up, the main results of Chapter 8 [KES 09a].

Let us remind ourselves that the function of the inverter is to apply the voltages calculated by the control to the electrical machine. More precisely, knowing that we are positioned within the framework of a PWM control, we will try to apply voltages whose mean values correspond to those calculated by the control. The real voltages will in fact consist of a "rolling mean" component and a "noise" component that will be filtered by the inductive circuit of the machine. We will then obtain the mean currents desired, which cause the mean electromagnetic torque developed by the machine.

According to the control strategies close to the inverter, noise voltages can be significantly different, even if the mean value of the voltage is the same. These noise voltages will induce parasitic currents whose amplitudes will be added to the "effective" mean current. When the amplitude of these noise currents becomes important, these currents become dimensioning for the choice of inverter transistor rating. For machines with more than three phases, it has been seen in section 5.2.1.4 that, contrary to the star-coupled three-phase machine without a neutral point, there are several inductive circuits (one per fictitious machine). The analysis of fictitious voltages imposed by the inverter in each fictitious machine, both for its mean

Comment [IRL1]: Ok ?

component and its “noise” component, is therefore fundamental in controlling the mean currents and the parasitic currents of the real machine.

At this level, two cases have to be distinguished, which have already been seen for the three-phase machine. In other words, depending on the way the phases of the machine are coupled, a fictitious machine can be dependent or not dependent on the inverter. For this reason we will show the case of the three-leg inverter using an approach that is easy to generalize to the case of a  $n$ -leg inverter supplying a  $n$ -phase machine.

5.2.2.1. *Three-leg inverter seen from the star-coupled three-phase machine*

Here we consider a three-phase machine assumed to be star-coupled and to fulfill the general hypotheses expressed at the beginning of this chapter, and particularly the hypothesis in section 2.1.4.1 (magnetomotive and sinusoidal emfs).

In order to emphasize the problem of parasitic currents, we will assume that the neutral  $N'$  of the machine is physically linked to neutral point  $N$  of the inverter by an impedance of capacitor type. If we consider the capacitance to be 0, we will again find the ideal case and point  $N$  will not exist in reality. The capacitance will allow us to roughly model the impedance of the machine’s earthing circuits and the inverter. We use this type of modeling when we are interested, for instance, in parasitic currents going through the bearings of a machine [DAH 08] where one of the origins is linked to the homopolar components of voltages imposed by the inverter [LEE 01].

Figure 5.5 shows the classical supply topology of the three-phase machine: star-coupled phases and supplied with a three-leg inverter.

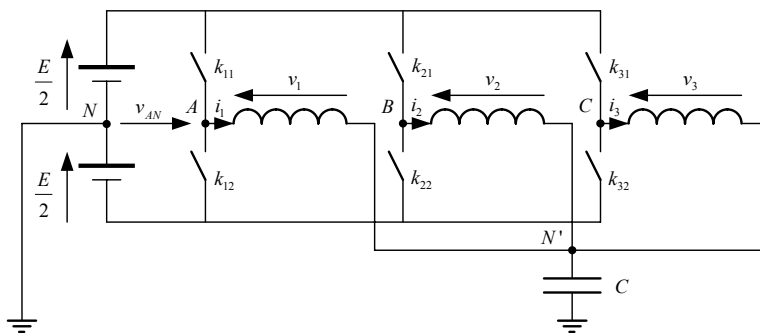


Figure 5.5. *Star-coupled three-phase machine supplied with a three-leg inverter*



The eight possible combinations of switches  $k_{ij}$  allow us to generate the eight inverter voltage vectors,  $\bar{v}_k^{ond} = v_{AN}\bar{x}_1^n + v_{BN}\bar{x}_2^n + v_{CN}\bar{x}_3^n$ :

$$\begin{aligned}
\bar{v}_{N0} &= -\frac{E}{2}\bar{x}_1^n - \frac{E}{2}\bar{x}_2^n - \frac{E}{2}\bar{x}_3^n & \bar{v}_{N1} &= -\frac{E}{2}\bar{x}_1^n - \frac{E}{2}\bar{x}_2^n + \frac{E}{2}\bar{x}_3^n \\
\bar{v}_{N2} &= -\frac{E}{2}\bar{x}_1^n + \frac{E}{2}\bar{x}_2^n + \frac{E}{2}\bar{x}_3^n & \bar{v}_{N3} &= -\frac{E}{2}\bar{x}_1^n + \frac{E}{2}\bar{x}_2^n - \frac{E}{2}\bar{x}_3^n \\
\bar{v}_{N4} &= +\frac{E}{2}\bar{x}_1^n - \frac{E}{2}\bar{x}_2^n - \frac{E}{2}\bar{x}_3^n & \bar{v}_{N5} &= +\frac{E}{2}\bar{x}_1^n - \frac{E}{2}\bar{x}_2^n + \frac{E}{2}\bar{x}_3^n \\
\bar{v}_{N6} &= +\frac{E}{2}\bar{x}_1^n + \frac{E}{2}\bar{x}_2^n - \frac{E}{2}\bar{x}_3^n & \bar{v}_{N7} &= +\frac{E}{2}\bar{x}_1^n + \frac{E}{2}\bar{x}_2^n + \frac{E}{2}\bar{x}_3^n
\end{aligned} \tag{5.39}$$

Any one of these eight vectors can be broken down by applying the Concordia transformation in a unique sum of a voltage vector belonging to a principal vectorial subspace and another homopolar vectorial subspace:

$$\bar{v}_{Nk} = \bar{v}_{Nk}^{\alpha\beta} + \bar{v}_{Nk}^z = (v_{N\alpha}\bar{x}_\alpha + v_{N\beta}\bar{x}_\beta) + (v_{Nz}\bar{x}_z) \tag{5.40}$$

The detail of these vectors is given by:

$$\begin{aligned}
\bar{v}_{N0}^{\alpha\beta} &= 0.\bar{x}_\alpha + 0.\bar{x}_\beta & \bar{v}_{N1}^{\alpha\beta} &= -\frac{E}{\sqrt{6}}.\bar{x}_\alpha - \frac{E}{\sqrt{2}}.\bar{x}_\beta \\
\bar{v}_{N2}^{\alpha\beta} &= -\frac{E}{\sqrt{6}}.\bar{x}_\alpha + \frac{E}{\sqrt{2}}.\bar{x}_\beta & \bar{v}_{N3}^{\alpha\beta} &= -\frac{2E}{\sqrt{6}}.\bar{x}_\alpha + 0.\bar{x}_\beta \\
\bar{v}_{N4}^{\alpha\beta} &= +\frac{2E}{\sqrt{6}}.\bar{x}_\alpha + 0.\bar{x}_\beta & \bar{v}_{N5}^{\alpha\beta} &= +\frac{E}{\sqrt{6}}.\bar{x}_\alpha - \frac{E}{\sqrt{2}}.\bar{x}_\beta \\
\bar{v}_{N6}^{\alpha\beta} &= +\frac{E}{\sqrt{6}}.\bar{x}_\alpha + \frac{E}{\sqrt{2}}.\bar{x}_\beta & \bar{v}_{N7}^{\alpha\beta} &= 0.\bar{x}_\alpha + 0.\bar{x}_\beta
\end{aligned} \tag{5.41}$$

and:

$$\begin{aligned}
\bar{v}_{N0}^z &= -\frac{\sqrt{3}E}{2}.\bar{x}_z & \bar{v}_{N1}^z &= -\frac{E}{\sqrt{6}}.\bar{x}_z \\
\bar{v}_{N2}^z &= -\frac{E}{\sqrt{6}}.\bar{x}_z & \bar{v}_{N3}^z &= +\frac{E}{\sqrt{6}}.\bar{x}_z \\
\bar{v}_{N4}^z &= -\frac{E}{\sqrt{6}}.\bar{x}_z & \bar{v}_{N5}^z &= +\frac{E}{\sqrt{6}}.\bar{x}_z \\
\bar{v}_{N6}^z &= +\frac{E}{\sqrt{6}}.\bar{x}_z & \bar{v}_{N7}^z &= +\frac{\sqrt{3}E}{2}.\bar{x}_z
\end{aligned} \tag{5.42}$$

Voltages  $\vec{v}_{\alpha\beta}$  and  $v_z$  applied to the principal and secondary fictitious machines are respectively expressed by:

$$\vec{v}_{\alpha\beta} = R_s \vec{i}_{\alpha\beta} + \Lambda_{\alpha\beta} \frac{d\vec{i}_{\alpha\beta}}{dt} = \vec{v}_{N\alpha\beta} \quad [5.43]$$

$$v_z = R_s i_z + \Lambda_z \frac{di_z}{dt} = v_{Nz} - \frac{V_{N'N}}{\sqrt{3}} \quad [5.44]$$

The capacitor being run through by a current equal to the sum of currents in the phases of the machine, we have:

$$V_{N'N} = \int \frac{\sqrt{3}i_z}{C} dt \quad [5.45]$$

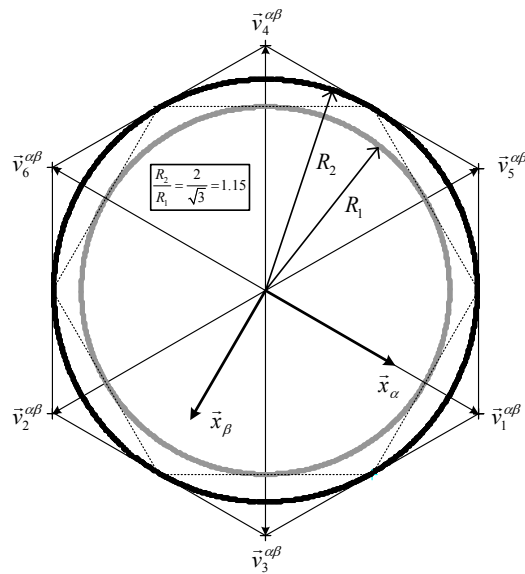
An ideal star coupling (zero capacitance,  $C$ ) implies a current  $i_z = \frac{i_1 + i_2 + i_3}{\sqrt{3}} = 0$  and hence a voltage applied to the homopolar machine of  $v_z = 0$ , whichever voltage  $v_{Nz}$  is imposed by the inverter. The homopolar machine is therefore *never* supplied when the real machine is star coupled and supplied by a three-leg inverter without a neutral point.

When capacitance  $C$  is not null, a non-zero current  $i_z$  circulates if voltage  $v_{Nz}$  is not zero. This is always the case when we consider the eight vectors  $\vec{v}_{Nk}^z$  that can be imposed by the three-leg inverter. We will understand why some inverter control strategies aim to choose those voltage vectors presenting the weakest homopolar components (excluding inverter voltage vectors  $\vec{v}_{N0}$  and  $\vec{v}_{N7}$ ) from among the eight voltage vectors [LEE 01].

REMARK 5.1.- these results still remain true if the emfs and magnetomotive forces have harmonics of rank 3 because this modifies the homopolar components of emf as well as the homopolar inductance. Only the homopolar current will be modified if the capacitance is non-zero.

REMARK 5.2.- if we consider a triangle coupling, the impact of an emf harmonic of rank 3 is fundamental. In fact, in the case of triangle coupling it is the homopolar voltage  $v_z$  of the machine that we make 0. Current  $i_z$  is only 0 when the emf  $e_z$  is also 0.

By considering the ideal case of the star-coupling with no capacitance and the homopolar machine not being supplied, the real machine supplied by a real inverter is strictly equivalent to the principal fictitious machine supplied by a fictitious inverter. Instead of studying the supply of the real machine using one of the eight real vectors  $\vec{v}_{Nk}$  given by [5.39], we prefer to study the supply of the fictitious machine by one of the eight principal vectors,  $\vec{v}_k^{\alpha\beta} = \vec{v}_{Nk}^{\alpha\beta}$ , obtained by projection of the real vectors into the subspace associated with the principal machine (see equation [5.41]). These two-dimensional vectors are classically represented in a plane and form the centered hexagon given in Figure 5.6. Vectors  $\vec{v}_0^{\alpha\beta}$  and  $\vec{v}_7^{\alpha\beta}$  appear in this figure only via the central point of the hexagon because they possess no projection in the principal plane.



**Figure 5.6.** The two-dimensional representation of voltage vectors supplying the principal machine

In Figure 5.6 the grey circle of radius  $R_1$  gives the limit of mean voltage vector  $\langle \vec{v}_{\alpha\beta} \rangle(t)$  that can be imposed if we generate three mean sinusoidal voltages of reference at the level of the inverter (voltages  $v_{AN}$ ,  $v_{BN}$  and  $v_{CN}$  in Figure 5.5). In this

case, by control we ensure that the mean value on a PWM period of the homopolar voltage of the inverter is 0:

$$\langle v_{Nz} \rangle(t) = \frac{1}{T_{MLI}} \int_{t_{MLI}} v_{Nz} dt = 0 \quad [5.46]$$

We then have a mean value of:  $\langle v_{N'N} \rangle(t) = 0$ .

The black concentric circle, of radius  $R_2 > R_1$ , indicates the limit of the mean voltage vector if we inject a homopolar component (often a harmonic of rank 3) in the reference voltages of the inverter. We are thus reminded that this overmodulation allows us to use at best, from the point of view of the DC voltage of the bus, the degree of freedom left by the star coupling (unsupplied homopolar with a harmonic multiple of 3 present in the inverter voltages).

In summary, the star coupling without a neutral point allows us to ensure that a fictitious machine will have 0 current and frees a degree of freedom for control, allowing us to better use the DC voltage of the bus (+15.5% of excursion).

The reader who would like to deepen his or her knowledge of the elements relative to the vectorial modeling of inverters is invited to read Chapter 8 “Multiphase voltage source inverters” of [MON 11].

#### 5.2.2.2. Generalization to *n*-leg inverters: fictitious two-phase inverters. Example of machine-five-leg inverter association

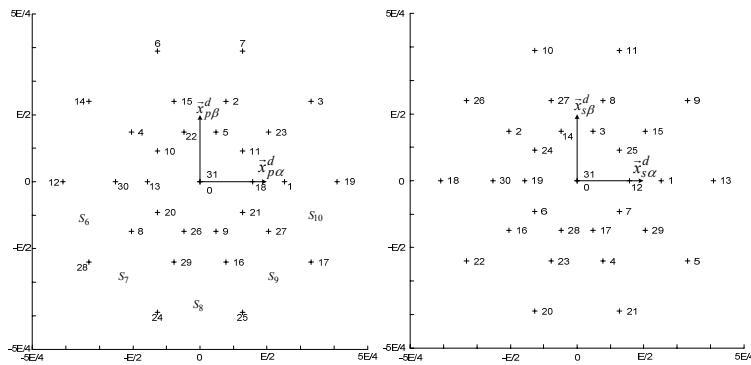
The study of machines with more than three phases, supplied with inverters with a number of legs equal to the number of phases follows the same approach as that used in section 5.2.2.1.

The star coupling without a neutral point always allows the current in the homopolar fictitious machine to be 0 and frees a degree of freedom for control. In Table 5.3 [LEV 08], we will find that the benefit introduced by the homopolar weakens as the number of phases increases. We could conclude that an increase in the number of phases is unfavorable for good use of the DC bus. We do, however, need to note that the calculations leading to Table 5.3 assume the machine is supplied in sinusoidal regime with an injection of homopolar voltage. In the “fictitious machine” approach, this means that we assume that we are only supplying a single fictitious machine. If this approach is enough in three-phase it is no longer the case if the number of phases  $n$  is greater than three because the optimal use of the DC bus depends on all the fictitious machines being supplied. This in [RYU 05], we find a modulation rate of 1.23 in the case of a five-phase machine that has been properly designed and whose two fictitious machines are supplied.

Number of phases $n$	Level of harmonics injection $n$	Index of maximum modulation $M_i$	Percentage of increase in the fundamental component
3	-1/6 of the fundamental	1.155	15.5
5	-0.062 of the fundamental	1.052	5.2
7	-0.032 of the fundamental	1.026	2.6
9	-0.02 of the fundamental	1.015	1.5

**Table 5.3.** Benefit introduced in the modulation index in the case of homopolar injection

If we omit this aspect of homopolar injection, which only intervenes in the cases where we work at the limits of the voltage possibilities of the inverter, supplying a multiphase machine has as a sole difference with respect to the three-phase case. It has to consider several projections of the  $2^n$  characteristic vectors of the inverter (instead of  $2^3$ ) in several planes instead of a single plane. Thus, for a five-leg inverter we will find two planes with 30 non-zero vectors ( $2^5 - 2$ ), see Figure 5.7.



**Figure 5.7.** Graphical representation of a five-phase inverter in the principal (left) and secondary (right) subspaces

At the level of the inverter control, the different steps for the determination of duty cycles will be the following:

- a) obtaining the voltage vectors for each fictitious machine (in three-phase we has only a single vector) as a function of torques required for each fictitious machine;
- b) vectorial summation of the different voltage vectors of these machines;
- c) possible addition of a homopolar voltage vector in order to optimize the use of the bus voltage;
- d) calculation of the conduction durations by assuming we are in linear regime (non-saturation of the inverter) according to the expressions given in [KES 09a];
- e) taking into account, if necessary, the saturation of the inverter by generating adapted references.

The analysis of the different steps emphasizes the fact that we apply a superposition theorem as long as there is no saturation of the inverter. This means that everything is as if each fictitious machine was supplied with a fictitious inverter. Thus, as long as we are not interested in the nonlinear aspects of the inverter control, we can use very classic intersective control techniques that implicitly fulfill step d, knowing that step c is less important as the number of phases increases.

### 5.3. Torque control of multiphase machines

Efficient position and speed servo-controls require a torque servo-control, i.e. stator currents. If several sets of  $n$  stator currents can generate the same torque, we will try and use the degrees of freedom given by the redundancy of phases to fulfill some criteria. Among the most frequently used is the criterion that minimizes Joule losses for a given torque. This will be used in the following sections.

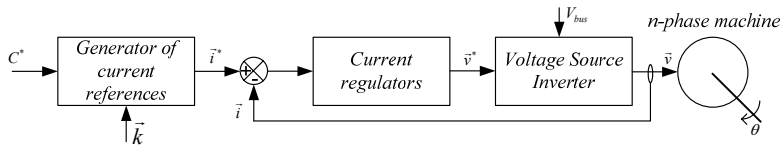
#### 5.3.1. Servo-control of currents in the natural basis

##### 5.3.1.1. Statement of the method

We speak of servo-control of currents in the natural basis when the servo-controlled currents are the real currents measured in the machine. Figure 5.8 gives the synoptic diagram of the torque control of a multiphase machine in natural basis. We will recognize :

- $c^*$  : the reference torque;
- $\vec{k}$  : the criterion used to elaborate the reference currents;

- $\vec{i}^*$  and  $\vec{i}$  : the current references and the measured currents;
- $\vec{v}^*$  and  $\vec{v}$  : the voltage references and the voltages applied to the machine; and finally
- $V_{bus}$ : the voltage of the DC bus supplying the inverter.



**Figure 5.8.** Synoptic diagram of the torque control of a multiphase machine in the natural basis

The first operation consists of elaborating the current references. Since we need to elaborate a vector (reference current vector) from a scalar (reference torque), it is necessary to introduce a criterion, and therefore a vectorial. Equation [5.47] clarifies the generation of current references from a reference torque:

$$\vec{i}^* = \vec{k} c^* \quad [5.47]$$

We can, for instance, choose to work with a maximum torque for given statoric Joule losses. Given that these Joule losses are proportional to the square of the modulus of the current vector, this criterion is easily translated from equation [5.9] by the fact that the current vector has to be colinear to the emf vector. For a given current vector modulus, we then obtain the maximum torque. It therefore becomes:

$$\vec{i}^* = a \vec{e}, a \in \mathfrak{R} \quad [5.48]$$

By reinjecting [5.48] in [5.9], we get  $c^* = a \|\vec{e}\|^2$ , from where we get:

$$\vec{i}^* = \frac{c^*}{\|\vec{e}\|^2} \vec{e} \Rightarrow \vec{k} = \frac{\vec{e}}{\|\vec{e}\|^2} \quad [5.49]$$

Equation [5.49] leads to several remarks:

- Vectors  $\vec{i}$  and  $\vec{e}$  being colinear, the generated torque induces minimum global Joule losses. If there are effectively several strategies available, generating a given

torque with minimum Joule losses allows optimal use (by neglecting the ion losses) from a thermal point of view of the machine.

– If the emfs only have harmonics of rank that are smaller than the number of phases  $n$  of the machine, term  $\|\vec{e}\|^2$  is constant and the currents possess the same harmonic ranks as the emfs. If we take the classic case of a machine with sinusoidal emf, we again find sinusoidal currents in phase with the emf.

– If the emfs possess a number of harmonics greater than the number of phases,  $n$ , term  $\|\vec{e}\|^2$  is no longer constant and the currents possess a number of harmonics greater than the emfs. Finally, if it's possible that term  $\|\vec{e}\|^2$  cancels out for a particular position  $\theta$  of the rotor, there is no combination of currents that allows us to maintain a constant torque.

None the cases shown previously have constant currents in steady-state regime and their servo-control usually requires the use of correctors with large bandwidth (often with hysteresis). This is prohibited in the domain of high power because of the rich and poorly controlled spectral content. Let us note, however, that if the harmonic content of current is finite, the use of multifrequential resonating controllers can allow the perfect tracking of references in steady state [LIM 09].

#### 5.3.1.2. Example: five-phase machine with trapezoidal emf

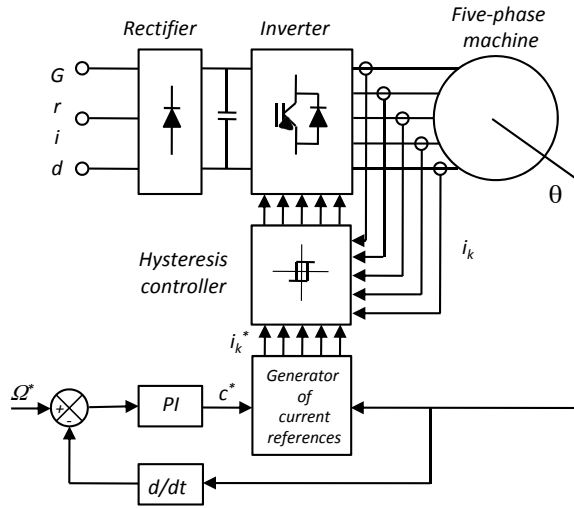
Here we show the results of controlling currents in the natural basis of the five-phase machine that were presented in section 5.2.1.4.1 for a machine that is star coupled and supplied with a five-leg inverter [KES 09b]. Figure 5.9 is a synoptic diagram of the experimental system put in place for these trials.

Torque reference  $c^*$  comes from the proportional integral (PI) controller ensuring the servo-control of speed  $\Omega$ . This speed is estimated by filtered numerical differentiation from the position measured by a synchro-resolver. The “optimal” current references are calculated from equation [5.49], the emf (i.e. vector  $\vec{e}$ ) being estimated in real time from mechanical angle  $\theta$ .

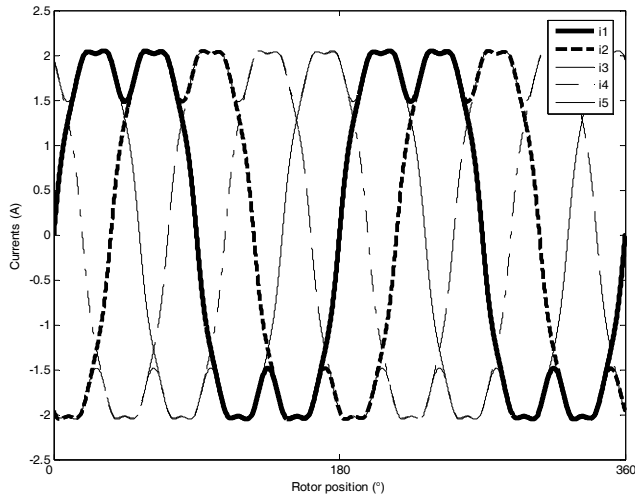
The set is controlled by real-time set DSpace® 1005. The mechanical load is generated by a powder brake. The effective torque is measured by a torquemeter placed between the motor and the load.

Figure 5.10 shows the current references obtained for a control speed of 20 rad/s and a resistant torque of 2 N.m.



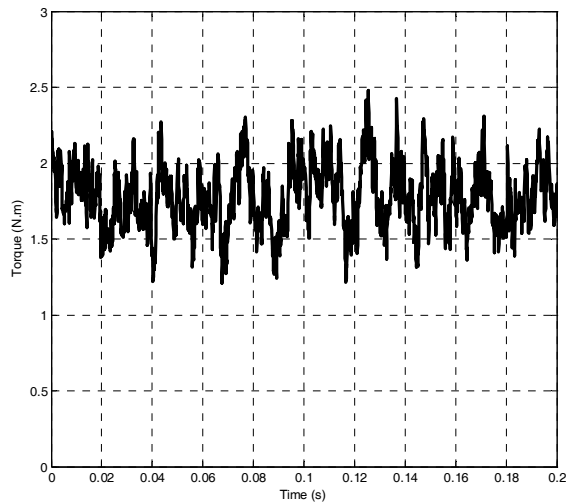


**Figure 5.9.** Synoptic diagram of the experimental system of control of currents in the natural basis of a five-phase machine



**Figure 5.10.** "Optimal" current references of a five-phase machine with trapezoidal emf

The currents, which are servo-controlled by hysteresis controllers, allow us to obtain a constant torque with minimal Joule losses, as shown in Figure 5.11. The amplitude of torque oscillations results from the bandwidth of the hysteresis corrector, which is itself linked to the maximum authorized chopping frequency.



**Figure 5.11.** *Experimental torque of a five-phase machine obtained by servo-control of currents in the natural basis*

### 5.3.2. Servo-control of currents in a decoupling basis

#### 5.3.2.1. Statement of the method

If we apply the decoupling transformation in section 5.2.1 to the characteristic equations of an  $n$ -phase machine, we are no longer studying the control of the real machine but a sum of  $N$  fictitious one- or two-phase machines. Figure 5.12 gives a synoptic diagram of the torque control of the machine in a decoupling basis. The variables carry indices  $d$  to indicate that it is about a decoupled variable and  $l$  to  $N$  to indicate the number of the fictitious machine of interest.

The torques reference distribution can be done in several ways according to the field of application. Either we use the principal machine (in which the fundamental component of the emf is projected) in normal running and the other fictitious machines are only used transiently in “transient overtorque” mode; or we make

demands on all the fictitious machines. In this last mode, we can again take the case of control with minimum global Joule losses. By projecting the reference current vector expressed by [5.49] in each eigenspace associated with a fictitious machine, we obtain the reference current for each fictitious machine:

$$\vec{i}_d^* = c^* \frac{\vec{\mathcal{E}}_d}{\|\vec{\mathcal{E}}\|^2} \quad [5.50]$$

$$c_d^* = \vec{\mathcal{E}}_d \cdot \vec{i}_d^* = c^* \frac{\|\vec{\mathcal{E}}_d\|^2}{\|\vec{\mathcal{E}}\|^2} \quad [5.51]$$

According to the harmonic content of the real machine, the reference torque imposed on each of the fictitious machines can vary, although that of the real machine is constant. In the latter case, other strategies will be devised.

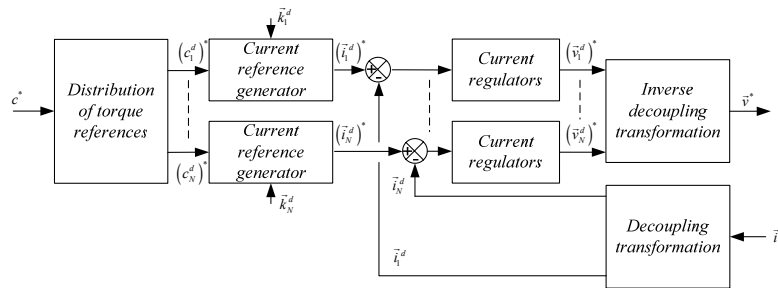


Figure 5.12. Synoptic diagram of the torque control of a five-phase machine in a decoupling basis

5.3.2.1. Case of machines whose fictitious machines have sinusoidal emf

In the case where each fictitious two-phase machine possesses sinusoidal emf, according to equation [5.51] and the remarks expressed in section 5.3.1.1, variables  $\|\vec{\mathcal{E}}_d\|^2$  and  $\|\vec{\mathcal{E}}\|^2$  are constant. The strategy that minimizes the global Joule losses for a given torque leads us to impose constant torque references in each fictitious machine if the torque reference imposed to the real machine is constant. We then end up controlling each two-phase fictitious machine as we would control the equivalent two-phase machine in the case of a star-coupled three-phase machine (where control is referred to as in the Park basis).

Each fictitious machine is assumed to possess an emf of the type:

$$\bar{e}_{\alpha\beta\_m} = \sqrt{\frac{n}{2}} \Omega \mathcal{E}_{\max\_m} (\sin(h_m p \theta) \bar{x}_{\alpha\_m} - \sigma \cos(h_m p \theta) \bar{x}_{\beta\_m}) \quad [5.52]$$

Here,  $h_m$  corresponds to the emf harmonics of the real machine, which is projected in fictitious machine number  $m$ . This harmonic, assumed to be unique, generally corresponds to the first odd harmonics of each machine (see Table 5.1). We are reminded that  $\sigma$  allows us to take into account whether the vector rotates in the direct ( $\sigma = +1$ ) or the retrograde direction ( $\sigma = -1$ ).

If in each fictitious machine we have a new basis change, obtained by rotation of the basis  $(\alpha\beta)$  as expressed by:

$$\begin{pmatrix} \bar{x}_{d\_m} \\ \bar{x}_{q\_m} \end{pmatrix} = \begin{pmatrix} \cos(h_m p \theta) & \sigma \sin(h_m p \theta) \\ -\sigma \sin(h_m p \theta) & \cos(h_m p \theta) \end{pmatrix} \begin{pmatrix} \bar{x}_{\alpha\_m} \\ \bar{x}_{\beta\_m} \end{pmatrix} \quad [5.53]$$

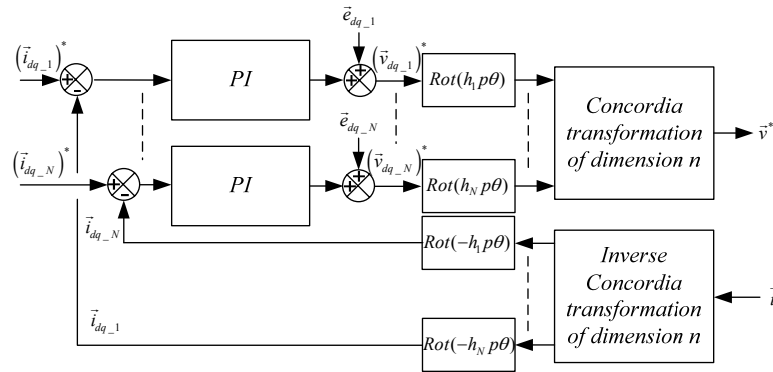
We obtain emf, referred to as axes  $(dq)$ :

$$\bar{e}_{dq\_i} = \sqrt{\frac{n}{2}} \mathcal{E}_{\max\_i} \Omega (0 \cdot \bar{x}_{d\_i} - \sigma \bar{x}_{q\_i}) \quad [5.54]$$

Insofar as some harmonics generate vectors rotating in the direct direction and others in the retrograde direction, the rotation can be in one direction or in the other.

The emfs of axes  $(dq)$ , which are constant in steady-state regime, lead to “optimal” current references such as  $i_{d\_i}^* = 0$  and  $i_{q\_i}^* = k \cdot c_d^*$ . These justify the use of current PI-type controllers and a control strategy in PWM with constant frequency of the inverter. The parameters of current controllers can be determined using classic methods (compensation of dominant compensation pole method, symmetrical optimum method, etc.) insofar as the fictitious machines are modeled by a first-order circuit made of the resistance of the stator phase, the inductance and the emf of the fictitious machine considered.

Figure 5.13 shows the synoptic diagram of current control of an  $n$ -phase machine in an extensive Park basis. If we wish to obtain better dynamic performances, we add the emf compensations (constant in a steady-state regime given the hypotheses taken in this section) to the PI controllers ensuring the control of currents.



**Figure 5.13.** Synoptic diagram of the current control of a multiphase machine in the generalized Park basis

5.3.2.2. Case of machines whose fictitious machines are not sinusoidal emf

In the case of non-sinusoidal fictitious machines, there are two alternatives.

The first imposes minimum global Joule losses for a given torque. In this case, the torque references of fictitious machines are not constant when the real machine is constant, and the choice of current correctors then arises. This approach, which has little advantage with respect to control in the natural basis detailed in section 5.3.1, will not be developed further.

The second alternative uses the approach developed in section 5.3.2.1. We then make a basis change in each fictitious machine by rotation of the basis associated with the being machine considered. We chose a rotation angle  $h_m p \theta$  so that the mean value of the emf of axis  $q$  is as high as possible. In this case, imposing constant currents  $dq$  in a steady-state regime does not allow us to generate a constant electromagnetic torque but does however possess a mean value for minimum Joule losses.

Besides generating torque undulations, the emf harmonics of ranks different from  $h_m$  generate harmonic currents that are responsible for additional losses and torque ripples. The solution here lies compensating for these harmonics by injecting them in the reference voltages. The synoptic diagram in Figure 5.13 remains valid, although the terms corresponding to the compensation of emf are not only necessary for obtaining good dynamic performance, but for cancelling out harmonics current that are harmful in steady state.

5.3.2.3. Example: five-phase machine with trapezoidal emf

Here we give the results of current control in the extensive Park basis of the five-phase machine, described in section 5.2.1.4.1, that is star coupled and supplied with a five-leg inverter. Figure 5.14 shows a synoptic diagram of the current control system put in place for these trials.

We are reminded that the five-phase star-coupled machine is equivalent to the association of two two-phase fictitious machines: a principal machine, indexed  $p$ , in which we have harmonics 1 and 9 of the magnetomotive forces and emfs of the real machine; and a secondary machine, indexed  $s$ , in which we mainly find harmonics 3 and 7 of the same variables.

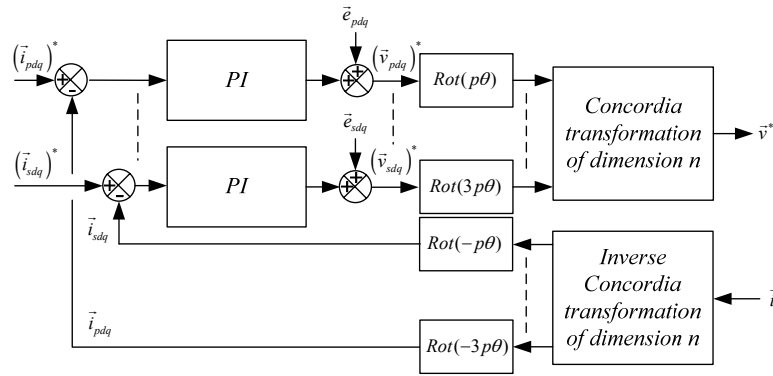


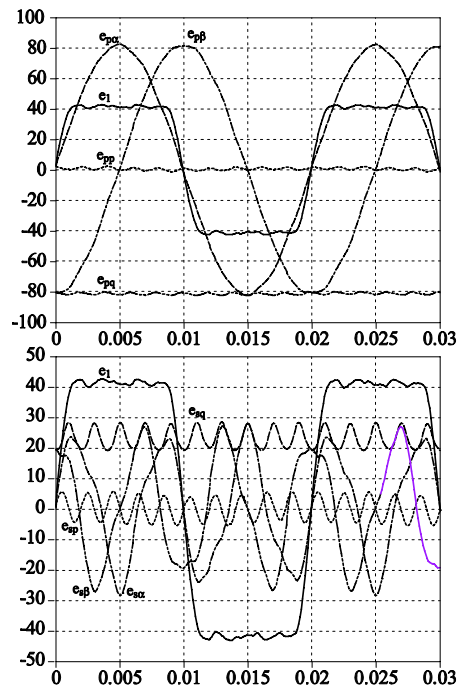
Figure 5.14. Synoptic diagram of the current control of a five-phase machine in generalized Park basis

The emf of fictitious machines indexed  $d$  or  $q$  in the new basis are obtained by rotation of variables of the principal machine of angle  $p\theta$  and variables of the secondary machine of angle  $3p\theta$ , see Figure 5.15. These emfs are not constant because they are not made of a single harmonic, the real machine possessing quasi-trapezoidal emfs. In the emfs of fictitious machines we again find a constant value that is predominantly associated with a harmonic of rank 10, which comes from the rotation of harmonic 9 by  $\theta$  in the principal machine and harmonic 7 by  $3\theta$  in the secondary machine.

For all the trials that have been carried out, the inverter is controlled in interselective PWM centered at a chopping frequency of 5 kHz. This frequency has

been determined from the smallest time constant of the system corresponding to the electrical time constant of the secondary machine,  $f_s = \frac{R_s}{2\pi\Lambda_s} = 114\text{Hz}$ .

The current references are constant and the currents are controlled via PI-type controllers. Inputs, allowing the emf to be compensated, are added to the output of current correctors.



**Figure 5.15.** The emfs of principal and secondary machines before ( $e_{\alpha\beta}$ ) and after rotation ( $e_{dq}$ ) compared to the emf of phase 1 ( $e_1$ )

5.3.2.3.1. Current control without compensation of emfs

In the trials presented in this section, we impose the following current references:

- $i_{pd}^* = 0\text{A}$  and  $i_{pq}^* = -7\text{A}$  for the principal machine;
- $i_{sd}^* = 0$  and  $i_{sq}^* = 0\text{A}$  for the secondary machine.

The emfs are not compensated.

Figure 5.16 shows the current in one phase. We observe a strong harmonic 7 due to the corresponding component of the emf. The PI current controller as it is set is not capable of rejecting this perturbation at the speed considered. This current harmonic is responsible for additional losses as well as torque ripples. We realize these harmonic currents by checking in Figure 5.17 that, although the current references of the secondary machine are set to 0, strong harmonic currents (of rank 10) exist.

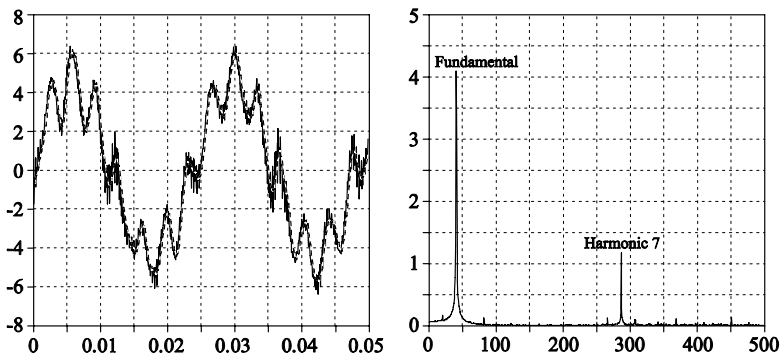


Figure 5.16. Current in a phase and associated frequential spectrum when the emfs are not compensated for

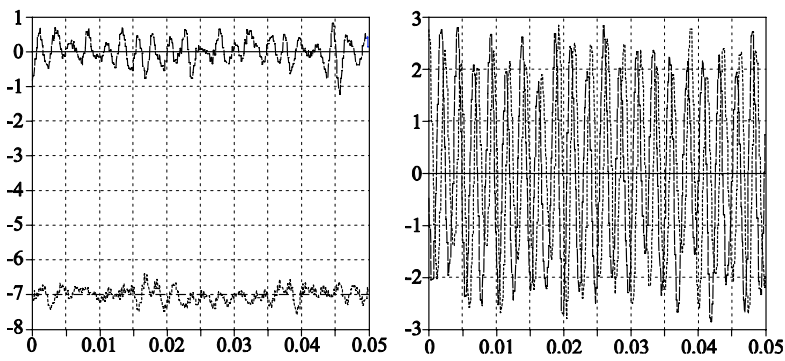


Figure 5.17. The dq currents in the principal and secondary machines when the emfs are not compensated for



5.3.2.3.2. Current control with compensation of emfs

In the trials in Figures 5.18 and 5.19, the only compensation is for emf harmonic 7. The current in a phase is quasi-sinusoidal and the currents in the fictitious machines being properly controlled.

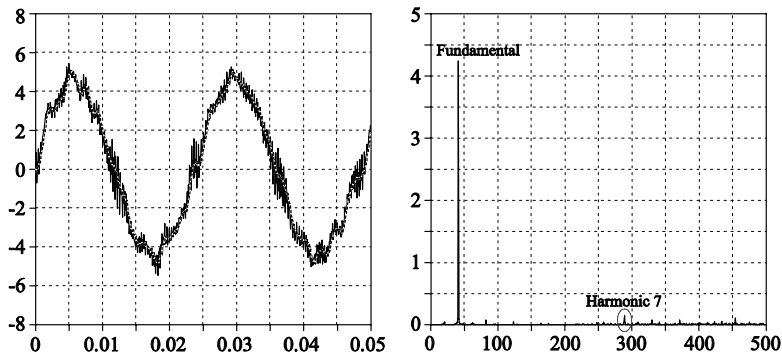


Figure 5.18. Current in a phase and associated frequential spectrum when the emf harmonic 7 is compensated

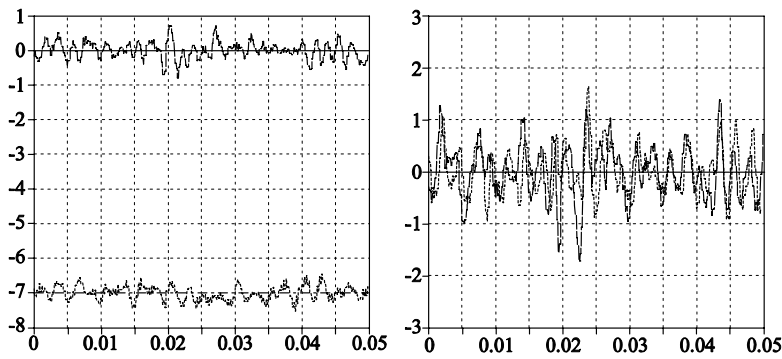
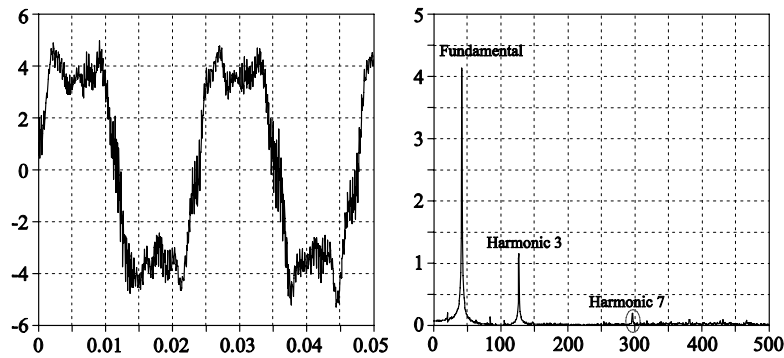


Figure 5.19. The dq currents in the principal and secondary machines when emf harmonic 7 is compensated

The fictitious machines now being considered properly controlled, we decide to generate a torque with each of the machines.

The secondary machine possesses a first emf harmonic (harmonic 3 of the real machine) equal to 30% of the first harmonic of the principal machine. The distribution of torque references in each of the fictitious machines, coming from equation [5.51], then fulfill ratio  $c_s^* = \frac{0.3^2}{1^2} c_p^*$ . Finally, if we assume that the electromagnetic torque generated by the machine is proportional to current of axis  $q$ , the references of currents of axis  $q$  then fulfill the ratio:  $|i_{sq}^*| = 0.3 |i_{pq}^*|$ .

We keep the same current references for the principal machine ( $i_{pd}^* = 0A$  and  $i_{pq}^* = -7A$ ), the references associated with the secondary machine becoming  $i_{sd}^* = 0$  and  $i_{sq}^* = 2.1A$ . Figures 5.20 and 5.21 show the currents in one phase of the real machine and in the associated fictitious machines.



**Figure 5.20.** Current in a phase and associated frequential spectrum when the two fictitious machines generate a torque

The injection of current of harmonic 3 allows an increase in electromagnetic torque of almost 9% (30% of current of rank 3 and 30% of emf of rank 3) which leads to an increase in Joule losses of 9%. An increase of 9% in torque using only the principal machine would require an increase in Joule losses of almost 19% (1.09 times the current of the principal machine).

The use of fictitious machines to generate of the total torque thus allows optimal use of the multiphase machine. Control in the extensive Park basis allows the use of PI controllers associated with an inverter controlled in PWM.

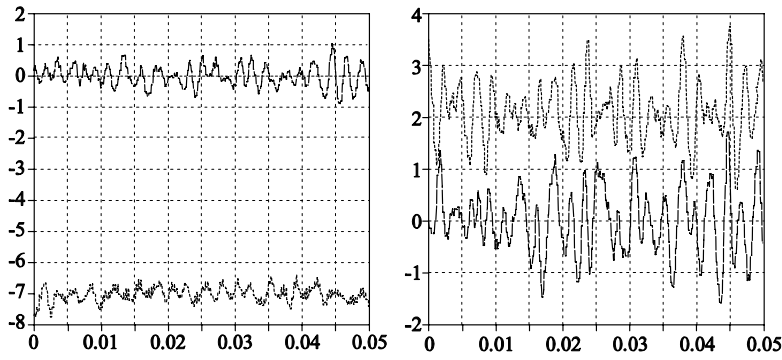


Figure 5.21. The dq currents in the principal and secondary machines when emf harmonic 7 is compensated for

Finally, Figure 5.22 shows the results of the speed control of this machine by using the torque distribution  $c_s^* = 0.3^2 c_p^*$ . The speed references are bursts of plus or minus 10 rad/s.

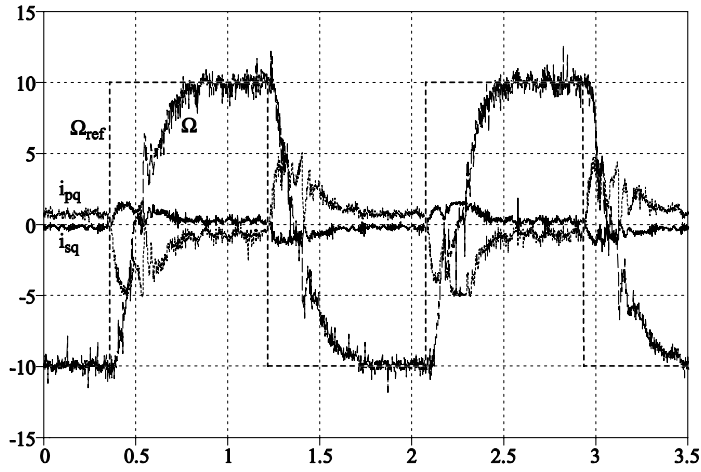


Figure 5.22. The dq currents in the principal and secondary machines and speed response in the case of a servo-controlled system

#### **5.4. Modeling and torque control of multiphase machines in degraded supply mode**

The modeling and torque control of multiphase machines in degraded supply mode is a broad topic that cannot be developed in detail in this chapter. However, the techniques shown previously are, with some modifications, applicable to torque control in degraded supply mode.

##### **5.4.1. Modeling of a machine with a supply defect**

A first method models a machine with  $n$  symmetrical phases whose  $m$  phases would no longer be supplied as a machine with  $n-m$  asymmetrical phases. By using a change of basis, such as the extensive Park transform, we control the system by controlling the constant current references [RYU 06]. This method has the major drawback of having to develop as many transforms (of models) as there are default cases. We can easily apply this method to machines with a small number of phases, but it is increasingly limited as the number of phases increase.

Another method models degradation and adds it to the initial model of the machine [CRE 10]. In this case the complete model is unique and therefore generally applicable to any number of phases. The use of particular controllers is necessary, however, to obtain satisfactory performance.

##### **5.4.2. Torque control of a faulty machine**

As for machines in normal functioning mode, control of the machine in degraded supply mode can be done in the natural basis and in a decoupling basis.

If we control the machine in the natural basis, we again have to calculate the current references allowing us to obtain a constant torque. Several authors propose calculations using optimization methods that cannot be used in real time (off-line method: [FU 94, PAR 07]). The method shown in section 5.3.1, however, can be applied in real time provided that we modify the emf vector according to the non-supplied phases [KES 09b].

If we control the machine in a decoupling basis, two cases arise. The first consists of designing a new model of the machine for each default case. In this case, the current references remain constant [RYU 06]. If we keep the same model of the machine and add a degradation model to it, we will either have to calculate new current references and check that the controllers are able to track them, or keep the same current references as in normal mode (constant) but adapt the number of

degrees of freedom of control according to the number of non-supplied phases [KES 10, LOC 08] and to adapt the bandwidth of the current controllers.

### 5.5. Bibliography

- [CRE 10] CREVITS Y., KESTELYN X., LEMAIRE-SEMAIL B., SEMAIL E., “Modélisation causale pour la commande auto adaptée de machines alternatives triphasées en mode dégradé”, *Revue Internationale de Génie Electrique (RIGE)*, February 2010.
- [DAH 08] DAHL D., SOSNOWSKI D., SCHLEGEL D., KERKMAN R. PENNING M., “Gear up your bearings”, *IEEE Industry Applications Magazine*, vol. 14, issue 4, 2008.
- [FU 94] FU R., LIPO T.A., “Disturbance-free operation of a multiphase current-regulated motor drive with an opened phase”, *IEEE Transactions on*, vol. 30, no. 5, pp. 1267-1274, 1994.
- [GRE 94] GRENIER D., Modélisation et stratégies de commande de machines synchrones à aimants permanents à forces contre-électromotrices non sinusoïdales, thesis, Ecole Normale Supérieure de Cachan, September 1994.
- [GRE 04] GRENIER D., STURTZER G., FLIELLER D., LOUIS J.-P., “Extension de la transformation de Park aux moteurs synchrones à distribution de champ non sinusoïdales”, in LOUIS J.-P. (ed.), *Modélisation des Machines Électriques en Vue de Leur Commande, Concepts Généraux*, Hermes-Lavoisier, Paris, France, 2004.
- [KES 03] KESTELYN X., Modélisation vectorielle multi-machines pour la commande des ensembles convertisseurs-machines polyphasés, Thesis, University of Lille 1, 04th December 2003. (Available at: <http://www.univ-lille1.fr/bustl-grisemine/pdf/extheses/50376-2003-305-306.pdf>, accessed 12.10.11.)
- [KES 09] KESTELYN X., SEMAIL E., CREVITS Y., “Generation of on-line optimal current references for multi-phase permanent magnet machines with open-circuited phases”, *International Electrical Machine and Drive Conference (IEMDC 09)*, May 2009.
- [KES 10] KESTELYN X., SEMAIL E., CREVITS Y., “Fault tolerant control of a seven-phase drive by degrees of freedom adaptation”, *International Conference and Industrial Technology (ICIT 10)*, May 2009.
- [KES 11] KESTELYN X., SEMAIL E., “Multiphase voltage source inverters”, MONMASSON E. (ed.), *Power Electronic Converters: PWM Strategies and Current Control Techniques*, ISTE Ltd, London and John Wiley and Sons, New York, 2011.
- [KLI 83] KLINGSHIRN E.A., “High phase order induction motors - Part I - description and theoretical considerations”, *IEEE Transactions on Power Apparatus and Systems*, vol. PAS-102, no. 1, pp. 47-53, 1983.
- [LEE 01] LEE H.-D., SUL S.-K., “Common-mode voltage reduction method modifying the distribution of zero-voltage vector in PWM converter/inverter system”, *IEEE Transactions on Industry Applications*, vol. 37, no. 6, pp. 1732-1738, 2001.

- [LEV 08] LEVI E., DUJIC D., JONES M., GRANDI G., “Analytical determination of DC-bus utilization limits in multiphase VSI supplied AC drives”, *IEEE Transactions on Energy Conversion*, vol. 23, no. 2, pp. 433-443, 2008.
- [LIM09] LIMONGI L.R., BOJOI R., GRIVA G. and TENCONI A., “Digital Current-control Scheme”, *IEEE Industrial Electronics Magazine*, March 2009.
- [LOC 06] LOCMONT F., SEMAIL E. AND PIRIOU F., “Design and study of a multi-phase axial-flux machine”, *IEEE Transactions on Magnetics*, vol. 42, no. 4, pp. 1427-1430, 2006.
- [LOC 08] LOCMONT F., SEMAIL E., KESTELYN X., “Vectorial approach based control of a seven-phase axial flux machine designed for fault operation”, *IEEE Trans. Indust. Elect.*, vol. 55, no. 10, pp. 3682-3691, 2008.
- [LOU 04a] LOUIS J-P., *Modélisation des Machines Électriques en Vue de Leur Commande, Concepts Généraux*, Traité EGEM, série Génie Électrique, Hermes-Lavoisier, Paris, France, 2004.
- [LOU 04b] LOUIS J-P., *Modèles Pour la Commande des Actionneurs Électriques*, Traité EGEM, Série Génie Électrique, Hermes-Lavoisier, Paris, France, 2004.
- [LOU 04c] LOUIS J-P., FELD G., MOREAU S., “Modélisation physique des machines à courant alternatif”, in LOUIS J-P. (ed.), *Modélisation des Machines Électriques en Vue de Leur Commande, Concepts Généraux*, Traité EGEM, série Génie Électrique, Hermes-Lavoisier, Paris, France, 2004.
- [LOU 10] LOUIS J-P., FLIELLER D., NGUYEN N.K. and STURTZER G., “Synchronous motor controls, problems and modeling”, in: LOUIS J-P.(ed.), *Control of Synchronous Motors*, ISTE Ltd, London and John Wiley and Sons, New York, 2010.
- [MON 11] MONMASSON E., *Power Electronic Converters: PWM Strategies and Current Control Techniques*, ISTE Ltd, London and John Wiley and Sons, New York, 2011.
- [PAR 07] PARSA L., TOLIYAT H.A., “Fault-tolerant interior-permanent-magnet machines for hybrid electric vehicle applications”, *IEEE Transactions on Vehicular Technology*, vol. 56, no. 4, pp. 1546-1552, 2007.
- [RYU 05] RYU H.M., KIM J.H., SUL S.K., “Analysis of multi-phase space vector pulse-width modulation based on multiple d-q spaces concept”, *IEEE Transactions on Power Electronics*, vol. 20, no. 6, pp. 1364-1371, 2005.
- [RYU 06] RYU H.M., KIM J.H., SUL S.K., “Synchronous-frame current control of multiphase synchronous motor under asymmetric fault condition due to open phases”, *IEEE Transactions on Industry Applications*, vol. 42, no. 4, pp. 1062-1070, 2006.
- [SCU 09] SCUILLER F., SEMAIL E., CHARPENTIER J.F., “Multi-criteria based design approach of multiphase permanent magnet low speed synchronous machines”, *IET Trans. Electric Power Applications*, vol. 3, Issue 2, pp. 102-110, 2009.
- [SEM 00] SEMAIL E., “Outils et méthodologie d’étude des systèmes électriques polyphasés. généralisation de la méthode des vecteurs d’espace”, thesis, USTL, June 30 2000. (available at: <http://hal.archives-ouvertes.fr/>)

- [SEM 03a] SEMAIL E., BOUSCAYROL A., HAUTIER J.P., "Vectorial formalism for analysis and design of polyphase synchronous machines", *European Physical Journal-Applied Physics*, vol. 22, no. 3, pp. 207-220, 2003.
- [SEM 03b] SEMAIL E., KESTELYN X., CHARLIER A., "Sensibilité d'une machine polyphasée aux harmoniques spatiaux", *EF'2003*, Supélec, Gif-sur-Yvette, December 9-10, 2003.
- [SEM 04a] SEMAIL E., KESTELYN X., BOUSCAYROL A., "Right harmonic spectrum for the back-electromotive force of an n-phase synchronous motor", *IEEE Industry Applications Conference*, vol. 1, pp. 78, October 3-7, 2004.
- [SEM 04b] SEMAIL E., LOUIS J.-P., FELD G., "Propriétés vectorielles des systèmes électriques triphasés", in: LOUIS J.-P. (ed.), *Modélisation des Machines Électriques en Vue de Leur Commande, Concepts Généraux*, Hermes-Lavoisier, Paris, France, 2004.
- [WHI 59] WHITE D.C., WOODSON H.H., *Electromechanical Energy Conversion*, John Wiley & Sons, 1959.