



HAL
open science

Evaluation of the long-term effect of lime treatment on a silty soil embankment after seven years of atmospheric exposure: Mechanical, physicochemical, and microstructural studies

Geetanjali Das, Andry Razakamanantsoa, Gontran Herrier, Lucile Saussaye, Didier Lesueur, Dimitri Deneele

► To cite this version:

Geetanjali Das, Andry Razakamanantsoa, Gontran Herrier, Lucile Saussaye, Didier Lesueur, et al.. Evaluation of the long-term effect of lime treatment on a silty soil embankment after seven years of atmospheric exposure: Mechanical, physicochemical, and microstructural studies. *Engineering Geology*, 2021, 281, pp.105986. 10.1016/j.enggeo.2020.105986 . hal-03169747

HAL Id: hal-03169747

<https://hal.science/hal-03169747>

Submitted on 3 Feb 2023

HAL is a multi-disciplinary open access archive for the deposit and dissemination of scientific research documents, whether they are published or not. The documents may come from teaching and research institutions in France or abroad, or from public or private research centers.

L'archive ouverte pluridisciplinaire **HAL**, est destinée au dépôt et à la diffusion de documents scientifiques de niveau recherche, publiés ou non, émanant des établissements d'enseignement et de recherche français ou étrangers, des laboratoires publics ou privés.



Distributed under a Creative Commons Attribution - NonCommercial 4.0 International License

1 Evaluation of the long-term effect of lime treatment on a silty soil embankment after
2 seven years of atmospheric exposure: mechanical, physicochemical, and microstructural
3 studies
4

5 Geetanjali Das^{a,*}, Andry Razakamanantsoa^a, Gontran Herrier^b, Lucile Saussaye^c, Didier Lesueur^d, Dimitri
6 Deneele^{a,c}

7 ^a*GERS, Université Gustave Eiffel, IFSTTAR, F-44344 Bouguenais, France*

8 ^b*Lhoist Recherche et Développement, rue de l'Industrie 31, 1400 Nivelles, Belgique*

9 ^c*CEREMA Blois, France*

10 ^d*Lhoist Southern Europe, 15 rue Henri Dagallier, 30040 Grenoble, France*

11 ^e*Institut des Matériaux Jean Rouxel de Nantes, Université de Nantes, CNRS, 2 chemin de la Houssinière,*
12 *BP 32229, 44322 Nantes Cedex 3, France*

13

14 **Abstract**
15

16 The long-term effect of lime treatment was evaluated on a 2.5 % lime-treated experimental
17 embankment after seven years of atmospheric exposure. The evaluation was done by comparison of (i) the
18 mechanical performance of the field sampled specimens with laboratory cured specimens, and (ii) the
19 physicochemical and microstructural properties of the samples from the lime-treated embankment with
20 specimens obtained from an untreated embankment constructed near to it as a reference embankment.

21 An average Unconfined Compressive Strength (UCS) level of 3.29 MPa was measured in the
22 lime-treated specimens sampled from the core of the embankment. This UCS level was found to be
23 comparable to the UCS of accelerated-cured specimens obtained at a laboratory scale. Thus, such levels of
24 UCS can be expected after long-term in-situ curing. Scanning electron microscope images evidenced the
25 contribution of the formation of cementitious bonding towards such UCS evolution in the lime-treated
26 specimen. The persistence of the lime effect within the core of the embankment was confirmed by the
27 presence of a pH greater than 11. However, a relative decrease in the pH and water content was observed
28 in the upper layer compared to the core of the lime-treated embankment. This indicates that the effect of
29 lime was lost in the upper layer under constant soil-atmosphere interaction and due to the development of
30 vegetation roots. Pore structure observations made by Mercury Intrusion Porosimetry (MIP) and Barrett-
31 Joiner-Halendapore (BJH) methods highlight the formation of smaller pores (diameter < 3000 Å) under
32 lime effect. These smaller pores have contributed towards the evolution of suction in the core-sampled
33 specimens of the lime-treated embankment. This has led to the long-term water retention capacity of the
34 lime-treated soil. BJH was able to detect mesopore-formation (25-500 Å) under the lime effect in a more
35 precise manner compared to MIP. The evolution of mesopores was found to be coincident with the
36 development of strength and specific surface area of the lime-treated soil.

37

38 *Keywords: lime treatment; compressive strength; embankment; mesopores; atmospheric exposure.*

39

40

1. Introduction

Management of natural resources is a critical challenge in any land development project, especially for projects related to earthworks. A cost-effective way to conserve natural resources is to use soil located directly in the land reserved for the project. This makes it essential to improve the engineering properties of the available soil. In this regard, soil improvement by lime is known to be an efficient and economical technique that leads to improved bearing capacity, strength, modulus, etc. (Al-Mukhtar et al., 2012; Bell, 1996; Diamond and Kinter, 1965; Little, 1995; Osula, 1996). Additionally, the lime-treated soil structure is also known to be eco-friendly as the material can be entirely reused after the deconstruction of the structure (Hopkins et al., 2007).

Most studies conducted on soil improvement by lime treatment were obtained from laboratory test results (Ali and Mohamed, 2019; Lemaire et al., 2013; Verbrugge et al., 2011) while the feedback from field performance is less investigated. It is worth noting that the conditions faced by the lime-treated soil under the laboratory- and field-testing environments are relatively different.

Several studies have reported long-term strength improvement in pavement layers stabilized with lime (Aufmuth, 1970; Cardoso and das Neves, 2012; Little, 1995; McDonald, 1969). Aufmuth (1970) concluded that the in-situ California Bearing Ratio (CBR) value observed in lime stabilized pavement layers significantly rises with age and tends to appear permanent if compared to the CBR value of the same soil without stabilization. McDonald (1969) confirmed the effectiveness of lime treatment through a study made on pavements subjected to low, medium, and heavy traffics flow after about 13 years from construction. This was in terms of improved smoothness or rideability and better structural response as indicated by deflection measurements. Cardoso and Neves (2012) demonstrated the effectiveness of lime in reducing the overall settlement rate of an embankment built with marls. They showed how lime treatment induced a decrease in the secondary consolidation of the marls with increased curing, reduced the swelling potential, and increased its stiffness.

So far, few studies have reported the behaviour of lime-treated specimens sampled from real or experimental earth structures submitted to long-term environmental exposure. Rosone et al. (2018) studied the effect of seasonal wetting and drying cycles for over 18 months on specimens obtained from lime-treated expansive clay soil embankment. The suction value measured at the top layer of the embankment was reported to be three times higher than that measured at 0.45 m depth from the surface. Below 0.45 m, the total suction value stabilized at about 1.40 MPa. The high value of suction measured on the top of the embankment was attributed to evapotranspiration, leading to water loss, a rise of suction, and crack development.

Bicalho et al. (2018) described a similar observation with respect to the rise in suction and water content loss in specimens sampled up to a depth of 0.75 m from the surface of a 2 % lime-treated silty clay experimental embankment due to climatic variation. However, with increased curing time, this impact of seasonal variation in the variability of water content and soil suction was minimised, thus indicating the good stability of the lime-treated soil.

The Friant-Kern Canal construction in California, United States, was based on 4 % quicklime by weight to stabilize a highly plastic clay soil in permanent contact with water (Herrier et al., 2012; Knodel, 1987). More than 40 years after construction, the study evidenced the increased long-term strength, reduction in swelling and shrinkage potential, as well as significant resistance to erosion, thus showing the improved geo-mechanical stability of the structure (Akula et al., 2020).

All these studies have demonstrated the effectiveness of lime treatment over time and, to an extent, the effect of the soil atmosphere interaction on the modification of properties of lime-treated soil. Beyond the general behaviour mentioned herein, more investigation is needed with respect to strength and microstructural modifications induced by long-term lime treatment on structures cured in the open atmosphere.

The purpose of this study was to thoroughly evaluate the influence of lime treatment in an atmospherically cured lime-treated embankment after seven years of exposure to wet environmental

91 conditions. The climatic condition of the construction region can be referred to in Makki-Szymkiewicz et
92 al. (2015), who investigated the embankment at an early age (up to 1 year from construction) to assess its
93 hydraulic performance. They demonstrated that if proper mixing and compaction process is maintained
94 during construction, a permeability of 10^{-9} m/s can be obtained, which was similar to the untreated soil.
95 The present study demonstrates an extended investigation regarding the effectiveness of lime treatment in
96 the long-term. The examination of the lime-treated structure was made in terms of strength,
97 physicochemical characteristics, and microstructure, which was lacking in the studies reported above.

98 The first part of the study focuses on (i) evaluating the UCS of the lime-treated soil, (ii)
99 examining the presence of cementitious bonding within the fabric of the lime-treated soil, and (iii)
100 investigating the long-term effect of lime treatment on water content, suction, and pH. The second part
101 presents the effect of lime treatment on pore structure and specific surface area modifications.
102

103 **2. Studied embankment, samples, and methods**

104 *2.1. Materials and implementation of the embankment*

106 The soil used is a silty soil from Marche-Les-Dames (MLD), Belgium, with the following
107 mineralogy: Illite, Kaolinite, and Chlorite as clay minerals along with Quartz and Feldspars. All
108 information about the embankment construction can be obtained from Makki-Szymkiewicz et al. (2015).

109 The lime-treated embankment was built with 2.5 % of quicklime (CaO), a Proviacal ® DD CL 90-
110 Q supplied by Lhoist. For reference purposes, an untreated embankment was constructed under the same
111 conditions. The maximum dry densities, $\rho_{d\ max}$ of the untreated and 2.5 % lime-treated soil obtained by
112 Standard Proctor test (as per ASTM D698-12e2) were $18.2\ \text{kN/m}^3$ and $17.3\ \text{kN/m}^3$, respectively, and the
113 Optimum Moisture Contents (OMCs) were 14.6 % and 17.8 %, respectively. Both embankments were
114 compacted by a vibratory sheep foot roller at a moisture content of about 1.1 times of optimum. The lime-
115 treated and the untreated embankment were compacted in 6 and 3 layers, respectively. The average water
116 content recorded after completion of compaction of the untreated and the lime-treated embankment was
117 17.0 % and 19.4 %, respectively.
118

119 *2.2. Specimens sampling from the embankment and sample preparation for laboratory test*

121 During deconstruction, at first, few specimens were gathered at different depths from the surface
122 up to a depth of 0.12 m (i.e., in the regions close to the surface) to understand the impact of seasonal
123 variation and vegetation roots in the lime-treated embankment. Then the soil near the surface was
124 removed to limit the effect of weathering and plant roots. Later, trenches were excavated (Fig. 1) for
125 sampling soil specimens at different depths throughout the core of the embankment.

126 A single trench was made on the untreated embankment (Fig. 2). Four trenches were excavated
127 across the lime-treated embankment: T1 and T2 located towards the South-West, and T3 and T4 were
128 located towards the North-East (Fig. 3). Specimens were collected throughout the trenches described in
129 Fig. 2 and Fig. 3 for the untreated and lime-treated embankments, respectively.
130



Fig. 1: Trench excavated in the lime-treated embankment (T2) for the sampling of specimens

131
132
133
134
135 The following nomenclature is used here to identify the various specimens. The specimens
136 collected from the trench excavated in the untreated embankment are referred to as 'Nat', followed by the
137 number displayed in the cross-section (Fig. 2). Similarly, specimens collected from the trench of the lime-
138 treated embankment are referred to as 'T1', 'T2', 'T3', and 'T4', followed by the number in the
139 corresponding cross-section (Fig. 3).

140 The trenching of the untreated embankment was relatively easy to perform, as the compacted soil
141 was damp and less cohesive. However, block-cutting was not possible due to the low cohesion of the soil.

142 In the lime-treated embankment, two types of sampling were carried out. A compacted cubic
143 block of about 0.40 m³ volume was cut from trenches using an excavator. It is worth noting that the
144 process of block sampling was particularly complicated due to the rigidity of the soil. The second type of
145 sampling consists of recovering smaller samples taken from each point of sample collection of the four
146 trenches (Fig. 3). All specimens sampled were packed in a sealed bag and transported to the laboratory
147 with care.

148 For strength measurement, two compacted cubic blocks were sampled from point T1-1 and T2-4,
149 located at a depth of 0.30 m and 0.75 m normal to the slope, respectively (Fig. 3). These blocks were later
150 trimmed at the laboratory to obtain specimens having dimensions of length (l) and diameter (d) with an l/d
151 ratio of 2 and 1. The 'l' and 'd' of specimens corresponding to l/d ratio of 2 were 0.08 m and 0.04 m,
152 respectively, and while it was 0.05 m for both 'l' and 'd' for specimens corresponding to l/d ratio of 1.
153 Samples of dimension l/d = 2 were obtained as ASTM D 2166 (ASTM, 2006) recommends the standard
154 size of specimens to be within l/d ratio of 2 and 2.5 for the UCS test. Additional samples of l/d = 1 were
155 trimmed.

156

157

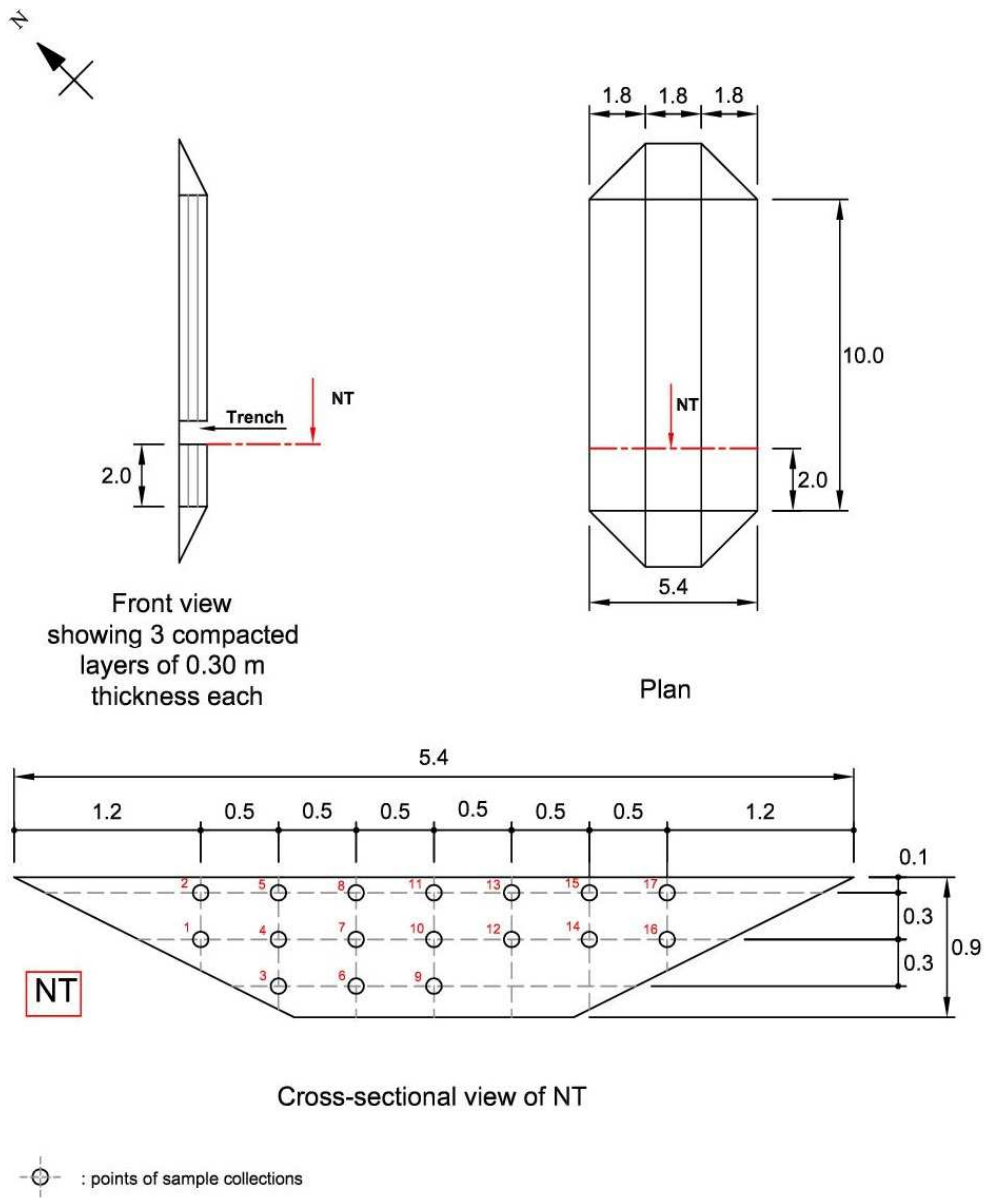

158

159

160

161

162

Fig. 2: Plan view, Front view along with Cross-sectional view of the excavated trench made for sample collections from the Untreated embankment (All units in meter)

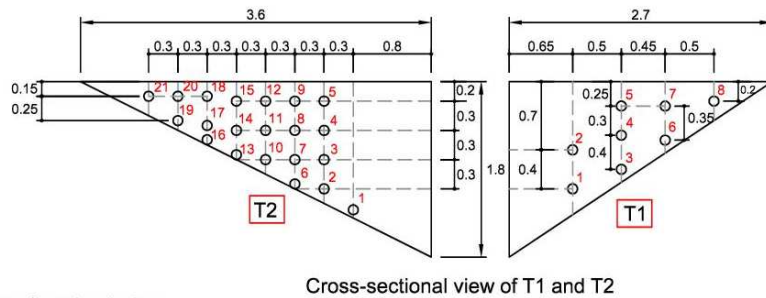
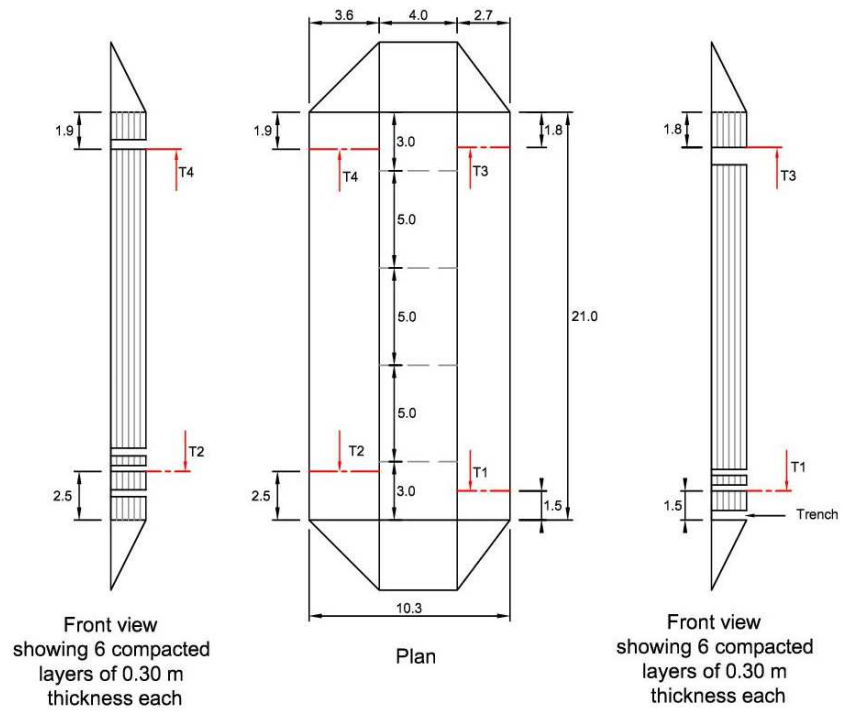
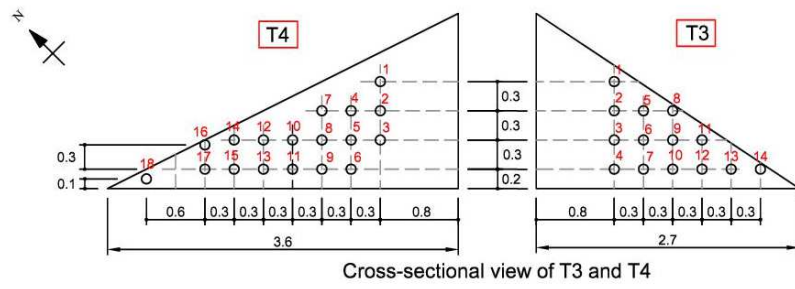

: points of sample collections

Fig. 3: Plan view, Front view along with Cross-sectional view of the excavated trenches made for sample collections from the lime-treated embankment (*All units in meter*)

163
164
165
166
167

168 2.3. Laboratory tests

169 The UCS of the samples was measured using a mechanical press with a load sensor of 25 kN
170 capacity. Measurements were performed at a constant deformation rate of 1 mm/min.

171 The soil fabric was assessed using a Scanning Electron Microscope (SEM) observation. The high-
172 field emission Hitachi SU5000 SEM device was used for this purpose.

173 The physicochemical behaviour was investigated by measuring the water content, suction, and pH
174 of the collected samples. Specimens sampled throughout the core of the trenches (Figs. 2 & 3) were
175 subjected to all three tests. At the same time, the upper-layer-sampled specimens were subjected to water
176 content and pH measurements. The water content measurement was carried out by oven drying at 105°C
177 (ASTM, 2010), and the suction measurements were conducted using the WP4C Dewpoint Potentiometer
178 (Decagon device). The pH measurement was executed by HI 2210 pH Meter. Samples collected were
179 sieved through a 2 mm mesh size and then suspended in distilled water in a liquid-solid ratio of 5:1
180 (volume fraction) for 1 hour. The pH of the suspended solution was then recorded.

181 The Specific Surface Area (SSA) of compacted freeze-dried samples were analysed by Brunauer–
182 Emmett–Teller (BET) (Brunauer et al., 1938) test using Micromeritics TriStar II PLUS. Since SSA values
183 were measured in compacted specimens, hence the measured values can be possibly lower than those of
184 powdered samples under similar conditions.

185 Pore characterization was done on compacted freeze-dried samples using MIP test and BJH
186 method. MIP test was conducted using Micromeritics Auto Pore IV, while the BJH method analysed the
187 pore structure from the data obtained by the BET test. The observed pore structure was classified based on
188 the International Union of Pure and Applied Chemistry (IUPAC) (Rouquerol et al., 1994), which
189 categorizes the pore-width as macropores ($> 500 \text{ \AA}$), mesopores ($20\text{-}500 \text{ \AA}$), and micropores ($< 20 \text{ \AA}$).
190 Lime treatment was shown to generate the development of smaller pores of diameter less than 3000 \AA
191 (Bhuvaneshwari et al., 2014; Cuisinier et al., 2011). This smaller pore includes a part of the macropores
192 range and the total range of mesopores and micropores as per IUPAC classification. Thus, to obtain a
193 more accurate description of the size of pore evolution, this study uses both the MIP test and the BJH
194 method. In this study, the analysis of Pore Size Distribution (PSD) by BJH was made considering the
195 desorption branch of the isotherm because the formation of the cylindrical meniscus is assumed to be
196 stable in the desorption branch as reported by Bin et al. (2007) and Cai and Hu, (2019). The contribution
197 of lime treatment on pore structure modification was investigated by a comparative analysis of pore
198 characterizations made on four selected samples. These specimens were collected at two constant depths
199 to avoid any possible additional stress impact: untreated specimens Nat 1, Nat 2, and lime-treated
200 specimens T2-2, T2-3. Specimens Nat 1 and T2-2 were sampled at 0.15 m depth, whereas Nat 2 and T2-3
201 are located at 0.45 m depth, normal to the slope (Figs. 2 & 3).

202 The distribution of moisture content, pH, and SSA of the specimens sampled from the core of the
203 embankments are presented using contour plots obtained by using the mapping software: Surfer 13.

204 Table 1 summarizes the complete testing programs with the corresponding identifications and
205 numbers of specimens.

206
207
208
209
210
211
212
213
214
215
216
217

218
219
220
221

Table 1:
Test programs with samples identifications and numbers

Sample type	Test name	No. of samples	Sample name
Laboratory (Lab.) specimens	UCS	3	Lab.-28days-20°C (l/d=2), Lab.-90days-20°C (l/d=2), Lab.-90days-40°C (l/d=1)
In-situ (upper layer-sampled) specimens	Water content, pH	13 each	T1 and T2
	UCS	4	T1-1 (l/d=2 ; 0.30 m), T2-4 (l/d=2 ; 0.75 m), T1-1 (l/d=1 ; 0.30 m), T2-4 (l/d=1 ; 0.75 m)
	SEM	2	Nat 2 (0.45 m), T1-1 (0.30 m)
	Water content, pH, SSA	78 each	All specimens shown in cross-sections of Fig. 2 & 3
In-situ (core-sampled) specimens	PSD by MIP	4	Nat 1 (0.15 m), Nat 2 (0.45 m), T2-2 (0.15 m), T2-3 (0.45 m)
	PSD by BJH	17	Nat 1 (0.15 m), Nat 2 (0.45 m), T1-1 (0.30 m), T2-2 (0.15 m), T2-3 (0.45 m), T2-4 (0.75 m), T1-2, T1-3, T1-6, T1-7, T2-13, T3-7, T3-9, T3-14, T4-8, T4-11, T4-12

222
223
224
225

3. Results

3.1. Unconfined Compressive Strength

226
227
228

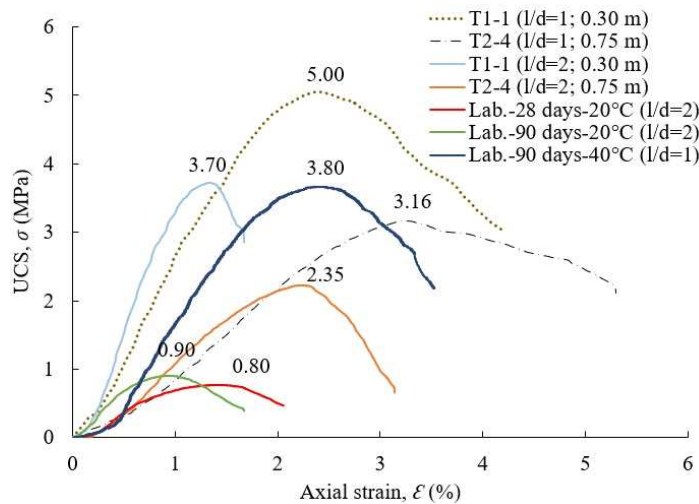

229
230
231

Fig. 4: UCS measured from the field- and laboratory-cured specimens

232
233
234
235
236
237

The UCS values of the four trimmed core-sampled specimens from T1-1 (0.30 m) and T2-4 (0.75 m), as mentioned in section 2.2, are presented in Fig. 4. Specimens from T1-1 show UCS values of 3.70 MPa (l/d = 2) and 5.00 MPa (l/d = 1). Specimens from T2-4 show UCS values of 2.35 MPa (l/d = 2) and 3.16 MPa (l/d = 1). The corresponding water content of these specimens during the UCS test was measured to be around 11.0 %.

238 The UCS measured in the in-situ specimens was compared with three laboratory-cured samples
 239 prepared with similar soil and the same lime content and water content as the field specimens. Two
 240 laboratory compacted specimens of dimension having l/d ratio of 2 were cured for 28- and 90-days at
 241 20°C. The 28-day curing was considered as a reference short curing period, whereas 90-day was the long
 242 curing period at a laboratory scale. Since no laboratory study was made with specimens subjected to 7
 243 years of curing, a third laboratory compacted sample was subjected to accelerated curing (at 40°C) for 90
 244 days. Lemaire et al. 2013 and Zhang et al. 2020 have demonstrated that the increase in temperature
 245 accelerates the soil-water-lime chemical reactions resulting in a rapid rise of UCS level in the lime-treated
 246 soil.

247 Fig. 4 shows that the UCS measured for 28- and 90-days laboratory cured specimens at 20°C (of
 248 dimension l/d = 2) were 0.80 and 0.90 MPa, respectively. While the UCS measured for the accelerated
 249 cured specimens (of size l/d = 1) was 3.80 MPa.

250
 251 *3.2. SEM observations*
 252

253 Fig. 5 presents the SEM images showing the fabric structures of Nat 2 (untreated specimen
 254 sampled at 0.45 m depth from the slope) and T1-1 (lime-treated specimen sampled at 0.30 m depth from
 255 the slope) freeze-dried and gold-coated specimens. At a magnification of 1.00k, macropores and
 256 aggregates were observed in Nat 2 (Fig. 5 (a)), while in T1-1, the aggregates, minerals, and pores were
 257 found to be covered by a gel layer (Fig. 5 (b)).

258 At higher magnifications (Fig. 5(c & d)), the cementitious bonding was observed between
 259 minerals and soil aggregates in T1-1, which is as reported in prior literature (di Sante, 2019; Jha and
 260 Sivapullaiah, 2019; Lemaire et al., 2013).

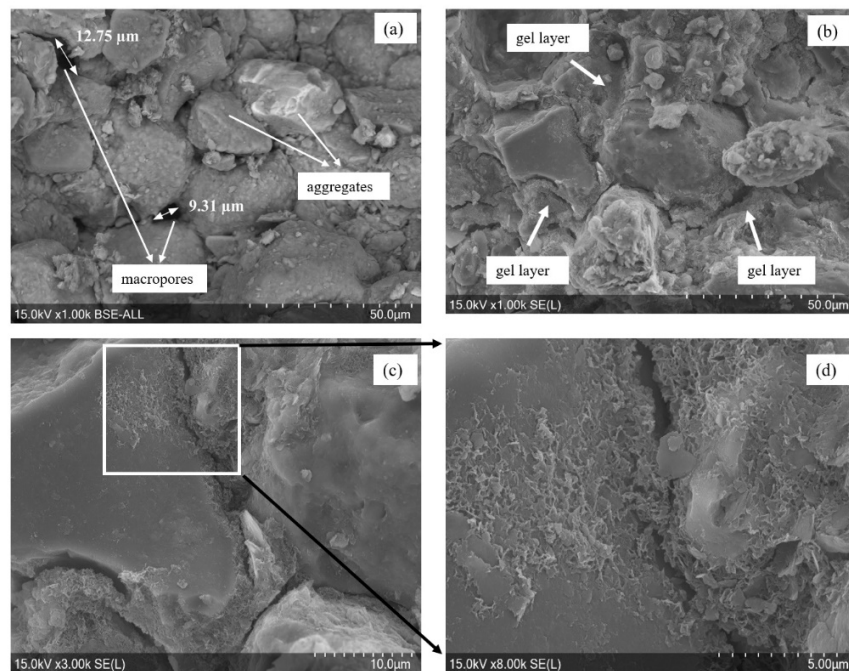

261
 262 **Fig. 5:** SEM images of specimens Nat 2 (0.45 m) (a) and T1-1 (0.30 m) (b-d) at different magnifications sampled from the core of
 263 the embankments

264
 265

266
267
268
269
270
271
272
273
274
275
276
277
278

3.3. Physicochemical properties

3.3.1. Distribution of water content

Fig. 6 presents the distribution of water content throughout the core of the untreated and lime-treated embankments measured during deconstruction.

In the core of the untreated embankment, the water content was measured to be minimum at the surface, i.e., 11.8 %, and it gradually increased with depths reaching 15.4 % at the subgrade (Fig. 6(a)). While throughout the core of the lime-treated embankment, the water content measured was observed to be unevenly distributed in the range 17-19.3 % (Fig. 6 (b-e)).

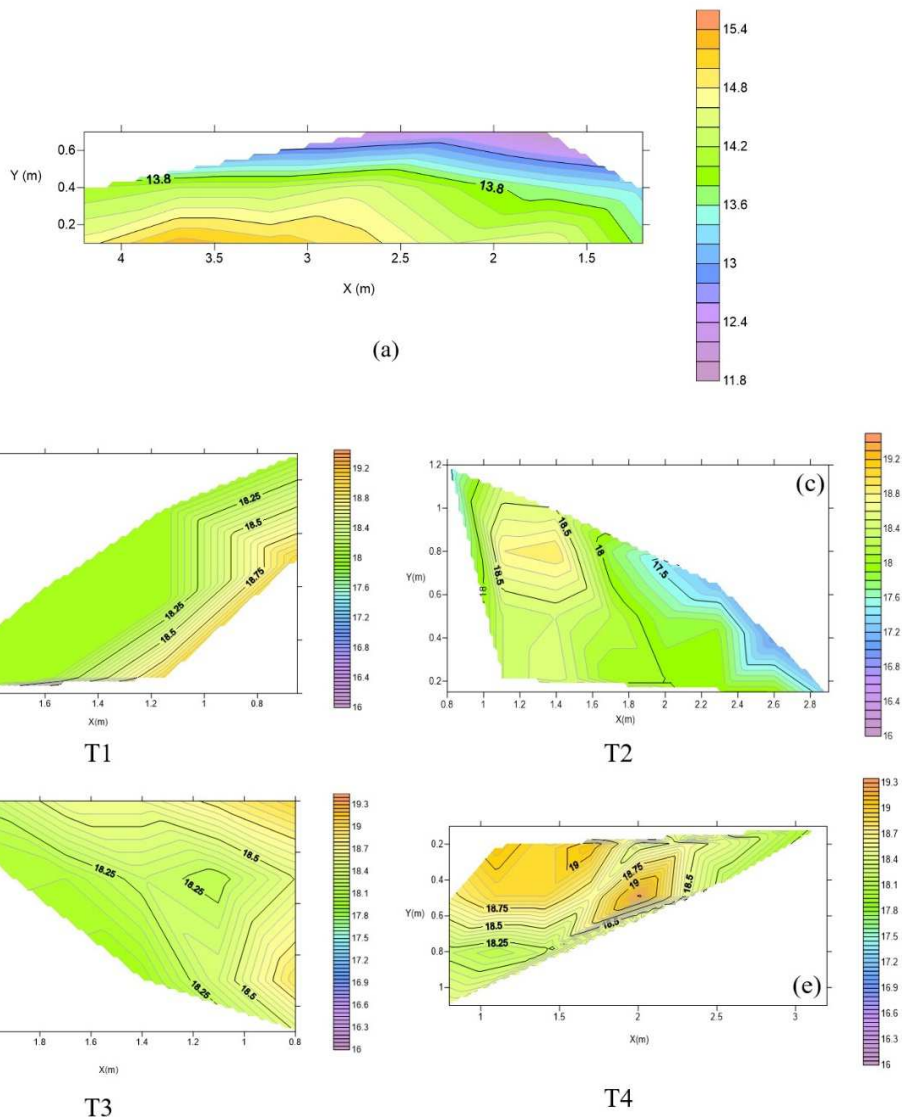

279

280

281 **Fig. 6:** Contour plots showing the distributions of water content (%) in the untreated (a) and the cross-sections T1 (b), T2 (c), T3
282 (d), and T4 (e) of the lime-treated embankments measured during deconstruction

283

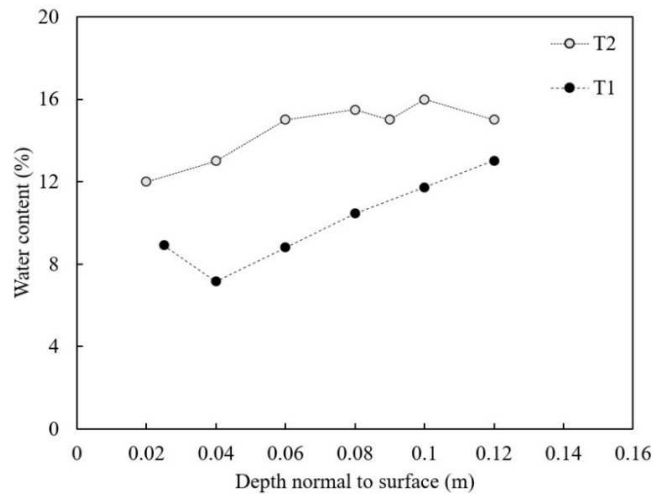

Fig. 7: Water content (%) measured on specimens sampled from the upper layer of the lime-treated embankment during deconstruction

284

285
286

287 Fig. 7 presents the water content measured on the upper layer-sampled specimens of the lime-
288 treated embankment from the cross-sections T1 and T2 up to a depth of 0.12 m normal to the surface. The
289 minimum water content observed in T1 was 7.0 %, while it was 12.0 % for T2. The water content then
290 gradually increased with depth from the surface and reached a maximum value of 15 % for T2 and 13 %
291 for T1.

292

293 3.3.2. Measurement of suction

294 The suction measured for all the untreated and the lime-treated core-sampled specimens is
295 presented in Table 2. Due to the presence of 78 samples, measurement of suction was done sequentially,
296 one after the other. This led to a slight variation between the water content measured during suction
297 measurement and the one measured during deconstruction, as seen in Table 2. The suction range measured
298 for the untreated specimens was 0.19-1.14 MPa, which corresponds to a water content range of 9.89-11.71
299 %. While for the lime-treated soil, the suction range measured was 0.17-2.71 MPa, corresponding to a
300 water content range of 15.8-17.9 % (Table 2).

301

302

303

304

305

306

307

308

309

310

311

Table 2:

Suction measured on untreated and lime-treated core-sampled specimens

Sample	Numbers	1	2	3	4	5	6	7	8	9	10	11	12	13	14	15	16	17	18	19	20	21	
Untreated	WC (DC) ¹ (%)	13.3	13.7	11.9	13.6	14.6	12.4	14.0	14.4	12.2	14.5	14.9	14.2	15.1	14.2	15.3	14.0	14.7					
	WC (SM) ² (%)	9.89	11.2	9.73	10.8	12.9	9.71	11.9	11.6	9.38	11.7	11.4	12.7	12.6	12.3	12.3	11.5	12.1					
	Suction (MPa)	1.14	0.73	0.60	0.88	0.40	0.80	0.57	0.65	1.01	0.19	0.46	0.21	0.61	0.45	0.66	0.39	0.31					
T1	WC (DC) (%)	18.2	19.0	18.1	18.2	18.7	17.9	18.2	18.2														
	WC (SM) (%)	17.0	18.0	17.0	17.0	18.0	16.3	17.3	17.2														
	Suction (MPa)	1.15	0.80	1.29	0.76	0.72	1.47	0.78	0.71														
T2	WC (DC) (%)	17.4	18.4	18.8	18.3	18.3	18.5	18.9	18.4	18.5	17.8	18.2	18.0	17.4	17.8	18.0	17.2	17.9	18.0	18.0	17.0	17.3	
	WC (SM) (%)	14.1	16.0	15.2	16.2	18.2	16.4	15.2	16.3	17.2	17.0	16.0	15.4	16.4	17.0	17.5	16.8	16.4	16.6	16.3	16.0	16.4	
	Suction (MPa)	1.51	0.86	0.89	0.34	0.40	0.55	0.95	0.83	0.93	0.80	1.29	1.75	1.10	0.83	0.80	1.27	1.29	1.03	1.39	1.61	1.13	
T3	WC (DC) (%)	18.5	18.9	18.5	19.0	18.4	18.2	18.8	18.0	18.3	18.6	18.1	18.6	18.3	18.2								
	WC (SM) (%)	17.9	17.6	17.2	17.7	18.2	18.1	17.9	17.2	17.1	18.2	17.8	17.9	18.2	17.2								
	Suction (MPa)	0.42	0.63	0.51	0.71	0.56	0.41	0.53	0.71	0.68	0.18	0.40	0.17	0.35	0.85								
T4	WC (DC) (%)	18.5	18.2	18.7	18.1	18.9	19.1	18.2	18.9	18.9	18.6	19.1	19.3	18.4	18.5	18.6	18.1	18.4	17.9				
	WC (SM) (%)	17.9	14.5	18.0	17.3	17.6	16.6	16.9	17.1	15.3	16.5	16.6	18.5	14.5	15.8	17.2	16.1	17.5	16.9				
	Suction (MPa)	0.97	0.30	0.50	0.95	0.87	1.14	0.90	1.31	1.40	1.77	1.46	0.70	2.04	2.71	1.03	1.76	0.98	1.63				

312

¹WC(DC): Water content measured during the deconstruction of embankments

313

²WC(SM): Water content measured during the suction measurement

314

315

316
 317
 318
 319
 320
 321
 322
 323

3.3.3. Distribution of pH

Fig. 8 presents the distribution of pH throughout the core of the untreated and the lime-treated embankments measured during deconstruction.

The pH value of the untreated embankment was between 8.3 to 8.8 (Fig. 8 (a)). In the lime-treated embankment, the measured pH value ranges between 11.08 and 11.66 (Fig. 8 (b-e)).

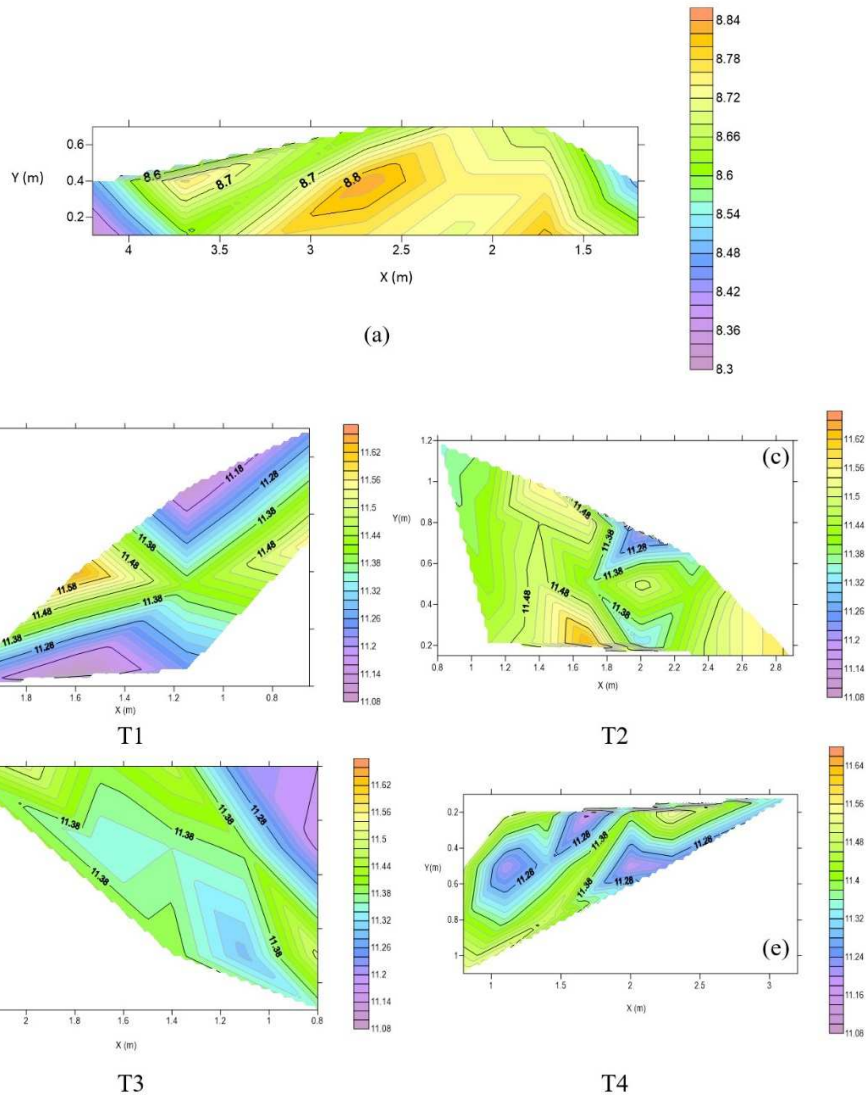

324

325

326 **Fig. 8:** Contour plot showing the distribution of pH in the untreated (a) and the cross-sections T1 (b), T2 (c), T3 (d), and T4 (e) of
 327 the lime-treated embankments measured during deconstruction

328 The pH measured from the specimens sampled at the upper layer (up to 0.12 m depth from the
 329 surface) of T1 and T2 was observed to be between 8.0 and 9.0 (Fig. 9). The trend of pH distribution in the
 330 upper layer of T1 and T2 appears to be almost similar.

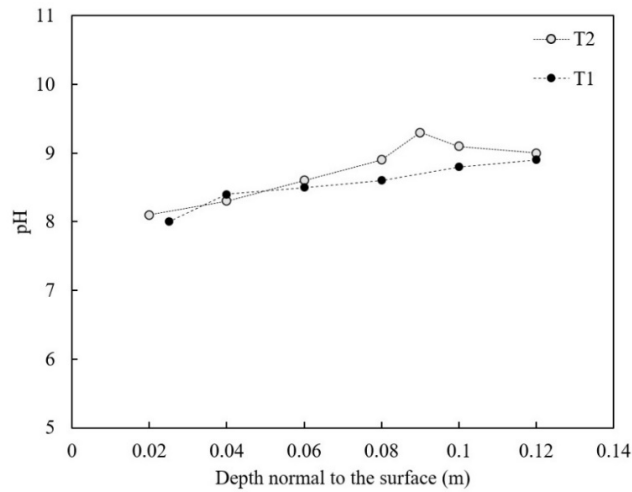

331
332 **Fig. 9:** pH measured on specimens sampled from the upper layer of the lime-treated embankment during deconstruction

333

334 *3.4. Pore size distributions*

335 Fig. 10 (a-h) presents the PSD and cumulative pore volume of the untreated (Nat 1 and Nat 2) and
336 the lime-treated specimens (T2-2 and T2-3) core-sampled at two different depths using MIP test and BJH
337 method.

338 On investigating the pore structure of the untreated specimens by MIP, Nat 1 (0.15 m), and Nat 2
339 (0.45 m) a bimodal and unimodal PSD were observed, respectively (Fig. 10 (a)). Nat 1 shows the higher
340 intensity of macropores diameter of around 10^4 and 10^5 Å, while Nat 2 shows the same around pore
341 diameter 10^4 Å. The cumulative pore volume measured for Nat 1 was about 19 % higher than Nat 2 (Fig.
342 10 (b)). On observing the PSD and cumulative pore volume (in the range of pore diameter 20-250 Å) of
343 the same untreated specimens by BJH, no significant presence of pores was observed in the mesopore
344 range of pore diameter 50-500 Å (Fig. 10 (e & f)). Moreover, a similar narrow peak was seen at the pore
345 diameter of 40 Å for both Nat 1 and Nat 2 (Fig. 10 (e)).

346 For the lime-treated specimens, the MIP results of both samples T2-2 (0.15 m) and T2-3 (0.45 m)
347 show a broad unimodal peak at 625 Å with the development of smaller pores lower than pore diameter of
348 3000 Å (Fig. 10 (c)). The trend of PSD remains the same for T2-2 and T2-3. However, T2-2 shows 20 %
349 lower total pore volumes than T2-3 (Fig. 10 (d)). While analysing the pore structure of these specimens
350 by BJH, the trend of the PSD in the mesopore range of pore diameter 40-500 Å remains the same for both
351 the lime-treated samples Fig. 10 (g). Both the specimens show a significant presence of mesopores of pore
352 diameter in the range 50-500 Å. Specimen T2-2 shows a 27 % lower cumulative pore volume in the
353 mesopore range of pore diameter 20-250 Å than T2-3 (Fig. 10 (h)). Additionally, a similar narrow peak at
354 the pore diameter of 40 Å was observed for both T2-2 and T2-3 (Fig. 10 (g)).

355
356
357
358
359
360
361
362

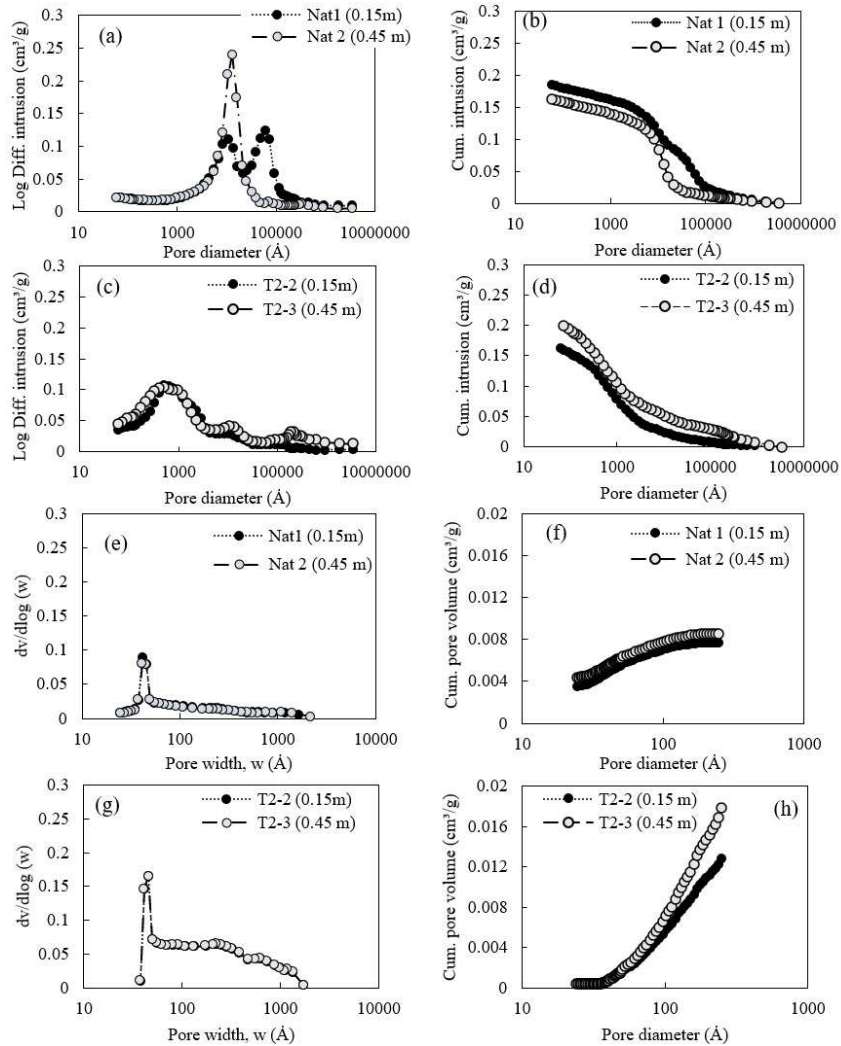

Fig. 10: PSD and Cumulative (Cum.) pore volume observed between untreated (Nat & Nat 2) and lime-treated specimens (T2-2 & T2-3) at a depth of 0.15 m & 0.45 m normal to the slope by MIP (a-d) & BJH (e-h) methods

363
364
365
366
367
368
369

3.5. Distribution of SSA

Fig. 11 (a) shows the distribution of SSA throughout the core of the untreated embankment, which remains almost similar.

The SSA measured throughout the core of the lime-treated embankment appears to be unevenly distributed in all the cross-sections presented in Fig. 11 (b-e). The maximum range of SSA measured was between $40 \text{ m}^2/\text{g}$ and $45 \text{ m}^2/\text{g}$, which was observed in few specimens sampled from T1 (Fig. 11 (b)), while other specimens show SSA values within $11 \text{ m}^2/\text{g}$ and $39 \text{ m}^2/\text{g}$ (Fig. 11 (b-e)).

370
371
372
373
374
375
376

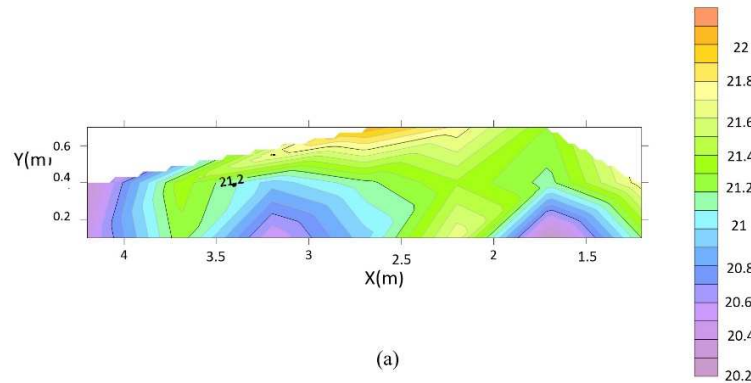

(a)

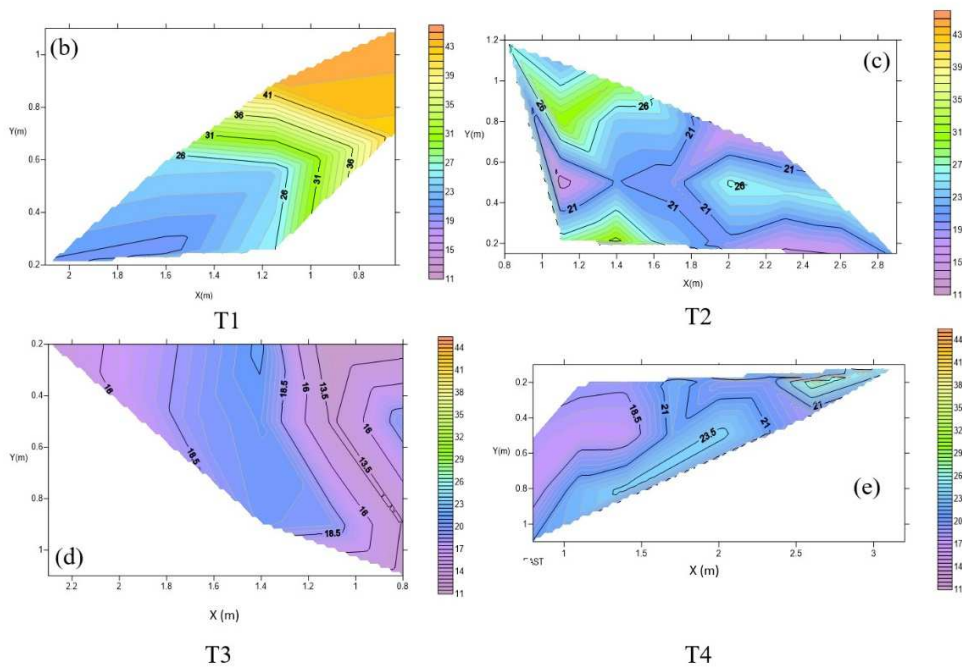

377

378

379
380

Fig. 11: Contour plot showing the distribution of SSA (m^2/g) in the untreated (a), and cross-sections T1 (b), T2 (c), T3 (d), and T4 (e) of the lime-treated embankments during deconstruction

381

382 4. Discussions

383

384 4.1. Evaluation of the UCS measured from the in-situ cured lime-treated specimens

385 Since specimens tested for the UCS had two different l/d ratios, a comparison between two
 386 samples of different ratios is made by applying a correction factor. According to ASTM-C42-77 (ASTM,
 387 1978), a correction factor of 0.87 should be applied to the UCS measured using specimens with $l/d = 1$
 388 to obtain the corresponding UCS of a similar sample having $l/d = 2$. Thus, corrected UCS values of 4.35
 389 (5.00×0.87) and 2.74 (3.16×0.87) MPa (Fig. 4) were obtained for T1-1 and T2-4, respectively.
 390 Expectedly, these corrected values are nearly equal to the UCS of specimens (T1-1 & T2-4) having $l/d = 2$
 391 (Fig. 4). Thus, considering different depths of sampling and different dimensions of the specimens, the
 392 UCS results can be assumed to be repeatable.

393 At the laboratory scale, the UCS measured from the accelerated cured specimen (Fig. 4) was
 394 corrected to 3.31 (3.80×0.87) MPa using the correction factor. The UCS of the in-situ specimens (Fig. 4)
 395 was observed to be about 2-4 times higher than what was measured after 28- and 90-days laboratory
 396 curing at 20°C. This highlights the contribution of lime treatment in increasing the UCS of the soil after
 397 long-term curing.

398 The average of the UCS value measured for the four in-situ cured specimens was 3.29 (± 0.45)
 399 MPa. This average UCS value was found to be of comparable order to the UCS of the laboratory
 400 accelerated cured specimen of dimension having $l/d = 2$ (3.31 MPa). This implies that such UCS levels
 401 can be expected after long-term curing. An inspection of the SEM images (Fig. 5 (b-d)) reveals that such
 402 evolution of UCS in the in-situ samples can be attributed to the formation of cementitious bonds as a
 403 result of pozzolanic reactions.

404 Another factor that can influence the in-situ measured UCS is the loss in water content. The water
 405 content measured in T1-1 and T2-4 during the UCS test was found to be 7 % lower than what was
 406 measured during the deconstruction period ($\approx 18\%$) (Fig. 6 (b & c)). This loss of water occurred due to the
 407 complications faced at the time of the trimming of the block-sampled specimens in the laboratory, as
 408 mentioned in section 2.2. One might argue that this loss of water might have resulted in a higher UCS
 409 level than expected. However, the evolution of a comparable level of UCS in the laboratory accelerated
 410 cured specimens, the maintenance of pH greater than 11, and the formation of cementitious bonding
 411 support the fact that the observed level of UCS was unlikely to have been influenced by the loss of water.
 412
 413

414 4.2. Contribution of mesopores generation towards strength evolution in lime-treated soil

415 The UCS of specimens T1-1 and T2-4 differs by 2 MPa (Fig. 4) even after they show similar
 416 water content during deconstruction ($\approx 18\%$) and UCS test (11 %). Also, the pH measured during
 417 deconstruction was of the same level (Fig. 8 (b & c)). Thus, it can be derived that the observed difference
 418 in the UCS is not due to the difference in water content or pH. However, the suction measured for T1-1
 419 corresponding to a water content of 17 % was 1.15 MPa, while it was 0.34 MPa for T2-4 at a water
 420 content of 16 % (Table 2). This difference in suction level might be due to differences in microstructural-
 421 development between T1-1 and T2-4 under the lime effect.

422 Lime treatment generates smaller pores (Cuisinier et al., 2011), which was shown to contribute to
 423 the rise in cohesion and hence strength (Verbrugge et al., 2011). In this aspect, the difference in smaller
 424 pores evolution between T1-1 and T2-4 was investigated by BJH method, as BJH method was observed to
 425 measure ranges of pores relatively lower than the one measured by MIP test in Fig. 10.
 426

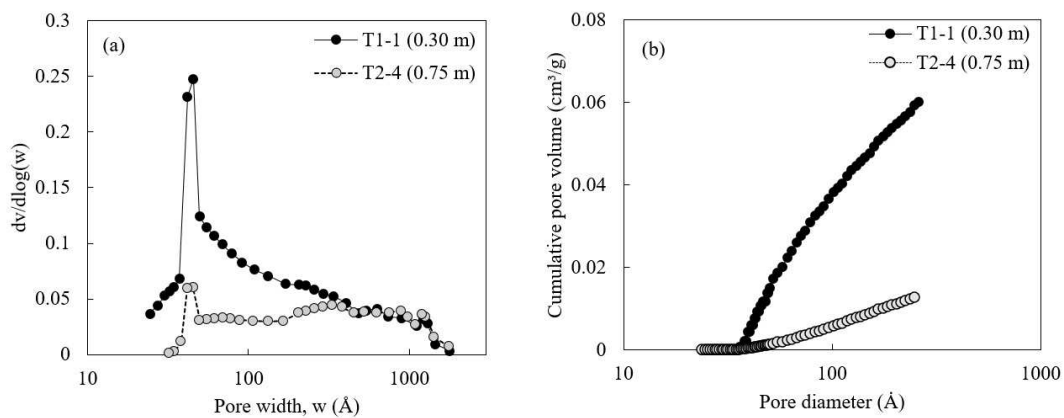

427
 428 **Fig. 12:** Evolution of mesopores distribution (a) and cumulative pore volume (b) between T1-1 & T2-4 by BJH method

429 Fig. 12 shows the mesopores distribution of T1-1 and T2-4. In Fig. 12 (a), a narrow peak at a pore
430 diameter of 40 Å was observed, which is five times higher in T1-1 than in T2-4. Moreover, a relatively
431 large number of mesopores of pore diameter 50-500 Å was found in T1-1 compared to T2-4.
432 Cumulatively, specimen T1-1 shows about 5.5 times higher presence of pore volume in the mesopores
433 range of pore diameter 25-250 Å than T2-4 (Fig. 12 (b)).

434 Thus, this higher number of mesopores development in T1-1 has led to the increased suction and
435 consequently resulted in greater strength in T1-1 than in T2-4.

436
437
438 *4.3. Long-term effect of lime treatment on the water content and pH distribution at the core of the*
439 *embankments*

440
441 The average water content measured at the end of construction was 17.0 % and 19.4 % in the
442 untreated and the lime-treated embankment, respectively. Thus, approximately a 5 % loss in water content
443 was observed from the end of construction up to a depth of about 0.35 m normal to the surface of the
444 untreated embankment (Fig. 6 (a)). This loss of water gradually decreases with depth. This was expected
445 in the untreated embankment. The maximum loss of water in the core of the lime-treated embankment was
446 about 2 % from the end of construction, comparatively lower than the untreated embankment.

447 Additionally, unlike the untreated embankment, the overall distribution of water content does not
448 vary significantly with depth in the lime-treated embankment (Fig. 6 (b-e)). Most of the core-sampled
449 specimens from the lime-treated embankment show water content ranging from 18.0 to 19.3 % (Fig. 6 (b-
450 e)). Thus, this distribution can be said to be homogeneous. This can be attributed to the proper mixing and
451 compaction process implemented during the construction time, as reported by Makki-Szymkiewicz et al.
452 (2015). Thus, the presence of this homogeneous water content throughout the embankment and the lesser
453 reduction in water content from the end of construction than the untreated embankment highlights the
454 long-term water retention capacity of the lime-treated soil.

455 Lime treatment increases the pH of the natural soil due to the release of OH⁻ ions in the soil-water-
456 lime medium (Little, 1995). On evaluating the pH measured during deconstruction, the average pH
457 measured in the untreated embankment was 8.5 (Fig. 8 (a)), which was found to be almost equivalent to
458 the pH value of the present silty soil. However, all the lime-treated soil show pH greater than 11 (Fig. 8
459 (b-e)) and lower than 12.3, which corresponds to the pH at Lime Modification Optimum (LMO) of the
460 soil. This decrease in pH can be attributed to the consumption of lime during the curing time, as
461 demonstrated by De Bel et al. (2013). Besides, the difference measured in the pH level between the
462 untreated and lime-treated soil evidences the presence of pozzolanic products within the core of the lime-
463 treated embankment.

464 Like the homogenous distribution of water content observed throughout the core of the lime-
465 treated embankment, the pH, too, was found to be uniformly distributed throughout, ranging from 11.08 to
466 11.66 (Fig. 8 (b-e)). This can also be attributed to proper mixing, as mentioned previously.

467
468 *4.4. Effect of lime treatment on the evolution of suction at the core of the embankments*

469
470 Within the range of suction measured for the untreated embankment (0.19 MPa-1.14 MPa), a total
471 variation of around 1.00 MPa in suction corresponds to a 2 % (9.89 %-11.71 %) variation in water content
472 (Table 2). At the same time, this variation is around 2.50 MPa (0.17 MPa-2.71 MPa) for the lime-treated
473 soil corresponding to the same percentage difference in the water content (15.80 %-17.90 %). Thus, the
474 maximum suction measured for the lime-treated soil was about 1.57 MPa higher than the untreated soil,
475 although the corresponding water content in the lime-treated soil was about two times higher than the
476 untreated soil. The average minimum suction measured for the untreated specimens approximately
477 corresponds to the average maximum measured water content and vice versa (Table 2). This behaviour of
478 suction variation with water content was expected in the untreated specimens. While in the lime-treated
479 samples, the variation of suction was less affected by the difference in the water content level.

480 Makki-Szymkiewicz et al. (2015) reported a suction level of 0.051MPa to 0.084 MPa at about an
 481 average water content of 19.4 % in specimens collected up to 1 year from the end of construction in the
 482 same lime-treated embankment. Thus, the present measured suction range (0.17 MPa-2.71 MPa) in the
 483 lime-treated specimens increased by about 2 to 30 times with a maximum of 3 % difference in the level of
 484 water content (15.80-17.90 %) during the additional six years curing period. This can be attributed to the
 485 modification of the lime-treated soil microstructure illustrated by an additional generation of smaller pores
 486 (< 3000 Å) (Fig. 10 (c)) in the present specimen compared to the MIP result reported by Makki-
 487 Szymkiewicz et al. (2015) for the six months in-situ cured specimen.

488 Besides, the present variation of suction with respect to water content (Table 2) was also
 489 compared with the water retention plot provided by Nguyen et al. (2015) for the same soil and are
 490 presented in Fig. 13. Nguyen et al. (2015) showed the evolution of suction with respect to volumetric
 491 water content for 28 days (28d) and 90 days (90d) laboratory cured specimens treated with 2 % and 4 %
 492 quicklime.
 493
 494
 495

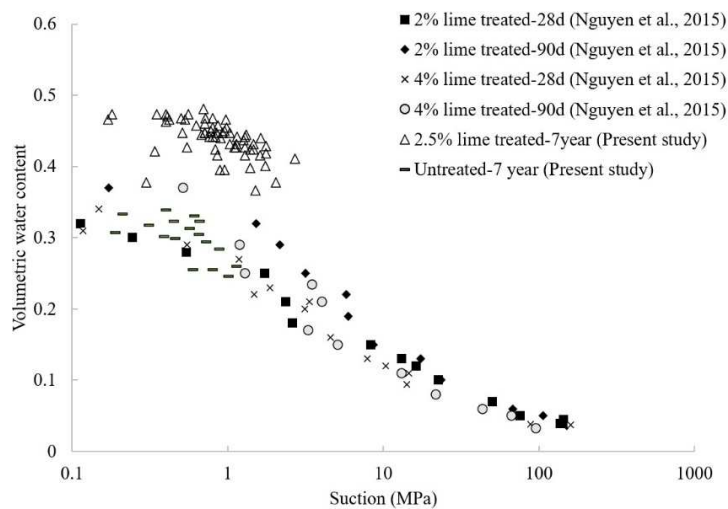

496
 497 **Fig. 13:** Water retention plot obtained from the present soil compared to the one obtained from Nguyen et al. (2015)

498
 499 Fig. 13 shows that the volumetric water content corresponding to the suction range of about 0.1 -
 500 5.0 MPa was slightly higher for 90 days cured specimens compared to the corresponding 28 days cured
 501 specimens. Similar evolution of volumetric water content was observed in the present untreated soil
 502 corresponding to the suction range of 0.19-1.14 MPa. However, the volumetric water content in the 7-year
 503 cured specimens was about 50 % higher compared to all the specimens from Nguyen et al. (2015),
 504 corresponding to a similar range of suction (0.17-2.71 MPa).

505 Thus, based on the above discussion, it can be concluded that the observed long-term water
 506 retention capacity of the present lime-treated soil was due to this increased suction because of long-term
 507 pozzolanic reactions. Literature, based on laboratory studies, has demonstrated how lime treatment
 508 improves the water retention capacity of soil with the increase in curing time due to the modification of
 509 soil microstructure resulting from the generation of cementitious compounds (Russo, 2005; Wang et al.,
 510 2016).

511 Thus, the overall suction variation in the untreated soil follows the variation in the water content
 512 level inversely. However, in the lime-treated soil, the evolution of suction was due to the development of
 513 smaller pores as a result of pozzolanic reactions and was less affected by the variation in the water content
 514 level.
 515

516 4.5. Effectiveness of lime treatment on the upper layer of the embankment submitted to atmospheric
517 exposure

518
519 The minimum water content measured in the upper-layer specimens of T1 and T2 was 7 % and 12
520 %, respectively (Fig. 7). This was about 12 % and 7 % less than the maximum water content measured in
521 the core of T1 and T2, respectively (Fig. 6 (b & c)). The increase in loss of water as one moves from the
522 core towards the upper layer emphasizes the effect of soil-atmosphere interaction. Besides, the
523 development of vegetation roots (as observed during deconstruction) also contributes towards this water
524 loss. Bicalho et al. (2018) and Rosone et al. (2018) reported a similar impact of soil-atmosphere
525 interaction on the upper surface of an in-situ cured lime-treated embankment. They showed a significant
526 loss of water from the surface to a depth of 0.45-0.75 m of the embankment. Thus, the present study
527 shows that the influence of soil-atmosphere interaction is significant up to a depth of 0.12 m normal to the
528 surface of the lime-treated embankment.

529 In addition to the loss of water, a maximum reduction in pH for T1 and T2 was observed to vary
530 from 11.66 (Fig. 8 (b & c)) in the core to 8 in the upper layer (Fig. 9). This might be a consequence of
531 carbonation (Xu et al., 2020) or dissolution of lime by leaching (Deneele et al., 2016; Khattab et al., 2007)
532 under the long-term exposure of soil to the atmosphere. In the upper layer, the average pH for T1 and T2
533 gradually increases from around 8 near the surface to 9 corresponding to the depth of 0.12 m. This
534 indicates that the atmospheric effects are minimised with depth.

535 Thus, it can be concluded that although the effect of lime treatment remains within the core of the
536 lime-treated embankment, it was lost up to a depth of 0.12 m normal to the surface.

537

538 4.6. Evaluation of pore structures measured between the untreated and the lime-treated soil

539 Unlike the MIP results of the untreated soil (Fig. 10 (a)), no significant macropores were found at
540 a pore diameter of 10^4 Å and 10^5 Å in the lime-treated specimens (Fig. 10 (c)). Instead, both samples T2-2
541 and T2-3 show the presence of smaller pores of diameter lower than 3000 Å (Fig. 10 (c)). Such smaller
542 pores formation due to lime treatment was also reported by Cuisinier et al. (2011). Additionally, in the
543 lime-treated soil, as per the BJH results, the observed development of mesopores in the range of pore
544 diameter 50 Å to 500 Å (Fig. 10 (g)) was more significant than that in the untreated soil (Fig. 10 (e)). The
545 narrow peak developed at the pore width of 40 Å for the lime-treated specimens (Fig. 10 (g)) was about
546 1.8 times higher than what was observed in the untreated samples (Fig. 10 (e)). In the untreated
547 specimens, this observed peak can be due to the presence of clay porosity (Bin et al., 2007; De Bel et al.,
548 2013). The increase in this peak for the lime-treated samples might be due to the combined presence of
549 clay porosity and cementitious bonding because of pozzolanic reactions.

550 The overall development of smaller pores in the lime-treated soil is attributed to the development
551 of pozzolanic products (C-S-H, C-A-S-H, C-A-H, etc.), and not due to carbonation, as both T2-2 and T2-3
552 exhibit pH greater than 11 (Fig. 8 (c)), while carbonation reactions lead to a decrease in pH below 9 (Xu et
553 al., 2020). Besides, the observed increase in smaller pores in the present 7-year cured specimens when
554 compared to that reported by Makki-Szymkiewicz et al. (2015) (as explained in section 4.4) underscores
555 the contribution of the pozzolanic reactions towards the development of smaller pores in the long-term.

556 Specimen Nat 1 (0.15 m) shows a higher number of macropores of pore width 10^5 Å and 19 %
557 greater cumulative pore volume than Nat 2 (0.45 m), as reported in section 3.4. This indicates that the
558 untreated specimen collected at a lower depth (0.15 m) exhibits more macropores than the one sampled
559 from a greater depth (0.45 m). Samples Nat 1 and Nat 2 were located within the 2nd and the 3rd layer of
560 compaction normal to the surface of the trench, respectively, in the untreated embankment (Fig. 2). Thus,
561 during the construction of the untreated embankment, the compaction effort achieved by Nat 2 in the 3rd
562 layer was higher than the one obtained by Nat 1 in the 2nd layer. Lipiec et al. (2012) and Mossadeghi-
563 Björklund et al. (2019) have demonstrated how an increase in compaction effort leads to a decrease in the
564 diameter of macropores with depths from the surface of the pavement. Thus, the presence of more
565 macropores in Nat 1 than Nat 2 can be partly due to this difference in the compaction effort achieved with

566 respect to depth during construction. In the lime-treated embankment, specimen T2-2, located at 0.30 m
 567 above T2-3 (Fig. 3), shows a 27 % lower pore volume than T2-3 as per the BJH results (Fig. 10 (h)).
 568 However, specimen T1-1 located 0.45 m above T2-4, shows 5.5 times greater pores volume in the same
 569 pore range (Fig. 12 (b)).

570 Thus, it can be said that the presence of macropores in the untreated specimens are affected by the
 571 sampling-depth of the embankment, while the formation of mesopores in the lime-treated samples under
 572 the lime effect remains less affected by the same.

573

574 4.7. Comparison between the volume of mesopores measured by MIP and BJH

575 The discussions in the preceding section show how lime treatment brings about the formation of
 576 pores smaller than 3000 Å in diameter, including mesopores. On comparing this formation of smaller
 577 pores detected using MIP (Fig. 10 (c)) and BJH (Fig. 10 (g)), it was observed that BJH results give a more
 578 precise distribution of intensities showing a narrow peak at 40 Å and a broad peak at 50-500 Å. This was
 579 missing in MIP results for the same specimens. Based on this observation, Table 3 is presented to show
 580 the percentage difference of cumulative pore volume in the mesopore range that can be accessed by both
 581 MIP and BJH methods. It includes specimens T2-2 and T2-3 in the pore range of mesopore diameter 60-
 582 250 Å (i.e., the intersection of the ranges accessible through MIP and BJH). Table 3 shows that the
 583 cumulative pore volume measured by BJH for T2-2 and T2-3, in the mesopore range (60-250 Å) was
 584 about 3.5 and 3.2 times higher than that measured by MIP, respectively.

585

586 **Table 3:**

587 Difference in pore volume measured in the mesopore range of pore diameter 60-250 Å by MIP and BJH methods

Sample name	Total V_{cum}^1 measured by MIP (60-3.5 × 10 ⁶ Å) (cm ³ /g)	Total V_{cum} measured by BJH (25-250 Å) (cm ³ /g)	V_{cum} measured by MIP (60-250 Å) (cm ³ /g)	V_{cum} measured by BJH (60-250 Å) (cm ³ /g)	Calculated V_{cum} (60-250 Å) as a percentage of total measured by MIP (%)	Calculated V_{cum} (60-250 Å) as a percentage of total measured by BJH (%)
T2-2 (0.15 m)	0.160	0.013	0.029	0.010	17.8	81.0
T2-3 (0.45 m)	0.200	0.018	0.040	0.015	19.8	84.0

588

¹ V_{cum} : cumulative pore volume

589 These results, thus, show the effectiveness of the BJH method in quantifying the mesopores
 590 formed under long-term lime effect.

591

592

593 4.8. Long-term effect of lime treatment on the SSA

594 Lime treatment is known to decrease the SSA of highly expansive soil based on laboratory
 595 investigations (Bhuvaneshwari et al., 2014; Cherian and Arnepalli, 2015). So far, the long-term effect of
 596 lime treatment on the SSA of lime-treated low plastic soil, such as silty soil, remains less investigated.

597 De Bel et al. (2013) conducted SSA by BET of the present MLD soil and stated that 3 % quick
 598 lime-treated MLD soil shows a decrease in SSA from 23.0 m²/g to 13.3 m²/g after 7 days of curing. At the
 599 same time, this SSA value rises to 21.6 m²/g after 400 days of curing at a laboratory scale. The former
 600 behaviour was attributed to the flocculation effect, while the latter to the formation of pozzolanic products
 601 (CSH and CAH). Considering this, it can be derived that the uneven distribution of SSA, as reported in
 602 Fig. 11 (b-e), could be linked to the development of cementitious compounds in the different specimens
 603 sampled at varying depths throughout the lime-treated embankment. As the evolution of cementitious

604 compounds leads to the formation of mesopores, the correlation between the range of mesopores
 605 generation and the evolution of SSA was evaluated by BJH.

606 Using BJH data, the percentage of cumulative pore volume present in the pore diameter range 25-
 607 250 Å was evaluated for specimens showing the maximum (T1-1 = 45 m²/g), the intermediate (T1-6 = 25
 608 m²/g), and the minimum (T3-7 = 11 m²/g) SSA values. Fig. 14 (a) presents the percentage of pore volume
 609 for specimens over the range of pore diameter 25-250 Å at 25 Å intervals. It was observed that T1-1
 610 shows about 11 % and 30 % higher pore volume in the range of pore diameter 25-75 Å than T1-6 and T3-
 611 7, respectively. T1-6 shows about 19 % higher pore volume in the same pore range than T3-7. For the
 612 remaining range of pore diameter (75-250 Å), the pore volume was observed to increase for T3-7, while it
 613 decreased more for T1-1 than T1-6. This indicates that the specimen with maximum SSA shows the
 614 presence of more pores of pore diameter 25-75 Å and vice versa.
 615

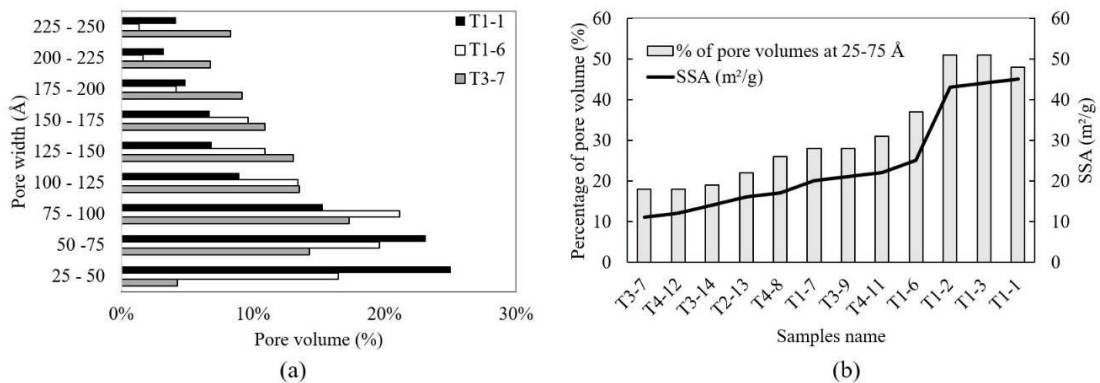

616
 617 **Fig. 14:** Evolution of SSA with respect to the presence of pore volume in the mesopore range of pore diameter 25-75 Å
 618

619 Based on this observation, the SSA of a few selected lime-treated specimens was plotted with
 620 respect to the evolution of pore volume in the range of pore diameter 25-75 Å (Fig. 14 (b)). An increase in
 621 the trend of pore volume was observed with the gradual rise in SSA. It can thus be derived that there exists
 622 an apparent correlation between the two quantities.
 623

624 4. Conclusions

625
 626 The long-term effect of lime treatment on a silty soil embankment was evaluated in terms of
 627 mechanical, physicochemical, and microstructural properties after 7 years of atmospheric exposure in a
 628 wet climate. The evaluation was made by undergoing laboratory investigations using several specimens
 629 gathered in the upper layer as well as throughout the core of the embankment. Based on the study, the
 630 following conclusions are derived:

- 631 1. An average UCS level of 3.29 MPa was obtained from the in-situ cured lime-treated specimens.
 632 Comparison of this UCS level with the UCS obtained from the accelerated-cured sample (at 40°C
 633 after 90 days) at laboratory scale confirms that such UCS level can be expected from the in-situ
 634 cured specimens after 7 years of curing.
- 635 2. SEM images evidenced the presence of cementitious bonding formed because of pozzolanic
 636 reactions under the lime effect in the core-sampled specimens of the lime-treated embankment.
- 637 3. The lime effect persists throughout the core of the lime-treated embankment as the pH
 638 measurement was greater than 11 despite 7 years of curing in a region that receives significant
 639 rainfall throughout the year.

- 640 4. A maximum loss of 12 % and 18 % in the water content and pH, respectively, was observed in the
641 upper layer-sampled specimens compared to the core-sampled specimens. This shows that the
642 effect of lime was lost in the upper layer of the lime-treated embankment due to long-term
643 exposure of the soil to the atmosphere and due to the development of vegetation roots.
- 644 5. The relevance of the combined MIP- and BJH-pore structure analysis is shown by their efficiency
645 in representing the complete range of macropores and mesopores affected by lime-treatment. MIP
646 highlights the reduction in macropores (10^4 - 10^5 Å) and an increase in the number of smaller pores
647 (< 3000 Å) in the lime-treated soil when compared to the untreated soil. Simultaneously, BJH
648 shows the formation of mesopores (50-500 Å) in the lime-treated specimens, which was missing
649 in the untreated soil. BJH method happens to define the evolution of mesopores under the lime
650 effect more precisely than MIP.
- 651 6. The formation of smaller pores enhances the evolution of suction in the lime-treated core-sampled
652 soil when compared to the untreated soil. This has led to a lower reduction in the water content
653 during this 7-year curing period, and the distribution of water content remains less affected by
654 depth. Thus, lime treatment improves the long-term water retention capacity of the soil.
- 655 7. The formation of mesopores in lime-treated specimens was less affected by the depth of sampling
656 in the lime-treated embankment. These mesopores contribute to the evolution of strength and
657 SSA. An increase in mesopores results in increased strength, while the SSA was found to be
658 correlated to the presence of mesopores in the range of pore diameter 25-75 Å.

659
660 Thus, the study confirms the long-term persistence of the effect of lime within the core of a lime-
661 treated silty soil embankment even after its exposure to a damp climate for 7 years. Based on the
662 physicochemical and microstructural observations, a good and persistent mechanical performance was
663 evidenced to be achieved at a lime content of 2.5 %.

664

665 **Acknowledgements**

666

667 This work was financially supported by Association Nationale de la Recherche et de la
668 Technologie with grant N°2018/0219 and Lhoist Southern Europe with grant N°RP2-E18114. The authors
669 are very thankful to the research team of Université Gustave Eiffel, Lhoist Nivelles, and CEREMA Blois
670 for their great support in performing field sampling, laboratory experiments, and technical support.

671

672 **References**

673

- 674 Akula, P., Hariharan, N., Little, D.N., Lesueur, D., Herrier, G., 2020. Evaluating the Long-Term
675 Durability of Lime Treatment in Hydraulic Structures: Case Study on the Friant-Kern Canal.
676 Transportation Research Record 0361198120919404.
677 <https://doi.org/10.1177/0361198120919404>
- 678 Ali, H., Mohamed, M., 2019. Assessment of lime treatment of expansive clays with different mineralogy at
679 low and high temperatures. *Construction and Building Materials* 228, 116955.
680 <https://doi.org/10.1016/j.conbuildmat.2019.116955>
- 681
682 Al-Mukhtar, M., Khattab, S., Alcover, J.-F., 2012. Microstructure and geotechnical properties of lime-
683 treated expansive clayey soil. *Engineering geology* 139, 17–27.
684 <https://doi.org/10.1016/j.enggeo.2012.04.004>

685
686 ASTM-C42-77., 1978. Standard method of obtaining and testing drilled cores and sawed beams of
687 concrete. American Society for Testing and Materials, West Conshohocken, PA, USA.
688

689 ASTM, D2166., 2006. Standard test method for unconfined compressive strength of cohesive soil.
690 American Society for Testing and Materials, West Conshohocken, PA, USA.

691 ASTM, D2216., 2010. Standard test methods for laboratory determination of water (moisture) content of
692 soil and rock by mass. Annual Book of ASTM Standards.

693 Aufmuth, R.E., 1970. Strength and Durability of Stabilized Layers under Existing Pavements. Army
694 Construction Engineering Research Lab Champaign Ill.

695 Barrett, E.P., Joyner, L.G., Halenda, P.P., 1951. The determination of pore volume and area distributions
696 in porous substances. I. Computations from nitrogen isotherms. *Journal of the American Chemical*
697 *society* 73, 373–380. <https://doi.org/10.1021/ja01145a126>
698

699 Bell, F.G., 1996. Lime stabilization of clay minerals and soils. *Engineering geology* 42, 223–237.
700 [https://doi.org/10.1016/0013-7952\(96\)00028-2](https://doi.org/10.1016/0013-7952(96)00028-2)

701 Bhuvaneshwari, S., Robinson, R.G., Gandhi, S.R., 2014. Behaviour of lime treated cured expansive soil
702 composites. *Indian Geotechnical Journal* 44, 278–293. <https://doi.org/10.1007/s40098-013-0081-3>
703

704 Bicalho, K. v, Boussafir, Y., Cui, Y.-J., 2018. Performance of an instrumented embankment constructed
705 with lime-treated silty clay during four-years in the Northeast of France. *Transportation Geotechnics*
706 17, 100–116. <https://doi.org/10.1016/j.trgeo.2018.09.009>
707

708 Bin, S., Zhibin, L., Yi, C., Xiaoping, Z., 2007. Micropore structure of aggregates in treated soils. *Journal*
709 *of materials in civil engineering* 19, 99–104. [https://doi.org/10.1061/\(ASCE\)0899-1561\(2007\)19:1\(99\)](https://doi.org/10.1061/(ASCE)0899-1561(2007)19:1(99))
710
711

712 Brunauer, S., Emmett, P.H., Teller, E., 1938. Adsorption of gases in multimolecular layers. *Journal of the*
713 *American chemical society* 60, 309–319. <https://doi.org/10.1021/ja01269a023>

714 Cai, J., Hu, X., 2019. *Petrophysical Characterization and Fluids Transport in Unconventional Reservoirs.*
715 Elsevier.

716 Cardoso, R., das Neves, E.M., 2012. Hydro-mechanical characterization of lime-treated and untreated
717 marls used in a motorway embankment. *Engineering geology* 133, 76–84.
718 <https://doi.org/10.1016/j.enggeo.2012.02.014>

719 Cherian, C., Arnepalli, D.N., 2015. A critical appraisal of the role of clay mineralogy in lime stabilization.
720 *International Journal of Geosynthetics and Ground Engineering* 1, 8.
721 <https://doi.org/10.1007/s40891-015-0009-3>
722

723 Cui, H., Tang, W., Liu, W., Dong, Z., Xing, F., 2015. Experimental study on effects of CO2
724 concentrations on concrete carbonation and diffusion mechanisms. *Construction and Building*
725 *Materials* 93, 522–527. <https://doi.org/10.1016/j.conbuildmat.2015.06.007>

726 Cuisinier, O., Auriol, J.-C., le Borgne, T., Deneele, D., 2011. Microstructure and hydraulic conductivity of
727 a compacted lime-treated soil. *Engineering geology* 123, 187–193.
728 <https://doi.org/10.1016/j.enggeo.2011.07.010>

- 729 De Bel, R., Gomes Correia, A., Duvigneaud, P. H., Francois, B., Herrier, G., Verbrugge, J. C., 2013.
730 Evolution mécanique et physico-chimique à long terme d'un sol limoneux traité à la chaux.
731 In Colloque Ter DOUEST.
- 732 Deneele, D., le Runigo, B., Cui, Y.-J., Cuisinier, O., Ferber, V., 2016. Experimental assessment regarding
733 leaching of lime-treated silt. *Construction and Building Materials* 112, 1032–1040.
734 <https://doi.org/10.1016/j.conbuildmat.2016.03.015>
- 735 Dhar, S., Hussain, M., 2019. The strength and microstructural behavior of lime stabilized subgrade soil in
736 road construction. *International Journal of Geotechnical Engineering* 1–13.
737 <https://doi.org/10.1080/19386362.2019.1598623>
738
- 739 di Sante, M., 2019. On the Compaction Characteristics of Soil-Lime Mixtures. *Geotechnical and*
740 *Geological Engineering* 1–10. <https://doi.org/10.1007/s10706-019-01110-w>
741
- 742 Diamond, S., Kinter, E.B., 1965. Mechanisms of soil-lime stabilization. *Highway Research Record* 92,
743 83–102.
- 744 Herrier, G., Chevalier, C., Froumentin, M., Cuisinier, O., Bonelli, S., Fry, J.-J., 2012. Lime treated soil as
745 an erosion-resistant material for hydraulic earthen structures.
- 746 Hopkins, T.C., Beckham, T.L., Sun, C., 2007. Stockpiling Hydrated Lime-Soil Mixtures.
747 <http://dx.doi.org/10.13023/KTC.RR.2007.12>
- 748 Jha, A.K., Sivapullaiah, P. v, 2019. Lime Stabilization of Soil: A Physico-Chemical and Micro-
749 Mechanistic Perspective. *Indian Geotechnical Journal* 1–9. [https://doi.org/10.1007/s40098-019-](https://doi.org/10.1007/s40098-019-00371-9)
750 00371-9
751
- 752 Khattab, S.A., Al-Mukhtar, M., Fleureau, J.-M., 2007. Long-term stability characteristics of a lime-treated
753 plastic soil. *Journal of materials in civil engineering* 19, 358–366.
754 [https://doi.org/10.1061/\(ASCE\)0899-1561\(2007\)19:4\(358\)](https://doi.org/10.1061/(ASCE)0899-1561(2007)19:4(358))
- 755 Knodel, P.C., 1987. Lime in canal and dam stabilization, US Bureau of Reclamation. Report No GR-87-
756 10, 21p.
- 757 Lemaire, K., Deneele, D., Bonnet, S., Legret, M., 2013. Effects of lime and cement treatment on the
758 physicochemical, microstructural and mechanical characteristics of a plastic silt. *Engineering*
759 *Geology* 166, 255–261. <https://doi.org/10.1016/j.enggeo.2013.09.012>
- 760 le Runigo, B., Cuisinier, O., Cui, Y.-J., Ferber, V., Deneele, D., 2009. Impact of initial state on the fabric
761 and permeability of a lime-treated silt under long-term leaching. *Canadian Geotechnical Journal* 46,
762 1243–1257. <https://doi.org/10.1139/T09-061>
763
- 764 Lipiec, J., Hajnos, M., Świeboda, R., 2012. Estimating effects of compaction on pore size distribution of
765 soil aggregates by mercury porosimeter. *Geoderma* 179, 20–27.
766 <https://doi.org/10.1016/j.geoderma.2012.02.014>
- 767 Little, D.N., 1995. Stabilization of pavement subgrades and base courses with lime.
- 768 Makki-Szymkiewicz, L., Hibouche, A., Taibi, S., Herrier, G., Lesueur, D., Fleureau, J.-M., 2015.
769 Evolution of the properties of lime-treated silty soil in a small experimental embankment.
770 *Engineering Geology* 191, 8–22. <https://doi.org/10.1016/j.enggeo.2015.03.008>

- 771 Nguyen, T. T. H., Cui, Y. J., Herrier, G., Tang, A. M., 2015. Effect of lime treatment on the hydraulic
772 conductivity of a silty soil. *Geotechnical Engineering for Infrastructure and Development*.
- 773 McDonald, E.B., 1969. Lime Research Study, South Dakota Interstate Routes:(sixteen Projects). South
774 Dakota Department of Highways, Materials and Soils Section.
- 775 Mossadeghi-Björklund, M., Jarvis, N., Larsbo, M., Forkman, J., Keller, T., 2019. Effects of compaction
776 on soil hydraulic properties, penetration resistance and water flow patterns at the soil profile scale.
777 *Soil Use and Management* 35, 367–377. <https://doi.org/10.1111/sum.12481>
- 778 Osula, D.O.A., 1996. A comparative evaluation of cement and lime modification of laterite. *Engineering*
779 *geology* 42, 71–81. [https://doi.org/10.1016/0013-7952\(95\)00067-4](https://doi.org/10.1016/0013-7952(95)00067-4)
- 780 Rosone, M., Ferrari, A., Celauro, C., 2018. On the hydro-mechanical behaviour of a lime-treated
781 embankment during wetting and drying cycles. *Geomechanics for Energy and the Environment* 14,
782 48–60. <https://doi.org/10.1016/j.gete.2017.11.001>
- 783 Rouquerol, J., D. Avnir, C. W. Fairbridge, D. H. Everett, J. M. Haynes, N. Pernicone, J. D. F. Ramsay, K.
784 S. W. Sing, K. K. Unger., 1994. Recommendations for the characterization of porous solids
785 (Technical Report). *Pure and Applied Chemistry* 66, no. 8: 1739-1758.
- 786 Russo, G., 2005. Water retention curves of lime stabilised soil. *Advanced experimental unsaturated soil*
787 *mechanics* 391–396.
- 788 Verbrugge, J.-C., de Bel, R., Correia, A.G., Duvigneaud, P.-H., Herrier, G., 2011. Strength and micro
789 observations on a lime treated silty soil, in: *Road Materials and New Innovations in Pavement*
790 *Engineering*. pp. 89–96. [https://doi.org/10.1061/47634\(413\)12](https://doi.org/10.1061/47634(413)12)
- 791
- 792 Wang, Y., Cui, Y.-J., Tang, A.M., Benahmed, N., 2016. Aggregate size effect on the water retention
793 properties of a lime-treated compacted silt during curing, in: *E3S Web of Conferences*. EDP
794 *Sciences*, p. 11013. <https://doi.org/10.1051/e3sconf/20160911013>
- 795 Webb, P.A., Orr, C., 1997. Analytical methods in fine particle technology. Micromeritics Instrument
796 Corp.
- 797 Xu, L., Zha, F., Liu, C., Kang, B., Liu, J., Yu, C., 2020. Experimental Investigation on Carbonation
798 Behavior in Lime-Stabilized Expansive Soil. *Advances in Civil Engineering*.
799 <https://doi.org/10.1155/2020/7865469>
- 800
- 801 Zhang, Y., Daniels, J.L., Cetin, B., Baucom, I.K., 2020. Effect of Temperature on pH, Conductivity, and
802 Strength of Lime-Stabilized Soil. *Journal of Materials in Civil Engineering* 32, 04019380.
803 [https://doi.org/10.1061/\(ASCE\)MT.1943-5533.0003062](https://doi.org/10.1061/(ASCE)MT.1943-5533.0003062)
- 804