



Quelques exemples d'analyses incluant la variable temporelle en psychologie :

des modèles latents aux network analysis

Yannick Morvan

*Maitre de Conférences,
Psychologue Clinicien*

Université Paris Nanterre, UFR SPSE, EA4430 CLIPSYD
Chercheur associé INSERM U1018, CESP
Institut de Psychiatrie - CNRS GDR 3557 de Psychiatrie



 ymorvan@parisnanterre.fr
 [@yannick_morvan](https://twitter.com/yannick_morvan)

THE SEM QUEST

Variables latentes = Analyse Factorielle

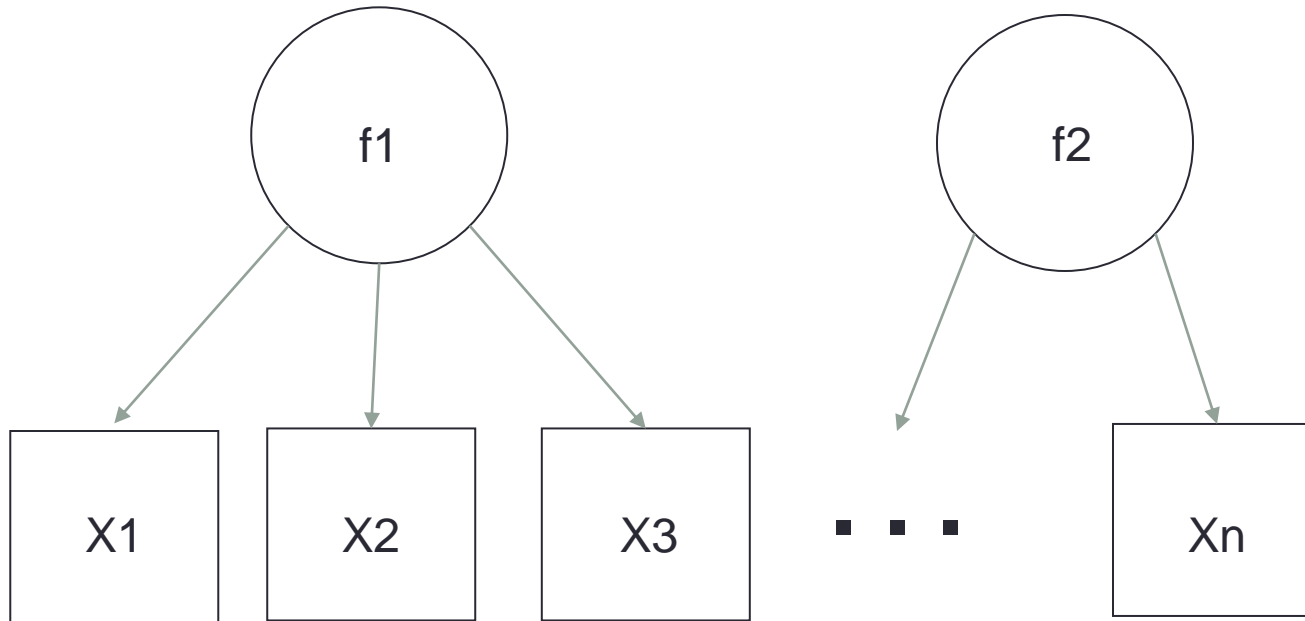

Terminologies

- En méthodologie expérimentale
 - Variable dépendante et indépendante
- Autres domaines
 - Variable explicatives (predictors) et variables à expliquer (outcomes)

Variable manifeste ou observée



X1

Variable latente (ou facteur)



f1

Terminologies

- Effet direct
regression $y=f(x)$



- Effets réciproques
regressions
 $y=f(x)$ et $x=f(y)$



- Correlation ou
covariance
 $Cov(x,y)$



**Categorical
Deteriorated Subtests (-1,96σ)
LCA WAIS 3 Classes**

Morvan et al. (2019)

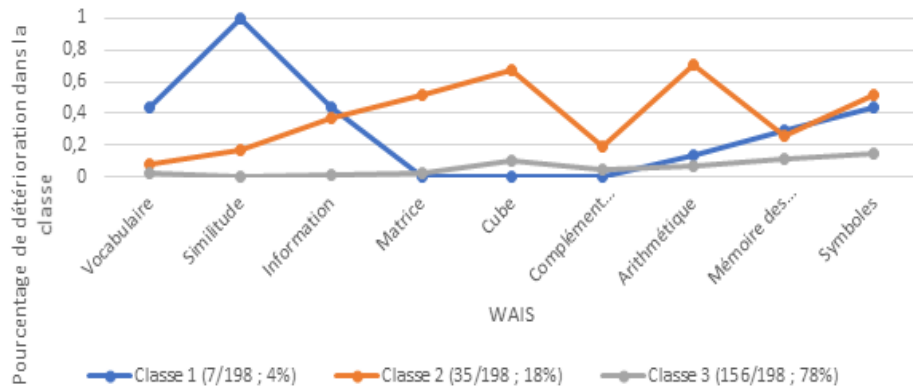

**Categorical
LCA WAIS
Explaining a « Distal Outcome »**

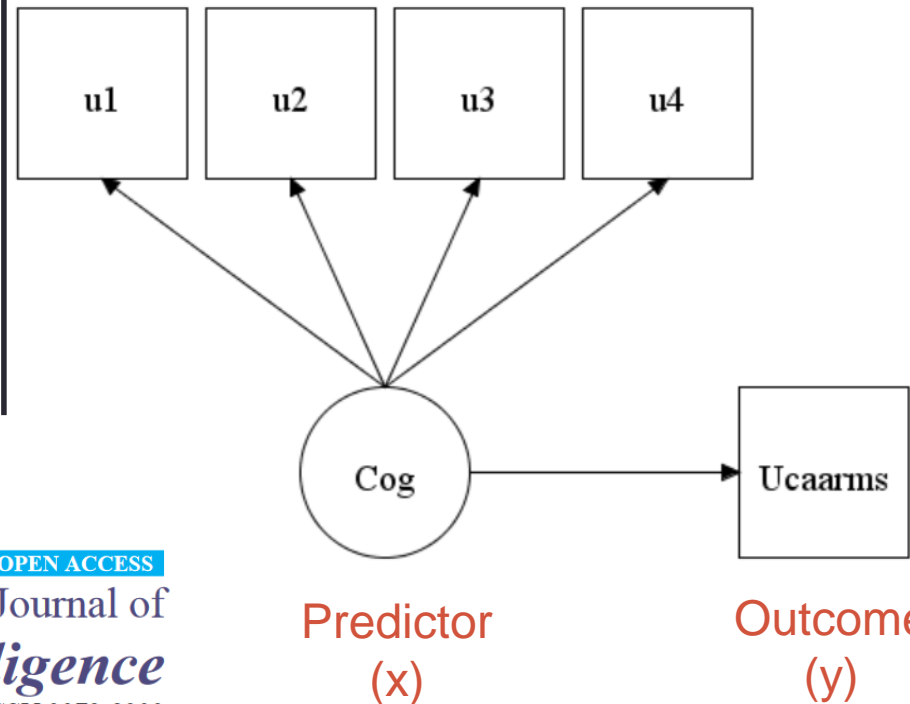

OPEN ACCESS

Journal of
Intelligence

ISSN 2079-3200

www.mdpi.com/journal/jintelligence

Asparouhov, T. & Muthén, B. Auxiliary Variables in Mixture Modeling: Three-Step Approaches Using Mplus. *Struct. Equ. Model. A Multidiscip. J.* **0**, 1–13 (2014).

J. Intell. **2014**, *2*, 12-15; doi:10.3390/jintelligence2010012

Comment

Intelligence Is What the Intelligence Test Measures. Seriously

Han L. J. van der Maas^{1,*}, Kees-Jan Kan² and Denny Borsboom¹

THE GROWTH QUEST

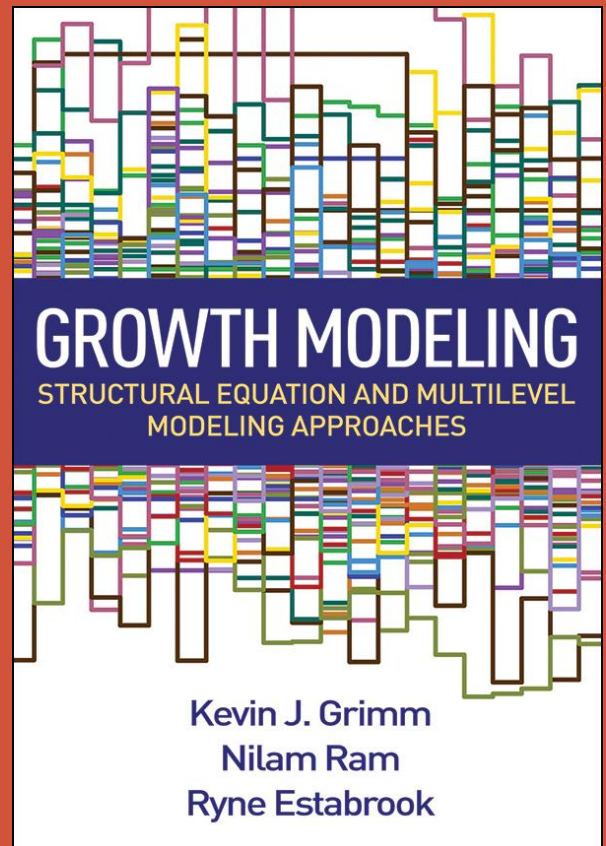

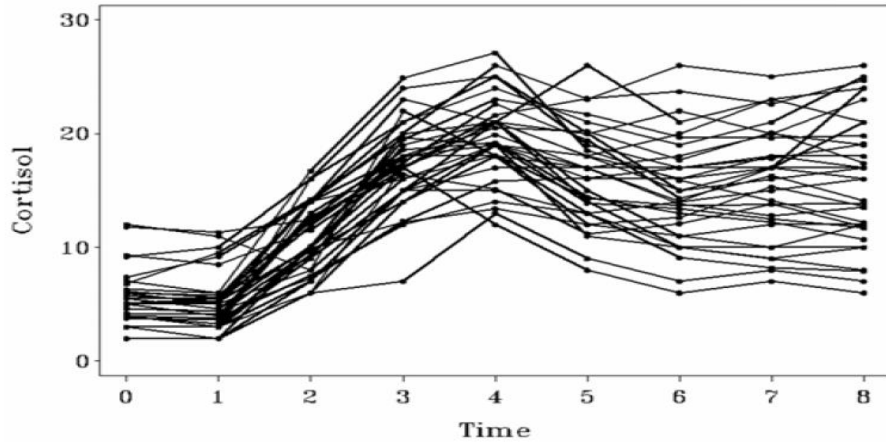
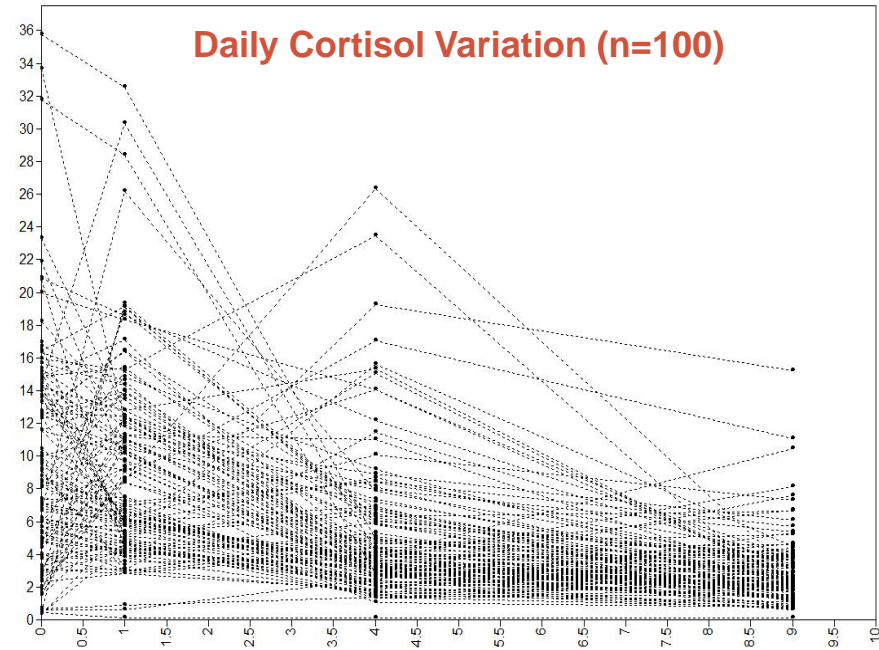

Figure 1. Raw data obtained from 34 individuals across nine occasions. Each individual is represented by a single line connecting their occasion to occasion levels of cortisol.

(Ram & Grimm, 2007)



Chaumette et al. (in prep)

Daily Cortisol Modelling

LGCM - Linear Growth

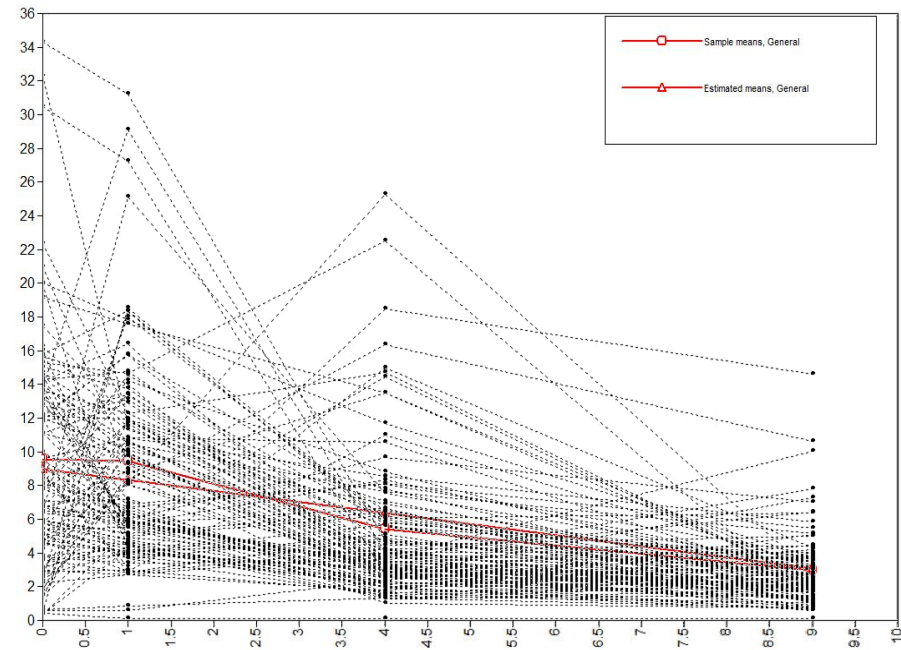
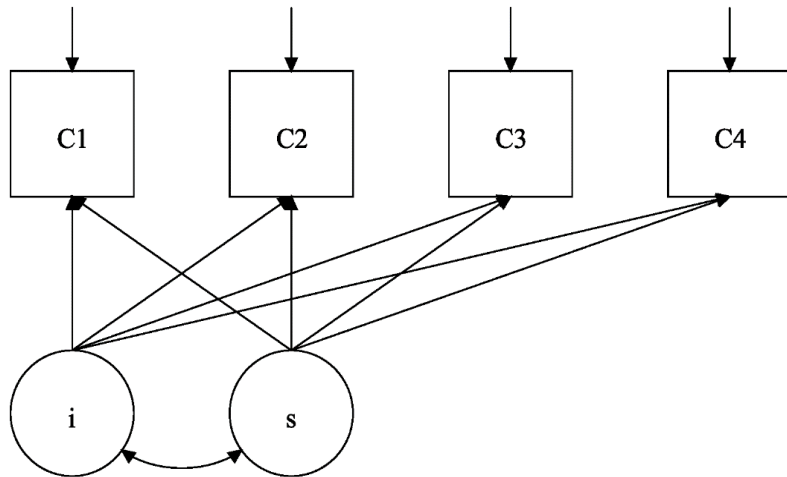

Daily Cortisol Modelling

LGCM - Linear Growth

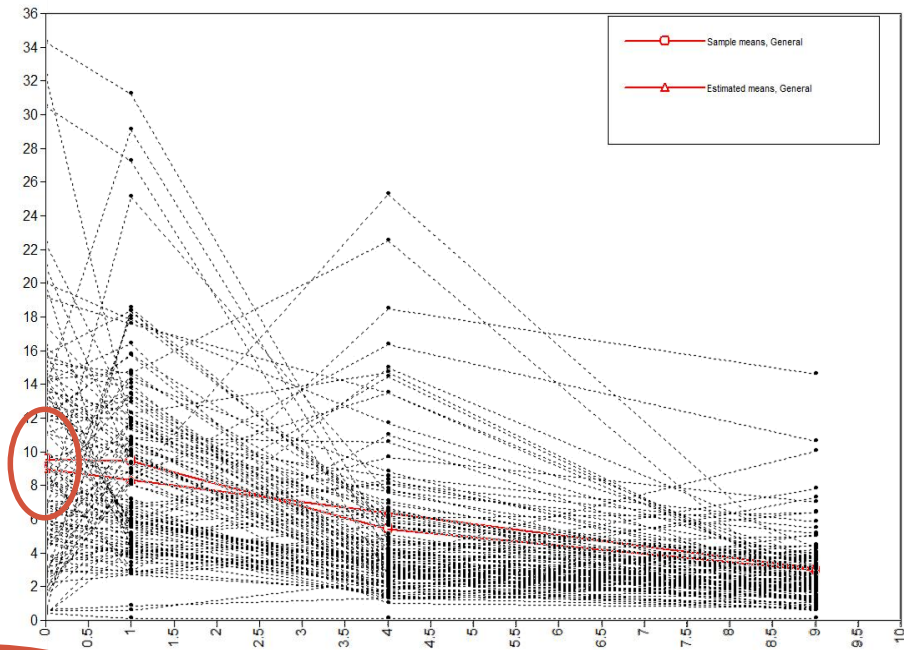
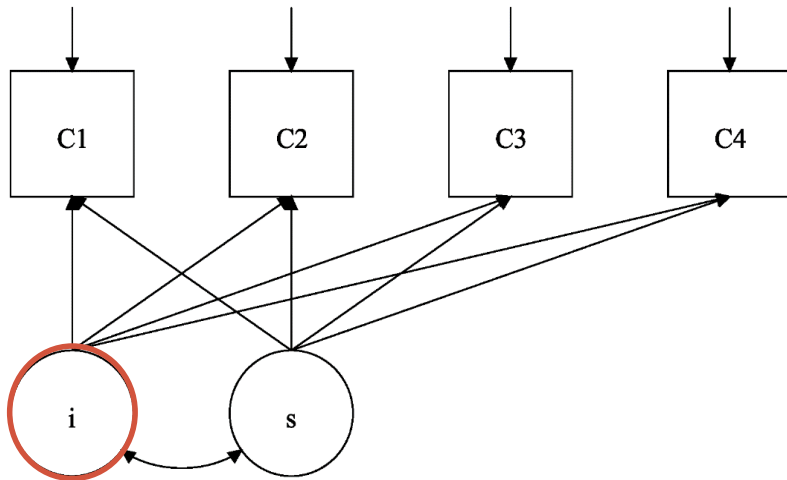

intercept ou
ordonnée à
l'origine

Daily Cortisol Modelling

LGCM - Linear Growth

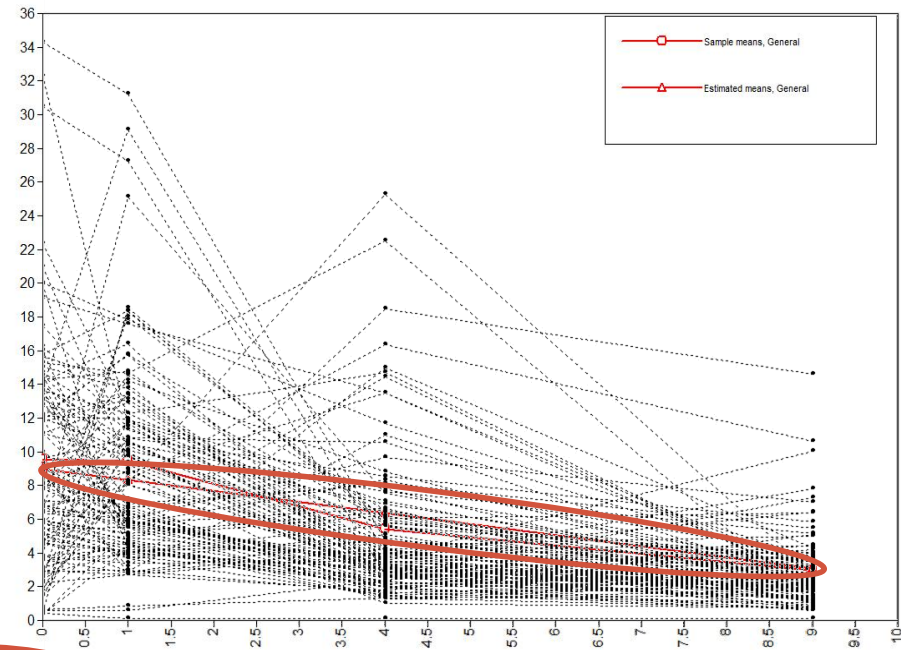
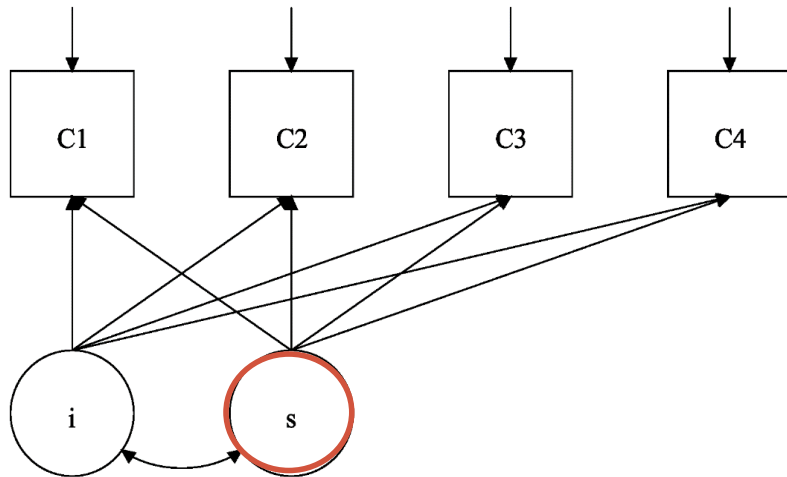

slope ou
coefficient
directeur

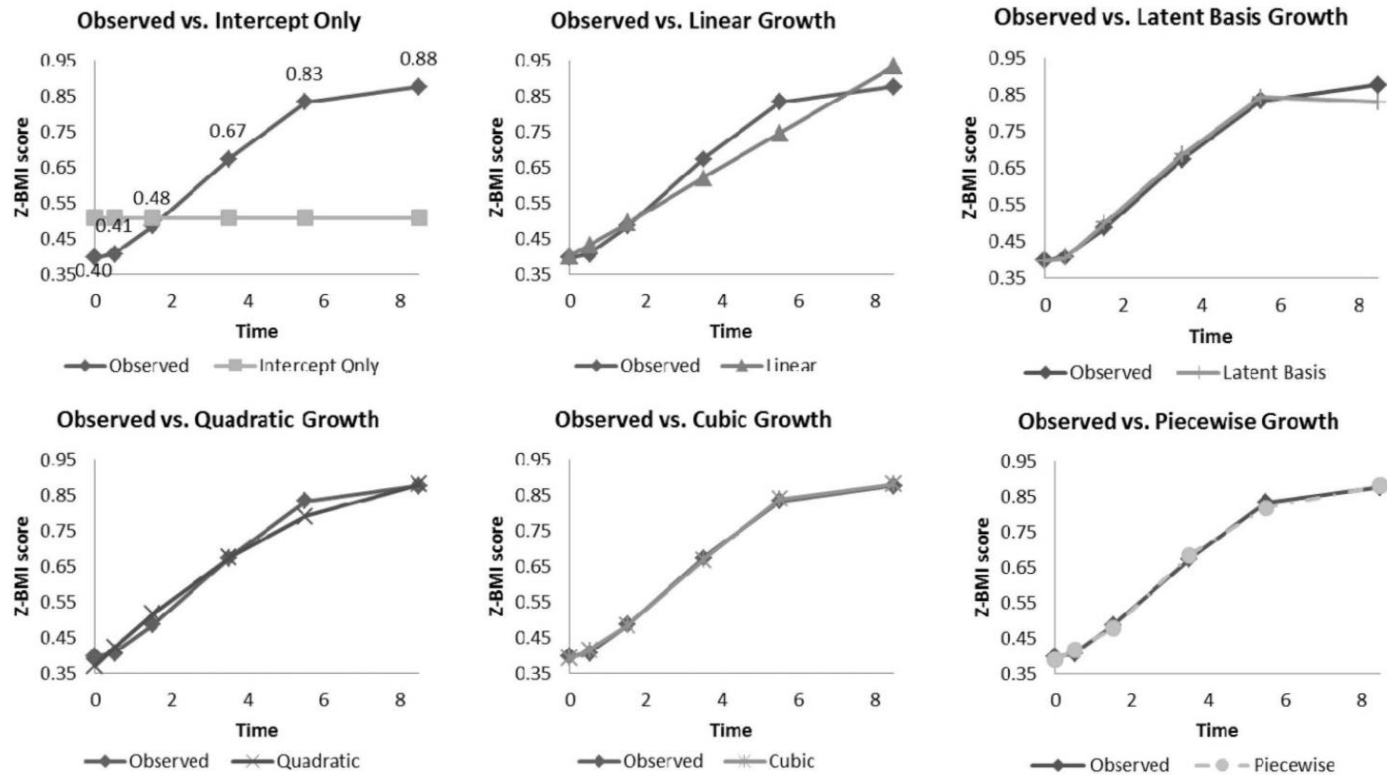

Table I. Fit Statistics for Single-Group (Nonmixture) Models. ($N_s = 2543$)

Model of Change	CFI	TLI	RMSEA	SRMR	χ^2	df	χ^2/df	AIC
Intercept	0.67	0.74	0.11	.14	554.78	19	29.20	23,334.88
Linear	0.93	0.93	0.05	.04	132.55	16	8.28	22,318.98
Quadratic ^a	0.99	0.99	0.02	.02	28.08	13	2.16	22,081.74
Cubic	0.99	0.99	0.02	.01	12.88	7	1.84	22,059.32
Piecewise Quadratic	0.997	0.994	0.02	.01	11.61	7	1.66	22,057.74
Latent Basis	0.96	0.95	0.05	.06	76.95	12	6.41	22,152.07

a. The residual variance for the sixth time point was fixed to .00001. CFI = Comparative Fix Index; TLI = Tucker-Lewis Index; RMSEA = Root Mean Square Error of Approximation. SRMR = Standardized Root Mean Square Residual. AIC = Akaike Information Criterion.

Growth Mixture Modeling

(Jung & Wickrama, 2007)

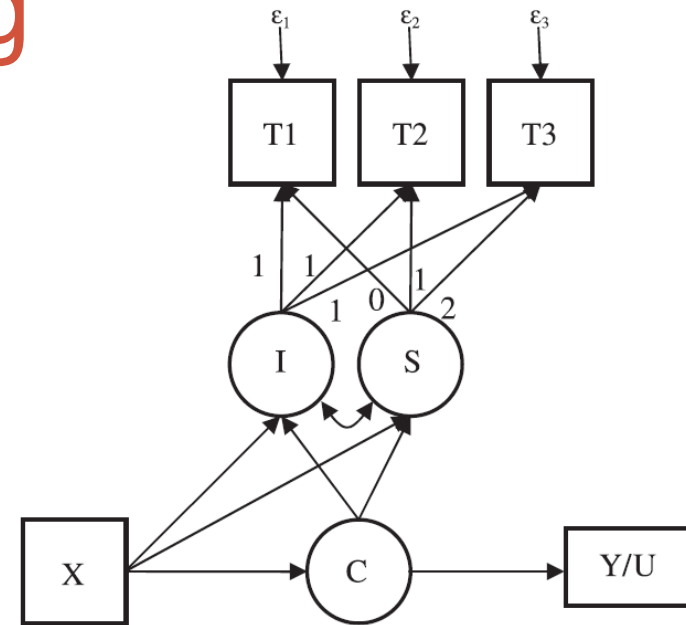
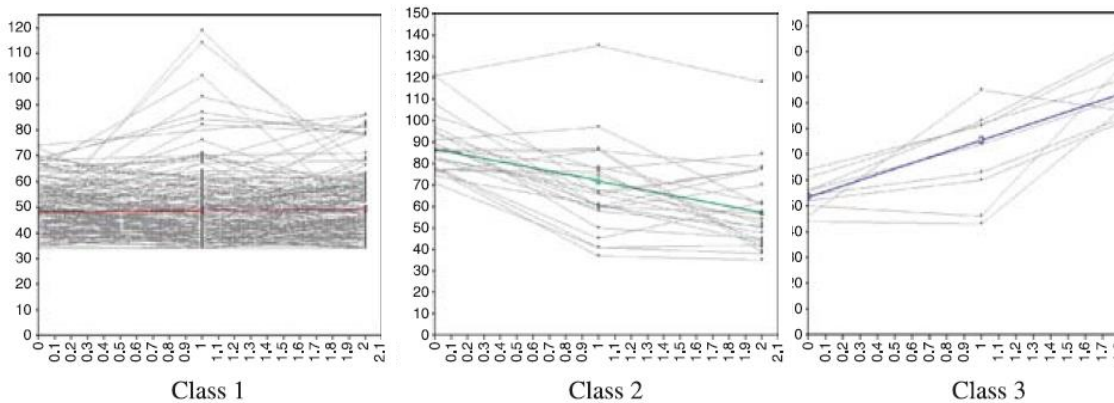

Representation of a growth mixture model with covariates.



Tweeter



Kevin M. King @KMKing_Psych · 4 déc.

I honestly can't wait for all the growth mixture modeling papers showing four types of changes in behavioral and mental health outcomes during the COVID pandemic:

A large "low stable", smaller "low increasing", "high decreasing", and "high stable" groups.

Science!

15

17

245



Recherche Twitter

Personnes pertinentes



Kevin M. King

@KMKing_Psych

Abonné

I study self control and quantitative methods because I would like to be better at both. Professor @UWPsychology He/him

THE NETWORK QUEST

People

Researchers located at the Psychological Methods group of the University of Amsterdam (project headquarters):

- [Denny Borsboom](#)
- [Lourens Waldorp](#)
- [Han van der Maas](#)
- [Sacha Epskamp](#)
- [Claudia van Borkulo](#)
- [Maarten Marsman](#)
- [Riet van Bork](#)
- [Jonas Dalege](#)
- [Jonas Haslbeck](#)

PSYCHOMETRIKA—VOL. 71, NO. 3, 425–440
SEPTEMBER 2006
DOI: 10.1007/s11336-006-1447-6



(Denny) Borsboom

PSYCHOMETRIKA—VOL. 71, NO. 3, 425–440
SEPTEMBER 2006
DOI: 10.1007/s11336-006-1447-6

THE ATTACK OF THE PSYCHOMETRICIANS

DENNY BORSBOOM

UNIVERSITY OF AMSTERDAM

This paper analyzes the theoretical, pragmatic, and substantive factors that have hampered the integration between psychology and psychometrics. Theoretical factors include the operationalist mode of thinking which is common throughout psychology, the dominance of classical test theory, and the use of “construct validity” as a catch-all category for a range of challenging psychometric problems. Pragmatic factors include the lack of interest in mathematically precise thinking in psychology, inadequate representation of psychometric modeling in major statistics programs, and insufficient mathematical training in the psychological curriculum. Substantive factors relate to the absence of psychological theories that are sufficiently strong to motivate the structure of psychometric models. Following the identification of these problems, a number of promising recent developments are discussed, and suggestions are made to further the integration of psychology and psychometrics.



What are psychological constructs? On the nature and statistical modelling of emotions, intelligence, personality traits and mental disorders

Eiko I. Fried

Department of Psychology, University of Amsterdam, Amsterdam, Netherlands

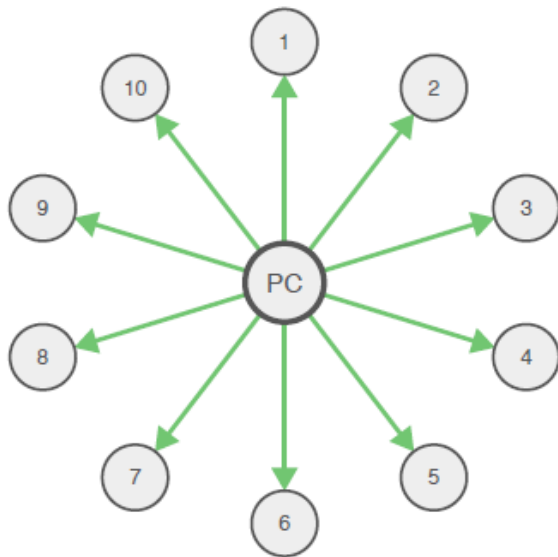

Reflective Model

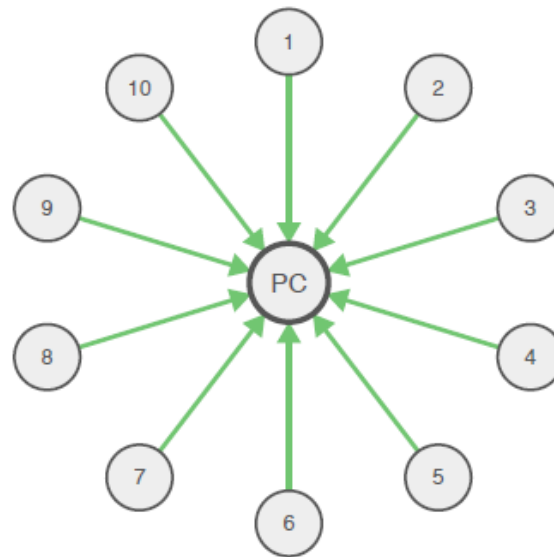

Formative Model

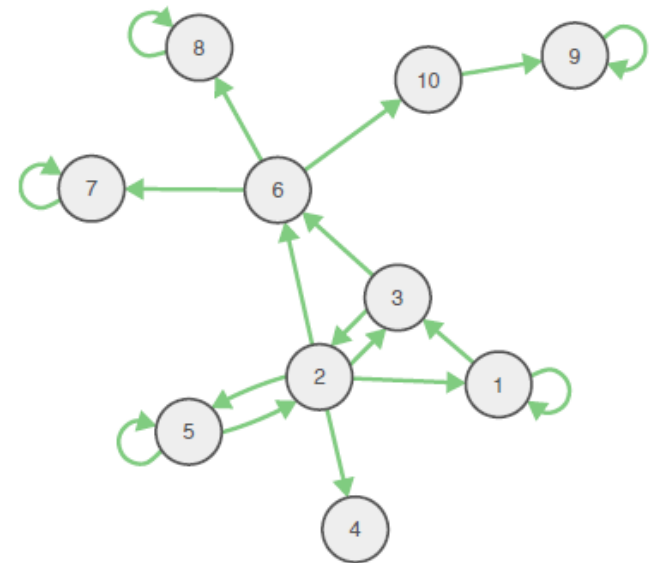

Network Model

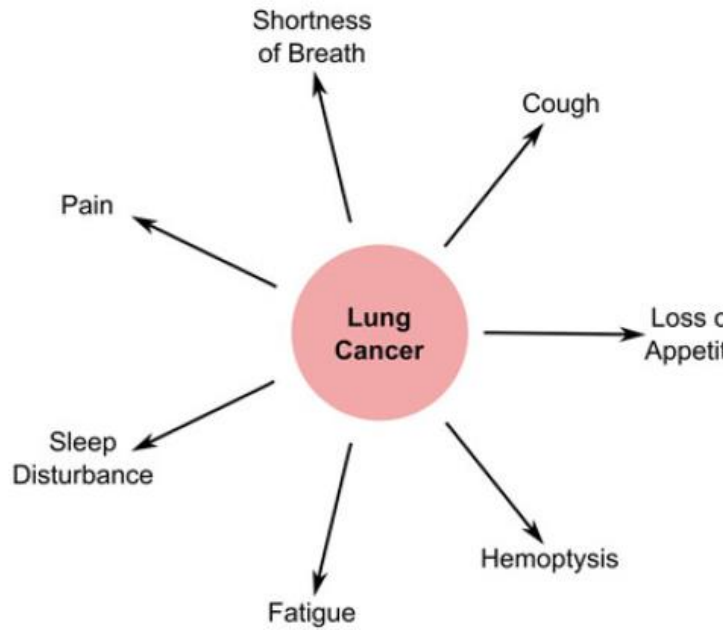

Fig. 1. Lung cancer, a distinct entity, is the origin of its signs and symptoms.

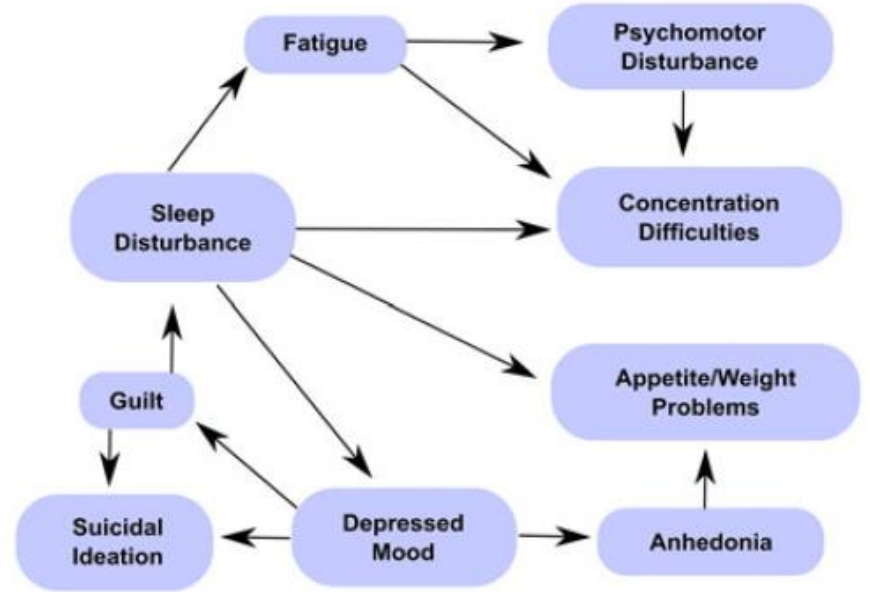

Fig. 2. Depression emerges from the dynamic interplay between signs and symptoms in a network.

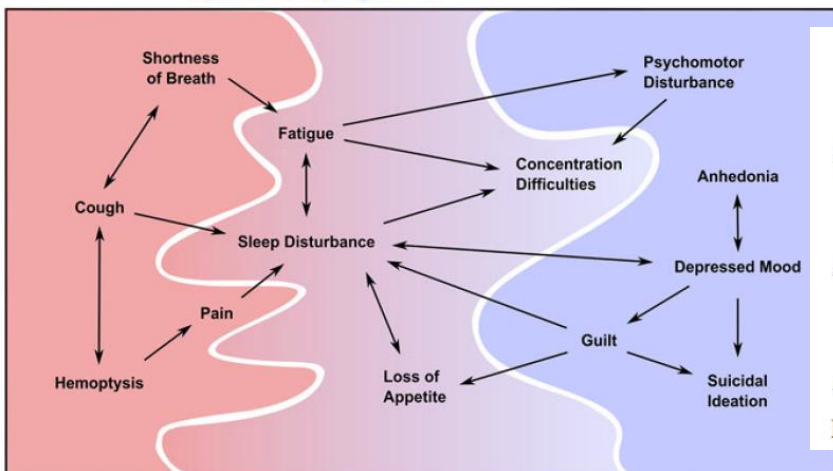

Fig. 4. The signs and symptoms of lung cancer (dark colour) progress and build a bridge (cytokine-induced sickness behavior) between symptom networks of lung cancer and depression (light colour).

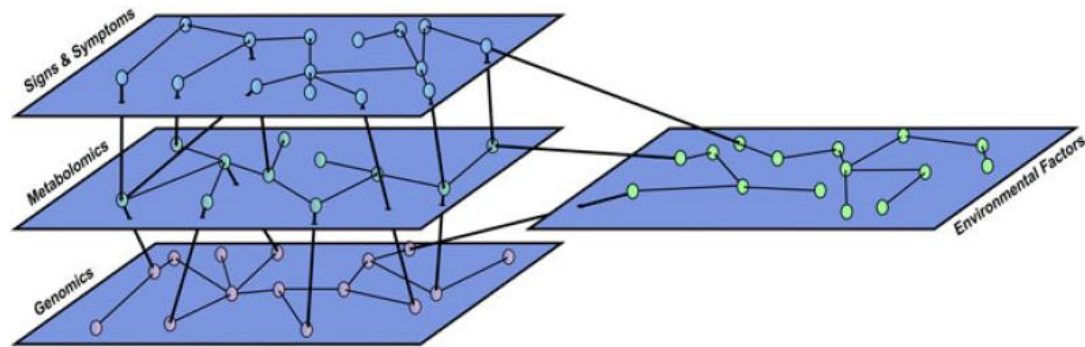

Fig. 3. A multilayered network diagram.

Cross-sectional Analysis

<http://sachaepskamp.com/files/NA2017/Week7Slides.pdf>



Sacha Epskamp
@SachaEpskamp

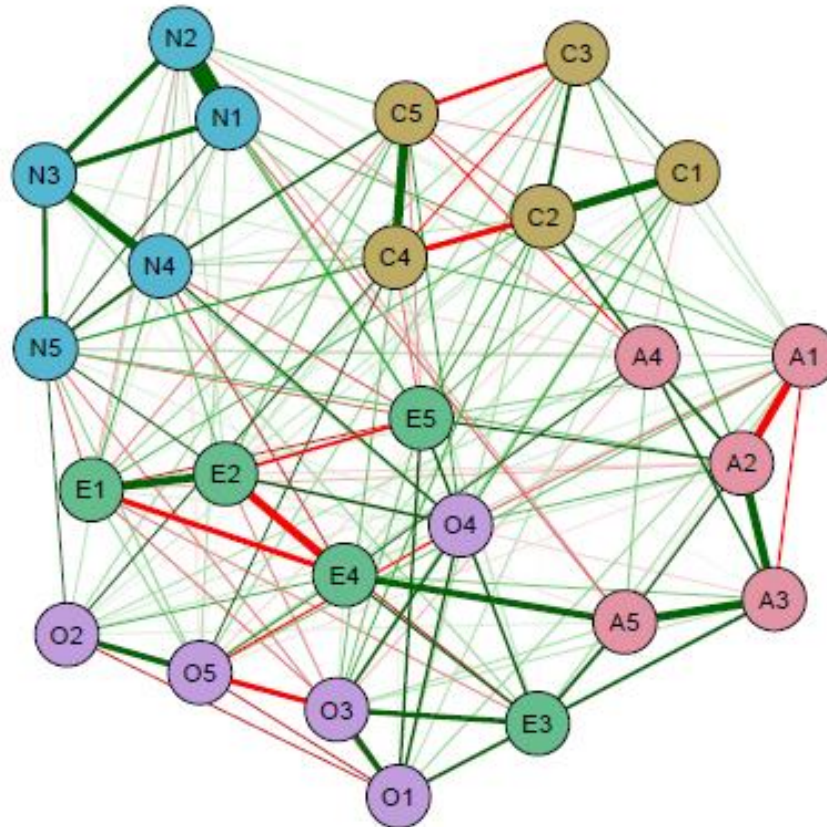

Agreeableness

- A1: Am indifferent to the feelings of others.
- A2: Inquire about others' well-being.
- A3: Know how to comfort others.
- A4: Love children.
- A5: Make people feel at ease.

Conscientiousness

- C1: Am exacting in my work.
- C2: Continue until everything is perfect.
- C3: Do things according to a plan.
- C4: Do things in a half-way manner.
- C5: Waste my time.

Extraversion

- E1: Don't talk a lot.
- E2: Find it difficult to approach others.
- E3: Know how to captivate people.
- E4: Make friends easily.
- E5: Take charge.

Neuroticism

- N1: Get angry easily.
- N2: Get irritated easily.
- N3: Have frequent mood swings.
- N4: Often feel blue.
- N5: Panic easily.

Openness

- O1: Am full of ideas.
- O2: Avoid difficult reading material.
- O3: Carry the conversation to a higher level.
- O4: Spend time reflecting on things.
- O5: Will not probe deeply into a subject.

- Concentration network: unique variance between two variables



Sacha Epskamp
@SachaEpskamp

$N = 1$ Time-series Analysis

(b) Temporal network – Patient 1

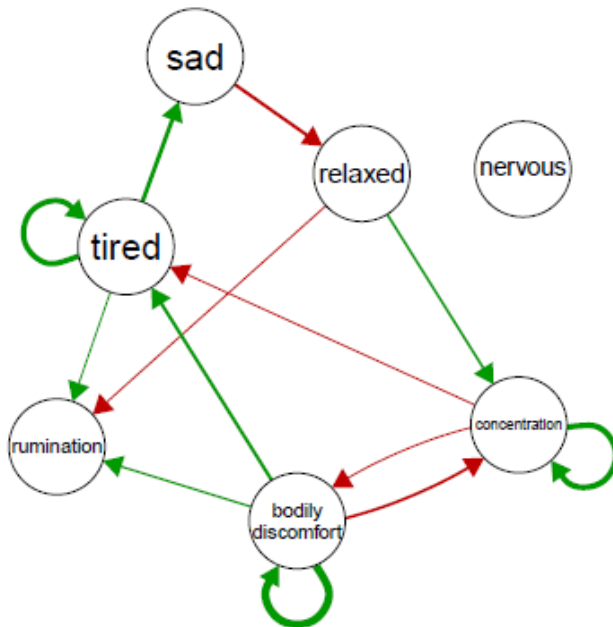

(a) Contemporaneous network – Patient 1

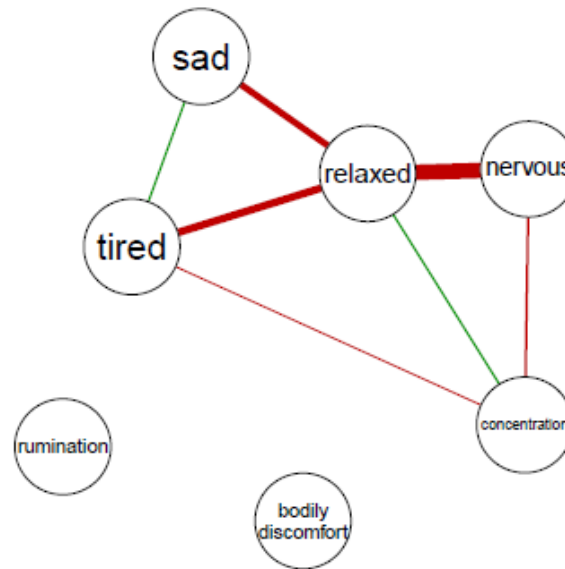

- Contemporaneous network: conditional concentration given $t - 1$
- Temporal network: regression coefficients between $t - 1$ and t



Sacha Epskamp
@SachaEpskamp

$N > 1$ Time-series Analysis

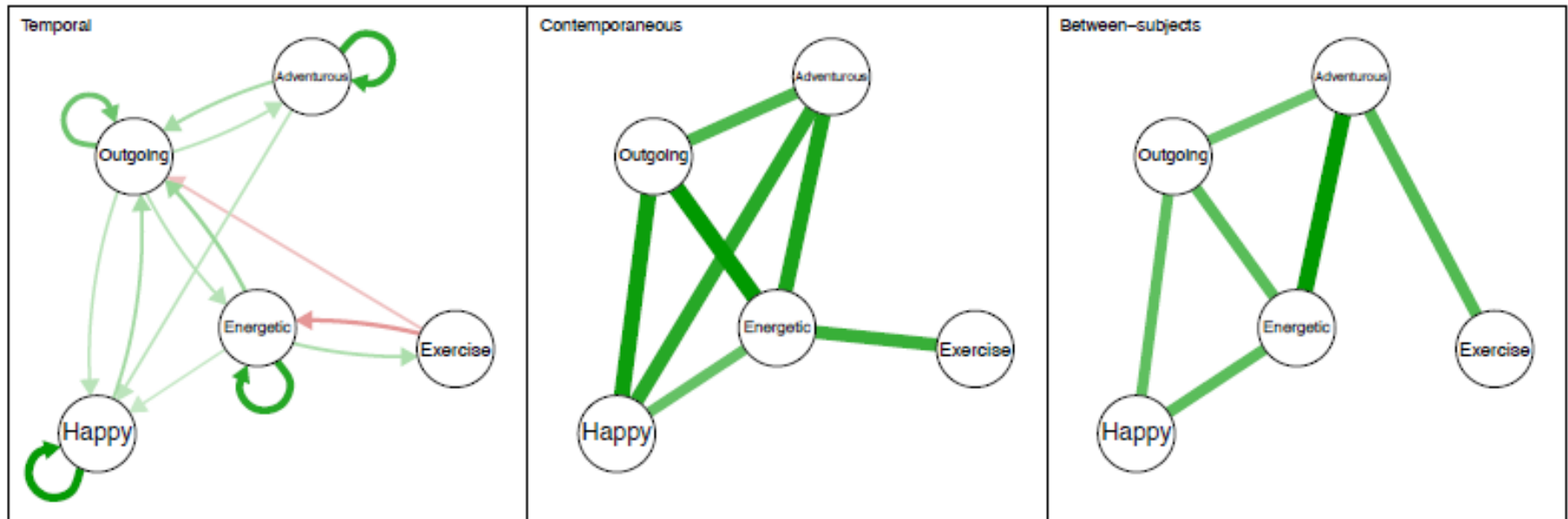

- Between-subjects network: concentration network between stationary means
- Two-step multilevel VAR

CONCRETE EXAMPLE ?

Research questions

1. Is the **intervention** an efficient way to reduce depression in relatives (with no control condition however) ?
2. If so, how does the **intervention** affect the system in the interplay between
 - knowledge of the relative's disorder (psychosis),
 - **the way they positively cope with their relatives** and
 - the **different kinds of worries they have** regarding their relative

Design : 2-3 waves

- 1) Program admission (-2 month **n=404**)
- 2) Beginning of the program (month 0 **n=397**)
- 3) End of the program (month 6 **n=319**)

listewise deletion 3 waves **n=302**



**Programme psycho éducatif pour
les familles ayant un proche
souffrant de schizophrénie**

Tableau 1

Variables mesurées dans le Module 1 du programme ProFamille. www.sciencedirect.com/science/article/pii/S0013700616302779

Variables	Outils	T1 (-2 mois)	T2 (0 mois)	T3 (+3 mois)	T4 (+6 mois)
<i>Pensées et émotions dominantes</i>					
Humeur dépressive	Echelle CES-D	X	X	X	X
Rumination, pensées négatives	Question binaire	X	X		X
Fréquence du souci personnel	Echelle de Lickert	X	X		X
Maîtrise du souci personnel	Echelle de Lickert	X	X		X
Agitation psychomotrice	Echelle visuelle analogique ^a	X	X		X
Fatigue psychomotrice	Echelle visuelle analogique ^a	X	X		X
<i>Connaissances</i>					
Connaissances sur la maladie	Questions binaires		X		X
<i>Stratégies de coping</i>					
Informé le proche malade sur sa pathologie	Echelle de Lickert		X		X
Capacité à faire des commentaires positifs	Echelle de Lickert		X		X
Maintien des relations sociales	Echelle de Lickert		X		X
Capacité à donner des limites au proche malade	Echelle de Lickert		X		X

CES-D : Center for Epidemiologic Studies - Depression Scale.

^a L'échelle visuelle analogique est représentée par un segment de 10 centimètres permettant de mesurer de 0 à 10 les variables « agitation psychomotrice » et « fatigue psychomotrice », 0 étant à considérer par le sujet comme un faible ressenti de la variable mesurée et 10 comme étant le plus fort ressenti de cette même variable.



Networks Summer School 2020

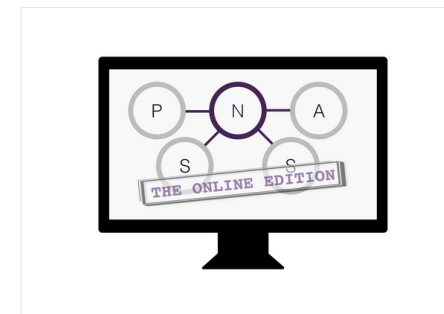

Psychological Networks Amsterdam Summer School 2020 – The online edition

	T2 pre mean (sd)	T4 Post mean (sd)	Mean diff (SE)	(Shapiro-Wilk) p	wilcoxon & t student p	(d cohen)
Dépression (CESD)	18,8 (10,0)	14,0 (8,5)	4,77 (0,52)	0,001	< ,001	0,51
Fréquence du souci	3,9 (2,2)	3,2 (1,9)	0,70 (0,14)	< ,001	< ,001	0,29
Maitrise du souci	4,1 (2,1)	3,6 (1,8)	0,52 (0,11)	< ,001	< ,001	0,26
Fatigue	4,3 (2,4)	3,8 (2,2)	0,54 (0,13)	< ,001	< ,001	0,23
Problème de concentration	3,4 (2,5)	3,0 (2,3)	0,43 (0,13)	< ,001	0,002	0,18
Agitation	2,9 (2,4)	2,4 (2,2)	0,55 (0,14)	< ,001	< ,001	0,23
Coping Inadapté	31,7 (9,5)	26,1 (9,1)	5,60 (0,44)	0,116	< ,001	0,70
Connaissances	86,4 (11,8)	111,7 (12,7)	-25,31 (0,76)	< ,001	< ,001	-1,87

Résultats qui restent À confirmer !!!



Network Profam T2

Network Profam T4

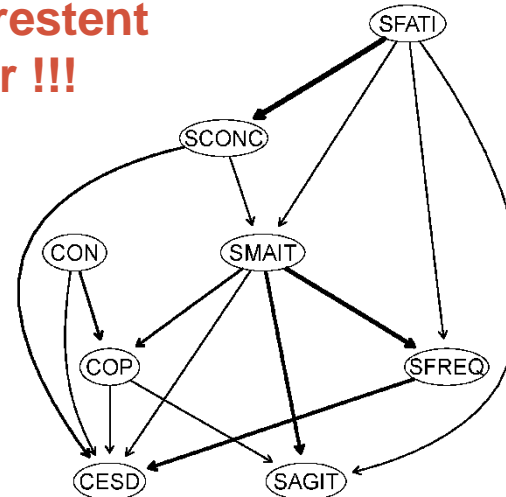
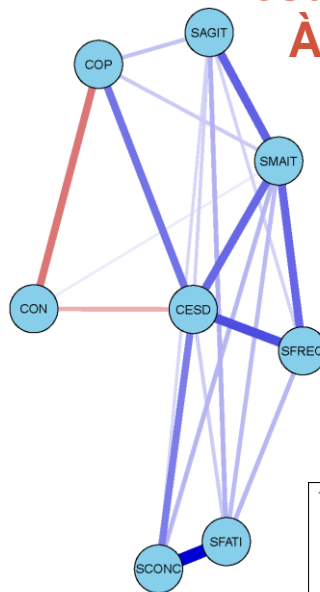
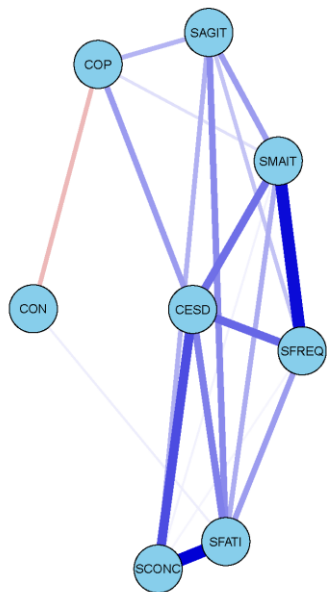

Pas de différence de structure ($p=0,052$) ou de connectivité globale entre ces deux réseaux ($p=0,948$), en revanche ils indiquent des différences de relations entre les variables connaissances et coping inadapté ($p<0,001$), fatigue liée aux soucis et dépression ($p=0,018$) et enfin entre fréquence des soucis et fatigue liée aux soucis ($p=0,034$).

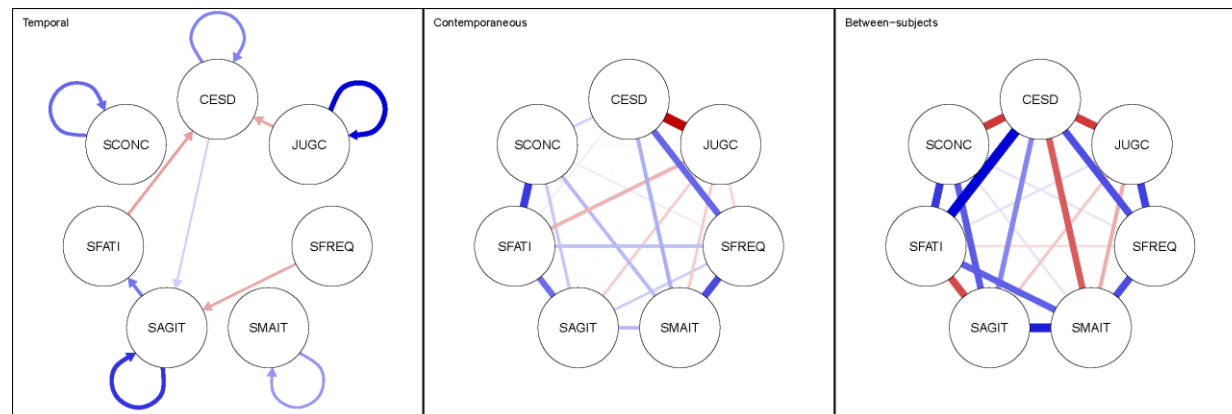

COMPLEXITY

Mais où allons-nous ?

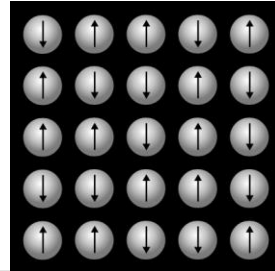

Heating up the measurement debate: What psychologists can learn from the history of physics

Laura F. Bringmann
University of Leuven

Markus I. Eronen*
University of Leuven

Theory & Psychology
2016, Vol. 26(1) 27–43
© The Author(s) 2015
Reprints and permissions:
sagepub.co.uk/journalsPermissions.nav
DOI: 10.1177/0959354315617253
tap.sagepub.com

nature index

[Home](#) [News](#) [Current Index](#) [Annual tables](#) [Supplements](#) [Client servi](#)

[Home](#) / [News](#) / Psychology looks to physics to solve replication crisis

[Share on Facebook](#) [Tweet this article](#)

Psychology looks to physics to solve replication crisis

Brian Nosek explains the potential for accelerating collaboration.

6 January 2020

Jon Brock

BMC Medicine

Fried and Robinaugh *BMC Medicine* (2020) 18:205
<https://doi.org/10.1186/s12916-020-01668-w>

EDITORIAL

Open Access

RESEARCH ARTICLE

Open Access

Systems all the way down: embracing complexity in mental health research

Eiko I. Fried^{1†} and Donald J. Robinaugh^{2†}



Bridging the gap between complexity science and clinical practice by formalizing idiographic theories: a computational model of functional analysis



Julian Burger^{1,2*}, Date C. van der Veen¹, Donald J. Robinaugh³, Rick Quax², Harriëtte Riese¹, Robert A. Schoevers¹ and Sacha Epskamp²

Dynamic Network Analysis Lecture <https://osf.io/z87g4/>

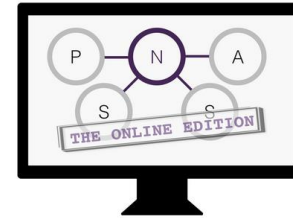

Julian Burger
University of Amsterdam
University Medical Center Groningen

Cross-sectional and time-series data

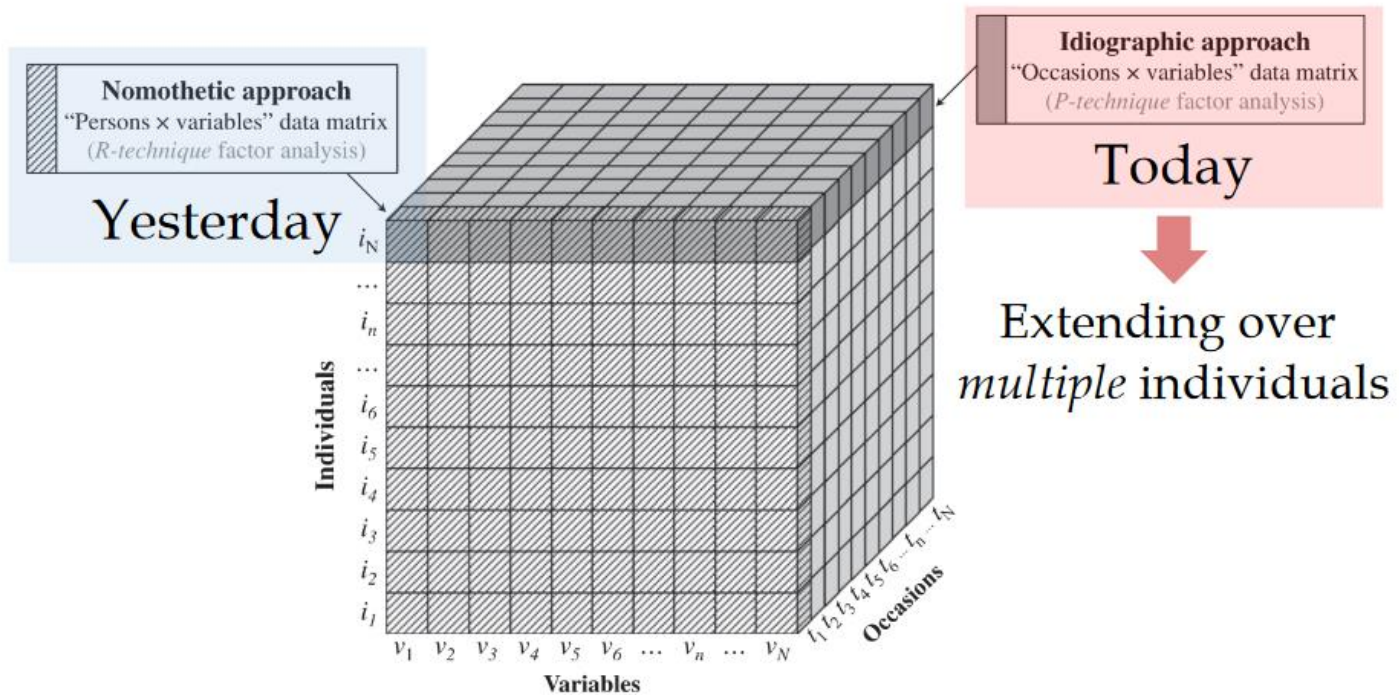

Ergodicité

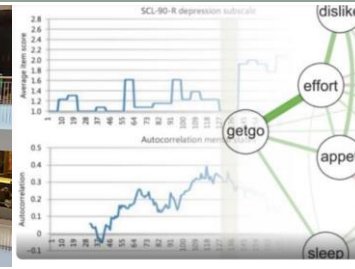

Psychological Dynamics
Groupe Public - 4,2 K membres



Ellen Hamaker
Full Professor at Utrecht University

- To be able to generalize from cross-sectional results to the level of the individual, we need ergodicity to hold.
- This implies that there are no real differences between individuals: If you would observe two (or more) people repeatedly over time, you would find they have the exact same mean, the same variance, the same autocorrelations, and the same covariances between variables.
- Of course this is extremely unlikely for most (all?) phenomena that we are interested in.
- One way to think about this question, is to assume that a cross-section is a snapshot of a lot of people, while these people are actually moving up and down all the time.
- If you would watch them for a longer period of time, you would be able to determine to what extent differences between them are transient (because they are moving up and down over time), and to what extent the differences are more permanent

<https://www.facebook.com/groups/PsychologicalDynamics/permalink/2752596784998366/>

Figure 2. Critical Slowing Down as an Early Warning Sign for Transition In Mental State

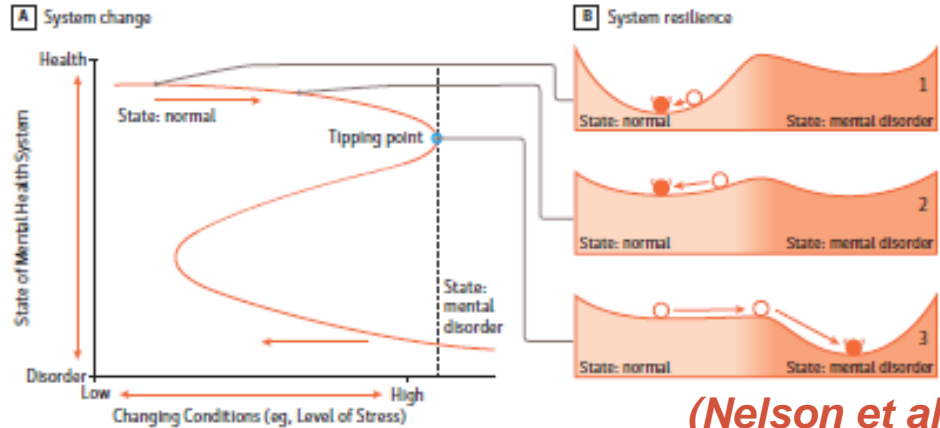

(Nelson et al., 2017)

A. The figure shows a system with 2 alternative states, a normal state and a mental disorder state. With changing conditions (eg. increased stress), the system is pushed toward a critical threshold (tipping point). The closer it gets to the tipping point, the less resilient it becomes. B. This principle of resilience can be represented using a ball-in-a-valley diagram. In 1, the valley is deep, and the system is resilient; after a perturbation, the ball will quickly return to its original position. In 2, the valley becomes shallower, demonstrating that the ball requires less perturbation to move to the alternative valley (to the right). The

increased shallowness also means that the ball will take more time to return to its original position after a perturbation (critical slowing down). In 3, the valley is even shallower, so a small perturbation (eg. an argument) was sufficient to push the ball beyond the threshold to the valley to the right and trigger a system change: the whole system transitioned to a different state (in this case, mental disorder). The A panel was adapted with permission from Scheffer et al.¹⁵ and the B panel was adapted with permission from Lenton.¹⁵

Equilibres instables non linéaires

The polarization within and across individuals: the hierarchical Ising opinion model

Posted on May 8, 2020 by Sacha Epskamp

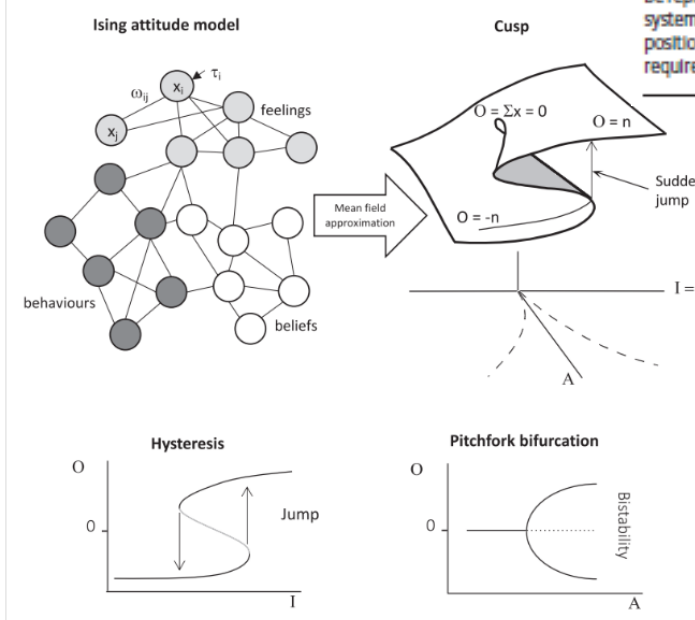

analogy of sudden switches in a simple business card.

(Van der Maas et al., 2017)

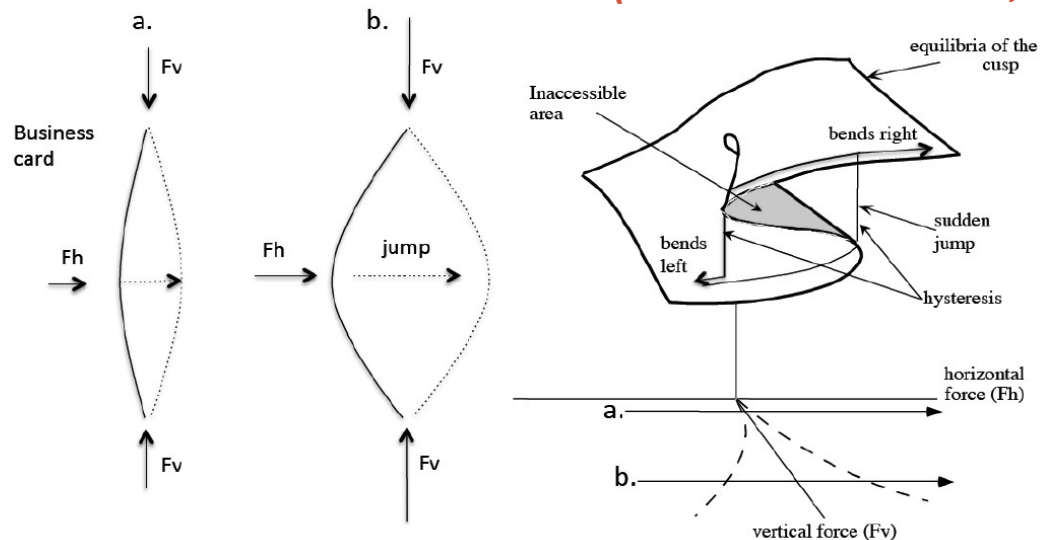

On May 7 2020 we published the paper 'The polarization within and across individuals the hierarchical Ising opinion model' in the Journal of Complex networks.

Différentes temporalités co-existent

Personality, Resilience, and Psychopathology: A Model for the Interaction between Slow and Fast Network Processes in the Context of Mental Health

GABRIELA LUNANSKY*, CLAUDIA VAN BORKULO and DENNY BORSBOOM
Department of Psychological Methods, University of Amsterdam, Amsterdam, The Netherlands

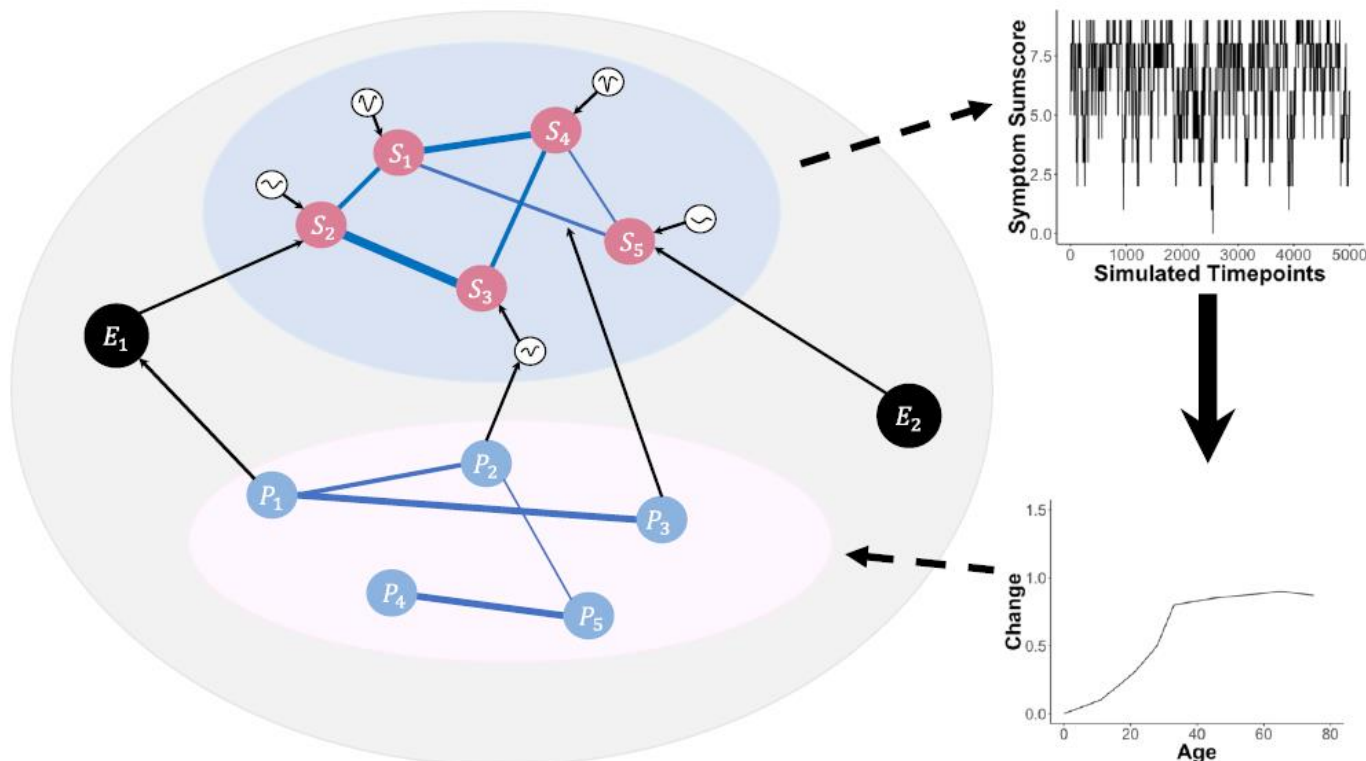

Gabriela Lunansky
PhD student in Psychological Methods



Claudia van Borkulo
cvborkulo

Follow

University Medical Center Groningen/
Amsterdam
cvborkulo@gmail.com
<http://cvborkulo.com>



(Denny) Borsboom

THANKS

To those who carry us !