

Diamond-based detector development for beam monitoring in the context of medical applications



ML. Gallin-Martel, A. Bes, G. Bosson, J. Bouvier, J. Collot, S. Curtoni, D. Dauvergne, P. Everaere, L. Gallin-Martel, A. Ghimouz, Ch. Hoareau, A. Lacoste, S. Marcatili, JF. Muraz, F. Rarbi, O. Rossetto, N. Rosuel, L. Tribouilloy, M. Yamouni : LPSC Grenoble



J-F Adam
STROBE, Grenoble



A. Guertin, F. Haddad, C. Koumeir, F. Poirier, V. Métivier, N. Servagent :
ARRONAX et Subatech Nantes



E. Testa
IP2I Lyon



J-M Letang
CREATIS Lyon



J. F. Motte, L. Abbassi, T. Crozes : NEEL Grenoble



mlgallin@lpsc.in2p3.fr



Context

➤ **Development of new generations of ion accelerators:**

- medical applications: hadrontherapy, X-ray or synchrotron radiation therapy and flash therapy
⇒ very precise monitoring of the beam with rapid counting in a highly radiative environment.

➤ **The intrinsic qualities of diamond:**

- speed, low leakage current, excellent SNR, resistance to radiation
⇒ an excellent candidate to meet such monitoring requirements over a wide dynamic range from a fraction of pA (single particle) up to μA .

Outlines

- **Beam tagging hodoscope for online ion range verification in hadrontherapy**
- **Diamond for beam monitor development**
 - **Material intrinsic qualities**
 - **Detector instrumentation**
 - **Performances in beam tests**
- **Development of a diamond beam monitor for innovative radiotherapies using spatially segmented photon beams at ESRF on ID17 medical beam line – IDSYNCHRO R&T Transverse IN2P3**
- **Diamond application to Flash Therapy : ANR – DIAMMONI**
- **Conclusion**

Outlines

- **Beam tagging hodoscope for online ion range verification in hadrontherapy**
- **Diamond for beam monitor development**
 - **Material intrinsic qualities**
 - **Detector instrumentation**
 - **Performances in beam tests**
- **Development of a diamond beam monitor for innovative radiotherapies using spatially segmented photon beams at ESRF on ID17 medical beam line – IDSYNCHRO R&T Transverse IN2P3**
- **Diamond application to Flash Therapy : ANR – DIAMMONI**
- **Conclusion**

Beam tagging hodoscope for online ion range verification in hadrontherapy

Prompt Gamma detection

Ion range monitoring in patient body : Bragg peak location

CLaRyS

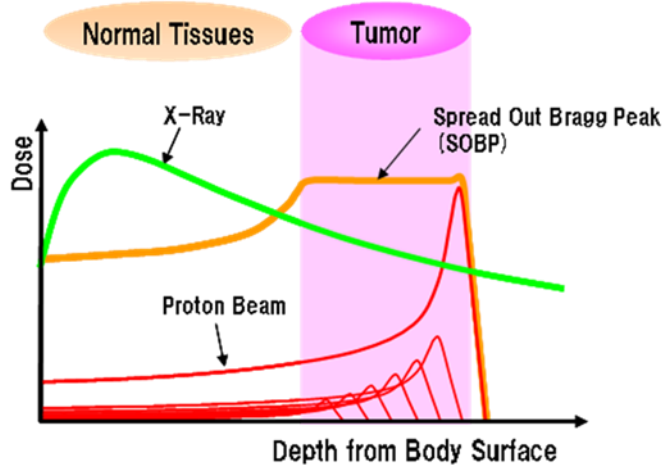

Multi-slit camera

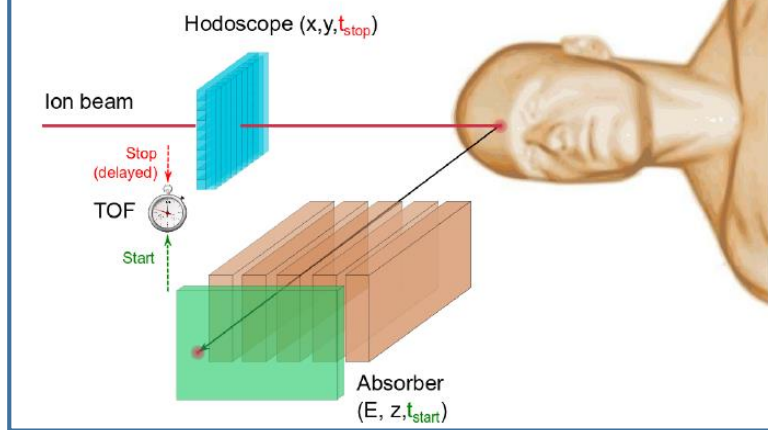

Compton camera

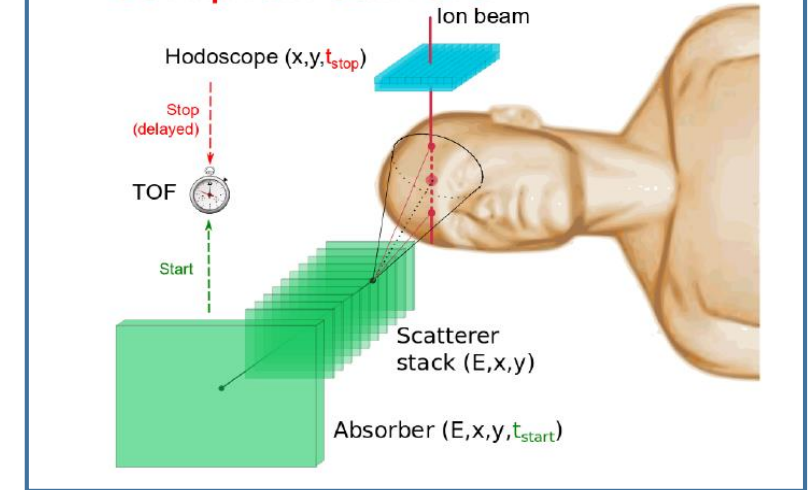

Geant4 Simulation

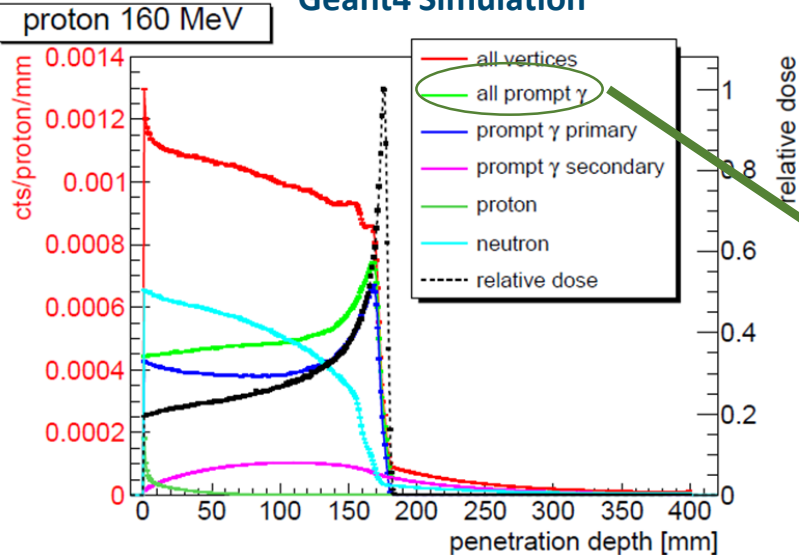

Gamma Prompt Imaging

Beam tagging hodoscope for online ion range verification in hadrontherapy

Prompt Gamma detection

CLaRyS

Gamma Prompt Imaging

Hodoscope Existing development :



← Array of scintillating fibres + multichannel PMT

Hodoscope : Background reduction + position and time stamp for the ion beam

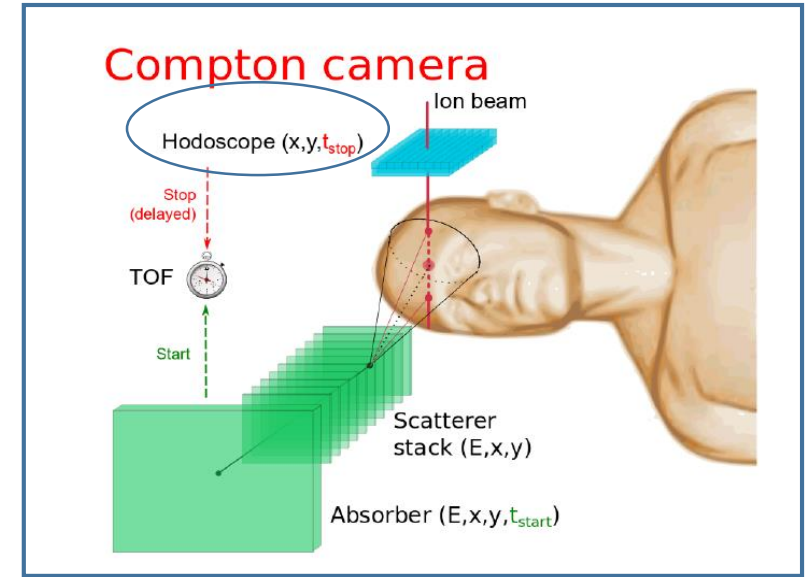
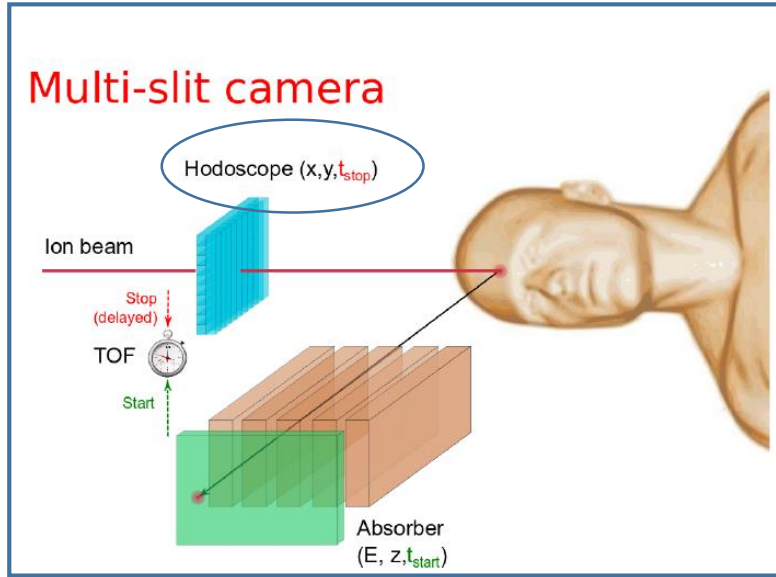

Geant4 Simulation

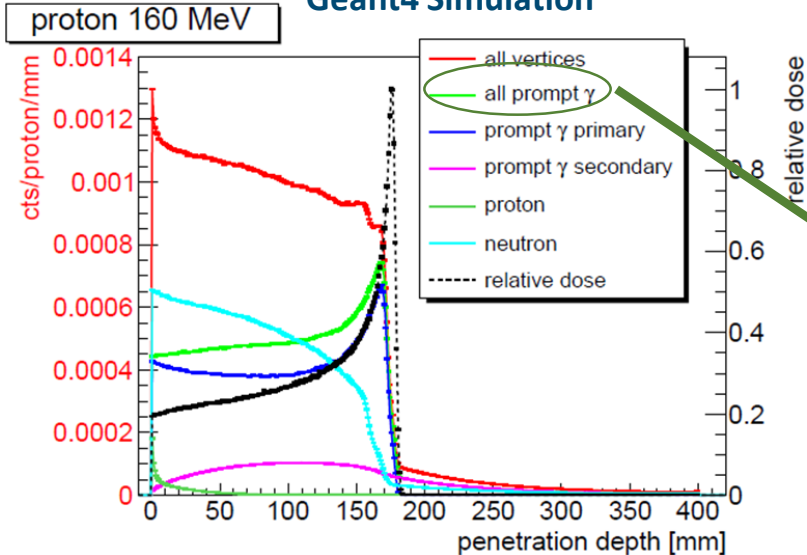

Gamma Prompt Imaging

Beam tagging hodoscope for online ion range verification in hadrontherapy

Prompt Gamma detection

CLaRyS

Gamma Prompt Imaging

Hodoscope Existing development :



Array of scintillating fibres + multichannel PMT

Hodoscope : Background reduction + position and time stamp for the ion beam

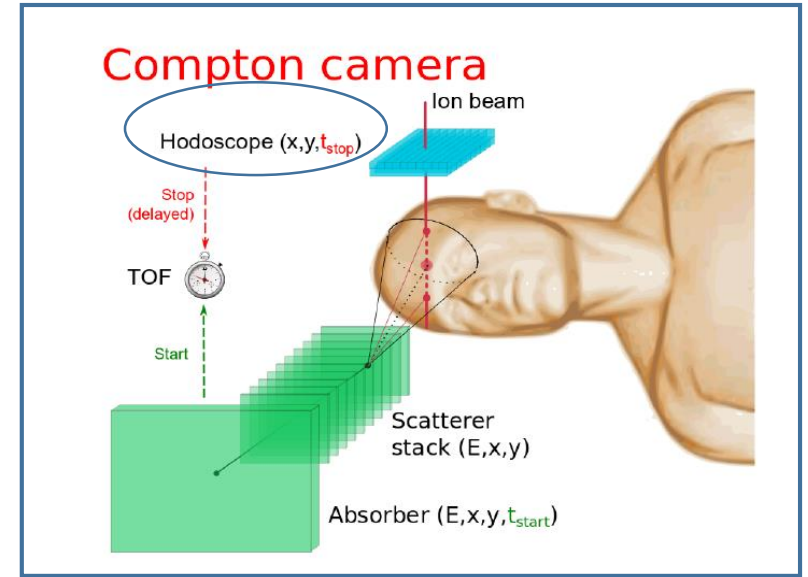
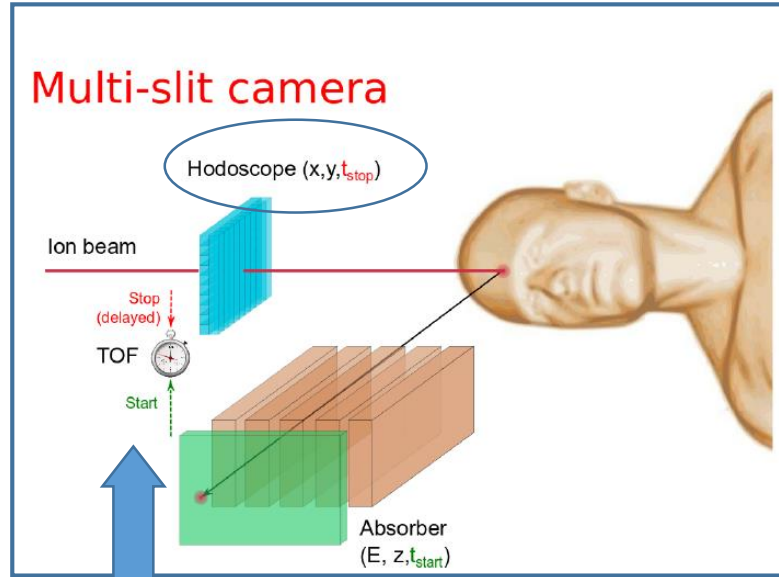

Prompt gamma detection : experiment using ^{12}C @95 MeV/u on PMMA
Time of Flight Spectrum

Geant4 Simulation

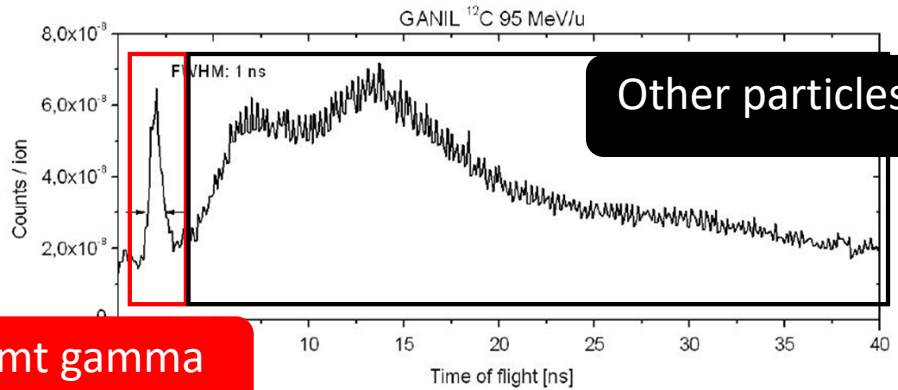
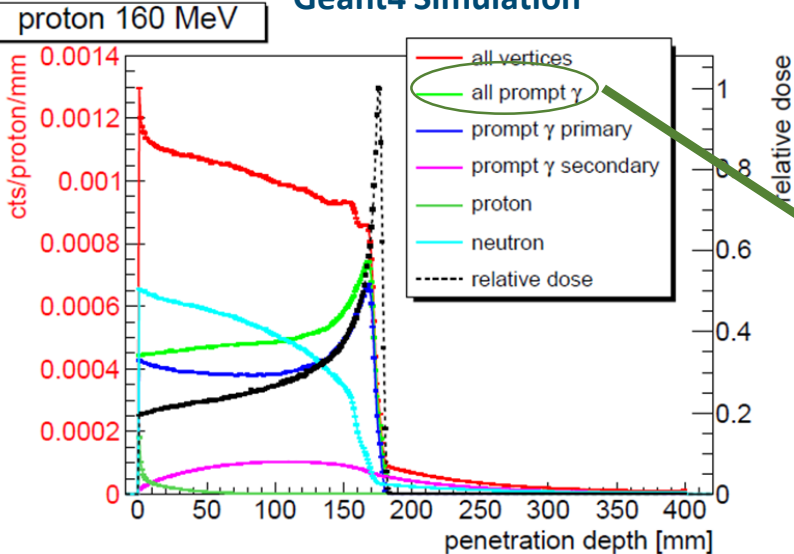

Prompt gamma

Mauro Testa, Thèse, Univ. Lyon, 2010

ML Gallin-Martel VHEE conference

Beam tagging hodoscope for online ion range verification in hadrontherapy

Prompt Gamma detection

CLaRyS

Gamma Prompt Imaging

Hodoscope Existing development :



← Array of scintillating fibres + multichannel PMT

Hodoscope : Background reduction + position and time stamp for the ion beam

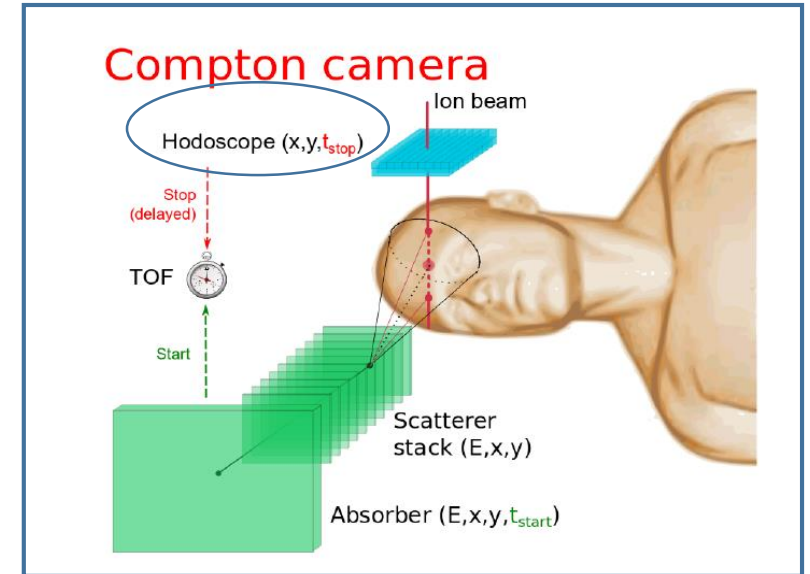
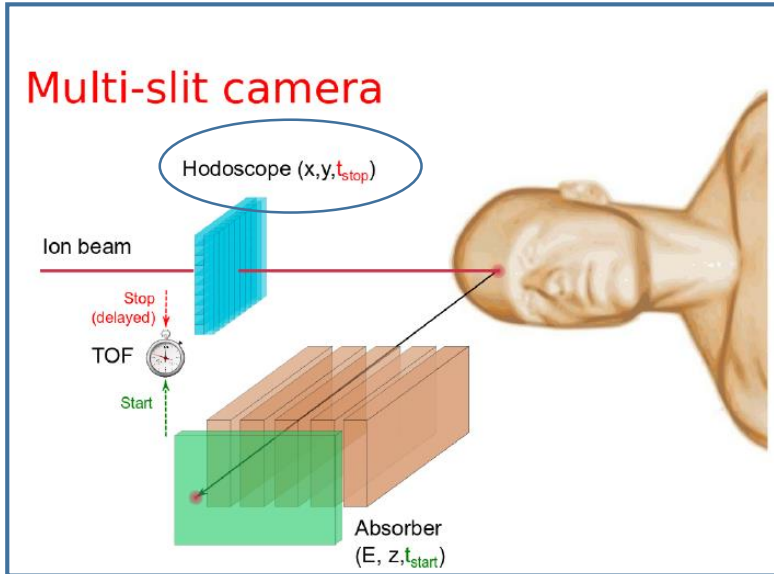

Limitations :

- Radiation hardness
- PMT count rate capability (10^7 cps per PMT)
- Time resolution 500 ps – 1 ns

Beam tagging hodoscope for online ion range verification in hadrontherapy

Prompt Gamma detection

CLaRyS

Gamma Prompt Imaging

Hodoscope Existing development :



← Array of scintillating fibres + multichannel PMT

Limitations :

- Radiation hardness
- PMT count rate capability (10^7 cps per PMT)
- Time resolution 500 ps – 1 ns

CLaRyS-Ultra-Fast Timing : 100 ps resolution using diamond

CLaRyS-UFT : S. Curtoni 2017-2020 PhD

→ Imaging based on Time of Flight

Hodoscope : Background reduction + position and time stamp for the ion beam

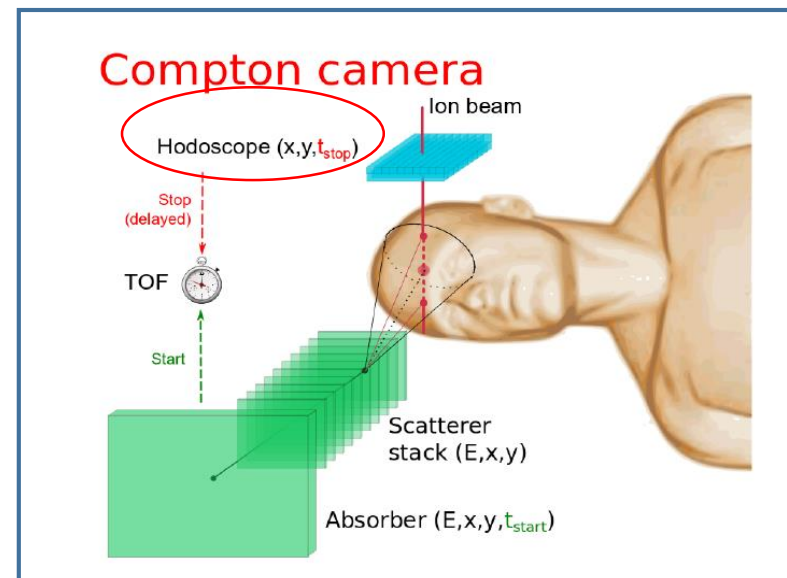
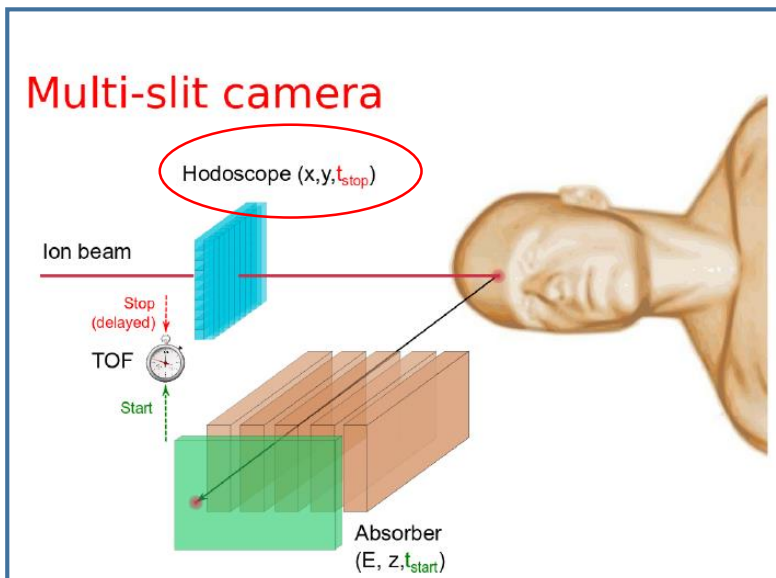

Diamond hodoscope

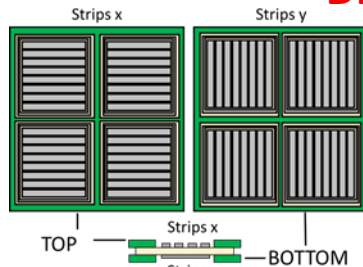

ML Gallin-Martel VHEE conference

Beam tagging hodoscope for online ion range verification in hadrontherapy

Prompt Gamma detection

CLaRyS

Gamma Prompt Imaging

Hodoscope Existing development :



← Array of scintillating fibres + multichannel PMT

Limitations :

- Radiation hardness
- PMT count rate capability (10^7 cps per PMT)
- Time resolution 500 ps – 1 ns

CLaRyS-Ultra-Fast Timing : 100 ps resolution using diamond

CLaRyS-UFT : S. Curtoni 2017-2020 PhD

→ Imaging based on Time of Flight

Hodoscope : Background reduction + position and time stamp for the ion beam

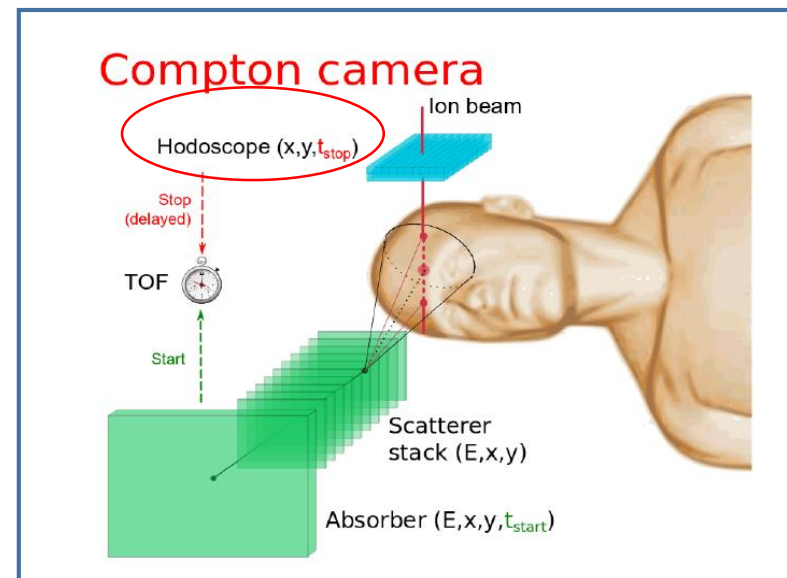
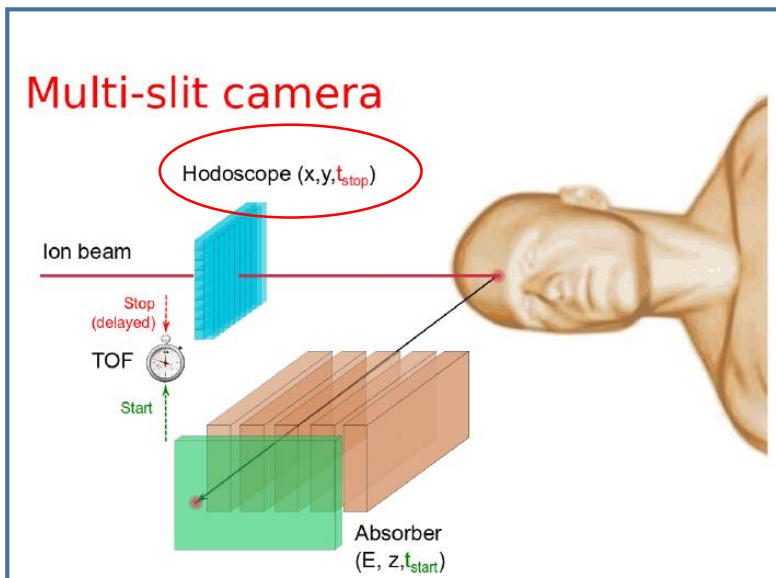

Diamond hodoscope

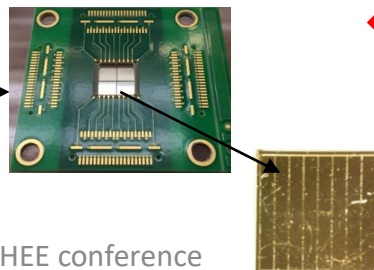

Beam tagging hodoscope for online ion range verification in hadrontherapy

Prompt Gamma detection

CLaRyS

Gamma Prompt Imaging

Hodoscope Existing development :



← Array of scintillating fibres + multichannel PMT

Limitations :

- Radiation hardness
- PMT count rate capability (10^7 cps per PMT)
- Time resolution 500 ps – 1 ns

CLaRyS-Ultra-Fast Timing : 100 ps resolution using diamond

CLaRyS-UFT : S. Curtoni 2017-2020 PhD

→ Imaging based on Time of Flight

Hodoscope : Background reduction + position and time stamp for the ion beam

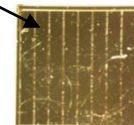
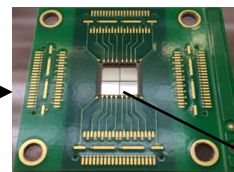
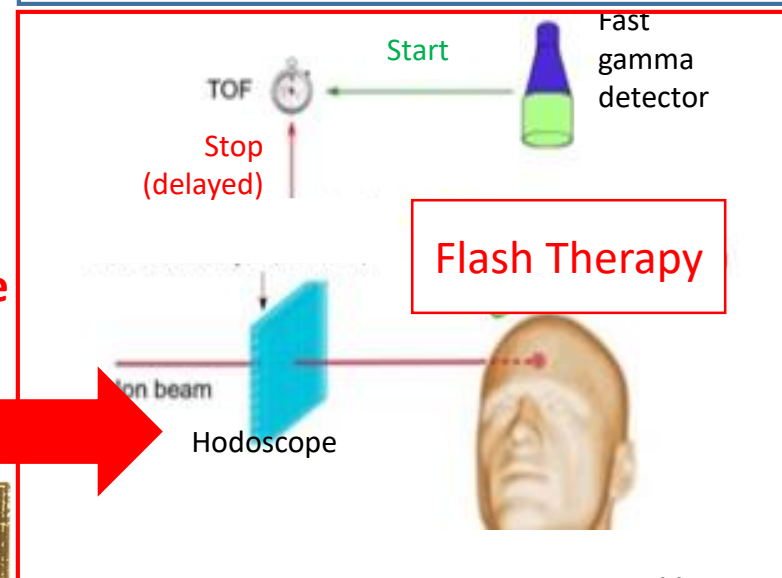
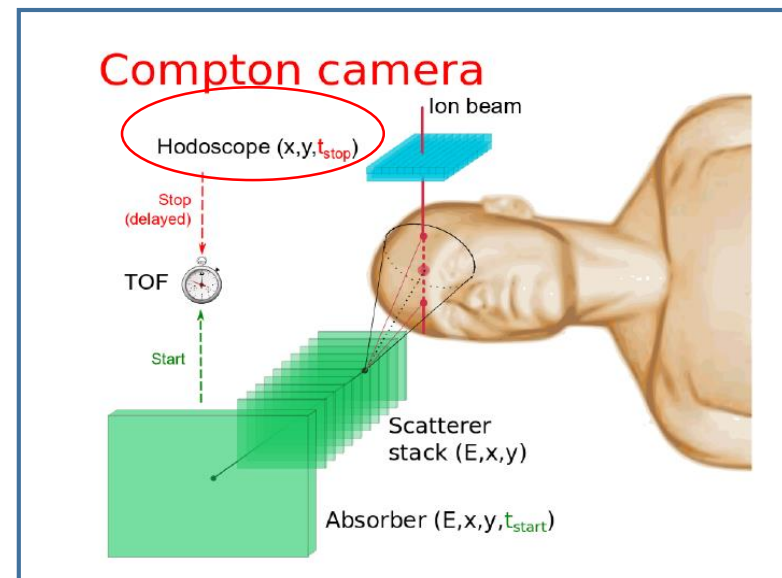
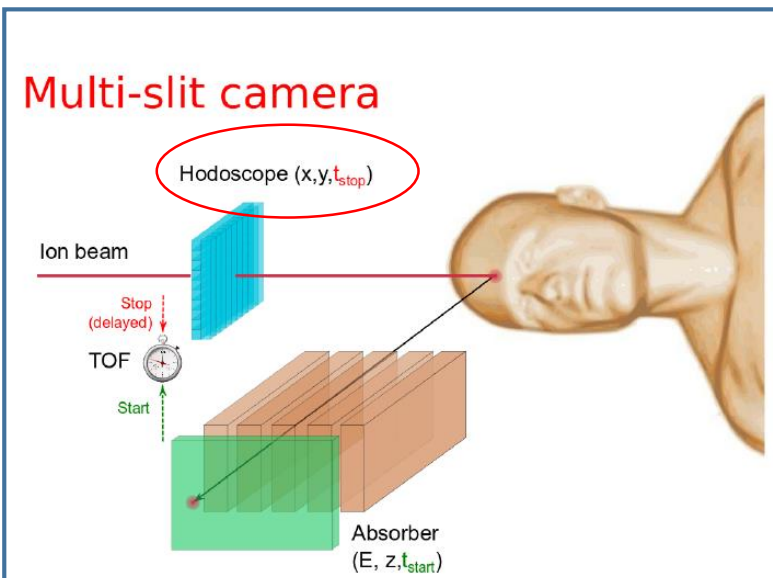

Diamond hodoscope

Beam tagging hodoscope for online ion range verification in hadrontherapy

Prompt Gamma detection

Proof of concept : beam tests in ARRONAX with 68 MeV proton beam

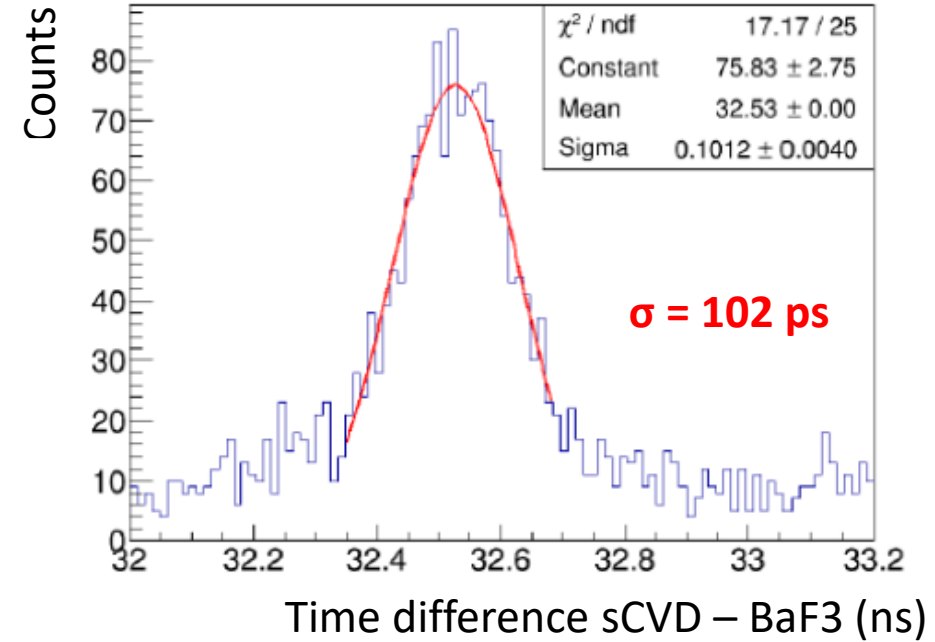
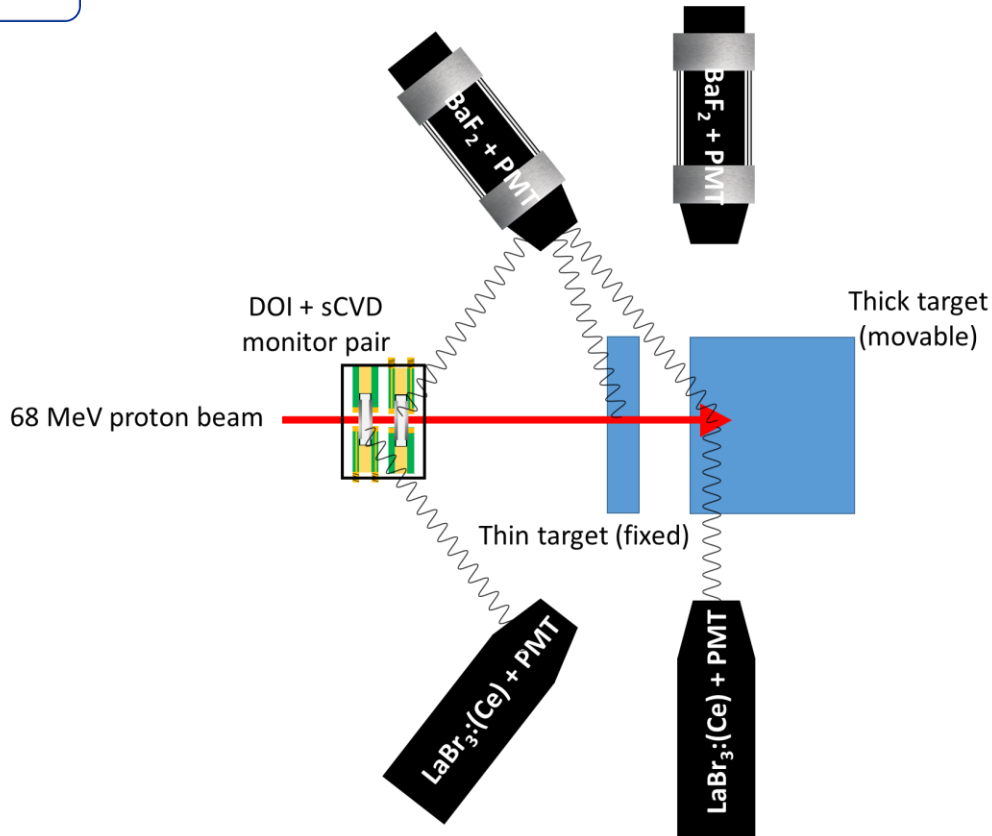

Time resolution single crystal diamond vs scintillator

S. Curtioni PhD thesis

S. Marcatili et al, PMB 2020

Outlines

- Beam tagging hodoscope for online ion range verification in hadrontherapy
- **Diamond for beam monitor development**
 - **Material intrinsic qualities**
 - **Detector instrumentation**
 - **Performances in beam tests**
- Development of a diamond beam monitor for innovative radiotherapies using spatially segmented photon beams at ESRF on ID17 medical beam line – IDSYNCHRO R&T Transverse IN2P3
- Diamond application to Flash Therapy : ANR – DIAMMONI
- Conclusion

Diamond a wide-bandgap semiconductor

Characteristics @ 300 K

	Diamond	Silicon
Resistivity ($\Omega.m$)	$> 10^{13}$	$2.3 \cdot 10^7$
Gap (eV)	5.5	1.1
e ⁻ /h creation energy (eV)	13.1	3.6
Displacement energy (eV)	43	25
Charge carriers mobility ($cm^2.V^{-1}.s^{-1}$)	> 2000	800 – 1400
Thermal conductivity ($W.cm^{-1}.K^{-1}$)	18	2

- Very low leakage current
- Low noise
- Radiation hard
- Fast timing
- Room temperature

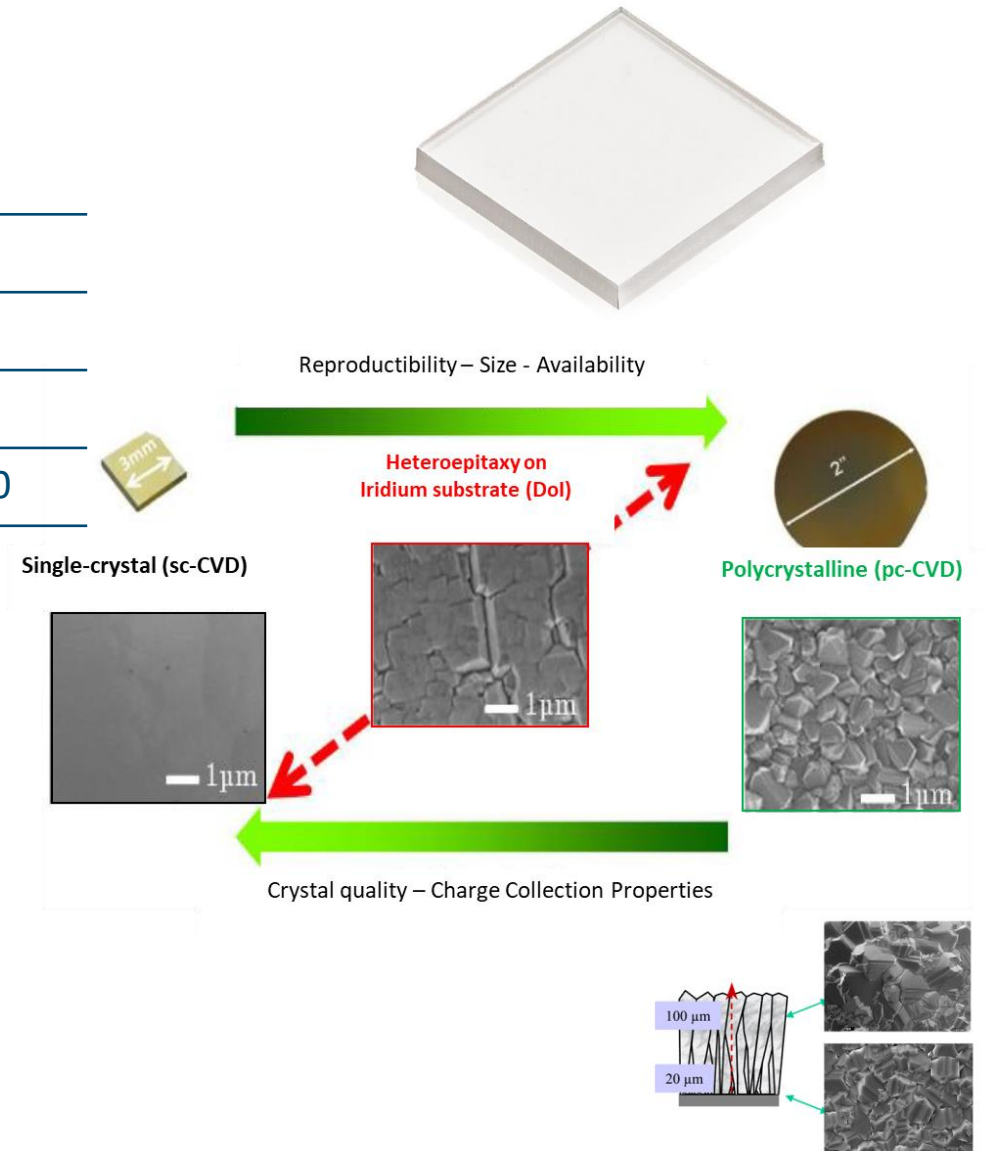

Diamond Sensor Instrumentation for test @ lab or in beam

Solid state ionization chamber

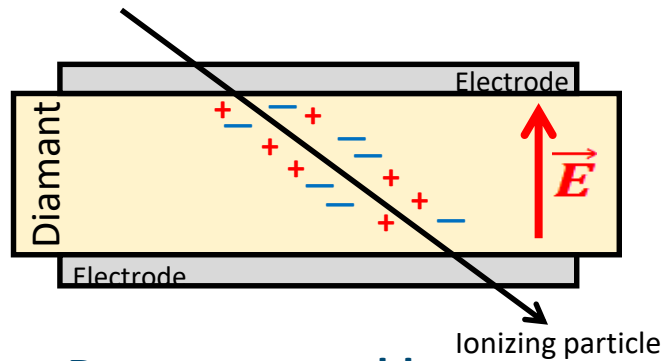

Detector assembly

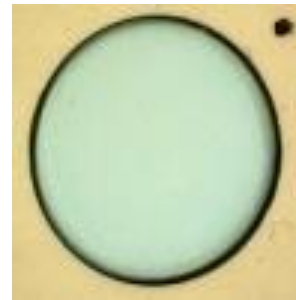
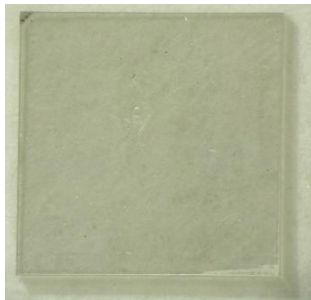

3 cm

PCB 50Ω adapted

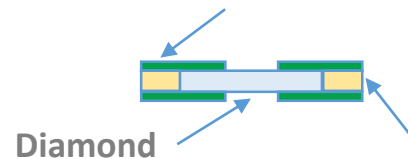

Diamond

Spacer

Read-out electronics

- Fast current preamplifier



Band Width:	2 GHz
Gain:	40 dB
Impedance:	50 Ω
Dynamic range:	~ +/- 1 V
Power Supply:	12 V / 100 mA

+ for other application :

- Charge preamplifier
- Electrometer

Diamond hodoscope Instrumentation

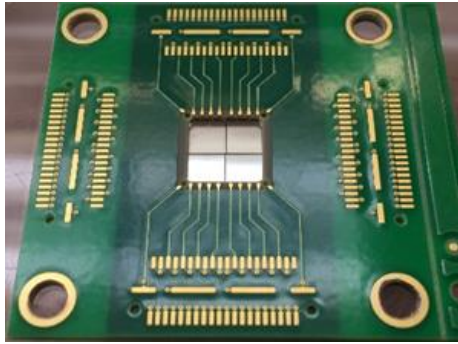

R&T IN2P3 DIAMTECH + ANR DIAMMONI 2020

Fast preamps + QDC in discrete electronics

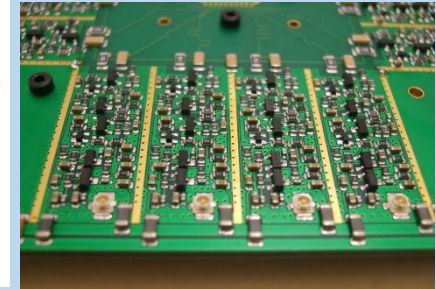
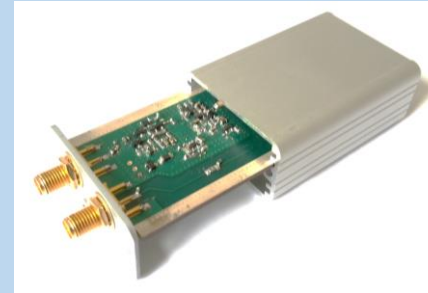

R&T IN2P3 DIAMASIC

LPSC - LPC Caen

ASIC Preamps +TDC+ QDC

- CMOS 130 nm (CERN)
- Radiation tolerant

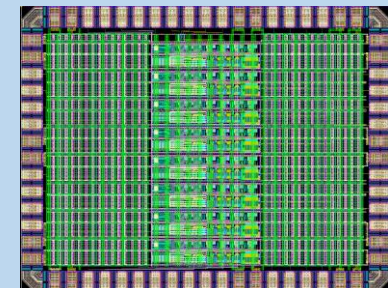
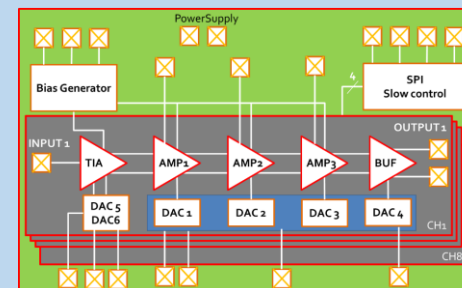

Beam tests XBIC @ESRF – 2D current response map

Tests at ESRF with 8.5 keV photons = XBIC source

Xray Beam Induced Current = XBIC

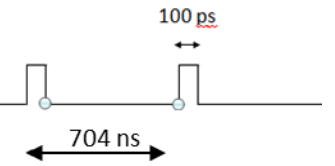

Poly-crystalline E6

10 x 10 mm² x 500 μm pc-CVD

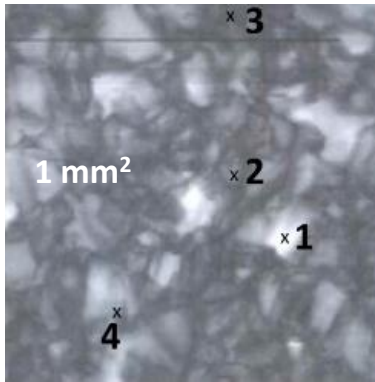

Polycrystalline (pc-CVD)

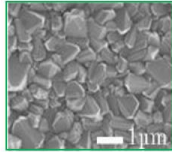

Reflects spatial distribution of grain boundaries

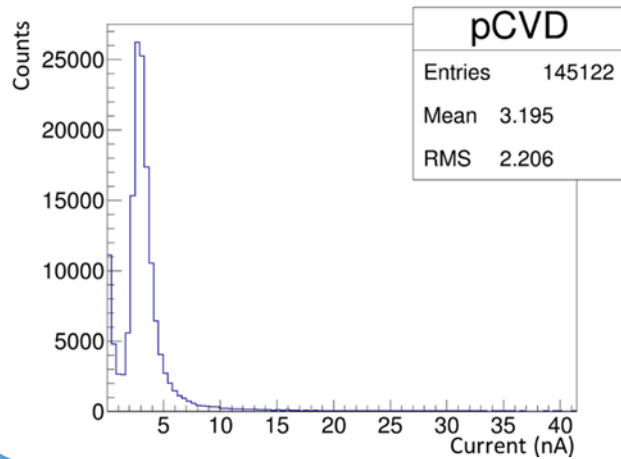

DOI AuDiaTec

5 x 5 mm² x 300 μm DOI-CVD

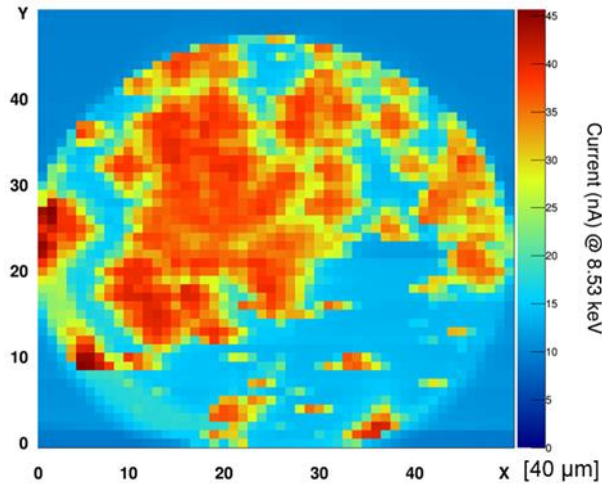

Heteroepitaxy on Iridium substrate (DOI)

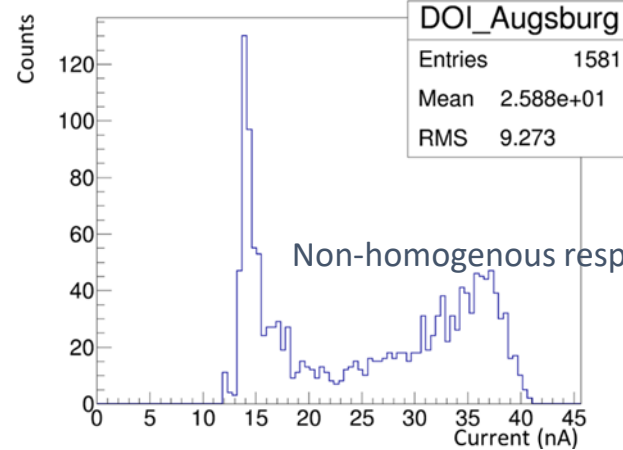
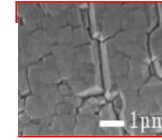

Non-homogenous response map

Single-crystal E6

4.5 x 4.5 mm² x 517 μm sc-CVD

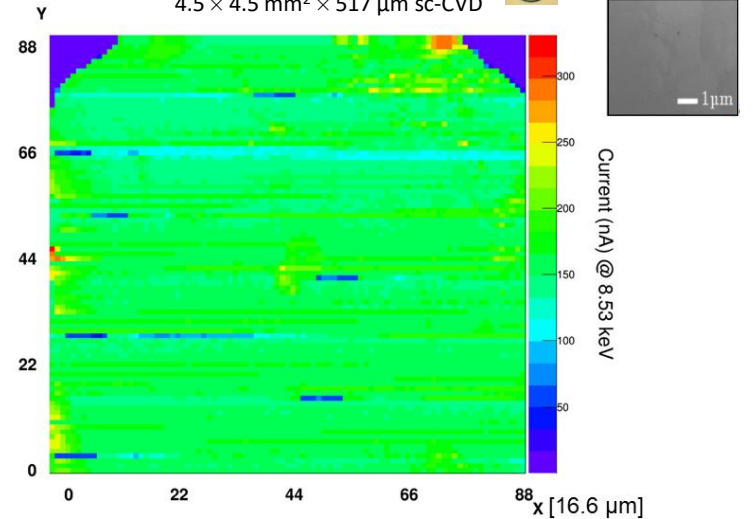

Single-crystal (sc-CVD)

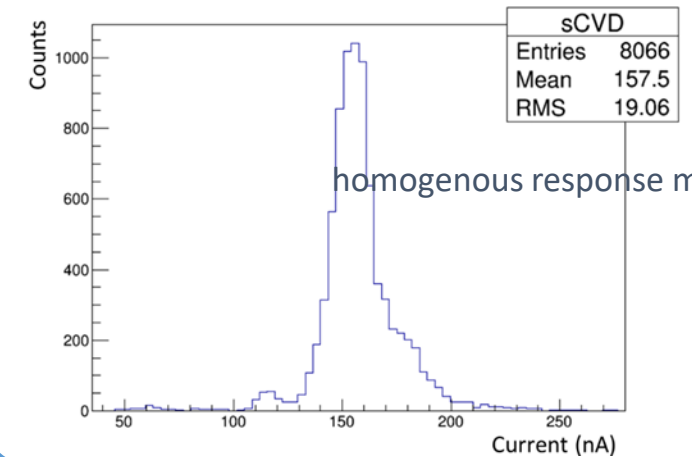
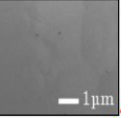

homogenous response map

Beam tests XBIC @ESRF – 2D current response map

Tests at ESRF with 8.5 keV photons = XBIC source

Xray Beam Induced Current = XBIC

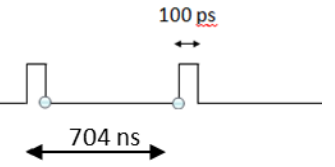

Poly-crystalline E6

10 x 10 mm² x 500 μm pc-CVD

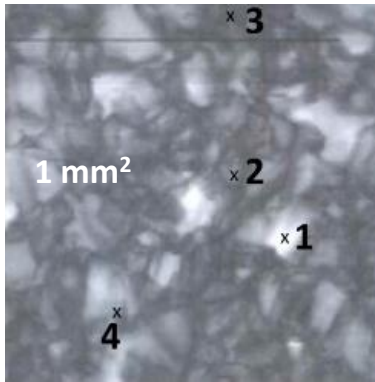

Polycrystalline (pc-CVD)

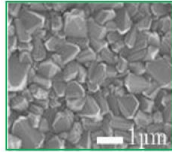

Reflects spatial distribution of grain boundaries

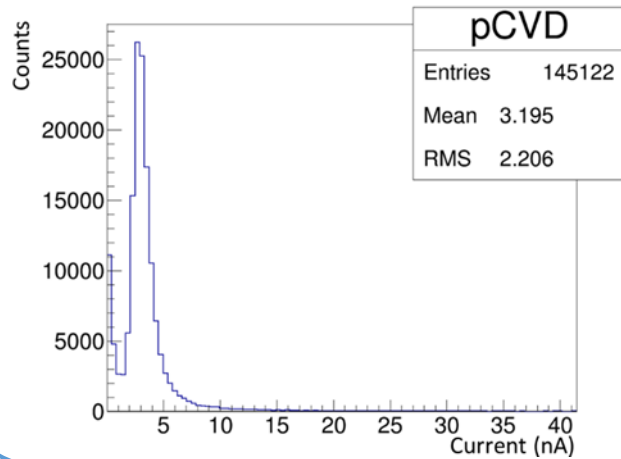

DOI AuDiaTec

5 x 5 mm² x 300 μm DOI-CVD

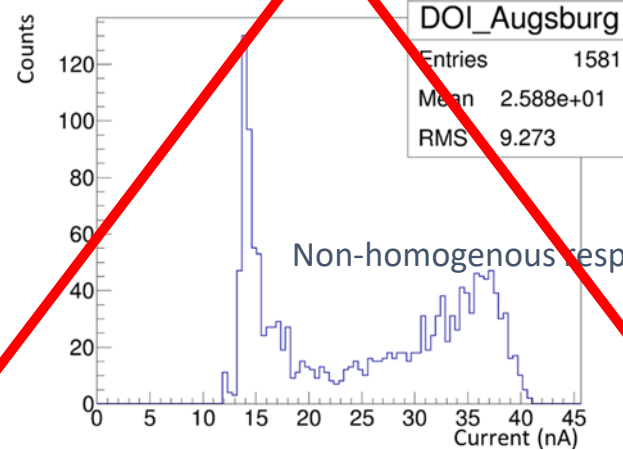
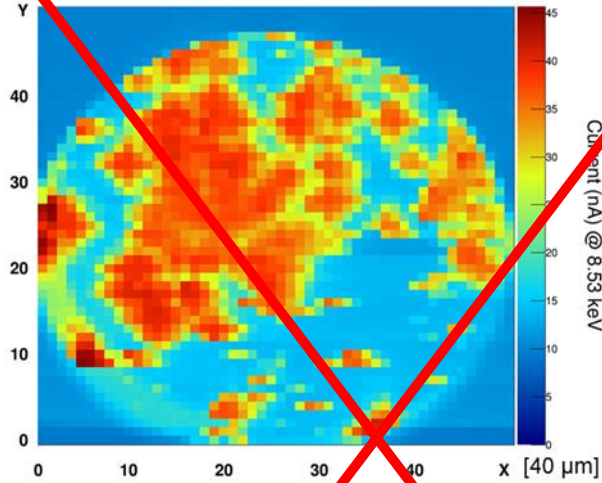

Single-crystal E6

4.5 x 4.5 mm² x 517 μm sc-CVD

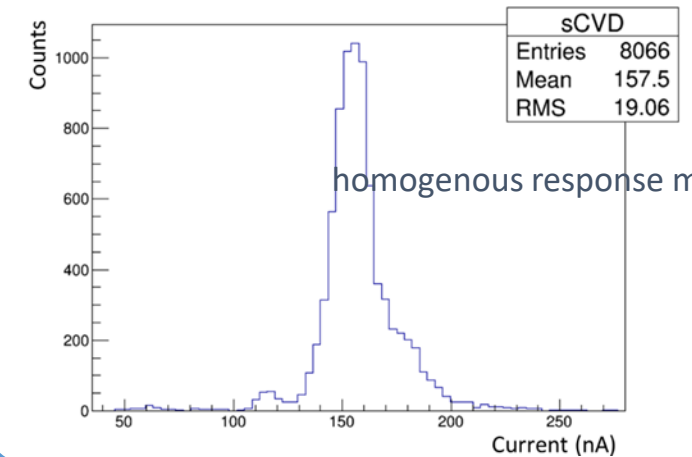
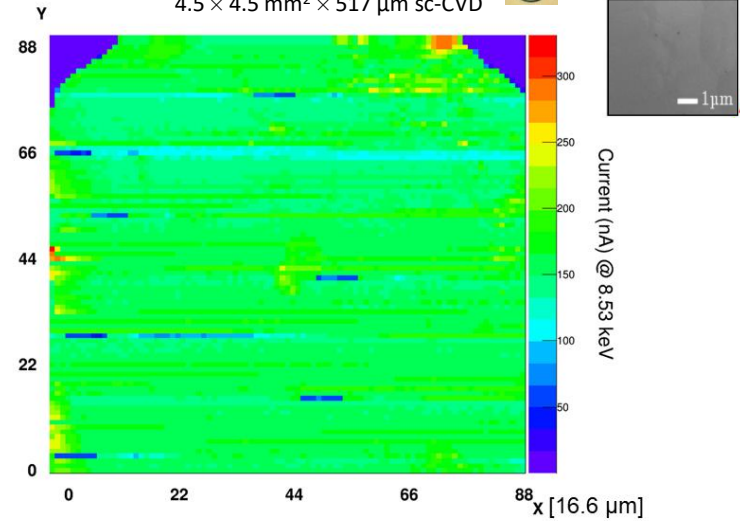

Outlines

- Beam tagging hodoscope for online ion range verification in hadrontherapy
- Diamond for beam monitor development
 - Material intrinsic qualities
 - Detector instrumentation
 - Performances in beam tests
- **Development of a diamond beam monitor for innovative radiotherapies using spatially segmented photon beams at ESRF on ID17 medical beam line – IDSYNCHRO R&T Transverse IN2P3**
- Diamond application to Flash Therapy : ANR – DIAMMONI
- Conclusion

IDSYNCHRO 2020-2023 (R&T IN2P3 DIAMTECH)

Innovative radiotherapies using spatially segmented photon beams
Energy 50-200 keV compensated by very high dose rate 10^4 Gy/s

R&T IN2P3 DIAMTECH

Fluence measurement in Micro-beam Radiation Therapy

Collaborations :

- LPSC (IN2P3), STROBE (Université Grenoble Alpes INSERM)
- ESRF medical beam line ID17

Synchrotron radiation on-line monitoring

- ➔ X-Rays detection
- ➔ Spatial (micro beams)
- ➔ Huge dynamique (High dose rate)

N. Rosuel PhD thesis (2018-2021)

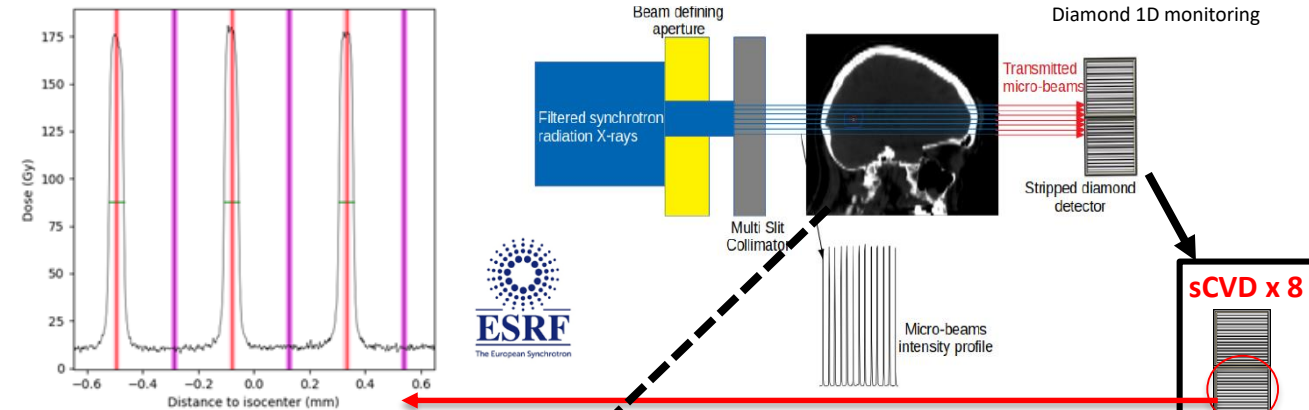

MRT: 50 μ m
Micro Beam Radiation Therapy

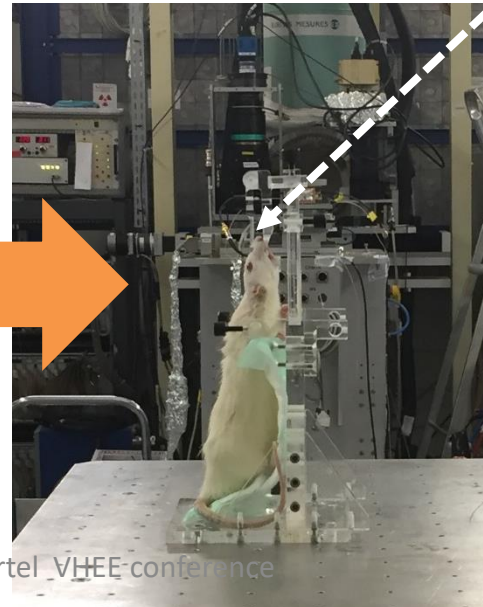

Strips on diamond to satisfy MRT beam structure

Detector = 8 x sCVD (4.5 x 4.5 mm²) strip metallized

+

elec FE = QDC ASIC LPSC

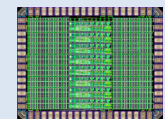
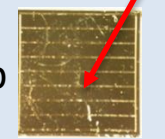

IDSYNCHRO 2020-2023 (R&T IN2P3 DIAMTECH)

Innovative radiotherapies using spatially segmented photon beams
 Energy 50-200 keV compensated by very high dose rate 10^4 Gy/s

R&T IN2P3 DIAMTECH

Fluence measurement in Micro-beam Radiation Therapy

Collaborations :

- LPSC (IN2P3), STROBE (Université Grenoble Alpes INSERM)
- ESRF medical beam line ID17

Synchrotron radiation on-line monitoring

- ➔ X-Rays detection
- ➔ Spatial (micro beams)
- ➔ Huge dynamique (High dose rate)

N. Rosuel PhD thesis (2018-2021)

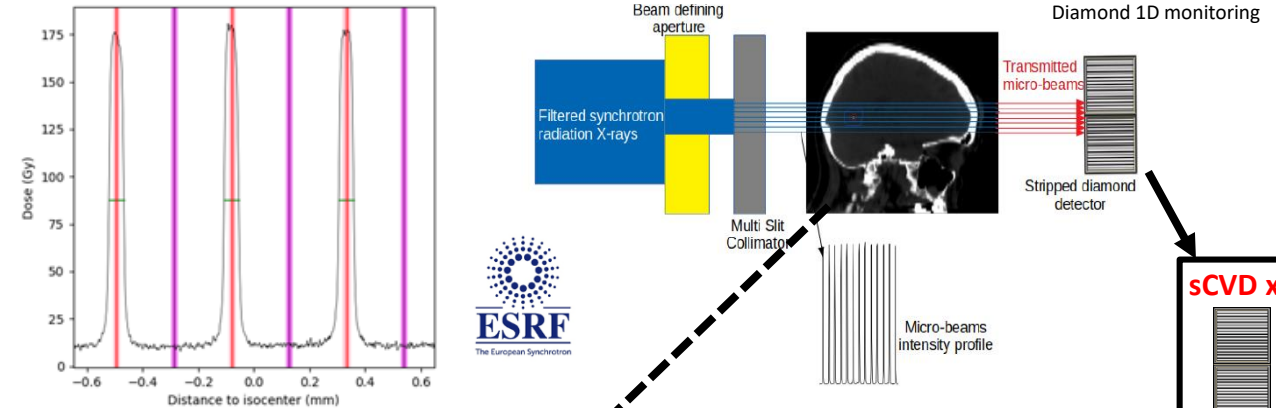

MRT: 50 μ m
 Micro Beam Radiation Therapy

Why sCVD ?

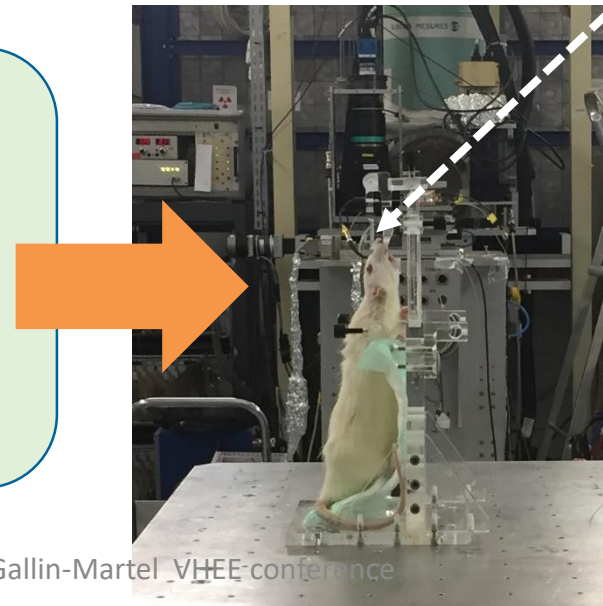
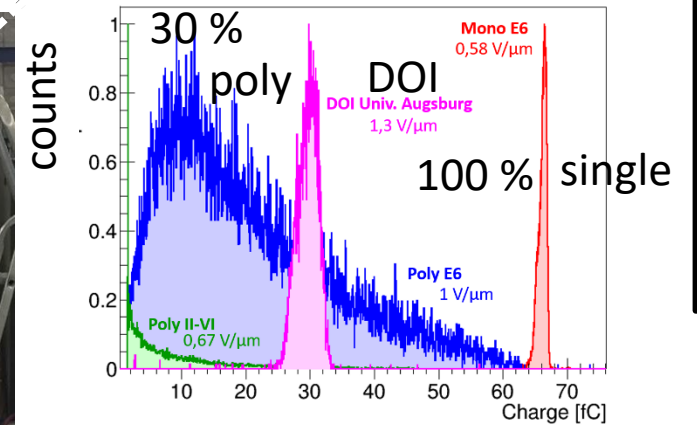

Am α source test results @lab
 5.5 MeV => 67 fC charge deposition
 S. Curtoni PhD thesis

IDSYNCHRO 2020-2023 (R&T IN2P3 DIAMTECH)

Innovative radiotherapies using spatially segmented photon beams
Energy 50-200 keV compensated by very high dose rate 10^4 Gy/s

R&T IN2P3 DIAMTECH

Fluence measurement in Micro-beam Radiation Therapy

Collaborations :

- LPSC (IN2P3), STROBE (Université Grenoble Alpes INSERM)
- ESRF medical beam line ID17

Synchrotron radiation on-line monitoring

- ➔ X-Rays detection
- ➔ Spatial (micro beams)
- ➔ Huge dynamique (High dose rate)

N. Rosuel PhD thesis (2018-2021)

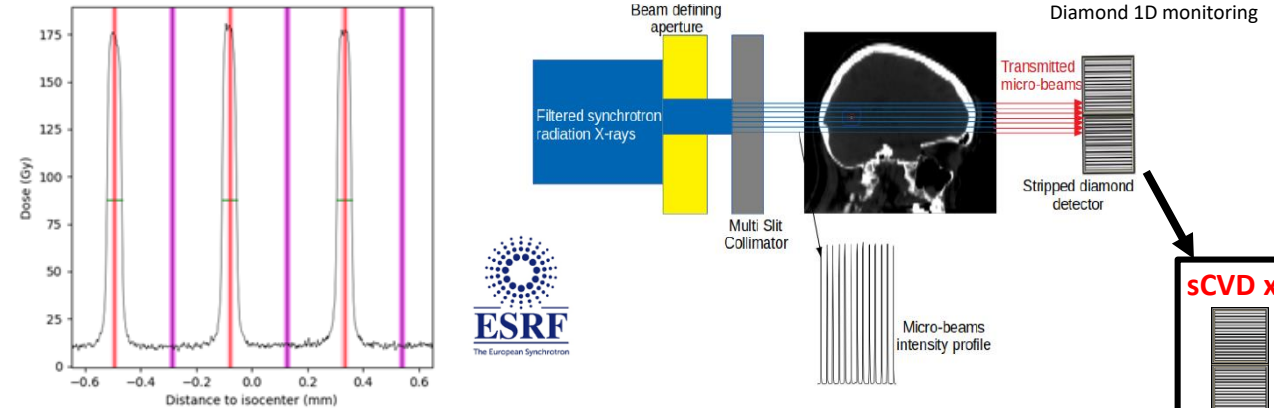

MRT: 50 μ m
Micro Beam Radiation Therapy

- Slightly loss of linearity for the highest flow rates (2019 result)
- Simulation => thinner diamond to be used
- New tests currently in Oct. 2020 @ESRF

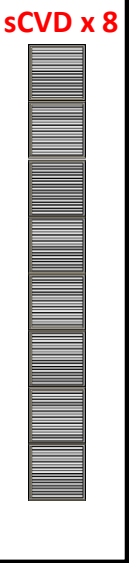
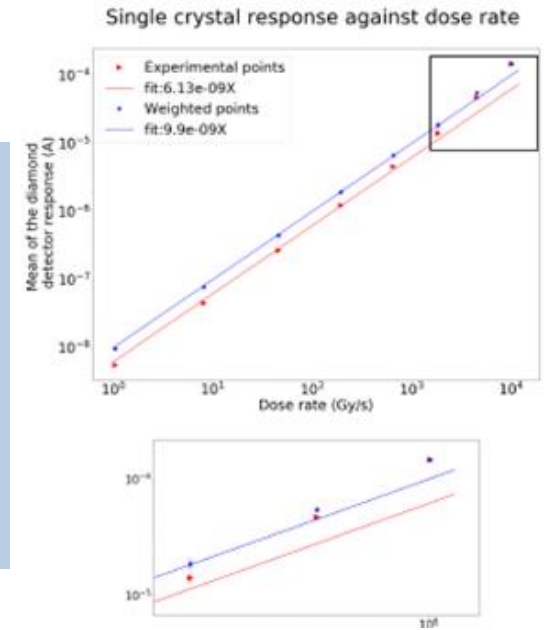

Outlines

- Beam tagging hodoscope for online ion range verification in hadrontherapy
- Diamond for beam monitor development
 - Material intrinsic qualities
 - Detector instrumentation
 - Performances in beam tests
- Development of a diamond beam monitor for innovative radiotherapies using spatially segmented photon beams at ESRF on ID17 medical beam line – IDSYNCHRO R&T Transverse IN2P3
- **Diamond application to Flash Therapy : ANR – DIAMMONI**
- Conclusion

DIAMMONI 2020-2024 (ANR + R&T IN2P3 DIAMTECH)

Diamond beam monitoring + prompt gamma detection with the Prompt Gamma Peak Integral method

Collaboration LPSC IP2I CREATIS in the frame work of Labex Primes

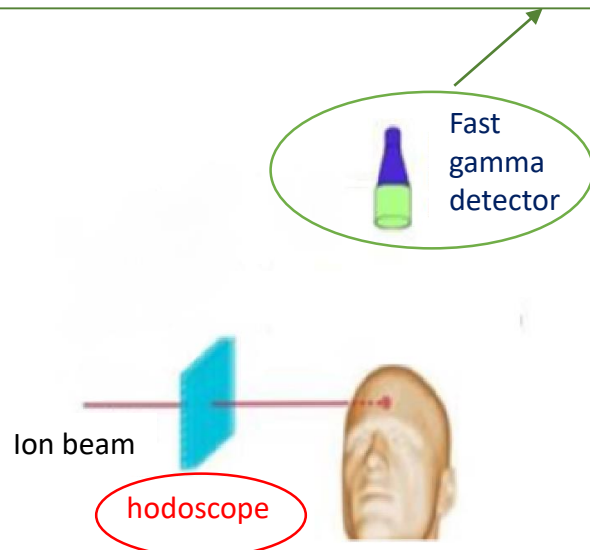

Collaboration LPSC SUBATECH ARRONAX : ANR DIAMMONI + R&T transverse DIAMTECH

DIAMMONI 2020-2024 (ANR + R&T IN2P3 DIAMTECH)

Diamond beam monitoring + prompt gamma detection with the Prompt Gamma Peak Integral method

Collaboration LPSC IP2I CREATIS in the frame work of Labex Primes

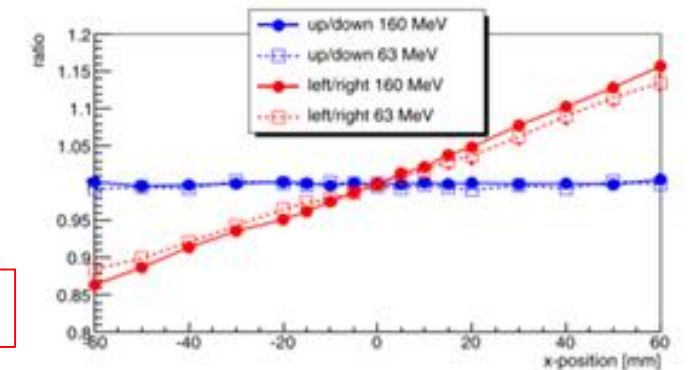
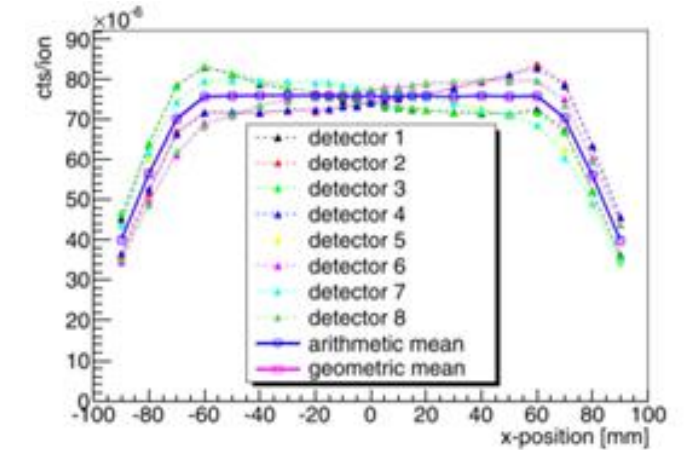
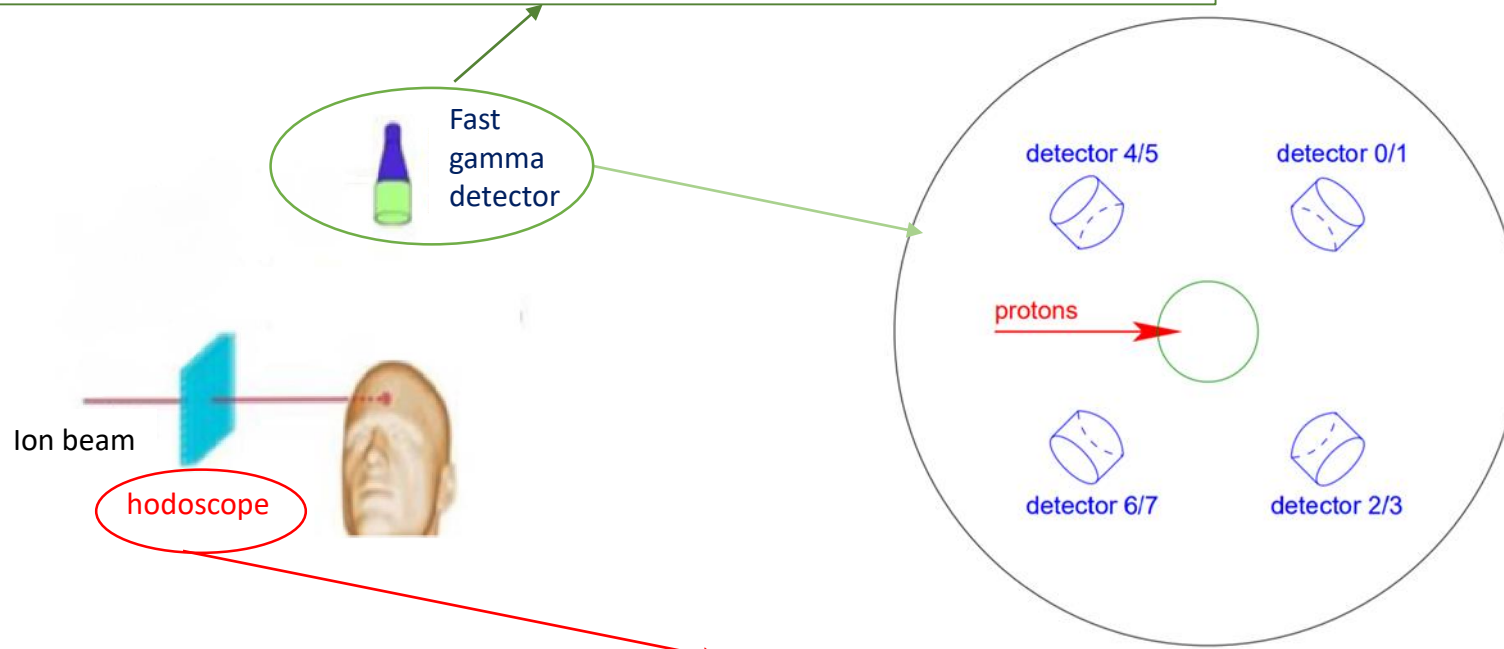

[Krimmer 2017](#)

Collaboration LPSC SUBATECH ARRONAX : ANR DIAMMONI + R&T transverse DIAMTECH

DIAMMONI 2020-2024 (ANR + R&T IN2P3 DIAMTECH)

Diamond beam monitoring + prompt gamma detection with the Prompt Gamma Peak Integral method

Collaboration LPSC IP2I CREATIS in the frame work of Labex Primes

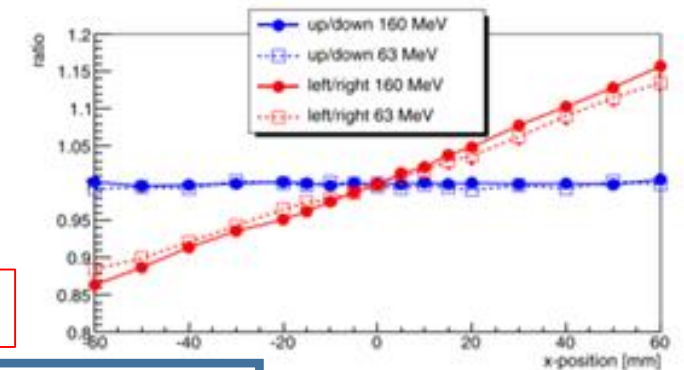
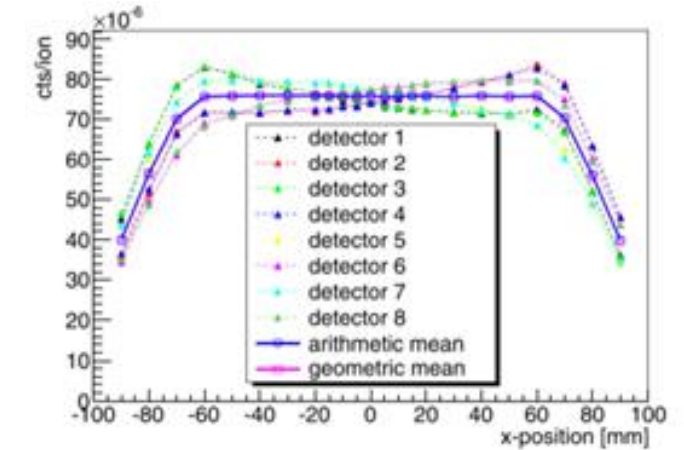
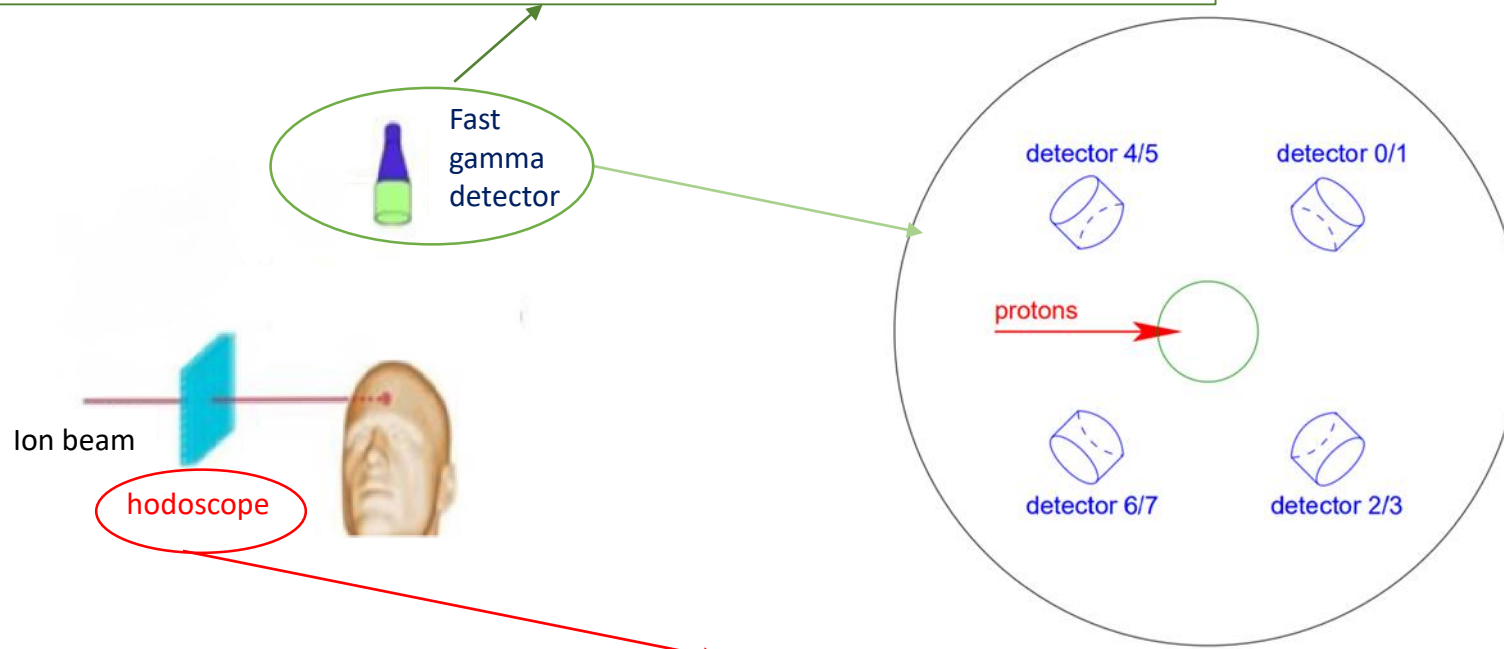

[Krimmer 2017](#)

Collaboration LPSC SUBATECH ARRONAX : ANR DIAMMONI + R&T transverse DIAMTECH

P. Everaere PhD thesis (Labex Primes 2020-2023) : simulation + experiment in FLASH condition both in ARRONAX and in CAL (Centre Antoine Lacassagne de Nice)
X PhD thesis (ANR 2021-2024) : diamond hodoscope for pulsed beam monitoring

DIAMMONI 2020-2024 (ANR + R&T IN2P3 DIAMTECH)

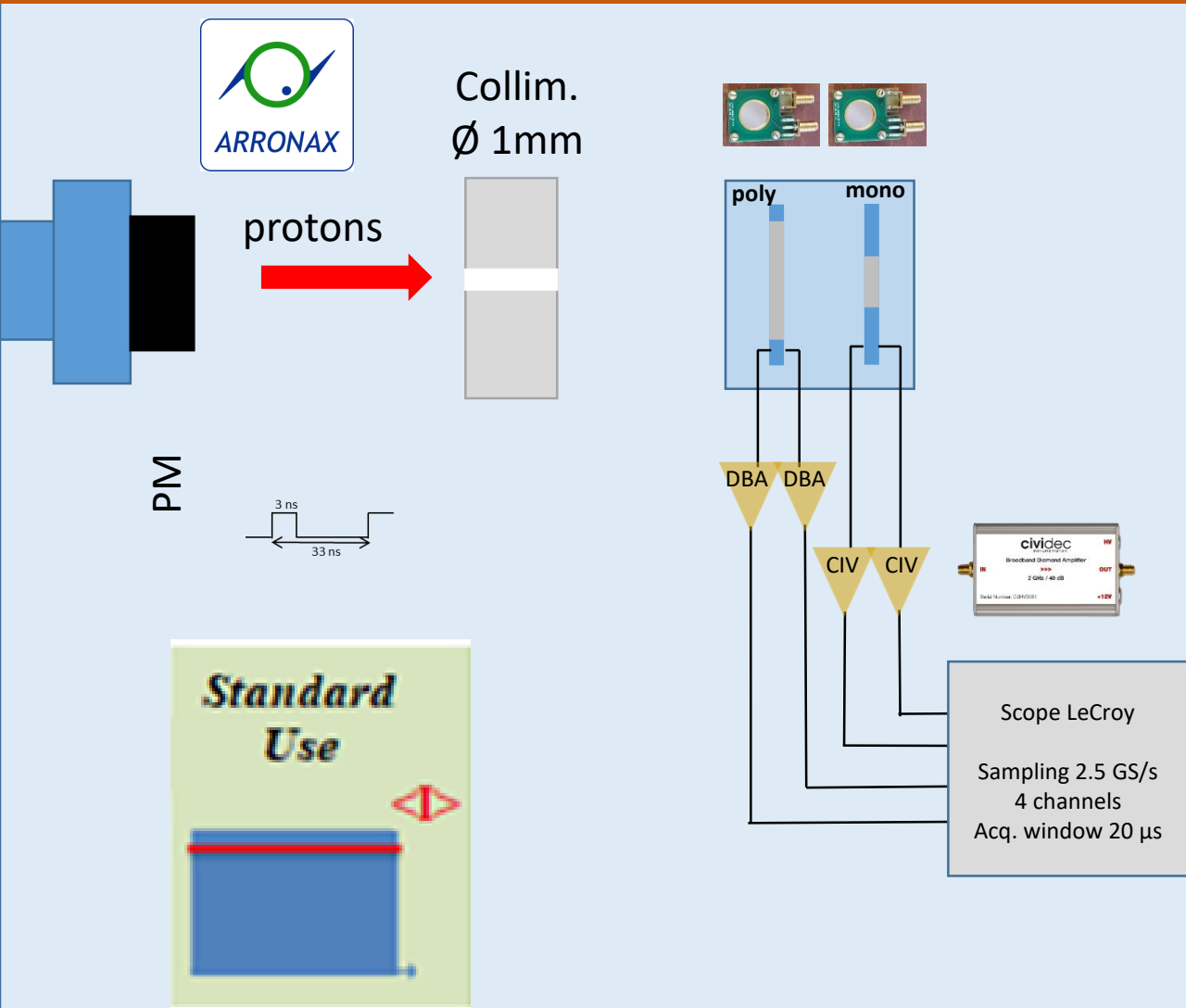

Continuous mode

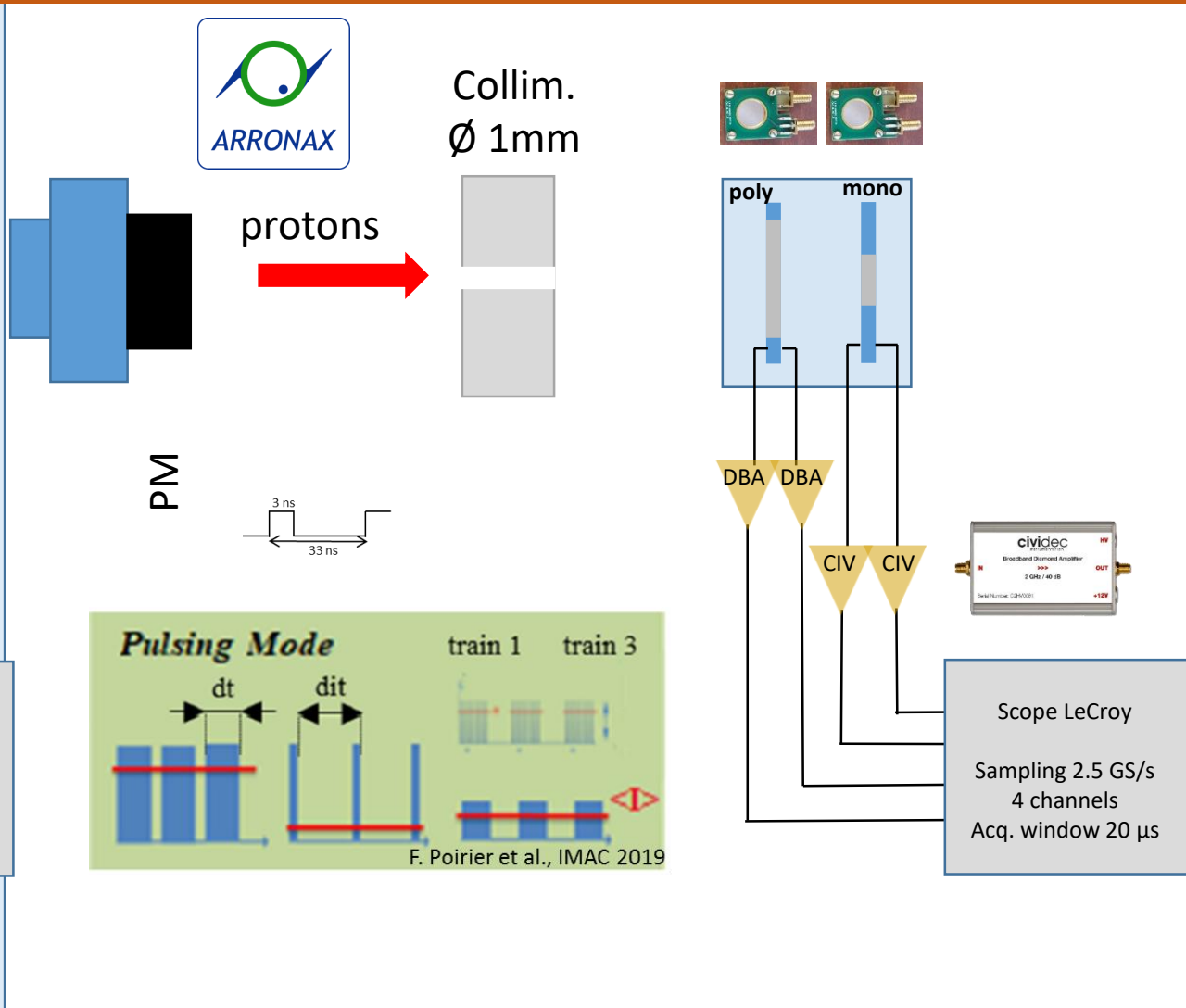

Pulsed mode => Flash Thérapy !

DIAMMONI 2020-2024 (ANR + R&T IN2P3 DIAMTECH)



Particle counting vs I_{beam} : preliminary measurement

Collim.
Ø 1mm

protons

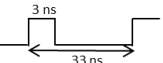
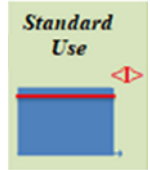

PM

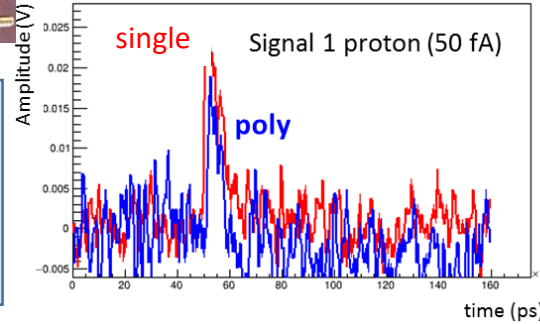
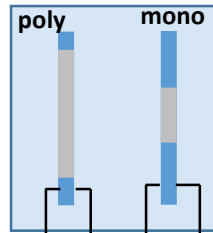

DBA DBA

CIV CIV



Scope LeCroy

Sampling 2.5 GS/s
4 channels
Acq. window 20 µs

Continuous mode and reduced intensity

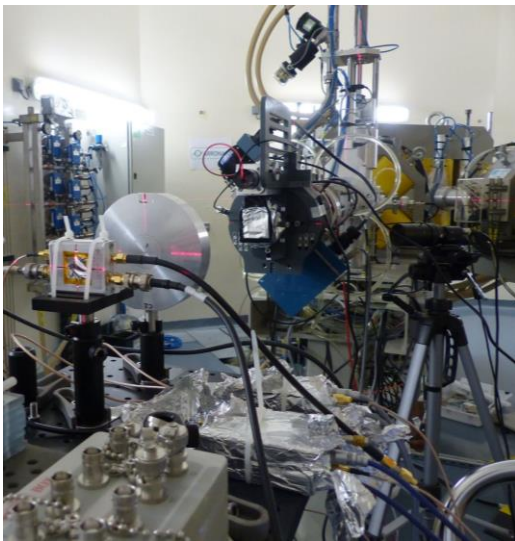

5-7 October 2020 IJCLab

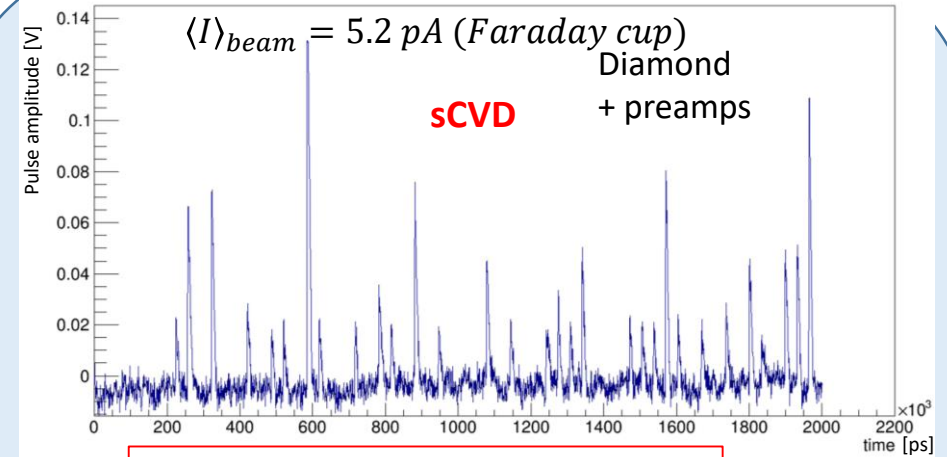

Particle counting in bunches

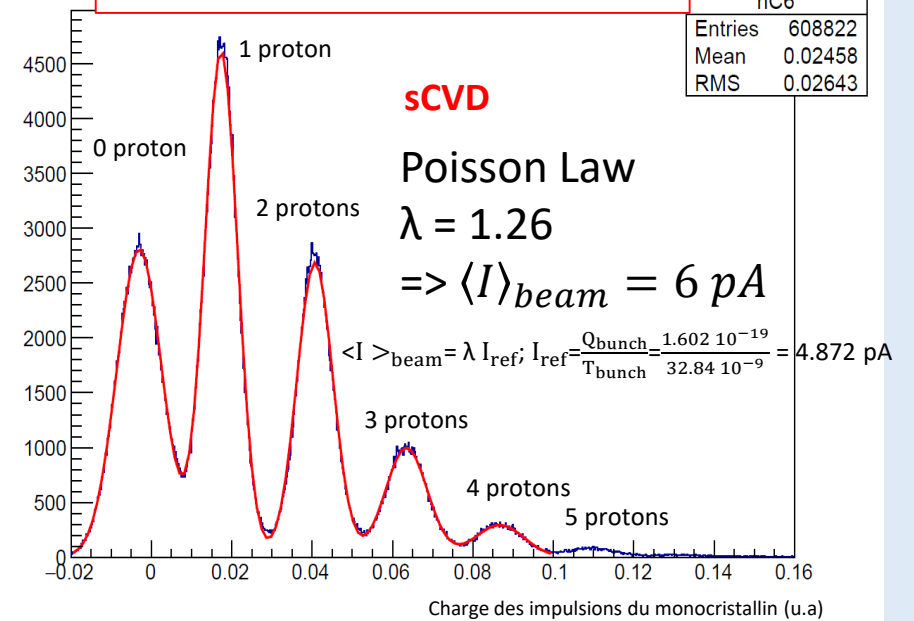

Proton counting in nano pulse

DIAMMONI 2020-2024 (ANR + R&T IN2P3 DIAMTECH)



Particle counting vs I_{beam} : preliminary measurement

Collim.
Ø 1mm

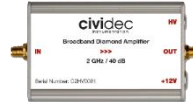
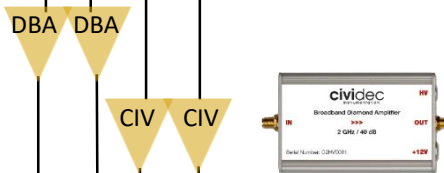
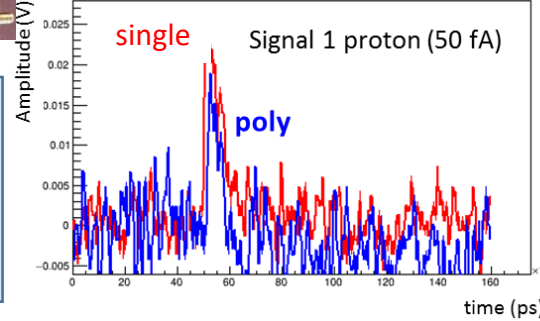
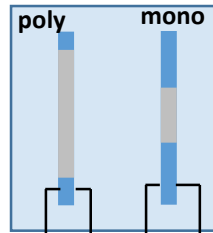
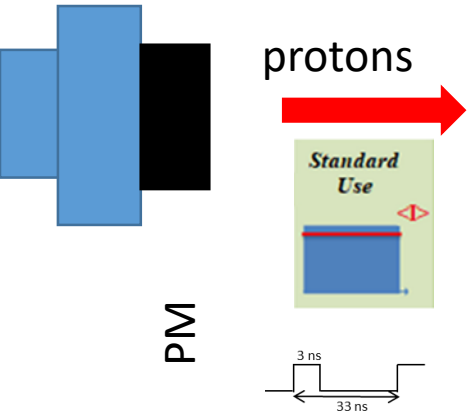

Scope LeCroy
Sampling 2.5 GS/s
4 channels
Acq. window 20 µs

Continuous mode and reduced intensity

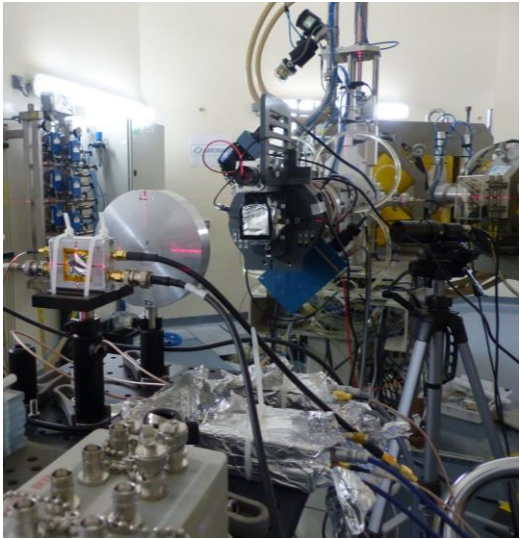

5-7 October 2020 IJCLab

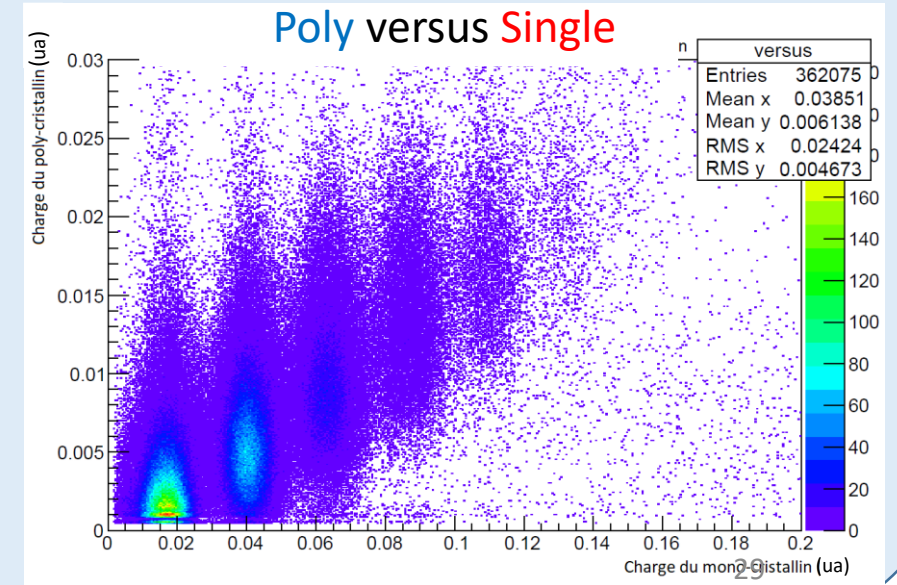
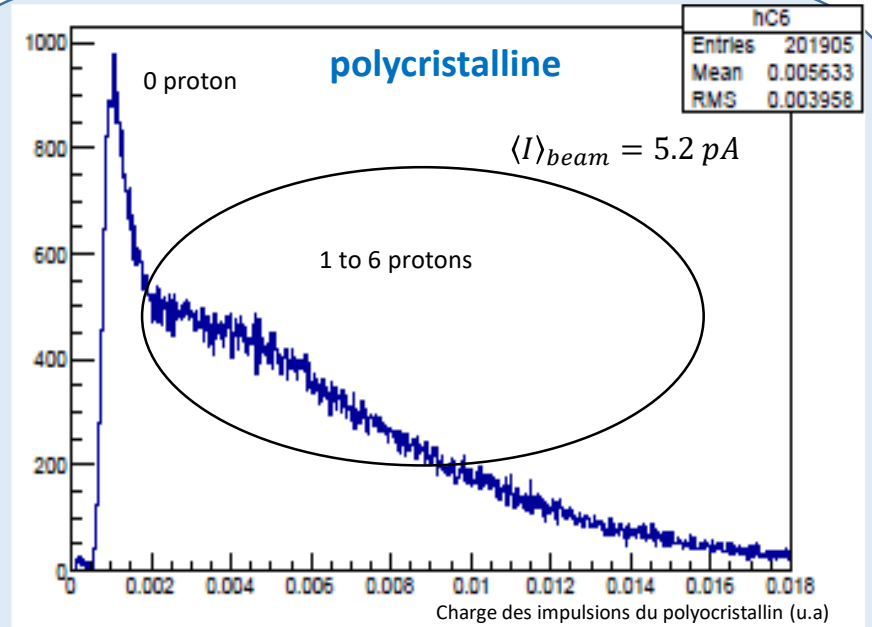

DIAMMONI 2020-2024 (ANR + R&T IN2P3 DIAMTECH)



Particle counting vs I_{beam} : preliminary measurement

Collim.
Ø 1mm

protons

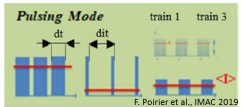

PM

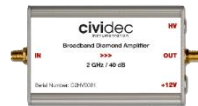
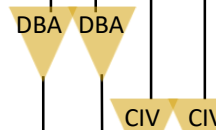
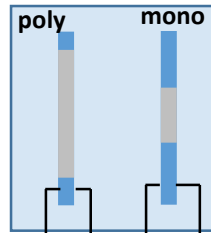

Scope LeCroy
Sampling 2.5 GS/s
4 channels
Acq. window 20 µs

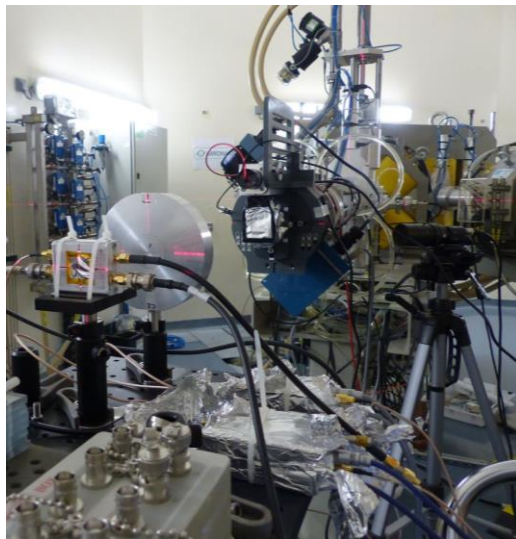

5-7 October 2020 IJCLab

Pulsed mode and $\langle I \rangle_{beam} = 100 \text{ pA}$

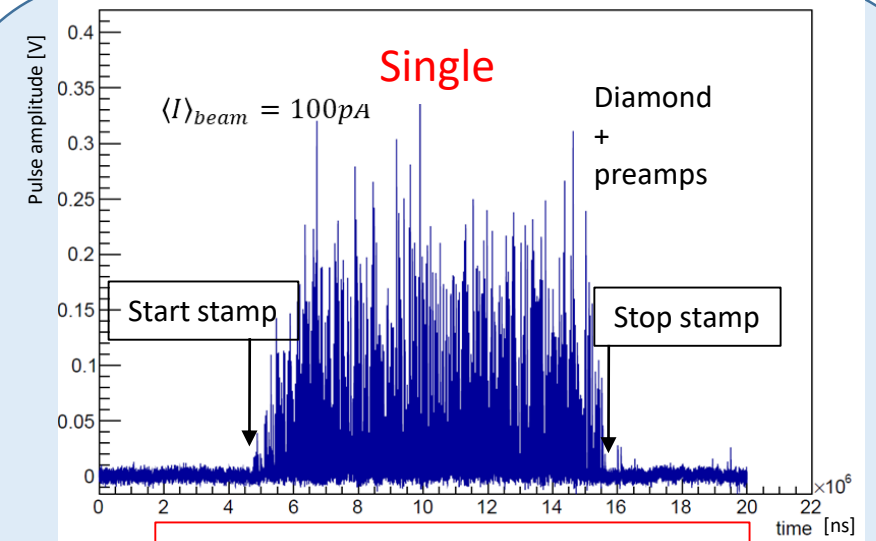

Particle counting in bunches

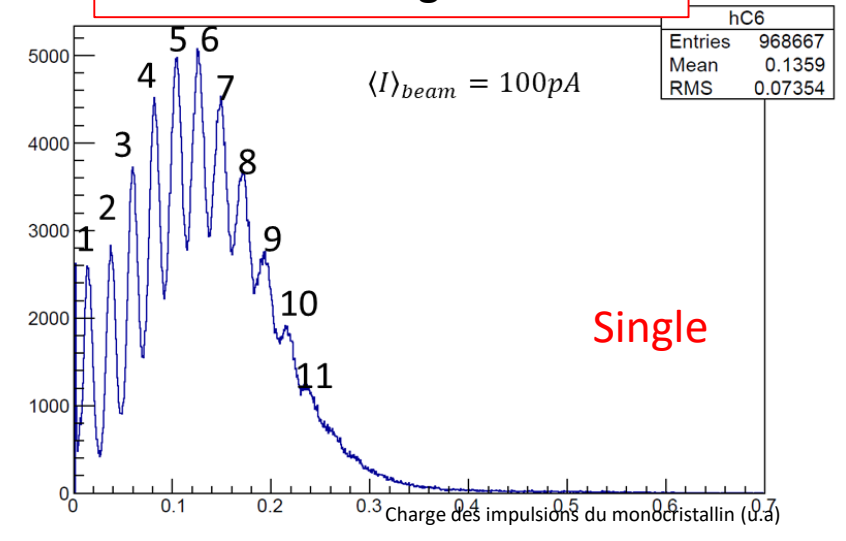

Proton counting in pulses !

DIAMMONI 2020-2024 (ANR + R&T IN2P3 DIAMTECH)



Particle counting vs I_{beam} : preliminary measurement

Collim.
Ø 1mm

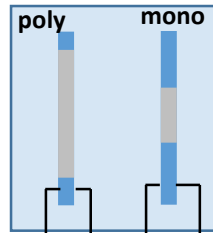
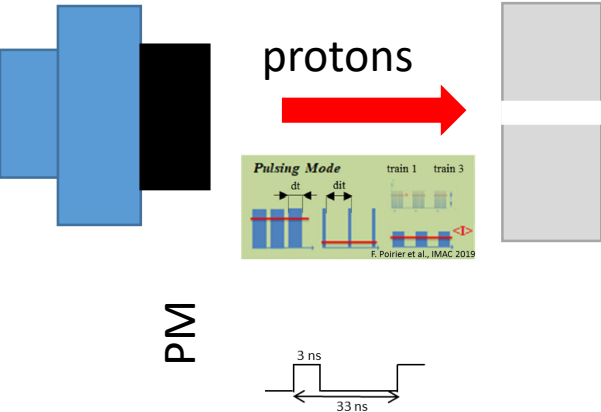

Scope LeCroy
Sampling 2.5 GS/s
4 channels
Acq. window 20 µs

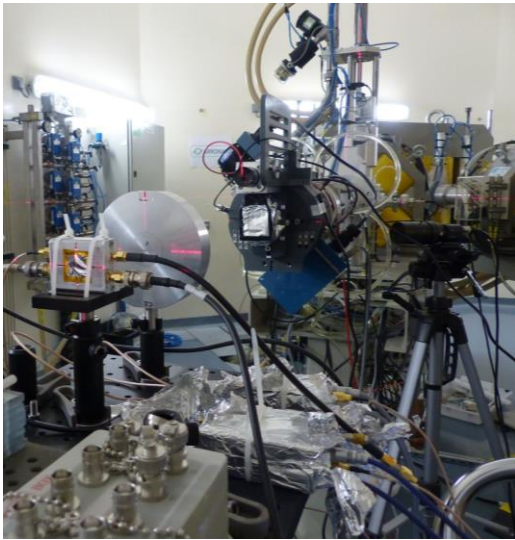

5-7 October 2020 IJCLab

Pulsed mode and $\langle I \rangle_{beam} = 200 \text{ pA}$

Particle counting in bunches

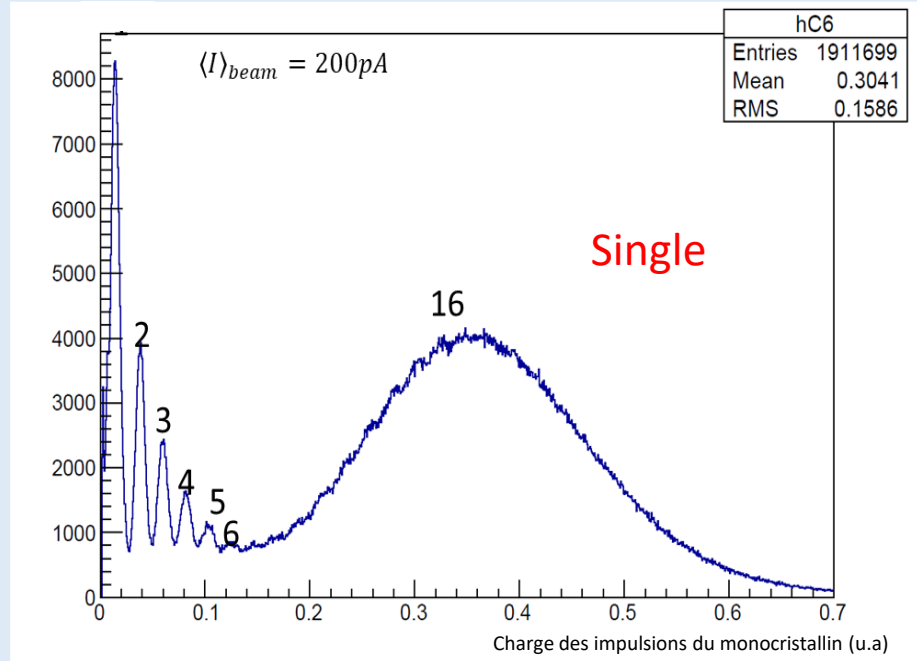

Preliminary Exp.

=> proton counting in bunches at 5.2 pA = calibration
=> proton counting in bunches at 200 pA !

DIAMMONI 2020-2024 (ANR + R&T IN2P3 DIAMTECH)



Particle counting vs I_{beam} : preliminary measurement

Collim.
Ø 1mm



protons

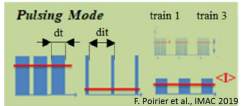

PM

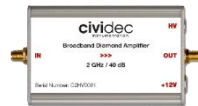
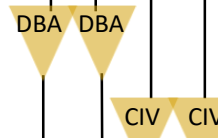
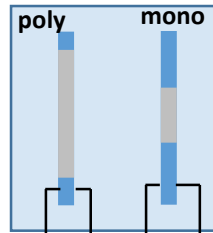

Scope LeCroy
Sampling 2.5 GS/s
4 channels
Acq. window 20 µs

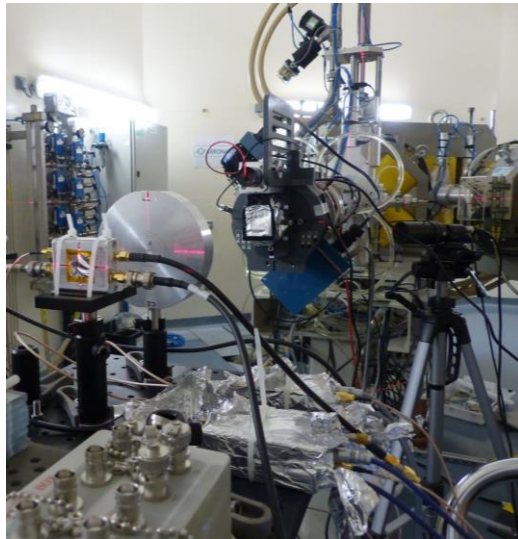

5-7 October 2020 IJCLab

Pulsed mode and $\langle I \rangle_{beam} = 200 \text{ pA}$

Single vs Poly at higher beam intensity ?

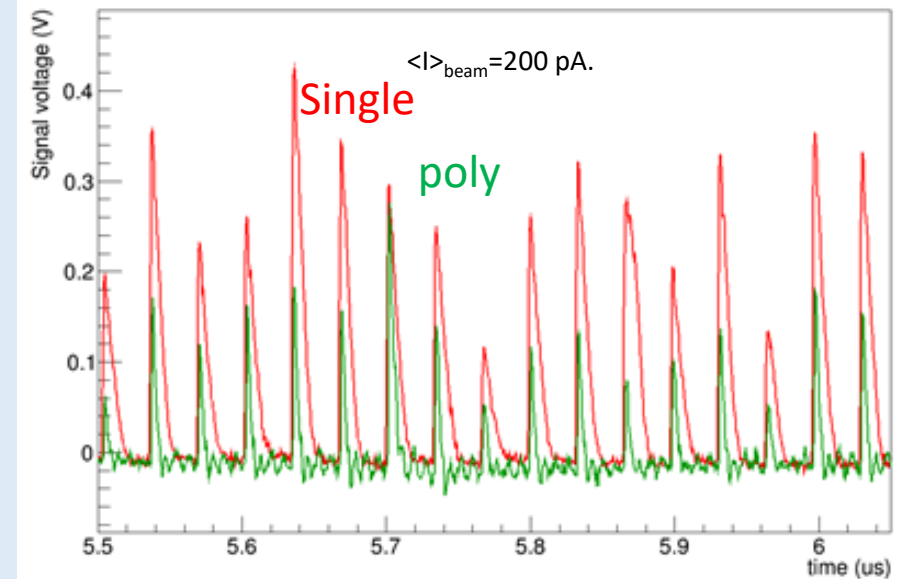

Polycrystalline crystals (pCVD) advantage vs single-crystals (sCVD) !

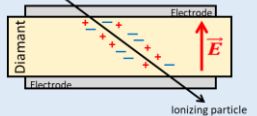

Charge recombination on the path of the charge carriers to the electrode occurs
=> a narrower signal !

DIAMMONI 2020-2024 (ANR + R&T IN2P3 DIAMTECH)



Particle counting vs I_{beam} : preliminary measurement

Collim.
Ø 1mm

protons

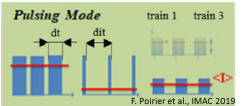

Pulsed mode

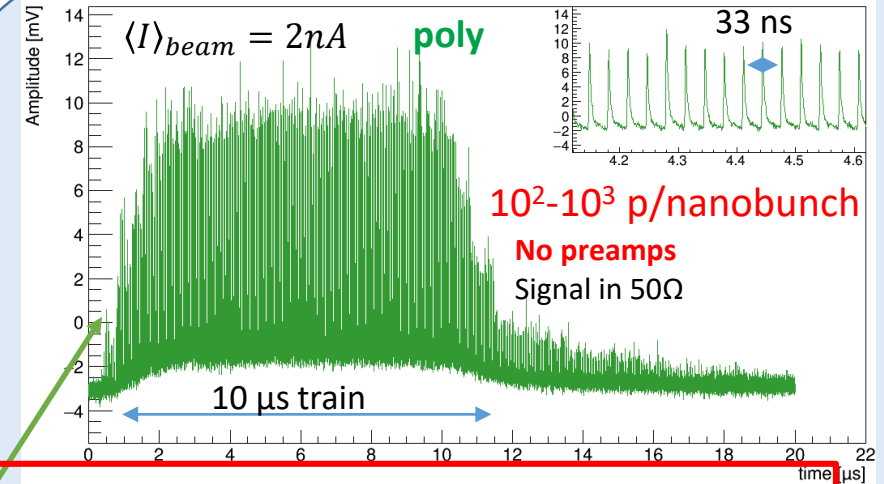
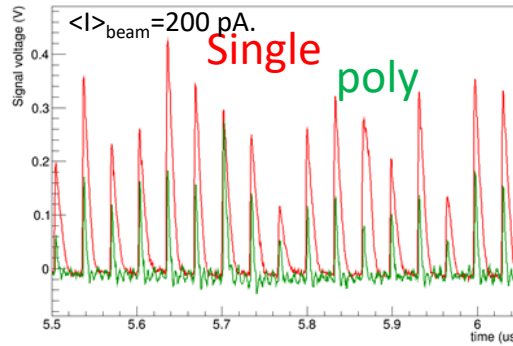
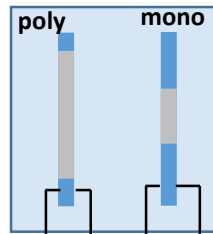

Preliminary results @ 2nA
Flash => $\langle I \rangle_{beam}$ up to μA to be done in Nov. 2020 !

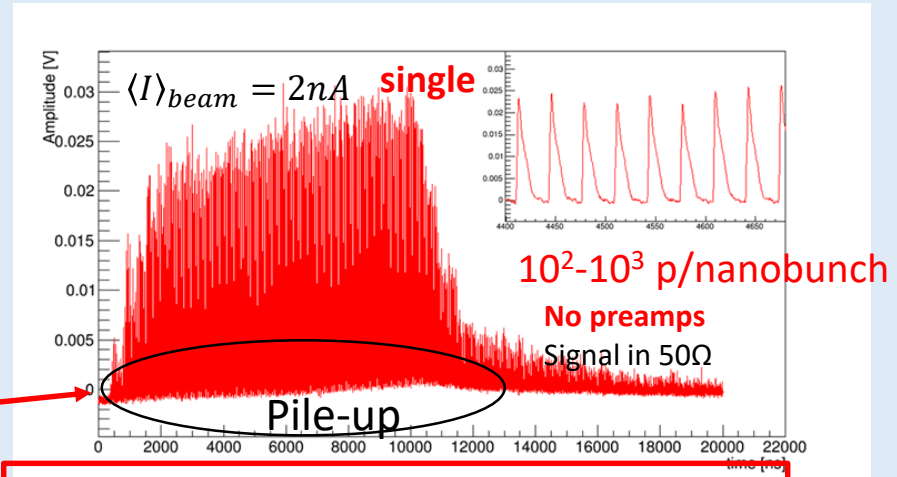

=> Proton counting in train: Ok
=> « start » and « stop » train stamp: Ok !

pCVD instead of sCVD
or
Single diamond to be thinned!
=> ANR-DIAMMONI be investigated in 2020-2024 !

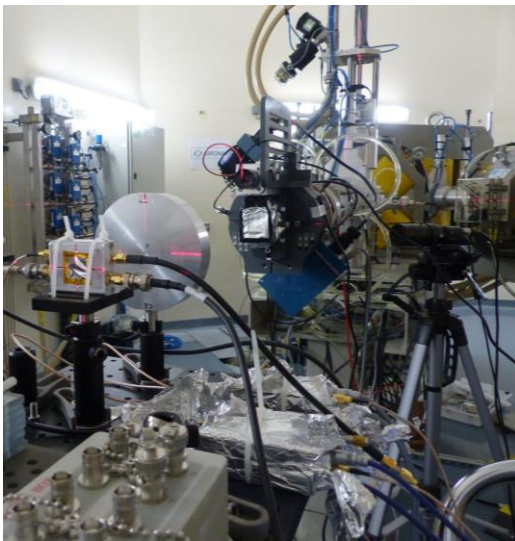

5-7 October 2020 IJCLab

Outlines

- Beam tagging hodoscope for online ion range verification in hadrontherapy
- Diamond for beam monitor development
 - Material intrinsic qualities
 - Detector instrumentation
 - Performances in beam tests
- Development of a diamond beam monitor for innovative radiotherapies using spatially segmented photon beams at ESRF on ID17 medical beam line – IDSYNCHRO R&T Transverse IN2P3
- Diamond application to Flash Therapy : ANR – DIAMMONI
- **Conclusion**

Conclusion

These developments are

- **in connection with collaborations established at IN2P3 (CLaRyS / CLaRyS-UFT– DIAMTECH – ANR DIAMMONI)**
 - **in a context of interdisciplinary research at CNRS (IN2P3, INP, INC): skills exchanges take place between**
 - characterization: sources (labs) + eBIC (Institut Néel) + accelerator beams @ IN2P3 (IP2I GENESIS GANIL...), GIP - ARRONAX, ESRF +...
 - Instrumentation (IN2P3 labs, Institut Néel, etc.)
 - **the proposed detection systems will bring significant added value to the transfer of high dose rate flash radiotherapy to clinical trials**
 - Microbeam Radiation Therapy: **IDSYNCHRO** @ ESRF on ID17 medical beam line : “flash effect” with a 10^4 Gy/s dose rate
 - Proton therapy : a monitoring system derived from the system studied for flash intensities in **DIAMMONI** can be easily implemented in a clinical environment (a few detectors located at ~ 1 m from the patient).
- => 2020-2024 objectives: design of monitors for CLaRyS-UFT + DIAMTECH-IDSYNCHRO + DIAMTECH-DIAMMONI to perform beam diagnostics and radiotherapies monitoring**

Acknowledgements



ESRF

AGENCE NATIONALE DE LA RECHERCHE

ANR



France
HADRON



UNIA



irfu



saclay

The authors would like to acknowledge the **ESRF** for provision of synchrotron radiation facilities and would like to thank the ID21 beamline staff for their assistance with experiment MI-1243.

This work was supported by the **Labex PRIMES** (ANR-11-LABX-0063), **FranceHadron** (ANR-11-INBS-0007) and **ANR MONODIAM-HE** (ANR-089520). **ANR DIAMMONI 219725**

The **CLARA** Canceropole (Oncostarter Project) is thanked.

The authors are grateful to **Matthias Schreck** from the Augsburg University for providing the LPSC laboratory with samples of diamond heteroepitaxially grown.

Dominique Breton from the Laboratoire de l'Accélérateur Linéaire and **Eric Delagnes** from CEA Saclay are thanked for their implication in dedicated software development and technical support of the namely "wavecatcher" data acquisition system.