



HAL
open science

Experiential Integral Backstepping Sliding Mode Controller to achieve the Maximum Power Point of a PV system

Brahim Khalil Oubbati, Mohamed Boutoubat, Abdelhamid Rabhi,
Mohammed Belkheiri

► **To cite this version:**

Brahim Khalil Oubbati, Mohamed Boutoubat, Abdelhamid Rabhi, Mohammed Belkheiri. Experiential Integral Backstepping Sliding Mode Controller to achieve the Maximum Power Point of a PV system. *Control Engineering Practice*, 2020, 102, pp.104570. 10.1016/j.conengprac.2020.104570 . hal-03142265

HAL Id: hal-03142265

<https://hal.science/hal-03142265>

Submitted on 22 Aug 2022

HAL is a multi-disciplinary open access archive for the deposit and dissemination of scientific research documents, whether they are published or not. The documents may come from teaching and research institutions in France or abroad, or from public or private research centers.

L'archive ouverte pluridisciplinaire **HAL**, est destinée au dépôt et à la diffusion de documents scientifiques de niveau recherche, publiés ou non, émanant des établissements d'enseignement et de recherche français ou étrangers, des laboratoires publics ou privés.



Distributed under a Creative Commons Attribution - NonCommercial 4.0 International License

1 Experiential Integral Backstepping Sliding Mode Controller to Achieve 2 the Maximum Power Point of a PV System

3 Brahim Khalil Oubbat^{a,c}, Mohamed Boutoubat^b, Abdelhamid Rabhi^c, Mohamed Belkheiri^a

4 ^aUniversity of Laghouat, LTSS Lab. Laghouat, Algeria

5 ^bUniversity of Laghouat, LACoSERE Lab. Laghouat, Algeria

6 ^cUniversity of Picardie, MIS Lab, Amiens, France

7 **Abstract**

Maximum Power Point Tracking (MPPT) strategy is necessary to extract the maximum power production of a Photovoltaic (PV) system. Since the PV has nonlinear dynamics, it is more suitable to use a nonlinear MPPT controller to improve the tracking efficiency. The modelling and control of most systems in real-time are not fully precise and introduce some variations such as : the steady state error and ripples in the system outputs. In this paper, a classical sliding mode controller has been designed and applied experimentally to the PV system to achieve the Maximum Power Point (MPP). The results show that the system responses present chattering phenomena with no negligible state error. In order to reduce these drawbacks (chattering and steady-state error), an Integral Backstepping combined with a discontinuous Sliding Mode Controller (IBSMC) is proposed and applied experimentally to the PV system. The obtained experimental results for the two controllers are compared under the same weather conditions, in terms of chattering phenomena and state error. As a result, the proposed hybrid controller (IBSMC) has achieved high dynamic system performances. Moreover, the stability of this system has been proved using Lyapunov stability criteria.

8 *Keywords:* Integral Backstepping Sliding Mode Control (IBSMC), PV, MPPT, Lyapunov
9 criteria, Sliding Mode Control (SMC).

10 **1. Introduction**

11 Recently, the power produced by Photovoltaic (PV) systems has gained worldwide popularity
12 for many reasons such as: the decrease of fossil fuels (gas and oil. . .), their abundant availability,
13 and their eco-friendly aspect [1].

14

Email addresses: i.oubbati@lagh-univ.dz (Brahim Khalil Oubbat), boutoubat90@yahoo.fr (Mohamed Boutoubat), abdelhamid.rabhi@u-picardie.fr (Abdelhamid Rabhi)

Preprint submitted to Elsevier

May 31, 2020

15 Besides, the generated PV power magnitude depends mainly on the variation of the weather
16 conditions such as the temperature, humidity, and the amount of the received global solar radi-
17 ations. Moreover, the choice of the controller's types has also its effect on the system responses,
18 more precisely in the MPPT mode [2].

19 Generally, the term MPPT refers to the maximum power point tracking controller that is nec-
20 essary to force a PV system to operate at its maximum power point. Nowadays, many MPPT
21 techniques ranged from conventional and unconventional approaches has been proposed. the meth-
22 ods proposed in the literature, and that guarantee the maximum power produced from PV panels,
23 could be categorise as follow :

24 First, the conventional control algorithms such as: incremental conductance [3], fractional short
25 circuit current, open-circuit voltage, and Perturb an Observe (P&O)[4, 5], achieve the maximum
26 point based on the P-V characteristic curve. In addition, hill-climbing algorithms are based on
27 introducing a net, negative or positive (increase or decrease) values. However, the main issue of
28 these algorithms is the system response fluctuations (produced power, load current...). Even if
29 the Maximum Power Point (MPP) is achieved, and by a consequence, the overall system will lose
30 its efficiency and power quality.

31 The second important category, namely ; Meta-Heuristic optimization techniques such as Salp
32 Swarm algorithm (SSA), Grey wolf optimization (GWO), Genetic Algorithm (GA), Particle Swarm
33 Optimization (PSO) and Ant Colony Optimization (ACO) [6, 7, 8, 9, 10] have been efficiently
34 tested to search the maximum Power Point under partial shading conditions. Generally, they use
35 the same procedure to optimize the maximum Power Point. Their efficiency depends strongly on
36 the population of different individuals, from which each individual can represent a solution. A
37 minimization process between each individual and their parents using a cost function is done for
38 each iteration in order to achieve the best goal. The main advantage of these algorithms is that
39 the chance of reaching the MPPT is very high [11].

40 Moreover, other algorithms category which are widely used in the case of a shaded PV systems
41 are the Artificial Intelligent AI and fuzzy logic controllers for MPPT applications [12]. In [13], an
42 Artificial Neural Network (ANN) is used to detect the region containing the global MPP. After
43 that, the P&O algorithm is introduced to find the optimum point of the maximum power. However,
44 these algorithms decrease the system efficiency and are known by their implementation complexity
45 [14]. On the other hand, fuzzy logic based control methods can do it better thanks to their short

46 response time to reach the MPP [15, 16, 17] . However, the performances of these systems depends
47 strongly on logic condition (IF-Else) law bases.

48 Consequently, many works have studied a different kind of MPPT strategies. From literature,
49 we distinguish to main techniques. The first one is called a voltage-oriented MPPT (VO-MPPT)
50 in cascade with a voltage controller, and the second one is called a current-oriented MPPT (CO-
51 MPPT) in cascade with a current controller. In this case, the previous mentioned techniques such
52 as: P&O,INC , will be used to generate the reference value (either current or voltage reference).

53 Based on this review, linear controllers strategies can improve the efficiency of the system to
54 find the MPP. The aim of using linear controllers is to adjust accurately the required MPPT duty
55 cycle which improves the dynamic system performances. However, the controller's performance
56 depends entirely on their selected parameters in order to produce the maximum power. These
57 parameters can be enhanced using optimization methods such as genetic algorithms, which are
58 used for PID controller parameters optimization in [18]. Other linear control algorithms can be
59 found such as Ziegler Nichols tuning method used to determine the optimal gain of PID controller
60 to improve the P&O-MPPT performance of grid connected PV system [19]. However, despite the
61 main advantages of linear controllers to solve the MPPT problems, they are not able to reduce the
62 state error and ripples.

63 This stability problem is due essentially to the nonlinear nature of the PV system. Linearization
64 methods are proposed to model the converters with the assumption that they respond linearly to
65 the varying duty cycle. However, they also experience nonlinear behaviour. Hence, as a solution,
66 nonlinear controllers are introduced in several researches such as the backstepping and sliding mode
67 control [20, 21, 22, 23, 24, 25, 26]. They are used to track the MPP of PV modules. The main
68 advantage of these controllers is the robustness and stability of the overall system while tracking
69 the MPP. However, the main drawbacks of such techniques are the important steady-state error
70 and chattering phenomena.

71 There are many sliding mode controllers that have been designed to cope with the steady-
72 state error and chattering phenomenon. The traditional SMC with an integral action added to
73 the sliding surface (ISMC) is proposed in [27]. The proposed ISMC has been compared with
74 traditional SMC in terms of reducing the steady-state error. This controller offers a fixed frequency
75 operating through PWM-based control. Nevertheless, chattering phenomenon and overshoot has
76 been observed by using this controller (ISMC). Other works have added another integral action

77 term to the sliding surface (double integral) as illustrated in [28], in order to more reduce the steady-
78 state error. This controller has achieved more minimization in the steady-state error. However,
79 the amount of the overshooting increased considerably.

80 In [29], the authors have proposed an adaptive integral derivative sliding mode (AIDSM) con-
81 troller to eliminate the overshoot and minimize the steady-state fluctuation. The implementation
82 of this controller by using the Hardware-in-loop (HIL) has performed a good performance in terms
83 of eliminating the overshoot and the steady-state fluctuation. This controller has been compared
84 with the conventional P&O method.

85 Generally, the main drawbacks associated with the SMC family is that, in the case of imple-
86 menting the r th-order sliding mode controller, the SMC needs knowledge of $S, \dot{S}, \ddot{S}, \dots, S^{(r-1)}$ and
87 and high implementation complexity.

88 In [30], a backstepping controller with integral action has been proposed to extract the max-
89 imum power produced from the PV system. This controller is very efficient and robust, but its
90 performance depends totally on the system modelling accuracy. Additionally, in their contribu-
91 tion, the authors used a non-inverting buck-boost as an interface between the PV system and load,
92 which leads to a complex system model. Furthermore, the authors have assessed the controller
93 performances by simulation without any experimental results.

94 The principal objective of this paper is to alleviate these drawbacks using a proposed integral
95 backstepping sliding mode controller (IBSMC). This controller is based on a combination of an
96 integral backstepping and a discontinuous classical sliding mode controller. The proposed con-
97 troller has been verified firstly by simulation tests using Matlab/Simulink software, in order to
98 evaluate the ability of this controller to respond under fast irradiation condition changing, robust-
99 ness and performance. Secondly, the performances of this controller (IBSMC) have been compared
100 experimentally with traditional sliding mode in terms of reducing the steady-state error and the
101 chattering phenomenon. The scheme of the global studied system is shown in Fig.1.

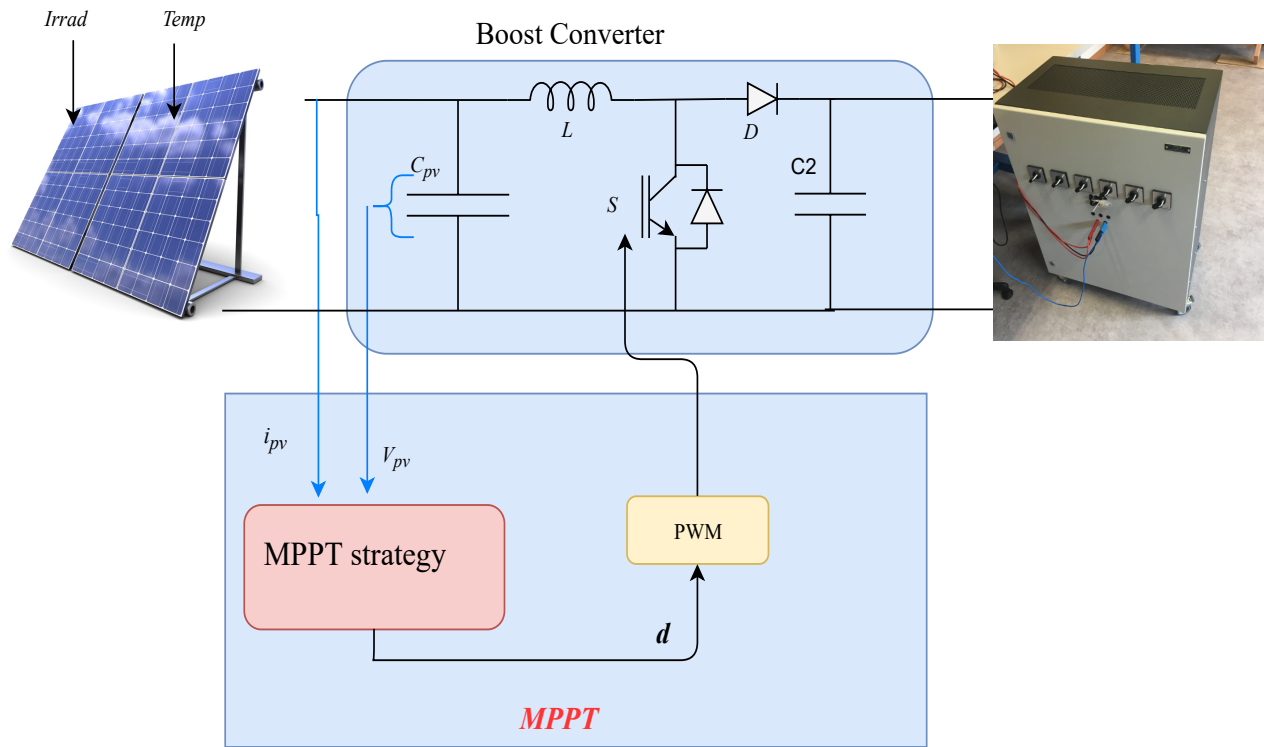

Figure 1: Global system scheme.

102 2. System modelling

103 2.1. PV system modelling

104 Photovoltaic system modelling is amply detailed in literature [31]. Hence, in this paper, we
 105 will present only the main equations that describe its electrical behavior.

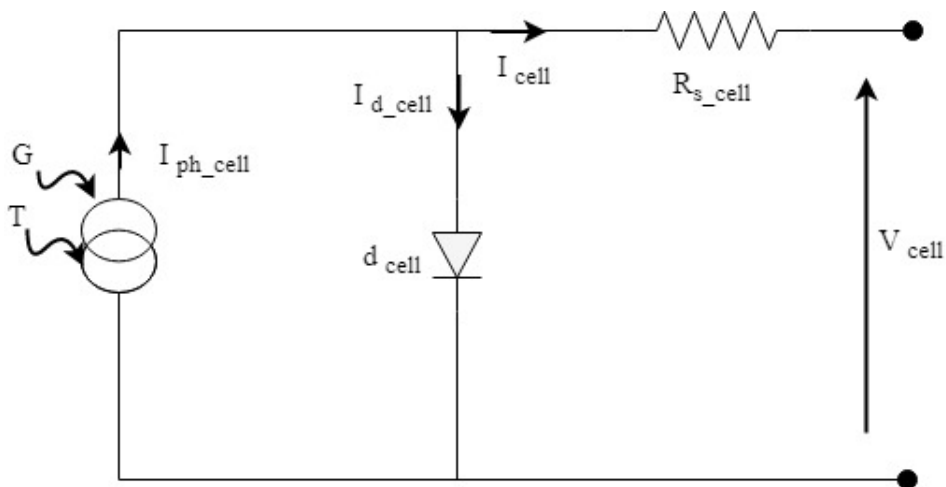

Figure 2: Equivalent PV circuit system based on the ohmic losses.

106 The output current of this module is given by:

$$i_{pv} = I_{ph_cell} N_p M_p - N_p M_p I_0 \exp \left(\frac{\frac{v_M}{N_s M_s} + R_{cell} \frac{I_M}{N_p M_p}}{n_{pn} k_b \frac{T}{q}} \right) \quad (1)$$

107 2.2. Boost converter modelling

108 Generally, the main role of using the DC-DC boost converter is to push the PV system to pro-
 109 duce the maximum power to the load. The differential classical equations expressed the dynamics
 110 of the boost converter are given as follows [32]:

$$\begin{cases} L \frac{di}{dt} = -(1-d)V_c + V_{pv} \\ C \frac{dV_c}{dt} = (1-d)i_L - \frac{V_c}{R} \end{cases} \quad (2)$$

111 Using the average mode over one switching period and assuming x_1 , x_2 and d to be an average
 112 value of i_L , V_c and u , which are defined as follows:

$$\begin{cases} x_1 = \langle i_L \rangle \\ x_2 = \langle V_c \rangle \\ u = \langle d \rangle \end{cases} \quad (3)$$

113 So, Eq.(2) takes the following form:

$$\begin{cases} \dot{x}_1 = -\frac{(1-u)}{L} x_2 + \frac{V_{pv}}{L} \\ \dot{x}_2 = \frac{(1-u)}{C} x_1 - \frac{x_2}{RC} \end{cases} \quad (4)$$

114 This averaged state-space model will be used to the design different controllers (integral back-
 115 stepping sliding mode and classical sliding mode) considered in this paper.

116 3. Different MPPT controllers design

117 3.1. Proposed integral backstepping sliding mode controller design

118 The controller is based on the combination of an integral backstepping and a discontinuous
 119 sliding mode. Its control scheme is shown in Fig.3. In fact, to achieve the MPP for the PV panel,
 120 the structured scheme of this controller is based principally on two loops; the first one is based
 121 on a simple conventional method P&O to generate the reference value of the MPPT-PV current
 122 (I_{pv-ref}). For more smoothing the required MPPT duty cycle form, a second control loop based
 123 on a nonlinear IBSM controller is proposed to regulate the instantaneous PV current I_{pv} to its

124 reference MPPT value I_{pv-ref} and achieve consequently a smooth and an accurate MPPT duty
 125 cycle value of the boost converter. As a result, a smooth output PV power is produced to the load
 126 with improved power quality.

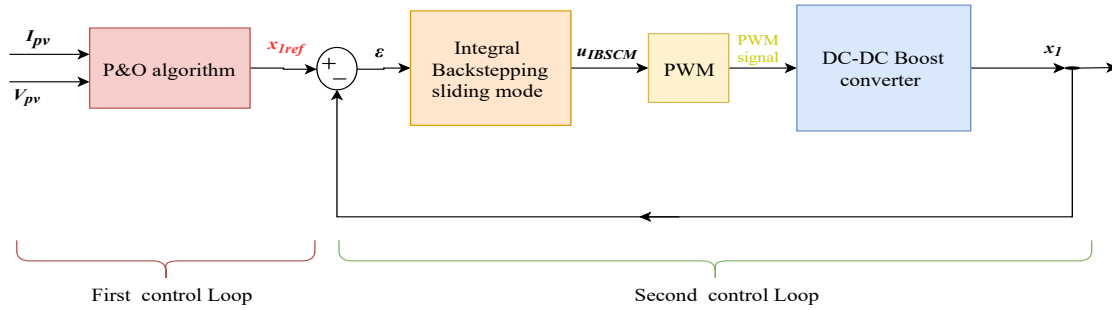

Figure 3: The global proposed closed-loop system control.

127 The flowchart of the proposed controller algorithm is depicted in Fig.4.

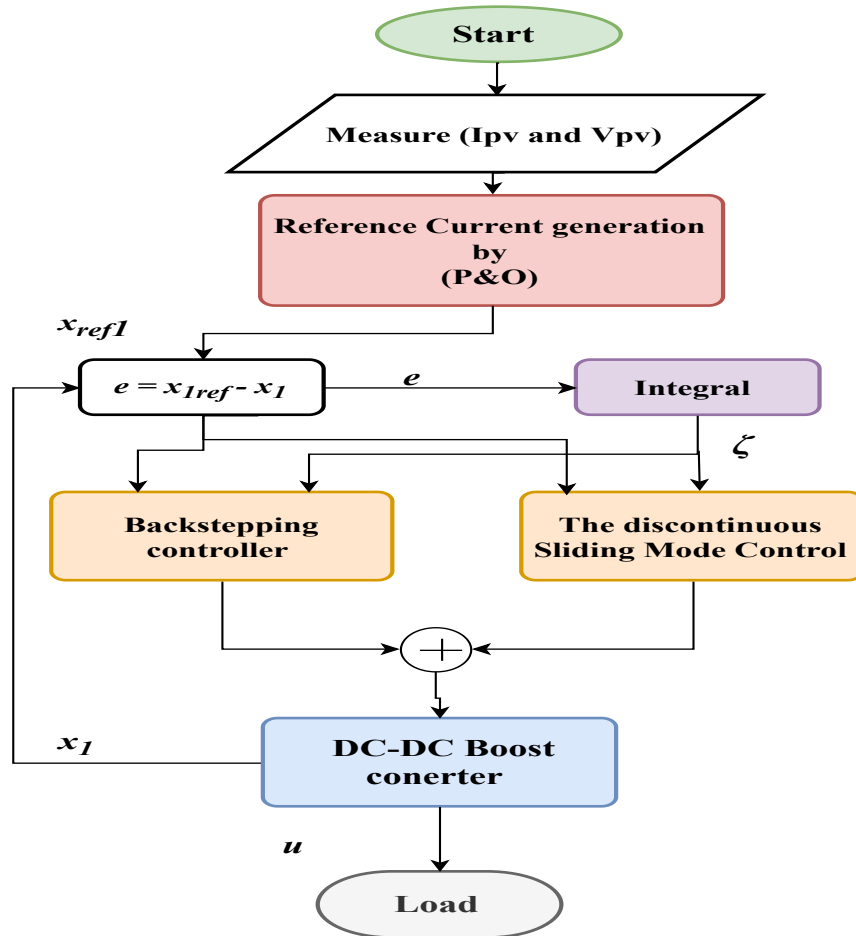

Figure 4: IBSMC proposed algorithm.

128 *3.2. Reference MPPT PV current generated by a classical method (P&O)*

129 Known as the featuring effective and simplicity of the classical P&O technique. Hence, it is
 130 more suitable to generate the reference MPPT value of the PV current (which corresponds to the
 131 maximum peak of the PV power). The flowchart of P&O algorithm is shown in Fig.5.

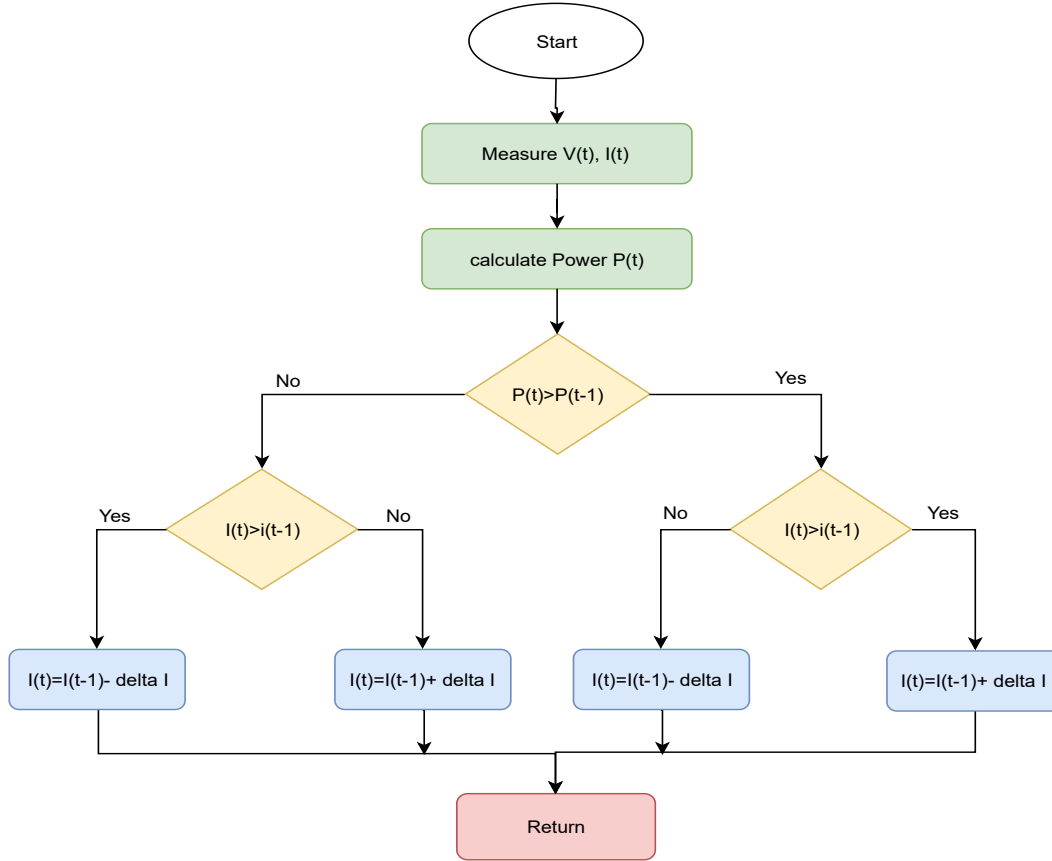

Figure 5: P&O algorithm.

132 *3.3. Integral backstepping sliding mode control*

133 In this paper, a nonlinear backstepping sliding mode structure is enhanced by introducing an
 134 integral action and a discontinuous sliding mode term in order to minimize the actual PV current
 135 error between the output PV current and its reference MPPT current (I_{pv-ref}) and to reduce the
 136 chattering ripples. The main role of the IBSM controller is to produce a smooth and an accurate
 137 duty cycle command value of the boost converter using the PV-MPPT current reference (I_{pv-ref})
 138 value in order to force the PV system to track the maximum power point (MPPT) with a minimal
 139 state error and reduced chattering phenomena. The controller structure (see Fig. 4) contains

140 the reference MPPT current (I_{pv-ref}) generated by classical method (P&O). Then, Based on the
 141 error of the PV current and its MPPT reference current, the IBSMS generate the required MPPT
 142 duty cycle (u)(see Fig.3.). The IBSMC output command (u_{IBSMC}) includes two parts; equivalent
 143 integral backstepping (u) and discontinuous sliding mode (u_{dis}), as given in Eq.(5).

$$u_{IBSMC} = u + u_{dis} \quad (5)$$

144 Based on the IBSMC flowchart (Fig.4) , the error between the actual ($x_1 = I_{pv}$) and the MPPT
 145 required output PV current ($x_{1ref} = I_{pv-ref}$), is writing as:

$$\varepsilon_1 = x_1 - x_{1ref} \quad (6)$$

146 Our principal aim is to force this error to be zero. So and By deriving Eq. (6) and using Eq.
 147 (4), we obtain:

$$\dot{\varepsilon}_1 = \dot{x}_1 - \dot{x}_{1ref} = -\frac{(1-u)}{L}x_2 + \frac{V_{pv}}{L} - \dot{x}_{1ref} \quad (7)$$

148 The addition of the integral action of ε_1 the error term leads to:

$$e_1 = \varepsilon_1 + \zeta \quad (8)$$

149 With the integral term written as follows:

$$\zeta = \int_0^t (x_1 - x_{1ref})dt \quad (9)$$

150 In order to guarantee the convergence of the error (ε_1) to zero, the positive candidate of the
 151 Lyapunov function is chosen as:

$$V_1 = \frac{1}{2}\varepsilon_1^2 + \frac{1}{2}\kappa\zeta^2 \quad (10)$$

152 Where, κ is a positive definite real number which is needed to guarantee asymptotic system
 153 stability.This task is ensured if the time derivative of the Lyapunov function is always negative
 154 .The derivation of equation (10) gives:

$$\dot{V}_1 = \varepsilon_1\dot{\varepsilon}_1 + \kappa\zeta\dot{\zeta} \quad (11)$$

155 By using the time derivative of Eq. (9) and Eq. (7), we get:

$$\dot{V}_1 = \varepsilon_1 \left(-\frac{(1-u)}{L}x_2 + \frac{V_{pv}}{L} - \dot{x}_{1ref} \right) + \kappa\zeta (x_1 - x_{1ref}) \quad (12)$$

156 The replacement of Eq. (6) in Eq. (12) permits to write:

$$\dot{V}_1 = \varepsilon_1 \left(-\frac{(1-u)}{L}x_2 + \frac{V_{pv}}{L} - \dot{x}_{1ref} + \kappa\zeta \right) \quad (13)$$

157 In order to guarantee the asymptotic system stability, \dot{V}_1 must be negative, the term $(-\frac{(1-u)}{L}x_2 +$
 158 $\frac{V_{pv}}{L} - \dot{x}_{1ref} + \kappa\zeta)$ in Eq. (13), is expressed by the following equation:

$$-\frac{(1-u)}{L}x_2 + \frac{V_{pv}}{L} - \dot{x}_{1ref} + \kappa\zeta = -k_1\varepsilon_1 \quad (14)$$

159 Where k_1 is positive scalar. Therefore, \dot{V}_1 becomes:

$$\dot{V}_1 = -K_1\varepsilon_1^2 \quad (15)$$

160 Rewriting Eq. (14) as:

$$x_2 = \frac{L}{(1-u)} \left(\frac{V_{pv}}{L} - \dot{x}_{1ref} + \kappa\zeta + K_1\varepsilon_1 \right) \quad (16)$$

161 Whereas Eq.(16) is chosen as the reference voltage of the capacitor voltage , and is rewritten in
 162 the following form:

$$\lambda = \frac{L}{(1-u)} \left(\frac{V_{pv}}{L} - \dot{x}_{1ref} + \kappa\zeta + K_1\varepsilon_1 \right) \quad (17)$$

163 In order to guarantee the convergence of the actual value of the capacitor voltage (x_2) to its
 164 reference MPPT value (λ), a capacitor voltage error ε_2 is defined as follows:

$$\varepsilon_2 = x_2 - \lambda \quad (18)$$

165 Rewriting Eq. (17) as follow:

$$x_2 = \lambda + \varepsilon_2 \quad (19)$$

166 By Laying Eq. (7) in Eq. (19), we obtain:

$$\dot{\varepsilon}_1 = -\frac{(1-u)}{L}(\varepsilon_2 + \lambda) + \frac{V_{pv}}{L} - \dot{x}_{1ref} \quad (20)$$

167 The Replacement of λ from Eq. (17) in Eq. (20) gives:

$$\dot{\varepsilon}_1 = -\frac{(1-u)}{L}\varepsilon_2 - \kappa\zeta - k_1\varepsilon_1 \quad (21)$$

168 So, Eq. (11) can be rewritten as follow:

$$\dot{V}_1 = \varepsilon_1 \dot{\varepsilon}_1 + \kappa \zeta \dot{\zeta} = -k_1 \varepsilon_1^2 - \frac{\varepsilon_2 \varepsilon_1 (1-u)}{L} \quad (22)$$

169 The first term in Eq. (22) has always a negative definite form. However, we don't have any
 170 information about the second term form. By using the time derivative of Eqs. (17) and (18), we
 171 obtain respectively the following expressions:

$$\dot{\varepsilon}_2 = \dot{x}_2 - \dot{\lambda} \quad (23)$$

$$\dot{\lambda} = \frac{L}{(1-U)} \left(\frac{\dot{V}_{pv}}{L} - \ddot{x}_{1ref} + \kappa \dot{\zeta} + k_1 \dot{\varepsilon}_1 \right) - \frac{\dot{u}}{(1-u)^2} L \left(\frac{V_{pv}}{L} - \dot{x}_{1ref} + \kappa \zeta + K_1 \varepsilon_1 \right) \quad (24)$$

172 By using Eqs. (6), (9), (17), (21) for simplifying $\dot{\lambda}$, we get:

$$\dot{\lambda} = \frac{L}{(1-U)} \left(k_1 \left(-\frac{(1-u)}{L} \varepsilon_2 - \kappa \zeta - K_1 \varepsilon_1 \right) + \frac{\dot{V}_{pv}}{L} - \ddot{x}_{1ref} + \kappa \varepsilon_1 \right) - \frac{\dot{u}}{(1-u)} \lambda \quad (25)$$

173 Putting $\dot{\lambda}$ from Eq. (30) in Eq. (28), $\dot{\varepsilon}_2$ becomes:

$$\dot{\varepsilon}_2 = \dot{x}_2 - \frac{L}{(1-U)} \left(k_1 \left(-\frac{(1-u)}{L} \varepsilon_2 - \kappa \zeta - K_1 \varepsilon_1 \right) + \frac{\dot{V}_{pv}}{L} - \ddot{x}_{1ref} + \kappa \varepsilon_1 \right) - \frac{\dot{u}}{(1-u)} \lambda \quad (26)$$

174 In order to ensure convergence of both ε_2 and ε_1 to 0, a new composite Lyapunov function
 175 V_2 is defined, whose time derivative must be always negative in order to permit to the system to
 176 achieve the MPPT with a global stability guaranteed.

$$V_2 = V_1 + \frac{1}{2} \varepsilon_2^2 \quad (27)$$

177 Taking the derivative of Eq.(27) and using Eq.(22) we obtain:

$$\dot{V}_2 = \dot{V}_1 + \varepsilon_2 \dot{\varepsilon}_2 = -k_1 \varepsilon_1^2 - \frac{\varepsilon_2 \varepsilon_1 (1-u)}{L} + \varepsilon_2 \dot{\varepsilon}_2 \quad (28)$$

$$\dot{V}_2 = \dot{V}_1 + \varepsilon_2 \dot{\varepsilon}_2 = -k_1 \varepsilon_1^2 + \varepsilon_2 \left(\dot{\varepsilon}_2 - \frac{\varepsilon_1 (1-u)}{L} \right) \quad (29)$$

178 To guarantee that \dot{V}_2 has a negative form, we pose:

$$\dot{\varepsilon}_2 - \frac{\varepsilon_1 (1-u)}{L} = -k_2 \varepsilon_1 \quad (30)$$

179 With K_2 is a positive scalar, so \dot{V}_2 becomes:

$$\dot{V}_2 = -k_1\varepsilon_1^2 - k_2\varepsilon_2^2 \quad (31)$$

180 Putting Eqs. (4) and (26) in (30), we obtain :

$$\begin{aligned} & \frac{1}{L}x_1(1-u) - \frac{x_2}{RC} + k_1\varepsilon_1 + k_1\kappa\zeta\frac{L}{(1-u)} + k_1^2\varepsilon_1\frac{L}{(1-u)} - \frac{\dot{V}_{pv}}{(1-u)} + (\ddot{x}_{1ref} - \varepsilon_1)\frac{L}{(1-u)} + \frac{\dot{u}}{(1-u)}\lambda - \varepsilon_1\frac{(1-u)}{L} \\ & = -k_2\varepsilon_2 \end{aligned} \quad (32)$$

181 From Eq. (32), one can write:

$$\begin{aligned} \dot{u} = & \frac{(1-u)}{\lambda} \left(\varepsilon_1 \frac{(1-u)}{L} \right) + \frac{(1-u)}{\lambda} \left(-\frac{Lk_1\kappa\zeta}{(1-u)} - \frac{k_1^2\varepsilon_1L}{(1-u)} + \varepsilon_1\frac{L}{(1-u)} - \frac{L}{(1-u)}\ddot{x}_{1ref} \right) + \frac{(1-u)}{\lambda} \left(\frac{\dot{V}_{pv}}{L} + \varepsilon_1\frac{(1-u)}{L} \right) \\ & + \frac{(1-u)}{\lambda} \left(-k_2\varepsilon_2 - \frac{1}{L}x_1(1-u) + \frac{x_2}{RC} - k_1\varepsilon_2 \right) \end{aligned} \quad (33)$$

182 Where $\lambda \neq 0$ and $u \in [0, 1]$.

183 The integration of this last equation gives the required MPPT duty cycle value (u) (equivalent
184 IBS command in Eq (5)). Since the boost duty cycle command (Eq(??)) is calculated based on
185 Lyapunov criteria, the global system stability is always ensured.

186 3.4. Discontinuous Sliding mode control

187 In this section, the discontinuous sliding mode term (u_{dis}) in Eq(5) is determined. The surface
188 of sliding is considered as follow:

$$S = e_1 = \varepsilon_1 + \zeta \quad (34)$$

189 The main objective of using the discontinuous controller is to reduce the chattering ripples, in
190 the case of considering the external disturbances. The discontinuous sliding mode control law can
191 be written as follows[29]:

$$u_{dis} = -k_3 \frac{S}{|S| + \delta} \quad (35)$$

192 Where k_3 is a large constant value which is chosen to ensure the system stability condition and δ
193 is a small positive number which is designed using results of simulation and experiments, in order
194 to reduce the chattering phenomena effect. Finally by adding Eq. (35) to the integration of the
195 Eq. (??, the proposed integral backstepping sliding mode control output is given by:

$$u_{IBSMC} = u + u_{dis} \quad (36)$$

196 4. Classical sliding mode

197 In order to compare the performances of the proposed IBSMC and the classical sliding mode
198 in terms of state error minimization and chattering phenomena reduction, this section is dedicated
199 to describing briefly the structure a classical sliding mode controller. In this work, we have chosen
200 to use a sliding mode strategy developed in [20]. Authors have proposed a simple sliding mode
201 approach to achieve the maximum power point for the PV array. The different principal equations
202 of this approach are given as follows:

$$S_1 = \varepsilon_1 = x_1 - x_{1ref} \quad (37)$$

$$u_1 = \frac{1}{2}(1 + \text{Sign}(S_1)) \quad (38)$$

$$u_1 = \begin{cases} 1 & \text{if } S_1 > 0 \\ 0 & \text{if } S_1 < 0 \end{cases} \quad (39)$$

203 Where S_1 is the sliding surface and u is the signal control of the boost converter. The stability of
204 this controller is analyzed based on the Lyapunov criteria in[20].

205 5. Simulation results and discussions

206 In order to prove the performances of the proposed controller, Matlab / SIMULINK is used
207 to perform the system dynamic responses. Our main objective is to analyze and compare the
208 performances of two nonlinear controllers (IBSMC and classical SMC) in order to track the
209 MPP of PV panel under the same conditions of the weather. The studied system consists of
210 a boost converter circuit feeding a resistor load. A PV panel that contains commercial PV mod-
211 ules "BISOLPV Monocrystalline/BMO300Wc" whose parameters panel are mentioned in Ta-
212 ble.1. Moreover, Table.2 summarized the IBSMC controller parameters and the boost converter
213 design. In order to compare the performances of the two controllers for MPP searching, two cases
214 of the irradiation are considered ($1000W/m^2$ and $728W/m^2$) with a fixed temperature value of $25C^0$
215 (see Table 2). This simulation tests have been preformed to evaluate the ability and robustness of
216 the proposed controller under fast irradiation condition changing.

Table 1: Parameters of PV module

Module Parameters	Value
Power at MPP $P_{mpp}(W)$	300
short circuit current $I_{cc}(A)$	9.75
voltage at MPP $V_{mpp}(V)$	31.9
current at MPP $I_{mpp}(V)$	9.40
open circuit voltage $V_{co}(A)$	39.8
module yield η_M [%]	18,4

Table 2: Parameters of boost converter and controller

parameter	value
$k1$	700
$k2$	8240.65
$k3$	0.01
k	1207
δ	0.5
Inductor, L	1 mH
Capacitor, $C1$	200 μF
capacitor , $C2$	2200 μF
load resistor, R	12 Ω

217 Fig.6 shows the $I - V$ and $P - V$ characteristics of the PV module with a fixed temperature
218 and the two considered irradiation values.

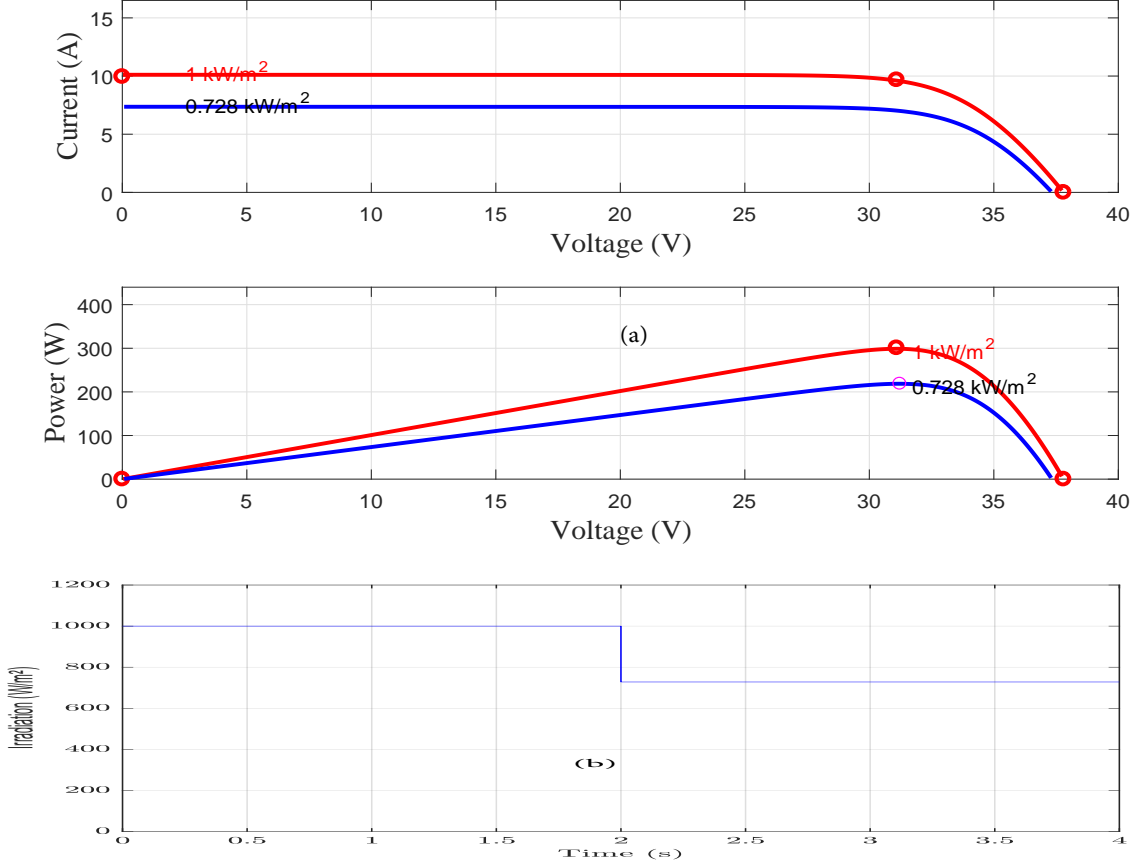

Figure 6: a) PV module characteristics, b) Irradiation (W/m^2).

219 In order to perform a comparison between IBSMC and SMC performances, the PV-current,
 220 PV-voltages, PV-power and load-power responses are considered. State error and chattering rip-
 221 ples are taken as a key factor to judge the goodness of the proposed controller. The obtained
 222 simulation results are shown in Fig.(7 and 8). From these figures, one can remark clearly that
 223 IBSMC has better dynamic performances comparatively to those of SMC. Moreover, from the
 224 zoomed figure of the PV-power (Fig.7(c)), the chattering phenomena and the state error have
 225 been reduced considerably in the case of using IBSMC. Practically, these improved performances
 226 are due essentially to the integral action and the discontinuous sliding mode controller integrated
 227 into the IBSMC structure. Indeed, the discontinuous sliding mode law affects clearly the chattering
 228 ripples that improve clearly the power quality and by the way ensure the stability of the overall
 229 system. The integral action has enhanced state error.

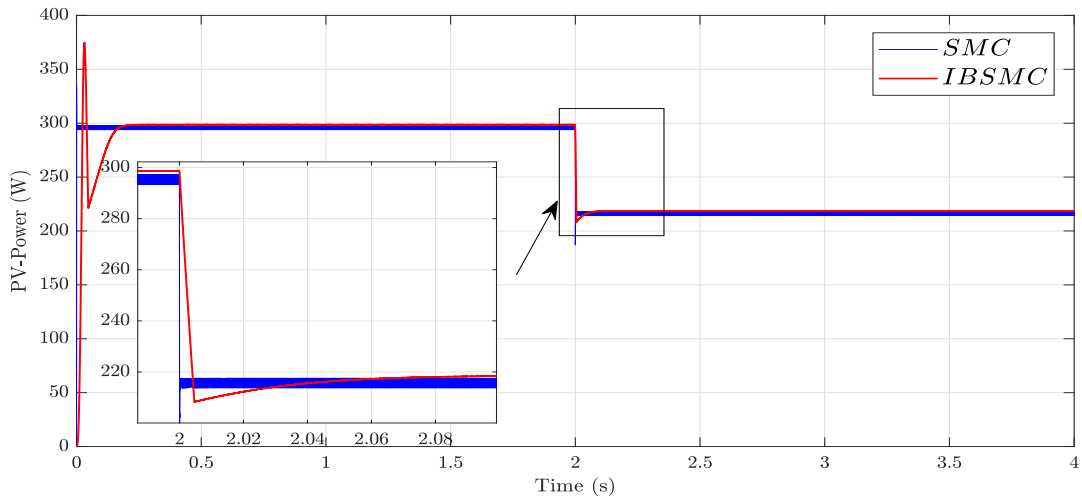
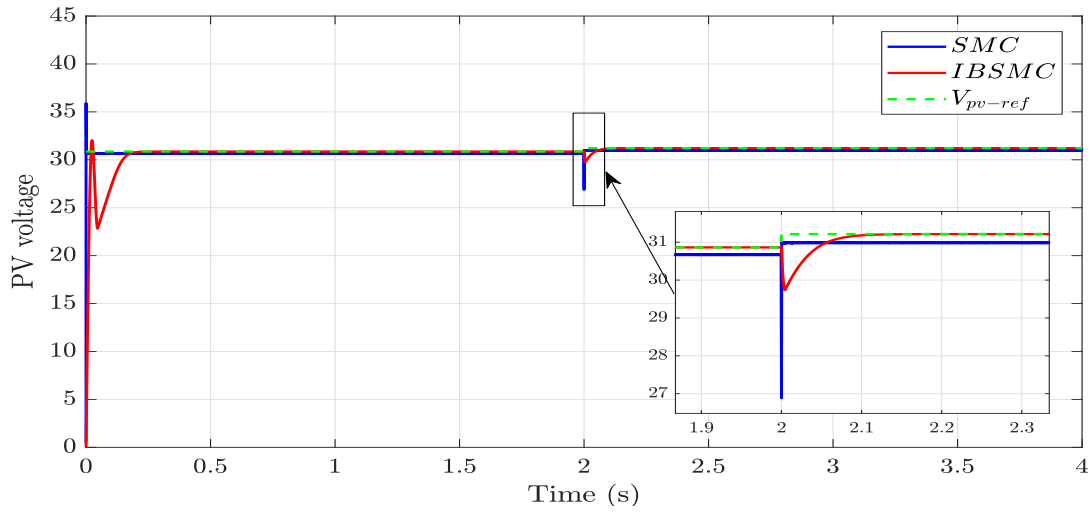
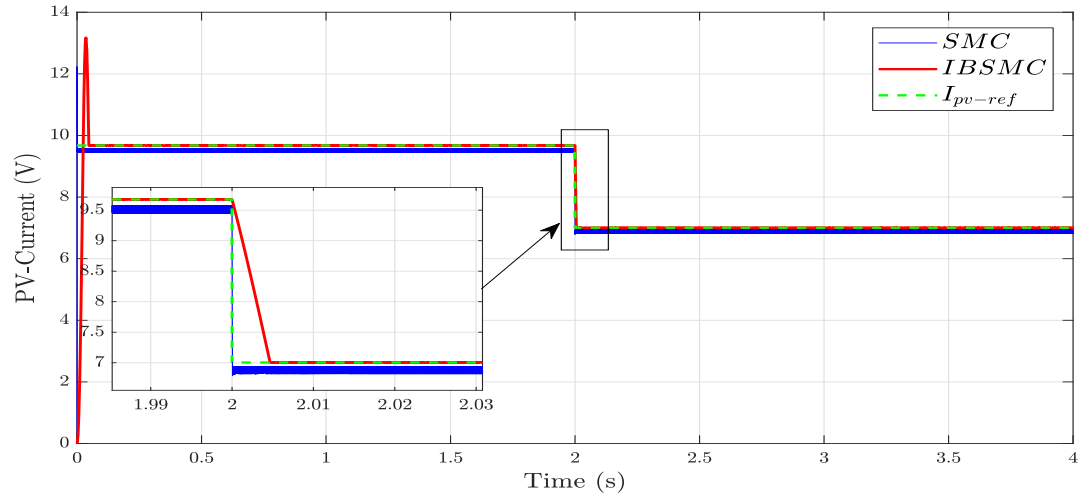

Figure 7: Different responses of the PV module in the case of IBSMC and SMC: a) PV- current (A), b) PV-voltage (V), c) PV-power (W).

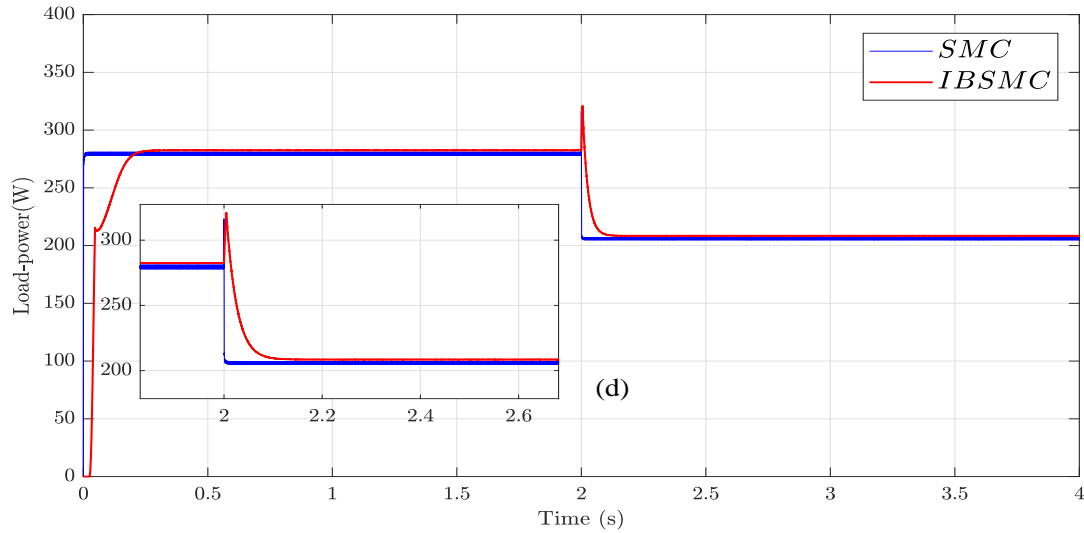

Figure 8: Load-power(W) of the PV module in the case of IBSMC

230 6. Experimental results and discussions

231 The experimental results are carried out on the basis of test bench existing in our laboratory. As
 232 shown in Fig.9. The list of material used in the experience is given hereafter:

- 233 • dSPACE (Dsp1 and Dsp 2);
- 234 • Variable resistive loads (load1 and load 2);
- 235 • Voltage and current sensors;
- 236 • DC-DC Boost converters (boost 1 and boost 2);
- 237 • Two PV modules (PV1 and PV2) (see Fig.9);
- 238 • Graphical User Interface (GUI1 and GUI2);
- 239 • Device for PV module characteristics measurement (see Figs.10).



Figure 9: Different required devices used for practical experience.



Figure 10: Device for PV module characteristics measurement.

240 6.1. Experimental measurement of the PV module characteristics

241 6.2. Case of constant weather conditions

242 The device, shown in 10, is used for the PV module characteristics measurement for irradiation
243 of about $728W/m^2$ generated by an irradiation sensor available in the laboratory (see Fig.11). The
244 obtained experimental PV characteristics ($I - V$ and $P - V$) for irradiation of ($728W/m^2$) and a
245 temperature of about $26C^0$ are presented in Fig 12. From these results, the practical maximum
246 PV power which can be produced for the actual irradiation value ($728W/m^2$) is about equal to
247 $215.4(W)$ for a PV voltage and current equal to $29.89V$ and $7.2A$ respectively (see Fig.11).

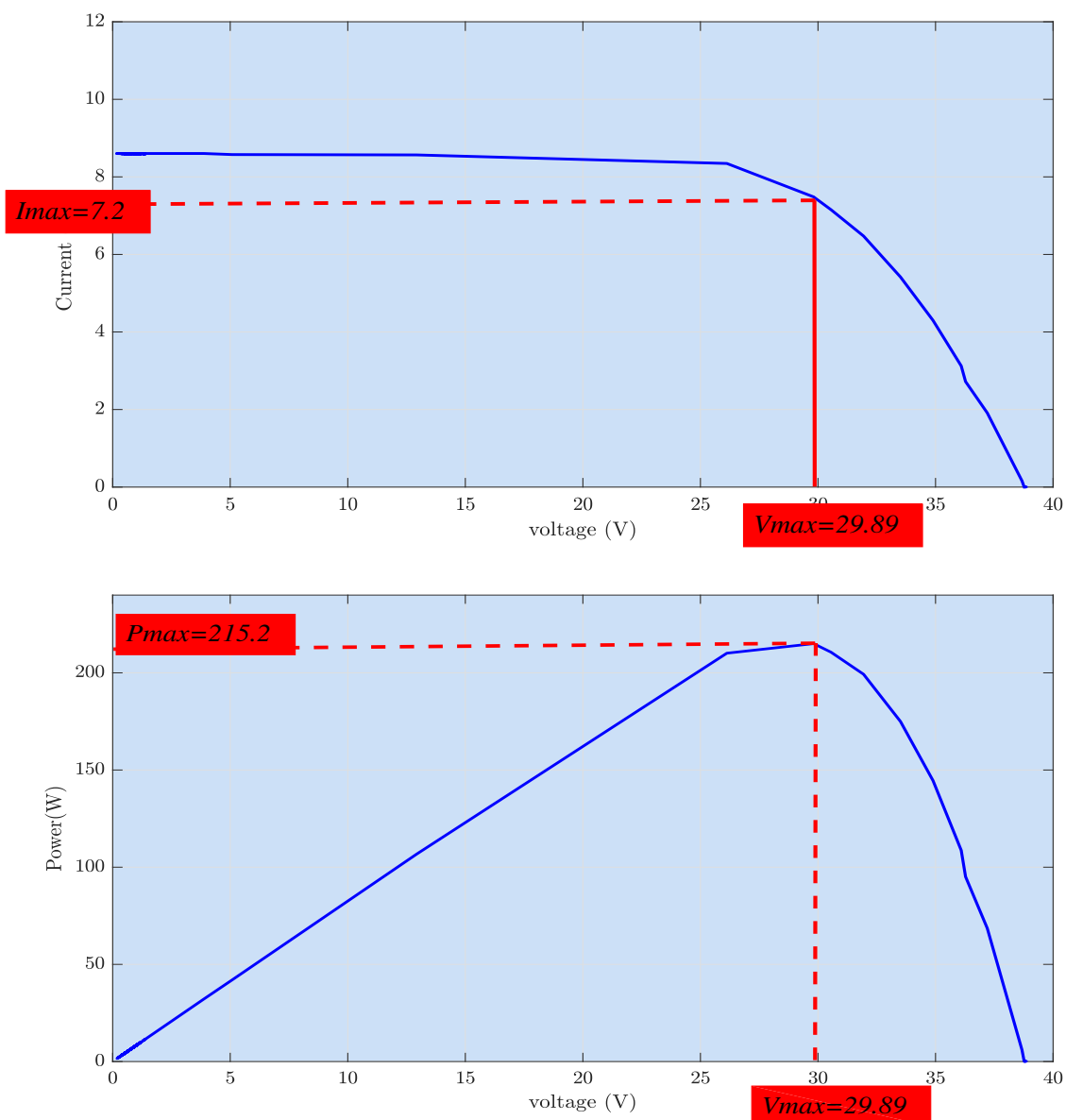

Figure 11: Experimental PV characteristics ($I - V$ and $P - V$) at an irradiation of $728w/m^2$.

248 In addition, the experimental irradiation curve given by the sensor is presented in Fig.12.

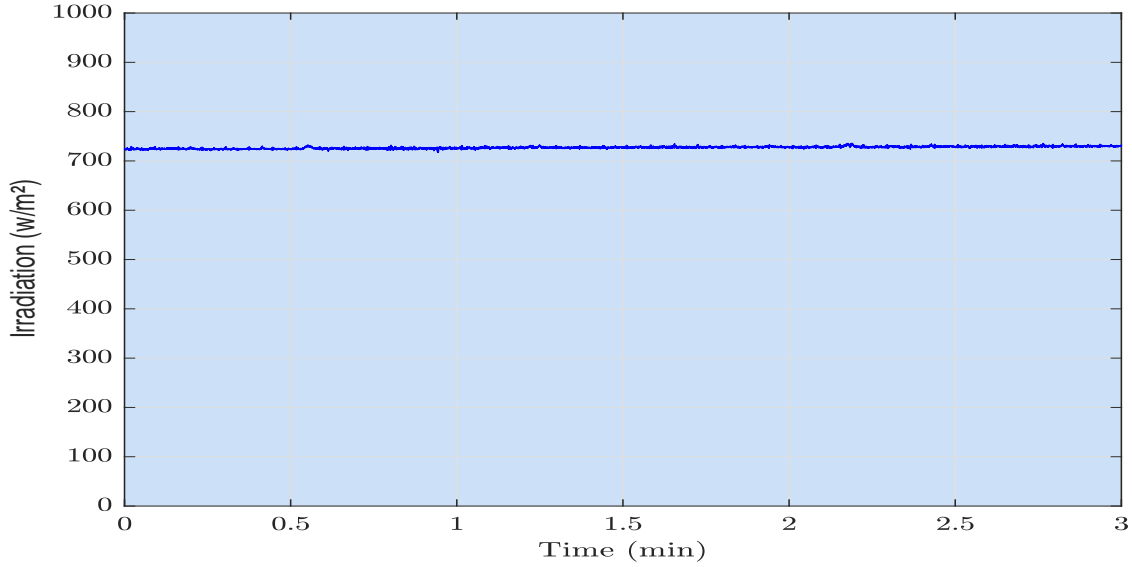

Figure 12: Experimental irradiation curve (W/m^2).

249 6.3. Experimental results using the controllers

250 The controller's strategies developed previously are applied practically to the PV system. The
251 IBSMC and SMC are tuned at the same time to control the PV current to follow its MPPT value
252 and achieve consequently the maximum produced power. The different experimental PV responses
253 are shown in Fig.13. The experimental results show that all different PV responses ($PV - voltage$,
254 $PV - current$ and $PV - power$) are following practically their MPPT values by applying the two
255 controllers with the same weather practical conditions (irradiation and temperature). However, in
256 the case of the IBSMC, the state error and the chattering phenomena are reduced considerably
257 (see Fig.13 (b and c)). As a result, a smooth PV power form (very small chattering level) is
258 achieved by the use of the IBSMC (see Fig.13(c)). Elsewhere, the experimental load responses
259 are depicted in Fig.14. From these results, one can remark that all load responses ($load - current$
260 , $load - voltage$, $load - power$) follow their MPPT required values. In the case of using SMC,
261 all the practical responses contain the chattering phenomena with a non nil state error, but these
262 drawbacks are significantly reduced in the case of IBSMC (see Fig.14 (b and c)). In fact, a smooth
263 load voltage and power are guaranteed for feeding the load. So, by using the IBSMC the power
264 quality is suitably enhanced . Finally, comparing the curves of the PV- power(see Fig.13(c)) and

265 the *load – power*(see Fig.14(c)) , one can observe a little difference which is due to the system
266 losses.

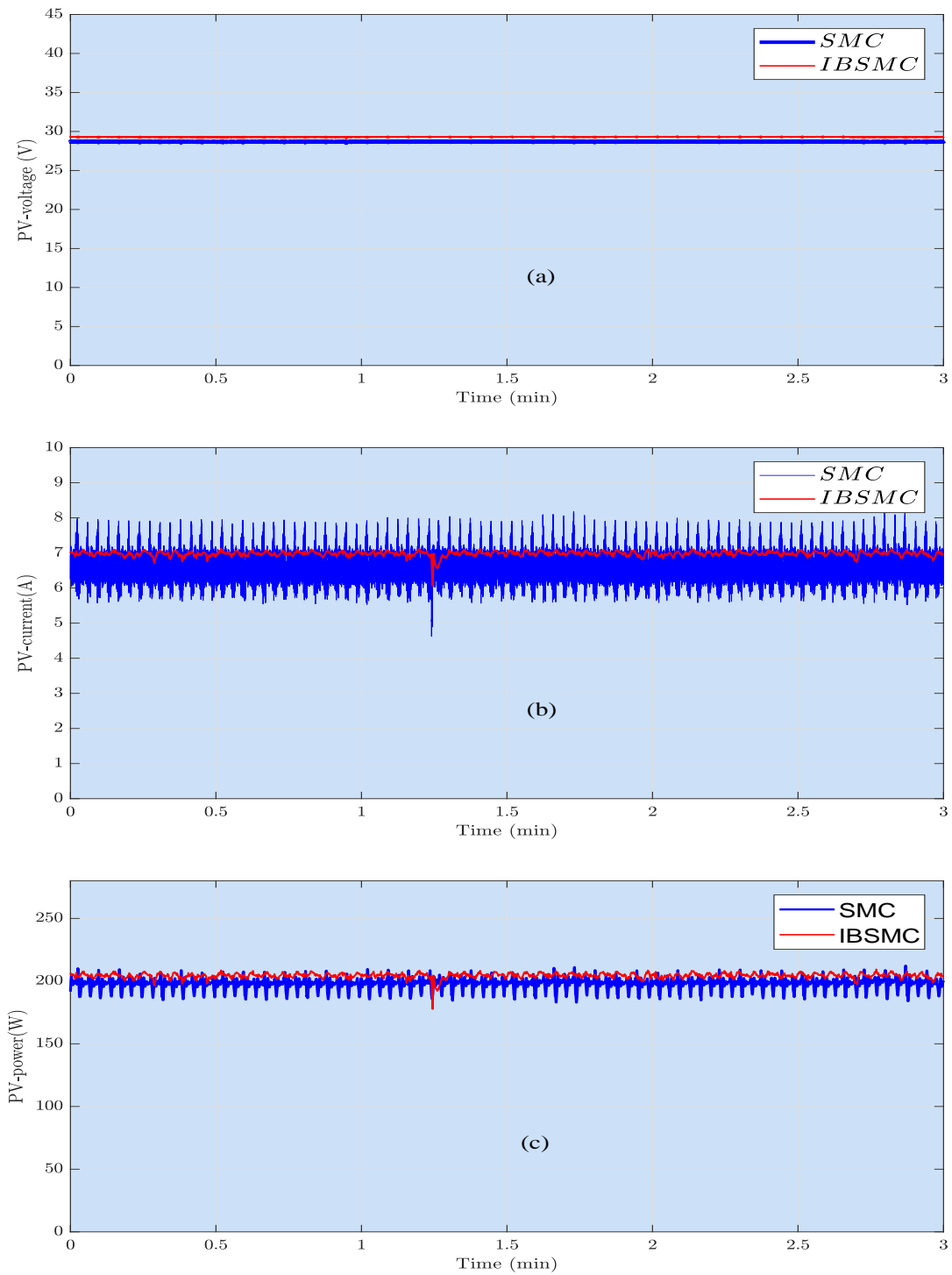

Figure 13: Different experimental responses of the PV module in the case of IBSMC and SMC: a) PV-voltage (V), b) PV-current (A), c) PV-power (W).

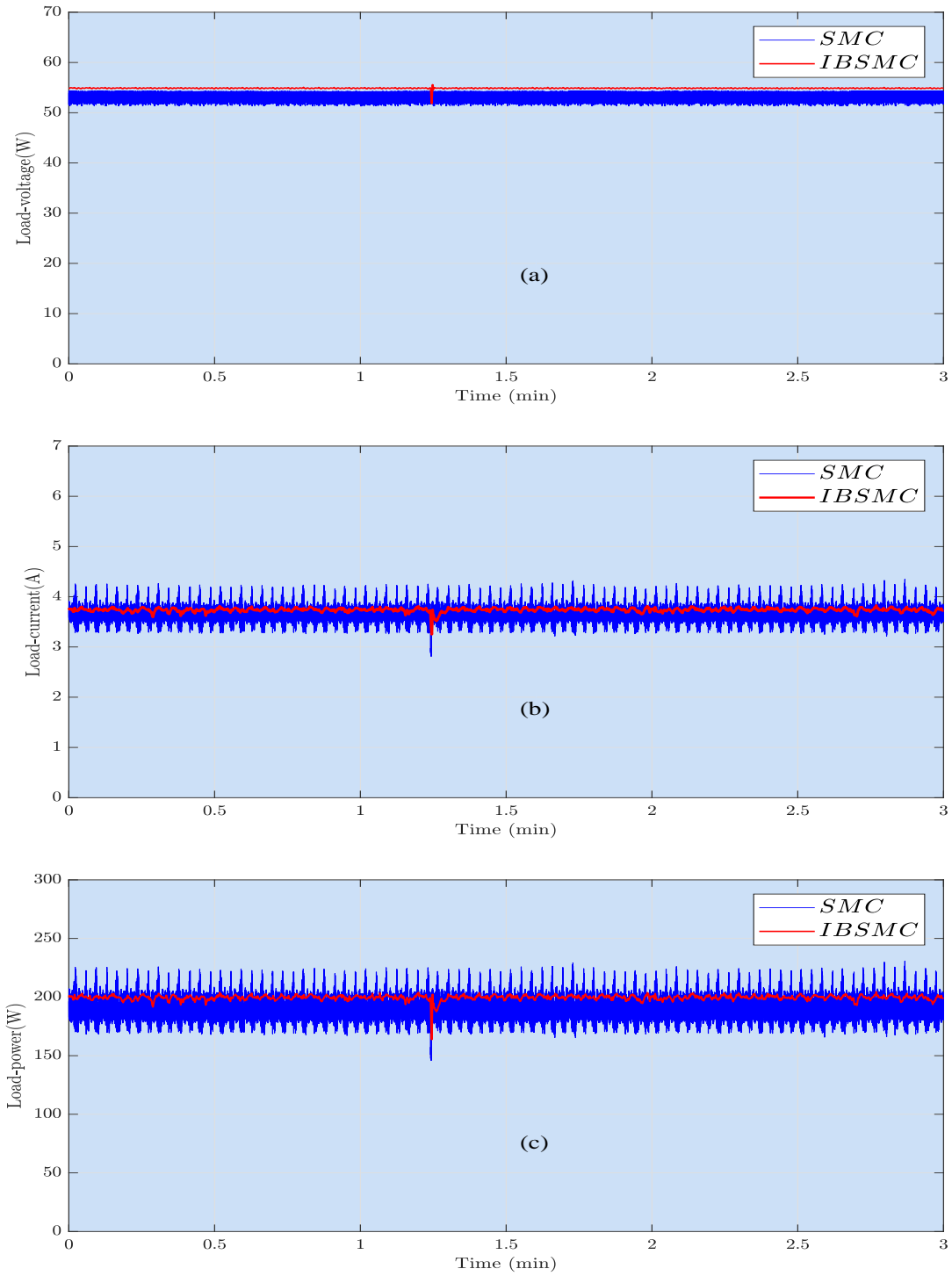

Figure 14: Different experimental responses of the load in the case of IBSMC and SMC: a) Load-voltage (V), b) Load-current (V), c) Load-power (W).

267 Finally, to show clearly the performances of the proposed controller, the obtained load power
 268 is measured through an oscilloscope and presented in Fig.16. The use of the IBSMC leads to an

269 improved power quality (smooth power curve).(see Fig.16)

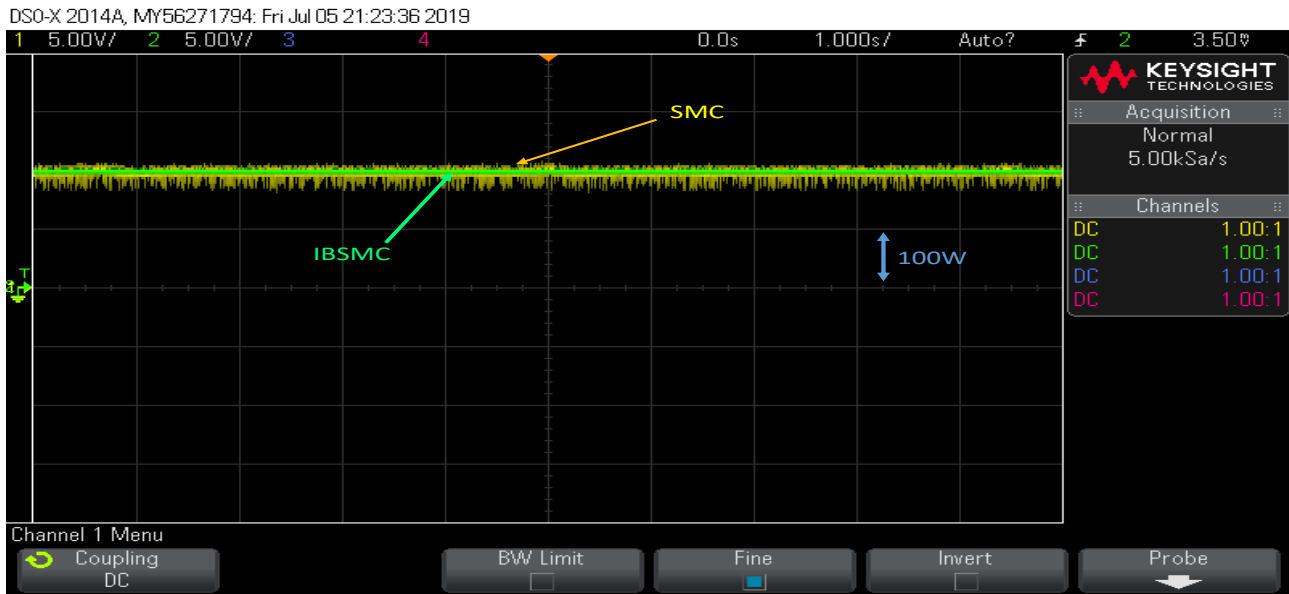

Figure 15: Load power measurement of the load power in the case of the IBSMC and the SMC.

270 6.4. Case of variable weather conditions

271 As a second test, the experiments were carried out by considering a large change in weather
272 conditions (Duration of 4 hours) in a very cloudy day. To evaluate the performances of the proposed
273 controller (IBSMC) in term of robustness, global stability and tracking the reference value. A
274 comparison between SMC and IBSMC has been made in real-time under the same irradiation and
275 temperature. The obtained experimental results for both controllers are shown in Fig 16. It can
276 be seen that the use the proposed IBSMC controller allow, a great improvement of the load power
277 quality, a high reduction of the chattering phenomenon and minimize the steady state-error.

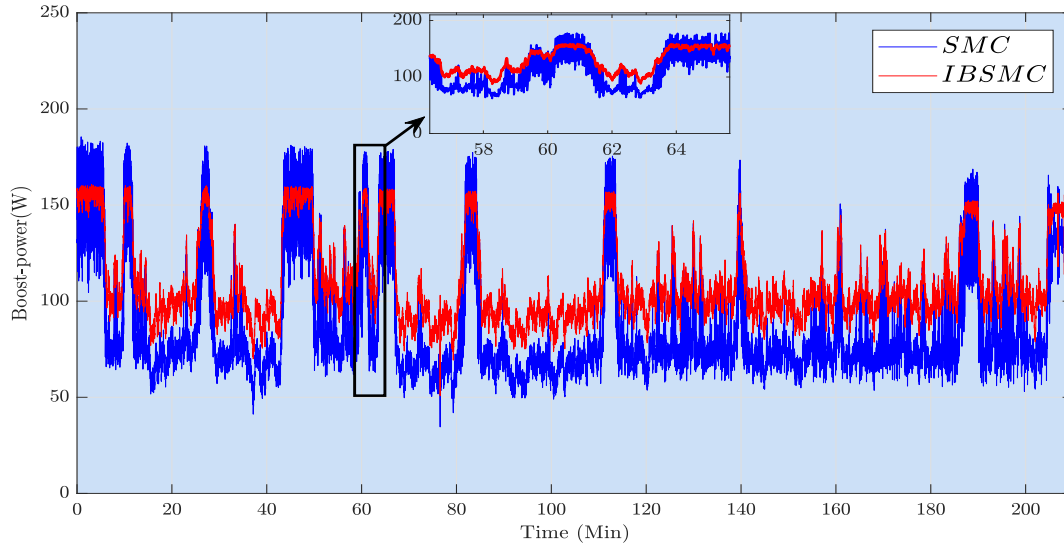

Figure 16: Experimental load (Boost-power (W)).responses in the case of IBSMC and SMC under large variable weather conditions.

278 7. Conclusion

279 Nonlinear controllers are the most suitable for PV systems control. In this paper, a nonlinear
 280 Integral Backstepping Sliding Mode Controller (IBSMC) to achieve the PV MPP using DC-DC
 281 boost converter had been proposed. The current reference value at the MPP has been generated
 282 using a classical method (P&O) and the global stability of the system has been improved using
 283 Lyapunov stability criteria. The IBSMC controller is based on a combination of a discontinuous
 284 sliding mode and an integral backstepping to reduce simultaneously the chattering phenomena and
 285 minimize the steady-state error. The performances of the proposed controller have been applied
 286 and tested through simulations and experimental validation using a test bench. Furthermore, its
 287 performances have been compared experimentally with a nonlinear classical Sliding mode controller
 288 under the same weather conditions. The obtained experimental results demonstrate an improved
 289 steady-state error and chattering phenomena minimization, using the proposed controller. So, the
 290 MPP tracking is accurately achieved and the system power quality is suitably enhanced.

291 Future work can be focused on the test experimentally the IBSMC performances under partial
 292 shading conditions and improving the system response time by optimizing the IBSMC controller
 293 parameters using optimization technique .

294 References

- 295 [1] T. Poompavai, M. Kowsalya, [Control and energy management strategies applied for solar](#)
296 [photovoltaic and wind energy fed water pumping system: A review](#), *Renewable and Sustain-*
297 [able Energy Reviews](#) 107 (2019) 108–122. doi:10.1016/j.rser.2019.02.023.
298 URL <https://linkinghub.elsevier.com/retrieve/pii/S1364032119301169>
- 299 [2] R. Ahmad, A. F. Murtaza, H. A. Sher, [Power tracking techniques for efficient operation](#)
300 [of photovoltaic array in solar applications – A review](#), *Renewable and Sustainable Energy*
301 [Reviews](#) 101 (2019) 82–102. doi:10.1016/j.rser.2018.10.015.
302 URL <https://linkinghub.elsevier.com/retrieve/pii/S1364032118307196>
- 303 [3] D. Sera, L. Mathe, T. Kerekes, S. V. Spataru, R. Teodorescu, [On the Perturb-and-Observe and](#)
304 [Incremental Conductance MPPT Methods for PV Systems](#), *IEEE Journal of Photovoltaics*
305 [3](#) (3) (2013) 1070–1078. doi:10.1109/JPHOTOV.2013.2261118.
306 URL <http://ieeexplore.ieee.org/document/6517453/>
- 307 [4] R. Alik, A. Jusoh, [An enhanced P&O checking algorithm MPPT for high tracking efficiency](#)
308 [of partially shaded PV module](#), *Solar Energy* 163 (2018) 570–580. doi:10.1016/j.solener.
309 [2017.12.050](#).
310 URL <https://linkinghub.elsevier.com/retrieve/pii/S0038092X17311325>
- 311 [5] B. K. Oubbati, M. Boutoubat, M. Belkheiri, A. Rabhi, [Extremum Seeking and P&O Control](#)
312 [Strategies for Achieving the Maximum Power for a PV Array](#), in: M. Hatti (Ed.), *Renewable*
313 [Energy for Smart and Sustainable Cities](#), Vol. 62, Springer International Publishing, Cham,
314 2019, pp. 233–241. doi:10.1007/978-3-030-04789-4_26.
315 URL http://link.springer.com/10.1007/978-3-030-04789-4_26
- 316 [6] A. M. Eltamaly, H. M. Farh, [Dynamic global maximum power point tracking of the PV](#)
317 [systems under variant partial shading using hybrid GWO-FLC](#), *Solar Energy* 177 (2019) 306–
318 316. doi:10.1016/j.solener.2018.11.028.
319 URL <https://linkinghub.elsevier.com/retrieve/pii/S0038092X18311290>
- 320 [7] H. Hamdi, C. Ben Regaya, A. Zaafour, [Real-time study of a photovoltaic system with boost](#)
321 [converter using the PSO-RBF neural network algorithms in a MyRio controller](#), *Solar Energy*

- 322 183 (2019) 1–16. doi:10.1016/j.solener.2019.02.064.
323 URL <https://linkinghub.elsevier.com/retrieve/pii/S0038092X19301902>
- 324 [8] M. A. Mohamed, A. A. Zaki Diab, H. Rezk, [Partial shading mitigation of PV systems via](#)
325 [different meta-heuristic techniques](#), Renewable Energy 130 (2019) 1159–1175. doi:10.1016/
326 [j.renene.2018.08.077](#).
327 URL <https://linkinghub.elsevier.com/retrieve/pii/S0960148118310279>
- 328 [9] B. Yang, L. Zhong, X. Zhang, H. Shu, T. Yu, H. Li, L. Jiang, L. Sun, [Novel bio-inspired](#)
329 [memetic salp swarm algorithm and application to MPPT for PV systems considering partial](#)
330 [shading condition](#), Journal of Cleaner Production 215 (2019) 1203–1222. doi:10.1016/j.
331 [jclepro.2019.01.150](#).
332 URL <https://linkinghub.elsevier.com/retrieve/pii/S0959652619301696>
- 333 [10] M. Mao, L. Zhou, Z. Yang, Q. Zhang, C. Zheng, B. Xie, Y. Wan, [A hybrid intelligent GMPPT](#)
334 [algorithm for partial shading PV system](#), Control Engineering Practice 83 (2019) 108–115.
335 doi:10.1016/j.conengprac.2018.10.013.
336 URL <https://linkinghub.elsevier.com/retrieve/pii/S0967066118306592>
- 337 [11] A. Mohapatra, B. Nayak, P. Das, K. B. Mohanty, [A review on MPPT techniques of PV system](#)
338 [under partial shading condition](#), Renewable and Sustainable Energy Reviews 80 (2017) 854–
339 867. doi:10.1016/j.rser.2017.05.083.
340 URL <https://linkinghub.elsevier.com/retrieve/pii/S1364032117307256>
- 341 [12] M. Seyedmahmoudian, B. Horan, T. K. Soon, R. Rahmani, A. M. Than Oo, S. Mekhilef,
342 A. Stojcevski, [State of the art artificial intelligence-based MPPT techniques for mitigating](#)
343 [partial shading effects on PV systems – A review](#), Renewable and Sustainable Energy Reviews
344 64 (2016) 435–455. doi:10.1016/j.rser.2016.06.053.
345 URL <https://linkinghub.elsevier.com/retrieve/pii/S1364032116302842>
- 346 [13] H. M. El-Helw, A. Magdy, M. I. Marei, [A Hybrid Maximum Power Point Tracking Technique](#)
347 [for Partially Shaded Photovoltaic Arrays](#), IEEE Access 5 (2017) 11900–11908. doi:10.1109/
348 [ACCESS.2017.2717540](#).
349 URL <http://ieeexplore.ieee.org/document/7953645/>

- 350 [14] B. K. Oubbati, M. Boutoubat, M. Belkheiri, A. Rabhi, [Global maximum power point tracking](#)
351 [of a PV system MPPT control under partial shading](#), in: 2018 International Conference on
352 Electrical Sciences and Technologies in Maghreb (CISTEM), IEEE, Algiers, 2018, pp. 1–6.
353 [doi:10.1109/CISTEM.2018.8613391](#).
354 URL <https://ieeexplore.ieee.org/document/8613391/>
- 355 [15] A. El Khateb, N. A. Rahim, J. Selvaraj, M. N. Uddin, [Fuzzy-Logic-Controller-Based SEPIC](#)
356 [Converter for Maximum Power Point Tracking](#), IEEE Transactions on Industry Applications
357 50 (4) (2014) 2349–2358. [doi:10.1109/TIA.2014.2298558](#).
358 URL <http://ieeexplore.ieee.org/document/6704722/>
- 359 [16] K. Ishaque, Z. Salam, [A review of maximum power point tracking techniques of PV system for](#)
360 [uniform insolation and partial shading condition](#), Renewable and Sustainable Energy Reviews
361 19 (2013) 475–488. [doi:10.1016/j.rser.2012.11.032](#).
362 URL <https://linkinghub.elsevier.com/retrieve/pii/S1364032112006442>
- 363 [17] P. Verma, R. Garg, P. Mahajan, [Asymmetrical interval type-2 fuzzy logic control based](#)
364 [MPPT tuning for PV system under partial shading condition](#), ISA Transactions (2020)
365 S0019057820300021 [doi:10.1016/j.isatra.2020.01.009](#).
366 URL <https://linkinghub.elsevier.com/retrieve/pii/S0019057820300021>
- 367 [18] R. Abdelrassoul, Y. Ali, M. S. Zaghloul, [Genetic Algorithm-Optimized PID Controller for](#)
368 [Better Performance of PV System](#), in: 2016 World Symposium on Computer Applications &
369 Research (WSCAR), IEEE, Cairo, Egypt, 2016, pp. 18–22. [doi:10.1109/WSCAR.2016.14](#).
370 URL <http://ieeexplore.ieee.org/document/7791974/>
- 371 [19] E. K. Anto, J. A. Asumadu, P. Y. Okyere, [PID control for improving P&O-MPPT performance](#)
372 [of a grid-connected solar PV system with Ziegler-Nichols tuning method](#), in: 2016 IEEE 11th
373 Conference on Industrial Electronics and Applications (ICIEA), IEEE, Hefei, China, 2016,
374 pp. 1847–1852. [doi:10.1109/ICIEA.2016.7603888](#).
375 URL <http://ieeexplore.ieee.org/document/7603888/>
- 376 [20] M. Farhat, O. Barambones, L. Sbita, [A new maximum power point method based on a](#)
377 [sliding mode approach for solar energy harvesting](#), Applied Energy 185 (2017) 1185–1198.

- 378 [doi:10.1016/j.apenergy.2016.03.055](https://doi.org/10.1016/j.apenergy.2016.03.055).
- 379 URL <https://linkinghub.elsevier.com/retrieve/pii/S0306261916303750>
- 380 [21] M. Bjaoui, B. Khiari, R. Benadli, M. Memni, A. Sellami, [Practical Implementation of the](#)
381 [Backstepping Sliding Mode Controller MPPT for a PV-Storage Application](#), *Energies* 12 (18)
382 (2019) 3539. [doi:10.3390/en12183539](https://doi.org/10.3390/en12183539).
- 383 URL <https://www.mdpi.com/1996-1073/12/18/3539>
- 384 [22] K. Dahech, M. Allouche, T. Damak, F. Tadeo, [Backstepping sliding mode control for max-](#)
385 [imum power point tracking of a photovoltaic system](#), *Electric Power Systems Research* 143
386 (2017) 182–188. [doi:10.1016/j.epsr.2016.10.043](https://doi.org/10.1016/j.epsr.2016.10.043).
- 387 URL <https://linkinghub.elsevier.com/retrieve/pii/S0378779616304400>
- 388 [23] Naghmash, H. Armghan, I. Ahmad, A. Armghan, S. Khan, M. Arsalan, [Backstepping based](#)
389 [non-linear control for maximum power point tracking in photovoltaic system](#), *Solar Energy*
390 159 (2018) 134–141. [doi:10.1016/j.solener.2017.10.062](https://doi.org/10.1016/j.solener.2017.10.062).
- 391 URL <https://linkinghub.elsevier.com/retrieve/pii/S0038092X17309428>
- 392 [24] R. Pradhan, B. Subudhi, [Double Integral Sliding Mode MPPT Control of a Photovoltaic](#)
393 [System](#), *IEEE Transactions on Control Systems Technology* 24 (1) (2016) 285–292. [doi:](https://doi.org/10.1109/TCST.2015.2420674)
394 [10.1109/TCST.2015.2420674](https://doi.org/10.1109/TCST.2015.2420674).
- 395 URL <http://ieeexplore.ieee.org/document/7101232/>
- 396 [25] B. Yang, T. Yu, H. Shu, D. Zhu, N. An, Y. Sang, L. Jiang, [Perturbation observer based](#)
397 [fractional-order sliding-mode controller for MPPT of grid-connected PV inverters: Design](#)
398 [and real-time implementation](#), *Control Engineering Practice* 79 (2018) 105–125. [doi:10.](https://doi.org/10.1016/j.conengprac.2018.07.007)
399 [1016/j.conengprac.2018.07.007](https://doi.org/10.1016/j.conengprac.2018.07.007).
- 400 URL <https://linkinghub.elsevier.com/retrieve/pii/S096706611830279X>
- 401 [26] M. Stitou, A. E. Fadili, F. Z. Chaoui, F. Giri, [Output feedback control of sensorless photo-](#)
402 [voltaic systems, with maximum power point tracking](#), *Control Engineering Practice* 84 (2019)
403 1–12. [doi:10.1016/j.conengprac.2018.10.020](https://doi.org/10.1016/j.conengprac.2018.10.020).
- 404 URL <https://linkinghub.elsevier.com/retrieve/pii/S0967066118302922>
- 405 [27] R. Chinnappan, P. Logamani, R. Ramasubbu, [Fixed frequency integral sliding-mode current-](#)
406 [controlled MPPT boost converter for two-stage PV generation system](#), *IET Circuits, Devices*

- 407 & Systems 13 (6) (2019) 793–805. doi:10.1049/iet-cds.2018.5221.
408 URL [https://digital-library.theiet.org/content/journals/10.1049/iet-cds.](https://digital-library.theiet.org/content/journals/10.1049/iet-cds.2018.5221)
409 [2018.5221](https://digital-library.theiet.org/content/journals/10.1049/iet-cds.2018.5221)
- 410 [28] N. Chatrenour, H. Razmi, H. Doagou-Mojarrad, [Improved double integral sliding mode MPPT](#)
411 [controller based parameter estimation for a stand-alone photovoltaic system](#), Energy Conver-
412 sion and Management 139 (2017) 97–109. doi:10.1016/j.enconman.2017.02.055.
413 URL <https://linkinghub.elsevier.com/retrieve/pii/S0196890417301668>
- 414 [29] A. Kihal, F. Krim, A. Laib, B. Talbi, H. Afghoul, [An improved MPPT scheme employing](#)
415 [adaptive integral derivative sliding mode control for photovoltaic systems under fast irradiation](#)
416 [changes](#), ISA Transactions 87 (2019) 297–306. doi:10.1016/j.isatra.2018.11.020.
417 URL <https://linkinghub.elsevier.com/retrieve/pii/S0019057818304555>
- 418 [30] M. Arsalan, R. Iftikhar, I. Ahmad, A. Hasan, K. Sabahat, A. Javeria, [MPPT for photovoltaic](#)
419 [system using nonlinear backstepping controller with integral action](#), Solar Energy 170 (2018)
420 192–200. doi:10.1016/j.solener.2018.04.061.
421 URL <https://linkinghub.elsevier.com/retrieve/pii/S0038092X18304274>
- 422 [31] A. Oi, M. Anwari, M. Taufik, [Modeling and Simulation of Photovoltaic Water Pumping](#)
423 [System](#), in: 2009 Third Asia International Conference on Modelling & Simulation, IEEE,
424 Bundang, Bali, Indonesia, 2009, pp. 497–502. doi:10.1109/AMS.2009.85.
425 URL <http://ieeexplore.ieee.org/document/5072037/>
- 426 [32] E. Van Dijk, J. Spruijt, D. O’Sullivan, J. Klaassens, [PWM-switch modeling of DC-DC convert-](#)
427 [ers](#), IEEE Transactions on Power Electronics 10 (6) (1995) 659–665. doi:10.1109/63.471285.
428 URL <https://ieeexplore.ieee.org/document/471285/>