



HAL
open science

Thermal building control using active ventilated block integrating phase change material

Amine Laaouatni, Nadia Martaj, Rachid Bennacer, Mohammed Lachi,
Mohamed El Omari, Mohammed El Ganaoui

► To cite this version:

Amine Laaouatni, Nadia Martaj, Rachid Bennacer, Mohammed Lachi, Mohamed El Omari, et al.. Thermal building control using active ventilated block integrating phase change material. Energy and Buildings, 2019, 187, pp.50-63. 10.1016/j.enbuild.2019.01.024 . hal-03138346

HAL Id: hal-03138346

<https://hal.science/hal-03138346>

Submitted on 21 Oct 2021

HAL is a multi-disciplinary open access archive for the deposit and dissemination of scientific research documents, whether they are published or not. The documents may come from teaching and research institutions in France or abroad, or from public or private research centers.

L'archive ouverte pluridisciplinaire **HAL**, est destinée au dépôt et à la diffusion de documents scientifiques de niveau recherche, publiés ou non, émanant des établissements d'enseignement et de recherche français ou étrangers, des laboratoires publics ou privés.



Distributed under a Creative Commons Attribution - NonCommercial 4.0 International License

1 Thermal building control using active ventilated block 2 integrating phase change material

3 Amine Laaouatni^{1, 2}, Nadia Martaj^{1, 3}, Rachid Bennacer^{4, 5, *}, Mohammed Lachi³,
4 Mohamed El Omari² and Mohammed El Ganaoui⁶

5
6 ¹EPF Campus de Troyes 2, rue F. Sastre 10430 Rosières-près-Troyes, France

7 ²Laboratory of Automation, Environment and Transfer Processes LAEPT, Faculty of Sciences
8 Semlalia, Cadi Ayyad University, P. B. 2390, Marrakesh, Morocco

9 ³GRESPI EA 4694, University of Reims Champagne Ardenne, UFR Sciences Exactes et
10 Naturelles, Moulin de la Housse, 51687 Reims cedex 2, France

11 ⁴LMT-Cachan, ENS Cachan CNRS, Université Paris Saclay, 61 avenue du Président Wilson,
12 94230 Cachan, France

13 ⁵ECAM EPMI, Cergy Pontoise, France

14 ⁶Université de Lorraine, Laboratoire Lermab-longwy, IUT Henri Poincaré de Longwy, 186 rue
15 de Lorraine, 54400 Longwy - Cosnes et Romain, France

16
17 ***Corresponding author**

18 Email: rachid.bennacer@ens-cachan.fr

19
20 **Keywords:** Phase change material (PCM), Thermal building, Modelling, Thermal modelling,
21 Thermal inertia.

29 **Abstract**

30 In the context of improving energy efficiency and thermal comfort in the building, the use of
31 phase change materials (PCMs) is one of the suggested solutions. The proposed integration
32 solutions concern the building envelope as well as the applications related to its operation.
33 The study of the incorporation of PCM in the walls of the building was the subject of
34 numerous works. However, the antisymmetric character of storing/recovering energy
35 management in the walls is less controlled and do not fit the optimal conditions. In this
36 study, a solution based on the direct integration of a stabilized PCM (gel) in an envelope
37 including ventilation channels, was proposed to overcome this problem of antisymmetry
38 storing/recovering and fitting with different fixed ambient conditions. The final aim is to
39 develop the optimization strategy of a wall combining the heavy inertia offered by the PCM,
40 intra-ventilation control and the contribution to air renewal energy demand.

41 In this context, an experimental study of a concrete block system is conducted to test the
42 thermal response of this configuration by the application of cyclic solicitations. The
43 comprehension of this integrated constructive solution essentially passes by the possession
44 of validated numerical tools. For this, two models have been developed. The first model
45 using the electrical-thermal analogy, based on an RC equivalence, is distinguished by its
46 relative simplicity and weak time computing demand. Each of these two factors, R and C
47 summarise the system properties and has a direct influence on the building transient
48 simulations over a year. The second one is based on direct numerical simulation DNS of the
49 energy and fluid flow equations using commercial code COMSOL Multiphysics. Such DNS is
50 time consuming and could not be used to simulate over a year but aims only to validate the
51 first RC circuit approach. A comparison of these two models with the idealised experimental
52 data was carried out and allowed the validation of the thermal behaviour of the solution
53 based on the integration of the PCM with core ventilation.

54

55 **Nomenclature**

56 ***Latin letters***

57 f_v *Volume fraction*

58	C	Thermal capacitance (J/K)
59	c_p	Specific heat at constant pressure (J/kg K)
60	e	Element thickness (m)
61	h	Convective heat transfer coefficient (W/m ² K)
62	k	Thermal conductivity (W/m K)
63	L	Length (m)
64	\dot{m}	Airflow rate (kg/s)
65	Q	Heat flux (W/m ²)
66	R	Thermal resistance (K/W)
67	Ra	Rayleigh number
68	S	Surface (m ²)
69	T	Temperature (K, °C)
70	t	Time (s)
71	T_{in}	Air inlet temperature (K, °C)
72	T_{om}	Onset temperature of the melting (K, °C)
73	T_{ou}	Air outlet temperature (K, °C)
74	T_{sl}	Phase change temperature (K, °C)
75	u	Velocity field (m/s)
76	Greek letters	
77	ΔL	Latent heat (J/kg)
78	ε	Emissivity
79	μ	Dynamic viscosity (kg/m s)
80	ρ	Density (kg/m ³)
81	σ	Stefan-Boltzmann constant (W/m ² K ⁴)
82	φ	Solar radiation heat flux (W/m ²)
83	Subscripts	
84	amb	Ambient

85 *conv* Convection
86 *C* Concrete
87 *elec* Referring to electrical physical quantities
88 *i* Internal, indoor
89 *l* Liquid
90 *min* Minimum
91 *O* Outer, outdoor
92 *pcn* Phase change material
93 *rad* Radiation
94 *S* Solid
95 *t* Tube
96 *V* Ventilation
97 *W* Wall

98 **Acronyms**

99 *EXP* Referring to experimentation
100 *FEM* Finite element model
101 *DSC* Differential scanning calorimetry
102 *PCM* Phase change material
103 *PVC* Polyvinyl chloride
104 *RC* Referring to resistance and capacitance network model

105

106 **1. Introduction**

107 Energy consumption in the building sector is gaining increasing interest as it is directly
108 related to energy economics and sustainable development. The design and the choice of
109 building materials, as well as the energy and thermal systems evolve very rapidly. In the
110 energy challenge, the building is among the largest consumers of energy. Efficiency and
111 optimization of energy systems remain among the main axes studied in order to reduce
112 energy consumption and increase system performance. The need to balance available
113 energy with occupant comfort involves the use of new innovative and effective technological
114 solutions. In the area of housing, the cost and optimization of space are the two main
115 reasons that require the decrease of the thickness of walls in new constructions; however,

116 this reduction greatly affects the thermal inertia of the frame and makes it insufficient to
117 effectively damp the oscillations due to the outdoor temperature variation. Moreover, the
118 management of thermal comfort by control systems acting on ventilation poses the problem
119 of increasing the electrical consumption energy and the drawbacks related to the operation
120 of these devices (noise, maintenance, etc.).

121 The integration of phase change materials (PCMs) in the building envelope is an interesting
122 solution to optimize energy consumption. When integrated into building elements, their
123 energy storage capacity using latent heat is manifested. A thermal phase shift is performed
124 during the energy storage phase, then comes the restitution phase with a damping, which
125 reduces the needs according to the outdoor climatic conditions of the considered
126 construction. This topic has been the subject of numerous studies aimed at answering the
127 various difficulties that oppose the optimal use of this solution [1–4]. Among these
128 constraints, one can cite the choice of the appropriate method of incorporation of these
129 products but also the limits imposed by the use of such a material which changes phase.
130 Direct incorporation, impregnation of building materials, incorporation of capsules filled
131 with PCM are part of the used methodologies. Thus, in order to minimize the risk of leakage
132 during the melting of this type of product, mixtures are used which aim at reinforcing the
133 PCM matrix, for example, the use of polymers which make it possible to have mechanically
134 stable gels during the process liquid phase [5]. Similarly, the efficiency of the systems
135 developed requires an optimization study on the types of PCM to be used, the dimensions of
136 the system and the possible combinations in order to correctly manage the energy
137 charged/discharged in these products [6,7].

138 Two categories of integration can be distinguished, when incorporated into the building
139 envelope or in applications related to the thermal comfort regulation during the occupation
140 of the building. In the first type of integration, the following cases can be mentioned:
141 integration in floors [8–10], walls [11–13], masonry elements [14–16] and roofs [17–19]. This
142 integration category of PCM also includes its use in windows and glazing [20–22] as well as in
143 shading systems [23–25]. Concerning the use of PCMs in comfort conditioning systems
144 within the building, the free cooling method based on heat exchangers was developed
145 according to several approaches [26–29]. These different studies have shown that the
146 contribution of PCMs increases the thermal inertia and on the other hand improves the air
147 quality in buildings.

148 The vertical elements of the building are the most studied, the wall panels that can be fixed
149 on the base walls are among the solutions proposed. In this context, many products have
150 been tested and marketed because this solution makes it possible to minimize the level of
151 the peak temperature during hot periods and to save energy. The damping of the peaks of
152 temperature obtained can go up to 4°C [30–32]. Concrete and coatings PCM based are part
153 of the solutions applied to the walls. They are found under several compositions with
154 different percentages of PCM. The tests carried out in a real scale on cells, show the increase

155 of the storage capacity as a function of the volume ratio of the PCMs, as well as the
156 difference in indoor surface temperature with respect to a reference cell [12,33,34].

157 The solutions applied to the walls also include integration into the masonry elements. In this
158 configuration Alawdhi *et al.* [7] conducted an optimization study of the amount of PCM to be
159 introduced into bricks containing cylindrical cavities. By means of a 2D finite element model,
160 they show that the best configuration reduces the inward heat flux on the wall by 17.55%.
161 Zhang *et al.* [14] numerically studied the filling of holes in traditional bricks. As results, the
162 study shows a 10% decrease in the amplitude of the surface temperature of the wall. Principi
163 *et al.* [15] presented an experimental and theoretical study of the impact of a brick wall with
164 PCM. As result, they showed that the presence of PCM affects the peak of heat and it
165 generates a phase shift of 6 hours with a decrease of 25% of temperature amplitude.

166 In all these works on construction materials, the interest is on the behaviour of the PCM
167 mainly in relation to the quantity used and the different combinations of filling in order to
168 obtain the best possible configuration [35]. However, these applications do not allow the
169 control and management of the stored/recovered energy in the PCM other than the change
170 in quantities or the type of PCM. The PCM imposes its behaviour on the output indicators,
171 which reflect the response of the system. A wall containing PCM is solicited from the outside
172 by an oscillating temperature between two, maximum and minimum values influenced by
173 the solar heat flux, while the interior is restricted by a comfort temperature generally set by
174 conditioning systems that operate for compensating or eliminate the heat flux crossing the
175 walls. In summer, the heat loads crossing the wall can be considered negligible if compared
176 to the internal heat gains. Such heat loads are shifted during the night hours. The increase in
177 apparent heat capacity and a fast discharge will act and enhance the indoor comfort as it is
178 equivalent to efficient free cooling.

179 Often, the chosen phase change temperature is generally close to the comfort set point, this
180 remains valid as long as the PCM part is close to the inner side. Depending on the season
181 and weather conditions, charging and discharging a PCM-based wall does not occur at the
182 same time. In this situation, a rebalancing is necessary in order to accelerate or slow down
183 the charging period or to shift the discharge.

184 As part of this study, a new strategy is proposed for using a wall with PCM, adding internal
185 ventilation through tubes located within the PCM contained in the wall. Fig. 1 shows the wall
186 which consists of concrete blocks filled with PCM and ventilated channels. This solution
187 allows both increasing the thermal inertia thanks to the inertial capacity of the PCM and to
188 control the charge/discharge while enhancing the exchanges by injecting the air from the
189 outside to the inside. It thus allows contributing to the conditioning of the renewal of the
190 local air and the temperature change. The diagram presented in Fig. 1 also shows the utility
191 of such a system in the management of energy needs. It allows, for example, the storage of
192 the energy released during the night from heating [36]. Ventilation control through the
193 system helps to meet some of the morning's energy needs when occupants wake up.

194

Fig. 1. Principle and utility of the tubes in the developed solution.

195 The study of thermal solutions in the building usually goes through an experimental study
196 which serves as a basis for validation of the models and optimization on the numerical level.
197 The development of the numerical model is essential to show the usefulness of the solutions
198 and quantify the thermal behaviour of the systems. However, the resolution of the studied
199 physical system requires techniques based on equations describing the physical behaviour of
200 heat transfer. Generally, three main thermal building models are currently used in
201 modelling: multi-zone, zonal and CFD (Computational Fluid Dynamics) methods [37].

202 In the multi-zone or nodal approach, modelling by electrical analogy is a technique often
203 used. It simplifies the physical problem by linearizing the equations and thus reduces the
204 calculation time. The equivalent electric circuit, formed of resistances and capacitances (RC),
205 represents the fundamental physical relations which translate the studied thermal
206 phenomena. It is based on the combination of a thermal resistance R and a thermal capacity
207 C for each studied thermal element. The RC model is distinguished by its speed, which is an
208 important factor in simulations related to the building where the heat exchanges require
209 substantial time intervals where calculations generally become very heavy [38–43]. In
210 addition to the phenomena often modelled, namely conduction and convection, a modelling
211 of the phase change of paraffin with integrated ventilation system will be presented in this
212 study. The features of the Simscape library integrated in the Matlab/Simulink environment
213 are used. The method of resolution, thus adopted makes it possible to work on a circuit
214 constituted of variable resistances and capacitances.

215 This article is part of the studies on the direct integration of a phase change material into a
216 concrete block [44,45]. In this context, a structural element of "hollow concrete block" filled
217 with a polymer-paraffin composite and provided with ventilation tubes allowing the
218 circulation of air will be studied. The used mixture of PCM is mechanically stable and that
219 avoids the problem of leakage. This study will be presented in four main axes:

- 220 • The first one is developed in approaching the actual operating conditions of the
221 system and represents the experimental study which is used to compare the effect
222 of PCM filling and the influence of tube condition (open, closed and ventilated).
- 223 • The second part is dedicated to modelling of the system under COMSOL
224 Multiphysics.
- 225 • After validating the used model, the third part will be devoted to reducing the time
226 calculation request by using the electrical analogy modelling and the equivalent RC
227 model.
- 228 • Finally, a validation was performed by comparing the two models with the
229 experimental data.

230 2. System description

231 Fig. 2(a) presents a diagram and an illustration of the developed system which is based on a
232 commercial hollow Concrete Block having the following length x height x width dimensions:
233 50 cm x 20 cm x 9.5 cm. The concrete block consists of 3 parallelepiped cavities. A PVC tubes
234 are used, with a diameter of 2 cm and a thickness of 1 mm. Two holes are carried out in the
235 base of each cavity to place the six tubes. The PCM is incorporated directly in the molten
236 state in the cavities (temperature higher than the temperature of the solid gel).

237 **Fig. 2.** Description of the developed system: **(a)** Schematic of the ventilated hollow concrete
238 block integrating PCM **(b)** Schematic diagram of the experimental setup.

239 The used PCM is a mixture of paraffin and a styrene-type polymer. The choice of paraffin
240 removed both hydrated salts, known by their corrosive tendency, as well as unsuitable fatty
241 acids because in our case the PCM is directly put in contact with the concrete having a basic
242 pH. The use of a percentage of polymers in solution makes it possible to obtain a gel with
243 acceptable stability in order to avoid problems of leakage in the liquid state. Currently,
244 paraffin manufacturers offer a wide range that varies with melting temperature as well as
245 latent heat. Normally, the choice will have to take into consideration the antisymmetry
246 between the external conditions and the temperature of comfort fixed indoor. The melting
247 temperature chosen is important to create a wall temperature stabilization bearing close to
248 that of comfort and also offer a sufficient storage that allows the incoming air to be
249 conditioned through the tubes. The realized mixture has the same characteristics as that
250 used in the work of Royon et al. [5]. Base paraffin is a commercial product having a melting
251 temperature of 27 °C and a latent heat of 179 kJ/kg. This choice is also based on
252 experimental laboratory manipulation conditions, which requires a difference between the
253 melting temperature and the ambient temperature to avoid the onset of melting. The
254 percentage of the used polymer is of 15%. The latent heat after mixing is equal to 110 kJ/kg.
255 Table 1 summarizes the characteristics of the mixture as well as the materials constituting
256 the used system.

257 **Table 1.** Thermo-physical properties of the materials constituting the system.

258 3. Experimental study

259 This part is devoted to the description of the used experimental device as well as the
260 procedure explaining the progress of the realized tests.

261 The obtained results of the experimental study are presented and a comparative study of
262 the different mounting configurations chosen is carried out to show the system behaviour.

263 3.1. Experimental device and procedure

264 Using a real scale system imposes constraints to fully adapt the experimental study and the
265 actual operation of the considered element as a representative part of a sunny wall. The

266 experimental device consists of an electrical resistance which allows imposing a power heat
267 on the side surface of the concrete block. K-type thermocouples are arranged on both side
268 surfaces, they are placed at mid-height and on the same horizontal plane (Fig. 2(b)). Linked
269 to the acquisition system, they make it possible to follow the evolution of the temperature.
270 Small fans are used to inject air through the tubes. The speed and temperature of the air are
271 checked with a hot-wire anemometer. In order to avoid thermal losses at the edges of the
272 system, a layer of polyurethane foam surrounds the other surfaces is used. The second face
273 of the block is in contact with the ambient air of the laboratory room which varies slightly
274 around 21 °C.

275 A preliminary study of thermal stresses allowed choosing an adequate heating power so as
276 not to exceed a temperature of 50 °C on the heated surface. This maximum temperature is
277 chosen relative to the limit of the stability of the used gel. The solicitation chosen has three
278 cycles with a duration of 24 hours for each one. Each cycle consists of applying a constant
279 heat power for 5 to 6 hours, except for the concrete block without PCM which its inertia is
280 too low and this duration of cycle is reduced in this case. After stopping the thermal
281 solicitations, a normal cooling is applied for the rest of the cycle for all configurations, except
282 in the case with forced ventilation; the air injection is activated directly after halting. The
283 experimental device as presented in Fig. 3, allows simulation the operating principle of each
284 studied element. Also, this installation would serve as a basis for the development and
285 validation of a complete numerical tool.

286 **Fig. 3.** Photography of the experimental bench.

287 **3.2. Experimental results**

288 The adopted experimental methodology makes it possible to follow the evolution of the
289 temperatures by the application of three identical cycles of heat fluxes. The use of cyclic
290 stresses allows testing the thermal behaviour of the PCM over a more prolonged period. The
291 finding of each configuration is presented in Fig. 4. The curves show the temperature
292 evolutions recorded on the lateral surface in contact with the ambient air. The heat flux is
293 imposed in the same way for all configurations. However, the experimental protocol makes
294 that the operating intervals are different according to the configuration tested. The
295 threshold temperature of 50 °C is the basis for the control of the electrical resistance which
296 simulates the sunshine and not the duration of application of the thermal stresses, which is
297 the result of the inertia and the thermal behaviour of each configuration. Two systems are
298 studied here; empty concrete block without PCM and system with PCM and tubes. For the
299 second system, three cases can be distinguished according to the state of the tubes which
300 can be, closed, opened or ventilated.

301 **Fig. 4.** Evolution of the temperature on the lateral surface of the concrete block for different
302 configurations.

303 The analysis of temperature evolution from the third cycle as represented in Fig. 5, shows
304 the effect of PCM filling. On the one hand, it contributes to the increase in the phase shift
305 from 0.5 hour in the case without PCM to 3.8 hours; on the other hand, the PCM allows the
306 reduction of recorded temperature peaks of about 3.4 °C. The study of the state of the tubes
307 on the response of the wall shows that the decrease in the recorded maximum temperature
308 is a function of the transfer mode imposed through the tubes.

309 In the case where tubes are closed, the response of the system is explained by the
310 predominance of conduction due to the diameter of the tubes that does not promote the
311 establishment of the convection heat transfer. When the tubes are open, in this case, they
312 favour a convective heat exchange thanks to the difference in density of the air between the
313 inside and the outside of the tubes; this small contribution explains the decrease in the
314 temperature evolution. Forced convection induced by the air injection further enhances
315 system response. The ventilation allows lowering the temperature level quickly on the inner
316 surface; a decrease of temperature from 3.4 to 4.7 °C compared to the case without PCM.
317 This gain in temperature is accompanied by a decrease in phase shift time from 3.8 to 2.9
318 hours which is a normal result because the application of ventilation improves the
319 discharging by a withdrawal of energy and thus induces a cooling of the system too. This
320 behaviour also explains the ability of the ventilated system to store more energy, which
321 therefore increases the necessary time to reach the threshold temperature on the heated
322 surface. The curves show (Fig. 5) that it takes 6.5 instead of 4.5 hours for the system without
323 ventilation, while only 2.4 hours are needed for the concrete block without PCM.

324 **Fig. 5.** Temperature analysis on the lateral surface of the concrete block for the different
325 configurations starting from the third cycle.

326 The temperature of the outgoing air measured by the hot-wire anemometer shows that the
327 maximum increase thereof reaches about 10 °C during the exchange of the discharged
328 energy through the tubes. This operating scenario makes it possible to heat the incoming air
329 from the outdoor by supplying the energy recovered on the PCMs during the renewal of air.
330 The response of the complete system with ventilated tubes shows that the discharging of
331 the energy is not sufficient to reach the same temperature at the end of the cycle in the case
332 without PCM. These results clearly demonstrate the role of PCMs in energy storage and the
333 efficiency of the recovery system by the ventilated tubes. However, an optimization study on
334 the quantity of PCM and the characteristics of the tubes will allow finding the best
335 configuration with the experimental used conditions.

336 **4. Numerical simulation**

337 As part of phase change problems solving, the use of COMSOL Multiphysics has
338 demonstrated good correlations with experimental results [46–48]. It allows the solving of
339 problems governed by partial differential equations by the finite element method. The
340 formulation using apparent specific heat approach is used to model the phase change [49].

341 Three-dimensional modelling (3D) has been developed in this study. The partial differential
 342 equation that governs heat transfer in the model is given by Eq. (1).

$$343 \quad (\rho C_p) \left(\frac{\partial T}{\partial t} + u \nabla T \right) = \nabla (k \nabla T) \quad (1)$$

344 where ρ , C_p and k are the intrinsic characteristics of the concerned material, u is the
 345 velocity field. The main characteristics of the PCM are evaluated experimentally. The
 346 different thermo-physical properties of the materials (Table 1) are introduced into the
 347 modelling. The thermo-physical properties of the PCM are governed by Eqs. (2)–(6).

$$348 \quad k_{pcm} = f_v k_s + (1 - f_v) k_l \quad (2)$$

$$349 \quad \rho_{pcm} = f_v \rho_s + (1 - f_v) \rho_l \quad (3)$$

$$350 \quad C_{p_{pcm}} = \frac{f_v (\rho C_p)_s + (1 - f_v) (\rho C_p)_l}{\rho_{pcm}} + \frac{\partial \alpha_m}{\partial T} \times \Delta L \quad (4)$$

$$351 \quad \theta = \begin{cases} 1 & ; T < T_{sl} - \Delta T/2 \\ \frac{T - T_{sl}}{\Delta T} + 0.5 & ; T_{sl} - \frac{\Delta T}{2} \leq T \leq T_{sl} + \frac{\Delta T}{2} \\ 0 & ; T > T_{sl} + \Delta T/2 \end{cases} \quad (5)$$

$$352 \quad \alpha_m = \begin{cases} -1/2 & ; T < T_{sl} - \Delta T/2 \\ \frac{(1 - f_v) \rho_l - f_v \rho_s}{2 \times \rho_{pcm}} & ; T_{sl} - \frac{\Delta T}{2} \leq T \leq T_{sl} + \frac{\Delta T}{2} \\ 1/2 & ; T_{sl} + \Delta T/2 \end{cases} \quad (6)$$

353 where f_v is the volume fraction of the PCM solid phase, ΔT is the phase transition interval,
 354 T_{sl} is the phase change temperature and α_m is the mass fraction defined from ρ_s , ρ_l and
 355 f_v .

356 The considered boundary conditions are as follows: on the heated side surface, a
 357 homogeneous temperature corresponding to the average temperature recorded
 358 experimentally was imposed. On the other side surface, a convective exchange with the
 359 ambient environment was used. The convective transfer coefficient, h_{con} between the
 360 lateral surface of the block and the ambient air, is calculated by Eq. (7).

$$361 \quad h_{conv} = \frac{Nu k_{air}}{L_w} \quad (7)$$

362 where Nu is the Nusselt number, k_{air} is the air thermal conductivity and L_w is the
 363 characteristic length of the surface of the concrete block. In our case, the flow is laminar and
 364 Nu is calculated from the correlation on a vertical plane [50] as:

$$365 \quad Nu = 0.59 \times Ra^{1/4} \quad (8)$$

366 The convection coefficient h_{con} calculated with the correlation is equal to $3.3 \text{ W/m}^2.K$. In
 367 addition to the convective effects, the lateral surface is subject to the phenomenon of
 368 radiation where the radiation heat flux is written as:

$$369 \quad Q_{rad} = \epsilon \sigma (T_w^4 - T_{amb}^4) \quad (9)$$

370 where ϵ is the emissivity of the concrete block which takes as value 0.9.

371 For modelling the case without ventilation, it is considered that the diameters of the tubes
 372 do not allow the appearance of a significant convective mode. However, the injection of
 373 ambient air, with the fans through the tubes, is activated with a measured speed of 1.3 m/s .
 374 The calculation of the Reynolds number Re shows that the regime is laminar. The studied
 375 model has short diameter pipes; which imposes to take into account the effects of the inlet
 376 region, the correlation of Seider and Tate [51] is used to calculate the Nusselt number Nu
 377 inside the tube:

$$378 \quad N_{ut} = 1.86 \times \left(Re \times Pr \frac{D_i}{L_t} \right)^{0.33} \left(\frac{\mu}{\mu_{wt}} \right)^{0.14} \quad (10)$$

379 Dynamic viscosity μ and the Prandtl number Pr are evaluated at the average temperature
 380 of the air between the inlet and the outlet of the tube. Thus, μ_{wt} is the viscosity of the air
 381 determined for the wall temperature of the tube T_{wt} . D_i and L_t represent respectively
 382 the inside diameter and the length of the pipe. As of the correlation, the forced convection
 383 coefficient through the tube is set equal to $11.7 \text{ (W/m}^2.K)$. On the other surfaces of the
 384 concrete block; a zero heat flow condition is used (adiabatic surface).

385 **5. Modelling by electrical analogy**

386 It becomes a classical approach in order to simplify a thermal system and predict the
 387 temperature evolution over time under the control-command strategy. First, the principle of
 388 thermo-electric analogy and the decomposition of the system into a unitary element will be
 389 presented. After that, the modelling of the system will be detailed.

390

5.1. Principle of thermal modelling by electrical analogy

391 Thermal modelling by electrical analogy is based on the analogy with Ohm's law in
 392 electricity. The temperature and the heat flux play respectively in this problem the same role
 393 as the potential and the current in electricity. It is, therefore, possible to adopt for the
 394 thermal resistances the same representation as for the electrical resistances. As the
 395 electrical and thermal systems are similar, going from one system to another is possible
 396 while respecting the equivalences existing between the different components (Fig. 6).

397

Fig. 6. Equivalent electrical circuit (1R1C) in the unsteady case.

398 Assuming the unidirectional transfer of heat, the conductive heat flux Q , through a layer of
 399 a thick wall e_w , under the influence of a temperature difference $\Delta T = T_{wo} - T_{wi}$ is written as:

$$400 \quad Q = \frac{k S}{e_w} (T_{wo} - T_{wi}) \quad (11)$$

401 In electricity, the application of a potential difference ΔV to a similar element is governed
 402 by Ohm's law, the electric current I is equivalent to the heat flux and it is expressed as:

$$403 \quad I = \frac{\sigma S}{e_w} \Delta V = \frac{1}{R_{elec}} \Delta V \quad (12)$$

404 According to the two equations (11) and (12), the similarity with the electrical resistance
 405 allows to define the thermal resistance of conduction R (K/W):

$$406 \quad R = \frac{e_w}{k S} \quad (13)$$

407 It quantifies the resistance that the system opposes to the passage of heat flux. Its
 408 expression depends on the considered geometry, k is the thermal conductivity and S is
 409 the surface of the layer.

410 In the same way, the stored energy in Joules by a mass m , having a mass capacity C_m at the
 411 temperature $T(K)$ is written:

$$412 \quad U = \int Q dt = mc_m \Delta T \quad (14)$$

$$413 \quad Q = mc_m \frac{dT}{dt} \quad (15)$$

414 Analogously, the equation of the intensity I which passes through a capacitance C_{elec} with
 415 a tension V is written:

$$416 \quad I = C_{elec} \frac{dV}{dt} \quad (16)$$

417 The thermal capacity C (J/K) represents the storage of the heat in the layer of the wall and
 418 it is given by:

$$419 \quad C = \rho c_m e_w S \quad (17)$$

420 The notion of thermal resistance allows the modelling of other phenomena, for example, the
 421 convective exchanges between a solid wall of temperature T_w and a fluid at a temperature
 422 T . Indeed, through Newton's law expressed in Eq. (18), a convective resistance R_{con} is
 423 defined by Eq. (19).

$$424 \quad (T_w - T) = R_{con} Q_{conv} \quad (18)$$

$$425 \quad R_{con} = \frac{1}{h_{conv} S} \quad (19)$$

426 Q_{con} is the convection heat flux and h_{con} is the convective exchange coefficient between the
 427 wall and the fluid.

428 The thermal/electrical equivalence makes it possible to derive the following properties:

- 429 ▪ An imposed temperature is identical to a voltage generator.
- 430 ▪ A heat flow is identical to an electric power generator.
- 431 ▪ A body of mass m and heat capacity C_m ; heated to the temperature T , is identical
 432 to a capacitor having a capacity mC_m related to the mass and the imposed voltage
 433 source.

434 5.2. Physical module decomposition

435 The passage from a purely thermal system to a model based on electrical phenomena
 436 requires an understanding of the physics that governs the system. In our configuration, there
 437 are 3 parts: concrete, phase change material and air tube. The study of the symmetry of the
 438 concrete block, in a wall or as an isolated element, allows us to adopt the decomposition of
 439 the system into 6 identical elements as represented in (Fig. 7).

440 **Fig. 7.** System decomposition into unitary elements.

441 Similarly, as a precaution, a study was conducted for the validation of the chosen geometric
442 layout. Numerical simulations based on the finite element model were carried out in the
443 case without ventilation.

444 Fig. 8 represents comparative study between 2D and 3D (configurations (b) and (c))
445 simulations of the lateral surface temperatures of the complete system and the unit element
446 as well as the experimental data. (1) Configuration (a) illustrates a section of the unitary
447 element at horizontal level on the tube. (2) Configuration (b) represents 3D unit element. (3)
448 Configuration (c) shows the 3D complete system. It reveals that numerical results obtained
449 from the 3D configurations are close to the experimental test then that obtained from 2D
450 configuration. This is can be explained by the effect of the rib of the neglected concrete in
451 the geometry (a). In addition, finite element flow modelling with geometry (a) is complicated
452 to transform the outflow into an exchange coefficient. Therefore, configurations (b) and (c)
453 can be considered to perform numerical validation. The configuration (c) has been adopted.

454 **Fig. 8.** Evolution of the average temperature on the inner surface for different geometric
455 approaches in the case without ventilation.

456 According to the analysis carried out, the physical problem to be modelled is presented in
457 Fig. 9; the diagram represents the chosen revealing zone. Physically, the influence of the
458 tube is done in three dimensions. The RC circuit approach is based on the average
459 temperatures of each modelled block; the horizontal flow between the two faces represents
460 the main heat exchange in our system, the integration of ventilation adds a second exchange
461 on the vertical. The modelling of these two exchanges with the electrical analogy requires a
462 good understanding of the system from the two geometries (a) and (b) (Fig. 8). Thus, the
463 hypothesis of a unidirectional transfer allows distinguishing three parallel levels that
464 represent the succession of the elements constituting each part.

465 **Fig. 9.** The configuration of the revealing zone studied according to thermal exchanges.

466 **5.3. System modelling**

467 The RC circuit modelling, proposed in this work, is based on the use of the Matlab Simscape
468 tool. Its library proposes several models for the direct integration of electrical, thermal,
469 mechanical and hydraulic phenomena which allow to quickly creating physical system
470 models in the Simulink environment.

471 The electrical model enables the creation of the circuit from the physical connections to
472 obtain block diagrams. In the sense of electrical and thermal analogy, every part of our
473 physical model will be replaced by an electrical circuit of resistances and capacitances, as
474 well as for imposed boundary conditions.

475 Before arriving at the equivalent diagram representing the studied element, simple models
476 were used to translate the behaviour of a single block of PCM. Thereafter, the other

477 elements were added progressively; the concrete parts as well as the air tube. The diagram
 478 in Fig. 10 represents the equivalent thermal model with its boundary conditions.

479 **Fig. 10.** Equivalent system diagram with the boundary conditions.

480 In our model, each concrete element would be replaced by an electrical circuit consisting of
 481 a resistance R_c and a capacitance C_c . According to the dimensions of each block, the
 482 formulas used in the calculation are:

$$483 \quad R_c = \frac{e_c}{k_c S_c} \quad (20)$$

$$484 \quad \text{and} \quad C_c = \rho_c c_{p_c} e_c S \quad (21)$$

485 with k_c , ρ_c and c_{p_c} are respectively, the characteristics of the concrete, the thermal
 486 conductivity, the density and the mass capacity, e_c and S_c represents the thickness and
 487 surface area of each part of the concrete.

488 In the experimental module, the lateral surface is subjected to convective exchanges; the
 489 convection coefficient h_{con} is calculated in the like in section 4. The convection resistance
 490 with the ambient air is written as follows:

$$491 \quad R_{conv} = \frac{1}{h_{conv} S} \quad (22)$$

492 For taking into account the heat transfer by radiation from a surface to inside a building,
 493 there are several methods that estimate, in a more or less approximate way, the radiative
 494 exchanges between the surfaces. A linear equation expressing the heat flux between a wall
 495 of temperature T and all the other walls is used [52]. The radiative heat flux on the lateral
 496 face is given by:

$$497 \quad Q_{rad} = h_{rad} S (T - T_w) \quad (23)$$

498 The expression of h_{rad} depends on the average temperature of the walls T_w . This
 499 temperature is considered equal to the ambient temperature:

$$500 \quad h_{rad} = 4\epsilon\sigma T_{amb}^3 \quad (24)$$

501 The radiative resistance R_{rad} on the lateral surface of our model is:

$$502 \quad R_{rad} = \frac{1}{h_{rad} S} \quad (25)$$

503 The elements containing the paraffin/polymer mixture constitute a system that stores the
 504 heat in a sensible and latent form, which results in a storage capacity and a thermal
 505 resistance that vary according to the solid and liquid state of the mixture. This is why in
 506 order to encompass the entire phenomenon of phase change by electrical analogy; each
 507 volume of PCM is replaced by an electrical block consisting of a resistance and a variable
 508 capacity depending on the temperature.

509 The variable capacity C_{pcm} for a PCM block having a volume V_{pcm} is given by Eq. (26).

$$510 \quad C_{pcm} = \rho_{pcm} c_{p,pcm} V_{pcm} \quad (26)$$

511 with $c_{p,pcm}$ is the variation of specific capacity of the mixture adopted for thermo-electric
 512 modelling.

513 The density of the phase change material is defined by Eq. (27).

$$514 \quad \rho_{pcm} = \begin{cases} \rho_s & ; T < T_{om} \\ \frac{(\rho_s + \rho_l)}{2} & ; T_{om} \leq T \leq T_{sl} \\ \rho_l & ; T > T_{sl} \end{cases} \quad (27)$$

515 where T_{om} is the temperature that marks the start of the fusion obtained from the DSC
 516 experimental measurements and T_{sl} is the solid-liquid phase transition temperature.

517 The specific capacity modelling is based on the experimentally obtained curve, the work of
 518 Alisetti and Roy [53] shows that the equivalent function shape $c_{p,eq}(T)$ has only a low
 519 influence on heat transfer. Taking into account the phase change in the transition interval
 520 which is defined by:

- 521 • The melting temperature T_{sl}
- 522 • The melting interval ΔT determined from the melting curve obtained by DSC
 523 (first initiation of the phase change T_{om} to the peak of transition)
- 524 • The calculated latent heat (integration of the total surface during the solid-
 525 liquid transition)
- 526 • Specific heats in the solid and liquid state ($c_{p,s}$ and $c_{p,l}$)

527 **Fig. 11.** Adopted modelling of the specific capacity of the PCM.

528 The adopted equivalent thermal capacity is, as simple as possible according to the
 529 announced indications; it respects the conservation of the amount of involved energy. Fig.
 530 11 shows the evolution of the involved thermal capacity; its equation is written as:

$$c_{p_{pcm}} = \begin{cases} c_{ps} & ; T < T_{om} \\ c_{peq} = \frac{\Delta L}{T_{sl} - T_{om}} & ; T_{om} \leq T \leq T_{sl} \\ c_{pl} & ; T > T_{sl} \end{cases} \quad (28)$$

Likewise, as given in relation (29), the resistance of each block of the PCM is a variable resistance depending on the liquid or solid conductivity according to the temperature:

$$R_{pcm} = \frac{e_{pcm}}{k_{pcm} S_{pcm}} \quad (29)$$

where e_{pcm} is the thickness of each part of the PCM and k_{pcm} is the variable conductivity according to the state of the PCM solution which is expressed by Eq. (30).

$$k_{pcm} = \begin{cases} k_s & ; T < T_{om} \\ (k_s + k_l) / 2 & ; T_{om} \leq T \leq T_{sl} \\ k_l & ; T > T_{sl} \end{cases} \quad (30)$$

- *Tube and airflow*

Taking into account the tube in the modelling of the studied thermal system begins with its thermal resistance. The assumption of a unidirectional heat transfer and the behaviour of the module impose the consideration of two heat flows which exchange to the right and to the left of the tube. Subsequently, splitting the thermal resistance in half is necessary to differentiate the total resistance on each side.

The thermal resistance of the tube R_t is written as:

$$R_t = \frac{\log\left(\frac{D_o}{D_i}\right)}{2\pi k_t L_t} \quad (31)$$

where D_i and D_o are the inner and outer diameters of the tube, L_t is the length of the tube and k_t is the thermal conductivity of the tube. The modelling of the flow is different according to the state of the tubes: open or ventilated. The dimensions of the tube do not allow the appearance of a significant convective mode in the open configuration case. The air part through the tube is modelled with a thermal resistance of heat conduction expressed by Eq. (32).

$$R_{air} = \frac{D}{k_{air} S_{air}} \quad (32)$$

553 where k_{air} is the thermal conductivity of the air and S_{ii} is the lateral surface of the air
 554 volume.

555 In the case of forced flow with fans, the problem evolves in the three directions; taking into
 556 account the passage of air using the exchange coefficients is not sufficient for modelling
 557 electrical-thermal equivalence. The injection of air through the tube is characterized by two
 558 elements, the speed and the temperature of the incoming air. In the sense of electrical
 559 analogy modelling, a temperature or a voltage will model the interaction of the flow of air
 560 entering with the flows exchanged horizontally across the system.

561 In order to identify this temperature, it is necessary to express the heat balance equation at
 562 the midpoint of the tube which is the mean temperature over the height. Fig. 12(a) describes
 563 the flows exchanged in the horizontal and vertical direction.

564 **Fig. 12.** Airflow modelling through the tube: **(a)** The schematic diagram of modelling
 565 parameters, **(b)** Equivalent electrical diagram of the middle part containing the tube.

566 The heat balance equation (33) can be written and then resolved for the air temperature in
 567 the middle of the system T_{air} :

$$568 \quad \dot{m}_{air} C_{p_{air}} (T_{in} - T_{out}) = R_{T1} (T_f - T_{air}) + R_{T2} (T_{amb} - T_{air}) \quad (33)$$

569 where R_{T1} and R_{T2} represent the total thermal resistance respectively on the left between
 570 T_{wo} and T_{air} , and on the right between T_{air} and T_{aml} . T_{in} and T_{out} are respectively the
 571 inlet and outlet air temperature across the tube.

572 The resolution of the air temperature, as a function of the travelled distance, in the case
 573 where the convection coefficients through the tube are equal [54], gives the expression (34).

$$574 \quad T_{air} = \frac{H_1 T_{wo} + H_2 T_{amb}}{H_1 + H_2} + \exp\left(\frac{-(H_1 + H_2)S}{\dot{m}_{air} C_{p_{air}}}\right) \left(T_{in} - \frac{H_1 T_{wo} + H_2 T_{amb}}{H_1 + H_2}\right) \quad (34)$$

$$575 \quad \text{with} \quad H_1 = \left(\frac{e_c}{k_c} + \frac{e_{pcm}}{k_{pcm}} + D_o \frac{\log(D_o / D_i)}{4\pi k_t} + \frac{1}{h_v} \right)^{-1} \quad (35)$$

$$576 \quad H_2 = \left(H_1^{-1} + (h_{rad} + h_{conv})^{-1} \right)^{-1} \quad (36)$$

577 where H_1 and H_2 are two coefficients that translate the heat transfer by convection and
 578 conduction on both sides of the tube. Thus, h_v , h_{rad} and h_{con} are respectively the
 579 coefficient of convection through the tube during ventilation, the coefficient of radiation on

580 the lateral surface and the convection coefficient with the ambient air. These coefficients are
581 calculated previously in the description of the models.

582 The expression of the temperature T_{air} depends on the ambient temperature T_{aml} and the
583 temperature T_{wo} that simulates the thermal solicitations on the lateral surface. When
584 integrated into the RC model, this temperature is equivalent to a variable voltage generator
585 according to the temperature of the PCM which reflects the variations of the resistances
586 expressed in the coefficients H_1 and H_2 .

587 Fig. 12(b) shows the equivalent electrical diagram used in the middle part of the model (see
588 Fig. 10). The arrows on the components indicate that these elements are variable; it
589 concerns the parts of the PCM as well as the temperature used in the modelling of the
590 airflow. In the RC model thus developed, the objective was to evaluate the response of the
591 surface of the system; a 1R1C circuit was used to model each part. The spatial discretization
592 used is fine enough to accurately determine the temperature of the output surfaces. If the
593 objective is to follow the detailed evolution of the temperature in a specific material, a
594 discretization with more nodes will be applied to each element [55].

595 **6. Validation results and discussion**

596 Fig. 13 presents the comparison between the results obtained from the FEM/RC simulations
597 and those obtained by experimentation for the two cases without and with ventilation. The
598 FEM was developed primarily as a reference for examining the accuracy of the model with
599 RC network. For this purpose, the first comparison concerns the results of the FEM with the
600 experiment; Table 2 represents the values of the relative errors calculated with respect to
601 the experimental data. The average relative error does not exceed 1.4% and the maximum
602 relative error is about 4.6% in the case without ventilation. This small discrepancy between
603 these data is probably due to three factors: the degree of uniformity of the thermal power
604 given by the heating resistor, the influence of thermal insulation, which is not ideal for
605 eliminating all heat losses. For modelling the PCM, the used effective thermal capacity, only
606 involves the measurement performed during the fusion.

607 Indeed, during solidification, the curve is slightly different. Taking into account this
608 hysteresis between fusion and solidification during numerical validation has been the subject
609 of numerous studies. Baghban et al. [56] indicated that it is essential to use the melting and
610 freezing characteristics of PCM to achieve good agreement between experimental and
611 numerical results. Kośny [57] stated that the use of simplified algorithms that do not include
612 hysteresis can lead to significant inaccuracies for a large number of non-paraffinic organic
613 and inorganic PCMs. Goia et al. [58] demonstrated that for paraffin organic PCM, the
614 available building energy simulation software is fairly accurate even if the effect of hysteresis
615 is neglected.

616 Thus, according to these different studies, the fact that hysteresis is not taken into account
617 does not affect significantly our results. Despite the noted slight difference, there is a good
618 agreement between the simulation and the experiment, which makes possible to validate
619 the finite element model used in the simulation.

620 **Fig. 13.** Temperature of the surface of the concrete block, comparison of the experimental
621 data with the two models RC and FEM: **(a)** without ventilation, **(b)** with ventilation.

622 For comparison of the RC model with the experimental data, Fig. 13 illustrates a similar
623 trend of variation between the simulated and measured values, in both cases with and
624 without ventilation. Relative errors calculated with respect to the experiment are acceptable
625 for direct validation. The difference between the two numerical models is mainly due to the
626 modelling of the phenomenon of phase change with the electrical analogy which is based on
627 the use of variable resistances and capacitances. Thus, the simplifying assumptions used in
628 the RC model do not allow capturing the simulated complexity in 3D with the CFD model.
629 These discrepancies have no significant effect on the accuracy of the obtained simulation
630 results. The temperature on the lateral surface of the system is very well predicted by the RC
631 network model and the maximum relative error is less than 4.0%. It can be concluded that
632 the developed RC model can be directly used to replace a fairly heavy CFD simulation in
633 computing time.

634 **Table 2.** Results of relative error between experimental and numerical data.

635 Following the analysis previously conducted on the experimental results, Fig. 13(b) clearly
636 illustrates that ventilation occurs in the heat transfer and that its influence even acts on the
637 heated side surface. The temperature evolution of this face gives more information on the
638 state of the PCM inside. For both cases, a surface can be distinguished, which evolves
639 between the horizontal line that shows the phase change temperature of the mixture T_{sl}
640 and the ambient temperature T_{amb} . The temperature variation on the internal face evolves
641 in this surface; it approaches of T_{sl} in the case without ventilation and tends towards T_{amb}
642 with ventilation.

643 In order to make a link against a real situation, this difference with respect to the ambient
644 temperature defines the heat flux passing through the wall and consequently the energy
645 requirement of air conditioning to reach the comfort temperature replaced here by the
646 ambient temperature. The gradient of the applied thermal heat flux acts progressively, the
647 concrete part rapidly reaches the steady state and all the energy transmitted is stored by
648 PCM. Gradually, the temperature of the internal face exceeds the ambient temperature and
649 a heat flux begins to leave this face towards the ambient environment. After stopping the
650 thermal solicitations, the temperature decreases and the PCM become a source that
651 releases energy. In Fig. 13(a), the stabilization bearing below T_{sl} marks the solidification
652 with a temperature close and parallel to T_{sl} . The air injection at T_{amb} by ventilation after
653 stopping of the thermal power gives rise to a vertical heat transfer which is added to that

654 established horizontally. The presence of the insulation on the heated side explains that the
655 descent, noted on the heating curve is mainly due to the evacuation of energy through the
656 tubes (Fig. 13(b)), the influence is significant because the average temperature on the
657 internal face goes from 25 to 23.8 °C. Thus, decreasing the energy requirement is also
658 accompanied by a significant capacity to increase the temperature of the air entering
659 through the tubes.

660 **7. Conclusions**

661 In this work, a study of a thermal system developed to regulate the indoor temperature of a
662 building have been proposed. The combination of the inertia effect of PCM introduced in the
663 wall elements coupled to a ventilation system leads to a better use of the energy stored in a
664 building wall. This solution uses building materials as a basic element and aims to improve
665 the thermal response of PCM building walls and to demonstrate the feasibility of such an
666 energy solution.

667 An experimental device was made based on a hollow concrete block filled with mechanically
668 stable paraffin and equipped with ventilation tubes. The results have confirmed that the
669 insertion of paraffin with tubes allows the creation of a thermal phase shift and the
670 improvement of the inertial capabilities of the studied element. The ventilated tubes play
671 the role of the regulator to unload the system and thus heat the injected air. The operation
672 principle of this type of system is confirmed. However, the small scale of the experiment and
673 the influence of the air flow at the entry of the tubes constitute limitations for the
674 generalization of the experimental results in the real scale of a wall. In this framework, it is
675 important to specify that there are many optimization parameters that can be used to
676 operate the system at the wall scale as well as adaptation to climate conditions and desired
677 operation. These parameters are: tube dimensions compared to the amount of PCM, flow
678 velocity, the geometry of the tubes and their arrangement in the cavities, the phase change
679 temperature as well as the type of the PCM and the materials of the constructions used.

680 On the numerical section, an RC network model has been developed, it proposes a simplified
681 approach to models the thermal heat transfer by using the Simscape tool under Matlab, it
682 allows both to get closer to the performance of CFD models in taking into account the
683 evolution of the physical phenomena and it offers a great speed of the execution of the
684 simulations, a parameter required in the calculations related to the building. Similarly, the
685 model proposes a new approach to modelling the phase change by using grey boxes with
686 their resistances and varying capacitances. The finite element model is proposed as a
687 reference for comparing the accuracy of the RC model.

688 The analysis of the obtained results has confirmed the validity of the RC model for predicting
689 the temperature evolutions of the system surface. The model developed in this study will be
690 used to define the quantity of the PCM and the optimal dimensions of the elements of the
691 system according to scenarios closer to reality. This study has made possible to test the

692 feasibility and the performance of this proposed solution, and the validation of numerical
693 tools allows the passage from elementary reasoning to a larger scale, this will be the basis
694 for achieving the final aim of obtaining an optimal wall based on PCM filled elements and
695 controlled by ventilation pipes.

696 **Acknowledgements**

697 The authors would like to thank the Grand Troyes Community in France for partially funding
698 this work. The LMT/ENS-Paris Saclay for affording the first version set-up.

699

700 **References**

- 701 [1] D. Zhou, C.Y. Zhao, Y. Tian, Review on thermal energy storage with phase change
702 materials (PCMs) in building applications, *Appl. Energy*. 92 (2012) 593–605.
703 doi:10.1016/j.apenergy.2011.08.025.
- 704 [2] A.M. Khudhair, M.M. Farid, A review on energy conservation in building applications
705 with thermal storage by latent heat using phase change materials, *Energy Convers.*
706 *Manag.* 45 (2004) 263–275. doi:10.1016/S0196-8904(03)00131-6.
- 707 [3] F. Kuznik, D. David, K. Johannes, J.J. Roux, A review on phase change materials
708 integrated in building walls, *Renew. Sustain. Energy Rev.* 15 (2011) 379–391.
709 doi:10.1016/j.rser.2010.08.019.
- 710 [4] L.F. Cabeza, A. Castell, C. Barreneche, A. De Gracia, A.I. Fernández, Materials used as
711 PCM in thermal energy storage in buildings: A review, *Renew. Sustain. Energy Rev.* 15
712 (2011) 1675–1695. doi:10.1016/j.rser.2010.11.018.
- 713 [5] L. Royon, L. Karim, A. Bontemps, Thermal energy storage and release of a new
714 component with PCM for integration in floors for thermal management of buildings,
715 *Energy Build.* 63 (2013) 29–35. doi:10.1016/j.enbuild.2013.03.042.
- 716 [6] L. Royon, L. Karim, A. Bontemps, Optimization of PCM embedded in a floor panel
717 developed for thermal management of the lightweight envelope of buildings, *Energy*
718 *Build.* 82 (2014) 385–390. doi:10.1016/j.enbuild.2014.07.012.
- 719 [7] E.M. Alawadhi, Thermal analysis of a building brick containing phase change material,
720 *Energy Build.* 40 (2008) 351–357. doi:10.1016/j.enbuild.2007.03.001.
- 721 [8] K. Lin, Y. Zhang, X. Xu, H. Di, R. Yang, P. Qin, Modeling and simulation of under-floor
722 electric heating system with shape-stabilized PCM plates, *Build. Environ.* 39 (2004)
723 1427–1434. doi:10.1016/j.buildenv.2004.04.005.
- 724 [9] R. Ansuini, R. Larghetti, A. Giretti, M. Lemma, Radiant floors integrated with PCM for
725 indoor temperature control, *Energy Build.* 43 (2011) 3019–3026.
726 doi:10.1016/j.enbuild.2011.07.018.
- 727 [10] A. Figueiredo, J. Lapa, R. Vicente, C. Cardoso, Mechanical and thermal characterization
728 of concrete with incorporation of microencapsulated PCM for applications in
729 thermally activated slabs, *Constr. Build. Mater.* 112 (2016) 639–647.
730 doi:10.1016/j.conbuildmat.2016.02.225.
- 731 [11] A. Castell, I. Martorell, M. Medrano, G. Pérez, L.F. Cabeza, Experimental study of using
732 PCM in brick constructive solutions for passive cooling, *Energy Build.* 42 (2010) 534–

- 733 540. doi:10.1016/j.enbuild.2009.10.022.
- 734 [12] L.F. Cabeza, C. Castellón, M. Nogués, M. Medrano, R. Leppers, O. Zubillaga, Use of
735 microencapsulated PCM in concrete walls for energy savings, *Energy Build.* 39 (2007)
736 113–119. doi:10.1016/j.enbuild.2006.03.030.
- 737 [13] M. Zhang, M.A. Medina, J.B. King, Development of a thermally enhanced frame wall
738 with phase-change materials for on-peak air conditioning demand reduction and
739 energy savings in residential buildings, *Int. J. Energy Res.* 29 (2005) 795–809.
740 doi:10.1002/er.1082.
- 741 [14] C. Zhang, Y. Chen, L. Wu, M. Shi, Thermal response of brick wall filled with phase
742 change materials (PCM) under fluctuating outdoor temperatures, *Energy Build.* 43
743 (2011) 3514–3520. doi:10.1016/j.enbuild.2011.09.028.
- 744 [15] P. Principi, R. Fioretti, Thermal analysis of the application of PCM and low emissivity
745 coating in hollow bricks, *Energy Build.* 51 (2012) 131–142.
746 doi:10.1016/j.enbuild.2012.04.022.
- 747 [16] X. Wang, H. Yu, L. Li, M. Zhao, Experimental assessment on the use of phase change
748 materials (PCMs)-bricks in the exterior wall of a full-scale room, *Energy Convers.*
749 *Manag.* 120 (2016) 81–89. doi:10.1016/j.enconman.2016.04.065.
- 750 [17] A. Pasupathy, L. Athanasius, R. Velraj, R. V. Seeniraj, Experimental investigation and
751 numerical simulation analysis on the thermal performance of a building roof
752 incorporating phase change material (PCM) for thermal management, *Appl. Therm.*
753 *Eng.* 28 (2008) 556–565. doi:10.1016/j.applthermaleng.2007.04.016.
- 754 [18] H. Elarga, S. Fantucci, V. Serra, R. Zecchin, E. Benini, Experimental and numerical
755 analyses on thermal performance of different typologies of PCMs integrated in the
756 roof space, *Energy Build.* 150 (2017) 546–557. doi:10.1016/j.enbuild.2017.06.038.
- 757 [19] S. Guichard, F. Miranville, D. Bigot, H. Boyer, A thermal model for phase change
758 materials in a building roof for a tropical and humid climate: Model description and
759 elements of validation, *Energy Build.* 70 (2014) 71–80.
760 doi:10.1016/j.enbuild.2013.11.079.
- 761 [20] F. Goia, M. Perino, V. Serra, Improving thermal comfort conditions by means of PCM
762 glazing systems, *Energy Build.* 60 (2013) 442–452. doi:10.1016/j.enbuild.2013.01.029.
- 763 [21] D. Li, Y. Wu, C. Liu, G. Zhang, M. Arici, Energy investigation of glazed windows
764 containing Nano-PCM in different seasons, *Energy Convers. Manag.* 172 (2018) 119–
765 128. doi:10.1016/j.enconman.2018.07.015.
- 766 [22] S. Li, K. Zou, G. Sun, X. Zhang, Simulation research on the dynamic thermal
767 performance of a novel triple-glazed window filled with PCM, *Sustain. Cities Soc.* 40
768 (2018) 266–273. doi:10.1016/j.scs.2018.01.020.
- 769 [23] E.M. Alawadhi, Using phase change materials in window shutter to reduce the solar
770 heat gain, *Energy Build.* 47 (2011) 421–429. doi:10.1016/j.enbuild.2011.12.009.

- 771 [24] K.A.R. Ismail, J. Henriquez, Thermally effective windows with moving phase change
772 material curtains, *Appl. Therm. Eng.* 21 (2001) 1909–1923. doi:10.1016/S1359-
773 4311(01)00058-8.
- 774 [25] A. Komerska, L. Bianco, V. Serra, S. Fantucci, M. Rosiński, Experimental analysis of an
775 external dynamic solar shading integrating PCMs: First results, in: *Energy Procedia*,
776 2015: pp. 3452–3457. doi:10.1016/j.egypro.2015.11.125.
- 777 [26] K. Nagano, S. Takeda, T. Mochida, K. Shimakura, T. Nakamura, Study of a floor supply
778 air conditioning system using granular phase change material to augment building
779 mass thermal storage—Heat response in small scale experiments, *Energy Build.* 38
780 (2006) 436–446. doi:10.1016/j.enbuild.2005.07.010.
- 781 [27] A. Waqas, Z. Ud Din, Phase change material (PCM) storage for free cooling of buildings
782 - A review, *Renew. Sustain. Energy Rev.* 18 (2013) 607–625.
783 doi:10.1016/j.rser.2012.10.034.
- 784 [28] M. Iten, S. Liu, A. Shukla, A review on the air-PCM-TES application for free cooling and
785 heating in the buildings, *Renew. Sustain. Energy Rev.* 61 (2016) 175–186.
786 doi:10.1016/j.rser.2016.03.007.
- 787 [29] H. Akeiber, P. Nejat, M.Z.A. Majid, M.A. Wahid, F. Jomehzadeh, I. Zeynali Famileh, J.K.
788 Calautit, B.R. Hughes, S.A. Zaki, A review on phase change material (PCM) for
789 sustainable passive cooling in building envelopes, *Renew. Sustain. Energy Rev.* 60
790 (2016) 1470–1497. doi:10.1016/j.rser.2016.03.036.
- 791 [30] M. Ahmad, A. Bontemps, H. Sallée, D. Quenard, Experimental investigation and
792 computer simulation of thermal behaviour of wallboards containing a phase change
793 material, *Energy Build.* 38 (2006) 357–366. doi:10.1016/j.enbuild.2005.07.008.
- 794 [31] F. Kuznik, J. Virgone, Experimental investigation of wallboard containing phase change
795 material: Data for validation of numerical modeling, *Energy Build.* 41 (2009) 561–570.
796 doi:10.1016/j.enbuild.2008.11.022.
- 797 [32] C. Hasse, M. Grenet, A. Bontemps, R. Dendievel, H. Sallée, Realization, test and
798 modelling of honeycomb wallboards containing a Phase Change Material, *Energy*
799 *Build.* 43 (2011) 232–238. doi:10.1016/j.enbuild.2010.09.017.
- 800 [33] D. Zhang, Z. Li, J. Zhou, K. Wu, Development of thermal energy storage concrete, *Cem.*
801 *Concr. Res.* 34 (2004) 927–934. doi:10.1016/j.cemconres.2003.10.022.
- 802 [34] T. Lee, D.. Hawes, D. Banu, D. Feldman, Control aspects of latent heat storage and
803 recovery in concrete, *Sol. Energy Mater. Sol. Cells.* 62 (2000) 217–237.
804 doi:10.1016/S0927-0248(99)00128-2.
- 805 [35] K. Kant, A. Shukla, A. Sharma, Heat transfer studies of building brick containing phase
806 change materials, *Sol. Energy.* 155 (2017) 1233–1242.
807 doi:10.1016/j.solener.2017.07.072.
- 808 [36] Y. Zhang, G. Zhou, K. Lin, Q. Zhang, H. Di, Application of latent heat thermal energy
809 storage in buildings: State-of-the-art and outlook, *Build. Environ.* 42 (2007) 2197–

- 810 2209. doi:10.1016/j.buildenv.2006.07.023.
- 811 [37] A. Foucquier, S. Robert, F. Suard, L. Stéphan, A. Jay, State of the art in building
812 modelling and energy performances prediction: A review, *Renew. Sustain. Energy Rev.*
813 23 (2013) 272–288. doi:10.1016/j.rser.2013.03.004.
- 814 [38] M.G. Davies, Optimal RC networks for walls, *Appl. Math. Model.* 6 (1982) 403–404.
815 doi:10.1016/S0307-904X(82)80108-X.
- 816 [39] S. Goyal, P. Barooah, A method for model-reduction of non-linear thermal dynamics
817 of multi-zone buildings, *Energy Build.* 47 (2012) 332–340.
818 doi:10.1016/j.enbuild.2011.12.005.
- 819 [40] G. Fraisse, C. Viardot, O. Lafabrie, G. Achard, Development of a simplified and
820 accurate building model based on electrical analogy, *Energy Build.* 34 (2002) 1017–
821 1031. doi:10.1016/S0378-7788(02)00019-1.
- 822 [41] J.H. Kämpf, D. Robinson, A simplified thermal model to support analysis of urban
823 resource flows, *Energy Build.* 39 (2007) 445–453. doi:10.1016/j.enbuild.2006.09.002.
- 824 [42] H. Park, N. Martaj, M. Ruellan, R. Bennacer, E. Monmasson, Modeling of a building
825 system and its parameter identification, *J. Electr. Eng. Technol.* 8 (2013) 975–983.
826 doi:10.5370/JEET.2013.8.5.975.
- 827 [43] B. Bueno, L. Norford, G. Pigeon, R. Britter, A resistance-capacitance network model for
828 the analysis of the interactions between the energy performance of buildings and the
829 urban climate, *Build. Environ.* 54 (2012) 116–125. doi:10.1016/j.buildenv.2012.01.023.
- 830 [44] A. Laaouatni, N. Martaj, R. Bennacer, M. Elomari, M. El Ganaoui, Study of improving
831 the thermal response of a construction material containing a phase change material, *J.*
832 *Phys. Conf. Ser.* 745 (2016) 032131. doi:10.1088/1742-6596/745/3/032131.
- 833 [45] A. Laaouatni, N. Martaj, R. Bennacer, M. El Omari, M. El Ganaoui, Phase change
834 materials for improving the building thermal inertia, *Energy Procedia.* 139 (2017) 744–
835 749. doi:10.1016/j.egypro.2017.11.281.
- 836 [46] P. Lamberg, R. Lehtiniemi, A.-M. Henell, Numerical and experimental investigation of
837 melting and freezing processes in phase change material storage, *Int. J. Therm. Sci.* 43
838 (2004) 277–287. doi:10.1016/j.ijthermalsci.2003.07.001.
- 839 [47] N.S. Dhaidan, J.M. Khodadadi, T.A. Al-Hattab, S.M. Al-Mashat, Experimental and
840 numerical study of constrained melting of n-octadecane with CuO nanoparticle
841 dispersions in a horizontal cylindrical capsule subjected to a constant heat flux, *Int. J.*
842 *Heat Mass Transf.* 67 (2013) 523–534. doi:10.1016/j.ijheatmasstransfer.2013.08.001.
- 843 [48] S.N. AL-Saadi, Z. (John) Zhai, Modeling phase change materials embedded in building
844 enclosure: A review, *Renew. Sustain. Energy Rev.* 21 (2013) 659–673.
845 doi:10.1016/j.rser.2013.01.024.
- 846 [49] M. Ahmad, A. Bontemps, H. Sallée, D. Quenard, Thermal testing and numerical
847 simulation of a prototype cell using light wallboards coupling vacuum isolation panels

- 848 and phase change material, *Energy Build.* 38 (2006) 673–681.
849 doi:10.1016/j.enbuild.2005.11.002.
- 850 [50] W.H. McAdams, *Heat Transmission*, 3rd ed., McGraw-Hill, New York, 1954.
- 851 [51] F.P. Incropera, D.P. DeWitt, *Fundamentals of heat and mass transfer*, 3rd ed., Wiley,
852 New York, 1990.
- 853 [52] M.G. Davies, Optimal designs for star circuits for radiant exchange in a room, *Build.*
854 *Environ.* 18 (1983) 135–150. doi:10.1016/0360-1323(83)90006-9.
- 855 [53] E.L. Alisetti, S.K. Roy, Forced Convection Heat Transfer to Phase Change Material
856 Slurries in Circular Ducts, *J. Thermophys. Heat Transf.* 14 (2000) 115–118.
857 doi:10.2514/2.6499.
- 858 [54] V. Dermardiros, Y. Chen, A.K. Athienitis, Modelling of an active PCM thermal energy
859 storage for control applications, *Energy Procedia.* 78 (2015) 1690–1695.
860 doi:10.1016/j.egypro.2015.11.261.
- 861 [55] N. Stathopoulos, M. El Mankibi, R. Issoglio, P. Michel, F. Haghghat, Air-PCM heat
862 exchanger for peak load management: Experimental and simulation, *Sol. Energy.* 132
863 (2016) 453–466. doi:10.1016/j.solener.2016.03.030.
- 864 [56] M.H. Baghban, P.J. Hovde, A. Gustavsen, Numerical Simulation of a Building Envelope
865 with High Performance Materials, *COMSOL Conf. 2010 Paris.* (2010) 1–5.
866 https://www.comsol.se/paper/download/63393/baghban_paper.pdf (accessed
867 September 6, 2018).
- 868 [57] J. Kośny, *PCM-Enhanced Building Components*, Springer International Publishing,
869 2015. doi:10.1007/978-3-319-14286-9.
- 870 [58] F. Goia, G. Chaudhary, S. Fantucci, Modelling and experimental validation of an
871 algorithm for simulation of hysteresis effects in phase change materials for building
872 components, *Energy Build.* 174 (2018) 54–67. doi:10.1016/j.enbuild.2018.06.001.
- 873

874

	Density ρ (kg/m ³)	Thermal conductivity λ (W/(m K))	Specific heat capacity C_p (J/(kg K))
PCM			
T < 27.5 °C	850	0.28	2800
T > 27.5 °C	780	0.18	2500
concrete (at T=25 °C)	1000	0.9	1000
PVC	1400	0.16	1046

875

Table 1. Thermo-physical properties of the materials constituting the system.

876

		Relative error (average) (%)	Relative error (maximum) (%)
without ventilation	RC-model	1.32	2.61
	FEM	1.14	4.58
with ventilation	RC-model	1.37	3.38
	FEM	1.32	3.03

877

Table 2. Results of relative error between experimental and numerical data.

878

879

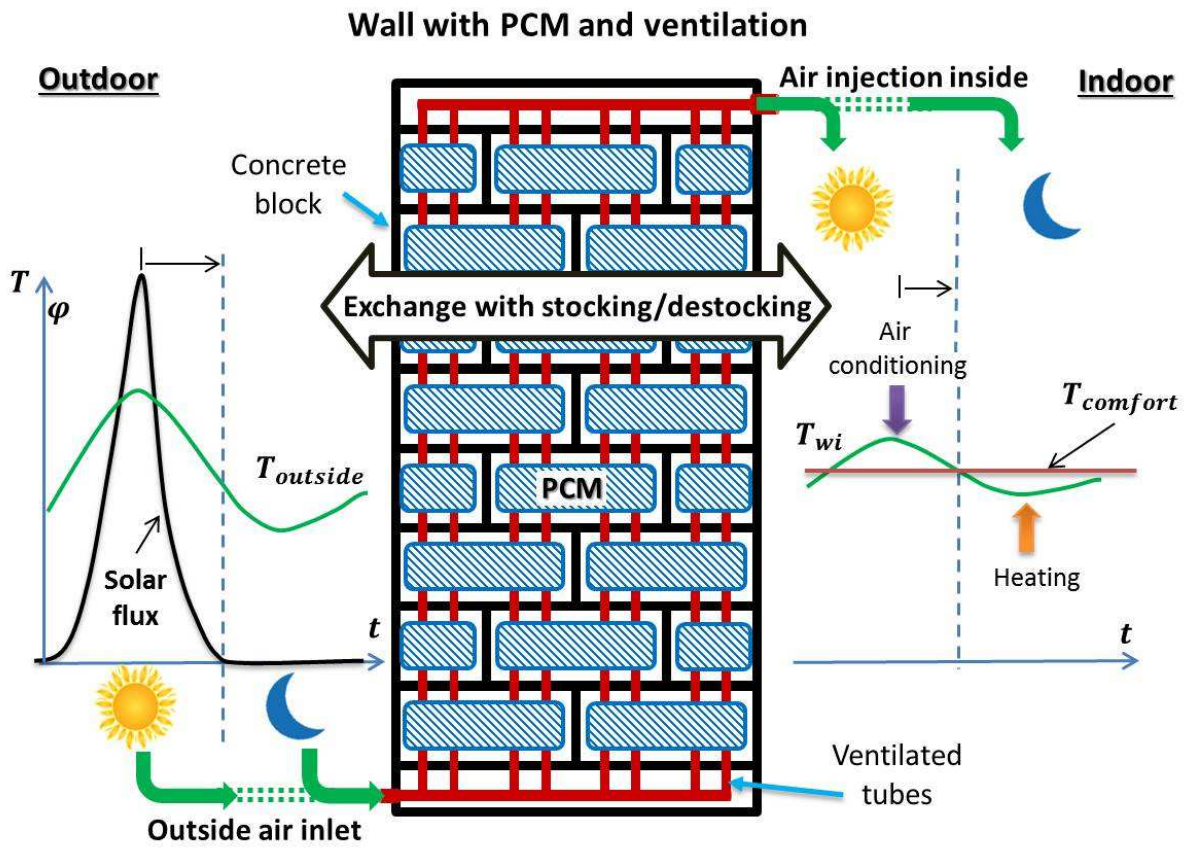

881

882

883

884

Fig. 1. Principle and utility of the tubes in the developed solution.

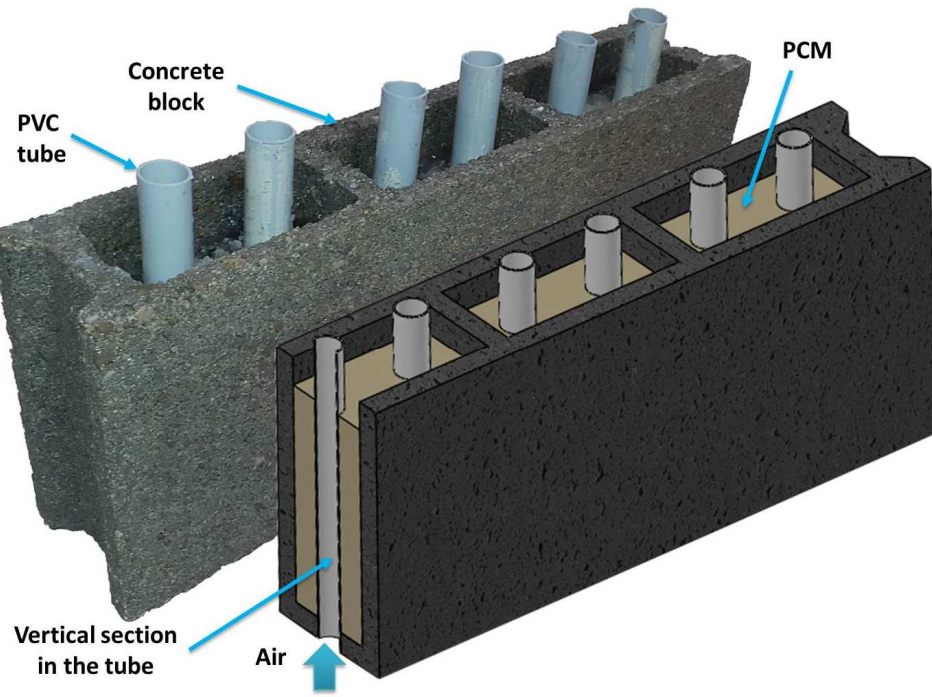

885

886

(a)

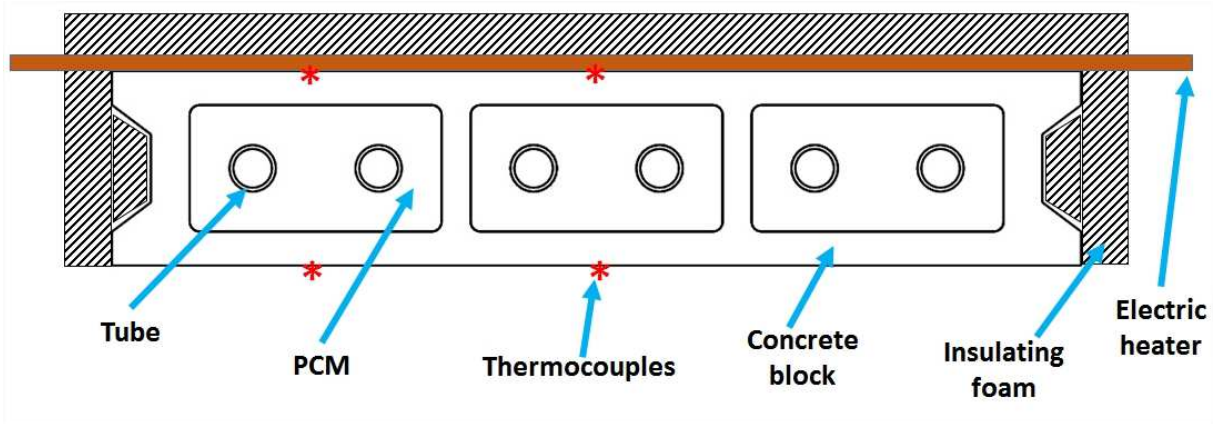

887

888

(b)

889 **Fig. 2.** Description of the developed system: **(a)** Schematic of the ventilated hollow concrete
 890 block integrating PCM **(b)** Schematic diagram of the experimental setup.

891

892

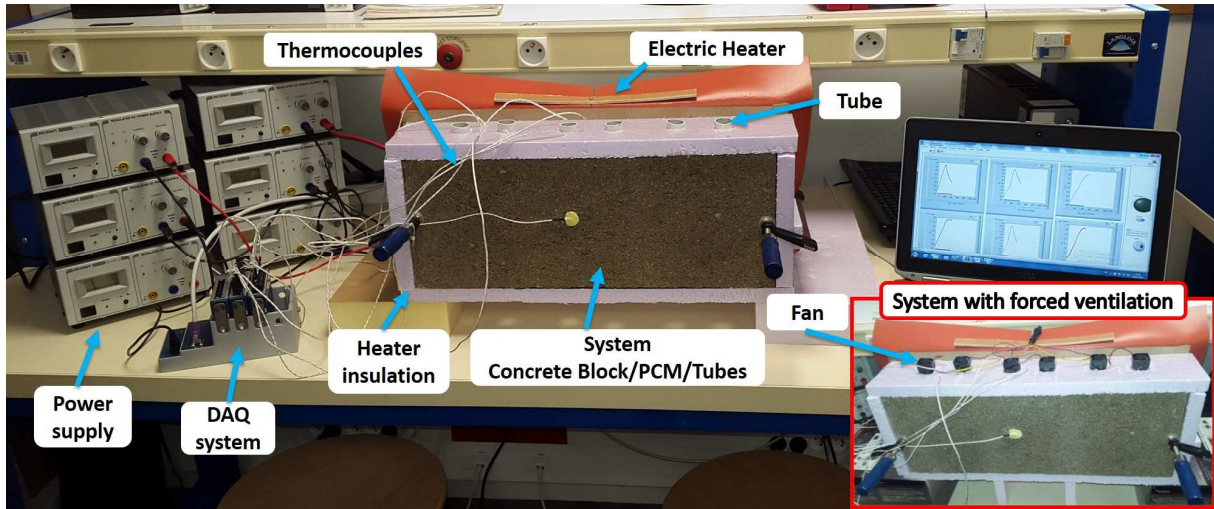

893
894
895

Fig. 3. Photography of the experimental bench.

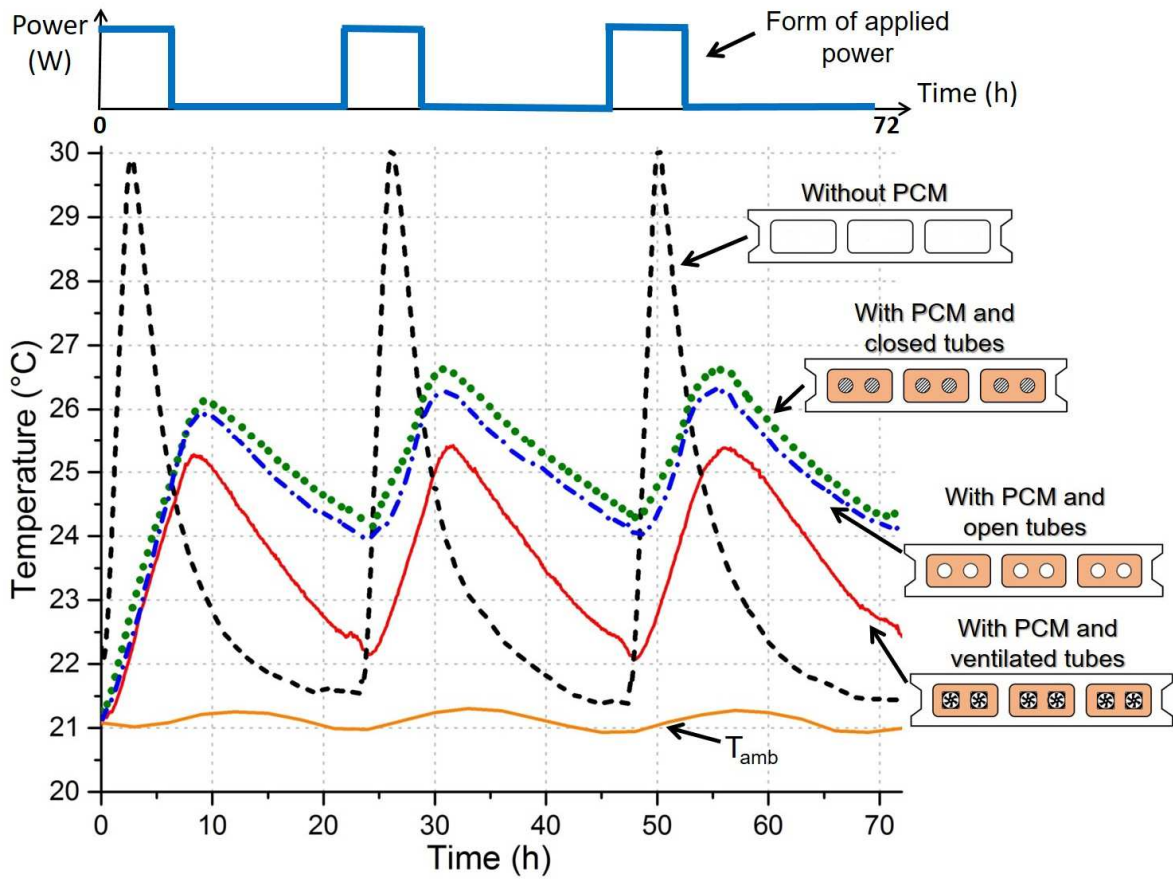

896
897
898

Fig. 4. Evolution of the temperature on the lateral surface of the concrete block for different configurations.

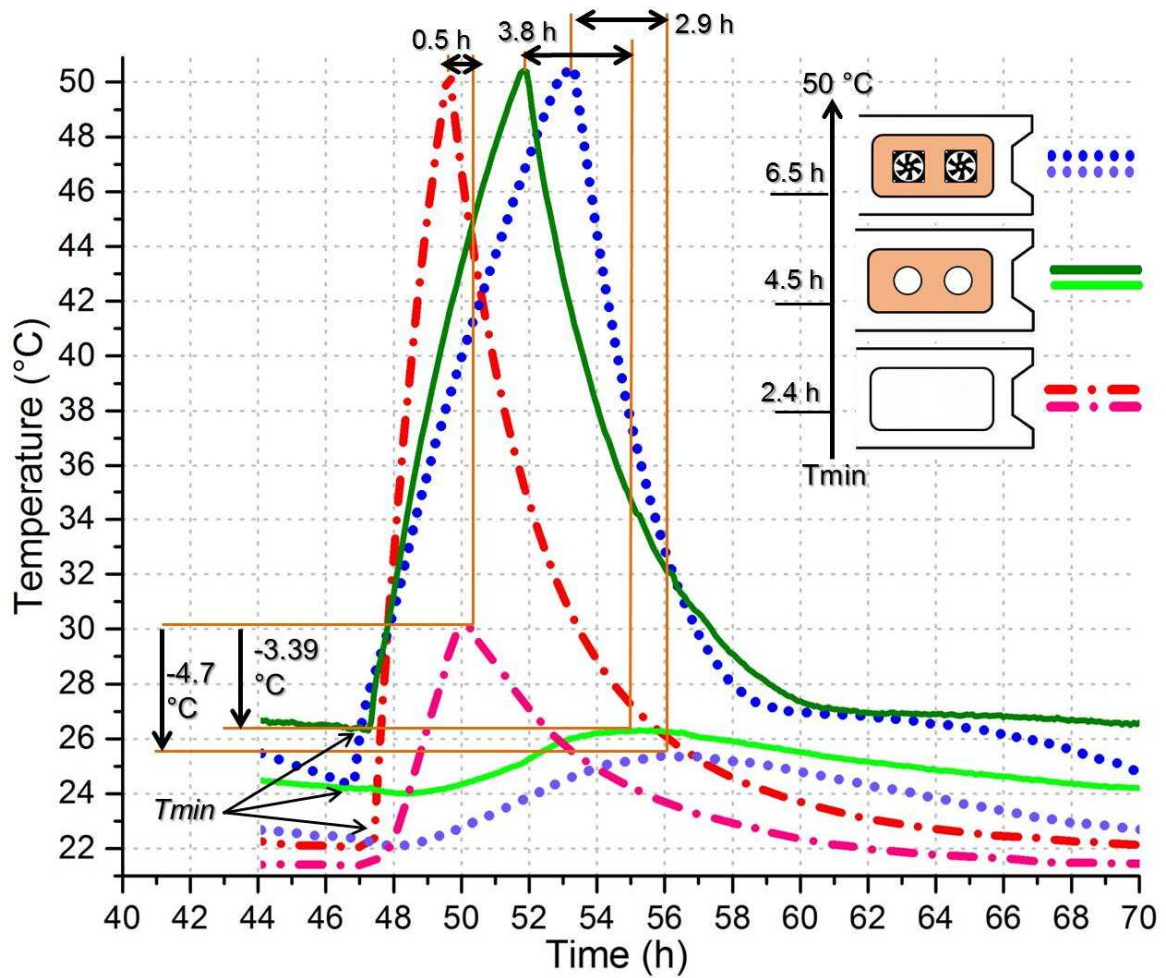

899

900

Fig. 5. Temperature analysis on the lateral surface of the concrete block for the different configurations starting from the third cycle.

901

902

903

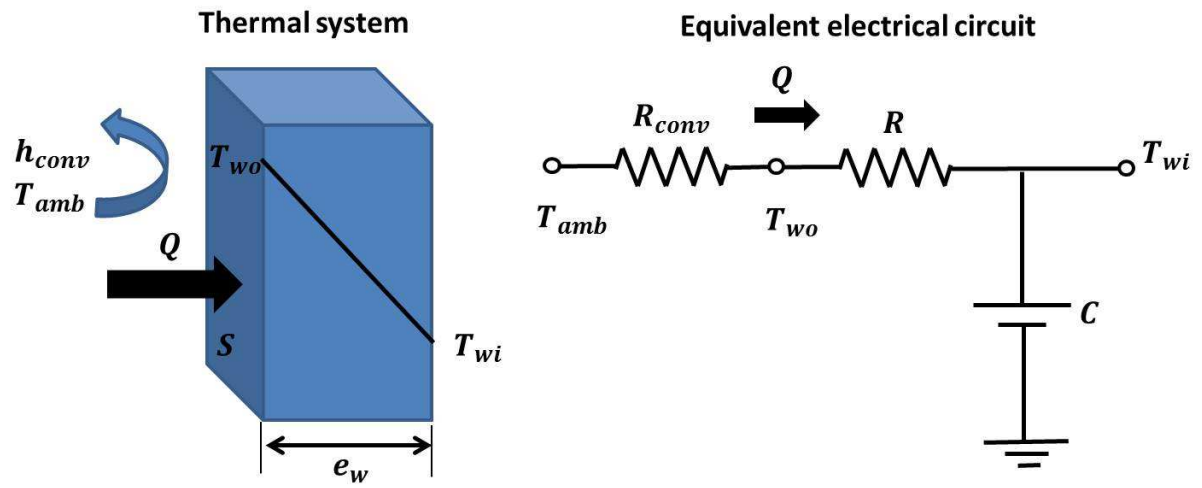

904
905

Fig. 6. Equivalent electrical circuit (1R1C) in the unsteady case.

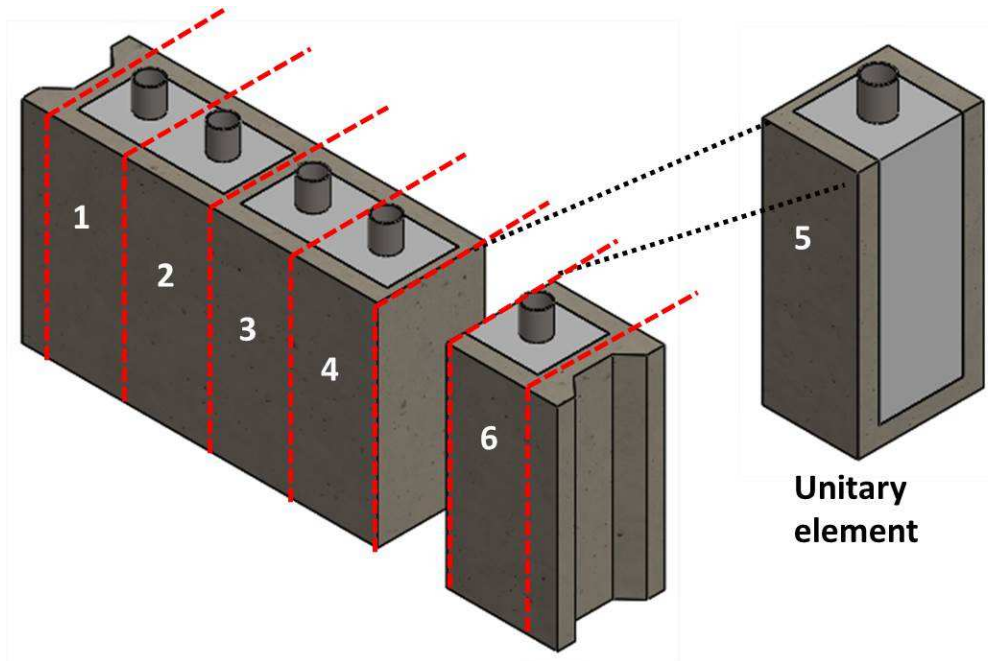

906
907

Fig. 7. System decomposition into unitary elements.

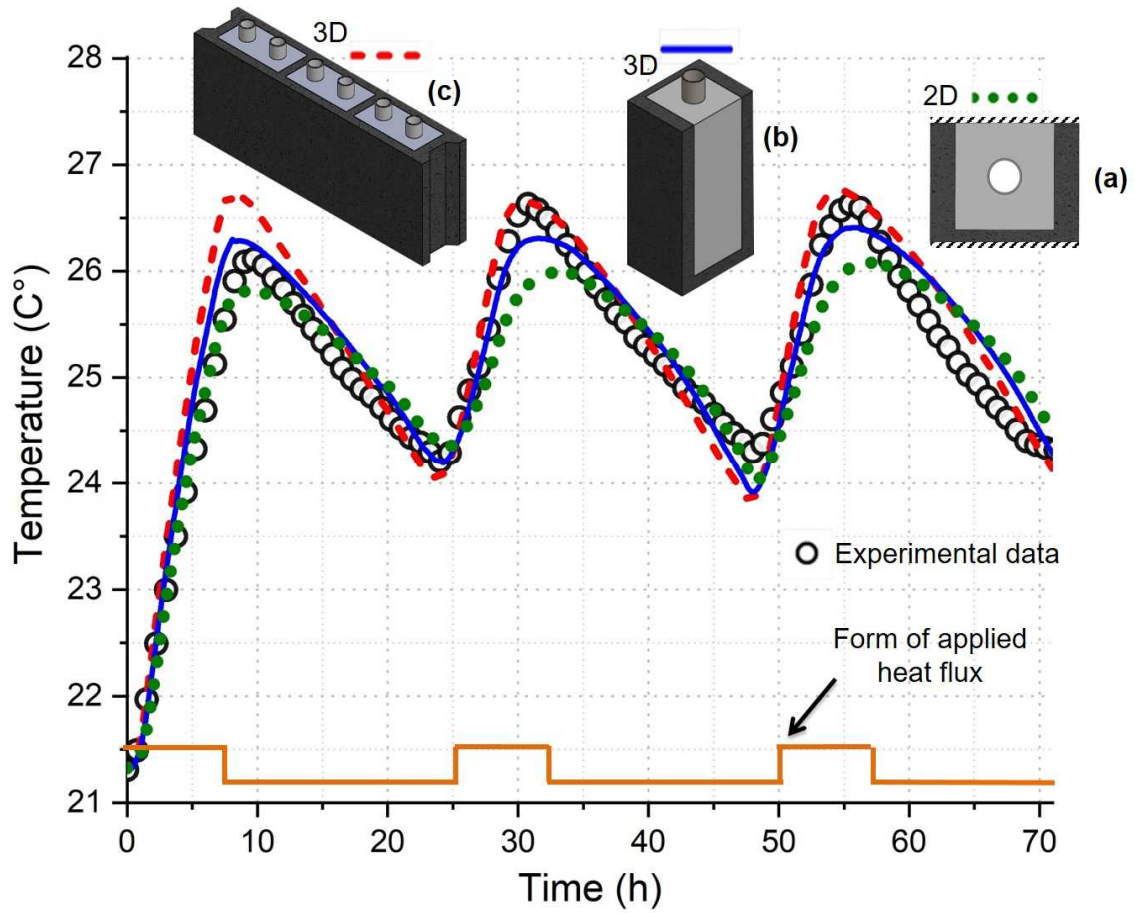

908

909

910

Fig. 8. Evolution of the average temperature on the inner surface for different geometric approaches in the case without ventilation.

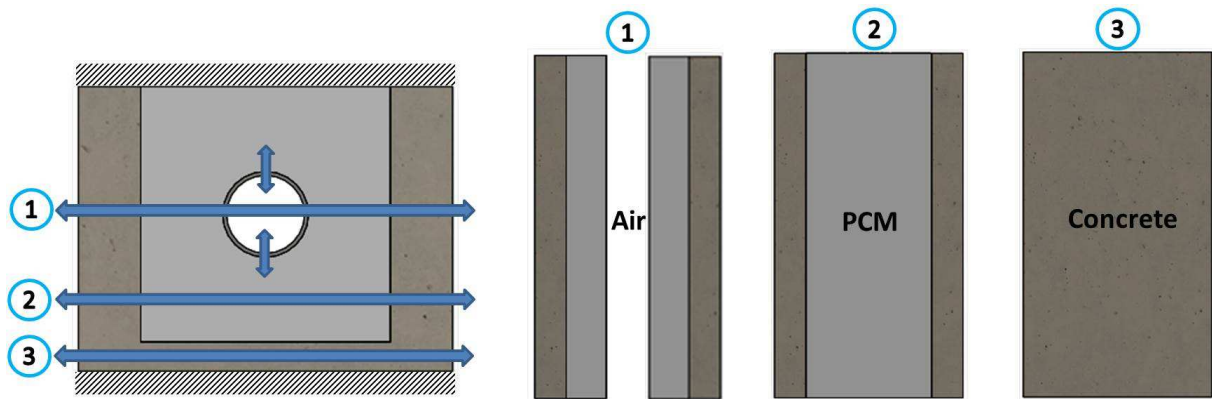

911

912

Fig. 9. The configuration of the revealing zone studied according to thermal exchanges.

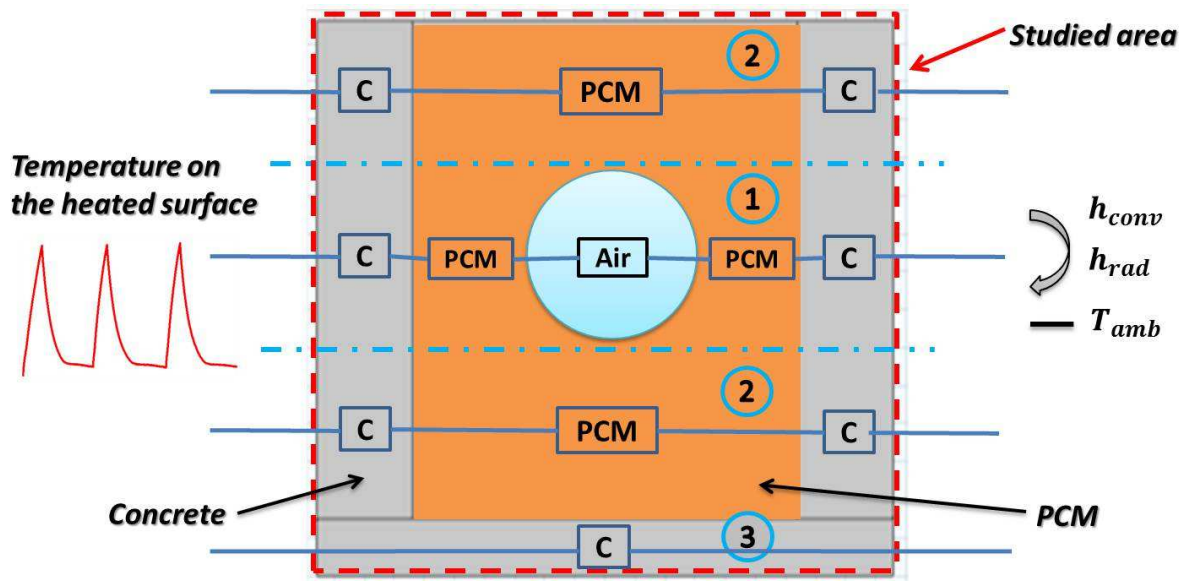

Fig. 10. Equivalent system diagram with the boundary conditions.

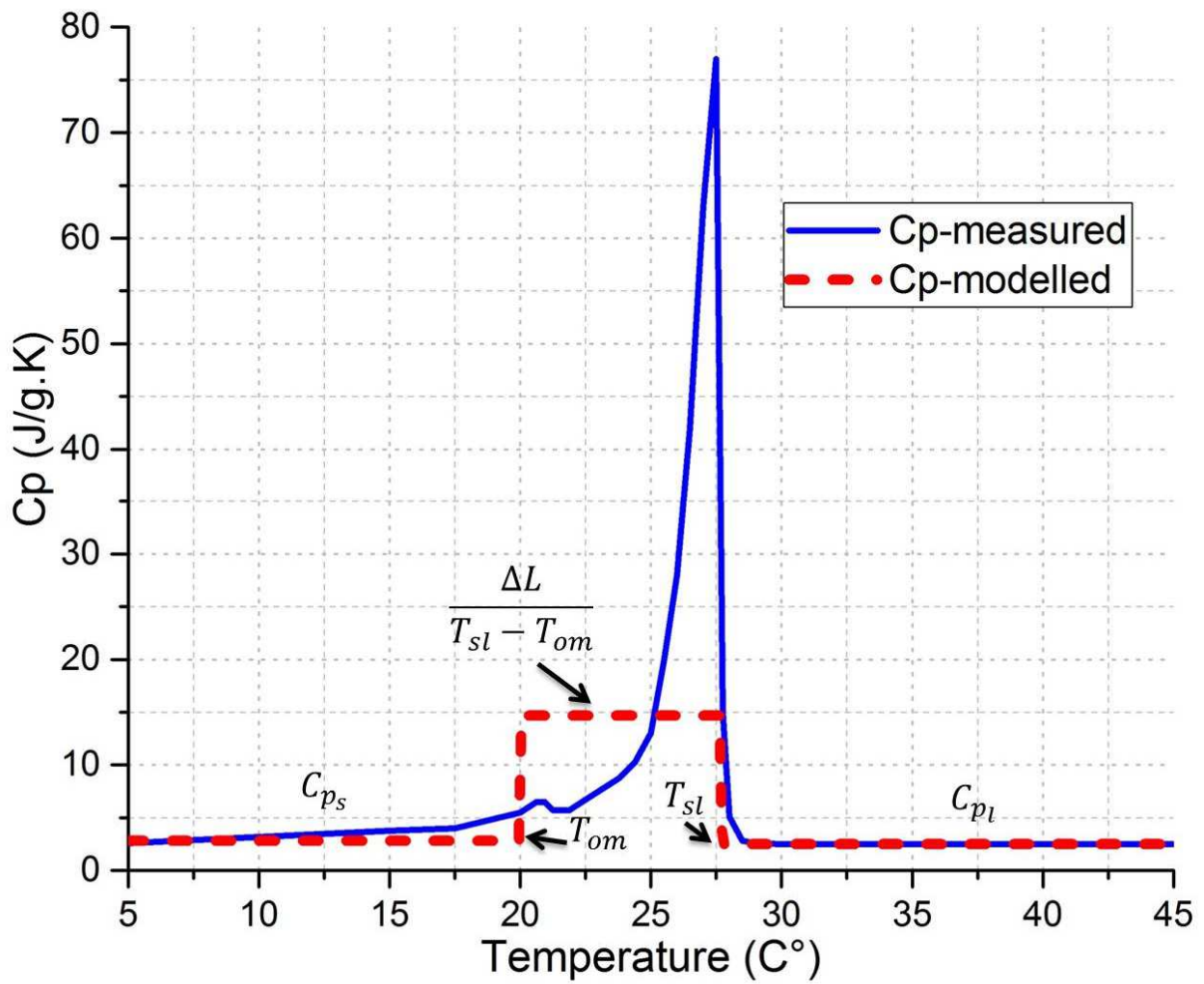
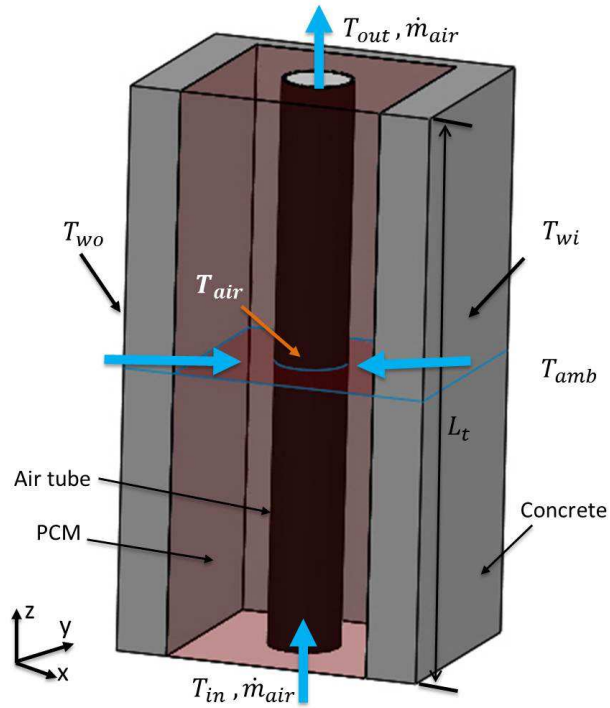
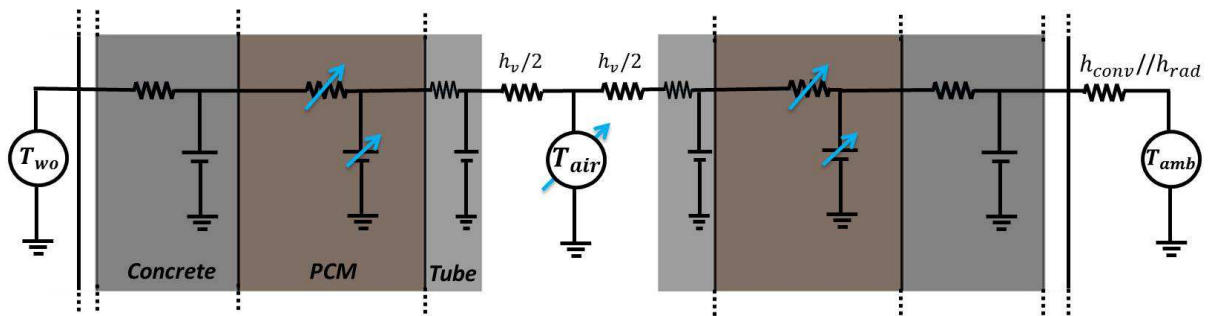

Fig.11. Adopted modelling of the specific capacity of the PCM.



(a)



(b)

Fig. 12. Airflow modelling through the tube: (a) The schematic diagram of modelling parameters, (b) Equivalent electrical diagram of the middle part containing the tube.

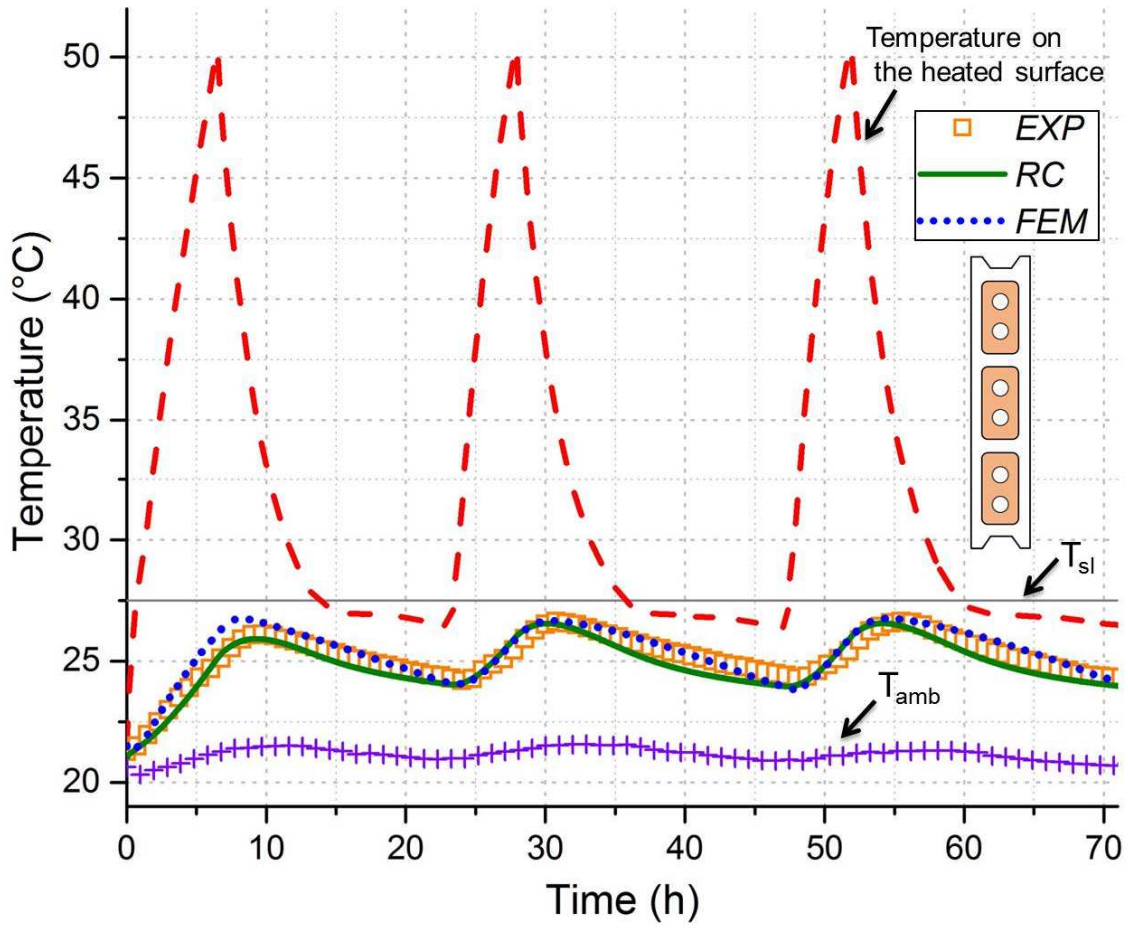

925

926

(a)

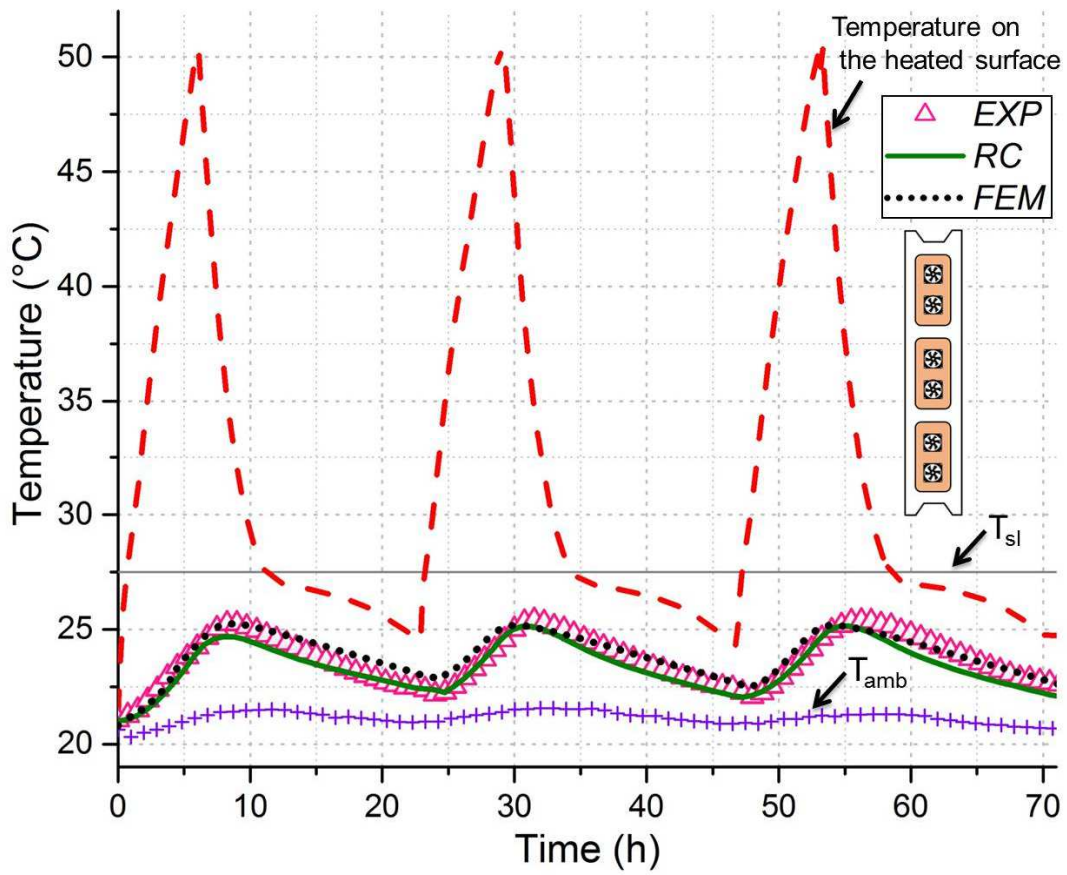

927

928

(b)

929

Fig. 13. Temperature of the surface of the concrete block, comparison of the experimental data with the two models RC and FEM: (a) without ventilation, (b) with ventilation.

930

931