



HAL
open science

Ambiances, Alloæsthesia: Senses, Inventions, Worlds

Damien Masson

► **To cite this version:**

Damien Masson. Ambiances, Alloæsthesia: Senses, Inventions, Worlds. Réseau International Ambiances, 375 p. (Vol. 1), 370 p. (Vol. 2), 2020, 978-2-9520948-7-0. hal-03136469

HAL Id: hal-03136469

<https://hal.science/hal-03136469v1>

Submitted on 23 Feb 2021

HAL is a multi-disciplinary open access archive for the deposit and dissemination of scientific research documents, whether they are published or not. The documents may come from teaching and research institutions in France or abroad, or from public or private research centers.

L'archive ouverte pluridisciplinaire **HAL**, est destinée au dépôt et à la diffusion de documents scientifiques de niveau recherche, publiés ou non, émanant des établissements d'enseignement et de recherche français ou étrangers, des laboratoires publics ou privés.

AMBIANCES, ALLOÆSTHESIA: SENSES, INVENTIONS, WORLDS.

Proceedings of the 4th International
Congress on Ambiances.

Edited by Damien Masson



ambiances
RESEAU INTERNATIONAL
INTERNATIONAL NETWORK

Edited by
Damien Masson

Publishing Secretary of Proceedings
Chloé Pestel

ISBN 978-2-9520948-7-0

© International Ambiances Network, 2020

Cover design © Les murs - Pauline Gorge

All rights reserved. No part of this publication may be reproduced in any form or by any means without the written permission of the authors and the publishers.

Ambiances, Alloæsthesia

Senses, Inventions, Worlds

**4th International Congress on Ambiances
December 2020, e-conference**

VOLUME 1

Edited by
Damien Masson

ambiances
| RÉSEAU INTERNATIONAL
INTERNATIONAL NETWORK |

The congress is organized by the International Ambiances Network, Scientific and Thematic Network of the French Ministry of Culture.

This initiative is funded by

- Bureau of Architectural, Urban and Landscape Research at the French Ministry of Culture;
- Grenoble School of Architecture;
- AAU “Ambiances, Architectures, Urbanités”, Joint research unit between CNRS (French National Centre for Scientific Research), Grenoble School of Architecture, Nantes School of Architecture, Centrale Nantes.

Partners

- CY Cergy Paris University;
- University of Thessaly.

Acknowledgements

These proceedings would not have been possible without a major collective mobilization. I would like to thank Prof. Marcos Novak for his warm welcome to UCSB and to the MAT team for proposing the organization of the Congress in person. I would also like to thank all the session organizers very warmly for their patient work in selecting the abstracts, critically reading the proposed chapters and for the confidence they have shown in the organization of this event, despite the uncertain times we have been going through in recent months. Thanks are also due to all the contributors to these proceedings. Without you, neither this book nor the congress would exist. Thank you in particular for having made the considerable effort to provide your chapters on time, for having taken the reviewers' comments into account in your texts, all this in a particularly complicated period due to lockdowns, overlapping calendars, holidays, new academic terms, and so on. Thank you also to all the members of the organizing committee and to the institutions that endorsed this event, for your support, both one-off and ongoing, without which the congress would not have been possible. In particular, a huge thank you to Nicolas Rémy, co-director of the International Ambiances Network, for your tireless work, your experience and your unfailing support for the success of this event and more widely for the management of the network. Finally, the proceedings in their present form would never have seen the light of day without the immense, conscientious, meticulous and creative work of Chloé Pestel, who ensured the exchanges with all the authors and session organizers, the spelling and typographical corrections of all the chapters and the realization of the present book. For all this and also for your constant good spirit, a huge thank you!

Damien Masson

Contents

Congress Organization	10
Foreword	13
Call for Papers	17
Contributors	22
SESSION 1	
ATMOSPHERE, ANTHROPOCENE, URBANITY, SENSITIVITY	57
Introduction	58
<i>Niels ALBERTSEN, Suzel BALEZ, Laurent DEVISME, Jean-Paul THIBAUD</i>	
A Multi-Dimensional Approach to Ambiance Change Triggers in an Urban Context	62
<i>Brieuc BISSON</i>	
Introduction to the Sound Installation “Beyond the Mortal Eye”	68
<i>Bethan KELLOUGH</i>	
Atmosphere and the anthropogenic Metapolis	74
<i>Niels ALBERTSEN</i>	
Sensibilities to Lifeworlds	80
<i>Jean-Paul THIBAUD</i>	
At the Edges of the Phenomenal	86
<i>Suzel BALEZ</i>	
Ambiances of Anthropocene on Thessaly Territory, Greece: A Critical Dictionary	92
<i>Yorgos TZIRTZILAKIS, Afroditi MARAGKOU, Yorgos RIMENIDIS</i>	
SESSION 2	
ARTIFICIAL LIGHTING AND DARKNESS IN THE ARCHITECTURAL AND URBAN PRACTICES	99
Introduction	100
<i>Nicolas HOUEL</i>	
Colored LED Lighting as a Primary Interior Spatial Condition	102
<i>Judy THEODORSON, Jennifer SCOTT</i>	
Design Practice as Fieldwork	108
<i>Rupert GRIFFITHS</i>	
Dark Design	114
<i>Nick DUNN</i>	
SESSION 3	
ATMOSPHERES + DESIGN	121
Introduction	122
<i>Shanti SUMARTOJO</i>	
Room for Transition by Aesthetic Empowerment?	126
<i>Birgitte FOLMANN</i>	
Light Affects	132
<i>Stine Louring NIELSEN</i>	

From Parlour to Studio	138
<i>Daniele LUGLI</i>	
Architectures, Technologies, and Stadiums Atmospheres	144
<i>Michel RASPAUD</i>	
Reusing Atmospheres	150
<i>Francesca LANZ</i>	
The Agency of Perception	156
<i>Izabela WIECZOREK</i>	
Culture of Creation	162
<i>Satyendra PAKHALÉ, Tiziana PROIETTI</i>	
Designing With Fog	168
<i>John SADAR, Gyungju CHYON</i>	
Choreographing Aesthetic Atmospheres	174
<i>Malte WAGENFELD</i>	

SESSION 4

BODY, CULTURE, IDENTITY 181

Introduction	182
<i>Cristina PALMESE, José Luis CARLES</i>	
Olympus VR	186
<i>Giorgos LOUKAKIS, Spiros PAPADOPOULOS, Vassilis BOURDAKIS</i>	
Physical Body Awareness and Virtual Embodiment	192
<i>Magdalini GRIGORIADOU, Eleni MANTZARI</i>	
Atelier Art et Re-Action (Area)	198
<i>Ricardo ATIENZA, Monica SAND, Robin MCGINLEY</i>	
Resonant Spaces	204
<i>Sofía BALBONTÍN, Mathias KLENNER</i>	
Phantasmagorias of the Post-Colonial Interiors	210
<i>João CUNHA</i>	

SESSION 5

DIGITAL ARCHITECTURE. ATMOSPHERES IN DESIGN AND NEW RESPONSIVE & SENSITIVE CONFIGURATIONS 217

Introduction	218
<i>Amal ABU DAYA, Philippe LIVENEAU</i>	
The Formation of the Technological Sensitivity	220
<i>Sebastien BOURBONNAIS</i>	
Architecture and its Double	226
<i>Yasmine ABBAS</i>	
Atmospheric Gestures of Architecture in Cinematic Aided Design Framework	232
<i>Amir SOLTANI</i>	
Ornamental Atmosphere & Digital De-lights	238
<i>Amal Abu DAYA¹, Noha Gamal SAID</i>	
Homunculus Nimbus	244
<i>Mark-David HOSALE</i>	

Extending sensibility for metabolic processes in immersive media environments <i>Desiree FOERSTER</i>	250
Development of the Integrated Approach on the impact of the Climate Adaptive Building Shells <i>Lilii ISYK</i>	256

SESSION 6

FROM A SENSITIVE ECOLOGY OF AMBIANCES/ATMOSPHERES TO A POLITICAL ECOLOGY	263
Introduction <i>Damien MASSON, Rachel THOMAS</i>	264
From a Sensitive Ecology to a Political Ecology of Ambiances <i>Damien MASSON, Rachel THOMAS</i>	268
Anxious Atmospheres of the Apologetic State <i>Seraphine APPEL</i>	274
Sensing Vulnerability, Listening to Urban Atmosphere. <i>Nicola DI CROCE</i>	280
Ambiences of Empathy and Fear <i>Sophia VYZOVITI, Thodoris CHALVATZOGLOU</i>	286
Preference Atmospheres in the 'Carioca Gaza Strip' <i>Alex Assunção LAMOUNIER, Vera Regina TÂNGARI</i>	292
Ambiance Is Key in Any Innovation Strategy <i>Diana SOEIRO</i>	298
Affects as Foam of the Balance of Power at a Time of Urban Aesthetisation? <i>Georges-Henry LAFFONT</i>	304
Politicising the Atmospheres of Urban Environmental Changes <i>Lucilla BARCHETTA</i>	310

SESSION 7

INFINITE ATMOSPHERES? ETHICAL DIMENSIONS OF AND FOR THE DESIGN OF PUBLIC SPACES	317
Introduction <i>Théa MANOLA, Evangelia PAXINO</i>	318
Infinite Atmospheres <i>Evangelia PAXINO</i>	320
Atmospheres of Rejection <i>Ole B. JENSEN</i>	326
Entangled Ambiance <i>Marília CHAVES</i>	332
Displacement: Architectural Collage <i>Jennifer A. E. SHIELDS</i>	338
Happy Atmospheres <i>Nicolas REMY, Evangelia PAXINO</i>	344

SESSION 8	
INHABITING INSECURITY. PRACTICES AND REPRESENTATIONS	351
Introduction	352
<i>Alia BEN AYED, Olfa MEZIOU</i>	
MAG	354
<i>Isabel BARBAS</i>	
Fear of the Unknown in Urban Atmospheres	360
<i>Farzaneh SEMATI, Hamidreza GHAHREMANPOURI</i>	
Ambiences and Safety?	366
<i>Ari KOIVUMÄKI</i>	
INDEX OF AUTHORS, VOLUME 1	373

Congress Organization

Damien Masson

Organizing Committee

Françoise Acquier (AAU), David Argoud (AAU), Suzel Balez (AAU), Stéphane Di Chiaro (AAU), Yiorgos Kalaouzis (UTH), Marcos Novak (MAT, UCSB), Chloe Pestel (CYU), Sophie Provost (AAU), Nicolas Remy (UTH), Daniel Siret (AAU), Rachel Thomas (AAU), Nicolas Tixier (AAU), Jean-Paul Thibaud (AAU).

Scientific Committee

Peter ADEY, Royal Holloway University of London, UK

Pascal AMPHOUX, AAU Laboratory, Cresson, France

Niels ALBERTSEN Aarhus School of Architecture, Denmark

Amal ABU DAYA, AAU Laboratory, Cresson, France

Suzel BALEZ, AAU Laboratory, Cresson, France

Olivier BALAY, AAU Laboratory, Cresson, France

Alia BEN AYED, ENAU (National School of Architecture and Urbanism), ERA Laboratory, Tunisia

Emeline BAILLY, CSTB, France

Vassilis BOURDAKIS, University of Thessaly at Volos, Greece

Jose-Luis CARLES, Universidad Autonoma de Madrid, Spain

Budhaditya CHATTOPADHYAY, Center for Arts and Humanities, American University of Beirut, Lebanon

Grégoire CHELKOFF, AAU Laboratory, Cresson, France

Edith CHEZEL, Pacte Laboratory, Université Grenoble Alpes, France

Laurent DEVISME, AAU Laboratory, Crenau, France

Cristiane Rose DUARTE, Universidade Federal do Rio de Janeiro - UFRJ, Brasil

Nick DUNN, Institute for the Contemporary Arts, University of Lancaster, UK

Tonino GRIFFERO, Università Tor Vergata, Italy

Nicolas HOUEL, AAU Laboratory, Crenau, France

David HOWES, Center for Sensory Studies, Concordia University, Canada

Andrea JELIC, Aalborg University, Denmark

Sylvie LAROCHE, AAU Laboratory, Cresson, France

Thomas LEDUC, AAU Laboratory, Crenau, France

Laurent LESCOP, AAU Laboratory, Crenau, France

Philippe LIVENEAU, AAU Laboratory, Cresson, France

Théa MANOLA, AAU Laboratory, Cresson, France

Damien MASSON, CY Cergy Paris University, France

Olfa MEZIOU, ENAU (National School of Architecture and Urbanism), ERA Laboratory, Tunisia

Marcos NOVAK, Media Arts and Technology, University of California, Santa Barbara, USA

Cristina PALMESE, Paisajesensorial Office-Lab

Spiros PAPADOPOULOS, University of Thessaly at Volos, Greece

Giorgos PAPKONSTANTINOOU, University of Thessaly at Volos, Greece

Evangelia PAXINOOU, AAU Laboratory, Greece

Ethel PINHEIRO, Universidade Federal do Rio de Janeiro - UFRJ, Brasil

Nicolas REMY, University of Thessaly at Volos, Greece

Ignacio REQUENA, AAU Laboratory, Crenau, France

Myriam SERVIERES, AAU Laboratory, Crenau, France

Paul SIMPSON, University of Plymouth, UK

Daniel SIRET, AAU Laboratory, Crenau, France

Aleksandar STANIČIĆ, TU Delft, Netherlands

Shanti SUMARTOJO, Monash University, Australia

Jean-Paul THIBAUD, AAU Laboratory, Cresson, France

Rachel THOMAS, AAU Laboratory, Cresson, France

Vincent TOURRE, AAU Laboratory, Crenau, France

Nicolas TIXIER, AAU Laboratory, Cresson, France

Aris TSANGRASSOULIS, University of Thessaly at Volos, Greece

Martin WELTON, Queen Mary University of London, UK

Izabella WIECZOREK, University of Reading, UK

Penelope WOODS, Queen Mary University of London, UK

Foreword

Ambiances, Alloæsthesia: Senses, Inventions, Worlds is the title of the 4th International Congress on Ambiances, organized by the International Ambiances Network. This is a thematic scientific network supported by the French Ministry of Culture, the *Ambiances, Architectures, Urbanités* research unit and the Grenoble School of Architecture. Its role is to federate and promote work relating to ambiances, to the sensory design of architectural and urban spaces and to the understanding of the ontologies, forms and powers of the affective intensities of atmospheres. It takes into account the sensory field in the ways of thinking and designing the spaces that are produced, experienced, practiced and represented. This approach to the built environment involves the sound, light, olfactory, thermal, tactile, kinesthetic and other dimensions of the world. It also involves the cultural, social and political dimensions of the situated bodily experience. The International Ambiances Network advocates multi-sensorial and multidisciplinary approaches. It is aimed at researchers, academics, professionals, artists and students from various horizons and covers the field of research as well as design activities, teaching practices and artistic actions. At the time we write these words, the network brings together nearly 1,080 individual members (whose distribution on the surface of the planet can be seen on the map below), spread over more than sixty countries. It also has some thirty teams (research, educational, professional groups) associated with it. Each year, this network contributes to the organization (scientific, financial and logistical) of at least one international thematic conference, several scientific seminars and educational workshops.

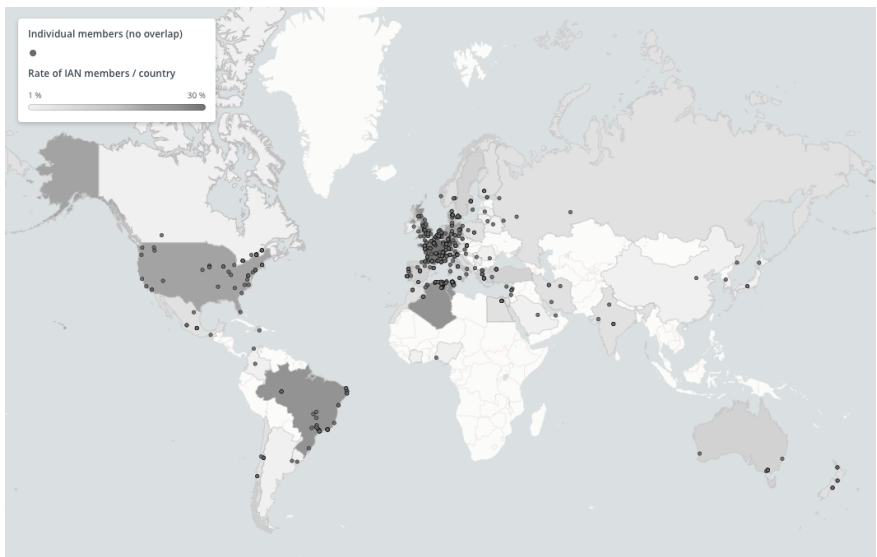

Members of the International Ambiances Network (October 2020). Basemap: Carto.

In line with previous editions (2008, Grenoble; 2012, Montreal; 2016, Volos), this 4th edition of the international congress aims to promote the widest possible range of research work, educational interventions, artistic experiments and design or conception operations, in and for which ambiances play a key role. They are present there

as much as an object of research, design intention and method of access to the sensitive world. As a place for meeting, exchange, transmission and innovation, the Congresses on ambiances are intended to welcome and bring people together. Different from themed seminars, they enable the expression of the great diversity of theoretical, methodological and practical approaches, as well as the meeting, within the same conference, of scientists from fields as diverse as anthropology, architecture, computer science, cultural studies, design, engineering, geography, history, musicology, psychology, sociology, urban studies, etc. They are also constructive moments, allowing the dissemination of the most innovative works, proposed by researchers at the forefront of their field, as well as the reception of embryonic research, still in the process of being set up, but whose novelty of questioning often goes hand in hand with thematic, methodological and theoretical renewal. Finally, these congresses are moments of sharing of the sensory, of testing the body, of experiencing situations and, historically, the emphasis is placed on sensory and aesthetic experiences, both individual and collective (through artistic installations, workshops, concerts, visits).

Since the Montreal congress (2012), the steering committee of the International Ambiances Network has chosen to co-organize its congresses. The challenge is to share the organization of this event with the network members and to enrich the network by learning and sharing the practices, cultures and territories that these encounters provoke. These partnerships also aim to identify and develop new research themes, by bringing together teams whose field of action and proximity to ambiances open up new perspectives for this field. In this sense, the meeting with Marcos Novak, professor at the University of California, Santa Barbara and the Media, Arts, Technology (MAT) team, to which he belongs, provided a particularly rich perspective for the network.

This team brings together academics and artists working on the intersections between media, media arts and technology. Based in particular on experimentation on scale 1, such as the production of immersive (visual, sound) devices, their work questions the modes of production of new environments and new aesthetic forms, as well as the renewal of forms of spatial narration, data representation, sound design and modes of sonification and so on. In doing so, they debate the philosophical, social and mediatic implications of the fabrication of worlds. They also question the production of new sensitive worlds and the evolution of sensitivities, particularly in situations of technological mediation of the latter. Without stating it explicitly nor thematizing it in these terms, these devices, like the reflections they underlie, participate in producing ambiances, questioning the forms of sensorial experience in situations of technological mediation of sensory environments and finally testing the limits of technological devices in the face of the complexity of the anthropic sensorium.

The partnership with the MAT and the fruitful exchanges with Marcos Novak have led to the development of hypotheses for the framework of this 4th Congress, whose title, *Ambiances, Alloaesthesia*, aims to express the questions arising from the crossroads of research concerns in our fields. These questions can be summed up in the following double questioning:

- What other forms of sensitivity are emerging at a time in history marked by major environmental, political and technological upheavals?
- In what way does this renewal of sensibilities question the problematization of the notion of ambiance, and how can the field of ambiances apprehend these upheavals?

The Covid-19 global pandemic provides, sadly, a perfect illustration of these upheavals. It has been widely noted that this health crisis is, at its core, a reflection of the environmental crisis we are going through, and it causes multiple shocks - economic, social and political. It is also provoking disturbances in sensibilities and affects. All over the world, humans are experiencing the consequences of the need to sanitize life in society. Through the almost global generalization, at different times, of confinements, we have collectively participated and assisted in the emptying of the streets of cities and the countryside, in the regulation of modes of occupation and possible uses within the public space, in the disinfection of bodies and common spaces, in the silencing of urban and extra-urban sound environments, in the proliferation of audio-visual mediations of verbal exchanges, in the fading of tactile contacts, in the relearning of breathing, in the disappearance of faces etc. This historical moment is also a moment to take time and step back. It allows a critical examination of our lifestyles and the choices made by our societies.

This crisis has not been without effect on the organization of the Congress, which had to be quickly rearranged into three phases: publication of the proceedings, an online conference, and then - once the health crisis is over - a time of exchange in co-presence. The situation, unprecedented in many respects, implied a resumption of the steering of the congress by the International Ambiances Network for the production of the proceedings and the organization of the e-conference. At the present time, we still do not know what form the third phase will take, but we sincerely hope that it will provide the opportunity for the expected meeting with our colleagues from the University of California in Santa Barbara, and that we can collectively benefit not only from rich intellectual exchanges, but also from bodily, sensitive and aesthetic experiences.

The present proceedings and the upcoming e-conference are evidence of a renewal of the forms of organization of the Congress. While the general framework of the call for papers follows the above-mentioned intentions, a set of thematic calls for sessions, proposed by specialists from different countries and disciplinary backgrounds, has been added to the thematic axes of the general call. Behind such an organization method lies the challenge of opening up themes and questions, but also of diversifying research approaches and practices. The initial call proposed 25 thematic sessions and 3 research axes, which were then reorganized once the abstracts were received, so as to ensure maximum coherence within each session. The present book, which reflects the organization of the e-conference, arranges 103 chapters spread into 16 sessions, representing a wide range of contemporary concerns relating to ambiances. Through this book and the forthcoming conference, we hope that the congress will fulfil its mission: to be a place of exchange, where each of the contributions can generate an echo, but also make a ripple effect by giving rise to extensions, be they ideas, experiences and collaborations.

Damien Masson & Nicolas Remy
Co-Directors of the International Ambiances Network
September 2020

Ambiances, Alloæsthesia:

Senses, Inventions, Worlds

**4th international Congress on Ambiances
2-4 December 2020, e-conference**

Call for Papers
Damien Masson, Marcos Novak
With the organizing committee of the Congress

The 4th Congress of the International Ambiances Network aims to bring together a large community of academics, practitioners, artists and students working on, with or through ambiances. The mobilization of this triptic underlines the diversity of the forms of mobilization of the notion of atmosphere, which questions the sensitive world in terms of: research subject, category of analysis, and dispositif for action.

The topic of ambiances and atmospheres has carried out its deployment for more than four decades, and the questions associated with it are constantly being renewed. The vitality of ambiance/atmosphere as an object of study and as a field of research and practice is particularly sensitive through the continuous development of the International Ambiances Network, with more than a thousand members spread over all continents, and belonging to disciplines ranging from Architecture and Urban Design, to Social Sciences, Engineering Sciences, Arts and Humanities (see the website: <https://www.ambiances.net>).

After the Congresses of Grenoble (*Creating an Atmosphere*, 2008), Montreal (*Ambiances in Action*, 2012) and Volos (*Ambiances, Tomorrow: The Future of Ambiances*, 2016), this 4th Congress entitled “*Ambiances, Alloæsthesia: Senses, Inventions, Worlds*” focuses on the renewal of the forms of feeling in a world that is undergoing major changes. Composed by “allo” which stands for “other, of another kind”, using the term *alloæsthesia* aim to characterize: other senses, or senses of another kind, and suggests to be comprehensive of the emergence of potential new kinds of senses and sensibilities¹. This Congress aims to consider how the contemporary environmental, social, technological, political and ethical changes are likely to affect the sensitive worlds, their ambiances, and the ways of experiencing them.

How do the aforementioned changes question the research on ambiances and atmospheres, at epistemological, theoretical, methodological and practical levels? These questions are divided into the following three thematic areas:

- **1/ New sensitizations.** Present times, on a global scale, are marked by the multiplication of environmental (such as global warming, massive damage to

1. Using this term beyond its medical definition (i.e. *alæsthesia* means the sensation of a stimulus in one limb that is referred to the contralateral limb) aims to open it to a wider understanding, in order to question its potential articulation to the notion of ambiances.

the biosphere, etc.), political and social (as evidenced by the rise of conflicts, the emergence of the “society of vigilance”, etc.) emergencies, which are carried in a massive and almost unavoidable way by the media and social networks. Together, they contribute to redefining the landscapes of ordinary life. In what way does this situation, characterized by various threats and associated anxieties, renew our modes of attention, presence and action in the world? How do these attentions redefine the *sensitivities*, in that they refer to *what I am sensitive to* (what touches me) and *how we become sensitive to* (how am I affected)? How do our sensitive experiences reconfigure themselves in these new worlds of uncertainty? How do they crystallize into new ways of designing and managing spaces? And how do these modes circulate and are communicated?

- **2/ Human and non-human sensitivities.** How can we question the pressures resulting from the evolution of the sensory environment on the non-human sensorium in a world more than ever affected by human actions, which can be designated in certain circumstances as Anthropocene? In what ways can ecological and ethological approaches, through observations on non-human living beings, question potential evolutions of human sensitivity? How, by extension, do they renew the ways of understanding ambiances? Conversely, how are the concept of atmosphere, and how the scientific approaches, on the one hand on architectural and urban ambiances, and on affective atmospheres on the other hand, likely to put into question disciplines that challenge the senses, the action, the interactions between body and environment, grounded within different epistemologies, and other methodological traditions?
- **3/ Artificial and extended sensibility.** In what ways does the development of technologies allowing the consultation and representation (notably through visualization, auralization, etc.) of a very large amount of information contribute to alter (notably through restriction or extension) our sensitive potential within a datascape? How do the spaces measured, captured, reproduced by machines, sensors and algorithms create new worlds, and new sensory universes for humans? How do physiological alterations (may these be temporary, such as the wearing of augmented reality devices, or durable, such as certain biotechnologies), and prostheses (whether these prostheses are located within the body, or are new holds and affordances provided by spaces) define new sensitive worlds? How do these environments overflow into our daily environments? What resources do works of fiction and anticipation provide to think about these changes? What resources or limitations do these new sensory worlds provide for action?

Beyond this general framework and these three themes, the Congress of the International Ambiances Network aims to be representative of the thematic and disciplinary diversity, of the most contemporary researches on Ambiances and Atmospheres. Themed sessions, panels and workshops (see session gallery at the end of this call, as well as on the website of the conference), as well as installations and posters, performances and aesthetic experiences, will make this meeting a key moment for exchanges, the dissemination of knowledge, and the federation of an international community of research, pedagogy and practice on ambiances and affective atmospheres.

CONTRIBUTORS

Contributors

Yasmine ABBAS

is a French architect working at the architecture and design faculty at The Pennsylvania State University. She received a SMArchS from MIT (2001) and a Doctor of Design from Harvard University (2006) for her work investigating neo-nomads. Her research explores mobility, digital culture, and augmented place-making, with current focus on architecting atmospheres, and the computational design of ambiances. She is co-founder of the Agboglobloshie Makerspace Platform (AMP), an open architecture project that has been exhibited at the 2017 Seoul Biennale for Architecture and Urbanism, South Korea, the 2018 Afropixel Festival #6, Dakar, Senegal and the 2018 “Digital Imaginaries: Africas in Production” exhibition at ZKM, Center for Art and Media in Karlsruhe, Germany. AMP has been awarded the 2020 Le Monde Urban Innovation Award for Citizen Engagement.

Amal ABU DAYA

is an architect and has worked on projects ranging from public facility buildings and housing to interior design for over 10 years in France before opening her own practice which she co-managed for 2 years. She is a lecturer at the Grenoble National School of Architecture in the master cycle “Architecture, Ambiance and Digital Culture”, in the Digital Research by Design Lab where she has been teaching since 2012. Amal is currently working on a Ph.D. on ‘The architectural prototype in the digital age’ at the Cresson laboratory, UMR CNRS “Architecture and Urban Atmospheres”. Her teaching and research focus on the digital transition of the architectural discipline through the notions of tectonics and atmosphere, especially around the themes of ornamentation, materiality, as well as the renewed processes of architectural design, questioning the role and status of architectural prototypes in the digital age.

Niels ALBERTSEN

Professor emeritus, MSc (political science), Aarhus School of Architecture, Denmark. Since 1975 research and teaching at this institution into urban and social theory, architectural and design theory, the sociology of the architectural profession, the sociology and philosophy of art. President of the Nordic Association for Architectural research (1998-2000), Head of Department (Landscape and Urbanism) (2003-2011), co-director Centre for Strategic Urban Research (2004-2015) (www.byforskning.ku.dk). Publications on atmosphere since 1996. See <https://adk.elsevierpure.com/da/persons/niels-albertsen>

Nuria ALVAREZ COLL

is an architect graduated at the “Escola Tècnica Superior d’Arquitectura de Barcelona.” With the desire to seek other artistic expressions, she studies for two years physical theatre (Jacques Lecoq’s method) in Barcelona. She discovers contemporary earthen architecture in Chile with the architect Marcelo Cortés. Astonished by raw earth’s expressive potential, she makes the connection between architecture and theatre cocreating the theater company Colectivo Terrón where she’s artistic co-director nowadays. Motivated to go deeper into earth construction, she integrates until 2012

the post-master “Earth architecture” in CRATERre laboratory in Grenoble School of Architecture (ENSAG). After that, she works in “atelier matières à construire” (amàco), an educational resources center that aims to upgrade the qualities of natural materials (such as sand, clay, water, fibers...) in building arts. Here she starts her interest in sensory experiences with raw matter and decides to develop a Ph.D. research to converge all her experiences.

Katarina ANDJELKOVIC

with a Ph.D., M.Arch.Eng., is a theorist, practicing architect, researcher and a painter. She served as a Visiting Professor, Chair of Creative Architecture, at the University of Oklahoma U.S.A., Institute of Form Theory and History in Oslo, Institute of Urbanism and Landscape in Oslo, University of Belgrade, and guest-lectured at TU Delft, AHO Oslo and ITU - Istanbul Technical University. She lectures internationally at conferences in more than 23 countries in Europe, UK, North America and Canada. Katarina has published her research widely in international journals (Web of Science) and won numerous awards for her architecture design and urban design competitions. She is a full author of the Preliminary Architectural Design, a national project supported by the government of Serbia. She won the Belgrade Chamber of Commerce Award for Best Master Thesis defended at Universities in Serbia in all disciplines.

Seraphine APPEL

is a doctoral candidate at Pompeu Fabra University in Barcelona, Spain. Her work relates philosophy of aesthetic atmosphere to decolonial theory and explores how colonial projects and attitudes shape oppressive ambiances through physical and narrative manipulations of space and time. Her childhood was spent in Canada and Asia and her formation in philosophy and art took place in North America and Europe. A Canadian of European parents, her perspective is that of a settler and her philosophical project is a deconstruction of settler colonial ideologies, rooted in the investigation of an aesthetic topology of settler spaces and temporal understandings

Ichraf AROUA

is a Ph.D. student in architecture. He is affiliated with the Research Team on Ambiances (ERA) from the National School of Architecture (ENAU), Tunisia. His interests are focused on the altered perception in the urban and architectural space and the complexity of ambiances.

Ricardo ATIENZA

is a researcher, Sound Artist, Ph.D. Architect. Senior lecturer in Sound Art at Konstfack University of Arts, Crafts and Design, Stockholm. Atienza focuses his work on the situated experience of place, on the multiple embodied, social, sensorial and sensible interactions established with and within our daily environments. Sound, as a qualified experience of place becomes here a main explorative tool and material for approaching the complexity of our everyday spaces and situations. The resulting research processes adopt interdisciplinary methods and transversal public forms such as sonic-spatial installations, in-situ interventions in the public space, electroacoustic and radiophonic compositions or sound design pieces.

Nathalie AUDAS

conducts her research on the sensitive relationships of individuals to their living spaces and thus questions the scope of “affects” in order to (re)-question the ambiances and give a new reading of the urban project. Her reflections are oriented towards qualitative methodologies in their propensity to reach the affects.

Karan AUGUST

is an independent scholar and City Planner in the San Francisco Bay Area. Since 2007 she has published in the fields of philosophy, architecture, and led design studios throughout Europe, the UK, Japan, New Zealand, and the States. Her formal training includes the study of philosophy at UC Berkeley and architecture at TU Delft. She is on the editorial board of *Footprint*, Delft Architecture Theory Journal.

Emeline BAILLY

is a Ph.D. and a researcher in Urbanism at Centre Scientifique et Technique du Bâtiment (CSTB). She currently works on sustainable and sensible urban research projects. She's developing a specific focus on the concept of urban landscapes, public spaces and quality of urban life. She is in charge of urban research programs on an international scale (Urban edge/Genève, Think Nature/EU, FACT (Paris & New York), Ecodistrict/Paris,..), and she regularly teaches in urban planning institutes and schools of architecture. Her last publications are : Biodiversité urbaines, pour une ville vivante, with Dorothee Marchand and Alain Maugard, edition PC, Oser la ville sensible, Cosmografia edition and, with Dorothee Marchand , Penser la qualité, vers une ville sensible et résiliente, Mardaga edition.

Sofía BALBONTÍN

is an architect, sound artist and researcher, that explore the relations between sound, space and society through performance. Her work focuses on the aesthetic, political and social dimension of soundspace as a means to create alternative and subjective narratives, to resignify, subvert and deconstruct the memory of space and the architecture that sustains it. She works with Mathias KLENNER since 2014 focusing their practice on sound and space experimentations. They have created workshops, lectures, performances, videos and installations in the cross fields of architecture and sound art in Santiago, Valdivia, Valparaíso, Barcelona, Madrid, New Haven, Bilbao, Cosenza, New York, Chicago, Melbourne, Copenhagen and Berlin. They have obtained the Fondart, Becas Chile and Graham Foundation Grants.

Suzel BALEZ

is a Ph.D. architect, researcher at the Cresson Laboratory (UMR CNRS 1536). Currently a lecturer at the École Nationale Supérieure d'Architecture de Paris la Villette (ENSAPLV), in the department of Sciences and Techniques for Architecture, she is teaching mainly environmental strikes and ambiances perception and design, especially in public spaces. Since her Ph.D. thesis about smell effects in the built environment using smell walks in a commercial center (University of Nantes - France, 2001), she has carried out works on dynamic indoor and outdoor the perception of places, primarily through the sense of smell. She is currently working on her accreditation to supervise research on the olfactory experience of places.

Isabel BARBAS

is an architect, artist, and teacher, develops a multifaceted work in-between architecture, art and design. She has a Master in Art (FBAUL), a degree in Architecture (FAUTL) and she is finishing a Ph.D. in architecture (ULHT) about ephemeral, spatial and artistic interventions in the public space. Her work (mostly realized in Spain and Portugal) results from the crossing of various artistic strategies investigating issues related to Materiality, Atmosphere and Gravity. In public Space she inquires about participation, memory and citizenship. She has several works and installations in public space awarded in competitions and presented in conferences. Since 2010 she

has developed teaching positions at the School of Communication, Architecture, Arts and Information Technology of the University Lusófona in Lisbon and has conducted international and national workshops.

Lucilla BARCHETTA

is an anthropologist and urban geographer who recently completed her Ph.D. in Urban Studies at the Gran Sasso Science Institute (L'Aquila, Italy). Her work focuses on the intersection of political ecology with urban studies and is sustained by an in-depth ethnographic approach to the everyday life of cities. She is currently a research fellow at the Department of Cultures, Politics and Society of the University of Turin, where she participates in a broader project on the relationship between the construction of Italian whiteness and processes of urban environmental change. She is in the process of writing up a monograph based on her Ph.D. thesis *Riverbanks made by walking: understanding the temporalities of urban natures through atmospheres*, scheduled to be published by the Italian publishing house Agenzia X in 2020.

Fredric BELL

is an Adjunct Associate Professor at Columbia University where he also serves as Deputy Director of the Center for Buildings, Infrastructure and Public Space. He previously held positions at the NYC Department of Design and Construction, the city's public works agency, where he was Director of Design and Construction Excellence and Assistant Commissioner of Architecture and Engineering. Between stints at DDC, he served as Executive Director of the American Institute of Architects New York Chapter and its storefront Center for Architecture. At AIANY he initiated the FitCity and FitNation programs which gave shape to the importance of physical activity in everyday life, and which resulted in the adoption of Active Design Guidelines by the municipality. A frequent lecturer and critic, he is a Fellow of the American Institute of Architects and the Forum for Urban Design, and a Board Member of the Consortium for Sustainable Urbanization.

Alia BEN AYED

is currently Professor at ENAU (Tunis), member of the Ambiances Research Team (ERA). Her research program proposes to test the notion of porosity in the context of an operational thought turned towards a sensitive urban and architectural practice. Her teaching activities are an opportunity to develop, deepen and concretely implement the theoretical framework of research work and enrich analysis and design tools.

Karl BERTHELOT

is a Ph.D. student in sociology, political science and geography at EHESS (Géographie-Cités) since 2018, he works on the relationship between the working classes and ecology in eco-districts undergoing urban renovation. He questions the effects of ecogentrification in these popular spaces and is interested in alternative cultures of ecology rooted in living places and precarious living conditions. Using an ethnographic approach combining observations and in-depth semi-directive interviews, he seeks to confront the concept of political subjectivation with three eco-districts in Lyon, Marseille and Romainville. If these territories are marked by a referential of sustainable development and ecological transition, the analysis of the lifestyles of the working classes invites to go beyond the institutional and consensual discourses of ecology, far from being an object devoid of social tensions. In summer 2019, he takes part in an action research about the lived experience of climate change and ecological commitment by inhabitants of French cities. He details the results in his contribution in this book.

Briec BISSON

is a Ph.D. and Professeur Agrégé in Rennes 2 University in the west of France. He is part of the ESO - Espaces et Sociétés laboratory. His Ph.D., defended in 2019, focused on géophychological approaches related to urban.

Frédéric BLAISE

studied at ENSA Nantes, and worked as a mediator for the urban project of l'Île de Nantes. After working in many architecture design studios, he cofounded the architecture and urban planning studio ALT in 2018 after winning two urban design competitions and a call for project with the Pavillon de l'Arsenal.

Mohammed BOUBEZARI

is an architect Researcher at Lusófona University in Lisbon. Ph.D. in architecture, University of Nantes, architectural and urban ambiances option. DEA from CRESSON-Grenoble. Project Coordinator at Parque EXPO where he managed the study of the Algiers PDAU (Urban Planning Project and Strategy) from 2013 to 2017, with a vision for 20 years 2015-2035. Project Manager for the preparation of the Rehabilitation Operations of the Medina of Meknes in Morocco for the E.I.B-Luxembourg. Principal Investigator « EYE hEAR, Qualitative sound maps for visualization of the urban soundscapes », FCT-financing. Pos-doctoral Fellow The Qualitative Representation of the Sound Space: “Analysis and qualitative representation of the soundscape”-FCT Grant. Co-Responsible Investigator “Le médiat et l’immédiat, dans les espaces de sociabilité contemporains” PUCA-France financing. Has filed a patent for soundscape topography measuring tool. He is an international consultant on the question of the Plan of Algiers and its waterfront.

Sebastien BOURBONNAIS

is an associated researcher at Evcau and also working as a research consultant at Asynth. He received his MSc in philosophy at the University of Paris 8 and then his Ph.D. in 2014 from Laval University, Quebec, Canada, and the School of Architecture Paris-Malaquais, France. His research interests lie in the area of digital architecture and technical philosophy. He taught in several universities in France like Grenoble or Paris-La Villette and was a visiting professor at the School of Architecture Laval University. He actually works on an issue for the Encyclopaedia of Science on *Instruments of Architectural Design* as an editor and preparing an exhibition on the emergence of software dedicated to architectural design.

Vassilis BOURDAKIS

is an architect and is Professor of Architectural Design and Spatial Representational Techniques at the Department of Architecture (UTH). His research interests are interactive digital models, VR and intelligent environments

José Luis CARLES

is a Ph.D. in Ecology and Composer. Full Professor at the Interfacultative Department of Music. Facultad de Filosofía y Letras. Universidad Autónoma de Madrid. Responsible for different national and international research projects and deployed different media to communicate project activities, such as scientific publications, international conferences, sound art and audiovisual productions or through radio programs (www.rtve.es/alacarta/audios/la-casa-del-sonido/). The projects are based on “in-situ” urban explorations and methodologies working on specific urban sites. The aim of these projects are the development and implementation of new methodologies by

integrating scientific and artistic activities related to sensorial, ecological and social aspects of perception. *Last Research Projects* (Principal Researcher: Jose Luis Carles). Space temporal Implications Musical Creation, Ref,: Har2011-23318 Funded By: Ministry of Science and Innovation Spain January 2012-December 2015. Execution Center: Interfaculty Department of Music (Faculty of Arts. UAM). Soundscape as immaterial Heritage. New methodological confluences. Institute of Heritage of Spain. Culture Ministry.

Raquel CASTRO

's work draws upon the relationship between sound, environment and urbanism. She presents her work in multiple formats including soundscape research, documentary filmmaking and curation. She is the founder and director of Lisboa Soa Sound Art Festival and the International Symposium Invisible Places.

Thodoris CHALVATZOGLOU

is an architect and post-graduate student in MSc "Research in Architecture: Design-Space-Culture" at the National Technical University of Athens. He has worked in architecture offices in Greece, the Netherlands and also as a researcher at the University of Thessaly. He frequently takes part in workshops and his work has been published in academic conferences.

Marília CHAVES

is an architect and Urban Designer from UFPE. Member of research group LASC - PROARQ/UFRJ. Main interests in research and project of leisure public spaces, user experience design, social housing, and ecological urbanism/architecture. Developed master thesis about micropolitics in daily usage of the space. Organized and coordinated one axis on the congress "Ressensitizing Cities - Urban ambiances and senses." Professional experience in housing and interior design, historical researches, analysis of built and perceived environment and viability studies.

Gregoire CHELKOFF

is an architect and doctor in urban planning, professor at the Ecole Nationale Supérieure d'Architecture de Grenoble and researcher at CRESSON (UMR AAU) where he directs thesis. He participated in the creation of the CRESSON laboratory in 1979 and was its director for eight years between 2000 and 2012. His publications resulting from some twenty research projects deal with the analysis, experimentation and design of architectural and urban environments and aim to develop specific tools in this respect. He undertook the experimentation of "architectural sound prototypes", and is the scientific manager of the cartophonies.fr website and is co responsible of the research esquissons. In parallel with research on the auditory dimension and sound effects, he questions architecture and urbanities through ambiances in order to renew the stakes, methods and design tools involving sensitive and social interactions.

Edith CHEZEL

is an urban designer (MSc) and human geographer (Ph.D.). She is an associate lecturer and researcher at the school for architecture in Grenoble (France) within the Cresson laboratory (UMR AAU) and associate researcher at Grenoble Alpes University within the UMR Pacte laboratory. Her research focuses on the collective making of landscapes, in a context of energy and agro-ecological transitions. Her approach and practice are namely based on anthropological and photographic field-work, as well as pragmatist philosophy and environmental humanities.

Gyungju CHYON

teaches Spatial Design at Monash University in Melbourne. She was Assistant Professor of MFA Industrial Design and BFA Product Design at Parsons School of Design in New York from 2016 through 2019. She earned her Ph.D. at RMIT University in Melbourne, an MA in furniture and interior architecture at Aalto University in Helsinki, and a BA from Hongik University in Seoul. Chyon's work focuses on relationships between designed things, environments, and people through engaging natural phenomena and exploring materialities. Through her design studio Little Wonder, partnered with Dr. John Sadar, she interpolates between installations and product design. Little Wonder has collaborated with international companies such as Rosenthal (DEU), Interface (USA), Duravit (DEU), Emotis (FRA), and Lucifer Lighting (USA). Little Wonder's work has been globally exhibited in venues in Europe, North America, Asia and Australia.

Paul CRAENEN

is Research Professor at the Royal Conservatoire The Hague and guest professor at Leiden University, The Netherlands. He has been a music and sound art curator and is the composer of experimental works involving acoustic instruments, electronics and choreography. His book "Composing under the Skin. The music-making body at the composer's desk" (2014) was published by Leuven University Press.

Eric CREVELS

is a Brazilian Architect and Urban Planner and a Ph.D. Candidate at the Methods of Analysis and Imagination Chair of the Faculty of Architecture at Technische Universiteit Delft, as a doctoral partner of the TACK - Communities of Tacit Knowledge Innovative Training Network. He holds a Masters and a Bachelor's degree in Architecture and Urbanism from the Escola de Arquitetura of the Federal University of Minas Gerais. His research addresses architectural production by the perspective of labour, looking to bridge the boundaries between theory and practice, and exploring the potentiality of crafts in participatory practices and in the empowerment of individuals and communities.

João CUNHA

holds a Ph.D. in Cultural Studies from the Catholic University of Portugal, and a Degree in Architecture from the Faculty of Architecture of the University of Lisbon. His doctoral thesis, entitled "Representation, immersion and interiors: Cultures of Space in To the *Lighthouse* and *Buddenbrooks*", provides a comparative reading of two emblematic novels of the early 20th century, regarding their spatial, architectural and cultural backdrop. He is an Assistant Professor as well as the Students Manager at the Department of Architecture and Urban Planning in Universidade Lusófona de Humanidades e Tecnologias [ULHT], Lisbon, where he's been teaching in undergraduate and post-graduate level. He's a researcher at LEAU-ULHT and he's been a speaker at international conferences on representation, culture, architecture and space. He's also a writer of fiction, having been awarded the *Gulbenkian Foundation/ Branquinho da Fonseca Literary Prize*, to his novella *Amor de Miraflores*.

Federico DE MATTEIS

is an architect, is Associate Professor of Architectural Design at the University of L'Aquila, where he teaches Design studios at undergraduate and graduate level. He has earned a Master of Architecture summa cum laude (2000), Faculty of Architecture, "Sapienza" University of Rome, a Master of Science with honors (2003), School of Design, University of Pennsylvania, and a Ph.D. in Architecture (2004), "Sapienza" University of Rome. He has written articles and monographs on various issues related

to urban design and regeneration. His recent research work focuses on the affective dimension of urban and architectural space, a topic on which he has published books and articles. He has been visiting lecturer and critic at several international universities and taught as Visiting professor at the Lebanese American University of Beirut and as Associate Professor at Xi'an Jiatong - Liverpool University in Suzhou, China.

Alex DEFFNER

Dipl. Arch. NTUA (Athens), MSc Regional & Urban Planning Studies (London School of Economics and Political Science: LSE), Ph.D. Planning Studies (LSE). Since 2013 he is Professor of Urban and Leisure Planning at the Department of Planning and Regional Development (DPRD, where he has taught since 1997), and since 2003 he is Director of the Laboratory of Tourism Planning, Research and Policy. Also since 2014 he is the Director of the Postgraduate Program '*Tourism and Culture Planning and Development*'. Between 2016 and 2018 he was the Head of the DPRD. His publications in English focus on city marketing, cultural and time planning in cities, and tourism planning. He is a member of the Editorial Board of the Greek journal '*Aeihoros: Papers in Urban and Regional Planning and Development*', and the international journal, '*Transactions of the Association of European Schools of Planning*', Consulting Editor of the international journal '*Tourismos*'.

Sandrine DEPEAU

is a researcher in environmental psychology. Since her Ph.D., her research fields have been focused on child urban environment-relations studied from an ecological approach implemented through mixed methods. Her interests in early children's travel and exploratory behaviors, socialization and autonomy process are integrated into a multi-scale perspective.

Laurent DEVISME

is full professor of urban studies at Nantes school of architecture - France, researcher at AAU lab. Holds a Ph.D. (2001) and an accreditation to supervise research (ENS Lyon, France, 2014). His main research focus is on planning practices, urban theories and new metropolitan territories. Adopting an ethnographic approach of planning activities, his works concern urban professionals at work, foresight and consulting activities, urban sociology and urban studies theories.

Nicola DI CROCE

is an architect, musician, sound artist, and scholar, he has a Ph.D. in regional planning and public policies, and is currently postdoctoral research fellow at Università Iuav di Venezia. His research deals with the relationship between urban studies and sound studies. In particular, he is interested in collaborative and participatory approach to urban policy analysis and design through methodologies emerging within the framework of urban planning and sound art. Sound and listening play a key role in his academic and artistic practice, which aims to acknowledge critical issues affecting vulnerable areas, and concerning urban and cultural transformations such as depopulation, segregation, and expiration of local identities and intangible cultural heritages. nicoladicroce.cargo.site

Zakaria DJEBBARA

is a postdoctoral researcher at the Department of Architecture, Design, Media and Technology, Aalborg University, Denmark. He recently defended his doctoral project "Expecting space: an enactive and active inference to transitions." He is an educated

architect and published author with a focus on the integration between architecture, philosophy and cognitive neuroscience. His experimental approach is based on a Mobile Brain/Body Imaging technique, while the computational approach is based on the free energy principle.

Nick DUNN

is Professor of Urban Design and Executive Director of Imagination, the design research lab at Lancaster University, UK. He is Senior Fellow at the Institute for Social Futures, examining the insights that the arts, humanities and social sciences can bring to the ways we think, envision and analyse the futures of people, places, and planet. Nick and his team are currently exploring the impacts of nocturnal urban activity on humans and non-humans, including the establishment of the Dark Design Lab to investigate how we can better design with darkness. His expertise on cities, darkness, futures, and health have led to curated exhibitions and keynotes around the world. He is author of *Dark Matters: A Manifesto for the Nocturnal City* (Zero Books, 2016), co-author with Paul Cureton of *Future Cities: A Visual Guide* (Bloomsbury, 2020), and co-editor with Tim Edensor of *Rethinking Darkness: Cultures, Histories, Practices* (Routledge, 2020).

Guillaume DURANEL

is an architect, doctor in architecture and urban planning, LAVUE-LET, ENSA Paris La Villette, ALT. Doctor in architecture, Guillaume Duranel is an associate lecturer at ENSA Paris La Villette and member of the LAVUE-LET research team. Guillaume worked in architecture and urban planning studios in Japan and in France until he co-founded the architecture and urban planning studio ALT in 2018.

Maroua EN-NEJJARI

is an architect, she is a Ph.D. student in architecture and urban studies at CRENAU, the Nantes team of the Ambiances Architectures Urbanités laboratory (AAU-UMR CNRS 1563), at the Graduate School of Architecture of Nantes. She benefits, since 2018, from a doctoral contract from the Office of Architectural, Urban and Landscape Research of the Ministry of Culture.

Firat ERDİM

is an artist and designer based in Des Moines, Iowa. His work has been exhibited most recently at the Constance Gallery (IA, USA), Yellow Door Gallery (IA, USA), the Spartanburg Art Museum (SC, USA), and the Windor (Madrid, Spain). He was the co-founder and co-director of Flash Atölye, an experimental project space for art and architecture in Izmir, Turkey, from 2012 to 2013. Awards include the 2014 Founders Rome Prize in Architecture from the American Academy in Rome, and the 2016 Santo Foundation Award for Individual Artists. He has a Bachelor of Architecture Degree from the Cooper Union (2001), and a Master of Architecture Degree from the University of Virginia (2007). Erdim is an Assistant Professor of Architecture at Iowa State University.

Petros FLAMPOURIS

was born in Volos, Greece. He studied Applied Arts (BA) and Architecture (BArch, MSc, MArch) in Greece and Scotland. He maintains an architectural office in Greece which specialises in architectural design. His research interests are within the fields of architecture and acoustics. These include soundscape, atmospheres and architectural acoustics as well as new design technologies, digital media and prototyping. He is a member of the Technical Chamber of Greece (T.E.E), the Hellenic Institute of Acoustics (HEL.IN.A.) and the European Acoustics Association (E.A.A.).

Desiree FOERSTER

is currently a postdoctoral researcher at the Department for Cinema and Media Studies at the University of Chicago. She graduated from the Institute for Arts and Media, University of Potsdam, with her Ph.D.-thesis “Aesthetic Experience of Metabolic Processes.” Her thesis asks questions such as: in how far can an aesthetic framework inspired by pragmatism, process philosophy, and biological concepts such as metabolism provide new understandings to the human-environment relation? Before, she graduated an MA in Media Studies at the University of Düsseldorf and a BA in Philosophy and Comparative Literature at the Ruhr University Bochum. She also worked as a program assistant at the Haus of World Cultures (HKW) and as a free curator in Berlin. Her interdisciplinary research combines theory with aesthetic practice and prototyping.

Victor FRAIGNEAU

is an architect, Ph. D. student in Architecture at the GERPHAU laboratory, teacher at Paris-la-Villette Architecture School. He explores what the olfactory dimension can bring to the definition of architecture and landscape. His thesis, due in 2020, is about the contemporaneity of the olfactory sense in the built environment, its potential in the expression of the materiality and atmospheres of architecture, and its importance in environmental and political issues. He is a laureate of the sponsoring for Research in Architecture and Landscape launched by Caisse des Dépôts in 2017, laureate of the Research Grant of the JSPS Summer Program for which he was invited to the Department of Architecture, Kuma laboratory, University of Tokyo, Japan, and former Resident of the Cité Internationale des Arts de Paris in 2019 supported by the French Academy of Architecture.

Noha GAMAL SAID

is a Doctor in architecture and urban design. She is an Associate Professor at Ain Shams University, Department of Architecture and Urban Design in Cairo and an associate researcher at the CRESSON research center, the National School of Architecture in Grenoble where she defended her Ph.D. thesis in 2014. Her research tackles the notion of ambiances which calls for a sensory and sentient experience of space. She is particularly interested in the sonic dimension and the temporal aspect and evolving character of cities. Some of her projects deal with contemporary urban issues such as sustainability, densification, memory, and heritage investigated from the angle of daily sensory experiences of a city.

Giuseppe GAVAZZA

is a laureate in Pharmacy of the University of Turin, studied Composition, Direction, Piano, Musicology and Electronic Music and graduated from the Conservatory of Milan studying - among others - with Azio Corghi, Paolo Castaldi, Marco De Natale and Goffredo Haus. He has collaborated with international music research centres: LIM-Milano, CSC-Padova, Experimentalstudio SWF Freiburg, IRCAM-Paris. Since 1999 he is resident composer at the ACROE-ICA Polytechnique Grenoble where, in 2018, he obtained a Ph.D. on the subject: Physical Model Synthesis as Tool for Music Composition. Gavazza teaches Composition at the Conservatory of Music in Cuneo and is Permanent Researcher at AAU CRESSON, Grenoble. His compositions have successfully participated in international composition competitions (Bucchi-Rome, Ensemblia-Mönchengladbach, Briccialdi-Terni, Irino-Tokyo) are published (BMG, Edipan, Ricordi), played by reference interpreters, recorded on CDs (2EZM, Datum, Happy New Ears, DDT, Nuova Era, Folkestone Fringe, Ventunesimo Musicale, Da Vinci Records) and broadcast on international radio networks.

Marilena GEORGANTZI

is an architect (NTUA) and holds a Master degree in digital fabrication (IAAC) as well as in graphic design and interactive media (HOU). She has been selected for her curatorial proposals, interactive art projects and as a workshop instructor in prestigious festivals and exhibitions in Europe (ex. ADAF Athens 2020, Cyprus University, 2018, HAUTSCENE 2017, Copenhagen, ADAF Athens 2017, Hybrids, OCC Athens 2016, IMPAKT, Utrecht 2014, London Architecture Festival 2014, Dimitria Festival 2014 etc.). She has been teaching and organising workshops on e-textiles and digital fabrication focusing on the blend of analogue and digital creative tools. Marilena Georgantzi has worked in architecture firms in Greece and abroad. Currently, she works as a stage designer focusing on the concept of atmospheres and world building of synthetic storyworlds.

Hamidreza GHAREMANPOURI

completed his MA in architecture from Shahid Bahonar University of Kerman. During his studies, he focused on sensory design. His thesis was based on the richness of sensory perception and cognitive mapping in architecture. After graduation, he collaborated with several architectural firms in Iran, before co-establishing Goljaam Design Studio in 2018. Being passionate about the impact of the senses in the perception of manmade places, he has also been an independent researcher in the field of multisensory design and sensory perception.

Rupert GRIFFITHS

is a research associate at ImaginationLancaster, an open and exploratory design and architecture research lab. As a researcher and a creative practitioner, his research sits at the nexus between cultural geography, creative practice, and design. By considering the cultural imaginaries of waste and margins, it asks how the concepts of nature and culture and their interrelation are composed and deconstructed. He has a specific interest in spatial margins, such as urban wastelands, and temporal margins, such as the night. His current research considers three areas—the use of creative methods to record, interpret and describe changing light and sound in nocturnal urban environments; the collection and reimagining of environmental data over periods beyond everyday experience, from months to years, decades or centuries; and the use and value of art and design practices to both conduct and communicate fieldwork.

Magdalini GRIGORIADOU

is an architect and holds a Ph.D. on the concept of the imaginary, collective or personal, through the evolution of the notions of space, time and body. In her first postdoctoral research, (2016-2017) *Sparágmata: incoherent fragments of vulnerable bodies in a multidimensional city*, in Mexico City, she explored the experience of nostos/nostalgia and otherness within the contemporary conception of the fragmented body. She is currently a Post-Doctoral Research Associate at LECAD, where she is the PI of the *DISEMBODY* Project.

Marie HØJLUND

is an Assistant Professor in Sound Studies, Audio Design, Department of Communication and Culture, Aarhus University. Ph.D. in Audio Design, Cand.it. Dissertation about sound and noise in Danish Hospitals entitled “Overhearing - An Attuning Approach to Noise in Danish Hospitals” (2017). She is an active sound artist and composer and a part of the bands Kh Marie & Nephew. During her work she has been engaged in developing novel sound technologies for alternative listening situations, modifying existing electronic devices and designing sound environments and installations for

various public spaces and hospitals. Through her artistic and academic work, she has been organizing international academic conferences, acted as editor of journals and project manager for academic and artistic projects including the Aarhus 2017 European Capital of Culture project *The Overheard*.

Mark-David HOSALE

is a computational artist, composer, and Chair of *Computational Arts in the School of the Arts, Media, Performance, and Design*, at York University in Toronto, Canada. He has exhibited, given lectures and taught internationally, and is the co-editor of the anthology, *Worldmaking as Techné: Participatory Art, Music, and Architecture* (Riverside Press, 2018). His varied practice spans from performance (music and theatre) to public and gallery-based art. His research-creation activities focus on theoretical discourse, methodological development, and the production of works in the areas of ArtScience, Computational Art, and Interactive Architecture. His practice is focussed on the creation of eversive works that blur the divide between the virtual and the real as informed by the concept of *worldmaking*. *Worldmaking* provides an approach to challenging the World and how it could be through future-making by creating alternate realities as artworks that are simultaneously ontological propositions.

Nicolas HOUEL

is an architect and a urban lighting planner. He is currently a researcher in night-time urban studies at CRENAU, which belongs to the AAU Laboratory (UMR CNRS 1563, Nantes). Since 2014, he has been leading Skedanoz, a nocturnal cultural mediation project, and has accompanied public and private projects regarding the study of architectural, urban and landscape lighting. He also carries out experiments and evaluation projects in terms of public lighting (*Interactive Data Light*, 2016 - 2018). After assuming the position of teacher in studio and in digital representation tools (*ESMA Nantes*, 2014 - 2017), he is now involved in the Master's curriculum at the Graduate School of Architecture of Nantes, where he is in charge of classes on lighting culture. He has been working along with the city of Nantes since 2017, to help them with the implementation of their lighting masterplan, considered as a management and renovation tool for the lighting stock of the metropolis' 24 municipalities.

Faten HUSSEIN

is a Ph.D. student in architecture. He is affiliated with the Research Team on Ambiances (ERA) from the National School of Architecture (ENAU), Tunisia. His interests are focused on the altered perception in the urban and architectural space and the complexity of ambiances.

Rachel IAMPOLSKI

is a Ph.D. Candidate and tutor at the Centre for Urban Research at RMIT University in Melbourne, Australia. Her research is focused on the nexus between tangible and intangible cultural heritage, urban imaginaries, and socio-spatial culture (and cultural performance) in cities. She is particularly interested in the liminal, 'ordinary', reactive and at times transgressive elements of urban life and atmosphere. Rachel holds a Masters of Arts and Cultural Management from the University of Melbourne and works as a creative producer and placemaker.

Liliia ISYK

is a Ph.D. Student, and young researcher at CAIU, Lusofona University of Humanities and Technologies, Lisbon, Portugal. Was born in Ukraine, and got the Bachelor and

Specialist degree in Architecture, after got a scholarship for an Integrated Master Program in Architecture in the University of Lisbon inside the project - International fellowship in transdisciplinarity is supported by the Erasmus Mundus INFINITY programme of the European Union. After successful graduation, Liliia entered to the Lusofona University of Humanities and Technologies to do her Ph.D. under the supervision of Dra. Maria Rita Pais and Dr. Eloi J. F. Figueiredo. During her studies, she participated in the Project S.O.S. Waterfront Climate Change where they investigated the problem of the Waterfronts in Poland, Greece, and Lisbon. Focus of her studies is Intelligent and Adaptive Facade Systems on the Performance and Energy Efficiency of Buildings.

Andrea JELIĆ

is an architect and Assistant Professor at the Department of Architecture, Design and Media Technology, Aalborg University, Denmark. Her research focuses on exploring the nature of architectural experience from the integrated perspectives of architecture, embodied cognitive science, and phenomenology. She has published articles in this emerging interdisciplinary field in architectural and scientific journals, and guest lectured at international conferences and workshops in USA and Europe. Dr Jelić is Advisory Council member of the “Academy of Neuroscience for Architecture - ANFA” and faculty member in the master program “Neuroscience applied to architectural design” at IUAV University of Venice.

Ole B. JENSEN

is a professor of Urban Theory at the Department of Architecture, Design and Media Technology, Aalborg University (Denmark). Bachelor in political science, master in sociology, Ph.D. in planning and Dr. Techn in Mobilities. Deputy director and co-founder of the *Centre for Mobilities and Urban Studies (C-MUS)*. Author of *Staging Mobilities*, Routledge, 2013, and *Designing Mobilities*, 2014, Aalborg University Press, the Editor of the four-volume collection *Mobilities*, Routledge, 2015, and author (with Ditte Bendix Lannig) of *Mobilities Design. Urban Designs for Mobile Situations*, 2017, Routledge, co-editor of the *Routledge Handbook of Urban Mobilities*, 2020 (with Claus Lassen, Ida S.G. Larsen, Malene Freudendal-Pedersen and Vincent Kaufman). His main research interest is how urban spaces, infrastructural landscapes, and technologies work as habitats for contemporary urbanites. Working primarily with a pragmatic and situational perspective, he has contributed to the emerging research field of ‘mobilities design’.

Sena KARAHAN

is an architect and Ph.D. student at Mimar Sinan Fine Arts University, Urbanism program. She wrote her thesis titled *Social Reproduction of Space and Soundscapes* at Istanbul Bilgi University Cultural Studies Master Program. Before engaging with academia she worked as an architect at the architecture studio SMA, Selin Maner Architects, and later travelled from Argentina to Colombia for fourteen months to study sustainable design practices. Based on her experience, her interest in the relation of sound and space is centred on design thinking and affects her understanding of architectural and cultural space. Sena continues her research on urban soundscape and her professional practice as an architect and acoustic consultant.

Bethan KELLOUGH

is a sound artist from Scotland, currently based in Los Angeles. Her practice involves learning about the Earth through listening to and recording sound, engaging with the layers of a landscape that sounds reveal. Following on from her doctoral research into

spatial aesthetics in immersive sound-worlds, she is developing a body of work that focuses on the dynamism of Earth processes occurring across various timescales. She is an experienced field recordist with an ever-growing library of sounds from across the globe, and the sound-worlds she creates in the studio reflect upon her knowledge of and experience in the environments she records. She has produced internationally programmed installations and concert works, additional music for Terrence Malick's 2019 film *A Hidden Life*, as well as an EP released on *Touch*, which was listed in *Rolling Stone's* "20 Best Avant Albums of 2016."

Lilia KHELIFI

as a Ph.D. researcher with a doctoral contract in Geography in Sorbonne University, she works on the role of body practices in the social construction of individuals. How people interact with their surroundings, from a local to a global scale, is one of the lines of her research. Besides, the evolution of the environmental paradigm is to be questioned in remote areas of French academic research. That is why she is interested in surveying social groups that have been neglected by conventional research. Her current study object - surfing - leads to reconsider the boundaries between sport, game and culture. Local knowledge is also part of her research, in order to analyse its place among modern science in the social groups surveyed.

Mathias KLENNER

is an architect, sound artist and researcher, that explore the relations between sound, space and society through performance. His work focuses on the aesthetic, political and social dimension of soundspace as a means to create alternative and subjective narratives, to resignify, subvert and deconstruct the memory of space and the architecture that sustains it. He works with Sofía BALBONTÍN since 2014 focusing their practice on sound and space experimentations. They have created workshops, lectures, performances, videos and installations in the cross fields of architecture and sound art in Santiago, Valdivia, Valparaíso, Barcelona, Madrid, New Haven, Bilbao, Cosenza, New York, Chicago, Melbourne, Copenhagen and Berlin. They have obtained the Fondart, Becas Chile and Graham Foundation Grants.

Ari KOIVUMÄKI

is a Doctor of Arts from Aalto University. He is currently working as a principal lecturer of Media production in Tampere University of Applied Sciences, School of Media, Music and Art. His research focus is in soundscape studies and sound design as well as in cultural well-being. He is fond of making radio documentaries and radio plays after being a sound designer more than a decade in Finnish Broadcasting Company.

Stavros KOUSOULAS

is an Assistant Professor of Architecture Theory in the Faculty of Architecture of TU Delft. He has studied Architecture at the National Technical University of Athens and at TU Delft. He received his doctoral title cum laude from IUAV Venice participating in the Villard d' Honnecourt International Research Doctorate. He has published and lectured in Europe and abroad. He is a member of the editorial board of *Footprint Delft Architecture Theory Journal* since 2014.

Jordan LACEY

is a Research Fellow in the School of Design at RMIT University, Melbourne, Australia. He investigates the role of sound installations in transforming urban ambiances, to facilitate new ways of knowing and being with the world. Jordan is author of *Sonic*

Rupture: a practice-led approach to urban soundscape design and has created numerous sound art installations.

Georges-Henry LAFFONT

is a researcher in urban and heritage studies, member of the UMR 5600 EVS and LabEX “IMU” University of Lyon, he teaches cultural geography, urban design and urban planning at the ENSA of Saint Etienne. His work focuses on the capacity of the imaginary (ideologies, images, discourses, objects and devices) to the production of space to perform the actions of individuals, groups and society in urban (Saint-Etienne, Nantes, Lyon) or territorial areas (Auvergne Rhone Alpes, Val de Loire). More particularly he investigates the forms and processes of conflict and regulation, normalization and resistance at work in the urban and territorial dynamics through themes like: theory of the urban and architectural project ; images and imaginary of places; emotional dimension of the relationship to space; materiality of individual and collective memories in post-industrial contexts; risk, vulnerability and resilience of territories; urban and territorial marketing.

Alex Assunção LAMOUNIER

is an architect and urbanist; Master in Geography, Environment and Development; Ph.D. in Architecture and Urbanism. Professor of the School of Architecture and Urbanism of the Fluminense Federal University (EAU-UFF). Postdoctoral researcher in the Graduate Program in Architecture of the Federal University of Rio de Janeiro (PROARQ-UFRJ). Has developed continuous research on urban atmospheres and ordinary landscapes and, in recent years, has been dedicated to the concept of Preference Atmospheres related to everyday life. Currently, has studied Preference Atmospheres in peripheral urban areas of vulnerability, especially favelas. Member of the Open Spaces Systems in Rio de Janeiro Research Group (SEL/RJ-ProLUGAR). Sub-coordinator of the research Affective Mapping, developed by PROARQ-UFRJ in partnership with the Rio de Janeiro Municipality, which analyzes children’s perceptions and desires on their daily journey from home to school.

Francesca LANZ

is lecturer in Interior Architecture and Exhibition Design at the Department of Architecture and Urban Studies, Politecnico di Milano and Marie Skłodowska-Curie Fellow at the School of Arts and Cultures, Newcastle University. Her research interests broadly lie at the intersection between museum&heritage studies and architectural design, with a focus on the representation of unheard voices within and beyond the museum. In the past years, she has contributed to several research projects in the field including MeLa (EU-FP7, 2011-2015) on museums and migrations, TRACES (EU-H2020, 2016-2019) on contentious heritages, en/counter/points (HERA, 2019-2022) on public spaces and places and multicultural encounters and ReMIND (MSCA, 2019-2021) on the adaptive reuse of former asylums into museums. Recent publications include “The Adaptive Reuse of Neglected Buildings” in *Contested Spaces, Concerted Projects* (Lettera22, 2020), and “Museums and a Progressive Sense of Place” (with C. Whitehead) in *Museums and Communities*, (Cambridge Scholars Publishing, 2019).

Sylvie LAROCHE

She is a professional architect (orientation research), she holds a doctorate in architecture and is a lecturer for the CNU Section 24 (spatial planning) and 23 (geography). She is currently undertaking a post doctorate at the Scientific and Technical Centre for Building, and is an associated researcher at the Centre for research on sound space and urban environment, UMR CNRS 1963 “Ambiances Architectures Urbanités.” She

regularly teaches at the Graduate Schools of Architecture (of Grenoble and Nantes). Her research themes are centered on the sensory dimensions of the city, to question the transformations of urban spaces. This approach relies on original pluri-disciplinary methods, at the crossroads between architecture, social sciences and engineering.

Sana LAYEB

is an architect, Ph.D. in architecture, affiliated to the Research Team on Ambiances (ERA) from the National School of Architecture (ENAU), Tunisia. She is interested by the researches on the altered perception in the urban and architectural space and the complexity of soundscapes. Her works focus on the problematic of identifying uncomfortable and embarrassing situations in particular perceiving conditions, as for autistic children, through the capture of emotion through the conductance of the skin called electrodermal activity (EDA). She proposes spatial and ambient corrections and recommendations to improve the quality of life and well-being of this population.

Thomas LEDUC

is a Ph.D. in computer science from the University of Paris VI, graduated in mathematical engineering, is a member of the laboratory *Ambiances Architectures Urbanités* (AAU - UMR CNRS 1563), CRENAU team, which he led from January 2014 to December 2018. His research focuses on the morphological analysis of the city and more precisely on an approach to urban form as visual form, bioclimatic form or network form. These different registers notably allow to model and quantify certain qualities of urban design, as he has been teaching for several years within the Master U-ENV at the *Ecole Centrale* and the *Ecole d'Architecture* of Nantes. He has contributed to several research projects (ANR CoolScapes, Merubbi, Urbasis, Eval-PDU in particular), is or has been involved in European actions (TU0801, 18204), has organized scientific conferences (SCAN'18, 3U3D-2012) or CNRS thematic school (Vu-pas-vu 2017), and supervises or has supervised Ph.D. or Master students.

Laurent LESCOP

is an architect, a doctor in sciences with habilitation and is a professor at the Nantes' Superior School of Architecture (ENSA Nantes) and researcher at AAU - UMR|CNRS 1563. He has worked ten years as an architect and is specialized into CG graphics and immersion. He's a trained specialist for 3D scanning, modeling, and restitution in the fields of archaeology, architecture, and scenography. His main teaching and research refer to immersion and immersive devices used for design and visualization and he's invited to many workshops and lectures round the world.

Fabian LEVEQUE

is a Ph.D. student in geography and urban studies at the University Lumière Lyon (UMR Triangle). He focuses his research on the environmental effects of urban and metropolitan policies through issues such as climate change, ecological degradations, and social inequalities, in France, Europe and Latin America. In summer 2019, he takes part in an action research about the lived experience of climate change and ecological commitment by inhabitants of French cities. He details the results in his contribution in this book. As a member of the "reseau des territorialistes," he also encourages other reflections about territories, bioregions, inhabitants, and ecological lifeform out of the metropolitan influence. He begins, in 2018, a Ph.D. thesis on social and racial dimensions of ecological issues through an epistemological work on "environmental justice," including Latin America decolonial theories. Through all his works, he seeks to define the concept of "urban capitalocene."

Sandra LORENZI

graduated from the Villa Arson National School of Art (Nice) in 2009. Her work has since been presented in institutions and galleries in France and abroad (Italy, Greece, South Africa, Germany...). She was in charge of artistic teaching at the Institut Supérieur des Arts de Toulouse from 2012 to 2019. She teaches at the Higher School of Arts in Annecy Alpes. She is also an artist-intervener in the “Brain Space Laboratory” of the Institute of Contemporary Art in Villeurbanne.

Giorgos LOUKAKIS

holds a Ph.D. from the Department of Civil Engineering (UTH). He is a post-doctoral researcher at the Department of Architecture at the University of Thessaly, Greece (UTH) and a lecturer at the Department of Computer Science & Telecommunications (UTH), teaching the course “Architecture and Game Development.” His research interests are the digital representations of landscape, the history and design of video games and virtual/augmented reality.

Daniele LUGLI

is a tattoo artist and Ph.D. candidate at Monash University in Australia. Investigating the contemporary tattoo studio as a designed space, her research aims to surface the sensorial and atmospheric experience of individuals, and how these are informed by gender and the sense of belonging.

Théa MANOLA

is an architect (DPLG), has a master degree and a Ph.D. in Urban studies. She is an associated professor on Social and Human Sciences for Architecture at the Grenoble school of architecture (University Grenoble Alpes), a researcher with the CRESSON team at the CNRS Laboratory AAU (Ambiances, Architecture, Urbanities). Her scientific work focuses on the links between social science and project processes and on the socio-political and environmental aspects of sensitive approaches. She is interested in ordinary sensory experiences, sensescapes, socio-environmental and participatory issues and their place in the urban fabric. She specifically focuses on socio/political and environmental aspects of sensitive approaches. <http://aau.archi.fr/equipe/manola-thea/>

Neoklis MANTAS

is an urban Planner (BSc+MPlan) with a Master’s Degree in Urban & Cultural Geography at Queen Mary University of London (MA Cities & Cultures). He is about to defend his doctoral thesis (Ph.D.) concerning the ‘*Emerging Oneirotopias in Contemporary City: In the Quest of Metamodern Urban Identity & Image through the Cinematic Palimpsest*’ (Summer 2020). His interdisciplinary work has been published in several academic conferences. His core research interest about utopianism and ideal cities uses psycho-geography and phenomenology as tools for urban exploration and interpretation correspondingly. His personal blog, stigmography.tumblr.com, is such an attempt.

Eleni MANTZARI

holds a Ph.D. in Applied Linguistics from the University of Patras, Greece. Currently, she is a postdoctoral researcher at LECAD, University of Thessaly and an adjunct professor at the Department of French Language and Literature (National and Kapodistrian University of Athens). Her research interests include cognitive linguistics, linguistic landscape and multimodal communication in the field of digital humanities.

Polyxeni MANTZOU

is a Doctor Architect, Professor and Director of the Laboratory for Artistic, Electronic and Audiovisual Applications, Department of Architectural Engineering, DUTH; Coordinator of the Research Group SindeFin. She has taught in graduate and post-graduate level at Democritus University, ETSAM Universidad Politécnica de Madrid, University of Ioannina, Hellenic Open University. Her architectural work has been awarded, exhibited and published. Her research is focused on how digital media transform our understanding and our relation to architectural and urban space and has published relevant books and articles.

Andrés MARAGAÑO LEVEUQUE

is an architect, Master in Urban Planning at Universidad Politécnica de Cataluña. Associate Professor at Universidad de Talca. He has been as well part of teachers team at the Escuela de Arquitectura from 2000 to date, where he was Director between 2010-2012. He currently performs academic duties as professor of Project Workshops and professor of the Degree Workshop. In conjunction with teaching, he develops research on architecture and education and on the correlation between architecture and culture. From these investigations, several articles have been published in specialty magazines in Chile and Europe. Among the latter ones: (2020) *Art installed in the construction of learning spaces*, Revista Arquitecturas del Sur, Chile, (38), 57: 38 - 55; and (2017) *The light forms of dwelling. Some parts of the educational model of the School of Architecture at Universidad de Talca*. European Journal of Architecture Research. (7): 189-197.

Afroditi MARAGKOU

is an architect (AUTH, 2012), holds a MSc degree in Architectural Design (UTH, 2015) and is currently a Ph.D. candidate in the Department of Architecture, University of Thessaly. She is a Graduate Research Fellow in University of Thessaly in the project “*Evidence for recording the Anthropocene. Transformations of the countryside of Thessaly through local newspaper archives: 1949-2010*” and Assistant Tutor in undergraduate classes in the Department of Architecture, University of Thessaly. She has participated as a speaker in international architectural congresses, and as a guest doctoral student in the Global History Workshop, S. Seeger Center of Hellenic Studies, Princeton University (2020). Her dissertation research is implemented with a Doctorate Research Scholarship from the Greek State’s Scholarship Foundation (IKY).

Théo MARCHAL

is an architect, musician and associate lecturer at the School of Architecture of Grenoble involved in both teaching and research. He has been working for several years on the importance of sound in the design of spaces and on their potential as “materials” for construction and project elaboration through site-specific experiments, pedagogical workshops and musical research. His specialization in digital tools related to the design of space associated with questions about ambiances have led him to investigate the question of tools, and more particularly the close link they maintain with the design of architectures. His Ph.D. work (directed by Grégoire Chelkoff) focuses more specifically on the development of a tool that allows sound environments to be taken into account from the very first sketches of a project (architectural and urban) through a digital process of real-time auralization and articulation with 3D design tools.

Thalia MAROU

is a Ph.D. candidate at the Department of Architecture in University of Thessaly. She graduated from the Department of Forest Science and Natural Environment (Aristotle University Thessaloniki, 1991) and received Msc in Environmental Design of Cities and Buildings (Hellenic Open University, 2007). Currently, she teaches courses on Urban Gardening and the Contemporary City, Food Geographies, the Environment and the Natural Resources, and Urban Green Infrastructures and Plants in the city, at the Department of Architecture, University of Thessaly. Her research interests are focused on the interactions of the practice of urban gardening with everyday life and culture, urban gardening as a factor in planning for urban resilience and natureculture networks.

Damien MASSON

is an Associate Professor in Urban Studies at CY Cergy Paris University, researcher at the MRTE laboratory, France, and co-director of the International Ambiances Network. His previous research has focused on sonic ambiances of public transports, and on the relationship between ambiances and mobility. His current research concerns the ambient dimensions of security and safety policies in urban areas, and the atmospheres of “post-terror” in cities that experienced terrorist attacks. This involves developing new research methods that aim at crossing micro-spatial approach, social encounters and sensory phenomena. The contributions of his recent research consist in articulating the social, cultural and political dimensions of urban spaces to the sensory and the ambient.

Jean-Baptiste MASSON

University of York, White Rose College of the Arts and Humanities. Jean-Baptiste Masson is a composer and Ph.D. researcher in the History Department of the University of York, where he works on listening and its relationships with society and technology, with a special emphasis on field recording, its history and philosophy. He holds a BA in Archaeology (Université de Bourgogne) and a MA in Composition (Université de Reims Champagne-Ardenne). His music covers a broad spectrum, from field recording to string quartet and choir. He often improvises with friends in the bands Jah Poney and Colonne Drone. He is also a cultural organizer, working with different organizations in France (Collège Contemporain, European Creative Academy, Fondation Royaumont). www.jbmasson.com

Robin MCGINLEY

is a British musician, sound and new media curator, freelance events producer and arts educator currently based in Stockholm. He holds a Ph.D. from the Music, Technology and Innovation Research Centre at De Montfort University, UK. He is Chair of Programme and Course Leader of the International MA in Curating Art at Stockholm University, a researcher and lecturer in sound at Konstfack, and co-Director of Interactive Agents, the independent production company and R&D think tank.

Olfa Raja MEZIOU

is an architect, teacher at the National School of architecture and urbanism of Tunis (ENAU), researcher in the Equipe de recherche sur les ambiances (ERA / ED-SIA Tunis). Her research focused on the design process through first a doctoral thesis on the genetic study of an architectural work. Later, she became interested in the design process of atmospheres. For several years now, she has devoted herself to exploring the potential of Peter Sloterdijk’s thought for the design of atmospheres.

Stephan MOORE

Stephan is a sound artist, composer, improvising musician, teacher and curator based in Chicago, IL, USA. He is a co-founder of the Chicago Laboratory for ElectroAcoustic Theater, one half of the sound art duo Evidence, and the proprietor of loudspeaker manufacturer Isobel Audio. He teaches in the Sound Arts and Industries program at Northwestern University.

Susana MORENO SORIANO

is a Ph. D. Architect, professor at Universidad Europea de Madrid. She has been director of Technology Department and as well as the Master Sustainability in Energy and Environmental Regeneration 2009-2014. She is currently Principal Investigator of ELAN (which means Local Strategies Architecture and Nature in Spanish). She has published the papers *Redensification and cooperative movement as tools for the regeneration and sustainable urban regeneration of vulnerable neighbourhoods in Madrid*. Proceedings ISUH-H 2019 III. Ciudad Compacta versus Ciudad Difusa. As a team she got the First Prize at the International University competition Powering Transformation at SB14. Also author of the book *Music and Architecture in the 20th century*, that was her thesis. She promotes regularly dissemination activities with the Music Working Group at the Madrid College of Architects. In 2019 she did a teaching internship at the school of architecture at Universidad de Talca.

Elisa MORSELLI

is an architect and a Dr. in Architecture-Theory and Design based in Rome. She studied in Italy at Sapienza University and in U.K. at Newcastle University. She obtained her Ph.D. in 2017 with an interdisciplinary dissertation on how the perceptual and emotional aspects generated by the figurative images of architecture are changed, from XVIII cent. until nowadays. Her research focuses on exploring the sensorial and affective architectural experience by integrating architecture, aesthetics, visual cultures, neuroaesthetics, and phenomenology. At present, she is working in the research "Feelings and the city" at Sapienza University and, she published her first monograph "Case Study Houses. La percezione dello spazio vissuto tra tecnica e narrazione" (Mimesis 2019).

Fatma MRAD

was born in 1990 in Tunisia. She is an architect graduated in 2015 from the School of Architecture and Urban Planning of Tunis at the University of Carthage. She has worked as an architect in architecture agencies and since September 2018 she is a Ph.D. student in architecture at CNRS - UMR 1563 - AAU - CRESSON. Her thesis questions the potential of filmic atmospheres to report and reveal new aspects of our urban atmospheres through the emotions they arouse. Passionate about architecture and neurosciences, she has chosen to explore different disciplinary points of view in her research, in this case neurosciences and human and social sciences, with the aim of striving for knowledge sharing.

Daniel NASCIMENTO

is a Ph.D. Student in Architecture at Federal University of Rio de Janeiro (PROARQ/UFRJ). Master in Architecture in Pontifical Catholic University of Rio de Janeiro (PPGARQ/PUC-Rio) and degree in Architecture and Urbanism in this same university. His research concerns the experimentation of walks, wanderings and poetic narratives as aesthetic practices capable of expanding the traditional field of architecture's critic and as ways of apprehension, comprehension and production of complexity in

railways suburban landscapes of Rio de Janeiro. Exploring mnemonic-affective body relationships and its narratives in liminal places, his research is conducted by the range of possibilities to reinvent existent hidden landscapes, to produce other subjectivities and to investigate artistic methods as architectural practices.

Stine Louring NIELSEN

holds a BSc and MSc in Anthropology from the University of Copenhagen, Denmark. She is currently a Ph.D. Fellow in the Lighting Design Research Group at the Department of Architecture, Design and Media Technology, Aalborg University Copenhagen. For over a decade, Stine has been working in the industry and academia together with architects, designers and users of healthcare environments; she has carried out user research to evaluate and inform the designs of hospitals and hospices, as well as qualitative analysis of healthcare designs for maternity wards. Her projects and research focus on aesthetics, atmosphere and bodily affect in architecture, including the study of art, colour and lighting. Her research is primarily rooted in phenomenological perspectives and (sensory) ethnographical methods. Moreover, Stine is an accredited EDAC professional and a member of the performance-group Sisters Hope, working towards a more sensuous society.

Olivier OCQUIDANT

is a Ph.D. student at the Centre Max Weber (University Jean Monnet of Saint-Etienne, Ensase), his thesis focuses on the sensitive components of urbanity in the city of Saint-Etienne. He develops a sensitive approach to the city through an ethnography using participant observation, interviews, walks and images (photo and video). He examines the city in its micro sociological and ecological aspects, and questions the construction of place attachments.

Maria Rita PAIS

is an architect, teacher, researcher and curator with degree in Architecture (FAUTL, 1999), Master in Construction (IST, 2004) and Ph.D. in Architecture (FAUTL, 2012). Currently teaches and co-coordinates Ph.D. at ULHT (Universidade Lusófona de Humanidades e Tecnologias) with Mário Kruger. Co-curates *Lisbon Open House 2018* (with Luis Santiago Baptista), *Habitar Portugal 2009-2011* (with Susana Ventura and Rita Dourado) and co-curate *Journey into the Invisible* exhibition (with Luís Santiago Baptista). Recently, co-edit the book *Journey into the Invisible* (with Luís Santiago Baptista). In research, dedicates herself to themes in the areas of architecture, territory, military, art and living: is CoPoPo at SOSClimateWaterfront Marie Curie Project (with Pedro Ressano Garcia); Principal Researcher in research project *Bunker architecture from mid 20th century and the post military Portuguese classified heritage: The Plan B of Defence of Lisbon and Setúbal harbours*; and in Research Project *Inhabiting Siza: houses between project and experience*.

Satyendra PAKHALÉ

established his practice SPA – Satyendra Pakhalé Associates in 1998 in Amsterdam, the Netherlands. He was trained both in India and Switzerland and has been active in the field of design and architecture. His design work is an act of unity going beyond any binary such as high- and low-tech, industrial production and traditional crafts, functionality and poetic significance. Over the last 20 years Pakhalé has cultivated a design practice through numerous innovative design projects for leading clients and industries, he has developed a worldwide reputation for designing diverse product typologies, pushing the limits of technology and materials. He has lectured throughout the world on platforms such as CeBIT Germany, Casa Brasil and Future Design Days Sweden. He

was invited to head the Master of Design for Humanity and Sustainable Living, Design Academy Eindhoven from 2006-2010. His works are in permanent collections at prestigious museums throughout the world.

Cristina PALMESE

is a Ph.D. Architect. Director of PaisajeSensorial Office Lab Architecture. Born in Italy, she lives and works in Madrid. Her activity develops in a crossroad between art, research and architecture. Specialist in Sensorial Landscape and Audio-Visual Architecture. Current project “Soundscape as Immaterial Heritage.” Universidad Autónoma de Madrid. Program of Subdirección General del Instituto del Patrimonio cultural. Spanish Minister of Culture. Collaborative Map Sound Stories of Covid-19. https://paisajesensorial.com/index.php/project_list/sound-stories-of-covid19/. Co-Chair of “*Madrid Sound week*.” Expanded video-theater “Rosita ante el Espejo” Re-think F. Garcia Lorca.

Anders PALSTRØM

is a MA student in Philosophy at Aarhus University, Denmark. With a special interest in philosophical aesthetics and more broadly in phenomenology and hermeneutics, he is currently involved in the establishment of Aisthesis, a new network for aesthetics and phenomenology in Denmark. He studies under Professor, Dr. Dorthe Jørgensen.

Lis PAMPLONA

is a Ph.D. Student in Architecture at Federal University of Rio de Janeiro (PROARQ/UFRJ). Master of Architecture in the same Post-graduation Program (2019) and degree in Architecture and Urbanism at Federal University of Rio de Janeiro (2015). Her research concerns architecture critic, theory, and history from intersections with literature, music, and visual arts. Inquiring about the multiple temporalities, meanings and concepts of images, her research is focused on the notion of Atlas and Montage in architecture imagination and production.

Spiros PAPADOPOULOS

is an architect and media artist. He is Professor of Architecture and Time Based Media at the Department of Architecture (UTH). His research interests focus on hybrid landscapes, audiovisual culture and ICTs in education.

Evangelia PAXINOI

is an architect, Dr. (Aristotle University of Thessaloniki), DEA Ambiances Architecturales et Urbaines. After several years in architectural offices in private sector in Greece and in France, she’s now associated researcher at “Ambiances, Architectures, Urbanités” research laboratory (AAU-CRESSON, UMR CNRS, France) and employed by the technical services of Volos municipality, Greece (public space and public building design and rehabilitation). Her work focuses, as an engineer and as a researcher, on the creation of the atmosphere for the public in contemporary public spaces.

Claire PELGRIMS

holds a Ph.D. in Architecture and Urbanism from the Université libre de Bruxelles, Belgium. Her Ph.D. thesis investigates imaginaries of fast and slow mobilities in the evolution of Brussels mobility infrastructure since the mid-20th century. Her research focuses on expanded understanding of mobility infrastructure in relation to gender, aestheticism and functionality. Claire has also been involved in researches on Brussels

metropolitan cultural and mobility infrastructures (micm-ARC) and on sustainable transition of company mobility. She is a member of the Laboratory on Landscape, Urbanism, Infrastructures and Ecologies, ULB and Associate researcher at the Laboratory on Urban Sociology [LaSUR], EPFL. She has joined T2M Executive Committee in 2019 and is involved as member in the French 'Passé, present mobilité' [P2M] network and in the International Ambiances Network.

Barbara E.A. PIGA

An Architect by education, she is Assistant Professor at the *Politecnico di Milano (POLIMI)*, where she is also coordinator of the Laboratorio di Simulazione Urbana Fausto Curti - labsimurb (Dept. of Architecture and Urban Studies) since its foundation in 2007. At *labsimurb* she coordinates and leads projects related to experiential simulation and multi-sensory design. She is part of the board of the interdepartmental research laboratory i.Drive - Interaction Between Driver, Road Infrastructure, Vehicle, And Environment since 2019, where she is responsible for mobility experiential simulation and the urban/landscape environment design guidelines (assessment and design perspective). She is the POLIMI Coordinator of two European Projects H2020 EIT Digital AR4CUP: Augmented Reality for Collaborative Urban Planning (2019 and 2020), where she is responsible for a novel co-design methodology through Augmented and Virtual Reality. She fosters a multi-scalar and interdisciplinary approach. She holds a Ph.D. in Urban Planning from POLIMI (2010).

Ethel PINHEIRO

Architect and Urbanist from the Federal University of Rio de Janeiro (2001) with Magna Cum Laude title of honor. D.E.A (2004) and Ph.D. in Architecture (2010), both from the Graduate Program in Architecture of the Federal University of Rio de Janeiro Proarq/UFRJ. Currently Coordinates Proarq/UFRJ (2020-2021) in addition to acting as Chief Editor of CADERNOS PROARQ Journal and coordinator of the Laboratory "Architecture, Subjectivity and Culture" - LASC. Works as Associate Professor at FAU/UFRJ and as Permanent Professor at Proarq/UFRJ. Experience in architectural representation with an emphasis on urban space design, coded drawing and sketch drawing, currently addressing the ethnographic and contemporary spaces. She has been advising several undergraduate students and Ph.D. theses in architecture and urbanism.

Hengameh PIRHOSSEINLOO-AMINI

is state-certified architect, doctor of architecture and associate researcher at the AAU-CRESSON laboratory (UMR Ambiances, Architectures, Urbanités), in the National School of Architecture of Grenoble. After several years of experience in agencies, in France and in Canada, she wanted to develop a reflection on concerns arising from her professional practices by enrolling in a thesis at the Cresson laboratory. Her research concerns the question of comfort and potential for habitability and of appropriation which could bring by the devices of the thick facades for the contemporary housing from the perspective of ambiance particularly in dense urban environment.

Tiziana PROIETTI

is an architect and Ph.D. in Architectural Design, Tiziana Proietti earned her doctorate from the Department of Architecture of the Sapienza University of Rome in collaboration with the University of Technology TUDelft. Her doctoral dissertation concentrated on the theory of proportion in architecture. She is an Assistant Professor at the University of Oklahoma where she directs the Sense|Base Laboratory. Together with the scientist Dr. Sergei Gepshtein of the Salk Institute for Biological Studies in California,

she develops an interdisciplinary program of research which will bridge neuroscience and architectural design and test age-old hypotheses about the human response to architectural proportion. Proietti is cofounder with Satyendra Pakhalé of the cross-disciplinary research platform ‘Culture of Creation’ that brings design thinking and studio practice together while covering range of topics such as social modernity, atmospheres of spaces and objects, early Buddhist realizations on senses and perception, poetic analogies, sensorial design and secular humanism.

Juliana QUEIROZ

is an architect and Urban Designer from PUC-Rio de Janeiro with an exchange program in Lisbon (UTL). Member of research group Architecture, Subjectivity and Culture LASC - PROARQ/UFRJ. Professional Experience in Interior Design and analysis of Environmental Comfort. Performs, mostly, in Interior Design projects and renovations.

Andrej RADMAN

has been teaching design and theory courses at TU Delft Faculty of Architecture since 2004. A graduate of the Zagreb School of Architecture in Croatia, he is a licensed architect and recipient of the Croatian Architects Association Annual Award for Housing Architecture in 2002. Radman received his master’s and doctoral degrees from TU Delft and joined Architecture Theory Group as Assistant Professor in 2008. He is an editor of the peer-reviewed journal for architecture theory *Footprint*. His research focuses on new-materialist ecologies and radical empiricism. Radman’s latest publication is *Ecologies of Architecture: Essays on Territorialisation* (EUP, forthcoming).

Simone RANOCCHIARI

was born in Rome. She obtained a bachelor’s degree in Architecture at the University of “Roma Tre” (Italy), and one in Sociology at the University of Paris 8 Vincennes-Saint Denis (France). He then approached Cultural Geography at the University of Paris-Sorbonne, where he obtained a Master degree with a thesis on Roman urban social movements. His interest in politics - and particularly on roman self-management movements - led him to pursue this research experience with a Ph.D. at the Institute of Geography and Sustainability of the University of Lausanne (Switzerland).

Michel RASPAUD

is an Emeritus Professor of Sport Sociology at Université Grenoble Alpes, France. His research focuses mainly on sociology and history of mountaineering, high altitude adventure tourism, and international football (Africa, Brazil, Romania). He was Head of the Faculty of Sport Sciences at Université Joseph Fourier Grenoble (2001-2006), and a research fellow at De Montfort University Leicester (1997), and at Universidade de São Paulo (2008). In 2001, ha was a founding member of “Société de Sociologie du Sport de Langue Française.” He has five books published to his credit: *L’Aventure himalayenne* (Presses Universitaires de Grenoble, 2003), *Histoire du football au Brésil* (Chandeigne, 2010), *Le sport au Brésil. XIX^e-XXI^e siècles* (Chandeigne, 2016), *Vélo Viso*, with M. Molle & G. Plagnol (Editions du Queyras, 2016) and, with Ernest Yeboah Acheampong & Malek Bouhaouala, *African Footballers in Europe. Migration, Community, and Give Back Behaviours* (Routledge, 2019).

Nicolas REMY

is associated professor at the architectural department of the Thessaly university. He’s teaching building physics and has developed several courses on acoustics, ambiances and soundscape design. Associate researcher at CRESSON (CNRS, ENS School of Archi-

ecture at Grenoble, France) his work deals with the concept of ambiance as a a tool and as a method for architectural design. More specifically, his work on the relationship between physics, perception theories and architecture. He has presented his work in several International conferences (France, Greece, England, Italy, Sweden, Portugal, Chine). In 2016 he co-organized the 4th International Conference on Atmospheres and since 2018 he is co-director of the Ambiances International Network.

Yorgos RIMENIDIS

is an architect (UTH, 2011), MArch degree in Architectural Design-Space-Culture (NTUA, 2019) and a Ph.D. candidate at the Department of Architecture, University of Thessaly. In the recent years he is an Adjunct Lecturer at the Department of Culture & Creative Media & Industries (UTH) and he participates as a Research Fellow in design and anthropology research programs at the Department of Architecture (UTH). His current activities involve any-scale design projects, experimental architecture configuration as well as the wide spectrum of visual communication and book design.

Natália RODRIGUES DE MELO

received the bachelor's degree in tourism from the University of Ouro Preto (2010), Brazil, the master's degree in geography from University Grenoble Alpes (2019), France and in Architecture from University of Rio de Janeiro (2013), Brazil, and the Ph.D. degree in Architecture from the University of Rio de Janeiro (2018), Brazil. She is currently a Research Associate with the Social Science Laboratory (PACTE), Grenoble, France, and member of the Laboratory of Architecture, Subjectivity and Culture (LASC), Rio de Janeiro, Brazil. Her research mainly focuses on the transition of urban spaces, with an emphasis on the analysis of changes and transformations in the ambiances of tourist places and soccer stadiums. Her research interests also include soccer and production of the urban spaces, urban cultures, urban ethnography, social and territorial innovation, ambiance, and sensitive aspects of urban spaces.

Paul ROQUET

is Associate Professor of media studies and Japan studies in the Comparative Media Studies/Writing section at the Massachusetts Institute of Technology. His work examines the aesthetics and cultural politics of spatial mediation. His first book, *Ambient Media: Japanese Atmospheres of Self* (Minnesota, 2016) explored how musical recordings, video art, film, and literature came to be repurposed as tools for personal mood regulation, giving rise to an ambient aesthetics mixing critical distance with relaxation and self-care. His current research focuses on how the VR head-mounted interface further transforms the perceptual relationship between a person and their surrounding environment. His writing on these and other media can be found in venues including *Visual Culture*, *Representations*, *Animation*, *Sound Studies*, and *LOGIC* magazine. See <https://proquet.mit.edu> for further details

Cristiane ROSE DE SIQUEIRA DUARTE

received the bachelor's degree in architecture from the University of Rio de Janeiro (1981), Brazil, and from the University Paris XII (1983), Paris, France, the master's degree from the University Paris XII (1985), Paris, France, and the Ph.D. degree from the University Paris I (1993), Paris. She was a postdoctoral fellow at the University of California Berkeley (2014). She was a professor at the University of Rio de Janeiro (UFRJ) since 1983, being Full Professor at the Faculty of Architecture and Urbanism until 2017. Currently, she works at the Graduate Program in Architecture at UFRJ (PROARQ) where she coordinates the Laboratory of Architecture, Subjectivity and

Culture (LASC) and the Pro-Access Nucleus. She has experience in the area of Architecture and Urbanism, with an emphasis on the cultural and subjective dimensions of space, accessibility and ethnography of the city.

John Stanislav SADAR

teaches Architecture at the Swinburne Institute of Technology. From 2016 through 2017, he taught Interior Design at Parsons School of Design, and from 2009 through 2015, he was Senior Lecturer in Architectural Technology and Design in the Department of Architecture at Monash University in Melbourne, Australia. He completed undergraduate studies at McGill University in Montréal, and postgraduate studies at Aalto University in Helsinki, and the University of Pennsylvania in Philadelphia. He has worked in private practice with firms in Finland, Slovenia, Canada, and the United States. He is a co-founder of the interdisciplinary design studio little wonder. He is concerned with the performative, ecological role of the built environment, with particular interest in how sensory technologies, biological materials and environmental energies intermingle in the built environment to create rich experiences that forge deep connections with the world around us.

Alice SALIMBENI

is a Ph.D. student of architecture who has approached the disciplines of feminist urban geography. Her research interests concern the study of the emotional and affective relationship between women's bodies and the urban space through participatory, creative and visual methodologies, aimed at showing both expressible and inexpressible meanings. Her work is based on non-representational approaches to urban space, feminist geography and nomadic theory.

Ilana SANCOVSCHI

is a Ph.D. student in the Post Graduate Program in Architecture at the Federal University of Rio de Janeiro; LASC researcher.

Monica SAND

is an artist, Ph.D., Research Adviser at the Faculty of Fine, Applied and Performing Arts, University of Gothenburg, Sweden. Currently Sand coordinates the artistic research project the *Common Room* financed by Vinnova 2018-2021, with the aim to develop a new experimental public model for a more democratic knowledge exchange within academia. For several years Sand and Atienza has been collaborating under the head-line *Playing the Space*, in which artists, students, and researchers explore urban resonance, corporeal rhythms, and movements, as well as public policies, through collective actions in European cities, resulting in exhibitions, public presentations/ actions, and articles: <https://playingthespace.wordpress.com>

Lisa SANDLOS

is a long-standing faculty member of the Department of Dance and School of Kinesiology at York University in Toronto, Canada. Sandlos holds an MA in Dance and is a Certified Movement Analyst (CMA) through the Laban Institute of Movement Studies (LIMS). Her Ph.D. in Gender, Feminist and Women's Studies focuses on sexualization of girls in competitive dance. A keen interdisciplinary collaborator, Sandlos has worked on dozens of community arts projects with actors, musicians, puppeteers, and visual artists and she is co-founder with landscape architect Rennie Tang of a research/ teaching group called *Soma-City*. Working through organizations such as the Ontario Arts Council's *Artists in ducation* program, the National Ballet of Canada's *Creating*

Dances program, the Toronto District School Board's *Drama/Dance Project* and the Royal Conservatory of Music's *Learning through the Arts*, Sandlos has taught contemporary dance, somatics and improvisation to all ages and levels for over three decades.

Luís SANTIAGO BAPTISTA

is an architect, researcher, curator. Master in Contemporary Architectural Culture (FA-UTL) and Ph.D. candidate in Architecture and Urban Culture (DARQ-UC), developing the thesis *Point de Folie: Strategies of Deconstruction in Contemporary Architecture 1978-2001*, with research at Architectural Association, MoMA, and Centre Canadien d'Architecture. Teaching assistant in FA-UTL (1999-2003) and invited Assistant Professor in ECATI-ULHT (2010-), and ESAD-CR (2015-). Editor-in-chief of *arqa* (2006-16), and member of the editorial board of *J-A* (OA, 2015-19). Curator of *Generation Z: Emergent Portuguese Architectural Practices* (OA, 2007-12), ““Let’s talk about houses’... in Portugal” (Lisbon Architecture Triennale 2010), *ARX archive* (CCB, 2013), *Architecture in Competition: A Critical Journey through Portuguese Modernity* (OASRS/CCB, 2016), *Fernando Guerra: A Photography Practice under X-Ray* (CCB, 2017), *Journey into the Invisible* (2016-19) and *Almada: A Territory in 6 Ecologies* (CMA, 2020). Author of *Modern Masterpieces Revisited* (2016). Working Group Leader in *Writing Urban Places: New Narratives of the European City* (COST CA18126, 2019-).

Steven SAULNIER-SINAN

is associate lecturer at the School of Architecture at the University of Grenoble-Alps. He teaches philosophy and urban sociology to students in architecture and urban design. He has a master’s degree in architecture and currently works on his Ph.D. in urban design and architecture, at AAU-CRESSON laboratory (UMR MCC/CNRS 1563 “Ambiances, Architectures, Urbanités”). His research is supported by the Auvergne-Rhône-Alpes regional authority as part of the ARC7 programme (innovations, mobilities, territories and urban dynamics). His research interests are attention/distraction processes, forms of dominations and technical systems in urban public spaces which are studied through a sensory approach. His research fields are the urban area of Grenoble (France), London and the Hertfordshire (United Kingdom), Aarhus and Copenhagen (Denmark).

Jennifer SCOTT

has taught at Washington State University and has consulted on lighting and color. She is an Architectural Visualization Artist for illumina, LLC. This research is a continuation of her Interior Design masters project.

Elisa SEIDNER

Elisa Seidner has been practicing occupational therapy for 25 years and is the owner of KidAbilities, a pediatric occupational therapy clinic in Santa Monica, California. Seidner’s clinic specializes in evaluation and interventions with children having sensory-motor challenges. Her main research interest lies in sensory integration theory and practice. She is currently pursuing a Ph.D. in Health Related Sciences at Virginia Commonwealth University, researching objective measurement of postural control using mobile technology. Her interest in interdisciplinary research began with her involvement in the Neurodevelopment and Related Disabilities program at the University of Southern California and Children’s Hospital of Los Angeles. Seidner has co-led interdisciplinary collaborative projects and presentations combining environmental design with adaptive features for individuals of varying diagnoses and abilities. Together with Rennie Tang, Seidner has given presentations connecting architecture, play, and occupational therapy.

Farzaneh SEMATI

holds an MA in architecture, from Shiraz University, focusing on multisensory design during her studies. Her thesis was on the theory of multisensory atmospheres in architecture. Having completed her MA, she then collaborated with several architectural firms in Iran and went on to co-establish Goljaam Design Studio in 2018. She is interested in the field of multisensory design and is an independent researcher in architectural atmospheres and their perception.

Myriam SERVIÈRES

is an Associate Professor in computer sciences at École Centrale Nantes and a member of CNRS JRU Ambiances, Architecture and Urbanity since 2006. She received an engineering degree in computer science and a M.Sc. in applied computer science from École Centrale Nantes in 2002 then she achieved a Ph.D. in university of Nantes in 2005. Her research interests are in on-site precise geolocalization, Augmented Reality and usages of such techniques in urban environments.

Jennifer A. E. SHIELDS

is an Assistant Professor of Architecture at California Polytechnic State University, San Luis Obispo and a Registered Architect. Her research and teaching are interdisciplinary, engaging colleagues and students from other disciplines to investigate the relationship between graphic representation methods and spatial perception. Her first book, *Collage and Architecture*, was published by Routledge in 2013. She is currently working on a second edition. She received a Bachelor of Science in Architecture from the University of Virginia and a Master of Architecture from the University of Virginia. Before moving to San Luis Obispo in 2015, Jennifer worked as an Architect in Charlotte, NC and Visiting Assistant Professor at the University of North Carolina, Charlotte.

Angeliki SIOLI

is an Assistant Professor of architecture at the Chair of Methods and Analysis, TU Delft. She completed her Ph.D. in the history and theory of architecture at McGill University. Her research seeks connections between architecture and literature in the public realm of the city, focusing on aspects of embodied perception of place in the urban environment. She recently edited the collected volume *Reading Architecture: Literary Imagination and Architectural Experience* (Routledge, 2018) and is currently editing the volume *The Sound of Architecture: Acoustic Atmospheres in Place* which will appear with Leuven University Press in 2021. Before joining TU Delft, Sioli taught both undergraduate and graduate courses at McGill University, in Montreal; Tec de Monterrey, in Mexico; and Louisiana State University in the U.S.

Diana SOEIRO

Philosophy, Ph.D. (Universidade Nova de Lisboa/UNL, 2011). Her research interests are Philosophical Anthropology, Architecture and Urbanism, and Political Science. She conducted her Postdoctoral studies in *Philosophy and Urban Studies* (UNL, 2012-2018) funded by Fundação para a Ciência e a Tecnologia (FCT). She was Postdoctoral researcher at the project *ROCK - Regeneration and Optimization of Cultural heritage in creative and Knowledge cities* (2017-2020), funded by the European Union under Horizon 2020. In 2020 she is expected to defend her MSc thesis in *Economics and Public Policy* at ISCTE - Instituto Universitário de Lisboa (ISCTE-IUL). In 2017 she was appointed Ambassador for United Nations' 2030 Sustainable Development Goals Agenda (Portugal). Recently she authored: "The Concept of Atmospheres: From Goethe to Bratton - How Atmosphere Is Key to Creating Smart Cities" (2020), in *Reconstructing*

Urban Ambiance in Smart Public Places (edited by H. Abusaada, A.M. Salama & A. Elshater), IGI Global, DOI: [10.4018/978-1-7998-3856-2.ch002](https://doi.org/10.4018/978-1-7998-3856-2.ch002).

Amir SOLTANI

is a designer and research associate at the University of Cambridge Architecture Department, Ph.D. research at DIGIS (Digital Studios for Research in Design, Visualisation and Communication) and MA in Design from UC Berkeley CED (College of Environmental Design). He has lectured and given workshops in the US, UK, Germany, China, and Middle East. Amir has been a UK EPSRC grant recipient and his interdisciplinary research interests lays in-between art, architecture and revealing codes of design. amir@metrowave.uk

Aleksandar STANIČIĆ

is an architect and Assistant Professor at TU Delft Faculty of Architecture and the Built Environment, the Chair for Methods and Analysis. Previously he was a Marie Curie Postdoctoral Fellow at TU Delft, research scholar at the Italian Academy for Advanced Studies, Columbia University, and postdoctoral fellow at the Aga Khan Program for Islamic Architecture at MIT. Aleksandar's work stems from two book projects, *War Diaries: Design after the Destruction of Art and Architecture* (coeditor, University of Virginia Press, 2020) and *Transition urbicide: Post-war reconstruction in post-socialist Belgrade* (sole author, forthcoming). His is recipient of multiple grants and fellowships from the Graham Foundation, the European Commission, Government of Lombardy Region, Italy, and Ministry of Education, Republic of Serbia.

Eric STEVENS

After having held managerial responsibilities as marketing manager for fast moving consumer brands and leading a Ph.D. at the University of Newcastle Upon Tyne University (AACSB), Eric Stevens has developed a range of research work on Service Innovation and Customer Relationship Management. He is responsible for books such as *La gestion de la relation client*, 5ed, Pearson, a book labelled FNEGE in 2017, and publications referenced in journals such as the *Revue des Sciences de Gestion*, *Journal of Business Research*, *Technovation*, *International Journal of Bank Marketing* and *European Journal of Marketing*. The work devoted to the management of service innovation aims to better understand the issues related to the fields of tourism, public services and eventually architect taken as social innovation agent.

Shanti SUMARTOJO

is an Associate Professor of Design Research in the Faculty of Art, Design and Architecture and a member of the Emerging Technologies Research Lab at Monash University (Melbourne). Using sensory, digital and design ethnographic methodologies, she investigates how people experience their spatial surroundings, including both material and immaterial aspects, with a particular focus on the built environment, design and technology. Her recent books include *Atmospheres and the Experiential World: Theory and Methods* (2019) and *Experiencing 11 November: Commemoration and the First World War Centenary* (2020).

Didier TALLAGRAN

is an artist. He has been teaching at the Annecy Alpes School of Art since 2002. He founded the Design & Space master's degree in 2008, which he has been coordinating since then. He is president of the contemporary art centre Angle in Saint-Paul-Trois-Châteaux. His work focuses on the question of art in the public space where he deploys

actions and forms in connection with the landscape and the actors of the territories. He questions the status of the image through narrative. Last exhibition: *Les dormantes* (Maison Victor Hugo, Paris, 2015). His current research focuses on the question of the foreland in the catchment areas of three Mediterranean rivers.

Rennie TANG

is a designer and educator based in Los Angeles. As Associate Professor of Landscape Architecture at California Polytechnic State University Pomona she spent the 2019-20 academic year on sabbatical leave in Paris, France, where she was living during the confinement period. Tang's practice-based research focuses on the investigation of choreographic tools and notations as methods for architectural, landscape and urban design. Specific areas of interest are health and well-being, intergenerational play and social cohesion in public landscapes. These research directions are fueled by collaborations with choreographers, artists, movement analysts and occupational therapists. In collaboration with Lisa Sandlos she launched the project *Soma-City* and with Elisa Seidner she designed *KidAbilities Pediatric Occupational Therapy Clinic*. Her teaching methods emphasize topographic manipulation, material exploration and one-to-one scale spatial construction. She is recipient of the 2017 Excellence in Design Studio Teaching Award from the Council of Educators in Landscape Architecture (CELA). www.rennietang.com

Vera Regina TÂNGARI

is an architect and urbanist; Master in Urban Planning with concentration in Urban Design; Ph.D. in Architecture and Urbanism. Associate Professor of the School of Architecture and Urbanism of the Federal University of Rio de Janeiro (FAU-UFRJ); Faculty staff in: Graduate Program in Architecture (Master and Doctorate supervisions - PROARQ-UFRJ); Master Program in Heritage and Architectural Design (Master supervisions - MPPP-PROARQ-UFRJ); and Master Program in Landscape Architecture Design (Master supervisions - MPAP-PROURB-UFRJ). Coordinator of the Open Spaces System in Rio de Janeiro Research Group (SEL/RJ-ProLUGAR); Research grants from National Council for Scientific Development (CNPq) and from State Foundation for Research Support (FAPERJ); Collaborative Researcher of Center for Sustainable Development-CSUD, Earth Institute, Columbia University. Coordinator of the research "Affective Mapping," developed by PROARQ-UFRJ in partnership with the Rio de Janeiro Municipality, which analyzes children's perceptions and desires on their daily journey from home to school.

Judy THEODORSON

is Associate Professor and Interior Design Program Head at Washington State University School of Design + Construction. Her teaching and research interests are broadly around environmental conditions and human well-being. She is director of *Interior Ambiances Lab* which studies conditions of light, space, form, and material to advance understanding of architectural ambiance and the human experience.

Jean-Paul THIBAUD

sociologist, is CNRS senior researcher at Cresson - Research Center on Sonic Space and the Urban Environment, UMR *Ambiances Architectures Urbanités*. His field of research covers the theory of urban ambiances, ordinary perception in urban environment, sensory culture and ethnography of public places, anthropology of sounds, qualitative in-situ methodology, socio-ecological issues. He has directed the CRESSON research lab and has founded the International Ambiances Network. Jean-Paul Thibaud has

published numerous papers on urban ambiances and has co-edited several books on this field of research : <https://cv.archives-ouvertes.fr/jean-paul-thibaud>. His latest book: *En quête d'ambiances. Éprouver la ville en passant* (Genève, MétisPresses, 2015).

Rachel THOMAS

is a Research Director at CNRS Laboratory Ambiances, Architectures, Urbanités (UMR CNRS 1563 - Team CRESSON). She is accredited to supervise research (HDR) in human and social sciences and in urban studies. Her current research program aims at questioning the possibility of formulating a critique of the urban - defined in this work as the way the city, as designed and planned, organises the public life forms and environments - from a focus on ambiances and their transformations. It thus opens up the questioning of urban ambiances to their political dimension. To this end, she coordinates the research group “Ambiances urbaines, critique, politique” : <https://aau.archi.fr/groupe-de-recherche/ambiances-urbaines-critique-politique/>

Bárbara THOMAZ

Architect and Urban Design. Ph.D. in Architecture from the Postgraduate Program in Architecture at the University of Rio de Janeiro - PROARQ / UFRJ, with a doctoral internship at the Center de Recherche sur l'Espace Sonore et l'Environnement urbain - CRESSON. Collaborating researcher in the research group Architecture, Subjectivity and Culture - LASC / UFRJ.

Nicolas TIXIER

is an architect, a Professor HDR of theory and design at The National School of Architecture of Grenoble and also teaches at the Annecy Alpes School of Fine Arts. He is a researcher at the CRESSON team (CNRS laboratory Ambiances, Architectures, Urbanities). He is a founding member of the BazarUrbain collective. From 2003 to 2010, he was responsible for scientific missions at the French Ministry of Culture. Since 2009, he has been president of the Grenoble Cinematheque. Since 2018, he has been director of the CRESSON. The different areas addressed by his research, projects and teaching experiences question what can be called the public sphere and the relations between ambiances and project. He does so by developing methodological tools, both for the approach of a site and for the production and the distribution of representations, or for the enunciation of possible futures.

Edgard TORRES TORRES

is an architect by Universidad de Talca 2015, First place International Archiprix, India 2017 (1, 2), Finalist Golden Pin Concept Design Awards, Taiwan 2017 (3), Honorable Mention International Photography Awards, USA 2019 (4). Currently candidate for Master in Geography at Universidad de Chile.

Vincent TOURRE

is an Associate Professor at Ecole Centrale de Nantes since 2009, in the team CRENAU of the lab AAU. He holds a Master thesis in Computer Science and a Ph.D. thesis in Engineering Sciences. His research interest concerns the visualization of urban data dedicated to urban planning and GIS applications, and the analysis of the morphology of urban public spaces from a pedestrian point of view. He participated into a SME project (EnVIE) about the creation of sustainable indicators (2011-2012) and H2020 project (Built2Spec) about building structure failure detection (2014-2018). He led a CNRS project (LiPaD) about natural light simulation and urban data modeling (2011-2013), and was the co-organizer of the “Eurographics Workshop on Urban Data Modeling

and Visualization” during four years (2013-2016). He is currently involved into a SME project (TyCity) about the use of 3D city models for citizen participation, and a regional project (VisUrba) about the visualisation of urban data.

Gillian TREACY

is currently Programme Director for Interior Design, The School of Design, Edinburgh College of Art, The University of Edinburgh. Gillian is a qualified architect in the UK and has been working in architecture and lighting practice since 2000. She has led international projects achieving awards for design including Scottish Design Awards 2016 winner in Lighting for her own practice. Gillian has been teaching design since 2005 and her recently completed Ph.D. research explores lighting design pedagogy. Her primary research interests lie within the fields of architecture, interiors, lighting and atmosphere with a keen interest in progressing design pedagogy, studio tools and methodologies.

Yorgos TZIRTZILAKIS

is a professor at the Department of Architecture, University of Thessaly and artistic advisor at the DESTE Foundation of Contemporary Art. He has curated several exhibitions, edited monographs, special issues. Among others, recently co-curated the exhibitions *Ametria* (DESTE Foundation, Benaki Museum), *Hypnos Project* (Onassis Cultural Centre, Athens) and participated as Advisor in the *Liquid Antiquity* project (DESTE Foundation, Benaki Museum). He has published the book *Sub-modernity and the Labor of Joy-Making Mourning. The Crisis Effect in Contemporary Greek Culture*. He is currently working with the artist Maria Papadimitriou on the archaeologies of Anthropocene in the area of Eleusis (*Titanomachy*) and preparing the second volume on Sub-modernity in contemporary Greek culture.

Anne-Sofie UDSEN

is a Ph.D. Fellow, Department of Communication and Culture, Aarhus University. Ph.D. project entitled ‘Sound as Design Material’, Cand.it. MA Thesis about communication and externalization of sound-based ideas, and how to use listening as a design method. Through her academic work she has been part of composing and designing sound for interactive museum installations, conducted workshops on experience-driven design, and is currently part of the project ‘Soundscapes in Authentic Buildings’ funded by the Velux Foundations. In her work she focuses on how an understanding of *materiality* shapes the way we think and talk about sound, and how to use experience-driven methods to work with sound as material.

Paula UGLIONE

received the bachelor’s (1992) and the master’s (1996) degree in psychology from the Catholic University of Rio Grande do Sul, Porto Alegre, Brazil, and the Ph.D. degree in architecture from the University of Rio de Janeiro (2008), Rio de Janeiro, Brazil, also from the Federal University of Rio de Janeiro. She was a postdoctoral fellow at the University of Rio de Janeiro (2014). She is a Research Associate with the Laboratory of Architecture, Subjectivity and Culture (LASC) at the University of Rio de Janeiro since 2004. She is also a collaborating researcher at the Laboratoire d’Anthropologie Social et Culturelle at the University of Liège, Belgium, since 2018. She is currently living in Belgium, where she develops qualitative research for organizations focused on the socioeconomic development of southern countries.

Heikki UIMONEN

is a Ph.D., professor and principal investigator in project *ACMESOCS. Auditory Cultures, Mediated Sounds and Constructed Spaces* at the University of Eastern Finland. He has published articles, a monograph and edited anthologies on music consumption, radio music, compact cassettes and changing sonic environments. His research interests include sonic construction of place, mediated music, social use of music, transforming soundscape and how all these intertwine. Recently he has examined how combining contemporary audio and video technology can be used in participatory research on sensory environment and how background music can be studied from ethnomusicological premises. Uimonen is the board member of Finnish Society for Acoustic Ecology and was member of COST project standardizing soundscape concept in Europe.

Vahid VAHDAT

is an Assistant Professor at Washington State University School of Design + Construction. His primary field of research is the theory of modern architecture, with an emphasis on non-Western experiences of modernity. He is the author of *“Occidental Perceptions of European Architecture in Nineteenth Century Persian Travel Diaries: Travels in Farangi Space.”* The book has been commended by reviewers for its “compelling and convincing interpretations [...] grounded in archival and architectural evidence.” Prior to joining WSU, Vahid was a faculty at Texas A&M University and University of Houston. His teaching primarily involves explorations in architectural media, including virtual interiorities and filmic expressions of space.

Fanny VUAILLAT

is a geographer and urban planner. She is interested in the ways of living in contemporary cities. She’s currently work about imaginations and representations of space through the experience of childhood in the city. Methodological issues are transversal to her work.

Sophia VYZOVITI

is an architect and researcher. She investigates the impact of emergent socio - spatial practices in the development of new architectural paradigms, addressing the transformations of human habitat in the context of global migratory, fiscal, and environmental crises. In her professional and academic studio, Sophia integrates form-generation methods with participatory design processes, producing architectural and urban design projects, full scale prototypes and temporary installations. Currently Associate Professor at the School of Engineering, University of Thessaly, she has taught at Aristotle University of Thessaloniki, University of Cyprus, National University of Singapore, and Delft University of Technology. Sophia Vyzoviti is the author of *Μικροκατοικία -Ατλαντας για Αρχιτέκτονες* (2017), *Soft Shells-Porous and Deployable Architectural Screens* (2011), *Supersurfaces* (2006), *Emergent Places for Urban Groups without a Place* (2005) and *Folding Architecture: Spatial, Structural and Organizational Diagrams* (2003).

Malte WAGENFELD

is a designer, curator, researcher, installation artist and academic whose experiential installations, designs and texts have been internationally exhibited, distributed and published. As well as designing physical ‘things’ his practice investigates how to design the ‘immaterial’, in particular the design of interior climates and atmospheres; exploring experiential encounters with air; breezes, humidity, temperature, sound, light and smell. Dr Malte Wagenfeld is Senior Lecturer of Industrial Design at RMIT

University, Melbourne Australia. Recent projects include *Outside_IN* (2018): an environment of dual interacting atmospheres which morph to create a microclimatic spectrum. The exhibition 'Dynamics of Air' (2018), curated with Jane Burry: an international survey of commissioned projects exploring the beauty, dynamics and sensuality of air. Instrument designs for Polar Force (Speak Percussion 2018 - 2019); an internationally touring live performance where natural phenomena are manipulated to capture the sounds of the Antarctic regions in context of climate change.

Izabela WIECZOREK

is an architect, researcher and educator, currently a director of the Master of Architecture Programme at the University of Reading. She holds a MSc in Architecture and Urban Design from Politechnika Krakowska, and a Ph.D. in Architecture from Escuela Técnica Superior de Arquitectura de Madrid. Izabela's research is situated at the nexus of academia and practice, focusing on sensorial, affective, performative, and ecological aspects of Architecture. From 2003 to 2017 Izabela was a co-director of the award-winning architectural office Gálvez+Wieczorek. Since 2017, she leads Atmospheric Architecture Agency - a research-based experimental practice that engages with historiography and methods of atmospheric design, exploring its environmental, societal and political significance as well as implications for architectural practice and pedagogy. Izabela's work has been presented, published and exhibited internationally, including Works+Words Biennale of Artistic Research in Architecture at the KADK in Copenhagen, and #Becoming, the Spanish Pavilion Exhibition at the XVI Venice Architecture Biennale.

Cândida ZIGONI

is an architect and Urbanist graduated from the Federal University of Rio de Janeiro/ UFRJ (2019), with master 1 at the École Nationale Supérieure d'Architecture de Toulouse (ENSA) in France (2018). Researcher collaborator at the Laboratory of Temporary Interventions and Tactical Urbanism (LABIT) - Prourb / UFRJ (2016) where developed interests about process of urban analysis and collaborative design. Developed an ephemeral intervention called Women's action of urban Guerrilla, part of a Final Undergraduate Studio at the Faculty of Architecture and Urbanism - UFRJ (2019). Feminist, researches the gender issue, the concept of ambiances and temporary interventions as a path to the process of re-sensitizing cities. Experience in the area of architecture and urbanism with an emphasis on urban analysis, tactical urbanism and design processes.

Fabiola do Valle ZONNO

is a Ph.D. and M.A. in Social History of Culture, in the field of History of Art and Architecture, Specialist in Communications and Image, Architect and Urbanist. Professor at Federal University of Rio de Janeiro (UFRJ) - Faculty of Architecture and Urbanism/ Department of History and Theory of Architecture. Professor at Master and Doctorate Program in Architecture (PROARQ) and at Professional Master of Architecture and Heritage. Coordinates the research: "In between art, architecture and landscape - theory and critics of contemporary complexity" dedicated to the theme of architecture's expanded field, working on the relations between artistic processes, body experience, memory, and city aesthetics. Author of the book: *Lugares complexos, poéticas da complexidade - entre arquitetura, arte e paisagem* (2014).

01

ATMOSPHERE, ANTHROPOCENE, URBANITY, SENSITIVITY

02

ARTIFICIAL LIGHTING AND DARKNESS IN
THE ARCHITECTURAL AND URBAN PRACTICES

03

ATMOSPHERES + DESIGN

Atmosphere, Anthropocene, Urbanity, Sensitivity

Session 1 – Introduction

Niels ALBERTSEN¹,
 Suzel BALEZ²,
 Laurent DEVISME³,
 Jean-Paul THIBAUD⁴

The rise of the contemporary city with the many names: endless, limitless, porous, network, ubiquitous, città diffusa, metapolis, Zwischenstadt, ortlose Stadt, planetary coincides with the Great Acceleration that takes off from about 1950 and shows exponential increases in a range of socio-economic as well as Earth System indicators.

Many geologists consider this take off the beginning of the Anthropocene, i.e. the period in the geological history of the Earth, where human forces have become 'natural forces' influencing the planet Earth in unprecedented ways, disastrously as with climate change caused by greenhouse gasses. Seen this way contemporary urbanity and the Anthropocene have developed together, but not only this. Cities have also been a prime mover in the anthropogenic acceleration through increases in the carbon footprints of urban regions in the Northern Hemisphere. Heating and cooling in these regions are responsible for an estimated 35 to 45 per cent of current carbon emissions, while urban industries and transportation contribute another 35 to 40 per cent. Mobility, dispersion, suburbanization, sprawl and expanded infrastructures of contemporary urbanities generate anthropogenic effects. Cities cover only 2 per cent of the world's land surface, but consume over 75% of Earth's material resources.

- Contemporary anthropogenic cities are also the places of a variety of atmospheric experiences in both the meteorological sense and the aesthetic sense. How does this relate to the anthropogenic character of cities? Are there atmospheric experiences coming specifically from the anthropogenic aspects of contemporary urbanities? If so, do they problematize (render obsolete) the distinction between the meteorological and the aesthetic dimensions of atmosphere. Has the weather become one common denominator of both?
- Does the Gaia-hypothesis on the Anthropocene, which understands the Earth as a moving totality of living beings and materials, generate new ways of atmospherically moving people's feelings? Can atmospheric interventions enhance anthropogenic consciousness as indicated by Olafur Eliasson's melting icebergs in his Ice Watch installations in different cities?
- More generally, different spatial devices, in-situ experimentations, scientific, artistic or documentary projects, aim to concretely experience this "new era": observation platforms for landscape change, exploration of places

1. Aarhus School of Architecture, Denmark.

2. AAU-Cresson Lab, France.

3. AAU-Crenau Lab, France.

4. AAU-Cresson Lab, France.

affected by a disaster, exhibition-awareness of the Anthropocene... What can we say about the use of such devices, what is their scope?

- One of the characteristics of the Anthropocene era stems from the difficulty of projecting ourselves. There has never been so much questioning of planning failures, disappointments in planning... If this impacts public policies, it is not unrelated with sensitivities affected by forms of disenchantment and defeatism. We can more particularly observe them in places marked by the Golden Age of Development (the flip-side of which has turned out to be the take-off of the Great Acceleration) and whose future is problematic: seaside resorts, ski resorts and other spheres related to modern spatial design. What do these situated sensitivities tell us?
- The subtle, tenuous characteristics of certain ambient transformations undoubtedly also contribute to the apprehension of Anthropocene. How are these sometimes discrete evolutions perceived and / or represented, playing out at the limits of the phenomenal and often unusual temporal ranges? Can we consider these discreet changes capable of initiating important processes having long creative spans?
- How is the current socio-ecological crisis also and inseparably a crisis of sensitivity to our environments? If our way of being sensitive to the spaces we inhabit is changing, how is sensitivity a particularly relevant entry for thinking about current and future changes in our living environments?

This thematic session has welcomed contributions that venture into this broad problematic searching for arguable connections between atmosphere, Anthropocene, contemporary urbanity and sensitivity. Contributions could be theoretical, empirical, case-oriented, describing and/or advocating possible interventions or already executed ones. The following pages present the outcomes of the call.

The 5 collected papers cross the main stakes that have been summarized. The authors all pay attention to methodological questions for both researchers and artists. For example, **Bisson** reveals the importance of comparing intra-urban ambiances thanks to guided tours made in Nantes, allowing to decipher “interesting points” and “iconic places.” Related to his recent Ph.D., his reflection can be connected to anthropocene considerations that are more the concern of the other papers of the session.

The attempt of an artistic device to develop the common geological consciousness and help make tangible major changes at the scale of the earth is described by **Kellough**: an atmospheric sense of geological time could help to frame the consequences of human actions on a large time scale.

It is a similar “big question” that can be asked to O. Eliasson’s proposal of big pieces of ice being located in european city centres and which is mentioned by **Albertsen** in his reflection on the consequences of the arrival” of both the Metapolis - urban concept elaborated by Ascher in 1995 - and the great acceleration due to our new geological era on the transformation of our attentiveness. What could metapolitan climate policies integrate for enhancing such consciousness? The question is open. The transformation of the awareness to living environments is the main point addressed by **Thibaud**’s paper : what are the paths leading to the awareness of environmental issues? Listeners, appreciators, performers, resonators and weavers are put into perspective and their capacities explored for the intensification of sensibility. Clearly this intensification concerns both “powers to perceive” and “capacities to be affected,” traditionnally disjoined.

The horizon of reconciliation between man and the world thanks to architecture is not new indeed but may require new ways. That's what **Balez** explores with an attention to the role of senses, explicitly transferring Sloterdijks thoughts into architecture.

Finally, a methodological tool is explored by **Tzirtzilakis**, **Maragkou** and **Rimenidis**, relying on a dictionary of terms applied to the region of Thessaly, Greece. Such a tool could contribute to build a general observatory of Anthropocene.

A Multi-Dimensional Approach to Ambiance Change Triggers in an Urban Context

***Abstract.** This paper focuses on the issue of ambiance change indicators. A series of guided photo tours was carried out in Nantes (West of France). During this guided tour, inhabitants had to identify the changes in ambiance that they are experiencing. We aim to analyze the indicators that trigger a change of ambiance in an urban environment connected to the density or diversity dimensions that characterize the urban environment. The results show that three levels of understanding of urban environments can be identified: a first level shared by all, a second one shared by social groups, and a last one related to the individual. These three-levels of the inhabitants' definition of urban ambiance anchors enable us to question participation in urban planning.*

Brieuc BISSON¹

Keywords. *Urbanity, Ambiance Change Triggers, Guided Commentary Tours*

Introduction

This paper is based on Ph.D. work defended in 2019 on the issue of “the sense of urbanity: a geopsychological approach.” For Lévy (1993, 1997, 2003), urbanity is a combination of density and diversity, regarded as both morphological and functional or social. In this context, the ambiance is also part of urbanity, because of this combination which can help to characterize it.

However, this definition of urbanity is insufficient. The individual and his specificity are denied. Then a concept needed to be built to approach at the same time morphological, functional or social aspects of the city and individual perceptions of it. Indeed, cities are “building frame that becomes lived personal and collective experience” (Thibaud, Thomas, 2004, 102). The “sense of urbanity” involves these individual perceptions of the density/diversity combination that creates urbanity. This “sense of urbanity,” as an emotional state, is also very permeable to urban ambiance, influencing collective and individual urban representations. The urban ambiance results from the matching of a built setting and an environment, and those who inhabit it as the “sense of urbanity.” Consequently, the urban ambiance is composed of multiple interlocking forms, such as morphological and cognitive elements. Three levels allow to understand the “sense of urbanity”: a collective one, shared by all the people - a social one, shared by groups of people with common characteristics (age, socio-professional category, housing) - and an individual one, which depends of individuals (Bisson, 2019). The main hypothesis here is that the social and cultural framework where the individuals live conditions their perception of urban spaces and then their interpretation of urban ambiances. The question of changes can be studied here perceptive transitions which are according to Thibaud “another mean to account for manifest changes”

1. UMR ESO - Espaces et Sociétés, Université Rennes 2, brieuc.bisson@univ-rennes2.fr

(about ambiances) by “asserting intensity differentials or variations in quality [...] [transitions] make it possible to characterize the articulation of places at the sensitive level” (Thibaud, 2003, 124). So how and why do individuals feel ambiance changes? Here, we focus on the collective level as representative of an inhabitant’s consensus about urban ambiance.

Method

The method of guided commentary tours (Thibaud, 2001), which is particularly used to approach urban ambiance (Thibaud, Thomas, 2004; Thomas, 2010; Thibaud, 2015) was used in the city of Nantes with a variety of inhabitants. The choice of city-place to go along were previously identified in a series of interviews which allowed us to identify Nantes as a recurrent representative city and to select potential “high places” of urbanity², such as the river banks, the historical squares, the commercial streets, or the multi-modal poles. This method captures in-situ individual feelings that are built by urban ambiance.

The Routes

Three routes in Nantes were selected. They have been configured so that they vary in terms of the urban ambiance and according to the combination of density and diversity (morphological, social and functional).

The three route sections were travelled by all participants³.

Instructions and Investigation Conditions

Because of the comparative approach, all the participants were individually surveyed and followed the same instruction.

“We are going to walk from [...] to [...]. You have a camera and we are going to make a route of approximately 2 hours. During the guided-commentary tour, you will be able to photograph urban situations which are representative of a city in general for you and then you have to explain why you photographed this specific urban situation. You will also be able to tell me when you feel an ambient change and describe it.”

Here we focus on the second part of the instruction connected to urban ambiance.

Results

195 ambiances changes were collected.

Collective Level

The collective level of apprehension of urban ambiance means some ambiance change triggers which are shared by almost all the people, regardless ages or social belonging. Here, it is interesting to note that the ambiance change triggers noticed by the respondents are mostly focused on morphological or functional dimension. Social ambiance changes triggers as “the Versailles island square is quieter than the inner-city area, with less social density” (Hbt 15) are rare. This relative lack of social density triggers is also relevant in the results of the guided commentary tours to

2. Results from 21 interviews carried out with researchers in different disciplines social and territorial sciences.

3. 52 tours have been completed in 2015 - with 12 men and 30 women - living in different areas of Nantes.

characterize what is the city, but it is more surprising for the ambiance. The collective level is mostly characterized by sound and morphological aspects. If we analyze each route, we can identify different places which are iconic to a collective apprehension of changed ambiance.

Route 1

Contextual highlights

- Quai Barbuse, with barges, end of first route
- Versailles island pedestrian bridge
- Banks of the Erdre, reorganized at the early nineties – coexistence of tram, pedestrian, bikes, cars
- Roger Salengro square, prefecture square, parking
- King Albert street, cosy residential building
- Cathedral square, beginning of the course

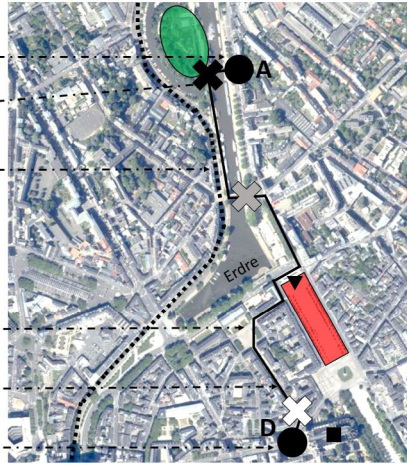

I - Interesting points

- St Peter cathedral
- St Peter square, carnival in spring and autumn
- ▼ War Memorial
- Versailles Island Park
- Tram line 2

II - Iconic places of atmosphere change in the results

- ⊕ Entrance into King Albert street from the cathedral square
- ⊕ Arrival on the St Mihiel bridge – opening on the Erdre
- ⊗ Entrance on the Versailles Island Park from the banks of the Erdre

Figure 1. Route 1: Inner city-centre

Here three places are raised by the respondents to identify two thirds of the ambiance change on the inner city route. For these three places, it is the entry into these three places that triggers the discourse about ambient changes. For the King Albert street, it is always the calmness felt in the streets compared to the cathedral square. For the St Mihiel bridge, it is the presence of the river with the wind and the green connected to it. And for the Versailles Island park, it is the quietness of the park compared to the Erdre banks. In the first and the last cases, the ambient change is mostly connected to the reduction of urban noise. And for the second case, it is connected to a morphological change, with a large opening in the urban landscape.

Route 2

Contextual highlights

- Desaix street, busy street lined with trees
- Bonnefoy and Ronarc'h streets, residential streets
- Drouet street, transition between commercial street and residential area
- Joffre street, commercial street
- Foch square, beginning of the second route

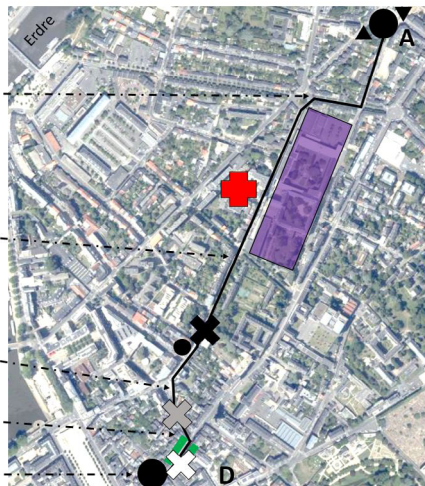

I - Interesting points

- Joffre street, commercial street, event « Le Voyage à Nantes » in July and August
- Bar « Le Brocéliande »
- Livet highschool
- Brétéché clinic
- ▲ Equestrian statue of Jeanne d'Arc
- ▼ St Donatien church, that burned in June 2015

II - Iconic places of atmosphere change in the results

- ⊕ Joffre street
- ⊕ Drouet street
- ⊗ Bonnefoy street

Figure 2. Route 2: Nearby city-centre

The first iconic place is here the Joffre street (departure of the second route). Here the respondents noted the Joffre street as an important ambient change compared to the first route. This changes are especially related to significant trade concentration in the Joffre street, with a high diversity of shops. After the two other important places are part of a gradation of exit of the city center and entering in a more residential area. For those streets, the main important markers of ambient change are (again) the reduction of noise and the morphological form (individual housings after the old building of inner city center). These major ambient changes are all localized at the beginning of the second route. Indeed, from the Bonnefoy street, the second route is localized in residential streets without major ambient change.

Route 3

Contextual highlights

- Haluchère, end of the routes
- Robic street, building of the 80's and 90's
- Pin Sec, large housing estates of the 60's and 70's
- Nancy street then Pilotières boulevard, individual housing, residential streets
- Jules Verne boulevard, beginning of the third route

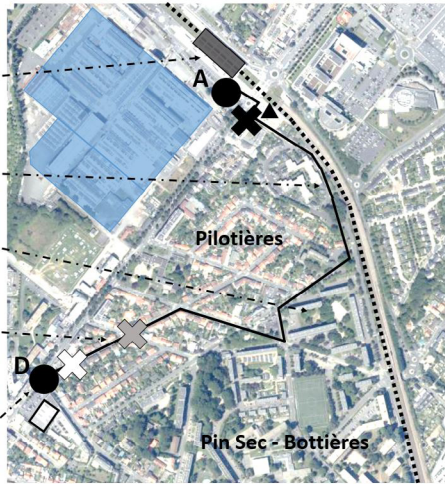

- I - Interesting points
 - Mall, Lidl
 - ▲ Wasteland, old station of Haluchère
 - ⋯ Tram, line 1
 - Multi-modal terminal of Haluchères (bus/train/tram/cars)
 - Batignolles factory
- II - Iconic places of atmosphere change in the results
 - ⊗ Chocolaterie bus stop
 - ⊗ Nancy street
 - ⊗ Haluchère multimodal terminal

Figure 3. Route 3: Far city center

Lastly, we can note on the third route a rupture between this route and both first routes. For inhabitants, this route is as an intermediate place between city and something else, where they perceived ambient changes. The perceived ambiance is very different with a low density of urban construction and then a low level of noise. Except the third important place, the Haluchère multi-modal terminal, which is associated with a human density and noise. On these tour, it is quite strange to note that the Pin-Sec Bottières area with its important buildings of the 60's are not much cited. Then the collective level of apprehension of urban ambiance is here highly connected to morphological-sensory combination connected to the noise of the city (noise produced by a more or less human density and by the mechanical noise of the transport - tram, cars, train).

This collective level is probably the most interesting for the urban planning. From these results, and taking into account the necessary precautions, it seems that the inhabitants are very sensitive to the issue of calm, heard in an appreciative sense. The combination density/diversity is mainly focused on a cognitive soundscape composed of a combination of morphological, sensitive and functional elements. The functional elements (commercial street or residential street - with their morphological and sensitive components) are also a strong ambiance trigger for the inhabitants.

Discussion: The Lack of a Social Level?

The results of ambiance change triggers analysis do not reveal a social level of apprehension. Here it seems that the social level is strongly connected to the collective level. The weight of this collective level is stronger than social level. It implies a form of consensus in the apprehension of the urban ambiance changes and appreciation of it.

However, the individual level represents the part of fragility of urban ambiances (Thibaud, 2018). Here, it is mostly connected to appreciative experiences of the places, or to an unexpected event. It is particularly connected to the places of life of individuals, “from this point we enter in my stronghold” (Hbt 8 when we enter in the Bonnefoy street). It is also for example a participant who reports “I don’t like Joffre street ambiance, it’s dirty and it stinks” (Hbt 52) while another individual notes that “Joffre street ambiance is very pleasant, I often come for a drink, it’s like if we are in Paris” (Hbt 12). This level is also related to personal experience of the ambiance. It is here the example of the inhabitant 26 on the second route sensitive to ambiance “in Bonnefoy street we enter in a posh street, two years ago I kept a little girl on this street and it was a posh family.”

The discovery of a new area is also noted by the inhabitants in term of ambiance. For example, the inhabitants 32 in the Bonnefoy street noted that “from this point I am ‘out of geography’ as we say in the Sables d’Olonne, I don’t know this area then I am pleasantly surprised by the ambiance, it is calm and nice.”

Then individuals are themselves actors of the changes of ambiance that they feel.

Conclusion

The results of this survey, by focusing on the collective and shared dimension of the perception of ambient changes may be discussed on two points. First, the relative lack of social distinction in the perception of urban ambiance seems to reveal a kind of consensus on urban ambiance changes. This approach shows the same results of a consensus on positive urban ambiance than other works (Dominique, 2010). By referring to the different theoretical schemes valuable to understand urban ambiance and its apprehension by the inhabitants these results are more in line with the hypothesis of a social consensus on the positive apprehension of calm in the urban ambiance. In this theoretical framework, this consensus built in the 19th century corresponds to the birth of a “bourgeois culture” that is generalized to the whole population (Dominique, 2010, Corbin, 2016). Nevertheless, this consensus does not prevent the individual from being himself creator of his own urban atmosphere by referring to an appreciative dimension or his lived experience.

Then guided commentary tours to apprehend urban ambiances could be useful in concertation process to access to the inhabitant’s representations “in-situ » and not by an interview or a focus group. Indeed, an ambiance is always located from a spatial and representational point of view (Thibaud, 2018) and to approach it in urban planning requires adequate means (to do individual guided commentary tours) and times, that are often missing.

References

- Bisson, Brieuc, 2019, *Au-delà de l'urbanité, une approche géopsychologique du sentiment d'urbanité*, Thèse de doctorat en géographie, Université Rennes 2.
- Corbin, Alain, 2016, *Histoire du silence, de la Renaissance à nos jours*, Paris, Albin Michel.
- Dominique, Luc-Charles, 2010, "Les paysages sonores en question : l'ethnomusicologie à l'épreuve des théories aréologiques", Congrès 2010 du CTHS, "Le Paysage".
- Lévy Jacques, 1993, "Espace intime, espace légitime ? Paris, l'urbain, l'urbanité", In *Politix*, 21, pp.52-64.
- Lévy Jacques, 1997, "La mesure de l'urbanité", In *Urbanisme*, n° 296, pp.58-61.
- Lévy Jacques, 2003, "Entrée Urbain (modèle)", In *Dictionnaire de la géographie et de l'espace des sociétés*, dir. Lévy Jacques, Lussault Michel, Paris, Belin, pp.952-957.
- Thibaud Jean-Paul, 2001, "La méthode des parcours commentés", In *L'espace urbain en méthode*, Grosjean, Michèle et Thibaud, Jean-Paul, Paris, Éd. Parenthèses, pp.79-99.
- Thibaud Jean-Paul, Thomas Rachel, 2004, "L'ambiance comme une expression de la vie urbaine", In *Cosmopolitiques*, numéro "Aimons la ville", n° 7, pp.102-113.
- Thibaud Jean-Paul, 2015, *En quête d'ambiances : éprouver la ville en passant*, Genève, MétisPresses, 328 p.
- Thibaud Jean-Paul, 2018, "Les puissances d'imprégnation de l'ambiance", Communications, Paris, Seuil, pp.67-80.
- Thomas Rachel, dir., 2010, *Marcher en ville. Faire corps, prendre corps, donner corps aux ambiances urbaines*, Paris, Éd. des Archives contemporaines, 196 p.

Introduction to the Sound Installation “Beyond the Mortal Eye”

On Listening to the Sonic Ambiances of Earth Systems

Bethan KELLOUGH¹

***Abstract.** Beyond the Mortal Eye is a sound-scape work that engages with the concept of deep time and our place within it. Using sounds of geological processes that are perceivable to the human ear, the installation voices a selection of slow, often invisible transformations that connect to and signify the passage of geological time. This installation is an initial practice-based experiment in ongoing research into the role of the sonic ambiances of Earth systems in communication about environmental change. It is designed to open up a space of enquiry and to fuel future research directions. This introduction to the work, by the artist, discusses the ideas behind the development of the installation.*

Keywords. *Sonic Atmospheres, Deep Time, Earth Systems*

Introduction

Many of the geological processes that are continuously shaping and re-shaping our planet are invisible, overlooked or imperceptible to the eye - some are too slow, happening at a pace that far exceeds the human lifespan; some are too small to witness with the naked eye; and others are happening underground or beneath a surface.

But we can hear them. The sound installation *Beyond the Mortal Eye*² explores the sounds of rocks expanding in the heat, wind buffeting and eroding boulders and lava flows, a singing sand dune, the rhythms of pebbles tumbling abrasively in the backwash on ocean shores, meltwater inside a glacier, and the booming and bubbling of hydrothermal vents above a deep hot water reservoir.

These are the sonic ambiances of Earth systems. Their dynamism draws attention to the impermanence of the landscapes we see, and highlights a vibrancy that, even as it emerges in the present moment, points towards the greater context of deep time - an unfolding of events in timescales that are far beyond our human experience.

Can listening to these sounds, then, bring forth an atmospheric experience that may situate us within this unfolding? What might we learn from such a perspective? What is lost and what is gained by ‘collecting’ these sounds and presenting them in another place and time, in a single sensory mode?

The installation was created to raise and engage with these questions, and to open a space of enquiry that is produced through listening to the sonic ambiances of Earth systems. Presented in ambisonic surround sound, the work is designed to situate the

¹ Independent Artist, Los Angeles, CA, USA, contact@bethankellough.com

² *Beyond the Mortal Eye* can be heard at www.bethankellough.com/beyondthemortaleye

listener in a dynamic field of geophony³, in doing so presenting an atmosphere of the unfolding of geologic time. This atmosphere, to follow Gernot Böhme's conceptualization of the term, does not have a particular character or an intended "tone of feeling" (Böhme, 1997, 114), rather the work revels in the fact that these generators of atmosphere intersect a complex array of emotional responses that will become a part of the experience, and are an important element of the human response to environmental change. The space of enquiry that the work creates is open-ended and invites further questioning, development and collaboration across disciplines.

Current Iteration of the Work, June 2020

The current iteration of the project, at June 2020, is a loopable, surround sound installation that may be installed using a multi-speaker system or listened to as a binaural render over headphones. It is accompanied by text that contextualizes the sounds of the installation, in order to guide the listeners in their understanding of the audio. Specifically, it provides knowledge of the sound sources that may be "thought-in" to the aesthetic experience (Hepburn, 1993, 79). The installation currently features recordings from the eight locations outlined below.

- *Kari Valley, Atacama Desert, Chile.*
The Atacama Desert is the driest nonpolar place on the planet, receiving almost no precipitation. The installation features two recordings from here: the sound of rocks making a cracking, ticking sound as they heat up in the sun; and the sound of the wind rising as the temperature drops, listening to its interaction between two parts of a rocky outcrop.
- *Eureka Dunes, Eureka Valley, California USA.*
The Eureka dunes are one of around 40 sand dunes around the world that 'sing' or emit a low resonant drone when activated by the wind under certain conditions. The recordings from these 700ft sand dunes feature the wind blowing the sand across the face of the dune, and the drone that follows.
- *Boiling Springs Lake, Lassen Volcanic Area, California USA.*
Boiling Springs Lake is a part of the Lassen volcanic system. The bright teal lake bubbles and steams in a fairly tranquil way, but in one corner of the lakeshore a number of dark vents emit low frequency rumbles and booms that speak, invisibly, of the greater hydrothermal system buried beneath the surface. The installation features three recordings from this area.
- *Rialto Beach, Washington, USA.*
The sound of the backwash on Rialto Beach on the Olympic Peninsula in Washington is quite remarkable. As Gordon Hempton describes, "the stones arrange themselves in tonal bands, the result of having been swept and stroked by countless fingers of winter's storm waves" and the rolling waves produce "a deep operatic breath, then a brief pause before roaring applause" (Hempton and Grossman, 2009, 29; 269). The recording in *Beyond the Mortal Eye* listens to the symphony of the pebbles both above and below the waves.
- *Mojave Desert, California USA.*
In many granite boulders in the Mojave, hollows and pits, called tafoni, appear in the surface, caused by various weathering and erosion processes, including acidic subsoil weathering followed by erosion of the soil layer to reveal

3. Geophony is defined by Bernie Krause (Krause, 2016, 2) as non-biological natural sounds, differentiated from biophony (non-human biological sounds) and anthropophony (human-made sounds).

the pitted surface (Trent and Hazlett, 2002, 42-43). When the wind whips through these features the sound resonates in these pits, sometimes with a discernible pitch, as well as with interesting textural qualities. Recordings made at two different structures are featured in the installation.

- Selatangar, Reykjanes Peninsular, Iceland.
The rough shapes of the black lava, and the design of the structures built from it in the abandoned village of Selatangar, provide a rich sounding board for the stormy winds that cut across the region. The recordings feature these winds buffeting the rocks, contributing to the ongoing reshaping of this active landscape.
- *Toftestallen, Toftøy, Norway.*
The disused wave power station in Toftestallen features two walls that channel waves through the narrow gap between them. It was damaged in 1991 and as the North Sea waves continue to crash into it, the structure is slowly being broken up by the power it was built to harness. The recording utilized in the installation foregrounds stones that have collected in the channel, tumbling back and forth with the rhythm of the waves.
- *Skaftafellsjökull, Iceland.*
Skaftafellsjökull is a glacier tongue connected to the largest ice cap in Iceland, Vatnajökull. The sound featured in the installation is meltwater and embedded stones dropping into a pool of ice-melt, recorded in a small space underneath a roof of ice.

Toward a Geological Consciousness

As Bjornerud (Bjornerud, 2018), Wood (Wood, 2019), and others have suggested, comprehending our place in geologic time is important in understanding the complex reach, far into the future, of the impact of today’s environmental policy and decision-making. We live within, and are part of, biogeochemical systems that have different speeds and rhythms of change often out of sync with the human life-span, but that are critical to our existence. A portion of humanity is already having an increasingly significant impact within these systems in a way that is unsustainable and damaging, and the extent of the damage already inflicted is something that will be revealed at different points in time, from immediate consequences to far into the deep future.

In exploring this polytemporal⁴ element of our existence, an atmospheric sense of geologic time can complement the scientific knowledge about the history and future of our planet, imbuing sometimes incomprehensible numbers and ideas with an affective quality, and therefore a sense of connection between lived experience and deep time. There have been a number of explorations of deep time across different artistic disciplines that have shown the possibility of these connections. The 2014 exhibition *Imagining Deep Time*, organized by the Cultural Programs of the National Academy of Sciences, collected a variety of these contributions together. These included Rachel Sussman’s *The Oldest Living Things in the World* - a photographic exploration of objects older than 2000 years - and sound duo Semiconductor’s *Subterranean (Seismic Blues)* (Talasek, 2014). The latter translates seismic ambiances into sound so we can “perceive subterranean movements that are normally beyond the realm of our experience”⁵. This work demonstrates the potential of sound in revealing Earth processes

4. Bjornerud (Bjornerud, 2018, 179) calls for a “polytemporal worldview” that takes into account these different rates of change and consequence.

5. See: <https://semiconductorfilms.com/art/glacial-seismic-data/>

and imbuing geological structures with a sense of movement and temporality. Other audio works that have engaged with the idea of geological transformation include Jez Riley French's *Dissolves*, which she listens to "the sound of mineral, ceramics and civil structures dissolving through the actions of acid rain, neglect and performative techniques"⁶; and Raviv Ganchrow's exploration of geological sources and shaping of infrasound (Ganchrow, 2015, 191).

These artworks point toward a "geological consciousness" - a concept positioned by Wood as the state of "bearing the significance of deep time" (Wood, 2019, 29). Bearing this significance - understanding how deeply entangled we are with the past and future dynamics of Earth systems - helps to frame the consequences of today's decisions and actions as irreversible, extending their impact beyond the next election cycle to many generations into the future. Furthermore, an environment of geological consciousness, in which time can be understood as extended, multilayered and non-linear, may house within it a variety of cultural understandings of time and temporality, opening possibilities for dialogue that may shift and de-center some of the narratives that surround these issues, and enable more informed and just approaches to human-led transformations in the face of environmental change.

As an artist, one of the driving forces behind my interest in field recording is encountering the layers of a landscape that sound and listening reveal. The experience in the Atacama Desert of listening to cracking sounds coming from a rock face that looked immobile, solid and permanent was profound, and the process of connecting this experience to other recordings in my collection, and to experiences I later had while listening and field recording, led ultimately to the production of this installation. The specific sound-world that *Beyond the Mortal Eye* explores is the portion of the sonic ambiances of Earth systems that we can aurally perceive in the world, unaided by technology, and with no direct (as opposed to indirect, consequential) human agency causing the sounds that are featured. This is important because it is intended that the atmospheric experience of the unfolding of deep time is not experienced solely through direct contact with the artwork, but is continued into interactions in the life-world. The sonic ambiances of Earth systems are audible all around the world, with no technology required to hear many of them, and each unique soundscape can help to tell a story. The installation is intended as an attunement, an experience that highlights or frames these sounds in a particular way that might impact how the listener hears such sounds in the future.

Research Trajectories and Future Directions

As an initial practice-based experiment, this work is intended as a contribution to a research project that takes the form of an iterative cyclic web, a research method proposed by Hazel Smith and Roger T. Dean (Smith and Dean, 2013, 19-25). This model encompasses and interweaves research-led practice and practice-led research, working with both artistic experimentation and theoretical developments, and valuing the application of each to the other.

This model underpins the proposal that this installation may open up an environment of enquiry that invites participation, comment, and further development outside of its current framework. Certainly, the current scope of the project is limited in a number of ways that prompt further investigation and development - a few of which are introduced below.

6. See: <https://jezrileyfrench.co.uk/dissolves.php>

Firstly, an evaluative and reflective engagement with the questions raised by the creation of this work, and outlined in the introduction to this paper, will provide both a contribution to discourse on the role of sound and art in communication about environmental change, and map avenues for further practical experimentation. I have written elsewhere (Parkes, 2012 and 2015) about presence in the virtual acoustic space, sonic atmospheres and intertwining aesthetic spaces, but the particular application of these ideas to the process of listening to the sonic ambiances of Earth systems is a rich site for investigation that is beyond the scope of this introduction to the work, and requires time for reflection and further experimentation.

Secondly, the biosphere, including human life, is an inseparable part of Earth systems. Sounds of the biosphere are not included in this installation (other than incidentally), as it focuses instead on highlighting the dynamism of non-life components of Earth systems that are less visibly vibrant within human timescales. However, a number of projects, including the activities of the Center for Global Soundscapes, Leah Barclay's *River Listening* project, and the work of Bernie Krause, have demonstrated that sounds of the biosphere are an important indicator of the broad impact of environmental change, and so the deliberate and careful integration of biophony - particularly focusing on where it intersects in crucial ways with other parts of Earth systems - is an important trajectory for this research to engage with in the future.

Finally, the environments heard in this installation are sourced and recorded from the artist's perspective. The project would benefit from the inclusion of other listening perspectives in order to hear a broad representation of these ambiances, and move towards a networked, contextualized, sonic witnessing of geological transformation. Developed in this way, the project might begin to ask: what does environmental change sound like listened to through the sonic ambiances of Earth systems?

Conclusion

This last question returns to the initial aim of the installation: situating the listener within the unfolding of geologic time, to witness the transformative dynamism of Earth systems that operate at various paces toward a complex and entangled future. So, to conclude this introduction, and look toward the future development of the work - the environment of *Beyond the Mortal Eye* is designed to invite and inspire collaboration and conversation, drawing upon the atmospheric experience of listening to the sonic ambiances of Earth systems to generate adaptive and evolving future iterations of the work, its outcomes, and related research.

Acknowledgements

Thanks to Trond Lossius, Chris Watson, Billy, Robert Kellough, and Thierry Cohen who have shared their knowledge of some of the featured recording locations with me.

References

- Bjornerud, Marcia. *Timefulness: How thinking like a geologist can help save the world*. New Jersey: Princeton University Press, 2018.
- Böhme, Gernot. "Atmosphere as the Fundamental Concept of a New Aesthetics." *Thesis Eleven* 36 (1993): 113-126.
- Dean, Roger T. and Hazel Smith. "Introduction: Practice-led Research, Research-led Practice - Towards the Iterative Cyclic Web." In *Practice-led Research, Research-led Practice in the Creative Arts*, edited by Hazel Smith and Roger T. Dean, 1-41. Edinburgh: Edinburgh University Press, 2009.
- Ganchrow, Raviv. "On Long-wave Synthesis." In *The Geologic Imagination*, edited by Arie Altena, Mirna Belina and Lucas van der Velden. Sonic Acts Press, 2015.
- Hempton, Gordon and John Grossman. *One Square Inch of Silence: One Man's Quest to Preserve Quiet*. New York: Free Press, 2009.
- Hepburn, Ronald. "Trivial and Serious in Aesthetic Appreciation of Nature." In *Landscape, Natural Beauty and the Arts*, edited by Salim Kemal and Ivan Gaskell, 65-80. Cambridge: Cambridge University Press, 1993.
- Krause, Bernie. *Wild Soundscapes: Discovering the Voice of the Natural World*. Yale University Press, 2016.
- Parkes, Bethan. "Affective Spatialities in the Acousmatic Arts." In *The Global Composition Proceedings*, edited by Sabine Breitsameter and Claudia Söller-Eckert. 2012.
- Parkes, Bethan. *Sonic Arts Portfolio and Commentary*. Ph.D. Thesis. University of Glasgow Thesis Repository. 2014. <http://theses.gla.ac.uk/7798/1/2014ParkesPhD.pdf> Accessed June 2020.
- Talasek, J.D. *Imagining Deep Time*. National Academy of Sciences Exhibition Catalogue. 2014. <http://www.cpnas.org/exhibitions/imagining-deep-time-catalogue.pdf> Accessed June 2020.
- Trent, D.D and Richard W. Hazlett. *Joshua Tree National Park Geology*. California: Joshua Tree National Park Association, 2002.
- Wood, David. *Deep Times Dark Times: On Being Geologically Human*. New York: Fordham University Press, 2019.

Atmosphere and the Anthropogenic Metapolis

Abstract. This article explores connections between the concepts of atmosphere, Anthropocene and contemporary urbanity. First, contemporary urbanity is specified as Metapolis composed of different assemblies of density and heterogeneity. Second, the aesthetic atmospheres of the European Metapolis are portrayed as intensified in the historical centres and pluralized throughout the Metapolis. Third, the Metapolis is connected to the concept of the Anthropocene identified as the Great Acceleration. Fourth, the atmospheric and the anthropogenic aspects are assembled under the headings of the weather, atmospheric attentiveness to the Anthropocene and atmospheric aspects of Metropolitan climate politics.

Niels ALBERTSEN¹

Keywords. Air, Anthropocene, Atmosphere, Great Acceleration, Metapolis

Introduction

This article explores connections between the concepts of atmosphere, Anthropocene and contemporary urbanity. The idea is: Geologists think of our age as a new geological epoch - the Anthropocene - due to hitherto unseen human impact on the planet Earth, its climate, ecosystems and geology. Concomitantly more than 50% of the Earth's population inhabit cities. Hence, (human) life on Earth and the Earth itself seems profoundly marked by both urbanization and the human impact on the planet.

This entanglement of urbanization and anthropogenic processes also encompasses aesthetic (Böhme, 2001) atmosphere, since atmosphere is a vital aspect of city-life. Further, the Anthropocene is likely to problematize the usual separation of atmosphere as a meteorological concept and an aesthetic concept. Anthropogenic urbanisation does not seem to call for such division.

The article proceeds as outlined in the abstract.

The Metapolis

Whilst a majority of humans became 'urbanites', it also became unclear what city or urban means. Cities were diagnosed as disappearing. In 1991 Françoise Choay proclaimed the death of the city, since the unity of urbs (the physical territory) and civitas (the community of citizens) is gone (Choay, 2006, 168, 191). Other farewells emphasized the loss of clear delimitations of the city from its outside, of centre-periphery structures, and clearly defined urban orders.

¹. Aarhus School of Architecture, Denmark, na@aarch.dk

At the same time, the concept of urbanization was expanded. According to the thesis of planetary urbanisation, for instance, spaces well beyond the traditional city cores and suburban peripheries have become integral parts of a “worldwide urban fabric” ranging from transoceanic shipping lanes to tourist enclaves, the world’s oceans and the atmosphere (Brenner and Schmid, 2011, 12).

If everything is urban, however, nothing is! The concept “fails to refer to anything” (Sayer, 1984, 281). Cities and urbanities apparently disappear conceptually because of too narrow (city) and too expansive (urbanity/urbanization) *conceptions* of both. Is there an “in-between” the two disappearances, a *concept* of city/urbanity that is neither too little or too much? I think there is. Rethinking Louis Wirth’s “minimal” sociological definition of the city paves the way.

Here the famous definition: “For sociological purposes a city may be defined as a relatively large, dense, and permanent settlement of socially heterogeneous individuals” (Wirth, 1938, 8). What should be rethought is “relatively.” By stressing that it is a matter of degree. The city is *more or less* large, dense and heterogeneous; it is a *graduated* phenomenon. Similarly, size, density and heterogeneity do not have to covariate. Urbanities may be large, while densities are low without heterogeneity turning into homogeneity. Graduations include different *compositions* of size, density and heterogeneity.

Jacques Lévy and Michel Lussault have - in explicit continuity with Wirth (Lévy, 2001, 16) - categorised *the graduated city* (my concept) into “geotypes” of varied assemblies of density and heterogeneity. Centralities show high degrees of both: sub- and peri-urban areas have low degrees of density; para-urban areas have low degrees of heterogeneity, and infra-urban areas low degrees of both as the limit case to non-urbanity (Lussault, 2000, 32). Infrastructural mobility networks keep these differentially composed *urban types* accessible and together.

‘The graduated city’ can serve as a *minimal common denominator* for the multiple urbanities of the contemporary city. Citiness is not everything, it has an outside, cf. that cities cover only 2 % of the Earth’s land surface (Pincetl, 2017, 75). Further, the concept does not separate city and urban, and it covers a multiplicity of compositions.

One such composition is François Ascher’s *Métapolis* (1995), i.e. former separated urban areas and landscapes assembled by mobility infrastructures into “vast conurbations” consisting of “dispersed and discontinuous, heterogeneous and multi-polarized” territories, where “the limits and the physical and social differences between city and country become increasingly blurred” (Ascher, 2001, 58). Henceforth, I shall focalize on the different urban types of the Metapolis.

Metropolitan Atmospheres

Atmospherically, the Metapolis “assembles a multitude of ambient places (*lieux-ambiance*), [...] more or less related to each other” (Bourdin, 2014, 112). In European cities this multiplicity often shows a double tendency: the intensification of atmospheres in the historical centres and the pluralisation of atmospheres throughout the urban types. My hometown Aarhus offers an example (see Albertsen, 2013, 227-230 and the references there).

The historical centre presents an *atmosphere of age* where one can sense the city as old without knowing much about history. An *atmosphere of shopping* characterizes it

as commercial centre. The many impressions and differences of dense city life creates *an atmosphere of urbanism*. In recent decades the centre was improved in different ways, intensifying the mix of *atmospheres of age, shopping and urbanism*.

In the suburb three areas, quite similar in terms of income and upper-class settlement, turn out to be different and quite unique in terms of atmosphere. In the Skåde Hills south of the historical centre a “landlord feeling” prevails, in an area called ‘Fedet’ in Risskov towards the North a “Klondike” - like atmosphere prevails, while a small neighbourhood around Stationsgade in the same area shows a strong feeling of community.

Suburbia also exhibits *typical* atmospheres. If we stick to habitation: the neighbourhoods of detached housing with atmospheres of privacy around the house and the lawn; the large social housing estates where atmospheres of standardised ‘neutrality’ have been provided with various devices of homeliness; the low-dense estates with an atmosphere of village-like community, supported by the density of the enclaves, small scale and relative closedness.

In the para- and infra-urban areas a plurality of mixed built-up and landscape constellations show up. A village is surrounded by detached private housing turning the front towards the fields to capture a calm landscape atmosphere. In another village new storey buildings have been implanted, significantly altering the village atmosphere. Around the highway exits atmospheres emerge from constellations of large box-shaped commercial buildings, traffic facilities, mobility and open landscape.

The Anthropogenic Metapolis

The Anthropocene (Crutzen & Stoermer, 2000) is a contested concept. For several reasons, which I cannot go into here. Despite the disputes I shall keep the concept because it has proved a useful umbrella for dialogue among the natural and the human sciences (Zalasiewicz, 2017, 168). I identify it as the Great Acceleration, not to take strong position in the hot periodization dispute, but because it matches the arrival of the Metapolis.

The Great Acceleration denotes the extraordinary growth after WWII in human population and global economy, the increased use of energy (fossil fuels) and expanded industrialization, leading to accelerated environmental change and rising levels of CO₂ in the atmosphere. Humans moved to cities. The annual transport of material by humans considerably exceeded that by rivers into the sea. In the biosphere, species invasions and species extinctions increased globally (Zalasiewicz, 2017, 167).

Louis Wirth defined the city as “settlement,” which presupposes built environments and infrastructures. Seen this way, the city is “a social, ecological and technical system of relatively large size, density and complexity. It contains humans and non-humans, some of which (like pigeons) are living and others of which (like street lights) are not” (Beauregard, 2018, 6). The growth of the human/non-human city was a prime mover in the anthropogenic acceleration, first through the rapid expansion of the “taylorfordo-keynesio-corbusian” (Ascher, 1995, 86) functionally zoned modernist city (1950-1975), then through the expansion of the Metapolis. This was an “environmentally disruptive” process. When “humans are brought together in such large and dense human settlements, non-renewable resources are consumed, land is absorbed, and ecosystems are displaced, disturbed and, at times, decimated” (Beauregard, 2018, 76). Today cities cover only 2% of the Earth’s land surface, but consume over 75% of the material resources (Pincetl, 2017, 75).

Atmosphere in the Anthropogenic Metapolis

The arrival of the Metapolis with its atmospheric multiverse was, then, also an anthropogenic urbanization process contributing to global warming and climate change, affecting the Earth system and deteriorating biodiversity. Both processes influence urban living and one may ask for connections. “After all, elements as diverse as air, water and plants are ambient factors as well as environmental resources” (Thibaud, 2015, 303). One obvious question is the relationship between meteorological atmosphere (climate change) and aesthetic atmosphere. The concept of *medium* helps linking.

Air and the Weather

Aesthetic atmosphere is often said to be experienced directly. Subject and object “melt together” just like when you feel the buzz of a mosquito (Böhme, 2001, 56). However, the buzz would be insensible if space was not filled with air. Air, one can say, is a precondition that as “loosely coupled” medium “without resistance” (Luhmann, 1995, 167, 172) allows the aesthetic experience of directness. Hence, perception always presupposes “a *third term* (my italics) between the perceiving subject and the perceived world” (Thibaud, 2015, 224).

Air is not only a third term between perception and perceived, it is also a third term between meteorological and aesthetic atmosphere. Loosely coupled air mediates both the atmosphere we breathe and the atmosphere we feel. “Breathing the air, we also perceive *in* the air,” without air we would both “suffocate” and be “struck senseless” (Ingold, 2012, 82).

Air is the medium in which different types of weather unfold. Shifts in weather conditions affects the aesthetic atmospheres across the anthropogenic Metapolis, following the seasons as well as shorter-term weather situations. Anthropocene weather conditions may be so strong and all-encompassing (hurricanes, cloudbursts, flooding, snowstorms, heat waves) that they dominate/annihilate the plurality of aesthetic atmospheres. Ordinarily, they modify the pluralities without obliterating their differences.

Atmospheric Attentiveness to the Anthropocene

From an everyday life perspective, the challenges of the Anthropocene may seem so overwhelming and unmanageable that it produces passivity and neglect. Here aesthetic atmosphere may come to help. We “need more than just instrumental, cognitive perception to influence attitudes and behaviour in the direction of responding to the conditions of the Anthropocene. We need to be emotionally affected, to be emotionally touched by those processes, which are already destroying our life supporting world” (Sieverts, 2017, 101). We need, one could say, to feel ourselves feeling the climate conditions. With the *Ice Watch Project* Olafur Eliasson has shown how to make the climate question sensuously present in the Metropolitan context. From 2014-2019 he installed large blocks of ice, cast off from the Greenland ice sheet, in the historical centres of Copenhagen, Paris and London. While melting, these blocks were meant to raise awareness of climate change through a direct and tangible experience of melting arctic ice², thus also gesturing towards global warming and connecting human and geological time scales. Thomas Sieverts emphasizes that the Anthropocene requires the use and reuse of built structures for a much longer period than present practice, which emotional attachments to the heritage of built structures and its preservation can assist (Sieverts, 2017, 103).

2. See at: <https://olafureliasson.net/archive/artwork/WEK109190/ice-watch>

Metapolitan Climate Politics: Atmospheric Aspects

Metapoles have been main drivers of the anthropogenic acceleration and its troubling consequences. Metapoles, though, also provide some solutions. Density, for instance, “saves energy, reduces land absorption, and minimises environmental burdens” (Beauregard, 2018, 80). Highlighting the importance of the concept of nature in urban climate politics, David Wachsmuth and Hillary Angelo aptly distinguish two different types of *æsthetics* in such policies: green urban nature and grey urban nature. *Green* denotes “the return of nature to the city in its most verdant form” emphasizing policy strategies such as “green walls, bioswales, and urban agriculture up to large-scale landscaping initiatives.” *Grey* denotes strengthening the already existing sustainable aspects of cities through policies of densification and efficiency measures. The green *æsthetics* appear as constellations of plants, vegetation and water; the grey *æsthetics* as “electric car chargers, high-tech smart-city infrastructure, and green building design.”

Wachsmuth and Angelo treat this *æsthetics* as ideologies tied to unequal power relations. The “*æsthetic* differences are important because they do ideological work.” They also understand them as signs, as *signifying* sustainability. Things that “look like nature, must be more sustainable than things that do not.” The *æsthetics* of grey signify that sustainable solutions are questions of “sophisticated technologies and expertise” (Wachsmuth and Angelo, 2018, 5, 7, 8). I shall not deny the importance of these ideological and semiotic aspects of Metapolitan climate policies. But this is not the whole story. Ideology and semiotics do not capture the aesthetic atmosphere, the sensuous experiences and moods engendered by green and grey, and as such influencing attachments of everyday urban life, and gesturing towards different or combined ways of living in and with the anthropogenic Metapolis.

Conclusion

Connections suggested for further inquiry: The Metapolis and its many atmospheres has arrived with and as co-generator of the Anthropocene; anthropogenic metapolitan atmospheres blur the meteorological/aesthetic distinction; metapolitan climate politics should be atmospheric.

References

- Albertsen, Niels. “Atmosfærernes by - fænomenologi i bystudiet.” In *Fænomenologi. Teorier og metoder*, edited by Bjørn Schiermer, 215-241. Copenhagen: Hans Reitzels Forlag, 2013.
- Ascher, François. *Les nouveaux principes de l'urbanisme*. La Tour d'Aigues: Éditions de l'Aube, 2001.
- Ascher, François. *Métapolis ou l'avenir des villes*. Paris: Editions Odile Jacob, 1995.
- Beauregard, Robert A. *Cities in the Urban Age. A Dissent*. Chicago; London: The University of Chicago Press, 2018.
- Bourdin, Alain. *Métapolis revisitée*. La Tour d'Aigues: Éditions de l'Aube, 2014.
- Brenner, Neil and Christian Schmid. “Planetary Urbanization” In *Urban Constellations*, edited by Matthew Gandy, 11-14, Berlin: Jovis Verlag, 2011.
- Böhme, Gernot. *Asthetik. Vorlesungen über Ästhetik als allgemeine Wahrnehmungslehre*. München: Wilhelm Fink Verlag, 2001.
- Choay, Françoise. “Le règne de l'urbain et la mort de la ville.” In *Pour une anthropologie*

de l'espace, 165-198, Paris: Éditions du Seuil, 2006 [1992].

Crutzen, Paul J. and Eugene F. Stoermer. "The Anthropocene." *IGBP Newsletter* 41 (May, 2000): 17-18.

Ingold, Tim. "The Atmosphere." *Chiasmi International* vol. 14 (2012): 75-87. <https://doi.org/10.5840/chiasmi20121410>

Lévy, Jacques. "Measuring Urbanness" In *Change and Stability in Urban Europe*, edited by Harri Andersson, Gertrud Jorgensen, Dominique Joye and Wim Ostendorf, 15-25, Aldershot: Ashgate, 2001.

Luhmann, Niklas. *Die Kunst der Gesellschaft*. Frankfurt am Main: Suhrkamp, 1995.

Lussault, Michel. "La ville des géographes." In *La ville et l'urbain, l'état des savoirs*, edited by Thierry Paquot, Michel Lussault and Sophie Body-Gendrot, 21-35, Paris: Éditions de la Découverte, 2000.

Pincetl, Stephanie. "Cities in the Age of the Anthropocene: Climate change agents and the potential for mitigation." *Anthropocene* 20 (December 2017):74-82. <https://doi.org/10.1016/j.ancene.2017.08.001>

Sayer, Andrew. "Defining the urban." *GeoJournal* vol. 9, no.3 (1984): 279-285. <https://doi.org/10.1007/BF00149040>

Sieverts, Thomas. "The Principle of Heritage - Preservation and its Generalisation in the Anthropocene." *disP-The Planning Review* vol 53, no. 1 (2017): 99-105. <https://doi.org/10.1080/02513625.2017.1316576>

Thibaud, Jean-Paul. *En quête d'ambiances*. Genève: Metis Presses, 2015.

Wachsmuth, David and Hillary Angelo. "Green and Gray: New Ideologies of Nature in Urban Sustainability Policy." *Annals of the American Association of Geographers*. 2018. <https://doi.org/10.1080/24694452.2017.1417819>

Wirth, Louis. "Urbanism as a way of life" *The American Journal of Sociology* Vol. 44, no. 1 (1938): 1-42. <https://doi.org/10.1086/217913>

Zalasiewicz, Jan. "Die Einstiegsfrage: Wann hat das Anthropozän begonnen?" In *Das Anthropozän. Zum Stand der Dinge*, edited by Jürgen Renn and Bernd Scherer, 160-180. Berlin: Matthes & Seitz Berlin, 2017.

Sensibilities to Lifeworlds

Abstract. Our ways of being sensitive to the lifeworlds are profoundly changing. A new distribution of the sensible is emerging, giving rise to alternative feelings towards the living. My aim is to explore how sensibility comes into resonance with current socio-ecological issues. Five main forms of awareness to living environments are identified: 1) “weavers” tend to explore new attentions to living beings and to intertwine narratives together, 2) “resonators” tend to attune to ambient milieus and to vibrate to impersonal affects, 3) “appreciators” tend to revisit aesthetically the familiar and to appraise the qualities of everyday environments, 4) “performers” tend to alter ordinary gestures and to explore the powers of bodies, 5) “listeners” tend to pay attention to the ways the world sound and to render audible current environmental phenomena.

Jean-Paul THIBAUD¹

Keywords. *Sensibility, Aesthetic, Narrative, Affect, Gesture, Sound, Attention*

Our ways of being sensitive to the spaces we inhabit are changing. Not only is the contemporary world changing, but our very sensitive relationship to the world is also changing. Whether we think of the growing influence of digital technologies in daily life, the massive movement to aestheticize urban spaces, or the growing concern about the current socio-ecological crisis, everything suggests that we are witnessing a reconfiguration of the human sensorium that involves a new distribution of the sensible and new ways of being affected. In other words, the question of sensibility is a particularly relevant and operative way of thinking about current and future changes in our living environments. It also means that sensitivity is not a simple passive reception but rather a power to intensify and transform our relationship to the world.

Sensibilities in the Making

I propose to focus my reflection on the impact of the socio-ecological crisis we are going through and on the emergence of a new form of sensitivity to our living environment. First of all, it is a question of recognizing the fundamental role played by affects and taking note of our capacity to be affected. In this respect, anxiety, disorder, discomfort, concern or distress are some of the moods that colour our ways of being. It is now impossible to conceal the precariousness and fundamental vulnerability of our condition. Natural disasters and other global pandemics are there to remind us of this, in case we have forgotten. From this point of view fundamental affects infuse our relationship to the world, making us feel less and less at home on earth and accentuating the impression that the ground tends to recede beneath our feet. Glen Albrecht (2005) forged the notion of “solastalgia” to account for the eco-anxiety induced by global climate change. This sense of loss of comfort in the familiar world and homesickness without exile would thus be particularly symptomatic of our

1. CNRS, AAU-CRESSON research lab, jpthibaud1@gmail.com

contemporary experience of the world. At stake here is ontological security, the basic trust we have in the world as it is, as it appears, and as it is supposed to unfold (Giddens, 1991). Moreover, the socio-ecological crisis we are going through is also and inseparably a crisis of the common sensibility in our lifeworlds (Zhong Mengual and Morizot, 2018). Although discreet and generally unnoticed, this crisis of sensitivity tends to impoverish our ability to perceive the richness and diversity of the living world. Robert Pyle (1978) spoke in this regard of the “extinction of experience” that increases our sense of strangeness towards the natural world. It is in such a context of eco-anxiety and crisis of sensitivity that a set of approaches is currently being experimented, which open up the field of the perceptible and explore new ways of being sensitive to living environments. It is as if the damaged world in which we live leads us to revisit the universe of affects, provokes a careful observation at beings and things, and encourages us to invent unusual ways of thinking. There is no royal road to learning to sense and feel the world, no overarching and encompassing paradigm, but rather a diversity of paths that cross to discover in a new light our sensitive relationship to the world. What about attempts to establish an extended and accurate sensitive relationship with the living world? The tentative mapping I draw up in the following sections is intended to show how different traditions of thought are working on contemporary sensibility by giving sense and exploring experience to our lifeworlds. Five constellations of work are identified that make us sensitive to our ways of inhabiting the precariousness of today’s world.

Weavers: Intertwining Narratives Together

A first line of work focuses on weaving stories to show how forms of life are interconnected, composes tangled narratives to account for how worlds manage to make, unmake and hybridize. We can be guided by matsutake mushrooms and learn how to survive in ruins (Tsing, 2015) or follow wolves and try to connect with non-humans (Morizot, 2020), investigate the world of birds and discover new ways of making territory (Despret, 2019) or tell the story about our dog and open up to interspecific socialities (Harraway, 2003). In all cases, the aim is to explore step-by-step the interdependencies and complex assemblages between people and environments, between humans and non-humans. These narratives disregard the major divisions between nature and culture and refer each time to singular situations and original arrangements. The aim is therefore not to construct a grand and general narrative but to make ourselves available to the diversity of living worlds and to bring to light the many ways of inhabiting the earth. The option is then to multiply small stories and intertwine them, to take note of the singularity and variety of the little links that make up the world. Such a perspective implies broadening the scope and range of feeling. This means first of all that feeling is not the exclusive preserve of humans but concerns every living being. If it refers to a capacity to be affected, then it applies to animals and plants as well: when a dog is on alert and detects a danger or when a flower turns towards the light something has been felt. In the world of the living we share a common ability to feel, a common power to be affected. This openness leads to experimenting with new regimes of attention towards the living. Anna Tsing, for example, developed various “arts of noticing” that aim to reveal how various living species are closely intertwined in a common environment. This involves paying attention to the most trivial connections, to the most minute links that weave together the components of an ecosystem. In such works, narratives and writing styles play a fundamental role as they make us feel the composition of lifeworlds and help to intensify our sensitivity to living beings.

Resonators: Attuning to Ambient Milieus

This second line of work deals less with living beings as such and more with their conditions, contexts and environments. The questioning here focuses on forms of envelopment and modes of immersion in an environment. One of the questions asked is how a sensory environment pervades existences and makes life possible. Thus, we can develop a theory of spheres and climatic envelopes in terms of immune systems and life support (Sloterdijk, 2016) or highlight our exposure to meteorological elements and elaborate the idea of weather-world (Ingold, 2011), we can develop an æsthetics of atmospheres and critique the current economy of experience (Böhme, 2017) or bring to the fore the elemental domain to better articulate the materiality with the affectivity of atmospheres (McCormack, 2018). We are dealing with resonators that make sensitive various ways of tuning to an ambient milieu, play on the porosity and interweaving of sensory envelopes, and enable to experience the affective tonalities of situations. It is here more directly the domain of ambiances and affective atmospheres that is at work, mobilizing particular attention to sensory phenomena and impersonal affects, to flows, mediums, membranes and natural elements that compose and sustain a living environment. In this respect, the notion of medium is of prime importance, summoning the air in the first instance, that imperceptible but no less vital medium. Hence, we should not be mistaken: an ambiance is not what one perceives, it is not an object of perception. It is from this which one perceives, which opens up the perceptibility of the world, which enables perception. The quality of the blows and the intensity of the flows thus fully participate in the vitality and tonality of lifeworlds. With resonators, it is a question of the diffused and pervasive characteristic of the ambient environment, and the discreet and molecular nature of atmospheric variations. It is not only a question of perceiving a landscape or measuring an environment, but of feeling situations in common and experiencing the sensory contexture of social life. Such a perspective presupposes an ability to defocus and enter into vibration with the sensory dynamics and vitality of a world in the making.

Performers: Exploring the Powers of Bodies

This third line puts the body, gesture and movement at the forefront of questioning. It is a question of exploring unsuspected bodily powers by relying on singular techniques (Feldenkrais, Alexander, etc.) and original choreographic and artistic practices, or by focusing on impeded or different sensorialities. In all cases, the body routines are put in default in order to open up the field of possibilities in terms of gesture and body interaction with the environment. Here we enter the register of somatics, somæsthetics and ecosomatics in which the human body is experienced from the inside, in the first person. This is how we can propose to rethink ecology and our relationship to environments in terms of gestures (Bardet, Clavel and Ginot, 2019) or to elaborate the notion of minor gestures from autistic perception in order to revisit the ecology of practices (Manning, 2016), use a pragmatist stance to make the body the site of a project and meliorative practices (Shusterman, 2012) or look at Lisa Nelson's tuning scores to explore how it is possible to be in tune with others and one's environment (Damian, 2019). It is therefore on the basis of effective practices, situated performances and destabilising exercises that these variations are developed around the somatic. It is no less than opening up the field of sensoriality by paying attention to the pre-reflective domain of experience, exploring what a body can do and paying attention to microscopic and interstitial phenomena that often go unnoticed. If these propositions start from the body and the potentialities of the gesture, from an attention paid to the proprioceptive and the kinesthetic, it is to better put in variation our sensitive relation to places, to others and to non-human worlds. The body is always here a body-medium in which a renewed ecology of feeling is at stake.

Appreciators: Appraising Everyday Environments

This fourth line of work is more a question of environmental aesthetics. At the origin of these works the question of natural environments and landscapes was central, then a more recent movement developed which opened up to everyday life and ordinary situations. The interest of such a perspective is to be interested in sensitivity in terms of aesthetic appreciation while emancipating itself from the strict register of art. In a way, it is about cultivating a common sensibility by paying attention to objects, places, qualities or even practices that are usually excluded from the aesthetic field and go unnoticed most of the time. Depending on the case, the idea of aesthetic engagement can be developed by emphasizing the practical activity, bodily involvement and contextual dimensions of aesthetic experience (Berleant, 1992) or the capacity of ordinary aesthetics can be tested to enhance the quality of everyday life and serve a truly environmentalist agenda (Saito, 2017), an attitude of defamiliarization can be experimented to escape perceptual routines and reveal the aesthetic components of ordinary life (Haapala, 2005) or a careful attention to surface qualities can be developed to point out the existence of aesthetic qualities that have been completely neglected until now (Leddy, 1995). While this framework is divided between a descriptive and a normative approach, it involves in all cases the issue of moral sensitivity and introduces social, political and environmental dimensions into its field of concern. This attention paid to values and criteria for the appreciation of everyday environments leads to think in terms of the articulation between the aesthetic and ethical domains. This moral sensitivity to everyday environments does not consist therefore only in making aesthetic judgements on the living environments but in implementing concrete actions and leading to proper transformations.

Listeners: Paying Attention to Sounding Worlds

This fifth line of work develops a specifically sound approach. Since the seminal work “The Tuning of the World” by R. M. Schafer, a large-scale movement has developed to listen to the world. There are many and varied proposals in this field, whether we think of soundscapes, sound studies, sound art, acoustemology, auditory culture, or acoustic ecology. It is not only a question of listening to the living environment, but also of thinking about the ecology of the world according to sound, based on what we can hear from it. Sound is at once a sensitive manifestation of the world being made, an original way of accessing reality and a possible framework for thinking about it. In other words, sound opens up a singular ecology in terms of observable phenomena and a sensitive relationship to the world. By way of example, we can take an interest in the world of biophony and the sound universe of animals (Krause, 2012) or in the relationships that exist between sound and weather (Allan, 2017), we can develop an attentive listening of climate change (Burtner, 2017) or propose an ecology of narratives to give voice to water and its manifestations in daily life (Jones, Gorell Barnes & Lyons, 2019). Sound has given rise to the invention of numerous listening devices that both raise awareness of current socio-ecological issues and help to inform certain ecological processes from what can be heard. In addition to soundwalks, field recordings or other phonography that make it possible to be attentive and to document the evolution of sound environments, we are also witnessing the development of sonification and audification devices that make phenomena audible that are otherwise beyond the reach of the human ear (Polli, 2017; Kanngieser & Gibb, 2019). In this respect, sound becomes a formidable translator that manages to reveal, amplify, or intensify the experience one can have of the environments one inhabits. Ecoacoustics is now being talked about at the crossroads of artistic practices, environmental sciences, and human and social sciences.

Conclusion

This brief overview of the various paths leading to awareness of current environmental issues does not pretend to be exhaustive and would require further problematization. Thus, we have only discussed how these approaches take up arguments relating to the living, the elemental, the pre-reflective, the ethical or the perceptible. While there are significant differences between these propositions, there are nevertheless several meeting places that contribute to giving meaning to the transformations of contemporary sensibility. In all cases, it is a question of being attentive to the variations and mutations of the lifeworlds we inhabit, of developing new relationships with the more-than-human world, and of relying on a situated, embodied, shared and enacted conception of the sensory experience. We can also note the central role that the question of feeling plays in these approaches. In this respect, original frameworks of thought should be mobilized, making the plurality of capacities to be affected the touchstone of our relationship to the world and of common sensibility (Whitehead, 1929). These approaches also have in common that they make us sensitive to molecular perceptions, to the infinitesimal dynamics and tiny phenomena that work in the field of the perceptible. This applies to the thresholds of perception, which are particularly tested and open the way to hypersensitivity (Grossman, 2017). Finally, it should be noted that these ways of being sensitive to transformations in the living environment give rise to concrete experiments that intensify the powers to perceive and sharpen the sense of nuances. The emergence of this new form of sensitivity is the result of singular combinations of affects and percepts, powers to perceive and capacities to be affected, vulnerability and vitality.

References

- Albrecht, Glen. "Solastalgia', A New Concept in Health and Identity." *Philosophy Activism Nature*, 3 (2005): 44-59.
<https://search.informit.com.au/documentSummary;dn=897723015186456;res=IELHSS>
- Allan, Jennifer Lucy. "Foggy notion. Sound and weather, and the intermingled senses." *SoundEffects*, 8 (2019): 52-67. <https://www.soundeffects.dk/article/view/115030>
- Bardet, Marie, Clavel, Joanne & Ginot, Isabelle (eds.) *Écosomatiques: penser l'écologie depuis le geste*. Montpellier: Deuxième époque, 2019.
- Berleant, Arnold. *The Aesthetics of Environment*. Philadelphia: Temple University Press, 1992.
- Böhme, Gernot. *The Aesthetics of Atmospheres*. Edited by Jean-Paul Thibaud, New York: Routledge, 2017.
- Burtner, Matthew. "Sounding Art Climate Change." In *The Routledge Companion to Sounding Art*. edited by Marcel Cobussen, Vincent Meelberg and Barry Truax, 287-304, New York: Routledge, 2017.
- Damian, Jérémy. "Somatonautologie. Hacker le problème corps/esprit." In *Habiter le trouble avec Donna Haraway*. edited by Florence Caeymaex, Vinciane Despret, and Julien Pieron, 161-82, Editions Dehors, 2019.
- Despret, Vinciane. *Habiter en oiseau*. Arles: Actes Sud, 2019.
- Giddens, Anthony. *Modernity and Self-Identity. Self and Society in the Late Modern Age*. Cambridge: Polity Press, 1991.
- Grossman, Evelyne. *Eloge de l'hypersensible*. Paris: Editions de Minuit, 2017.
- Haapala, Arto. "On the Aesthetics of the Everyday: Familiarity, Strangeness, and the

Meaning of Place.” In *The Aesthetics of Everyday Life*. edited by Andrew Light and Jonathan M. Smith, 39-55, New York: Columbia University Press, 2005.

Harraway, Donna. *The Companion Species Manifesto. Dogs, People & Significant Otherness*. Chicago: Prickly Paradigm Press, 2003.

Ingold, Tim. *Being Alive. Essays on Movement, Knowledge, and Description*. New York: Routledge, 2011.

Jones, Owain, Gorell Barnes, Luci & Lyons, Antony. “Voicing waters: (co-)creative reflections on sound, water, conversations and hydrocitizenship” In *Sounding Places. More-Than-Representational Geographies of Sound and Music*. edited by Karolina Doughty, Michelle Duffy & Theresa Harada, 76-96, Cheltenham: Edward Elgar Publishing Ltd, 2019.

Kanngieser, Anja & Gibb, Rory. “Sonifying the world” In *Sounding Places. More-Than-Representational Geographies of Sound and Music*. edited by Karolina Doughty, Michelle Duffy & Theresa Harada, 153-160, Cheltenham: Edward Elgar Publishing Ltd, 2019.

Krause, Bernie. *The Great Animal Orchestra. Finding the Origins of Music in the World's Wild Places*. London: Profile Books, 2012.

Leddy, Thomas. “Everyday Surface Aesthetic Qualities: ‘Neat’, ‘Messy’, ‘Clean’, ‘Dirty’.” *Journal of Aesthetics and Art Criticism*, 53(1995): 259-268.
<https://www.jstor.org/stable/431351>

Manning, Erin. *The minor gesture*. Durham: Duke University Press, 2016.

McCormack, Derek. *Atmospheric Things: On the Allure of Elemental Envelopment*. Durham: Duke University Press, 2018.

Morizot, Baptiste. *Manières d’être vivant: Enquêtes sur la vie à travers nous*. Arles: Actes Sud, 2020.

Pyle, Robert. “The extinction of experience.” *Horticulture*, 56 (1978): 64-67.

Saito, Yuriko. *Aesthetics of the Familiar. Everyday Life and World-making*. Oxford: Oxford University Press, 2017.

Shusterman, Richard. *Thinking Through the Body: Essays in Somæsthetics*. New York: Cambridge University Press, 2012.

Sloterdijk, Peter. *Foams: Spheres Volume III: Plural Spherology*. Los Angeles: Semiotext(e), 2016.

Tsing, Anna. *The Mushroom at the End of the World. On the Possibility of Life in Capitalist Ruins*. Princeton: Princeton University Press, 2015.

Whitehead, Alfred. *Process and Reality. An Essay in Cosmology*. Cambridge: Cambridge University Press, 1929.

Zhong Mengual, Estelle & Morizot, Baptiste. “L’illisibilité du paysage. Enquête sur la crise écologique comme crise de la sensibilité.” *Nouvelle revue d’esthétique*, 22 (2018): 87-96.

At the Edges of the Phenomenal

The Design of Architectural and Urban Ambiances as a Reconciliation Between Ourselves and the World

Suzel BALEZ¹

Abstract. The limits of sensory apprehension can take different forms: phenomena can be so tenuous that they do not necessarily reach consciousness; habit can bring them out as missing; they can also manifest only in a delayed manner, primarily through their sensory consequences; and finally, devices - such as a digital display - can bring them back into the realm of human perception. This paper first seeks to explore their integration into the lived ambiances, especially from the contemporary geophysical and climatological explanations. Then it questions how architecture and urban design can, through new attention to these limits of the phenomenal, contribute to the readability of the world and collective response-abilities at the time of the entry of humanity into the Anthropocene.

Keywords. *Phenomenology, Environmental Design, Gaia Hypothesis, Anthropocene*

Discreet Things at the Time of Anthropocene

Peter Sloterdijk considers phenomenology as “the narrative science of the explanation of what could initially be given only in an implicit form” (2006, 65). The definition of a new geological epoch can only transform our sensory relationships toward space and time. Ambiances, as situations of specific interactions experienced at a given moment, then resonate with the new fields of knowledge relating to our planet balances.

The question here is how the integration into the lived atmospheres of these contemporary explanations is likely to influence or even transform the conception of places. Can ‘discreet things’ be considered as capable of opening vital successions or as having long staves’ creative effects? At the time of intense and extended anthropogenic effects, discrete, absent, delayed, or revealed sensory events take on renewed importance as potential expressions of the global threat and as drivers of new human (re)actions. The major challenge is to make ourselves more reactive to the consequences of our lifestyles, to increase the relevance and to make felt as more urgent “the knowledge of the place where we reside and the arguments of our atmospheric condition” (Latour, 2015, 184). Drawing on this purpose, the design of places could consider the passage in the field of the explanation of phenomenal limits relating to Gaia’s fragile balances.

From the Latent to the Manifest, at the Edges of the Phenomenal

The *Gaia hypothesis* is a way of designating the Earth as a shared world, unified by a power of “regulation of the physic-chemical environment within limits favorable to life” (Lovelock, 2001, 56). As an explanation, it questions our capacities of perception

¹ CRESSON - UMR AAU, École Nationale Supérieure d'Architecture de Paris la Villette, France, suzel.balez@numericable.fr

and understanding because it may include subtle local expressions.

The modes of attention and potential passages from the latent to the manifest indeed draw different limits, or edges, for the phenomenal, specific to each epoch and each human group. The *discrete phenomenal* corresponds to the tenuous sensations that we experience daily, to “an exposed, soluble, explorable atmospheric character attached to existence” (Sloterdijk, 2011, 126). While walking on a street, ground textures variations under our feet, alternation of light or shadow zones, as well as changes in air velocity on our face, are all tenuous sensations. Even if they often stay on the margins of our consciences, they participate in the pre-reflexive apprehension of the world, resonances of our relations with it. However, under its entry into the field of - ecological - explanation, this limit of the phenomenal is part of a temporal paradox: what is lived discreetly at the moment carries meanings relative to temporal scales (and spatial) so large that they are tough to apprehend.

It also happens that sensory phenomena disappear from our habitual sensory environments. These may include gradual disappearances, such as the clattering of horse irons on the cobblestones of cities at the beginning of the 20th century, or more brutal and episodic, such as the recent sound upheaval of cities hit by episodes of confinement. Here too, our sensory and explanatory interpretations are questioned. ‘De-phenomenalization’ is then part of the ambiance. It manifests itself *en creux* in the plain assessment of the experience *vis-à-vis* the reference to the usual. For example, when, for the first time, we use an electric car or an odorless wall paint, the new sensations are first manifested by shortcomings relating to the reference. Then again, at the time of the Anthropocene, the de-phenomenalizations far exceed the technological obsolescence of human realms, to concern ecological mutations, like changes in soundscapes related to transformations in bird species living in specific territories. The de-phenomenalization thus constitutes a present where all past moments and their variations resonate.

Moreover, within this limit of phenomenal, a paradoxical relation to time plays: the disappearance of some elements is the object of collective amnesia. The *shifting baseline* corresponds to the continuous movement of the normality thresholds: from one generation to the next, whole parts of the sensory environment are engulfed in oblivion. It results in tolerance of progressive environmental degradation (Soga and Gaston, 2018). The issue of new sensory readability, therefore, does not only concern our relations to geological times. It likewise includes the subtle sensory manifestations of the macroscales of what Bruno Latour often calls “Gaia’s clutter” (2015).

On the other hand, there may be a time lag between lived experience and delayed sensory manifestations. Certain sensitive aspects of reality are revealed only after the fact, specifically through their physical or emotional consequences. Exposure to direct sunlight, for example, in addition to the immediate sensation of heat on the skin, has postponed consequences, from a change in skin color to long term accelerated aging. Emotions experienced in specific sensory environments can have long-term echoes² too. As a consequence, a ‘trivial’ sensory stimulus may cause an emotional reaction related to the past situation. This *delayed phenomenal*, emotional, or physical may be related to different time scales. In the same way, the pollution of an ecological environment by an ecotoxic substance can have sensory consequences, immediate (like visible dead plants) but as well in the longer term, such as the modification of its global ambiance (visual, sound, olfactory), resulting from the profound transformation

2. For a description of this phenomenon of evaluative conditioning in the case of olfactory stimuli, see Zucco, 2013.

of the local biotope (Dupouey and al., 1993).

With the phenomenal delayed, the present projects in the future consequences or refers to the past of what was discreet or unnoticed and could then pass as insignificant. It is, therefore, the 'after-the-fact' demonstrations that give it its meaning. Such displays, inscribed in the apprehension of the violent or more subtle transformation of our sensory environments, involve mental health issues³. *Solastalgia*, described by Glenn Albrecht (2005), corresponds, for example, to a melancholy relative to a place that has not been left but whose sensory manifestations are changed.

Sometimes, re-phenomenalization⁴ devices are used to avoid the delayed consequences of specific first in-sensory phenomena. They can either work by "perceptibility rendering," for example, with the odorization of an odorless gas or by displaying measurements of the imperceptible element to be reported (a U.V. index, a fine dust pollution rate...). Through these processes, phenomenology becomes "a restoration of perception after its passing by observation using machines" (Sloterdijk 2006, 72).

Based on the same threat scenarios that led to the transition from latent to manifest for the potential toxicity of air, radioactivity, or microbe (Sloterdijk, 2006, 76), new issues of readability of the world related to our safety, not only bodily but also emotionally, emerge today (Zhong Mengual and Morizot, 2018; Charbonnier, Latour, and Morizot, 2017). The limits of legibility of sensory phenomena then raise new challenges for architectural and urban design.

Anthropocenic Design Issues of the Limits of the Phenomenal

The threats of our time assume that we would be able to integrate the understanding of our actions on the geochemical balances of our planet. It is then for us - humans - to manage to link the sensory and the meaning, to be brought to action. The design of our environment may play such a role, even if the stakes of phenomenological readability are played at scales hitherto unprecedented. These new scales of explanation lead, indeed, to new ranges for the phenomenal: the spatial and temporal shifts to be taken into account, the collectives to be considered to link (in)sensory phenomena and their consequences expand very strongly. As Bruno Latour points out, "the 'nature,' in the classical design, had levels, strata, and you could go from level to level with a well-ordered continuous zoom. Gaia subverts the levels" (2015, 141). Daily, the most discreet aspects of the atmospheres contribute to the spatial and temporal locating of each person. When *Gaia's cutter* is involved, the subversion of levels is active in the design of ambiances. To build with local materials, whether bio- or geo-sourced, is, for example, a way to transcend spatial scales, as earthen buildings have color and odor palettes specific to their territories. On the same line, lighting of today's cities can no longer be thought of in a luminous escalation. Beyond its energy consumption, it has a significant impact on local biotopes, even at a long distance⁵. Reducing the illumination in intensity as well as in temporality should then make it possible to integrate the non-living (reduction of energy consumption and its damaging planetary effects) and the living (the nocturnal fauna) in the overall conception of the night-time luminous ambiances. When no longer limited to human safety function, street lighting plays with the limits of human visual perception.

3. Bruno Latour (2015, 23) evokes madness as an adequate description of the profound alteration of our contemporary relationship with the world.

4. Term borrowed from Peter Sloterdijk (2006, 99).

5. See for example the recent works of Touzot and her colleagues (2020) and of Shier and her colleagues (2020).

Regarding the tenuous phenomena, disappeared or delayed, the re-phenomenalization correspondingly presents significant stakes because they may express Gaia's intermingling. The implementation of such new re-phenomenalizations presents, in fact, the same relevance as when a gas is odorized or when one moves with a Geiger counter: it is a matter of warning so that appropriate actions can be put in place. Allowing humans to understand the extended consequences of their actions in the present is a way to put them in safety in the longer term.

Nevertheless, how environmental design can re-phenomenalize a phenomenon "of prime approach so far away, like the chemical composition of the atmosphere" (Latour, 2015, 185) and especially its evolutions? Some contemporary artworks may offer leads to give an apprehension of long times and help to re-situate individual actions in the collective. Gustav Metzger's pioneering self-destructive pieces are good examples of works that express "long" times. On the same line, the large-scale images of contemporary artist Yves Monnier in the metropolis of Grenoble, appear thanks to giant stencils, through the slow deposition of atmospheric particles and the appearance of lichen. At the other end of the re-phenomenalization spectrum, the city of Copenhagen so displays bicycle counts in its streets. These bike counters inform cyclists of their place in the number of those who passed by that day, relative to the total annual frequentation. Such a count makes it possible to read a collective action, tenuous on an individual scale.

Thus, the materialization of *Gaia's clutter* is a challenge for designers of the environment. For Alberto Pérez Gómez (2016, 175), "today's architecture, even though it is possible only through its past, denies history deliberately to be free of it, responding to Paz's definition of modernity as 'a tradition against itself.'" He calls for architecture to return to its historic role as a guarantor of society's psychosomatic health: "Such [historical] architecture operated by giving place to our embodied consciousness; it achieved this both emotionally and intellectually, by reflecting mimetically the picture of a purposeful universe" (2016, 4). It is not a plea for an architecture or urban planning without form, but on the contrary for (sensory) forms that are bearers of meanings. As Merleau Ponty points out about literature: "we are right to condemn formalism, but we usually forget that what is reprehensible in it, it is not that he esteems the form too much, it is that he esteems it too little, to the point of detaching it from the meaning" (2010, 126). Based on the observation of "the alteration of the alteration of relationships to the world" (Latour, 2015, 23), the "psychosomatic health" described by Pérez Gómez falls within the capacities of the designers of places to respond, in the sense of *responses-abilities* given by Donna Haraway (2016). Forms of re-phenomenalization, such as the highlighting of discrete, delayed, or absent phenomena, can only constitute crucial political and ethical choices. Integrated into the design and management of places, the phenomenal limits of the ambiances could then contribute to the readability of the world, leading to the establishment of mental conditions enabling, in turn, collective mobilizations.

Conclusion: Architecture as a Reconciliation Between Ourselves and the World

In the last volume of his *Spheres Trilogy*, Peter Sloterdijk shows that the need for readability of the world was partly built under threat, especially when air quality began to be at stake. The contemporary passage, in the field of knowledge, of phenomena relating to planetary atmospheric balances, comes now to question their places in that of lived experience.

If an ambiance is an interpretation, in a given socio-cultural context, of bodily sensations linked to a specific cultural and physicochemical context, the 'readability' or

‘invisibility’ related to the passage from latent to manifest, in return, questions this whole. The entry into the Anthropocene challenges our ability to perceive subtle and sometimes decidedly postponed changes in our sensory environments, at scales of time and space that far exceed our ordinary apprehensions. The issue of sensory readability of Gaia’s intertwining is, in-fact, a reconsideration of the spatial and temporal scales of perception of the world, especially in everyday life.

The design of places then goes beyond the most direct phenomenal, to resonate more deeply with the world, through a conception of the non-objective, in a thought of *æsthethics* that refers to its primary meaning as the ability to simultaneously ‘perceive’ and ‘be affected.’ So, under the aegis of Gaia, the conception of places can revert to Juhani Pallasmaa’s definition: “Architecture is the art of reconciliation between ourselves and the world, and this mediation is carried out by the senses” (2010, 81).

References

- Albrecht, Glenn. 2005. “‘Solastalgia’. A New Concept in Health and Identity.” *PAN: Philosophy Activism Nature*, no. 3: 41.
- Charbonnier, Pierre, Bruno Latour, and Baptiste Morizot. 2017. “Redécouvrir La Terre.” *Tracés. Revue de Sciences Humaines*, no. 33: 227-52.
- Dupouey, Jean-Luc, Anne Thimonier, and Bruno Ménette. 1993. “Dynamique de La Végétation et Pollution Atmosphérique.” *Annales de Géographie* 102 (572): 386-96.
- Haraway, Donna. 2016. *Staying with the Trouble: Making Kin in the Chthulucene*. Experimental Futures: Technological Lives, Scientific Arts, Anthropological Voices. Durham: Duke University Press.
- Latour, Bruno. 2015. *Face à Gaïa: Huit Conférences Sur Le Nouveau Régime Climatique*. Paris: La Découverte : Les Empêcheurs de penser en rond.
- Lovelock, James E. 2001. *Gaïa: une médecine pour la planète : géophysologie, nouvelle science de la terre*. Paris: Sang de la Terre.
- Merleau-Ponty, Maurice. 2010. *Le visible et l’invisible*. Nachdr. Tel 36. Paris: Gallimard.
- Pallasmaa, Juhani. 2010. *Le regard des sens*. Paris: Éd. du Linteau.
- Pérez Gómez, Alberto. 2016. *Attunement: Architectural Meaning after the Crisis of Modern Science*. Cambridge, Massachusetts: The MIT Press.
- Shier, Debra, Alicia Bird, and Thea Wang. 2020. “Effects of Artificial Light at Night on the Foraging Behavior of an Endangered Nocturnal Mammal.” *Environmental Pollution*: 263.
- Sloterdijk, Peter. 2006. *Écumes sphérologie plurielle -Sphères III*. Paris: Hachette Littératures.
- . 2011. *Globes : macrosphérologie - Sphères II*. Paris: Pluriel.
- Soga, Masashi, and Kevin Gaston. 2018. “Shifting Baseline Syndrome: Causes, Consequences, and Implications.” *Frontiers in Ecology and the Environment* 16 (4): 222-30.
- Touzot, Morgane, Thierry Lengagne, Jean Secondi, Emmanuel Desouhant, Marc Théry, Adeline Dumet, Claude Duchamp, and Nathalie Mondy. 2020. “Artificial Light at Night Alters the Sexual Behaviour and Fertilisation Success of the Common Toad.” *Environmental Pollution*: 259.

Zhong Mengual, Estelle, and Baptiste Morizot. 2018. "L'illisibilité du paysage. Enquête sur la crise écologique comme crise de la sensibilité." *Nouvelle revue d'esthétique* 22 (2): 87-96.

Zucco, Gesualdo M. 2013. "Quand Les Odeurs Deviennent Des Émotions : Le Conditionnement Olfactif Évaluatif." In *Odeurs et Émotions : Le Nez a Ses Raisons*, edited by Benoist Schaal, Camille Ferdenzi, and Olivier Wathelet, 115-42. Dijon: Éditions Universitaires de Dijon.

Ambiances of Anthropocene on Thessaly Territory, Greece: A Critical Dictionary

Yorgos TZIRTZILAKIS¹,
Afroditi MARAGKOU²,
Yorgos RIMENIDIS³

Abstract. In 20th century, at Thessaly region a series of paradigmatic metamorphoses took place that transformed both the spatial and environmental aspects of this landscape. Focusing on Thessaly's environmental and spatial peculiarities and exploring the region's human footprint this paper proposes a methodology that underlines their significance in the context of Anthropocene. The methodological tool is an ongoing dictionary of terms - textual & visual - exported from the specific territory and contributing to a wider observatory of Anthropocene. The methodology of the dictionary is applied not only as an accredited tool of terminological mapping, but also as a critical interpretation mechanism through which we will be able to perceive current and future changes of our living environments.

Keywords. Anthropocene, Thessaly, Dictionary, Ambiances, Countryside

Introduction

Bruno Latour in his lectures on “the religion of nature” explores what it means to live in the age of Anthropocene, when, what has so far been purely a decorative element in human history, is now the protagonist of this story. The crucial for Latour Gaia (Latour, 2017), is now understood not as a system but as something that has its history, and mobilizes everything within this geo-history. In that sense, if something determines the politics of place, it is the soil, the land, the localities, it is what everyone is working on by building, using energy, using means of transport and with their lifestyle choices. Therefore, the importance of studying a locality and its geo-history can contribute to the establishment of a wider framework for analyzing and interpretation of Anthropocene. At the same time, the redefinition of research tools, which goes beyond the strict framework of geological and environmental sciences, is considered important in order to be able to understand and interpret the crucial symbiotic relationship between mankind and ground.

The region of Thessaly is comprised of four medium-sized cities and a number of smaller residential formations, but also includes the largest section of Greece's arable land as well as a significant part of its overall production activity. This paper perceives Thessaly region as a unique “city-territory” condition, as an expanded metapolis with density variations and hybrid urbanity characteristics. The urban tissues constellations extend beyond the city's boundaries to sparse rural areas with certain infrastructures (roads/highways, bridges, dams), smaller-scale building structures (agricultural cooperatives, warehouses, gas stations, shopping centers) and a vast patchwork of culti-

1. Department of Architecture, University of Thessaly, Volos, Greece, tzir@uth.gr

2. Department of Architecture, University of Thessaly, Volos, Greece, afro.maragkou@gmail.com

3. Department of Architecture, University of Thessaly, Volos, Greece, yorgosrimenidis@gmail.com

vated areas. This hybrid character of Thessaly region, a result of two broader transformation processes: modernization and globalization, is defined by networks in which the above heterogeneous entities are related in various ways, create spaces and emerge atmospheres crucial for study. These atmospheres summarize the paradigmatic transformations, geological and environmental, that the region of Thessaly has experienced and can contribute to the Anthropocene context.

The landscape of Thessaly was the main territorial field for the modernization acceleration of the 20th century in Greece. As the main “productive engine” of the country, Thessaly was characterized by the modernization of agricultural practices, the intensification of agricultural production and the use of increased quantities of inputs (fertilizers, machinery, etc.). At the same time, it was a field of implementation of major technical and land improvement projects, diversion of rivers, dams, drainage of lakes, modification of crops and expansion of monocultures. Therefore, this dominant vision, especially of the 1950s, 1960s, highly modernizing, created an intensified anthropogenic landscape, with a critical geo-spatial and environmental footprint.

Within this research framework, this paper records, in the form of an ongoing dictionary, the local atmospheres produced by the environmental entity of the region of Thessaly in order to contribute to a wider observatory of the Anthropocene. Specifically, seven of the main dictionary entries of this ongoing research are presented here, as an extract. The structure of the dictionary is not only a methodology for recording definitions but also a critical interpretation mechanism. Each entry contains its own internal analysis and structure (Williams, 1983). According to Bataille, “A dictionary begins when it no longer gives the meaning of words, but their tasks” (Bataille, 1929). In this way these tasks can emerge the ambiances of Anthropocene on Thessaly territory.

[...]

Campos

Campos (in greek κάμπος) is the Greek word which in order to be sufficiently attributed in English we shall use the words: fields, valley and countryside (Koolhaas, 2020). It is an extensive, wide region with small fluctuations in altitude differences and low altitude. Campos is defined by the surrounding mountains and the sea. It is mainly a region with low vegetation through which a river system flows. The Thessalian campos is understood as a unified, lowland, arable area, is the largest part of the agricultural land of the prefecture of Thessaly and is delimited within the area defined by the largest mountains of the country. Due to this special geomorphology, in the Thessalian campos is developing the highest temperature of the country during the summer months, a fact that is aggravated by the weak presence of winds, resulting in the creation of a very locally characteristic, dysphoric atmosphere. The main feature of the Thessalian campos is the monocultures: cotton, corn and cereals in vast areas compose a unified landscape, which changes seasonally and into which the largest percentage of water resources in the area is channeled. The continuous watering in the summer months is intensified by private water drilling, drying the underground aquifers and at the same time increasing dramatically the percentages of surface moisture that emerge from the arable land.

Hyper-Humidity

Hyper-humidity (on the contrary of desertification; see entry *Quasi-desertification*) is defined as the increased percentage of moisture that emerges from the arable land during the summer months due to extensive watering. Most private water drillings are

located in Thessaly, which pump the largest volume of water from non-renewable reserves, thus draining the underground aquifer. The image of the campos (see entry *Campos*) is particularly characteristic, where dozens of irrigation systems with the method of artificial rain (injectors) irrigate the areas. The increased humidity in combination with the high temperatures that are developed, create a feeling of discomfort and suffocation.



Figure 1. Hyper-humidity, Yorgos Rimenidis, 27.06.2020

Liquid Urbanity

The liquidity that characterizes Thessaly is located in the vague spatial boundaries between the organized units. The formation of contemporary Greek cities (especially in the region of Thessaly) does not depend on tabula-rasa-type of conditions, as is the case in other countries or territories. It rather depends on accumulation, fragmentation, juxtaposition, polyarchy and superimposing. In this sense we could describe the region of Thessaly as a city-territory, where the high density of urban centers expands with gradual dilutions to the campos (see entry *Campos*), while at the same time in the extensive arable land of the campos are incorporated small unbounded residential settlements.

Mega-Machines

Mega-machines are the technical modernization projects that have shaped and continue to shape the landscape of Thessaly. The infrastructure projects, the dams and even the built environment of the industrial units were designed, constructed and operate as “production machines” (Varnelis, 2008) having as primary goals the coveted development and prosperity of Thessaly. But the relationship of this mega anthropogenic landscape with the territory comes in an invasive contrast, in a borderline condition with a double outcome: On the one hand we have the ubiquitous, dispersed presence of these megastructures in the landscape including the produced visual atmospheres, sound ambiances and micro-environments, and on the other hand their environmental footprint in the landscape of Thessaly.

Meta-Lakes

Meta-lakes are the demarcated areas of stagnant water whose creation is based entirely on human intervention. The main feature of these areas is their changing human-made condition where a piece of land is transformed from a plain into a lake or vice versa. At 14,037 km² of the total area of Thessaly there are seven recorded lakes, five of which are active. The two inactive (Askourida, Nessonis) dried up during the first

decades of the 20th century, in order to be converted into arable land. Of the five active, only two are natural lakes (Zerelia, Tyrnavos Lake). The other three (Karla, Plastiras Lake, Smokovos Lake) are artificial lakes that were created mainly for the irrigation of the crops of the Thessalian campos. Particular interest is found in the two largest of them. Karla as a natural lake in its original state was significantly influenced by human intervention during the second half of the 20th century. The lake goes from its initial state to drainage and later to its reconstruction. It was drained in 1962 in order to make the land available for cultivation, thus achieving the increase of production, however the erosion of the ecosystem and the changes in the microclimate of the wider area, led to the decision of its reconstruction in the first years of the 21st century. Plastiras lake was formed in 1959 as a flood and irrigation project, and today its reserve is used for water supply of Karditsa city, for the irrigation of the campos and for electricity generation. In addition, in recent years the lake turned into a tourist attraction, with activities on and around the lake.



Figure 2. Lake Karla (detail), Yorgos Rimenidis, 05.02.2020

Micro-Machines

A micro-machine is defined as any kind of small-scale built structure and machinery that is used supportively in agricultural production. Micro-machines are integral and iconic elements of the microenvironment of every arable area of Thessaly, every road that runs through them (either rural or main road) as well as many residential areas of the region, since the liquidity (see entry *Liquid Urbanity*) of space and activities is present. From the rural warehouses that protect the private water drillings and the agricultural vehicles (tractors) with their accompanying machinery to the very recent drones that have been recruited for the development of precision agriculture, the landscape of Thessaly is shaped and characterized from those. Whether static or mobile, micro-machines are a unique reality and compose an additional artificial microenvironment.

Quasi-Desertification

Desertification is a process of land degradation that occurs over time in intensively cultivated areas. It affects the earth's ability to produce the services of an ecosystem, such as food production and hosting of biodiversity. The concept of desertification is part of the research studying the context of Thessaly due to the increased use of water resources that takes place, mainly during the summer months, for the irrigation of arable land. This extensive pumping, since at the same time the renewable stocks due to climate change are shrinking, leads to the depletion of the stocks of underground aquifers. As a result, soils go into a critical condition of infertility and the phenomenon of desertification makes the ecosystem unsustainable. Desertification is not currently directly visible in the Thessalian landscape, however studies⁴ show that it is in a state of quasi-desertification, with the first symptoms becoming apparent from the progressive change of the color palette at the sight of a dynamic map (from green to yellow) as well as in the close observation of individual parts that appear cracked-earth phenomena.

[...]

Conclusions

Felix Guattari in his book *The Three Ecologies* states that “Today more than ever nature cannot be separated from civilization and we must learn to think ‘transversely’ about the interactions between ecosystems, the mechanosphere and the social and individual spheres of reference [...]” (Guattari, 2000). The proposed dictionary of Thessaly can also contribute to such a transverse reading. The ongoing recording of critical entries and their interpretive meaning derived from the above locality, can be on the one hand a database, loaded with its own geo-history, and on the other hand an open field of completion, an interpretation framework of wider recordings of an entire era.

Acknowledgments

This research is co-financed by Greece and the European Union (European Social Fund - ESF) through the Operational Programme “Human Resources Development, Education and Lifelong Learning 2014-2020” in the context of the project “Evidence for recording the Anthropocene. Transformations of the countryside of Thessaly through local newspaper archives: 1949-2010” (MIS 5048951).



Operational Programme
Human Resources Development,
Education and Lifelong Learning

Co-financed by Greece and the European Union



4. See: https://sustainabledevelopment.un.org/content/documents/dsd/dsd_aofw_ni/ni_pdfs/NationalReports/greece/Greece_II_Drought_Desertification.pdf (Access: 05/09/2020).

References

- Bataille G. (1929), Formless, (trans. Stoekl A. et al.) *Documents 1*, p. 382.
- Guattari F. (2000), *The Three Ecologies*, (trans. Pindar I., Sutton P.), London and New Brunswick, The Athlone Press.
- Koolhaas R. (2020), *Countryside*, A Report, Köln, Taschen.
- Latour B. (2017), *Facing Gaia: Eight lectures on the new climatic regime*, (trans. Porte C.), Cambridge, Polity Press.
- Rimenidis Y., Tzirtzilakis Y. (2012) Athens Minutes, in *Collecting Architecture Territories - Phase One Report*, New York, GSAPP Books, pp. 132-141.
- Varnelis K. (2008) Introduction, in K. Varnelis (ed.), *The Infrastructural City: Networked Ecologies In Los Angeles*, Barcelona, Actar.
- Williams R. (1983), *Keywords. A vocabulary of culture and society*, New York, Oxford University Press.

01

ATMOSPHERE, ANTHROPOCENE, URBANITY, SENSITIVITY

02

ARTIFICIAL LIGHTING AND DARKNESS IN
THE ARCHITECTURAL AND URBAN PRACTICES

03

ATMOSPHERES + DESIGN

04

BODY, CULTURE, IDENTITY

Artificial Lighting and Darkness in the Architectural and Urban Practices

Session 2 – Introduction

Nicolas HOUEL¹

As a public service taken for granted by populations for its contribution to comfort, identity and the feeling of safety, urban artificial lighting has recently started a renewal process of two kinds: light extinction and/or switching the lamps in favour of energy-efficient ones. The first option faces an outcry regarding the discomfort and the feeling of insecurity generated, while delighting associations and individuals with strong ecological values. The second option does not initiate the expected reduction in light pollution. If it does generate the energy savings that are called for, these could be short-lived. It is undoubtedly the first time since its invention and deployment on a large scale that artificial lighting is so controversial.¹

Largely studied in its geographical (Challéat, 2011; Gwiadzinski, 2014), ecological (Gaston & al., 2018), sanitary (Zieliska-Dabkowska, 2007) or even security-related (Mosser, 2007) dimensions, night remains a space-time explored through political and technical considerations in relation with artificial lighting. The question of the connection to darkness (Edenson, 2013) seems in turn to represent a wealth of resources and knowledge to be discovered. In reply to this, university and institutional initiatives are nowadays in place to study the protocols for the complete or partial restoration of darkness in urban environments (Challéat, Samuel, Lapostolle, 2017; Chhaya, 2012). In a context where, in the western world, artificial lighting is culturally accepted as an identity and security tool, what nocturnal urban landscapes will we eventually design and experience if darkness is partially restituted?

The return of darkness to spatial and societal environments takes different paths. Each author questions the spatial and mental representations in terms of individual cognitive experiences. The observation of the semantic fields evoked by the perceptions of coloured illuminated interiors, the pictorial representations of nocturnal electromagnetic and sound waves captured near Glasson Dock and the opening to the concept of Dark Design illustrate the transversality of the notion of darkness. In their own way, each author contributes to the discovery of the diversity in imaginations capable of accompanying the spatial and societal reintroduction of darkness.

¹. AAU Laboratory, Crenau, France.

Colored LED Lighting as a Primary Interior Spatial Condition

Human Preference and Affectual Response

Judy THEODORSON¹,
Jennifer SCOTT²

***Abstract.** This research explores the human response to colored lighting with light emitting diodes (LEDs) in a space with the intent of understanding preference and affectual response. The research was conducted through photographic appraisal of a single interior space illuminated with monochromatic and mixed colored lighting³. Results indicate that the stimuli of monochromatic lighting (red, blue, green) confers distinct subjective impressions to a spatial setting and, for a number of subjects, prompts memories. When mixed color lighting is introduced, there are preferences for warm colors and consensus that red lighting is energizing. Future studies will replicate this study with in-situ, immersive experiences.*

***Keywords.** Colored Lighting, LED, Lighting, Interiors*

Introduction

For centuries, colored light has been a tool of architects and designers to shape notable experiences in the built environment. With the emergence of inexpensive light emitting diodes (LEDs), there is substantial opportunity for designers to create intentional, expressive, and individualized ambiances in both interior and exterior environments. This research explores the human response to colored lighting as the primary physical stimulus in an interior space. The intent is to understand preferences and appraisal of colored light in order to make informed design decisions.

There is substantial research around color perception that extends beyond aesthetics. Nakashian (1964) theorized that longer color wavelengths such as red and orange are experienced as arousing and warm, while shorter wavelengths such as blue and green are relaxing and cool. Adams and Osgood (1973) published a seminal study of the affective meanings of color that used a semantic differential tool. Findings include the following: red has emotional salience; the blue-green spectrum is more highly evaluated than red-yellow; blue and green are good; red is potent and active; and blue is familiar. This study was cross-cultural and identified differences related to geographic location, climate, religion, and factors related to culture. A literature review by Elliot and Maier (2014) on the psychological aspects of color determined that color has impact on affect, cognition, and behavior. While they found trends, such as that red is powerful, they caution around generalization.

1. Associate Professor, M.Arch, School of Design + Construction, Interior Ambiances Lab, Washington State University, Pullman, WA, USA

2. M.A. Interior Design, Interior Ambiances Lab

3. This research was originally planned as an immersive experience but was interrupted by COVID-19 restrictions

Architectural phenomenology theory recognizes that senses and memory are triggered by environmental conditions, especially light and color. Controllable LED colored lighting is a relatively new technology but is being quickly adopted as a design element that can be used to stimulate senses, trigger memory, and support personal expression. While research is nascent, there is indication that colored lighting as a spatial experience confers a measurable emotional response (Lee, 2019).

This research specifically investigates the following: What is the affectual and preferential response to colored light as the primary spatial condition?

Method

This is a within-subject experiment whereby subjects are presented a series of photographs of colored lighting scenarios and asked to assess each through survey tools and open-ended questions. An experimental space was established with controllable LED colored lighting, both ambient and accent. The space was photographed under various monochromatic and mixed color lighting scenarios.

The subjects (n=41) were recruited through a university design and construction program and screened for color-blindness. Demographics include: 85% female; 25% report having substantial color theory background while 70% report having some background. The subjects' reported favorite colors: pink (21%), green (21%), blue (19%), purple (7%), yellow (7%), red (4%), and no favorite (14%).

Subjects were first presented the monochromatic scenes, in the order of blue, red, green and cool white, and asked to assess each on a semantic differential scale with nine word-pairs (antonyms) selected to appraise atmospheric and spatial conditions (fig. 1). The word pairs are sorted into three dimensions: evaluation, potency, and activity. The subjects were given the opportunity to discuss if they had a positive or a negative association with each scene. Finally, they asked to rank each scenario according to preference.

Next, the subjects were presented four sets of mixed color scenarios: each set comprised monochromatic ambient lighting with three variations of accent light (red, green, blue, yellow). Subjects were asked to rank their preference of each set (fig.2) and to assess on a Likert scale if each scenario was energizing or relaxing (fig.3).

Results

Monochromatic Scenarios

The addition of ambient colored light to a simple interior space transforms the space into an unfamiliar atmospheric condition with distinctive spatial and visual qualities. In the narrative responses, a substantial number of subjects reported that the colored light triggered memory and emotion, perhaps as they sought to make sense of what might be perceived as an alien space.

Of the four colors, the red lighting scenario consistently generated the most consistent and intense responses. On the semantic differential scale, the red space is evaluated as somewhat negative - *unpleasant, bad* - and as highly potent and active, garnering the strongest responses to the following terms: *powerful, warm, confined, tense, flashy, and unfamiliar*. In the narrative discussion, subjects reported mostly negative and ominous associations with red light though there several positive responses:

“It reminds me of almost any movies depiction of hell and while I’m not religious it still makes me uncomfortable”

“Negative because it reminds me of a warning light“

“Positive. Warm, like a hug. Lots of energy, exciting.”

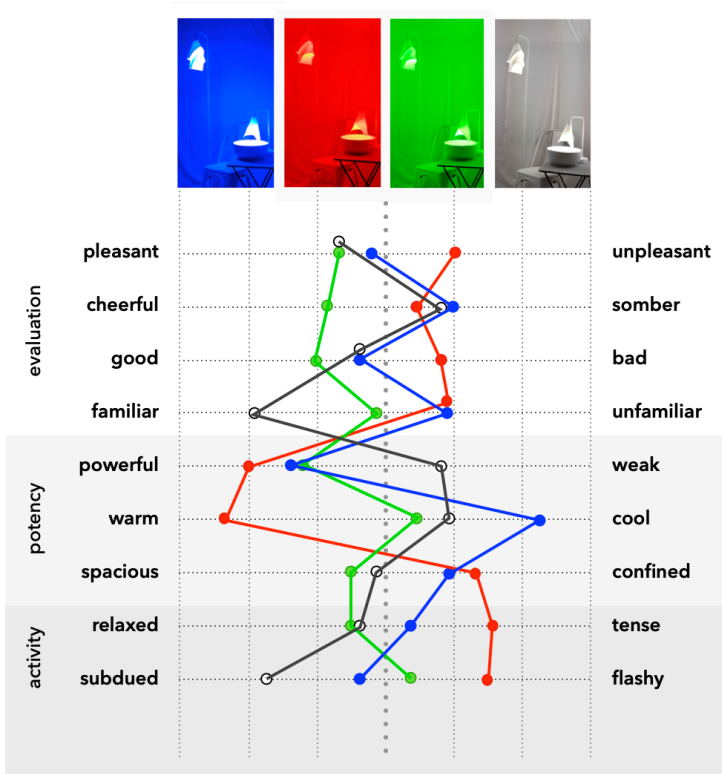

Figure 1. Monochromatic lighting scenarios and semantic differential results

Green light is the most positively evaluated scenario, with the highest ratings on *pleasant*, *cheerful*, *good*. This corresponds to Adams and Osgood’s findings. Additionally, it is seen as the most *spacious* and *relaxed*. In general, the comments leaned toward positive and several noted an association with the natural world:

“I feel more toward positive about green. It is a very strong color in this image but I feel like it could be very soft as well. This color is definitely energizing to me and would make me feel cheerful. It also makes me feel like I am in a jungle.”

“Green is positive. Very natural and familiar. Makes me think of environmental surroundings. Not tense.”

Blue light is strong in potency dimension, appraised as *powerful* and *cool*. It is also seen as *somber* and *unfamiliar*. While color theory suggests blue is a calming color, this was not borne out by the semantic differential. The subjects’ comments are laced with melancholy, references to water, and trepidation although a few found blue calming.

“The blue color displays feelings of sadness, loss, and desire. These feeling [sic] are coming from the light, if the blue was lighter (cyan), the feeling could change in favor for the light.”

“Positive, it’s calming. Feels like floating, like an ocean”

“I am terrified of sharks and drowning and being surrounded in blue makes me panic.”

Mixed Color Scenarios

The intent of mixed color scenarios (ambient and accent) is to explore the potential to create atmospheric conditions that are perceived as energizing or relaxing and also, to gain insight into spatial color combination preferences. The mixed color scenarios offer more dimension and focus to the photographic depictions. When two colors of light are introduced to the space, there is a mixing of the color wavelengths resulting in a shift of colors, primarily affecting the minor color. For example, blue accent light shifts to a purple/pink hue when mixed with red ambient light (fig.2).

Warm accent colors correlate to a stronger preference of the overall spatial condition. In the spaces with colored ambient light, the most preferred accent color is yellow. In the white space, yellow was not an option and red was the preferred accent color. The least preferred scenarios have shorter wavelength colors - green or blue - as the accent color.

Subjects were asked to rate each scenario as *energized* or *relaxed* (fig.3). The strongest predictor of *energized* is the use of red light. The three red ambient light scenes are the rated the highest of the entire group; when red light is the accent color, it rated highest in the set. Spaces with blue light trend slightly toward relaxed; white ambient with blue accent is the rated the most relaxed.

Discussion

The human response to colored light as a spatial circumstance is complex and idiosyncratic. There are clear trends in this study: red is potent, warm, active, and signals threat; green is generally positively evaluated and references the natural world; blue is cool and unfamiliar. However, there are number of divergent responses, for instance green is seen as equally familiar and unfamiliar, and some find red comforting rather than threatening. Given the pool of subjects has exposure to color theory, it should be considered that this knowledge influenced responses. In the case of the blue space, the semantic differential results do not indicate that blue is calming, however three subjects used the word calm in their comments. Were they influenced by color theory that suggests blue is a calming color?

While photography is an accepted method to appraise a spatial setting, there are limitations to photographing a colored light space. It is difficult to control color balance and exposure and to capture the actuality of the colored light circumstance. While the photographs show a spatial situation, the appraisal is likely weighted toward the color of light. D’Andrade and Egan (1974) point out that emotional associations to color are perhaps more related to saturation and brightness rather than the actual hue of the color. The researchers theorize that an immersion experience in a colored light space offers a fuller visual, spatial and sensory experience. Once COVID-19 restrictions have been lifted, there are plans to replicate the study in-situ; this could be a valuable comparative analysis.

Further research might explore the link between color light and the association to

non-conventional or alien spaces such as those noted by the subjects: hell, a jungle, under water, sci-fi films. While colored light is not appropriate for many traditional built environment activities, it offers the potential for expressive exploration, branding, and abstracted interiors. Moreover, this study offer insight into nocturnal urban spaces which are not bound by the constraints of the interior.

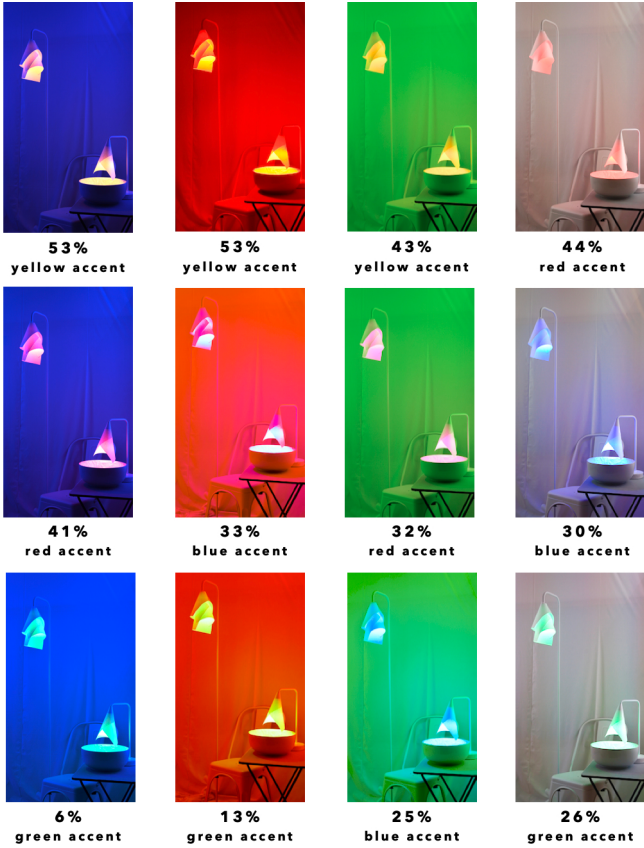

Figure 2. Preferences of mixed colored lighting scenarios

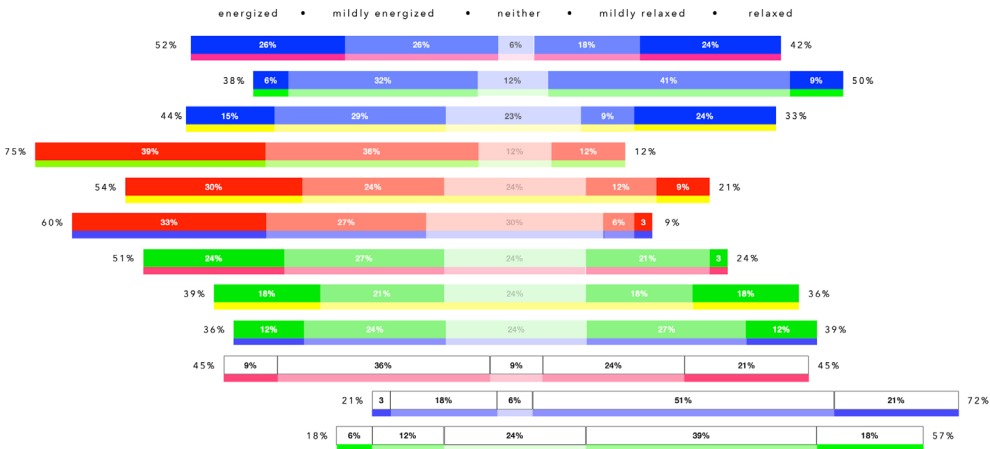

Figure 3. Evaluation of mixed color lighting scenarios as energized or relaxed

References

Adams, Francis M., and Charles E. Osgood. "A cross-cultural study of the affective meanings of color." *Journal of cross-cultural psychology* 4, no. 2 (1973): 135-156.

D'Andrade, Roy, and Michael Egan. "The colors of emotion 1." *American ethnologist* 1, no. 1 (1974): 49-63.

Elliot, Andrew J., and Markus A. Maier. "Color psychology: Effects of perceiving color on psychological functioning in humans." *Annual review of psychology* 65 (2014): 95-120.

Lee, Heejin. *Effects of Light-Emitting Diode (LED) Lighting Color on Human Emotion, Behavior, and Spatial Impression*. Michigan State University, 2019.

Nakashian J S. "The effects of red and green surroundings on behavior." *J. Gen. Psychology*. 70 (1964),143-6

Design Practice as Fieldwork

Describing the Nocturnal Biome Through Light and Sound

Rupert GRIFFITHS¹

Abstract. Human and non-human behaviours are regulated by cycles of light and dark, while many such behaviours can be detected through sound. This article asks how we might use recordings of light and sound to make the nocturnal urban environment meaningfully legible as a more-than-human biome. It reports on several prototypal methods that bring together art/design practices and fieldwork techniques. The aim of this ongoing work is to raise awareness of the night as an ecology, communicate the multiple temporalities characteristic of a healthy biome and provide tools that can inform responsible urban design interventions that improve the quality of the night from a more-than-human perspective.

Keywords. *More-Than-Human, Ecology, Creative Fieldwork, Urban Design, Night Studies*

Introduction

The night time ecology of the urban environment is of great importance to humans, flora and fauna. Yet, when thinking about the quality of the urban environment, the night is often overlooked, and, for many of us, the ecological dimension of the city recedes from view for much of the period between dusk and dawn. Synthesising fieldwork and creative practice, this article considers prototypal methods of bringing into shared public view the often-invisible rhythms of the nocturnal environment - particularly those of biological cues, in this case light, and the corresponding activities of human and non-human life.

Many aspects of the behaviours of humans, flora and fauna are regulated by light (Fonken & Nelson, 2014). Before widespread artificial lighting, the predominate sources of light were the rhythmic cycles of sunlight and moonlight. In contemporary urban and non-urban environments, the anthropogenic contribution of light at night is considerable. This can influence human behaviours, and indeed is often designed to do so, as well as affecting health and wellbeing. Artificial light allows us to work longer, feel safer and express our cultures. Meanwhile, it is also associated with depression, insomnia, cardiovascular disease, and cancers (Chepesiuk, 2009). Similarly, it significantly affects non-human life (Rich & Longcore, 2013), often in unplanned or unacknowledged ways. It disrupts the circadian clock that regulates the physiologies of most organisms (Fonken & Nelson, 2014), affecting, for example, the adjustment of trees to seasonal variations in light, which affects animals and insects that depend on them. It disrupts foraging and predation, altering the balance of ecosystems, and it confuses birds, disturbing migratory routes or causing collisions with buildings (Longcore & Rich, 2004). It is clear that these issues cannot be considered in isolation - an approach that considers the environment as a more-than-human ecology would be more appropriate.

Although there is a large body of research regarding the effects of anthropogenic nocturnal light upon both humans and non-humans, research tends to be focused in narrow disciplinary silos - few studies consider the human and non-human dimensions of light together or the interdisciplinary collaboration required for such an approach (Kyba et al., 2020). This is, in part, because the night tends to be largely ignored as a habitat in the social sciences (Edensor, 2017), and approaches to artificial light tend to be dominated by issues of human safety, security and cost. Furthermore, despite the abundance of data available in our daily lives, we know relatively little about our immediate environment, particularly the nocturnal environment (Dunn, 2016). There are few methods for describing the nocturnal environment as a biome, particularly when considering the broad audience of stakeholders within urban environments.

An Applied Poetics of Data

New methods are needed to capture and communicate the qualities of the nocturnal environment in a language that can speak to diverse groups and interests. This paper proposes an approach - an applied poetics of data - that collects and disseminates environmental data in ways that extend the imaginative framework through which the night is perceived, particularly as a more-than-human (Whatmore, 2002) ecology. This approach does not seek to instrumentalise data, but rather to engage an audience in the spatial, temporal and imaginary realms that emerge through the multitude of biological, meteorological, geological and cosmological processes that we are held within. This approach is concerned with what Whatmore describes as “rhythms and motions of inter-corporeal practices [which] configure spaces of connectivity between more-than-human life worlds” (p. 162). It emphasises the topological over the topographic - i.e. relation over proximity - and is intimate and affective in its concern with the interrelations among life and land and how these emerge as a shared ecology.

Art and design practices, such as David Bowen’s *Telepresent Wind*¹, Thijs Biersteker’s *Symbiosia*², Zach Poff’s *Pond Station*³, or Jem Finer’s *Score for a Hole in the Ground*⁴, are examples of how environmental data can be transformed into visual and material forms of poetry that give observations, ideas and affects mobility. Through sensory experience, such works encourage people to inhabit both real and imaginary dimensions of the environment. This is valuable when considering a more-than-human perspective that cannot be directly perceived through human eyes but can, to some extent, be inhabited imaginatively. Such practices offer a template for communicating environmental data in a compelling manner that acknowledges both human and non-human sensoria, experience and agency. They move away from the instrumental aesthetic representations of data visualisations towards poetic expression (see Koblin, 2012).

1. Using sensors and actuators, the movement of a dried plant stalk in the wind at an outdoor location in Minnesota is replicated in real time across an installation of dried plant stalks in a contemporary culture centre in Bilbao (<https://www.dwbowen.com/telepresent-wind>)

2. Biersteker collaborated with professor Stefano Mancuso to create an artwork that reveals the symbiotic relationship between trees and their communication in relation to climate change (<https://thijsbiersteker.com/symbiosia>)

3. Pond Station is a modular platform that monitors and transmits data related to the hidden activity of a freshwater pond in New York (<https://www.zachpoff.com/artwork/pondstation>)

4. Finer installed a camera in a tree and left it recording for two years, capturing 18,000 photographs as the view transitioned through the seasons. Lying somewhere between a film and a photograph, *Still* is a generative sequence of these images composed in real time such that every viewing of the work is different (<http://www.scoreforaholeintheground.org>)

The former has a specific message - the data visualisation *Show Your Stripes*⁵, for example, intuitively and urgently communicates the increase in global temperatures that has occurred since 1850. Meanwhile, the latter seeks dialogue and reflection with and among its audience - for example, Jem Finer's *Score for a Hole in the Ground* gives us a nuanced, embodied and open-ended engagement with the environment. The former strategy assumes us to be instrumental consumers of data, whereas the latter assumes us to be participants in the process of observation and interpretation - more akin to Ingold's understanding of landscape as dwelling (Ingold, 2000). This approach asks us to use our bodies and senses to inhabit the environment physically and imaginatively and our relationship to it. Such works also encourage us to become attentive not only to spatial and temporal dimensions of the landscape, but also that which is not captured by data, the excess that escapes description (Dewsbury et al., 2002). This paper is concerned with these types of approach.

Methods

There are a number of methods I am experimenting with in this vein. This article will briefly describe two and provide illustrations of each before going on to discuss the longer term aims. The examples presented here was mostly recorded close to Glasson Dock, which sits on the River Lune estuary in Northwest England. One method records the variation of visible light over the night and day, while the other records variations in wide-spectrum sound. The underlying rationale is that light is a driver of behaviour in the environment, whereas sound is a proxy for behaviour.

The first method uses a lens-less photographic technique that combines stop-frame animation and slit-scan photography to record changes in ambient light over time. Figure 1a shows a four-hour period over the transition from day through civil, nautical and astronomical twilight and into night. This light recording can be considered as a datum against which to read behaviour - a datum that is perhaps more obviously associated with non-human than human activity. The image, reproduced in greyscale here, is constructed from several thousand still colour-field images of the night sky. As can be seen, the sky does not begin to become truly dark until almost two hours after sunset (the 6 o'clock position). The colour images show an amber hue, which persists into the night, caused by sky glow from various anthropogenic sources, including the dock, the nearby city of Lancaster, the nuclear power station at Heysham and the marina itself. This technique can also be extended to longer periods. Figure 1b shows a 24-hour recording made in Beijing during the spring equinox in 2018.

The second method employs radial sonograms to show human and non-human behaviour in the environment. Sonograms visually represent sound frequency as a function of time and are used by soundscape ecologists, for example, to evaluate the health of natural biomes (Pijanowski et al., 2014). Energetic biological, meteorological, technological and occasionally geological events all cause disturbances to the air, and sound can thus be used as a proxy for such environmental activities. Sonograms of short periods - a couple of seconds - can be used to identify specific bird or insect calls, while much longer recordings of hours, days or weeks tend to show the accumulation of events in an environment and their rise and fall over time according to the various processes that guide them.

The sonograms shown in Figure 1c and d show the same four-hour period as Figure 1a. These have been rendered radially rather than the usual linear format to emphasise the rhythmic nature of behaviour and behavioural cues in the environment. To encourage a relational reading over one of absolute measurement, labels, scales and grids

5. See at: <https://showyourstripes.info/>

have omitted. The first sonogram shows frequencies that extend beyond human hearing (approximately 20 Hz to 20 KHz) into infrasonic and ultrasonic frequencies (3 Hz to 96 KHz). The second shows a much narrower band of low frequencies (3 Hz to 300 Hz). These emphasise different aspects of behaviour in the environment. In Figure 1c, the infrasonic calls of an insectivorous bat species (*Nyctalus noctula*) can be seen, way beyond our hearing range. These start around the 1 o'clock position, as dusk falls (see Figure 1a), as mating swarms of midges appear above the water. In contrast, Figure 1d shows sounds of a predominantly anthropogenic technological source - engines and motors, the hum of electrical transformers, automated systems and electronic signals. Many of these sounds tend to go unnoticed, being either filtered out by the brain or simply below the threshold of hearing. However, the sonograms make it clear that as night falls, human activity continues unabated.

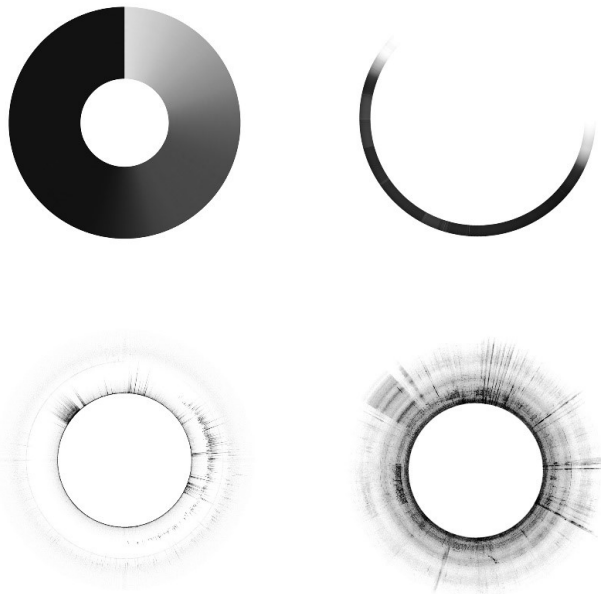

Figure 1. Left to right, top to bottom: (a) Light recording, dusk, Glasson Dock, Northwest England (19:45 to 23:05, April 16, 2020) (b) Light recording, vernal equinox, Xisi, Beijing, (solar noon to solar noon, 2018); (c) radial sonogram, Glasson Dock, 3 Hz to 96 KHz (19:45 to 23:05, April 16, 2020); (d) radial sonogram, Glasson Dock, 3 Hz to 300 Hz (19:45 to 23:05, April 16, 2020)

© Rupert Griffiths

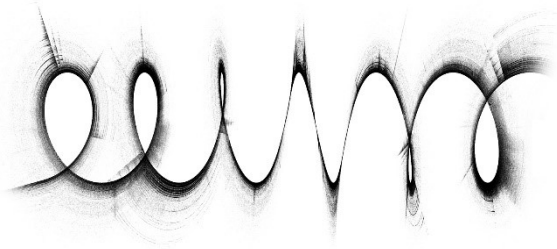

Figure 2. A proposed helical sonogram aims to capture the periodicity of events at particular temporal scales, such as circadian, weekly, circalunar, or monthly © Rupert Griffiths

Coda

These brief descriptions are intended to give an indication of how an applied poetics of data might begin to manifest in practice. A longer-term aim of this research is to develop a suite of methods and techniques that communicate such data through objects and materials as well as images. Future work will also record and communicate much longer periods - from days, weeks and months to years - to bring out the many rhythms in urban environments and the processes that drive them. Figure 2 shows a prototype of a continuous recording process. This is currently implemented in JavaScript, capturing a live stream from a microphone and recording it as a helical sonogram shown in three-dimensional space. The circumference of the helix can be changed to match particular periods - with long enough recordings, it could be adjusted to a diurnal, circalunar or various anthropogenic periods. Future iterations and additions to the toolkit will capture other dimensions of light and sound, such as ultraviolet and infrared light and variations in the polarisation of light over time. It will also align them with perambulatory methods that take an audience into the landscape (Drever, forthcoming; Dunn, 2016). This will articulate an expression of the urban biome that acknowledges our human sensorium and its limits in understanding what concerns our non-human companions.

In summary, the aim of these methods is to use recordings of environmental data to physically and imaginatively engage an audience in the environment as a more-than-human ecology - to facilitate a chimeric stance (Haraway, 1991). Such works also encourage a view of the environment that sits at an intersection between lived experience and timescales that extend beyond the day to day, acknowledging a more-than-human understanding of temporality that embraces the bio-, geo- and technological.

References

- Chepesiuk, R. "Missing the Dark: Health Effects of Light Pollution." *Environmental Health Perspectives* 117, no. 1 (2009): A20-27.
- Dewsbury, J.D., P. Harrison, M. Rose, and J. Wylie. "Enacting Geographies." *Geoforum* 33, no. 4 (2002): 437-440.
- Dunn, N. *Dark Matters: A Manifesto for the Nocturnal City*. John Hunt Publishing, 2016.
- Edensor, T. *From Light to Dark: Daylight, Illumination, and Gloom*. University of Minnesota Press, 2017.
- Fonken, L.K., and R.J. Nelson. "The Effects of Light at Night on Circadian Clocks and Metabolism." *Endocrine Reviews* 35, no. 4 (August 1, 2014): 648-70.
- Haraway, D. *Simians, Cyborgs and Women: The Reinvention of Nature*. London: Free Association Books, 1991.
- Ingold, T. *The Perception of the Environment: Essays on Livelihood, Dwelling and Skill*. London; New York: Routledge, 2000.
- Drever, J.L. "Listening as Methodological Tool: Sounding Soundwalking Methods." In *The Bloomsbury Handbook of Sonic Methodologies*, edited by M. Cobussen and M. Bull. Bloomsbury Academic, Forthcoming.
- Koblin, A. "Data Visions." *Think Creativity*, 2012.
- Kyba, C.C.M., S.B. Pritchard, A.R. Ekirch, A. Eldridge, A. Jechow, C. Preiser, D. Kunz, et al. "Night Matters—Why the Interdisciplinary Field of 'Night Studies' Is Needed." *J – Multidisciplinary Scientific Journal* 3, no. 1 (2020): 1-6.
- Longcore, T., and C. Rich. "Ecological Light Pollution." *Frontiers in Ecology and the Environment* 2, no. 4 (2004): 191-98.
- Pijanowski, B.C., L.J. Villanueva-Rivera, S.L. Dumyahn, A. Farina, B.L. Krause, B.M. Napoletano, S.H. Gage, and N. Pieretti. "Soundscape Ecology: The Science of Sound in the Landscape." *BioScience* 61, no. 3 (March 1, 2011): 203-16.
- Rich, C., and T. Longcore. *Ecological Consequences of Artificial Night Lighting*. Island Press, 2013.
- Whatmore, S. *Hybrid Geographies: Natures, Cultures, Spaces*. Sage, 2002.

Dark Design

Reimagining Nocturnal Ambiances

Nick DUNN¹

Abstract. The implementation of energy-efficient artificial lighting has been accompanied by a compelling narrative of savings in economic terms. However, this obscures significant costs to the environment, humans and non-humans. It has also led to higher levels of brightness at night. Integral to this process is the loss of nocturnal atmospheres and ambiances as access to darkness becomes further limited. We need new ways to address this ongoing extinction of experience of the nocturnal commons. Design can provide a valuable role in its ability to explore alternatives, to speculate on new sensitizations that enable nocturnal urban ambiances to be reimagined. This paper proposes an emerging field of 'Dark Design' as advocacy for change of existing beliefs concerning artificial lighting and darkness.

Keywords. Darkness, Design, Nocturnal Commons, Ambiances, Humans and Non-Humans

The Cost of Light

Enmeshed in the ongoing processes of global urbanisation are the manifold networks that support collective life, including artificial light and its unintended consequences. The dominant narrative of savings in economic terms through the implementation of energy-efficient lamps, however, is problematic in two principal ways. Firstly, the focus on economic value largely obscures other significant costs i.e. to the environment, humans and non-humans (Haim et al., 2019). Secondly, to date the deployment of more efficient artificial lighting methods has resulted in increasingly higher levels of brightness at night (Kyba et al., 2017). This widespread growth in different types of artificial illumination is altering natural cycles of light and dark, directly impacting on the circadian rhythms of human and non-human bodies, flora and their ecosystems (Rich and Longcore, 2006). Integral to this increase is the loss of nocturnal atmospheres and ambiances as access to darkness becomes further limited. This is particularly pronounced in urban nightscapes due to the quantity and quality of different forms of artificial light employed. How do we determine the cost of light?

In order to comprehend the extent of the problems caused by light pollution it is important to appreciate the scale of the situation, with some scientists referring to it as a global challenge (Davies and Smyth, 2018). An intrinsic issue is that as artificial lighting continues to increase at night we become accustomed to the higher levels of illumination and are not aware of what is disappearing. It is, therefore, apparent that we need new ways to address this ongoing 'extinction of experience' (Pyle, 1978; Soga and Gaston, 2016) of the nocturnal commons. Despite appeals to calibrate the cost of artificial light through rethinking how its adverse impacts are assessed and regulated through policy (Hölker et al., 2010) or better understand the sociotechnical controversies

¹. *ImaginationLancaster, Lancaster University, UK, nick.dunn@lancaster.ac.uk*

it represents (Challéat et al., 2015), the focus on light itself only provides one side of the argument and it is equally crucial to consider the unheralded virtues of darkness (Edensor, 2103).

The Value of Darkness

Light and dark are inextricably bound together. Their coexistence is fundamental to countless ecological processes as well as having significant conceptual associations and cultural meanings. However, the bias toward negative connotations of darkness endures. Recent work has attempted to redress the balance of this relationship by challenging existing reductionist frameworks and proposing a relational approach (Le Gallic and Pritchard, 2019), and providing new insights into cultures, histories, and practices concerning darkness (Dunn and Edensor, 2020). Therefore, rather than solely focusing on what is problematic with regard certain forms and functions of artificial lighting at night, perhaps it is useful to consider what is positive about darkness at night (Henderson, 2010; Gallaway, 2015). Clearly establishing the value of darkness is a complex task concerning multiple actors, human and non-human. Stone (2018) has sought to conceptualize and categorize the ways in which value is derived from darkness, particularly as an environmental good, with the practical goal of informing future decision-making about urban lighting at night. Understanding that darkness is worth pursuing alongside efforts to reduce the negative impacts of artificial lighting at night is important since it directs us towards an alternative way of approaching value in urban spaces at night. Yet gaining this knowledge and appreciation is not without its obstacles and barriers.

Giving equal consideration to the value that darkness can contribute to urban nightscapes, rather than simply attempting to reduce the effects of light pollution, requires us to address the decision-making processes that underpin such an ambition. Making sense of what darkness is, in its multifarious forms, and how and why these are valuable is shaped by those who participate in this endeavor. This raises the question of what constitutes the 'who' in such processes. Jacques Rancière explains how making sense of a sense is inherently political since it concerns, "what is seen and what can be said about it, around who has the ability to see and the talent to speak, around the properties of spaces and the possibilities of time" (2009, 13). When applied to nocturnal places, this perspective stimulates important ethical and ecological issues alongside the spatial and temporal dynamics of such environments in two distinct ways. First, there is the array of belongings that are situated in, relational to, and may also co-exist that coalesce to produce the specific ambiance of a place at night. Second, it is critical to account for the non-human actions, routines, and responses that co-constitute the characteristics of a particular nocturnal ambiance. Caution needs to be exercised when bringing non-human agencies into a political ecology since it, "is not to claim that everything is always a participant, or that all participants are alike. Persons, worms, leaves, bacteria, metals, and hurricanes have different types and degrees of power, just as different persons have different types and degrees of power" (Bennett, 2010, 108-109). What emerges through these complex entanglements of light and dark, human and non-human, space and materiality, is the need for diverse encounters and alternatives to the business-as-usual approach that dominates the development of artificial lighting in urban nightscapes.

Reimagining Nocturnal Ambiances

Critical to understanding nocturnal ambiances is acknowledging the dynamic qualities of the elements that form and shape them in material, spatial, and temporal terms (Dunn, 2016; Edensor, 2017; Foessel, 2017). This flux comprises an admixture of

stable, contingent and even fleeting aspects which “emerge as part of a distributed relationality and, rather than constituting a durable condition, atmosphere flows as a sequence of events and sensations, successively provoking immersion, engagement, distraction and attraction” (Edensor, 2015, 333). The potentialities and capacities of nocturnal ambiances to provide a wider array of sensations and interactions than are often present in urban landscapes requires methods through which to rediscover and reimagine our relationships with darkness. This is essential if we are to reduce the detrimental effects of unfettered artificial lighting upon the health of human and non-human bodies and ecosystems, let alone the waste of valuable energy resources. This is where design can provide a valuable role. As Sumartojo and Pink (2018, 95) suggest, “the role of design is to create interventions that make possible the circumstances through which particular types of atmosphere might emerge.” In its ability to explore alternatives, design can speculate on new sensitizations that enable nocturnal urban ambiances to be encountered and experienced beyond the purview of most contemporary urban artificial lighting deployment.

Key to this trajectory is the commitment of design to an ongoing process of adjustments or “atmospheric attunements” (Stewart, 2011) that may direct us toward new ways of living in and through our surroundings or routines. Rather than a static context, a nocturnal ambiance can be understood as “a lived affect - a capacity to affect and to be affected that pushes a present into a composition, an expressivity, the sense of potentiality and event” (ibid., 452). Through its entanglement with such lived affects, design can open up new dialogues with ordinary sensibilities and question their acceptance by exploring how precarious and limited many of our norms are. The night and the variety of light and dark conditions it provides are substantial presences with their own role to play in this process (Alvarez, 1996). Reimagining nocturnal ambiances urges us to engage with different places after dark since it is through such encounter that it is possible to consider how these atmospheres may be suggestive of alternatives for existing situations (Dunn, 2020). By developing new visions and interventions for nocturnal ambiances, shared atmospheres that promote positive behaviour for human and non-human sensitivities can be designed with darkness rather than against it. To achieve this, it is proposed that we need a specific field of ‘Dark Design’ as advocacy for change of existing beliefs concerning artificial lighting and darkness.

Towards Dark Design

In identifying what it means to develop approaches for Dark Design and how we account for ‘nocturnal design values’, we need to reconsider existing design practices since “if night means the ephemeral, the fragile, the spontaneous, how does one construct this element without distorting it?” (Armengaud et al., 2009, 12). Positioning darkness as a positive agent for design brings forth an exigency to better understand the value of different coexistences of light and dark; their qualities and effects so that we may further comprehend the array of possibilities available to us. Crucial here is to remember that our senses and view of darkness are culturally conditioned, being bound up in specific historical, geographical and social circumstances. Dark Design, therefore, should be a global community.

In seeking to establish what Dark Design might entail, it is useful to turn our attention to those elements that are often underrepresented or excluded from design. To do this, I draw on Gissen’s (2009, 22) notion of ‘subnatures’ which are “those forms of nature deemed primitive (mud and dankness), filthy (smoke, dust, and exhaust), fearsome (gas or debris), or uncontrollable (weeds, insects, and pigeons).” For many, this may also be how darkness might be viewed so, rather than ignore the complexity

of engaging with the manifold material-æsthetics of nocturnal ambiances, it is proposed that Dark Design should follow Haraway (2016) and learn to ‘stay with the trouble’, forming a ‘making-with’ them. It is suggested here that working with and through such entanglements might provide a useful way to avoid the current trajectory, characterized by ‘what is being lit is not the space but merely a fear - legal or otherwise - of the consequence of darkness’ (Bartholomew, 2004, 39). The transition in understanding and practices needed to appreciate the value of darkness rather than deal with its consequence is no mean feat.

Key to this role is the capacity of design to speculate on how the future could be and present radical alternatives to business-as-usual scenarios. In this context, such an approach would echo Narboni’s (2017) appeal for cities to integrate ‘dark infrastructures’, to protect and preserve darkness and support green spaces and blue areas such as parks, canals and rivers, by directing their attention away from artificial lighting toward a ‘nocturnal urbanism.’ A critical step towards Dark Design will be to make the nocturnal biome meaningfully legible as a more-than-human ecology (Griffiths and Dunn, 2020). This will enable us to better understand the non-anthropocentric implications of what we design, how we design and why.

Through producing alternatives for urban places at night, that demonstrate positive ambiances for humans and ecological benefits for other species, design can promote better public understanding of darkness and redefine the importance of its value and meanings in the twenty-first century. Rather than accept that the different forms of light pollution are a necessary by-product of urban life, the purpose of Dark Design is to provide alternatives which offer deliberate and positive counterpoints to the prevailing practices of designing against darkness. To conclude, this paper presents an open invitation to academia and design professions to shape the emerging field of Dark Design as a multi- and inter-disciplinary collaborative network of theory and practice. In doing so, it calls for the pressing need for design to engage in new ways to reimagine our relationships with darkness and better understand alternatives for artificial lighting that enable humans, non-humans, and the planet to flourish.

References

- Alvarez, Al. *Night*. New York, NY: W.W. Norton & Company, 1996.
- Armengaud, Marc, Matthias Armengaud, and Alessandra Cianchetta. *Nightscares: Paisajes nocturnos/Nocturnal landscapes*. Barcelona: Editorial Gustavo Gili, 2009.
- Bartholomew, Edward. “A Place for Darkness.” *Professional Lighting Design*, Sept/Oct: 38-41, 2004.
- Challéat, Samuel, Dany Lapostolle, and Rémi Bénos. “Consider the Darkness: From an Environmental and Sociotechnical Controversy to Innovation in Urban Lighting.” *Artículo - Journal of Urban Research* 11 (2015) [Online]. <https://doi.org/10.4000/articulo.3064>
- Davies, Thomas W., and Tim Smyth. 2018. “Why artificial light at night should be a focus for global change research in the 21st century.” *Global Change Biology* 24(3) (March, 2018): 872-882.
- Dunn, Nick. *Dark Matters: A Manifesto for the Nocturnal City*. New York: Zero Books, 2016.
- Dunn, Nick. “Place After Dark: Urban peripheries as alternative futures.” In *The Routledge Handbook of Place*, edited by Tim Edensor, Ares Kalandides, and Uma Kothari,

155-167. Routledge Handbooks. London: Routledge, 2020.

Dunn, Nick, and Tim Edensor, eds. *Rethinking Darkness: Cultures, Histories, Practices*. London: Routledge, 2020.

Edensor, Tim. "Reconnecting with darkness: gloomy landscapes, lightless places." *Social & Cultural Geography* 14(4) (May 1, 2013): 446-465. <https://doi.org/10.1080/14649365.2013.790992>.

Edensor, Tim. "Light design and atmosphere." *Visual Communication* 14(3) (June 29, 2015): 331-350. <https://doi.org/10.1177/1470357215579975>

Edensor, Tim. *From Light to Dark. Daylight, Illumination, and Gloom*. Minneapolis, MN: University of Minnesota Press, 2017.

Foessel, Michaël. *La Nuit: vivre sans témoin*. Paris: Editions Autrement, 2017.

Gallaway, Terrel. "The value of the night sky." In *Urban Lighting, Light Pollution and Society*, edited by Josiane Meier, Ute Hasenöhr, Katharina Krause, and Merle Pottharst, 267-283. London: Routledge, 2015.

Gissen, David. *Subnature: Architecture's Other Environments*. New York, NY: Princeton Architectural Press, 2009.

Griffiths, Rupert, and Nick Dunn. "More-than-human Nights: Intersecting lived experience and diurnal rhythms in the nocturnal city." Paper presented at 1st International Conference on Night Studies, Lisbon, July 2-4 2020.

Haim Abraham, David M. Scantlebury, and Abed E. Zubidat. "The loss of ecosystem-services emerging from artificial light at night." *Chronobiology International*, 36(2) (2019): 296-298. <https://doi.org/10.1080/07420528.2018.1534122>

Haraway, Donna J. *Staying with the Trouble: Making Kin in the Chthulucene*. Durham, NC: Duke University Press, 2016.

Henderson, David. "Valuing the Stars: On the Economics of Light Pollution." *Environmental Philosophy* 7(2) (Spring 2010): 17-26.

Hölker, Franz, Timothy Moss, Barbara Griefahn, Werner Kloas, Christian C. Voigt, Dietrich Henckel, Andreas Hänel, Peter M. Kappeler, Stephan Völker, Axel Schwöpe, Steffen Franke, Dirk Uhrlandt, Jürgen Fischer, Reinhard Klenke, Christian Wolter, and Klement Tickner. "The Dark Side of Light: A Transdisciplinary Research Agenda for Light Pollution Policy." *Ecology and Society* 15(4) (2010) [Online]. <http://www.ecologyandsociety.org/vol15/iss4/art13>

Kyba, Christopher C. M., Theres Kuester, Alejandro Sánchez De Miguel, Kimberly Baugh, Andreas Jechow, Franz Hölker, Jonathan Bennie, Christopher D. Elvidge, Kevin J. Gaston, and Luis Guanter. "Artificially lit surface of Earth at night increasing in radiance and extent." *Science Advances* 3(11) (November 22, 2017): e1701528. <https://doi.org/10.1126/sciadv.1701528>

Narboni, Robert. "Imagining the Future of the City at Night." *Architectural Lighting*, 2017. https://www.archlighting.com/projects/imagining-the-future-of-the-city-at-night_o

Pyle, Robert M. "The Extinction of Experience." *Horticulture* 56 (1978): 64-67.

Rich, Catherine, and Travis Longcore, eds. *Ecological Consequences of Artificial Night Lighting*. Washington D.C.: Island Press, 2006.

Soga, Masashi, and Kevin J. Gaston. "Extinction of experience: the loss of human-na-

ture interactions.” *Frontiers in Ecology and the Environment* 14 (March, 2016): 94-101.

Stewart, Kathleen. “Atmospheric attunements.” *Environment and Planning D: Society and Space* 29(3) (January 1, 2011): 445-53. <https://doi.org/10.1068/d9109>

Stone, Taylor. “The Value of Darkness: A Moral Framework for Urban Nighttime Lighting.” *Science and Engineering Ethics* 24(2) (April, 2018): 607-628.

Sumartojo, Shanti, and Sarah Pink. *Atmospheres and the Experiential World: Theory and Methods. Ambiances, Atmospheres and Sensory Experiences of Spaces*. London: Routledge, 2018.

01

ATMOSPHERE, ANTHROPOCENE, URBANITY, SENSITIVITY

02

ARTIFICIAL LIGHTING AND DARKNESS IN
THE ARCHITECTURAL AND URBAN PRACTICES

03

ATMOSPHERES + DESIGN

04

BODY, CULTURE, IDENTITY

05

DIGITAL ARCHITECTURE. ATMOSPHERES IN DESIGN
AND NEW RESPONSIVE & SENSITIVE CONFIGURATIONS

Atmospheres + Design

Session 3 – Introduction

Shanti SUMARTOJO¹

Even at their most abstract and conceptual, atmospheres are tethered to configurations of spaces, materials and the sensory and affective feelings that these afford. Always available if we attune to them, atmospheres help us to understand and value our surroundings in ways that stretch to include what we sense, imagine, feel and remember. Accordingly, they are deeply entangled with design of all sorts, both in terms of built, made or manipulated artefacts, and the processes of creativity and making that generate those artefacts. This means that whilst atmospheres might be the goal of design processes - buildings, objects, lighting schemes or interior décor, for example - this relationship is reciprocal. That is, just as atmospheres are linked to the designed world, design can also help us understand atmospheres, and their constitution, impact and analytical limits. This group of papers explores what happens when we think about design atmospherically, and what insights might emerge from this pairing.

While the generation of atmospheres has been the goal of a range of design fields, they inevitably escape this intention when they are taken up in the experiential world. Even when places, buildings or events are understood atmospherically by people who encounter them, the specific terms of these atmospheres, and what they connect to in the imagination, remain distinctively individual, even when some of these feelings are shared. Atmospheres might be a spatial quality, but they do not begin and end definitively, or remain spatially contained. Instead, ‘the role of design is to create interventions that make possible the circumstances through which particular types of atmosphere might emerge, but alone it cannot predetermine or predict exactly what these atmospheres will be experientially (Sumartojo and Pink, 2018, 95). This is because atmospheres always exceed the intentions of the designer, because they are made and made sense of by the ‘perceiving subject’ (Anderson, 2009).

Moreover, precisely because atmospheres are relational and dynamic, they configure and are understood ongoingly. This echoes the inherent incompleteness of design itself, which is never a finished process. Design artefacts of all types are taken up, modified and become valuable and useful in ways that go beyond the control of the designer. Indeed, while design may have a long history as an area of specialist expertise, vernacular, ‘everyday’ and improvisational modes of design and making (Duque and Poplow, 2019; Wakkary and Maestri, 2007) are enacted constantly, and have long aimed to configure atmospheres. This is exemplified in ‘the ongoing adjustments that

1. *Emerging Technologies Research Lab, Monash University, Australia, shanti.sumartojo@monash.edu*

people make to improve their surroundings or routines ...[that] are equally relevant in both making designed objects, services or other things active in the world and in the making of atmospheres' (Sumartojo and Pink, 2018, 95).

Atmospheres and design have this in common: their unfinished and ongoing quality - and sometimes these come together empirically in illustrative ways. An example is Pink *et al*'s (2014) project related to energy use in the home. Here research participants showed how they improvised the use of technologies, such as lighting and heating, to make their homes 'feel right'. They designed routines to ongoingly tweak how their homes 'felt', such as switching on lights in different rooms, opening or closing curtains, and adjusting heating and cooling. These actions were routine and continual ways of configuring the sensory and affective feel of their homes - that is, their atmospheres - showing how design and atmospheres come together in people's ways of understanding and manipulating aspects of their surroundings. This work showed the entanglement of atmospheres and energy use in the home, connecting directly to technology design. Bille's (2014) work on lighting similarly shows the curation of light and lighting in Danish homes, a quotidian routine aimed at curating a 'cosy' or 'homely' atmosphere where lighting technology was directed at supporting culturally specific domestic interior spaces. These examples show how design, as both a process and an outcome, is entangled with atmospheres.

Atmospheres thus offer great value as something to think with in order to help understand our worlds and forms of intervention in it. We can deploy atmospheres conceptually to grapple with and link up affect, the senses, movement, spacetime, imagination and memory. They help us connect these concepts to a world that we can reach through empirical research, bringing them into dialogue with methodologies that, while directed at investigating atmospheres, also treat it as an expansive category of experience that can be determined by different people in different ways. In the examples of making homely atmospheres discussed above (Pink *et al*, 2014; Bille, 2014), atmospheres provide a valuable concept that can draw together everyday routine, technology, energy usage and domestic interiors, assembling these aspects in aid of designing for more sustainable homes. However, it was not a concept that the researchers necessarily provided, but rather one that emerged from the research participants' accounts. Moreover, it can help to connect the details of everyday experience to much larger conceptual frameworks, and can link up social science research methodologies with design processes and outcomes. Thinking atmospherically is therefore generative across multiple scales and perspectives.

It follows that if atmospheres can help us understand design, then design can also help us move forward empirically and analytically in our understanding of atmospheres. This is because design tethers atmospheres to the things, activities and imaginaries we dwell in. Design gives us empirical and methodological entry points to thinking with atmospheres. An example is the use of visualisation, particularly in architectural design and marketing. In a fascinating study of a large-scale redevelopment project in Qatar, Degen *et al* (2017) detail how designing atmosphere was an explicit goal of the team producing digital visualisations of the as-yet-unbuilt structures. They show how 'computer-generated images are... a new form of visualising the urban that captures and markets particular embodied sensations'; in other words, atmospheric images are crucial in both imagining and selling the project (Ibid., 3). Connecting graphic effects and the 'virtual engineering of sensory experiences', designers purposefully attempted to depict not only the designed structures, but also the atmospheres that they imagined would configure along with them. This included attending to light, colour and the placement of smiling people in 'happy scenes', all digitally

produced. This suggests that atmospheres, even only virtual ones, are still effective in drawing people in, and in this case, selling property.

Spatial and material prototypes also engage atmospheres in creative and imaginative processes. If digital visualisations are intended to be perceived by the eyes (and sometimes the ears), then prototypes can also engage touch, spatiality and proprioception, testing how things feel across a wide range of sensory affordances. Both an outcome of design and a process of designing, prototypes can help us understand how design feels, but also remind us that the context in which we encounter design is crucial in our responses to it. That is, design does not exist in a world devoid of other objects, processes or people; prototypes, whether in the studio or elsewhere, are manifest in a world in which atmosphere is already at play. Moreover, as with atmospheres themselves, the relationship between design artefacts and the worlds they are part of is not fixed, static or certain. While visualisations or prototypes are important tools in design processes, they can never predetermine or predict exactly how atmospheres will be experienced, even when this is the aim. At the same time, many places, buildings, events or routes are understood atmospherically by people who experience them, whether or not atmospheres are the purposeful goal of designers.

Ambiances2020

The goal of this *Ambiances2020* panel is not to determine what causes or controls atmospheres, or extent to which atmospheres may be designed or not. Indeed, the problem with thinking about atmospheres as 'designable' is that it treats them as 'things' in their own right that pre-exist our apprehension of them. The result is that we can easily lose sight of their location in relationality, and push to the background their indeterminate, ongoingly configuring and multiple qualities. As I say above, like design, atmospheres are never finished.

Instead, this set of papers takes on the relationship between atmospheres and design, considering what happens when we pair them conceptually and empirically. It seeks to probe the relationship between atmospheres and the processes and interventions of design, architecture and other forms of creative practice. The papers begin with two accounts of how lighting design and other sensory qualities configure into the experience of people in hospital settings. Papers in located the distinctive environments of tattoo studios, football stadia and a museum continue the exploration of the particular role of atmospheres in contributing to the feel of these places and contributing to how they are valued (or how they disappoint) the people who use them.

The panel hinges on a paper about individual atmospheric apparatuses designed specifically to generate atmospheric experiences when worn by their users. The panel concludes with three papers written by designers that explicitly explore atmospheric affordances through their own practice-based research. Here, air - and its qualities of temperature, humidity and flow - is explored through gallery installation. A paper on fog considers how this inherently atmospheric quasi-substance reacts to its surroundings, and how designers might best shape its distinctive shapes and movements. Finally, the capacity of objects to carry or evoke atmospheres finishes the session.

Together, the papers show a variety of approaches to atmospheres, demonstrating its value as a conceptual framework, and the creative, interdisciplinary and highly applicable research insights it can evoke.

References

Bille, Mikkel. "Lighting up cosy atmospheres in Denmark." *Emotion, Space and Society* (2014). <http://dx.doi.org/10.1016/j.emospa.2013.12.008>

Duque, Melisa and Popplow, Laura. "Caring with others - cultivating and revaluing as forms of everyday designing." *NORDES 2019: Who cares?* (2019) www.nordes.org.

Degen, Monica, Melhuish, Clare and Rose, Gillian. "Producing place atmospheres digitally: Architecture, digital visualisation practices and the experience economy." *Journal of Consumer Culture*, 17(1) (2017): 3-24.

Pink, Sarah, Leder Mackley, Kerstin and Moroşanu, Roxana. "Researching in atmospheres: video and the 'feel' of the mundane." *Visual Communication* 14(3) (2014): 351-369.

Sumartojo, Shanti and Pink, Sarah. *Atmospheres and the Experiential World: Theory and Methods*. Routledge, 2018.

Wakkary, Ron and Maestri, Leah. "Aspects of Everyday Design: Resourcefulness, Adaptation, and Emergence." *International Journal of Human-Computer Interaction* 24 (2008): 478-491.

Room for Transition by Aesthetic Empowerment?

Atmospheres and Sensory Experiences of a New Hospital Birth Environment

Birgitte FOLMANN¹

Abstract. This paper focuses on how the design, aesthetics and atmosphere of a new hospital birth environment affects the experiences of new fathers. Based on a phenomenological study it shows how atmospheres are experienced in a new birthing room intended to stimulate the senses in a comforting and equanimity-evoking way, and especially how the fathers attuned themselves to the situation of being present at the birth of their new-born infant. Studying fathers' transition to parenthood through the lens of atmosphere and interrogating the meaning of atmosphere in hospital rooms offers a more nuanced approach to our understanding of the relationship between people, space, time and event in future design of new hospital rooms.

Keywords. Atmosphere, Aesthetics, Hospital Design, Re-Enactment, Sensory Experience



¹. SONIC College, University College South Denmark and Regional Hospital Herning, ATMOSphere Research Group, Denmark, bfol@ucsyd.dk

Atmospheres – Aesthetics in Interaction

Denmark is currently undertaking major investments in the construction of new and improved hospitals. One of the architectural objectives of this renovation is to build hospital wards that aside from offering effective treatment, also provide a synthesis of functionality, design and sensory experiences (Frandsen et al., 2009). While clear cut evidence, preferably based on quantitative research is still predominant in the hospital context, there is a growing interest in understanding the importance of various ‘non-measurable’ phenomena such as sensory experiences and their impact on treatment and satisfaction. This interest in the sensory experiences in the hospital resonates with a broader trend in urban development and architecture generally, where focus on the physical environment now also includes an understanding of the sensory environment in interplay with the body, with an explicit strategy that focusses on inhabited space using concepts such as ‘atmosphere’ and ‘ambiance’ (Thibaud, 2014 ; Bille, 2014; Chebotareva and Rask, 2018).

Atmospheres are strange and ambiguous and bound to space. They can affect our very being by colouring our perception and influencing our experience. Furthermore, perception is active. As Jean-Paul Thibaud reminds us, perception “cannot be reduced merely to passive contemplation of the world - it involves moving in a certain way” (2011, 210). This means that experience is formed by bodies moving in the tuned space, and materiality and perception are intertwined in the process (see Hasse, 2008, 44). This study is based on interviews with Danish first-time fathers who participated in the birth of their first child at a regional hospital in Denmark. Based on these phenomenological interviews, I argue that rather than the objects in the birth room per se, what is at the core of the father’s experience is atmosphere - the in-betweenness of objects and subjects in the room (see Böhme, 2006). Rather than focusing on the agency of objects, this study is concerned with the body, in what the German philosopher Gernot Böhme has framed as “tuned spaces” (2013). Tuned spaces are spaces with a certain atmosphere where the spatial sense of atmosphere affects or disturbs the individual’s conception of the situation. In foregrounding “tuned spaces” (Böhme, 1993, 121), or what “corporeally moves the perceiving person” (Smits et al., 2011 in Bille et al 2015, 32), I argue that people actively seek to attune themselves to the situation or the spaces in which they find themselves (Bille et al., 2015). In my analysis of the significance of atmosphere for the fathers in the birthing room I will apply the ideas of Gernot Böhme and his definition of atmosphere as *aesthesis* (1993). In his proposal for a new *æsthethics*, Böhme (1993, 2013) argues for an *æsthethics* that is not focused on assessment of art but on sensory experience. Atmospheres become central to this *æsthethic* due to their unclear state; they belong neither to a human subject nor to a material object. Rather, they point to “[t]he relation between environmental qualities and human states” (Böhme, 1993, 114). For Böhme atmosphere is not simply the subjective experience of a room or situation, nor is it an objectively observable state of the physical environment. Nevertheless, Böhme argues that atmosphere belongs to subjects in that they are sensed in bodily presence by human beings. This sensory experience, is at the same time a bodily state of being of subjects in a space (1993, 122). In this sense, atmospheres are the perceived quality of a situation (or space), comprised by the constellation of people and things in a specific place and in a specific situation (Böhme, 1995, 33). Atmospheres are in Böhme’s word, “spheres of the presence of something, their reality in space”. An atmosphere approach requires that the subject be present in a space, and that the subject sense the presence of surrounding objects, other people, nature, etc.). Atmospheres is thus created out of engagement between persons, things, and their constellations (1993, 123). Thus, in order to study how atmospheres affect human practice, we need to focus on sensory experiences and emotional effects

Exploring the Significance of Atmospheres in Hospital Rooms

The study is undertaken at Regional Hospital Herning, where an innovation project was initiated to explore new designs of hospital rooms, in several departments including at the existing maternity ward. Aside from being informed by medical research and knowledge of hospital design, the design of the experimental birthing room had been developed through several workshops where health professionals, game designers, parents, designers and interior decorators among others discussed the possibilities and limitations that characterise a birth environment. The result was a birth environment where as much medical gear as possible had been removed to an adjacent room or hidden behind screens. In addition, the room had been fully furnished with Nordic décor, including chairs, coffee table and a rearrangeable sofa-bed. Thus, everything except the delivery bed had been chosen with the purpose of creating a home-like feeling, calmness and to accommodate the needs of both the mother-to-be and the birth supporters.

Using phenomenological theory to guide the interview a total of 12 interviews were conducted between March 2016 and June 2016. Nine of the interviews were with fathers participating at the birth of their child in a newly designed birthing room, and the remaining three interviews were with fathers participating at the birth of their child in a conventional birthing room. All interlocutors were part of a randomized controlled trial (first time mothers/fathers, ethnically Danish, uncomplicated pregnancy, not induced labor) as part of a larger quantitative study (Lorentzen et al., 2019). The study used embodied methodologies (Pink, 2009). Hence, 10 of the 12 interviews were conducted in the actual birthing room where the birth had taken place as part of a re-enactment method in order to facilitate the fathers' recollections and bodily sensations from the experiences. In this way, the fathers were able to point out, for example, which parts of the room were used the most and by whom. The re-enactment method was supplemented by the use of photos. All interviewees were asked to select and share pictures from the birthing room, if they had any, that represented something special to them. This allowed the fathers to emphasise what they found important, with the photo providing a point of departure for conversation. At the same time, the photo helped stimulate the fathers to recollect sensory experiences. Thus, both re-enactment and the use of photos helped facilitate the phenomenological approach. One of the advantages of using visual material and re-enactment is the heightened awareness of materiality and practical dimensions. As such, this approach complemented the interviews by affording the fathers an opportunity to explain how the physical conditions of the birth environment and their felt senses influenced their experiences of entering fatherhood.

From Sensory Experience to Practices of Attunement

During analysis of the data, it became clear that the two birth environments in the study affected the fathers in different ways. Whereas fathers who had their child in a conventional birthing room had difficulties in describing their sensory experiences, fathers who had their child in the new birthing room had deeply engaged transactions with the environment and were much more aware of the self and surroundings. The new birthing room, seemed to stimulate the fathers to explore the different possibilities of being an active part of the situation. Becoming aware of the atmosphere influences our perception and ways of perceiving and thus our possibilities for action. Perception, action and meaning are thereby closely related, as we engage directly in the meaning of events in an environment. Constituted as a relationship between environmentally available information and the capacities, sensitivities, and interests of the perceiver, the individual engages what Clarke call an "aesthetic attitude or

attunement” (Clarke, 2005, 91). The fathers in the newly designed birthing room were more explorative in performing their role; they described their sensory experiences in a more nuanced way, and their immediate reflections led them to be more active during the event of the birth. Since action can modify perceptions, the fathers more active participation in the birth ended up changing the way they perceived their experiences. Since atmosphere is a spatial carrier of attunement (Böhme, 1995) and a stimulating atmosphere is much more than enjoyable distractions, focusing on the atmosphere offers the possibility of more deeply engaged transactions for the fathers. This in turn, will make the overall birth situation more enjoyable, or at least less stressful for the parents. The fathers narrated how they could easily adjust and remain calm in the process of attunement. One could say that they were captured by the atmosphere but their attunement also affected the atmosphere in the birthing room. Other examples of practices of attunement were clearly visible in the photos that the interlocutors chose for the recall interviews. Several photos showed how the fathers felt at home, removing taking their outer shirt when the room temperature was warm, how they left their shoes under the sofa-bed and hung their clothes over the armrest of the sofa, as if they were in a home environment. People not only perceive the world through atmospheres; they also perform activities and practices and thus transform these atmospheres as well (Bille et al., 2015). They truly engage with the atmosphere in a dynamic process. The atmosphere, therefore, is not just ‘there’. It is constituted by subjects and their engagement with it.

Attunement as Co-Constitution of Atmosphere

Attention to multi-sensorial surroundings can lead to new possibilities and actions for the fathers as they attune themselves to the space and perform the practices of making a place feel right. The fathers-to-be, all of them experiencing a life-changing event, all seek to attune themselves to the situation during the birth. However, the possibility of being immersed into a different kind of atmosphere than the traditional clinical one, an atmosphere quite different from the conventional hospital experience, seems to stimulate their paying attention to the atmosphere. This engagement with the atmosphere inspires the user to explore new interactions. The new birthing room stimulated the fathers’ sensibility, while their attention to the atmospheric quality was inviting them to be more engaged in the situation.

Being able to attune to a particular atmosphere means that the “pervasive quality” of a situation “gets inside us” and orients us towards particular actions and expressions (Thibaud, 2011, 209). Modes of perception and cultural socialization influence this attunement process, and determine how a given atmosphere is co-created. Rather than being passive, mutely attuned and uncritically receptive individuals, people modify and play an active role in co-constituting atmospheres (Edensor and Sumartojo, 2015). Those who were in the newly designed birthing room - an environment quite different from any other clinical setting, found the experience to be pleasurable in itself. Despite the stress of the birth process and the life-changing event of being a first-time father, the newly designed birthing room made them “feel right.” The fathers were engaged in both the surroundings which gave them both a sense of autonomy and of well-being and in the event of the birth. Moods in the birthing room that stimulate the senses in a comforting and un-stressful way, and the inter-changeability in the technical features that the fathers themselves could manage, gave them a greater feeling of mastery and self-confidence in a situation normally marked by anxiety and stress.

Conclusion

Atmosphere exists at the intersection of the built and social environments. As such, it can create affective moods that even when unarticulated can influence our well-being and tune our being in the world. The atmosphere in a particular space is dependent on both object and subject, but subjects are also active agents in the atmosphere (Edensor and Sumartojo, 2015). The atmosphere is not just 'there'. It is also a creation of the subject's engagement with space. Actively co-constituting the atmosphere generates autonomy, enabling the subject to better attune to the space precisely because their attentiveness to the atmosphere was heightened. Entering a white-walled hospital environment, with its highly visible medical equipment, seemed to be counterproductive for attunement and active engagement in the situation. Birth of one's first child is certainly a key life transition for all humans. Due to the liminal status in this process, people are especially sensitive and susceptible to messages from the environment (Reed, 2005, 87). For the fathers who experienced the different birthing spaces, the importance of atmosphere for a supportive birth environment became evident. In a transformative process, an individual requires an environment that is as supportive as possible. The design of the birthing room can thus empower the fathers to take a more active supporting role in the birth process. The capacity to stimulate positive sensory experiences can raise awareness of the atmosphere - helping the fathers to be active co-creators of the atmosphere, which again influences the way they can act during the birth process and reflect upon the event. An atmosphere cannot be designed (Sumartojo and Pink, 2018). However, by viewing atmospheres as "tuned spaces" that can influence patients and their relatives' perception, co-creation and agency in the situation, the atmosphere approach can be useful in designing new hospital rooms.

References

- Albertsen, N." Gesturing atmospheres." In Jean-Paul Thibaud & Daniel Siret (eds.). *Ambiances in Action. Proceedings of the 2nd International Congress of Ambience*. Danadien Centre for Architecture, Montreal, September 2012. Mayenne: International Ambiance Network. 2012. P. 69-74.
- Bille, M. Lighting up cosy atmospheres in Denmark. *Emotion, Space and Society*, 17 January. Available at: <http://dx.doi.org/10.1016/j.emospa.2013.12.008> (accessed 22 June 2020)
- Bille, M., Bjerregaard, P., & Flohr Sørensen, T. Staging atmospheres: Materiality, culture, and the texture of the in-between. *Emotion, Space and Society* 15 (2015) 31e38. 2015
- Böhme, G. Atmosphere as the Fundamental Concept of a New Aesthetics. January 1993. *Thesis Eleven* 36: 1993, P. 113-126
- Böhme, G. Bohme, Gernot, *Atmosphäre: Essays zur neuen Ästhetik*. Suhrkamp, Frankfurt am Main. 1995
- Böhme, G. *Architektur und Atmosphäre*. München, Germany: Suhrkamp. 2006
- Böhme, G. Aesthetic of Atmospheres. Paper presented at the Tuned City: Operative atmospheres, Brussels Keynote lecture. 2013. Retrieved from: http://www.tunedcity.net/?page_id=3868
- Chebotareva, P., & Rask, N. Mediating new individual-environment relations through experimentation on ambience. *Ambiances*, 2018(4).
- Clarke, E. *Ways of Listening: An Ecological Approach to the Perception of Musical*

Meaning. Oxford. UK: Oxford University Press. 2005

Edensor, T. & Sumartojo, S. Designing Atmospheres: introduction to Special Issue, Visual Communication Volume: 14 issue: 3, 2015, page(s): 251-265

Frandsen, A.K., Ryhl, C., Folmer, M.B., Øien, T. B., Lykke Sørensen, N., & Mullins, M. Helende arkitektur. Institut for Arkitektur og Design skriftserie vol. 29. 2009

Hasse, C. Postphenomenology: learning cultural perception in science.

In: Human Studies, Vol. 31, No. 1, 2008, p. 43-61.

Højlund, M. Overhearing. An attuning Approach to Noise in Danish Hospitals. Ph.D. Dissertation, Faculty of Arts, Aarhus University, Denmark. 2017

Iben Lorentzen, Charlotte Sander Andersen, Henriette Svenstrup Jensen, Ann Fogsgaard, Maralyn Foureur, Finn Friis Lauszus, Ellen Aagaard Nohr,

Study protocol for a randomised trial evaluating the effect of a “birth environment room” versus a standard labour room on birth outcomes and the birth experience,

Contemporary Clinical Trials Communications, Volume 14, 2019

Pink, S. Doing sensory ethnography. SAGE Publications Ltd City: London. 2009

Reed, R. Birthing Fathers: The Transformation of Men in American Rites of Birth. Rutgers University Press, 2005

Schmitz, H., Owen. M., Rudolf, S. Emotions outside the box - the new phenomenology of feeling and corporeality. Phenomenol. Cognit. Sci.10 (2), 241e259. 2011

Sumartojo, S. & Pink, S. Atmospheres and the Experiential World. Theory and Methods. Routledge, London, 1st edition. 2018

Thibaud, J.-P. Urban Ambiances as Common Ground? Lebenswelt. Aesthetics and philosophy of experience, Università degli Studi di Milano, 2014, pp. 282-295

Thibaud, J.-P. The Sensory Fabric of Urban Ambiances, The Senses and Society, 6:2, 203-215, 2011.

Light Affects

Towards a Body-sensory Approach in Lighting Design

Abstract. Informing current research on how light effects our performance, hormones and moods, this paper presents a body-sensory approach to study atmospheric affects of light. Presenting ethnographic data from three studies on the bodily feel of colour illuminated spaces, the paper shows how architectural lighting designs go beyond their immediate potential of supporting visual needs and aesthetic delight, by their ability to attune bodily sensations and states of being. Consequently, the paper argues for a qualification of current methodologies within lighting research and calls for an atmospheric mindful awareness of the sensory body when designing with chromatic lighting technologies for architectural spaces.

Stine Louring NIELSEN¹

Keywords. *Light, Colour, Atmosphere, Bodily Sensation, Architecture, Design*

The Body of Luminous Atmospheres

Designers and architects have long been doing multiple types of aesthetic work on giving materials and spaces a certain presence, radiation or feel (Böhme, 2013b; Edensor and Sumartojo, 2015). With the introduction of chromatic lighting technologies, the possibilities within the tinting of spaces have expanded. From smart-home lighting technologies to tuneable LED spots of sensory delivery rooms, coloured illuminations have made their way into our private homes and public spaces. While we know of some of their psychophysiological effects on performance, hormones and moods (Küller et al., 2006; Lockely et al., 2006) and their sociocultural affects and attunements of everyday practices and social dynamics (Edensor, 2017; Bille, 2019), studies on their affective feel have become ever more crucial, in order to inform the designs and applications of chromatic lighting technologies in architectural spaces. Zooming in on the somewhat intangible sensory interaction between body and lit space, this paper deals with how we actually feel within our new tinted and tintured world.

Lighting up a path to approach the body-sensory affects of lit spaces is the concept of atmosphere. While acknowledging that atmospheres are entangled in social and cultural worlds, constituted in a dynamic force field of multiple elements of people, materials, conditions and constitutions, the particular scope of this paper addresses the concept of atmosphere as a general theory of perception (Böhme, 1993). As conceptualized by Böhme, perception “is basically the manner in which one is bodily present for something or someone or one’s bodily state in an environment” (ibid., 125). Thus, we are forever present within and perceiving this world via our body. Unfolded by a prominent contributor and speaker for the significance of the body in space, architect Juhani Pallasmaa, our human perception occurs with our entire body

¹ Aalborg University Copenhagen - Lighting Design Research Group, Denmark, stm@create.aau.dk

(Pallasmaa, 2012). With reference to Merleau-Ponty, Pallasmaa states “I grasp a unique structure of the thing, a unique way of being. Which speaks to all my senses at once.” (ibid., 23) Our multisensorial bodily sensations and presence within a space can thus be found at the core of any atmospheric phenomenon.

As such, atmospheres are evidently an intermediate phenomenon of the co-presence of subject and object (Böhme, 1998, 114). On the matter of lit space, Böhme notes how light has the power to provide a space with distinctive qualities by affecting the way surfaces appear (Böhme, 2017b). Böhme calls this the ‘ecstasies’ of objects, connoting an object’s ability to step out of its own tangible boundaries and impose itself on the environment. Or more precisely: “it does not relate to the determinations of things, but to the way in which they radiate outwards into space, to their output as generators of atmospheres” (Böhme, 2013b, 5). As such, according to Böhme, by imbuing a certain quality to a space, light serves as a generator of atmosphere (2017, 203) for the human body to perceive. Hence, emerged by a co-presence of body and space, atmospheres hold the capacity to “imbue everything, they tinge the whole of the world or a view, they bathe everything in a certain light, unify a diversity of impressions in a single emotive state” (2013b, 2).

Bodily Sensations as a Means of Inquiry

Taking multisensorial experience and perception of lit space as a starting point, the three studies converged in this paper are essentially based in a phenomenological, sensory ethnographical methodology (Pink, 2015, xi). As such, the methodological approach dissociates from the early anthropology of the senses, proposing a comparative anthropology separating our sensory modalities, and instead thinks about and does ethnography from an understanding of the senses as interconnected in human perception (Pink and Howes, 2010, 332-334). Consequently, the studies are concerned with bodily sensations as a means of inquiry, and not solely as an object of study. Moreover, by mixing and adding to the current methodologies within lighting research and addressing designerly potentials of coloured illuminations, the methodological framework of the three studies essentially takes on an interdisciplinary approach depending on other disciplines for its foundational ideas, in line with a sensory ethnographical approach.

On that note, the three studies have been structurally inspired by design research as laid out by Koskinen et al. (2011), taking place in ‘the lab’, ‘the field’ and ‘the showroom’. Hence, drawing from natural science, social science and the art world, the studies have respectively and chronologically occurred between 2017-2019 in a performance art manifestation (the showroom), a maternity ward counting a sensory delivery room (the field) and a lighting laboratory (the lab). Despite their different settings, all three studies have been rooted in and driven by an ethnographic methodology, primarily relying on and collecting data on sensory experiences by (participant) observations and interviews (Madden, 2010). Yet, the showroom study was also informed by data from cultural probes (Nielsen, Friberg, and Hansen, 2018), the field study by photos and mappings (Nielsen, Bille, and Barfoed, in review), and the lab study informed by video recordings and psychophysiological data, collected via an Empatica4 wristband sensor (Nielsen et al., submitted). Following a multisensorial approach to the study of experience and perception, the showroom study and lab study have furthermore considered sensory and embodied aspects of chromatic light beyond visual perception, in order to sharpen a conscious perception of the feel of colour illuminated space. Hence, people in these two studies were both blindfolded and non-blindfolded, while being bodily present in a space lit up by different spectra of light.

The following representations of bodily feels of lit spaces addresses the four spectra of white, blue, amber and red, and rest solely on the ethnographical interviews and observations collected during the three studies. Evidently, being personally, culturally and socially situated and skilled in the world, the expressions of bodily sensations of the particular light spectra have varied across people and studies. However, following a phenomenological body-sensory approach and carrying out extensive thematic analysis, some particular patterns have shown across both bodies and studies. A selection of these are presented below.

Bodily Sensations in Colour Illuminated Space

White

A bodily feel of being in an energized state was common to people being present in white illuminated space. Participants of the lab study would express how they felt “a higher tone” in their body, “like pfff!” or “like a busy bee.” Some felt it difficult to breathe and “a need of clarity and sharpness” in their movements. Comparatively, midwives working in the bright lights of a hospital experienced their bodies in a certain alert state: “Just try and feel it, it’s not very enjoyable, this light we are sitting in right now... I just don’t like being in it. I would never choose this light if I were to feel safe or relaxed or work,” one midwife expressed.

The energy of the white light could nonetheless serve as a supporting element for focus and speed in midwifery practices, if for example they had to apply a vacuum extractor (to pull the baby out of the womb), needed to see properly (while stitching up the perineum) or wanted for the birthing mother to “be woken to be ready.” Similarly, participants of the lab study felt more “rational” and detached from their “inner private mood,” when being bodily present in white illuminated space. In this relation, they perceived the space as a “big,” “neutral,” “dead” and “cold” “non-space” with a “rough,” “squared” or “hard” texture. As such, to some it was like the white illuminated space allowed them “to be physical without being in a certain mood.”

Blue

People across the three studies generally sensed the blue illuminated space as “infinite,” “distant” and “diffuse.” Some participants of the showroom and lab study compared it to “going into an aquarium” or the feeling of “being in a spaceship.” These spatial perceptions were followed by bodily movements and feels of “fluidity in the body,” sensations of having “a fish-body” or being “alone in a weird way.” One participant in the lab study comparatively expressed how she “felt more lost and not knowing where I was,” in the bluely lit space.

In this regard, people across the showroom and lab study described how they sensed a “silence,” “more space inside” and feeling “intuitive,” “more tactile” or “fragile.” When asked about if she knew a space like this, during the showroom study, one informant expressed: “Yes... Inside myself... It is melancholic and heavy... (...) Like being on deep water...” Furthermore, a cooling sensation was experienced in the blue across all three studies. One participant in the lab study expressed how “It was sort of a chilly calm... It is like at ease but icy.” In relation, midwives in the maternity ward experienced the blue illumination as “cold,” “brash” and “diffuse,” in which one midwife found “it hard to find peace.” Thus, midwives would generally favour the warmer hues and mainly introduce the more bluish lighting to support a “change in energy” to the birthing situation.

Amber

In the amber illuminated spaces people across the three studied felt the most supported, welcomed and protected. During the showroom study, one informant noted her bodily sensation as: “(It is) like maybe someone is carrying you... like a mother carrying you... it feels heavy and safe, like there is something all the way around you... like you are protected.” Another informant stated how “It feels like I belong to this space...” and a third how “It feels like an onion and that I am in the middle of it... well protected.”

Similarly, participants of the lab study would comparatively feel the space like “hugging me” or as “a good friend.” Furthermore, in the amber illumination, they smiled and expressed feeling “happy,” “careless” and “content” the most. One participant more-over sensed “a supportive atmosphere” where one “could just move.” At the maternity ward, this showed in midwives’ practices of searching the ward to track down adjustable architectural lamps. To them it all came down to reduce bright lights. As one midwife stated: “I’m trying to get [the light] as dimmed as possible, to create a sort of cave-like atmosphere.”

Red

Being bodily present in the red illuminated space people generally found their bodies in a “calming”, “dense” or “small” space across the three studies. During the showroom experiment, one informant had an intense bodily feel: “(It) is like I want to get out but I am not able to... It is not friendly at all... It is like something is keeping me back... I feel like a stone or a rock (...) I am stuck.” Another informant of the same study similarly stated a “feeling of not being alone... Because there is someone on top of you.” In line with the bodily sensations of slightly-pushing density, participants of the lab study generally moved in a more downwards manner by rolling, crawling or sliding around in the reddish illumination. One participant also noted how “I definitely felt the space pushing down... Not in a bad way but I was grounded.”

In the maternity ward, the reddish illumination of the delivery room was experienced less intensely, as “soothing,” “soft” and “cosy.” “I think... the word ‘gentle’ just comes to my mind. It’s such a gentle way to say welcome... where the light is not hard,” one midwife stated, while another experienced how “you lower your shoulders a little and feel welcome,” and a third midwife noted how she was “a bit more careful in there... I think that I am a little slower...”

Towards a Body-sensory Approach in Lighting Design

As laid out in above merging of empirical data of three studies on bodily sensations of lit space, different spectra of light seem to carry affective qualities to attune our bodily presence in different ways. From the energizing detachment of white, to the distant chill of blue, over to the caressing support of amber and the warm and slightly-pushing quality of red, luminous “atmospheres can suffuse all spatial contexts, in some spaces this is more affectively, emotionally and sensually profound than in others” (Edensor and Sumartojo, 2015, 252). Noting the awareness of bodily attunement in midwifery lighting practices, not only contextualizes the bodily feels of certain spectra of illumination from the showroom study and lab study, but moreover shows how chromatic illumination can attune certain practices, e.g. of focused work (in the white), changing energies (in the blue), intimacy (in the amber), or slow movements (in the red) in the delivery room. As such, the potential of designing with coloured illumination goes beyond visual needs and aesthetic delight by affecting our bodily existence and ways of practicing our world.

Thus, despite the evermore technology-entangled reality of our everyday lives, including new technologies of chromatic lighting, people insists on their bodily existence (Böhme, 2013a). Showing how luminous atmospheres are a fundamental part of human perception, that is, of the way in which we sense at once where we are, atmospheres of light shape a person's being-in-the-world as a multisensory whole. This is why atmospheres are extraordinarily significant for the theory and practice of architecture (Böhme, 2017a, 70). However, by taking on a body-sensory approach to study and understand the significance and potentials of today's chromatic lighting technologies, it becomes apparent how something is missing from the research on which we base our architectural lighting designs of today. While studying how light has an effect on performance, hormones and moods, recognition and considerations of our very bodily feel and existence within lit space are diminished. As such, this paper argues for qualifying current methodologies within lighting research by a body-sensory approach, which evidently calls for a revised and revived atmospheric, mindful awareness of 'the bodily feel' of lit space when designing with chromatic lighting technologies for architectural spaces.

References

- Bille, Mikkel. *Homely Atmospheres and Energy Technologies in Denmark. Living with Light*. London: Bloomsbury. 2019.
- Böhme, Gernot. "Atmosphere as the Fundamental Concept of a New Aesthetics." *Thesis Eleven* 36 (August, 1993): 113-26.
- . "Atmosphere as an Aesthetic Concept." *Daidalos - Berlin Architectural Journal* 68 (1998): 112-15.
- . "Atmosphere as Mindful Physical Presence in Space." *Oase* 91 (2013a): 21-31.
- . "The Art of the Stage Set as a Paradigm for an Aesthetics of Atmospheres." *Ambiances*, (October, 2013b): 2-8.
- . "Atmospheres in Architecture." In *Atmospheric Architectures. The Aesthetics of Felt Spaces*, edited by A.-Chr. Engels-Schwarzpaul, 69-80. London: Bloomsbury. 2017a.
- . "Seeing Light." In *The Aesthetics of Atmosphere - Ambiances, Atmospheres and Sensory Experiences of Space*, edited by Jean-Paul Thibaud, 193-204. New York: Routledge. 2017b.
- Edensor, Tim. *From Light to Dark - Daylight, Illumination and Gloom*. Minneapolis: The University of Minesota Press. 2017.
- Edensor, Tim, and Shanti Sumartojo. "Designing Atmospheres: Introduction to Special Issue." *Visual Communication* 14 (3) (June, 2015): 251-265.
- Koskinen, Ilpo, John Zimmerman, Thomas Binder, Johan Redstöm, and Stephan Wensveen. *Design Research Trough Practice - From the Lab, Field and Showroom*. 1st ed. Waltham: Elsevier Inc. 2011.
- Küller, Rikard, Seifeddin Ballal, Thorbjörn Laike, and Byron Mikellides. "The Impact of Light and Colour on Psychological Mood: A Cross-Cultural Study of Indoor Work Environments." *Ergonomics* 49 (14) (November, 2006): 1496-1507.
- Lockely, Steven, Erin Evans, Frank Scheer, George Brainard, Charles Czeisler, and Daniel Aeschlbach. "Direct Effects of Light on Alertness, Vigilance, and the Waking Electroencephalogram in Humans." *Sleep* 29 (2) (2006): 161-68.

Madden, Raymond. *Being Ethnographic: A Guide to the Theory and Practice of Ethnography*. Los Angeles: SAGE Publications Ltd. 2010.

Nielsen, Stine Louring, Ute Besenecker, and Ellen Kathrine Hansen. "More Than Meets the Eye: Sensing Coloured Illuminations in Space Through the Skin." *Nordic Journal of Architectural Research*. Submitted.

Nielsen, Stine Louring, Mikkel Bille, and Anne Berlin Barfoed. "Illuminating Bodily Presences in Midwifery Practices." *Emotion, Space and Society*. In review.

Nielsen, Stine Louring, Carsten Friberg, and Ellen Kathrine Hansen. "The Ambiance Potential of Coloured Illuminations in Architecture." *Ambiances. International Journal of Sensory Environment, Architecture and Urban Space* Theme Issue 4 (December, 2008): 0-27.

Pallasmaa, Juhani. *The Eyes of the Skin - Architecture and the Senses*. England: Wiley. 2012.

Pink, Sarah. *Doing Sensory Ethnography*. Edited by Jai Seaman. London: Sage Publications. 2015.

Pink, Sarah, and David Howes. "The Future of Sensory Anthropology / the Anthropology of the Senses." *Social Anthropology* 18 (3) (2010): 331-340.

From Parlour to Studio

The Sensory Experience in Contemporary Tattooing Spaces

Daniele LUGLI¹

Abstract. Tattoos have historically been marginalised and associated with deviancy. However, as they become mainstream, the experience of giving and receiving a tattoo changes, and so does the studio environment. This paper analyses design elements that set the contemporary tattoo studio apart from the traditional parlour, and how they shape the sensorial and atmospheric experiences of individuals. I present an ethnographic case study of a contemporary studio in Australia, suggesting that design interventions influence the way practitioners and clients engage with the space, with each other, and with tattoo culture. I use this case to build an argument for the importance of an atmospheric understanding of this design practice, as it signals an effort to detach itself from a stigmatised subculture.

Keywords. *Tattoo Culture, Sensory Ethnography, Aesthetic Experience*

Introduction

Focusing on Western tattoo culture, Atkinson (2003) divides its development in six moments: the Colonist/pioneer era (1760s-1870s), when Europeans first encountered tattooed indigenous people; the Circus/carnival era (1880s-1920s), when tattooed individuals performed as “freaks” on circus for money; the Working class era (1920s-1950s), when tattoos became more popular, associated with military and working men; the Rebel era (1950-1970), when tattooing was again rejected by society for its association with criminality; the New Age era (1970-1990), when tattoos became popular among a progressive middle-class as a sign of self-expression; and the Supermarket era (1990-2003²), when the tattoo industry expanded and reached a greater audience through conventions, magazines and TV shows.

Atkinson’s classification is useful for a historical overview but needs to be further developed as tattoo culture continues to change and become mainstream: the recent “ratification” of tattooing (Kosut, 2014) elevated its status and social acceptance, and the images and language around it have changed - for example, terms like “tattooist” and “gun” have been replaced by “tattoo artist” and “machine” respectively (Martin, 2019). However, contemporary tattooing is also unique in an experiential level, and I argue that an atmospheric understanding of tattooing would help capture the nuances of this phenomenon, because it would account for the sensory and affective aspects of the intimate and embodied experience of giving and receiving a tattoo.

Here I adopt the understanding that atmospheres comprise how material and immaterial inputs are felt in sensorial and emotional ways by individuals who experience

1. Monash University - MADA, Australia, daniele.lugli@monash.edu

2. Atkinson (2003) refers to it originally as “1990-present.” I suggest the end date of this period as 2010s.

them subjectively and in interaction with others and the environment, learning from the definitions in affective (Anderson, 2009), aesthetic (Böhme, 2016); and design (Sumartojo and Pink, 2019) literature. Understanding atmospheres is important as they mediate the way people engage with each other and their surroundings. In a practical sense, they cannot be created - an environment can be crafted in a certain way that allows them to emerge, but they ultimately rely on the way individuals will subjectively experience them.

In the context of tattooing, I consider the tattoo shop as the environment where the atmospheric experience takes place. It contains material inputs such as tools - tattoo machines, inks and needles, safety and cleaning gear - and the interior design, including floor to ceiling colours and textures, furniture and decor objects. These are complemented by inputs like the sounds of background music and the machine noise, the smells of cleaning products, the ambient temperature among others. Immaterial inputs can also refer to the overall "mood" of that space and how it evokes certain familiar sensations, such as "safe" or "welcoming." All these inputs are captured sensorially by people in that environment - practitioners and clients - and experienced emotionally by them, drawing from their expectations, previous experiences, and the intimate interactions happening between them in that particular moment.

Traditional tattoo shops were once dark and cluttered spaces, with loud music, bold colours on the wall, along with imagery such as skulls and sexualised women - a spatial representation of a subculture associated with deviancy, rebelliousness, lower class, and other forms of stigma. The vintage style of these early studios remained ingrained in tattoo culture, just like the American traditional tattoo designs never went out of style. Therefore, many elements of the old-school tattoo culture are still present in tattoo shops today, either because they have been in business for decades and preserved their original look, due to nostalgia or preconceptions of what a tattoo studio should look like.

However, as the tattoo industry becomes increasingly mainstream, some studios are redefined as bright and carefully curated spaces, far from the cluttered old school parlour or the flashy gangster shop. These particular types of space are discussed by Martin (2019) as "Neo-Bohemian" studios - the ones that arose in the post-industrial neighbourhoods and cater "to the middle class, artists, and students who are looking for a unique and more hip experience by entering an area that also showcases inner-city, urban, and lower-class characteristics" (54). By doing so, these studios are attempting to detach themselves from stigma and appeal to an audience that responds to such sensibilities.

It is no coincidence that the contemporary tattoo studio shares similarities with art galleries, coffee shops, beauty salons, design coworking spaces, and other types of businesses that are popular in gentrified neighbourhoods. They are all products of the same taste regime described more prominently by Jonathan Bean - influenced by the clean domesticity of Scandinavian design in Hygge lifestyle, the faux-artisan authenticity of Kinfolk magazine (Bean et al., 2018) and widely disseminated online through Pinterest and Instagram. Nonetheless, limiting the appeal of such spaces to their adherence to trends would be relying on an assumption that all clients have the same cultural capital that allows them to experience it in a uniform way. This position overstates the symbolic and underestimates the sensorial and subjective ways people experience their surroundings - attributes that are particularly relevant in the context of tattooing, as a highly intimate and embodied experience.

I argue that the contemporary studio, as a designed space, has specific sensory components that afford atmospheres to emerge as individuals to engage sensorially and affectively with each other, the space, and the culture of tattooing. In the next section, I present an ethnographic case study of one of these contemporary studios, in which I identify design interventions that make this space different from preconceived images of the traditional parlour, and discuss how these shape the sensorial and atmospheric experiences of clients and practitioners there.

Case Analysis

This ethnographic study was performed in 2019 and early 2020 at a contemporary studio located in an inner suburb of Melbourne, Australia, on a busy commercial street. The shop front is quite sober - etched glass windows and door with black frames and one hanging sign with the studio name. Inside, the open plan space is minimal in decor, but usually full with people. The waiting area is small, with a wooden bench and black pillows. Right in front of it, there is a wall made from light wood with potted plants and a white neon sign that says "it was all a dream" in cursive writing - a corner that clients constantly photograph and share on social media. On the right side, the wall is fully mirrored with a wooden counter - much like a beauty salon. However, instead of the seats facing the mirror, the workstations are composed of clean black massage beds, wheeled seats, and metal trolleys (Figure 1).



Figure 1. Overview of the studio space, Daniele Lugli, 2020

There are skateboards and a couple big pieces of artwork on the walls - colourful contemporary portraits of famous hip-hop musicians, painted by a local artist. The genre is often played as background music, along with pop and contemporary R&B, giving the studio an urban appeal that is popular with the young audience. These clients often bring along friends for their appointments, so the sound of laughs and chatter are also common. These are the predominant sounds in the space, since most artists use contemporary rotary machines that, unlike the traditional coil machines, are fairly silent. This not only makes a difference in the ambient sound, but also in the experience - as E., one of the artists says, the clients prefer them because the quiet machines feel less "scary." As a practitioner, she also favours them as they are light-weight and vibrate less.

When asked about the space, E. says that the studio where she worked before was dark and decorated with skulls, Japanese armour and masks, which made it "creepy"

in the evening. She prefers this one, because it is brighter and popular among female clients. The wooden front wall with the plants is another highlight, as she says it makes a great background for pictures of the finished tattoos that she posts on social media.

One client, T., sees the studio as an inclusive space, suiting both people who want something small and delicate as well as hardcore tattoo fans. She says that the clean and minimalist decor of the space stands out - "It's not what you would expect from a tattoo studio" - and this aesthetic, along with the fact that the studio has several female artists, makes it an inviting space for her. However, she prefers to book her appointments on Sundays, since the studio is quieter on those days - for her, the most important thing in a tattoo studio is cleanliness, so she can feel safe, but she also wants it to be a somewhat private, comfortable and relaxed environment.

I asked T. about her previous experiences with tattoo studios. She said they looked very traditional and were spaces where most of the dark spaces with old school tattoo designs on the walls, red and black as the main colours, and heavy metal playing on the radio - "the kind of place that your grandmother would be shocked to go to!"

Discussion

In this analysis, I do not intend to limit the atmosphere of the studio to the aesthetic elements of the space or focus on the possible symbolic meanings of such elements. Following Böhme (2016), I look away from the objects' *expression*, such as form and functionality, to concentrate on the *impressions* they make and how they contribute to the embodied experience. I also acknowledge that the ways individuals perceive and make sense of those sensory inputs is ultimately subjective, and certainly the human interactions between tattoo artists and clients are a meaningful and complex part of the experience. However, such engagements are mediated by space and materiality.

Feelings and sensations such as "inviting," "comfortable" and "relaxed" mentioned by T. are more likely to emerge in an environment like the contemporary studio. The clear and bright space increases the sense of safety (Böhme, 2016), and the layout, similar to a beauty salon, evokes familiarity even for a first-time visitor. In addition, the non-specific aesthetic is more accessible for a mainstream audience - "inclusive" in the words of T. - as opposed to the traditional tattoo parlour that displays elements of traditional tattooing so ostensibly that clients might feel unwelcome if they are not part of that subculture.

Despite being a small corner and relatively distant to the action of tattooing, I identify the wooden wall with the plants and the neon script as a significant part of the experience. It is one of the first things clients encounter when entering the space, and what they see while waiting. Within the taste regime described by Bean et al. (2018), the natural characteristics of the corner evokes homeliness on a sensorial level and, as a carefully curated decor space, it affords the studio a sense of luxury, dissociating it from the lower-class stigma and validating the work performed there as "tasteful." Moreover, it is playful, since the quote invites people to imagine what is the said "dream" (my informed guess is that it refers to the lyrics of "Juicy" by The Notorious B.I.G.), and it is active in the sense that it participates in people's routines - the clients capture it to post on social media, publicly "checking-in" at the studio, and the artists use it as a background to photograph their finished work.

The design interventions are not limited to the presence of certain elements, but also the absence of others. The absence of darkness and certain imagery, such as the

“creepy” skulls and masks mentioned by E., makes the space less intimidating for people who, like T., are looking for a relaxed tattoo experience. The absence of the loud machine noise, also in E.’s words, makes the clients feel less scared about the procedure, and might even decrease their physical discomfort. This challenges traditional understandings that tattoos are “earned” symbols of endurance to pain and, consequently, who feels entitled to carry them.

These examples are evidence of an ongoing movement within the now mainstream tattoo culture to move away from the long-standing stigmas attributed to the tattoo subculture. As pointed by Sumartojo and Pink (2019), atmospheres relate not only to how places feel, but also to what they mean. Therefore, while this can be pertinently problematised as commodification (and indeed has been by authors like DeMello, 2000), the fact that these businesses flourished in an industry rooted in tradition signals a deeper shift in the forms of engagement between people and space, and between individuals within that space creating a potential for further change.

Conclusion

In this paper, I argued for an atmospheric understanding of tattooing, looking at the tattoo studio as a designed space where individuals engage sensorially and affectively with their surroundings, with each other and with tattoo culture more broadly. I presented an ethnographic case study of a contemporary studio and discussed how the presence of certain design elements and the absence of others afford the emergence of an atmosphere that distances mainstream tattooing from the stigmas and pre-conceptions of traditional tattoo subculture. As a single case analysis, this study is only a starting point for further investigation on the topic. The findings, however, are helpful for signaling other aspects to be observed in future studies, such as the smaller actions surrounding the act of tattooing, and how gender might play a role in this context.

References

- Anderson, Ben. “Affective atmospheres.” *Emotion, Space and Society* 2 (2009): 77-81.
- Atkinson, Michael. *Tattooed: The Sociogenesis of a Body Art*. Toronto: University of Toronto Press, 2003.
- Bean, J., Khorramian, A., & O’Donnell, K. “Kinfolk magazine: anchoring a taste regime.” *Consumption Markets and Culture*, 21 (2018): 82-92.
- Böhme, Gernot. *The Aesthetics of Atmospheres*. London: Routledge, 2016.
- DeMello, Margo. *Bodies of Inscription: A Cultural History of the Modern Tattoo Community*. Durham: Duke University Press, 2000.
- Kosut, Mary. “The Artification of Tattoo: Transformations within a Cultural Field.” *Cultural Sociology* 8 (2014): 142-158.
- Martin, Chris W. *The Social Semiotics of Tattoos*. London: Bloomsbury Publishing, 2019.
- Sumartojo, Shanti and Sarah Pink. *Atmospheres and the Experiential World: Theory and Methods*. New York: Routledge, 2019.

Architectures, Technologies, and Stadiums Atmospheres

Abstract. The aims of this work are to understand some changes in the behavior of football spectators and fans in the stadium. For that, the analysis considers the architecture of new stadiums in one hand, the evolution of elite football in Europe in another hand, and the links with fans by a sociological approach. The information is coming from academics researches and journalists commentaries. The results show that the necessity to struggle against hooliganism and violence of the ultras, the football spectacle commodification, the building of new sport facilities, and the ticket price policy to make them profitable, induced the gentrification of the public. As a former French professional footballer said, “In the past, the fans encouraged, today, they sing.”

Michel RASPAUD¹

Keywords. Stadiums, Architectures, Design, Technologies, Sensitization

Introduction

Over the past two decades, new stadiums have been built, radically different from the previous ones, with a dual purpose: comfort on the one hand, and commercial on the other. But, what are the consequences for the fans and the atmosphere during matches? With the Covid-19 pandemic, many human activities were affected (professional, commercial, artistic, sports, etc.). Among them, elite football has been interrupted on almost the entire planet and if, during June 2020, certain competitions have resumed, it is behind closed doors that is to say without audience: spectators, supporters, fans, to use the categorization of J.-M. Roux (2014). This question of behind closed doors is controversial, especially among fans (ultras) for whom it is anti-football. In May 2020, more than three hundred European groups of ultras co-signed a press release to express their opposition to the resumption of the championships under these conditions: “We are firmly convinced that returning to the stadium would exclusively serve economic interests [...]. However, we strongly call on the competent bodies to continue to suspend football competitions until going to the stadium has become a habit without risk to public health” (Appadoo, 2020). Therefore, behind closed doors distorts the atmosphere of matches.

This position of the ultras refers to the status the football match occupies in their lives, the importance of participating almost weekly in this festive ritual of communion with the team of which they are fans, in the animation of the stadium and in the atmosphere they help to create which constitutes a good part of the show. Football match is not played only on the pitch, but also in the stands, and more particularly in the club supporters' stands.

1. Laboratoire SENS (EA 3742), Université Grenoble Alpes, France, michel.raspaud@univ-grenoble-alpes.fr

But this position is also linked to the economy that elite football has developed. In particular the dependence on television rights and the fact that the clubs have no financial reserve, like Manchester United, one of the richest in Europe, which asked his supporters to waive the refund of their subscription (Guillou, 2020); or Olympique Lyonnais, which obtained a pre-agreement for a State-guaranteed loan of € 92.6 million (L'Equipe, June 23, 2020). If supporters are aware of the financial risks that clubs face, they dream more of the game than profit (Hernandez, 2020), and today “they are no longer the only ones to say that this [economic] model is not sustainable” (Guillou, 2020).

Transformation of Architectures

However, since the early 2000s, within the framework of projects to organize major international sporting events (continental championships, world cup, multidisciplinary sports games), or in order to have more modern, large and profitable infrastructure, many football stadiums have been built, leading to a change of location for resident teams. In England, we can cite Arsenal, Tottenham, West Ham in London, Manchester City; in Germany, Bayern Munich; in France, Lille OSC, Girondins de Bordeaux, Olympique Lyonnais, OGC Nice; in Portugal, Benfica and Sporting in Lisbon, FC Porto; in Spain, Atlético Madrid, etc. These stadiums are, for the most part, radically different from those existing previously, even if sometimes they are reconstructed on the same site or near the old one (Benfica, Tottenham...).

In the past, two types of stadiums have been built:

1. The stadiums on the British model, properties of the clubs, which have developed a very particular architecture, specific to the exclusivity of the game of football: the stands are parallel and close to the pitch, spectators are close to the players. Enclosed in their neighborhood of origin, surrounded by houses, as for the old stadium of Leicester City FC, Filbert Street, which wall of its south stand was adjoining houses, so no extension was possible. These stadiums, over time, have undergone multiple successive redevelopments and modernizations (Inglis, 1983), producing a very heterogeneous architecture from the different stands, but at the same time charged with the history of the stadium and the club. In France, the stadiums of Lens (Bollaert-Delelis) and Saint-Etienne (Geoffroy-Guichard) are the best examples of this type of architecture.



Illustrations 1 and 2. RC Lens stadium in the 1960s and during Euro 2016 (photos: rights reserved).

2. The other model is the multi-sports stadium, built with public funds, and which can accommodate different sports (football, rugby, athletics, cycling). Its location was generally far from the city center. Separated from the field by a running track and a cycling ring, spectators were far from the spectacle

of the match. Today, the new stadiums, whether they remain inserted in their original urban environment (Arsenal, Tottenham) or moved to the periphery, respond to an architectural model that broadly refers to the ellipse made of two levels of stands, built around a pitch exclusively reserved for football. Designed by specialized and renowned architectural and engineering firms like Populous (formerly HOK Sport), Buro Happold, Arup, etc., these new stadiums are free, internally, of any sign linked to the history of the club. Their name even responds most of the time to the mercantile concerns of naming: Emirates Stadium (Arsenal), Etihad Stadium (Manchester City), Groupama Stadium (Lyon), Orange Vélodrome (Marseille), Matmut Atlantique (Bordeaux); the Allianz company multiplying: Allianz Arena (Munich), Allianz Riviera (Nice), Allianz Parque (Palmeiras Sao Paulo).

Effects of Architectures and Marketing

In a seminal article, Tim Edensor specifies the dialectical conditions for the production of the atmosphere in stadiums:

“The stadium possesses architectonic qualities that promote and contain levels of noise, and organize the distance between fans, and the closeness of fans to the pitch and players. These spatial contexts contribute to atmospheres of varying intensity that continually emerge during a match [...]. Atmosphere is moreover, a co-production that involves players, match organizers and fans. In exploring the importance of atmosphere in the match-day experience, I will subsequently focus on the changing conditions under which contemporary football atmospheres are produced, considering the tensions that emerge when clubs attempt to stage atmosphere, further alienating fans whose are already uncomfortable about stadium relocation, intensified commercialization and growing regulation” (Edensor, 2013, 1).

Thus, the architectural characteristics of the new stadiums, the materials used in their construction produce acoustics which contributes as an important part of the atmosphere of a stadium. In ancient times, theaters were designed to amplify sound. In contemporary architecture, the verticality, the inclination or the height of the stands are important parameters. While the Parc des Princes (Paris) or the Signal Iduna Park (Dortmund) are incredible sound boxes, the Santiago Bernabeu stadium (Real Madrid) or the Camp Nou (FC Barcelona), on the other hand, are too high or curved, and do not offer the possibilities of creating the same atmosphere. As for the Velodrome stadium (Marseille), renovated for the 1998 World Cup, it was a real fiasco, the architect having wanted to make it “a flower open to Provence” (Marchand, 2020), without taking into account the reality of the matches and the ambiance aspirations of supporters.

For Jean-Michel Roux (2014), the reputation of stadiums is based on the representations we have of their atmosphere. Thus, in France, the stadiums of Lens, Saint-Etienne, the Parc des Princes in Paris or the Velodrome in Marseille (especially since its expansion and coverage for Euro 2016) are perceived as exceptional. Because the atmosphere refers to three complementary challenges:

1. The economic issue relating to the sale of an event (the match), the profitability of the equipment itself, the development of the sports show business that is the club;
2. The social challenge which consists in creating and maintaining a collective identity (of the city, of the region), but also of the public as in Lens;

3. The political stake which consists in signifying the advent of a territory, of a nation. However, for Jean-Paul Callède (2016), the “new sports cathedrals” are of unprecedented architectural and monumental audacity, and constitute technological prowess, æsthetic virtuosités, innovation in the way of approaching the sporting spectacle. Christophe Bonnotte (2016) stresses that their vocation is to express a form of power, of authority, that of the private investors in whose name they are made, and whose names they sometimes bear (naming). It is obvious that these stadiums exalt a form of economic power, that of the clubs which built them. However, as indicated above, the economic model is fragile (Martel, 2020; Pedro, 2020).

Jean-Michel Roux (2014) identified that the public is made up of three categories:

1. The spectators, who come to see a show, they want to get their money’s worth;
2. The supporters, who attend a match by supporting one of the two teams, they are stakeholders, they come to encourage their own;
3. The fans (or ultras, socios, torcedores ...), who are committed and militant supporters, who want to weigh collectively on the outcome of the match, to win their team.
4. These last two categories are the atmosphere during the match (but especially the fans), and spectators come to the match for this total spectacle, that of the lawn and the stands.

However, under the effects of the development of hooliganism and the violence of ultras during the decades 1980, 1990 and again 2000, the sports authorities on one hand, political on the other hand. They took drastic measures leading to prohibitions of stadiums for some supporters, the suspension of grandstands, matches behind closed doors, and the prohibition of movement of the supporters to follow their team away. At the same time as this form of ‘sanitation’ was implemented, football changed its economic dimension in particular to the substantial increase in television rights, but also by the substantial increase in the price of subscriptions (+ 1000% between 1991-92 and 2011-12). The result is the gentrification and the aging of the public (average age of 35 years in 1995 to 41 years in 2015) (Auclair, 2020). These new stadiums are built for the television show on one hand (pay channels), and to increase revenues related to hospitality (VIP boxes). Security measures have led to the removal of terraces (standing places) and video surveillance. Moreover, today, in UK, several clubs have reintroduced the terraces because it is a demand from the fans and this allows to create an atmosphere more favorable to the total show. In France, they also led to a ban on the introduction of smoke bombs and their use before the match (and even more during ...). All this of course weighs on the expression of the fans, especially since the clubs organize their own matches in the mode of the spectacle (deafening music, giant screens...), some American-style staging and actions appearing to contradict tradition and being hated by fans like Edensor (2013) give an example in Manchester City.

Thus, a very recent information report made to the National Assembly of the French Republic (Buffet and Sacha, 2020) highlights that a certain number of these measures are liberticidal, and do not respect the law of defense, the perpetrators of the incident not even being heard in the context of an adversarial debate! In addition, the IAS (Interdiction Administrative de Stade / Administrative Stadium Ban), originally designed to combat violence, “is widely used to punish supporters for other acts, mainly the possession or use of smoke bombs” (Pécout, 2020).

Conclusion

Regarding the stadium, Pierre Sansot noted that “it is the noise that gives life and mobility to this heavy material. The clamor, the whistles, the songs, the applause or even the unanimous breathing of the multitude awakens the concrete” (Sansot, 1986, 86). Nowadays, as J.-M. Roux (2014) remarks, stadiums are built by renowned architects, have great technological sophistication, “but their» authenticity “is now manufactured.” Thus, with these new architectures, but also to want to make profitable each component of the club, one smothers the flame of the supporters and the fans. The Premier League show has become a happening for wealthy people.

The sociology of the stands has changed a lot, but so have the stadiums: West Ham (London) lost emotion when leaving Upton Park for the Olympic stadium, Arsenal by choosing the Emirates, Atlético Madrid by leaving Vicente Calderon for the Wanda Metropolitano (Sowden, 2020). Taking up the neologism of tradium forged by John Bale (trade + stadium) (Roux, 2014), it appears that the “intense emotionality” (Sansot, 1986, 74) that spectators, supporters and fans seek through the “experience” has diminished. As former AS Saint-Etienne player Patrick Revelli points out, “the supporters I have known at Geoffroy-Guichard and those of today have nothing to do with it. Before, they were encouraging, now they sing” (quoted in Marchand, 2020).

Few stadiums like Dortmund have the incredible “yellow wall” (gelbe wand), the world’s tallest standing stand (24,454 fans). As Saïd Ennjimi (former French international referee) reports: “In Dortmund, facing the yellow wall, you have to look up. But it also depends on the architecture of the stadium” (Marchand, 2020).

References

- Appadoo, Dave. “Quand les ultras changent de tribune.” *France Football* 3858, 3 juin 2020: 12-13.
- Auclair, Philippe. “Angleterre. Silence, on joue!” *France Football* 3858, 3 juin 2020: 14-17.
- Bonnotte, Christophe. “Séance d'ouverture.” In *Les nouvelles cathédrales du sport*, edited by UNCU and UJSF, 12-4. Pessac, MSHA, 2016.
- Buffet, Marie-George et Houlié, Sacha. *Rapport d'information sur les interdictions de stade et le supporterisme*. Paris, Assemblée Nationale, n° 2984, 22 mai 2020. http://www.assemblee-nationale.fr/dyn/15/rapports/micsuppor/l15b2984_rapport-information.pdf
- Callède, Jean-Paul (2016). “Séance d'ouverture.” In *Les nouvelles cathédrales du sport*, edited by UNCU and UJSF, 19-25. Pessac, MSHA, 2016.
- Edensor, T. (2013), “Producing atmospheres at the match: Fan cultures, commercialisation and mood management in English football,” *Emotion, Space and Society*, <http://dx.doi.org/10.1016/j.emospa.2013.12.010>
- Guillou, Clément. “Pour les supporters, il faut prendre son temps avant de rejouer,” *Le Monde*, dimanche 17-lundi 18 mai 2020: 17.
- Hernandez, Anthony. “Les supporters de l’OL rêvent de jeu, pas de profits.” *Le Monde*, jeudi 27 février 2020 : 15.
- Inglis, Simon. *The Football Grounds of England and Wales*. London: Willow Books, 1983.

Marchand, Thierry. "Emportés par la foule." *France Football* 3858, 3 juin 2020: 6-11.

Martel, Clément. "Pandémie : le football français fait le gros dos." *Le Monde*, samedi 4 avril 2020: 18.

Pécout, Adrien. "Supporteurs de football : «la politique du tout répressif» dénoncée." *Le Monde*, jeudi 21-vendredi 22 mai 2020: 16.

Pedro, Alexandre (2020). "Surcotée, la Ligue 1 vit à crédit," *Le Monde*, jeudi 16 avril 2020, p. 18.

Roux, Jean-Michel. "L'ambiance des stades." *Urbanisme* 393, 2014: 60-62.

Sansot, Pierre. *Les formes sensibles de la vie sociale*. Paris, Presses Universitaires de France, 1986.

Sowden, Patrick. "Le top 30 des stades les plus chauds du monde." *France Football* 3858, 3 juin 2020: 20-21

Reusing Atmospheres

The Case of the Adaptive Reuse of the Lombroso Pavilion

Francesca LANZ¹

Abstract. The paper is a contribution to the analysis of the role and nature of the built environment in mind museums - former asylums turned into museums. It notably focuses on the adaptive reuse intervention implied in the design of these museums by revolving around the concept of atmosphere. By building on the case of the Museum of the History of Psychiatry in Reggio Emilia (IT) the paper examines how the peculiar atmosphere of the museum premise has been in play and worked out in the museum design. In doing so, it posits atmosphere as a designerly element alike other material and immaterial ones characterising the site and points out how such a perspective can provide a fruitful position for delving into the role of design in the overall project of a mind museum.

Keywords. Atmosphere, Adaptive Reuse, Mind Museums, Museum Design

Mind Museums and the 'Power' of the Site

Most basically, a 'mind museum' is a former asylum turned into a museum (Moon et al., 2015, 79-84; Coleborne and MacKinnon, 2011; Bruggeman and Schmid-Krebs, 2007; Maj, 2013). However, it is not only a museum of the own history of its premise, or a historical museum of psychiatry. A mind museum rather, is a site-specific and place-based cultural institution devoted to the representation of the history of psychiatric care and treatment that has the chief mission to foster critical reflections and informed discourses on the histories and contemporary problems of managing mental health in society, eventually promoting awareness and dismantling stigma about mental health today².

In mind museums, similarly to other 'site of conscience', the site itself with its 'power' is crucial in determining and supporting the museum work (Sevcenko, 2010; 2011). Therefore, when it comes to study mind museums, among other issues, the nature and the role of the site - one that is particularly meaning and memory loaded and strongly evocative - shall be carefully analysed in its various implications. This means assessing how material and immaterial features of the building are played out and put into play in the overall design of the museum - i.e. its spaces and its practices - with which intent and effects, as well as evaluating how visitors react to and make sense out of them.

1. Department of Architecture and Urban Studies - Politecnico di Milano, Italy. Media Culture Heritage Department, School of Arts and Cultures - Newcastle University, United Kingdom, francesca.lanz@polimi.it

2. The definition and study of mind museums is at the core of the ReMIND Project, from which this paper ensues. ReMIND is a two-year research project funded in 2019 from the European Union's Horizon 2020 research and innovation programme under the Marie Skłodowska-Curie Actions, grant agreement No. 841174 and hosted at Newcastle University School of Arts and Cultures. <https://research.ncl.ac.uk/remind/> (Accessed June 2020).

As already discussed by other authors in relation to memory sites, the concept of atmosphere may provide productive insights into this, in relation not only to how these places feel but also to what they do, how they do it and what they mean (Sumartojo and Pink, 2019; Turner and Peters, 2015; Sumartojo, 2016; 2019; Sumartojo and Graves, 2018). All the more so in mind museums; indeed, even though “atmospheres can suffuse all spatial contexts, in some spaces this is more affectively, emotionally and sensually profound than in others” (Edensor and Sumartojo, 2015, 252) and this is doubtless the case for former asylums spaces hosting mind museums.

Crucially however, the ‘spatial context’ of a mind museum is not downright a former asylum. Most precisely, and decisively, it is the result of an adaptive reuse intervention onto the original spaces of a former asylum aimed at turning them into a very specific type of museum. This paper focuses on this issue by building on the analysis of the Museo di Storia della Psichiatria (Museum of the History of Psychiatry), in Reggio Emilia, in Italy³.

From Asylum to Museum

The Museo di Storia della Psichiatria is hosted at the Lombroso pavilion, one of the original buildings of the former San Lazzaro psychiatric hospital in Reggio Emilia. As many other asylums in Europe and overseas, the San Lazzaro hospital was established in the early 19th century within a positivist approach, in the belief that insanity should be ‘treated’ and could be cured and that the built environment could play a role in doing so (Airoldi et al., 2013; Crippa and Galliani, 2013; Topp et al., 2007). Throughout the 19th century, San Lazzaro grew up and became famous all over Italy and Europe. At the beginning of the 20th century, it was a sort of small self-sufficient town, which included more than 20 buildings organised in a cottage plan with about 2.000 patients hospitalised every year. Shortly after that moment onward however, the hospital started a slow and regrettable decline, which characterized many other psychiatric institutions worldwide, and that eventually led to their closure at the turn of the 60s (Foot, 2014; Paulson, 2012).

In 1978 in Italy, the so-called Basaglia Law (L.180) ratified the closure of all asylums. However, across the whole country, deinstitutionalization was all but a straightforward and easy process, and the closure of asylums took years. The same happened at San Lazzaro hospital, which buildings had been progressively abandoned from 1978 onward and the last patients dismissed only in 1997. In 2009 a plan for the rehabilitation of the whole area – 296.792mq – has been eventually implemented, involving the reuse of several former asylum premises for different purposes, including a museum of the history of psychiatry to be hosted at the Lombroso pavilion.

The Museo di Storia della Psichiatria opened in 2013 with the chief mission to serve as a place displaying the history of the San Lazzaro hospital and promoting knowledge and awareness about mental health care in the past and in the present. To do so, the museum can count on rarely rich and diverse collections pertaining to the hospital life and practices and, above all, on its very peculiar venue: i.e. the former Lombroso

3. *The study is based on extensive desk research on direct and indirect sources including: a comprehensive literature review on the museum and its history; the study of historical records from the museum archive; the analysis of architectural drawings and technical reports related with the architectural intervention; transcriptions from three school visits. Desk research is complemented by fieldwork including: direct observation of two guided tours, interviews with the museum staff and the chief designers involved in the museum project.*

pavilion (Tagliabue, 2013; Grassi et al., 2013).

The Lombroso pavilion dates back to 1892. It was originally named Casino Galloni and it was devoted at hosting “calm chronic patients.” In 1911, after the Legge Giolitti in 1904 imposed the creation of specific sections in psychiatric hospitals for the isolation of “mad criminals,” the Casino Galloni was converted to this purpose. It was enlarged by adding two lateral wings hosting the cells and named after the doctor Cesare Lombroso. During its lifespan, the Lombroso pavilion had been going through minor changes and used until 1972, when it was considered obsolete and redundant and thus disused. After the hospital closure, there has always been an idea to establish a museum at the former San Lazzaro asylum, notably by reusing the former Lombroso pavilion; however, even though a call for project was launched in 1978, the project was not realized (Zambonini, 1980). The pavilion continued to decay, while the debate on a possible museum kept on growing in the following years, paving the way to the creation of the Museo di Storia della Psichiatria.

Encountering a Place, Designing a Museum

When the urban rehabilitation plan for area of the former San Lazzaro hospital started in 2009, the asylum memory was still resonating in the city’s memory in many ways despite the site was totally disused since more than 10 years. Almost anyone in Reggio Emilia knew the San Lazzaro, either for direct experience or hearsay. At the same time, whilst well known by almost all citizens, ‘stories’ and ‘legends’ were circulating about the asylum, and, it was a ‘mysterious’ and ‘ghostly’ place in the city’s collective imaginary.

The San Lazzaro was not a totally unknown space either for Giorgia Lombardini, the municipality architect in charge for the reuse of the Lombroso, although she was never been there before 2006 when she did the first preliminary site visit. She recalls that many at that time were asserting that, due to the advanced status of decay of the Lombroso pavilion, ‘there was nothing special there’ that could be valorised by any kind of restorative intervention. However, after she visited the site, she saw it differently.

“Despite the manifest deterioration - she writes in her reports - the place was emanating an atmosphere of rare uniqueness; at a closer look, one less superficial and more sensible, beyond the stained surfaces and the ruining structures, the place was allowing to be half-seen extraordinary potentialities and a remarkable formal and aesthetic value.”

Her encounter with the place determined her design approach, backing up the choice for a reuse project chiefly based on restorative measures. As Lombardini explains, the overall intervention has been aimed at preserving the spatial features of the building fabric as well as its materiality, by following the guiding principle to ‘integrate’ what was missing not by replacing it, but rather by evoking the same aesthetic impression, in order to ‘maintain intact the peculiar atmosphere of the place.’ Specific interventions secured the building and cleaned it from infesting vegetation, detritus, and rubbish left behind by squatters. Accurate surveys were carried out and historical and archival researches were done. On site construction-works started in 2009 and concluded in 2011. Structural interventions have been realised either adopting the same techniques and materials in the case of refurbishment - e.g. in the reconstruction of the collapsed vault and wood roof - or with self-evident interventions in case of new additions - as for the steel tie-rod structure aimed at reinforcing the floors and improve

the seismic reaction or new technical systems and plants realised at sights. Wall surfaces have been cleaned eliminating more recent painting layers, squatters' graffiti and signs on inner fires. Interior wall finishing have been restored and a specific attention has been payed to original 19th century mamorino plasters and to graffiti done by patients in different ages using spoons and soles. The same happened with other architectural elements and details and furniture, such as the cells doors, through and through similar to those of prisons; table and benches in the former dining room fixed and distributed in the space according to security and surveillance rationales or the cells windows; or blinders and radiator control valves, that could not be used and adjusted from the inside requiring a hospital operator to do so. As part of the reuse intervention moreover, the building containment wall, demolished in 1974 has been "recreated." The wall, has been rebuilt on the same size and location of the original one, but as a wireframe structure realised in corten steel, with the twofold aim to symbolically evoke the former wall and to serve as a support for temporary outdoor exhibition.

Reusing Atmospheres: Cues for Debate

Atmosphere and the idea of atmosphere had an important role in the project for the Lombroso pavilion, variously coming into play within the different project stages. Firstly it was a designerly inspiration, determining the architect's design approach. Then, atmosphere became an actual object of intervention being the whole project not aimed at creating or recreating a specific atmosphere, but at 'maintaining intact' the existing one. Finally, a specific atmosphere resulted from this design process, one that inherently characterizes the site today and that has a crucial role in how the museum works.

This raises the question: is it possible to preserve an atmosphere? How?

Lombardini resolved for a restorative project to do so. It implied a mindful intervention, grounded on accurate on-site preliminary surveys and in-depth historical research, attentive to the building fabric, its material and architectural features and details; based on architectural preservation techniques and the work of skilled labourers and professionals. However, regardless the accuracy of the intervention and its actual results, the objective Lombardini set herself was an impossible one to achieve in many regards.

Firstly and most obviously, because atmospheres are ongoing and inherently individual phenomena (Sumartojo and Pink, 2019). As any atmosphere, the one Lombardini sensed was something largely subjective, influenced by her knowledge and foreknowledge about the site and its history, imaginaries of the public discourse and collective imagination about asylums in general and San Lazzaro in particular, and by her background as an architect. Most crucially however, the materiality of the site and other 'generators' of that atmosphere (Böhme, 2013) could not be actually kept intact in any way through any kind of intervention, precisely because of it.

Indeed, albeit it aims to conserve the building at some extent, an adaptive reuse intervention is a designed form of transformation of a disused architectural assemblage, intended at making it apt to be used again for a new purpose, which is different from its original or previous ones in functional and/or behavioural terms (Scott, 2018; Brooker and Stone, 2019; Plevoets and VanCleempoel, 2019; Wong, 2019; Stone, 2020).

To do so the intervention works with and reworks the material and immaterial elements characterising the preexisting building that crucially involve also its atmosphere. Atmosphere thus shall be considered a designerly element alike other material and

immaterial ones characterising the site and constituting what Machado called a “‘package of senses” of built-up meaning to be accepted (maintained), transformed or suppressed (refused)’ through an adaptive reuse intervention (Machado, 1976, 49). From such a perspective, as this case demonstrate, rather than a design practice somehow aimed at preserving an atmosphere, adaptive reuse intervention becomes a practice of designing with atmosphere and designing atmosphere – i.e. a ‘process for attending to what already exists and how the affordances of these elements might be augmented, ameliorated or transformed through design processes’ (Sumartojo and Pink, 2019, 13).

Obviously, notwithstanding the attentive restorative approach of the intervention carried out at the Museo di Storia della Psichiatria, the site hosting the museum today is something different from the Casino Galloni, the Lombroso pavilion, or the ruined asylum leftover it had been before, so is its atmosphere. This is not to say that accounting for atmosphere in adaptive reuse intervention, especially in the case of a mind museum, is not worth. Quite the contrary. At the Museo di Storia della Psichiatria the museum ‘spatial context’ resulting from the reuse intervention, plays a key role in the museum work. Along with the objects on display, the media installations and the contribution of the guides and the ‘cultural mediators’ who accompany visitors, the museum site, its materiality and architectural details have an essential role in the museum visit. They support and illustrate it spurring visitors’ physical and emotional engagement, eventually contributing for a certain atmosphere to emerge in the museum with some specific implications and effects (Turner and Peters 2015). As this case demonstrate, thinking adaptive reuse through atmosphere and considering atmosphere as part of the ‘package of senses’ to be reworked by the adaptive reuse intervention implied in the creation of a mind museum, can provide productive insights into adaptive reuse both from a practical and analytical point of view. On the one hand, it can help addressing how the place and its ‘power’ can be used, reused and designed in these museums and with which effects. On the other, it supports a needed yet still overlooked critical assessment of adaptive reuse interventions onto the built heritage in relation to the cultural significance, interpretative and selective dimension of heritage practices (Lanz and Whitehead 2019; Pendlebury et al. 2018).

References

- Ajroldi, C., et al. (eds). 2013. *I Complessi Manicomiali in Italia tra Otto e Novecento*. Milan: Electa.
- Böhme, G. 2013. “The art of the stage set as a paradigm for an æsthetics of atmospheres.” *Ambiance*.
- Brooker, G., STONE, S. 2019. *Re-readings 2*. London: R.I.B.A.
- Brüggemann, R., Schmid-Krebs, G. 2007. *Locating the Soul*. Frankfurt am Main: Mabuse.
- Coleborne, C., MacKinnon, D. (eds). 2011. *Exhibiting Madness in Museums*. New York: Routledge.
- Crippa, M. A., Galliani, P. F., (eds.). 2013. “Conoscenza, Conservazione, Valorizzazione degli Ex Ospedali Psichiatrici Italiani.” *Territorio* (65): 60-105.
- Edensor, T., Sumartojo, S. 2015. “Designing Atmospheres: Introduction to Special Issue.” *Visual Communication* 14 (3): 251-265.
- Foot, J. 2014. *La ‘Repubblica dei Matti’*. Milan: Feltrinelli.

- Grassi, G., Farioli, E., Bombardieri, C.. 2013. "Perché parlare oggi di psichiatria e della sua storia." *Rivista Sperimentale di Freniatria* 87 (2): 75-94.
- Lanz, F., Whitehead, C. 2019. "Exhibiting Voids." In *Handbook of Art and Global Migration*, edited by B. Dogramaci, and B. Mersmann, pp.331-348. Berlin; Boston: De Gruyter.
- Machado, R. 1976. "Old Buildings as Palimpsest." *Progressive Architecture* (11): 46-49.
- Maj, B. 2013. "'Museen der Seele' (Museums of the soul)." *Rivista Sperimentale di Freniatria* 87 (2): 15-29.
- Moon, G., Kearns, R., Alun, J. 2015. *The Afterlives of the Psychiatric Asylum*. Farnham: Ashgate.
- Paulson, G. W. 2012. *Closing the Asylums*. Jefferson: McFarland.
- Pendlebury, J., Wang, Y., Law, A. 2018, "Re-using 'Uncomfortable Heritage'." *International Journal of Heritage Studies* 24 (3): 211-229.
- Piddock, S. 2007. *A Space of Their Own*. New York: Springer.
- Plevoets, B., Van Cleempoel, K. 2019. *Adaptive Reuse of the Built Heritage*. London: Routledge.
- Scott, F. 2008. *On Altering Architecture*. London; New York: Routledge.
- Sevcenko, L. 2010. "Sites of Conscience." In *Cultures and Globalization*, edited by Helmut K. Anheier, and Yudhishtir Raj Isar, 114-118. London: SAGE.
- . 2011. "Sites of Conscience." *Museum International* 62 (1-2): 20-25.
- Stone, S. 2020. *UnDoing Buildings*. London: Routledge.
- Sumartojo, S. 2016. "Commemorative Atmospheres." *Transactions of the Institute of British Geographers* 41 (4): 541-553.
- . 2019. "Sensory Impact." In *Doing Memory Research*, edited by D. Drozdowski and C. Birdsall, 21-37. Singapore: Palgrave Macmillan.
- and Graves, M.. 2018. "Rust and dust." *Journal of Material Culture* 23 (3): 328-343.
- , Pink, S. 2018. *Atmospheres and the Experiential World*. London: Routledge.
- Tagliabue, L. 2013. "Il valore di un Museo della Psichiatria a Reggio Emilia." *Rivista Sperimentale di Freniatria* 87 (2): 95-111.
- Topp, L., Moran, J., Andrews, J. (eds). 2007. *Madness, Architecture and the Built Environment*. London: Routledge.
- Turner, J., Peters, K. 2015. "Unlocking carceral atmospheres." *Visual Communication* 14 (3): 309-330.
- Wong, L. 2017. *Adaptive Reuse*. Basel: Birkhäuser.
- Zambonini, R. et al. (eds). 1980. *Il cerchio del Contagio*. Reggio Emilia: Istituti neuropsichiatrici.

The Agency of Perception

A Perceptual Apparatus as a Tool for Critique and Subversion, Action and Mediation

Izabela WIECZOREK¹

Abstract. By exploring a series of perceptual devices, which constituted a notable disciplinary expansion in the fields of art, architecture and design, particularly in the 1960s, the aim of this paper is to present apparatuses as instruments of embodied knowledge. The key proposition is that, situated in a liminal space between aesthetics and politics, perception and action, the discussed devices can be seen as tools of both critical analysis and radical intervention. They act as ‘performative manifestos’ which by acknowledging the agency of perception and by challenging conventions, reveal alternative spatial, somatic and societal realities, raising ‘atmospheric awareness’ and promoting a co-production of new ecologies.

Keywords. *Perceptual Apparatus, Radical Practices, Immersion, Atmospheric Awareness*

Performative Manifestos

Taking as a point of departure, Karen Barad’s definition of apparatuses as “dynamic (re)configurings of the world, specific agential practices/intra-actions/performances” (2003, 816, emphasis in original), the intention of this paper is to discuss the notion of a perceptual apparatus as a tool of both architectural critical analysis and radical intervention. That is, an apparatus that transcends its merely scientific connotations as well as quantitative logic, becoming instead a projective interface: qualitative, performative and affective.

Investigating and exploring such an apparatus should focus on its use as well as its design. In this sense, the design process is not, however, limited to a device as an *object*. Similar to Barad who defined apparatuses as “open-ended practices” (2003, 816), the Austrian artist and architect Walter Pichler described a whole series of devices and spatial interventions developed in the mid 1960s as *Prototypes*, suggesting “something from which something could later emerge” (Breitwieser and Pichler, 1998, 31). Additionally, what comes to the fore while thinking of perceptual apparatuses - for example the *Sensory Objects* (1966-69) of the Brazilian artist Lygia Clark - is that they are situated in a liminal space between *propositions* and *actions*, in which the object acquires “meaning and structure only in the moment of direct bodily interaction with the spectator” (Brett, 1994, 61). Within their paradoxical non-utilitarian nature, the purpose of perceptual apparatuses, is to “manipulate phenomena in the same way that architecture does - using space, time, sound and materiality to interact with its audience in a performative relationship” (Lim, 2006, 006). Such apparatuses may include instruments of observation that define perceptual and conceptual boundaries for (self-)knowledge production, creation and action; and devices of defamiliarization

1. School of Architecture, University of Reading, UK, i.z.wieczorek@reading.ac.uk

that re-enact bodily and environmental awareness by challenging objective reality and by revealing expanded perceptual worlds and alternative spatial possibilities.

A key proposition here is that perceptual apparatuses can be seen as instruments of embodied knowledge, used to construct, test and communicate new arguments and radical thoughts by means of experience and reflection, opening up a wide range of modes of engagement (individual and collective) with the material world. They are thought- and action-provoking *performative manifestos* that by acknowledging the agency of perception, reveal the creative power of observing bodies, providing a critique of the limits and potentials of architecture itself.

The Generative Power of Observing Bodies

In *Techniques of the Observer* (1992), Jonathan Crary explores the vast field in which perception and its comprehension were transformed, tracing a particular taxonomy of visual apparatuses in which immersive experiences relocated vision within a “carnal density” (1992, 150), converting the human body into an integral and active part of visual machinery. Exploring the origins of that specific epistemological transformation, Crary stresses the important shift from the passive spectator to the *observing body* that becomes both receptor and producer, involved in a dynamic and kinæsthetic relationship with other bodies and surroundings. In this sense, the use of the term observer carries specific connotations. As Crary explains, etymologically, the term observer “means ‘to conform one’s action, to comply with’. (...) [A]n observer is more importantly one who sees within a prescribed set of possibilities, one who is embedded in a system of conventions and limitations” (1992, 5-6).

The varied devices considered in this paper constitute a particular family of apparatuses, in which conventions and habits are destabilised, perceptual thresholds are redefined, internal worlds are exteriorised, and human bodies mobilised. They represent a larger disciplinary expansion in the field of architecture and design, which notably occurred in the 1960s, overlapping with artistic practices of that time.

It was at the beginning of the 1960s that the visual arts, through performances and happenings, reintroduced the human body not only as a subject of representation but also as a medium of expression and a locus of experience. Within this new creative framework, body and perception became central to the artistic production of the aforementioned Clark. She is of interest here not only for her *Sensory Objects*, but also for the architectural analogies that strongly resonate in her work². Following her belief that living in “architectural reality” is “To live in perception. To be perception in itself” (Clark, 1965, np), she developed a series of garments, armours and bodily envelopes that became “extensions of the skin” (McLuhan, 1964) - to allude to Marshall McLuhan’s conception of clothing as media of communication that shape collective consciousness. However, rather than McLuhan’s focus on clothing’s codification of social order, Clark’s bodily extensions shape collective (and political) consciousness through bodily involvement and interaction. In Clark’s works, “[t]he new skin seems to use the body as a kind of medium or resounding chamber for registering its presence and innovation” (Best, 2005/2006, 94), challenging dichotomies of subject/object, mind/body, and individual/collective. Resonance, as noted by Jean-Paul Thibaud, “involves the ability of the body to incorporate and be affected by vibratory forces: its capacity to engage with, be penetrated by and participate in the actual ambiance”

2. See, for instance: *Fantastic Architecture Critters* (1963), *The House is the body, The Body is the House* (1968-69), *Biological Architecture Birth* (1969).

(Thibaud, 2011, np.). Accordingly, Clark's devices can be seen as tools for engaging with and transforming ambiance, exploring reciprocal capacities of affecting and being affected.

Clark's *Sensorial Masks* (1967), designed as a series of hoods with incorporated ear-pieces and nose-pieces, shifted attention from visual to non-visual experience, stimulating olfactory, auditory and tactile sensations. Tactility was also pivotal to Clark's *Sensorial Gloves* (1968) and *Abyssal Mask* (1968), which through the enhancement of the sense of touch questioned inside/outside relationships. While the aforementioned hoods and other perceptual devices such as *Googles* (1968) manipulated or restricted sight, using coloured filters and mirrors, suits such as *Straitjacket* (1968) restricted the movement of the body. Through bodily manipulations, sight, touch, smell and hearing became paradoxically both communication channels with the external world and vehicles of introspection, giving rise to societal, political and technological re-configurations of the body. In other words, Clark's *Sensory Objects* were awareness-arousing apparatuses, enacting body's affective, transformative and generative capacities.

Interestingly, while analysing sensory thresholds defined by new technologies, McLuhan assigned to art a new role of programming "anti-environments" that entailed creating particular situations, raising awareness "of the environment, in which we live and of the environments we create for ourselves technically" (McLuhan, 1967, 165). Such an idea was pivotal to many of the devices developed at that time in the field of architecture and design, conceived as "vehicle[s] for opening up new horizons of consciousness and outlook on life" (Blomberg, 2014, 98), as noted by Günter Zamp Kelp, one of the founding members of Haus-Rucker-Co³. Moreover, in a similar way that Clark's 'propositions' stimulated affective participation in the world, entailing the rupture with the object and furthering the "dematerialisation of art" (Lippard and Chandler, (1968) 1999), Haus-Rucker-Co's apparatuses represented "a dismantling and redefinition of architecture" (Blomberg, 2014, 108). They were devices charged with a critical potential, questioning modernist disembodiment and self-referentiality. By intertwining pleasure and irony, they were both devices of resistance and devices of critique orientated towards a possible future, liberating the generative power of the felt-body.

In Search of Atmospheric Awareness

Not only did perceptual apparatuses require bodily interaction in order to come into being, they would not have worked without an existing context, as Ortner emphasised (Blomberg, 2014, 112). The purpose of these devices was to produce atmospheric resonances by bringing the body into a relation with the surrounding ambiance, drawing attention to atmospheric conditions and atmospheric imbalances. It is precisely attention that "builds into the gap of perceiving and re-acting" as noted by Siegmund Gerald in his analysis of the notion of apparatus (2009, 339). Through channelling attention - that is, through creating an 'anti-environment' by means of somatic alterations or dislocation of perception - perceptual apparatuses stimulated reflections on physical and perceptual forces embedded within the environment, replacing passiveness and inattentiveness with active engagement.

Many of the devices had a prosthetic character and were designed as a "mini-environment to be worn on the body" (Porch, 2009, 23). Known as *Environment Transformers* (1968), Haus-Rucker-Co's *Flyhead*, *Viewatomizer* and *Drizzler* were conceived as such

3. Haus-Rucker-Co was an avantgarde group founded in 1967 in Vienna by Laurids Ortner, Günther Zamp Kelp, Klaus Pinter, and later joined by Manfred Ortner.

bodily extensions. They were helmets or masks with incorporated sight-filters, lenses and/or headphones, meant to “alter sensory impressions” that are “very often taken for granted,” regaining “a real contact with the world” (Porch, 2009, 23). Unfolding technological metaphors, many devices resembled a science-fiction costume prop as in Haus-Rucker-Co’s *Electric Skin* (1968) that acted as both a transformative medium and a vehicle of communication. Others, such as Coop Himmelb(l)au’s *Soul Flipper* (1969) and *White Suit* (1969), were conceived as sensorial activators, intensifiers of phenomena, and orchestrators of emotions. While *Soul Flipper* translated emotions into visual and auditory effects, *White Suit* expanded vision through olfactory and haptic sensations, translating it into bodily awareness. Other devices were conceived as immersive micro-environments which by dragging the subject into expanded perceptual worlds stimulated particular patterns of behaviour - like Haus-Rucker-Co’s *Yellow Heart* (1967-68), or the whole series of installations and devices entitled *Immersion* (1968-71) by the Italian architect and designer Ugo la Pietra, belonging to the Radical Design Movement.

However, regardless of their character, perceptual devices were meant to develop “aggressive energies that influence people physically and psychologically” (Porch, 2009, 23) - as described by Haus-Rucker-Co in their *Mind Expanding Programme* (1967-70). By exaggerating, intensifying, and mastering the senses, they conditioned and modulated experience of the city, questioning architecture’s social and environmental responsibilities. They were what La Pietra defined as an *Unbalancing System* - vehicles for subversion of the uniformity and normativity of the city, introduced into the urban fabric to induce moments of perceptive, behavioural and organisational imbalance.

La Pietra’s objective was to destabilise the regulating powers of the city “by means of the analysis and identification of the environmental and social situations within which we found ourselves living, with a critical physicality” (La Pietra 1991, 15). For him the body was an instrument of interpretation and knowledge production, and his *Immersion* were certainly embodiments of that critical physicality; devices through which he attempted to break a “mummified” equilibrium or habit, and to “re-awaken the dulled imaginative faculties of the spectator and the citizen” (Dorfles, 1971, 3) of the citizens - as noted by Gillo Dorfles in the introduction to *Il sistema disequilibrante*. However, is that even though La Pietra’s apparatuses employed immersion as a means to separate the individual from the surrounding ambiance - similar to Pichler’s *Small Room* (1967) and *TV-Helmet* (1967) - they were meant to be relational devices. They were not merely perceptual tools, but spaces that offered themselves “as a point for critical and imaginative reflection on the context itself” (La Pietra, 1972, 226). That is, for “a real comprehension of the social and psychological conditions in which we are ‘immersed’” (Trini, 1970, 30). As La Pietra explained, it was through disrupting the perception of reality by immersion and alienation that a critical reality was created and dynamic relationships set in motion, strategically pushing “toward a certain behaviour” (La Pietra, 1972, 226). In this sense, perceptual devices can be seen as instruments of atmospheric attunement, guiding not only ways of seeing the environment, but also showing potential for change. It was “an attunement of the senses, of labors and imaginaries to potential ways of living in or living through things” (Stewart, 2011, 453) - to borrow Kathleen Stewart’s words.

In conclusion, not only tools of defamiliarization - a transgression of propriety or a critical resistance to sensorial regimes - perceptual apparatuses are, above all, instruments of embodied knowledge. They offer new ways of understanding design and knowing through atmospheres, exploring conditions, actions, and processes through which atmospheres are disclosed and to which they give rise. As ‘dynamic (re)configurings

of the world', they render atmospheres not as fixed qualities of space and things, but as contingent, situational and relational, acquiring meaning only in the moment of the direct engagement of people with them. By intertwining critique and introspection, perceptual devices can also be seen as carriers of particular moods, invoking behavioural change. Thus, they are as much tools for raising atmospheric awareness as the actual generators of atmospheres.

References

Barad, Karen. "Posthumanist Performativity: Toward an Understanding of How Matter Comes to Matter." *Signs: Journal of Woman in Culture and Society* (The University Chicago Press) 28 (3) (2003): 801-831.

Best, Susan. "Lygia Clark (1920-1988) Bodily Sensation and Affect: Expression as Communion." Edited by Art Association of Australia and New Zealand. *Australian & New Zealand Journal of Art* 6/7 (2/1) (2005/2006): 82-104.

Blomberg, Katja, ed. *Haus-Rucker-Co. Architekturutopie Reloaded*. Berlin: Haus am Waldsee, 2014.

Breitwieser, Sabine, and Walter Pichler. "A conversation with Walter Pichler." In *Prototypen/ Prototypes 1966-69*, by Sabine Breitwieser, edited by Sabine Breitwieser, 27-34. Vienna: Generali Foundation, 1998.

Brett, Guy. "Lygia Clark: In Search of the Body." *Art in America* 82 (7) (1994) : 56-63.

Clark, Lygia. "1965 About the Act." Lygia Clark. Accessed October 10, 2017. <http://www.lygiaclark.org.br>.

Crary, Jonathan. *Techniques of the Observer. On Vision and Modernity in the Nineteenth Century*. Cambridge, Massachusetts, London: MIT Press, 1992.

Dorfles, Gillo. "Preface." In *Il sistema disequilibrante*, by Ugo La Pietra, 2-3. Genova: Edizioni Masnata, 1971.

Gerald, Siegmund. "Apparatus, attention and the body: the theatre machines of Boris Charmatz." In *Planes of Composition. Dance, Theory and the Global*, edited by André Lepecki and Jenn Joy, 318-345. London, New York, Calcuta: Seagull Books, 2009.

La Pietra, Ugo. "1960-1990: Thirty years of experimental research." In *Ugo La Pietra. Monographs on Contemporary Design*, by Pierre Restany and Maurizio Vitta, translated by Carme Artal and Graham Thomson, 14-16. Barcelona: Editorial Gustavo Gili, 1991.

La Pietra, Ugo. "The Domicile Cell: A Microstructure within the Information and Communications Systems." In *Italy: The New Domestic Landscape. Achievements and Problems of Italian Design*, edited by Emilio Ambasz, 226-231. The Museum of Modern Art, 1972.

Lim, Cj. *Devices. A manual of architectural + spatial machines*. Amsterdam, London: Elsevier Architectural Press, 2006.

Lippard, Lucy, and John Chandler. "The Dematerialization of Art." In *Conceptual Art: A Critical Anthology*, edited by Alexander Alberro and Blake Stimson, 46-51. Cambridge, Massachusetts, London: The MIT Press, 1999.

McLuhan, Marshall. "Clothing: Our Extended Skin." In *Understanding Media. The Extensions of Man*, by Marshall McLuhan, 119-122. London: Routledge & Kegan Paul Ltd., 1964.

McLuhan, Marshall. "The Invisible Environment: The Future of an Erosion." *Perspecta* (Yale University, School of Architecture) 11 (1967): 161-167.

Porch, Johannes, ed. *Austrian Phenomenon: Architekturavantgarde Österreich 1956-1973*. Vol. Vol 2. 2 vols. Wien: Architekturzentrum Wien, Birkhäuser, 2009.

Stewart, Kathleen. "Atmospheric Attunements." *Environment and Planning D: Society and Space* 29 (2011): 445-453.

Thibaud, Jean-Paul. "A sonic paradigm of urban ambiances?" *Journal of Sonic Studies* 1 (1) (2011).

Trini, Tommaso. "Le «Immersioni»." In *Il sistema disequilibrante*, by Ugo La Pietra, 30. Milano: Edizioni Galeleria Toselli, 1970.

Culture of Creation

The Atmosphere of Objects

Abstract. As human beings we are constantly immersed in different atmospheres and spontaneously associate them with space. We propose here to focus on atmospheres of objects. In over more than two decades of experience with Satyendra Pakhalé Associates, we have developed a research program complementary to studio practice. While designing objects, we investigate their related atmospheres and cultivate a deep understanding of human perception and sensoriality referring to multiple sources. With the intention to empower the ability of objects to contribute to the broadest necessities of human - social and sensorial - being, here we focus attention on the invisible aura that surrounds objects and evokes specific feelings. We call this holistic practice as 'Culture of Creation'.

Satyendra PAKHALÉ¹,
Tiziana PROIETTI²

Keywords. *Sense spheres, Poetic Analogy, B.M. Horse, Kayo, Add-On Radiator*

Introduction

We live in a world where everything is designed or in need to be designed: from the buildings we inhabit to the smallest tools or objects that accompany our daily gestures and actions. While entering space, we encounter, both physically and mentally, a variety of objects that we use, plan to use, or simply imagine or recall from past experiences. Every single object has a sort of immaterial substance that surrounds it. Therefore, whenever we design an object, we are also, often unconsciously, generating its related immaterial presence.

Studies on perception in architecture have associated it with the concept of 'atmosphere', borrowed from geology and physics. Juhani Pallasmaa refers to it as featured by an "ephemeral, unfocused and non-material experiential character" (Pallasmaa, 2014, 2). Tonino Griffèro called it "quasi-thing" (Griffèro, 2017), since it appears and disappears, and one can never be sure whether it truly exists or not. Atmosphere is something you cannot distance yourself from. It constantly regenerates itself and asks for your immediate reaction and response.

Given the abundance of objects that populate our lives, it is urgent to bring attention to their atmosphere, pondering how they affect our daily life. In order to deepen the subject, we present the design practice of Satyendra Pakhalé Associates as related to studio research, that we call Culture of Creation (Alessi et al., 2019). Culture of creation is the place of making, thinking, discussing, acting, contemplating, questioning, all animated by a tireless research at the root of the meaning of creation. In this context, the idea of objects' atmosphere is understood as a part of a bigger picture

1. *Satyendra Pakhalé Associates*, satyendra@satyendra-pakhale.com

2. *University of Oklahoma*, tiziana.proietti@ou.edu

- where multiple topics - including poetic analogy, sensorial design, social modernity, technology and craftsmanship, secular humanism - converge to expand their own meaning. Here we place attention on the concept of atmosphere by showing how some connections with related topics are embodied in a broader thinking as well as in the studio practice.

An Insight into Atmospheres

The Totemic Presence of an Object

Across history human beings have created an endless variety of objects that have tirelessly served the everyday life of people. Sometimes their physical presence resembled a living creature, quietly standing on hold for action. The ancient Greek *chytras* - versatile cooking pots used to store food and liquids, cook or carry fire - were often placed in circle around the fire at the center of the space. Tall and undecorated, with their rounded and irregular body, were in a sense alive, surrounding the fire and patiently waiting to be heated. They served humans' daily necessities while completing and animating the space. Similarly, the Indian *lota* pot, like many pots across the world, has a presence that completes the space. It has an architectonic appeal. Like the *chytra*, it is an ordinary everyday object, just like any good industrial design object we use today. It is a resourceful object, not task specific, but versatile in its utility. Its real magical feature is the 'generosity of an object' that has been used for the most mundane utilitarian everyday act and also for the most sacred rituals.

The sophisticated design of an object is the main vehicle in generating a powerful atmosphere. The perfect balance reached in the design of the *lota* pot is expressed by the control of the dynamic of the fluid while carrying or pouring liquids, the tactility of the object changing according to the gestures and uses, the magic turning into gold color once cleaned, the way it reacts to sunlight with endlessly varying tones. Unfortunately like many things in India, these atmospheric perceptual features of the *lota*, made of metals like brass, copper or recently in stainless steel, are almost disappearing from the Indian domestic landscape, replaced by cheaply made pots in molded plastics, often made in China. This has deprived the object of its magic atmosphere.

In the modern and contemporary world there are still examples of this basic totemic presence of an object, such as the Kikkoman soy sauce dispenser by Kenji Ekuan (1961). It is remarkable how such a small object can generate such an expanded atmosphere. Indeed, the scale of the object says nothing about the scale of its atmosphere. It is a very common problem with so many objects with spouts that they drip and there is never such precise control on the quantity of liquid you pour. With sophisticated innovative technology, Ekuan created a new gesture by simply controlling the airflow with the index finger and allowing the right amount of liquid to pour onto the dish. The result is an iconic piece of design that connects with people universally.

The perfect control of liquid pouring and the resulting harmonic poetic gesture of the Kikkoman bottle can exist only at the touch of someone's finger, just like the totemic presence of the *chytra* in an ancient Greek dwelling can only manifest itself in the presence of someone willing to touch and activate the big standing pot almost asking to meet the fire. It is by interaction of our senses that the sensorial qualities and atmospheres of objects are activated.

Expanding from Within

Already centuries ago, early Buddhist realization conceived the senses as “instruments or mediums joining together the external spheres of sensory activity with the internal spheres of perception” (Stanford Encyclopedia, 2006, 3.3). Senses are ‘receptacles of experience’ rather than physical organs. They can be described as a set of internal-external pairs of sense spheres. The internal sense bases are the ‘sense organs’: eye, ear, nose, tongue, body, mind. The external sense bases are the ‘sense objects’: visible objects, sound, odor, taste, touch, mental objects. Together they constitute twelve ‘sense spheres’ called *āyatana*. Human beings are therefore gifted, according to this interpretation, with six main senses, that include the mind. Alongside the main six senses there are many others, such as sense of life, movement, balance, temperature, speech, etc.

In early Indian sculpture, still visitable in ancient monumental sites such as Ajanta, Bharhut, and Sanchi (Rawson, 1966), the interaction between internal and external sense spheres, between the subject and the object, has been emphasized by the sculptor’s methods. The characteristic roundness and thickness of volumes, well described by Philip Rawson (Rawson, 1966), invites you to experience the stone carving as a center that expands from the inside out. Concavities are rare and reserved to special parts in the form of soft channels. The exaggeratedly-rounded outlines, subtracting some adherence to reality, draw attention to the ‘inside’ suggesting the presence of some kind of entity. The object is animated and its atmosphere expanded.

Ettore Sottsass, like many other architects, designers and artists such as Charles Eames and Constantin Brancusi, were fascinated by Indian art. Sottsass, clearly inspired by Indian methods of sculpture, describes how the thickness of the object affects its sensoriality: “All the dimensions are slightly thicker than would be needed, and the corners round instead of straight, because if the corners are round you don’t have a feeling of the line of the corners, but you have the feeling of the two surfaces as a whole continuum, and they give you much more the feeling of a volume which is filled by matter and things of that kind” (Sottsass, 1986). Nuovo Milano flatware, 5074 oil and vinegar condiment set are examples of how Sottsass worked to enhance objects’ visual, sensorial and atmospheric presence by sculpting their shape. A similar approach can be found in the work of Isamu Noguchi, Tapio Wirkkala and Sori Yanagi among other designers.

Poetic Analogy of Objects

One unique insight of early Buddhist realizations consists of understanding the mind as a sense organ, just like the ear or eye. This gives the opportunity to rethink the concept of atmosphere by pondering how it interacts with our intellect. Indeed, the atmospheres trigger our imagination and memory relying on our ability to grasp and decode information coming from the outside world.

In the daily task of discerning, simplifying, categorizing different information, we tend to search for those that are easy to grasp. Generally speaking, we search for relevant generic information and store them. In doing so, we rely on universal common denominators, constancies, enduring forms that are constituent parts of uncountable forms, and that we can process, associate and even expand upon. In this act of decodification and rationalization, we are able to build an infinite set of associations that facilitate the task whilst nurturing our imagination. “We do not simply apprehend an object. Rather, we apprehend it as the locus of a multiplicity of associations” (Stanford Encyclopedia, 2009, 3.3) that stretch the boundaries of any univocal definition of it.

The object relates with the user in a very peculiar manner. The more it expands its 'realm of associations' the more the user relates with it. In doing so, it leaves space to a kind of 'self-identification'. Not by chance, the power of analogical associations has been at the core of art since antiquity. The aptitude of projecting the image of our functions upon the outside world and reading the external reality on our own terms is ancient and profound. It is a way to humanize the world through 'analogies'.

"The 'meaning' of forms is thus seen to reside in their suggestions of similar forms seen and remembered from other contexts" (Rawson, 1957, 142) or in their "poetic analogy" as defined by Philip Rawson. As Dietrich Seckel says: "the more abstract a visual sign is, the truer and more effective it is. An image fulfills its purpose all the more if it reaches the boundary of all form, and allows the step into the realm beyond all form. (...) Beyond all images, even the most sublime, there is always one more step" (Seckel, 2008, 56-57).

Culture of Creation

Generating Atmospheres

Atmospheres relate differently with people, but somehow few objects are able to produce such atmospheres that go beyond personal feelings and become universal. They resonate with human senses in a very primal, deep manner. These are the atmospheres that last. At Pakhalé Associates we approach design with the idea to generate atmospheres and shape them around human physical, sensorial and social necessities in the context of their environment. Atmospheres are manifested through all facets of object's presence, enriched with poetic analogies, sensorial qualities, technological innovations, social modernity and, sense of secular humanism.

The idea that man invents his own realities is not a new one. It is found in diverse philosophies and teachings. 'Culture' is not something given. Rather it is people who shape their culture by constantly manipulating conventional symbols taken from a variety of ever-changing codes in order to create new meanings. With this insight, the act of design is very much understood in the studio practice as 'Culture of Creation'.

Not embellished with any mystic or religious meaning, creating is an integral part of human life, manifested in "making." There is an analogical connection between the more ample meaning of creation, which belongs to nature, and the smallest expression that is brought into being through human action. 'Culture of Creation' engages with the very roots of the human necessity to create, to design, to make, bringing something to become reality. We look at objects as centers of expansion while keeping in mind their physical and immaterial presence in every step of the design process.

B.M. Horse

The B.M. Horse (2000) is a totemic object. This seamless piece produced by means of the lost-wax bell metal casting process is a totemic chair, part of the B.M. Horse Family (B.M. Horse Chaise Longue, Stool, Lo Table and Hi Table). It is produced in limited editions with sandblasted and patinated surface finishing (Ammann Gallery, Germany).

When seated on the B.M. Horse one has the feeling of being empowered and acquiring a strong presence in the surrounding space. The user becomes part of the B.M. Horse. Nowadays the act of sitting is mainly related to the necessity of comfort and functionality, but across history sitting had much broader meanings. The B.M. Horse is like a 'contemporary throne', but not in the meaning of social hierarchy or status. It is an

object designed to empower everyone. The refined abstraction and convexly curved form of the B.M. Horse opens endless analogies whilst conveying the sense of empowerment experienced in the space with its own vigorous character. This sense of personal empowerment is more than a feeling, it is a capability to transform oneself that comes directly from the generated object's atmosphere. With and on it the user 'exists' in the space with an enhanced presence.

Kayo Extensible Table

Kayo (2015) is an extensible table with only two supporting pivots and pioneering bent glass technology. Kayo's main plane on bent glass legs and its extensible parts are connected by a compact mechanism, allowing extension of the table from a two to an impressive three-meter span.

Gathering around a center has often been described as the beginning of architecture. In antiquity this center was the fire, today it is often a dining table. Gathering allows people to feel part of a family or a community. The center exists because of the people, and as soon as they gather the table becomes almost invisible. What matters is the feeling of becoming "one." An invisible table that generates a sense of unity is what we wanted to create. Kayo is designed to almost disappear in the space and expand its boundaries into an invisible space within the physicality of the room. The sense of gathering and being together is animated by the object's design and its related atmosphere.

Add-On Radiator

Add-On Radiator (2004) can be placed on a wall, recessed or used as a space divider connected to floor and ceiling. It is a hydraulic and electric radiator with an effectively larger surface area, manufactured in pressure die-cast aluminum which offers faster temperature regulation with less energy consumption.

The idea of Add-On Radiator was to create a new experience by taking the radiator off the wall. This was to generate an atmosphere that could exist at the center of the space without being confined to its perimeter. Radiators are usually thought as integrated with the walls by diminishing their presence and atmosphere, as well as their efficiency. Add-On radiator was designed to warm the space where needed with the personality of an object: a presence in the space with its own modest dignity. Add-On Radiator is a typological and technological innovation that creates a new atmospheric possibility for a traditional object. It is a technological product and a sculpted piece as an assembly of modular elements creating rhythmic volumes and densities evoking an atmosphere.

Conclusion

Being idealistic and aspirational, 'Culture of Creation' is nurtured by Pakhalé's studio practice as a way of thinking and approaching design culture - not aimlessly following commercial consumerism and market demands but by investigating the roots of the culture of making, be it based on high-tech or sheer craftsmanship, but always aimed at creating sensorial qualities and the generation of atmospheres. It is by balancing all aspects of design - addressing human needs, utility of object, manufacturing possibilities, and all aspects that explore the objects in its multifaced sensoriality - that atmospheres emerge in its most powerful expression as a composite amalgamation.

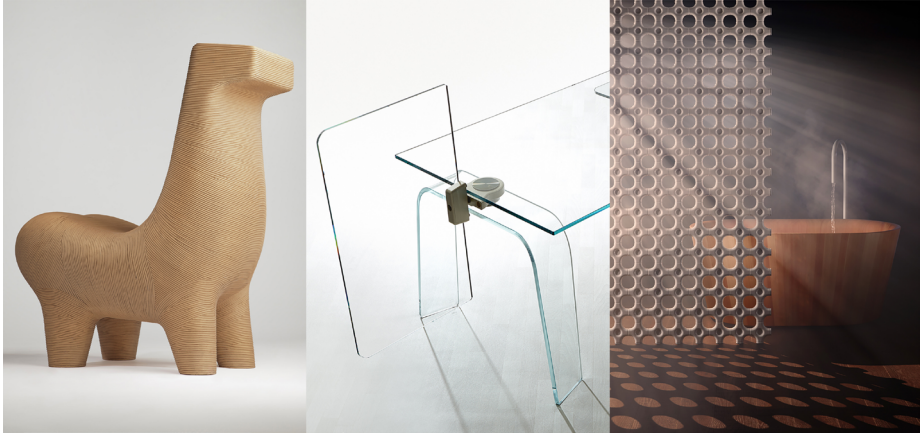

Figure 1. S. Pakhalé. *B.M. Horse, Kayo, Add-On-Radiator* (2000, 2015, 2004). Amsterdam: SPA, 2020

References

Alessi Alberto. et al. *Satyendra Pakhalé. Culture of Creation*. Rotterdam: nai010 publishers, 2019.

Böhme Gernot. et al. *Architecture and Atmosphere*. Espoo: Tapio Wirkkala-Rut Bryk Foundation, 2014.

Dietrich Seckel. *Before and Beyond the Image. Aniconic Symbolism in Buddhist Art* (1976). London: Paul Holberton, 2008.

Griffero Tonino. *Quasi-Things: The Paradigm of Atmospheres*. New York: State University of New York Press, 2017.

Pidgeon Monica. "Ettore Sottsass. A Sensorial Technology." Interview with Sottsass Ettore. London: Pidgeon Audio Visual, 1984.

Rawson Philip. *Indian Sculpture*. London: Studio Vista, 1996.

Stanford Encyclopedia of Philosophy, "Mind in Indian Buddhist Philosophy." Accessed May 22, 2020. <https://plato.stanford.edu/entries/mind-indian-buddhism/>

Designing With Fog

Abstract. Designing with Fog traces the development of 10 Kinds of Fog: Prototypes, a set of ten ephemeral, dynamic, and environmentally-responsive fog sculptures. Developing the installation required that, as designers, we had to find fog - that we go on a journey from seeing fog as a carrier and enabler, to seeing it as a material with properties that can be explored and designed with. It built on a proposal for an immersive, multi-sensorial Fog Garden, in which fogponics carried plant nutrients. Explorations into ways of delivering, shaping and releasing fog in relation to the plants led to an increasing understanding of fog's own behaviour. Finding fog was thus attuning to changes in buoyancy, litheness and opacity arising from the relationship between materials and the environment.

John SADAR¹,
Gyungju CHYON²

Keywords. Atmospheric Design, Environmental Performance, Installation Art, Materiality

Designing With Fog

Designing With Fog traces the development of *10 Kinds of Fog: Prototypes*, a set of ten ephemeral, dynamic, and environmentally-responsive fog sculptures. In addition to the more conventional materials that designers work with, such as electronics, plastics and textiles, was the slippery substance we call fog. As defined by philosopher Tonino Griffero, fog is the prototypical *quasi-thing* in that it oscillates between being a material phenomena which can be perceived in itself, and one which colours our experiences and it thus inseparably coupled to them (Griffero 2017). Developing the installation required understanding fog not only as a phenomenon, but seeing it as a material with properties that can be *explored* and *designed with*, and that affords opportunities to the designer. It required that, as designers, we had to *find fog* - that we go on a journey from seeing fog as a carrier and enabler, to seeing it take a central role.

Finding Fog

10 Kinds of Fog: Prototypes emerged from a proposal for an immersive, urban *Fog Garden*, utilising fogponics. *Fog Garden* was exhibited in Ljubljana during the BIO50³. Developing the work meant considering water's peculiarity: its being solid, liquid and gas at atmospheric conditions; it being substance which we experience with the full gamut of our senses; being a carrier of energy and nutrients; and being both a universal solvent and a medium for life. Fogponics - using electronically-produced water vapour as a carrier of nutrients for plants - demonstrated water's multifarious qualities simultaneously.

1. Swinburne University of Technology - School of Design, Australia, jsadar@swin.edu.au

2. Monash University - Faculty of Art, Design and Architecture, Australia, gyungju.chyon@monash.edu

3. Jan Boelen and Vera Sacchetti, *Designing Everyday Life*, trans. Rawley Grau and Darja Horvatic (Zürich: Park Books, 2014), 168-69

The exhibited work included three transparent acrylic fogponic capsules, containing water, ultrasonic fogging devices and perforated planters, and set against a printed visualisation of the work in place. The fog brought the work to life, animating it with the sight and sound of a continuous cycle of phase changes as water vaporised only to re-condense. Rather than simply escaping through the perforations and into the gallery space, as one might expect, the fog was contained, percolating energetically within the capsules.

Releasing the fog was desirable for thermal and visual amenity, as the intent of the Fog Garden was enhancing public space through not only an ever-changing growth and decay of plants, but also through the summertime cooling effect of fog on the immediate surroundings. Thus, the turbulent movement of the fog in the capsules drove subsequent explorations into ways of delivering, shaping and releasing fog in relation to the plants.

Exploring Fog

Figure 1. Fog Garden, image courtesy of little wonder, 18 Sep.2014



As we wondered about recirculating the fog, we also wondered about giving the fog form. In experiments with recirculating fog - involving an outlet for the fog and a suction inlet for recirculation - we came across particular challenges: if the outlet and inlet were close enough together for optimum recirculation, the plants did not benefit, while if the outlet and inlet were far enough apart for the plants to benefit, the fog would disperse into the air, rather than recirculate. Meanwhile, the fog seemed reduced to merely a technological fluid, lacking the percolating vitality that had made it so captivating in the exhibition prototypes. It seemed that as we gained greater precision in controlling the fog's movement, direction and volume, we diminished fog's own atmospheric allure, for the more we controlled it, the less it seemed like the captivating phenomena that fog is.

Heightening and understand fog's own behaviour, required reducing the design. Considering that fog is categorised by the interaction between material and environment which gives rise to it (such as radiation fog or evaporation fog), if we were to work *with* fog, it would mean working with the dialogue between fog, materials and the environment, in order to manifest their fluctuating interrelationships⁴. We began to experiment with putting the fog into contact with different materials. We tried

4. World Meteorological Organization, "International Cloud Atlas," World Meteorological Organization, <https://cloudatlas.wmo.int/home.html>

pushing the fog through geotextiles, whereupon they acted as filters, giving fog different textures and weights. The fog began to move slower, and become thicker. It began to linger and started to exhibit its own qualities, rather than immediately dissipate in to the air.

We began to experiment with paper. When we placed fog into contact with paper, fog alternately gripped or slid over the surfaces, and lingered. When we placed solid objects on the paper, the fog slowly reacted in dialogue with its environment. This suggested that rather than controlling fog, we should enable it to communicate with its environment. In oscillating between thing and atmosphere, fog became more thing-like at this point. The more we explored something as insubstantial as fog, the more it began to feel like a material - akin to ceramic or steel - that we could work *with*.

Designing With Fog



Figure 2. *10 Kinds of Fog*, image courtesy of little wonder, 7 May. 2017

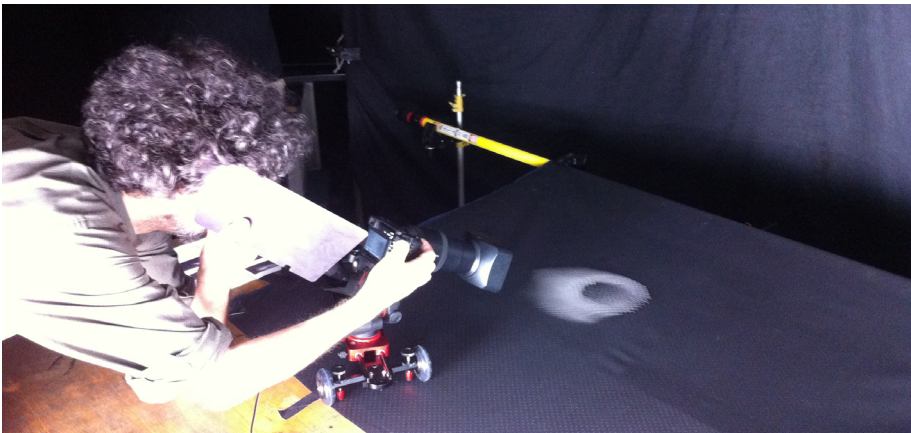

Figure 3. *10 Kinds of Fog*, image courtesy of little wonder, 7 May. 2017

We continued to explore how fog behaved in relation to different textiles in different densities, porosities and layers. We allowed the fog drop onto the materials, move along them, and grip them. As we did this, we began to wonder whether, more than interacting with surfaces, fog could actually be shaped by them. Could fog be formed?

We hybridised our two approaches, pushing fog through the various textiles we had been exploring. We let fog drop through them from above, then pushed the fog through them from below, letting it interact with the textiles as it sat atop them. As

we did these effects started to emerge, as if the textile became a stage and the fog began to dance with air. Allowing the fog to accumulate in a plenum before being released through the textiles further amplified it, and enabled us to sculpt it, as we altered the plenum geometries, from square boxes to linear troughs to cylinders to toroids. The results were varied, but equally transfixing fog formations; turbid jets, effervescent fountains, slithering vortexes, contemplative squares, and striated rings each emerged from nowhere only to disappear once again, each revealing fog's structure and texture as a quasi-thing. We combined the mechanics and electronics of ultrasonic foggers, fans, plenums and integrated lighting, with the geotextile filters and stretched fabric surfaces, into a set of ten black boxes: *10 Kinds of Fog*.

The fog in our design studio, however, was not only the product of the experimental prototype we had made, but was also very much a product of the thermal properties and movement of the air of the studio itself. Everyday in the studio, the prototype behaved slightly differently, and each time we moved the prototype from the design studio to the making workshop to the photography studio and ultimately to the gallery, we felt like we were gambling, as it was hard to predict what to expect. Each move altered the fog's buoyancy, litness and opacity. In a photo studio in New York's Chinatown, an open window which allowed the sound of the subway thundering over the Manhattan Bridge to permeate the space, an itinerant cat racing to and fro, a creaky and uneven wooden floor which moved with each step, the heat of the lighting and the placement of the photographic backdrop all manifested in unforeseen influences on the fog produced. The double-height ceiling and air conditioning system of the RMIT Gallery, as well as a neighbouring work, which was continuously dropping to the floor and rising back up to the ceiling, affected the work in unpredictable ways. The most extreme side effect of these came when the gallery's cooling system malfunctioned, creating refrigerator-like conditions within the space. The *10 Kinds of Fog* were reduced to one kind, as each of the plinths was covered in fog so thick it was liquid-like. In each of these places, the fog performed a different dance with the air, but retained its own beauty. *Finding fog* was thus attuning to changes in buoyancy, litness and opacity arising not only from materials, but their relationship to the environment.



Figure 4. *10 Kinds of Fog*, photographed by Mark Ashkanasy, image courtesy of little wonder, 14 Sep. 2018

Artists and designers have turned to fog alongside other quasi-things in the past. In the late 1950s through the early 1960s, Yves Klein engaged energy and phenomena to produce works in which he was no longer completely the author, but the phenomenon itself was an active participant, as in his proposing an “architecture of the air” composed not of walls and roofs, but of air, fire, and water - phenomena that were ephemeral,

and immaterial⁵. Treading similar ground to Klein, Hans Haacke's *Condensation Cube* of 1965, for example, comprised distilled water sealed within a transparent acrylic box, to create a system which reacted to the surrounding environment of the gallery⁶.

Fog's atmospheric quality has been a component of immersive installations from contemporary artists like Fujiko Nakaya, with works from the 1970 *Pepsi Pavilion* through the 2002 *Blur Pavilion*, and Ólafur Eliásson, from *Yellow Fog* (1998) to *Fog Assembly* (2016). In capturing miniaturised clouds indoors, Berndnaut Smilde's elaborately staged photographs are captivating in that they portray vapour as a thing, both alien and fragile, reminiscent of *Earthrise's* portrayal of Earth against the backdrop of space. *Cloudscape* (2010) by Tetsuo Kondo and Transsolar straddles these in its stratification of air: one approaches a hovering cloud from below, that then becomes an immersive atmosphere⁷.

10 Kinds of Fog, on the other hand, presents fog as a quasi-thing: a structured, material phenomena in itself, a carrier of information about the behaviour of the air, and a colourant of experience (Griffero, 2017). Whereas the aforementioned works are architectural in scale, *10 Kinds of Fog* was akin to bonsai, contained to an uncovered 40x40x10cm space atop each of the ten black boxes. Just as bonsai draws one's attention to otherwise unnoticeable qualities of a tree, *10 Kinds of Fog's* diminutive size lifted the viewer above the phenomena, and foregrounded formal and textural qualities that are not readily apparent. Yet, being uncovered, *10 Kinds of Fog* enabled the audience to interact with it, as it flickered, evanesced and returned in response to the waving of hands or blowing of breaths, as they, too, *found fog*.



Figure 5. *10 Kinds of Fog*,
photographed by Mark Ashkanasy,
image courtesy of little wonder,
14 Sep. 2018

5. Yves Klein, *Yves Klein 1928-1962: Selected Writings*, trans. Barbara Wright (Tate Gallery, 1974), 35-38

6. Walter Grasskamp et al., *Hans Haacke, Contemporary Artists* (London ; New York: Phaidon, 2004).

7. Gernot Böhme et al., *Architectural Atmospheres: On the Experience and Politics of Architecture* (Basel: Birkhäuser, 2014)

References

Boelen, Jan, and Vera Sacchetti. *Designing Everyday Life*. Translated by Rawley Grau and Darja Horvatic. Zürich: Park Books, 2014.

Böhme, Gernot, Eliasson Ólafur, Juhani Pallasmaa, and Christian Borch. *Architectural Atmospheres: On the Experience and Politics of Architecture*. Basel: Birkhäuser, 2014.

Grasskamp, Walter, Molly Nesbit, Jon Bird, and Hans Haacke. *Hans Haacke*. Contemporary Artists. London ; New York: Phaidon, 2004.

Griffero, Tonino. *Quasi-Things: The Paradigm of Atmospheres*. Albany, NY: State University of New York, 2017.

Klein, Yves. *Yves Klein 1928-1962: Selected Writings*. Translated by Barbara Wright. Tate Gallery, 1974.

World Meteorological Organization. "International Cloud Atlas." World Meteorological Organization, <https://cloudatlas.wmo.int/home.html>

Choreographing Aesthetic Atmospheres

Abstract. My design and research practice explore our relationship to air and how designing with atmospheric phenomena can constitute a new design practice: an Aesthetics of Air. Whilst Sumartojo & Pink (2018) contend that “atmospheres themselves cannot be designed,” I put forth that we can design or ‘choreograph’ the conditions from which atmospheres arise. I am interested in our experience of air in lived space and how atmospheric encounters can be shaped by choreographing the complex, transient and dynamic matrix of breezes, scents, moisture, radiant light, dappled shade, textures and sounds. In this paper I will expand on these ideas and my practice in designing ‘with’ phenomena through describing the process of developing the atmospheric installation ‘Outside_In’.

Malte WAGENFELD¹

Keywords. *Atmosphere, Aesthetics, Air, Phenomena, Design, Ambiance, Microclimates*

Choreographing Aesthetic Atmospheres

My design practice explores our relationship to air and how designing with atmospheric phenomena constitutes a new design practice, the Aesthetics of Air.

Gernot Böhme (1998, 114) argues that an “aesthetics of atmosphere shifts attention from the ‘what’ something represents, to the ‘how’ something is present. [Restoring the term aesthetics] to its original meaning, namely the theory of perception’.” Atmosphere, originally a meteorological term denoting the earth’s aerial envelope, “can also describe the emotional tone of a space, [...] the sphere of felt bodily presence” (Böhme, 2017, 69) or “the moods that are ‘in the air’” (158)

My practice is phenomenological, not so much in a psychological or philosophical sense, although drawing from these, but practice-based: where I consider phenomena to be perceivable spatiotemporal events; a form of energy or force, with a momentum to act on things and on us. Designing with air requires such phenomena to be understood, and perceptually and conceptually mastered.

Discovering Phenomena

My early investigations revealed atmospheres as a complex and intricate assemblage of phenomena consisting of transient air currents and breezes, subtle variations in temperature, humidity and air density, localised scents, dappled pockets of radiant warmth, incidental sounds and so on. These are highly “interrelated, interacting and networked energies and forces, which together generate a multitude of dynamic and ever-changing atmospheric phenomena” (Wagenfeld, 2015).

1. RMIT University, School of Design, Melbourne, malte.wagenfeld@rmit.edu.au

Invoking such rich experiential encounters in a design context, requires this “intricate assemblage” of phenomena to be studied; to understand what we are perceiving and, critically, to comprehend the dynamic systems that generate our perceptions.

Initially I studied atmospheric phenomena using video observations, scanning lasers, fog machines and piezoelectric misters. Most of these methods engaged strategies that enabled the visualisation of air, or rather - of “the energies and forces present in air” - and the stunning topographies of this otherwise invisible experience (Wagenfeld, 2015). For example, using scanning lasers and fog to visualize aerial phenomena a “hidden world was made known to us, [...] as highly complex [...] patterns of gently spinning vortices that had the delicacy of fine lace” (Wagenfeld, 2008).

This awareness of phenomena inculcates us into this unseen sensory world, but engagement with a deeper bodily encounter in which the designer experiences the interplay of these phenomena as a vivid aesthetic encounter is paramount. Here the principle instrument is our own body undertaking a sensory investigation. If we calibrate ourselves to such encounters, to feel and see air, a comprehensive understanding of and mastery over the medium is possible.

Attuning to Phenomena

Humans have an extraordinary sense of perception. We can perceive a change in surface temperature of as little as 0.02c (Jones, 2009). Such delicate responses are evident, for instance, as we walk under the canopy of a tree. We can register a minute change in temperature or the faintest breeze.

A conscious immersion in and bodily investigations of atmospheres over time, enables a shift from what Rudolf Arnheim defines as a state of “passive reception” towards “active perceiving” (Arnheim, 1969, 14), thereby becoming more attuned to the presence of very subtle manifestations of phenomena - to perceive Thibaud’s micro-phenomena (2015, 39).

In a design context, this active perceiving and attuning to atmospheric phenomena, a process David Seamon refers as Goethe’s way of science: “direct experiential contact coupled with prolonged, attentive efforts to look and see [to build a] synthetic understanding” (Seamon, 2005), has been critical to my grasping of what constitutes an atmosphere and the nuanced ways it effects us; and how to ‘think’ in phenomena.

Thinking in Phenomena

Even if what is being visualised is not visible to the eye, such as the perception of sun warming our shoulders, we construct a visual image of this. As Rudolf Arnheim explains “truly productive thinking in whatever area of cognition takes place in the realm of images” (Arnheim, 1969, v).

Thinking in atmospheric phenomena also challenges us to think spatially and temporally; so that we can conceptualise how phenomena move through space and time, cognate the impressions this might have on our senses and then translate these into specific feelings and moods. In this case, the images we think in are ‘perceptual’ images, and through these we can imagine new phenomenological situations; and finally, through such perceptive engagement we can begin to design with phenomena.

Designing With Phenomena and Staging Atmospheres

Sumartojo & Pink (2019) assert that atmospheres cannot be designed, primary because the perception of an atmosphere is “taken up in individual experience.” But we can, as I demonstrate, design the staging of atmospheres. Here we need to consider the nuanced distinction between atmosphere and ambiance.

In my practice I consider *atmosphere*, as the perceptual medium, the carrier of phenomena, and *ambiance* as the individual’s experience of atmosphere, but, as Thibaud (2015) argues, aspects of ambiances can also be a shared experience. This distinction, along with an acute awareness of both the uniquely individual experience and what resonates as collective experience, is fundamental to staging atmospheres.

Phenomena exhibit highly idiosyncratic behaviours. While they can be modulated within the spatial context in which they present, they cannot be precisely controlled, nor would this be desirable. Designing with air, can be thought of as a form of choreography, where phenomena are ‘choreographed’ like dancers’ moving through air: but in a manner that doesn’t constrain their agency: dynamic, transient and evolving, inciting unexpected atmospheric encounters.

Locating & Siting the Atmosphere

My choreographic approach is exemplified in the design process undertaken to create *Outside_In*. This atmospheric installation was designed with Thomas Auer (Transsolar) for the exhibition, *Dynamics of Air* (2018). The intention was to investigate the type of atmospheric experiences present in an outdoor setting, such as a park, and see if this could be staged within an interior space.

RMIT Gallery 3 was chosen for its material qualities and proportions, a largish, windowless box with featureless walls, a high ceiling and polished concrete floor. The design process began with spending time in the space - observing, feeling and discovering the affordances that presented - gaining insights as to what material and phenomenological aspects were desirable and how problems could be mitigated. The gallery’s silent ambiance and resonant cold concrete surfaces created a meditative quality and the high ceiling afforded a generous, atmospheric volume to work with. Problematic were a series of air-conditioning outlets along the bottom of one wall. These could not be isolated, so ways to employ the cold dry air to advantage were explored.

Conceptualising the Atmosphere

The central design concept behind *Outside_In* was to explore how microclimates transpire and interact producing an internal weather system. Early design iterations explored four microclimatic quadrants - cool/dry; cool/moist; warm/shady/humid; and warm/sunny/dry - loosely contained within an open X-shaped structure that allowed these climatic zones to blend at the edges.

For each design iteration a phenomenological schemata was created to conceptualise the atmospheric possibilities and resultant experiences, through drawings and diagrams with detailed annotations describing the intended perceptual qualities and ideas on how these could be generated. This required ‘thinking in phenomena’ across a range of scales; for instance, translating the temporal and spatial presence of a gentle breeze right down to the smallest aerial vortices - into perceptual images, as a way to imagine their latent qualities.

As the design ideas formulated, scaled human figures entered the drawings to act as perceptual avatars, wandering through the space, figuratively exploring the microclimates, allowing me to imagine and internalise the perceptual effect. How the heat feels on my forehead and the humid air on my skin and in my lungs. What does it smell like? What is the colour and light intensity? What is the overall ambiance? Later scale models were built to explore space volumetrically, again figures were used as spatial and perceptual reference points.

The final design narrative was pared down to two distinctly different interacting environments - the Australian beach and the German forest. The central element of this proposition was a large geometric structure consisting of two parabolic concave surfaces sitting back to back at a 34-degree incline, one side cave-like simulating a forest gorge with cool, dark, moist air, the other dune-like, dry and bright, like the feeling of standing on the beach under the radiant warmth of the sun.

The principle phenomena being choreographed included clouds of mist, created with high-pressure water pumped through jets with a micro-aperture, radiant heat from infra-red lamps, and coloured light reflected off the two end walls. A key aspect of juxtaposing two such distinct microclimatic experiences was to generate a phenomenological duet and explore how this would be perceived by people moving through the space, from the cool cave to hot beach. Would there be subtle sensory shifts in atmosphere and perceptual environments between these extremes; a spectrum of dynamic and transient microclimatic bodily encounters?

Prototypes were created to explore *how* to choreograph the phenomena, by adjusting the conditions that would generate the intended atmosphere. The dimensions and angle of incline of the parabolic discs were determined by how it would be physically and visually perceived. The misting jets were positioned to harness the cold air from the air-conditioning ducts. The intensity of light, its colour temperature, the material qualities and their colour palette were methodically tuned.

Installing the Atmosphere

Once the bones of the installation were in place, the equipment and the angle of the jets was tested, adjusted and retested. Water pressure and the volume of mist were tweaked. The height and position of heat lamps were determined to create warmth on the visitor's face. The parabolic structure was precisely placed to create an intimate cave-like environment on one side and an open, warm and radiant expanse on the other. On either end, the walls reflected a specially calibrated light, simulating the iridescent green of a forest canopy and the deep cerulean blue of the ocean sky. The tone and hue of the colours as well as the LED light finely calibrated. How atmospheric phenomena interacted with the structure was observed and perceptually studied, especially at the edges where the two microclimates mixed.

Colleagues were asked to engage with the installation. We focus on the angle of the jets, initially pointing in different directions to produce a chaotic pattern. We observed that the dynamics of the air within the gallery was already randomising the mist almost as soon as it leaves each jet, so we adjust them to all point straight allowing this phenomenon to be observed and keenly felt.



Image 1. Outside_In, Malte Wagenfeld, 2018. Photo: Mark Ashkanasy.

Reflecting on the Aesthetic Atmosphere

Over the duration of the exhibition, I spent time immersed in *Outside_In*, no longer as a choreographer but as participant. I was surprised how distinct the perceptual experience of each climate was, each had a unique ambiance, or “*Gefühlston* (feeling-tone)” (Böhme 2017, 14). Intriguing were the microclimatic variations blending at the edges of these atmospheres, and how the interplay of phenomena subtly changed from day to day.

I often heard people discussing their perceptual encounters with the atmospheres. Unexpected were the many comments about ‘the pleasant scents’. These perceived scents may have been produced by the mist circulating on the ‘forest’ side and interacting with the materials of the installation, but most likely were in part psychosomatic; eliciting memories of forest air. Our senses work together to create a psychosomatic experience, if information from one sense is lacking, other senses compensate to build a complete phenomenological image.

Visitors also regularly remarked on the sonic experience. This was not a staged element but was generated from aspects of the installation itself. The gentle hiss of misters dissolved into a pink noise, resembling a distant waterfall and reverberated inside the parabolic dish, adding to the perception of standing deep inside a forest, with muted sounds of the gallery beyond; walking around the geometric structure into the sun, the sounds, now reflected off the dish, felt much brighter and open, like being at the beach. Both highlight the complexity of phenomenological interplay, and the importance of allowing phenomena agency to perform: for aesthetic atmospheres to emerge and ambiances to arise.

The parabolic structure was critical in shaping these microclimates, the emergent phenomena, unscripted soundscape and the overall ambiance; revealing how immaterial atmospheric phenomena interact with and are fashioned by the physical world. In a forest gorge, the moist cool air is shaped as it is caught between lush tree canopies and stone face radiating cold; sunlight is dappled, filtered and refracted as are sounds; and moist air alters our perception of sound. Likewise, the thermal mass of a beach dune reflects the sun’s light and radiates its warmth. Working with immaterial atmospheric phenomena requires an understanding of how they exist in the physical world - as material manifestations that both generate phenomena and also act on and alter our perception of them.

Although individual atmospheric encounters cannot be ‘designed’ nor determined, the phenomenological conditions from which they arise can be thoughtfully conceived through a design process to involves thinking in phenomenological images and visualising their perceptual effect, to choreograph their interaction with each other and the physical materiality.

References

- Arnheim, Rudolf. “*Visual Thinking*.” Berkley: University of California Press, 1969.
- Böhme, Gernot. “*Atmosphere as an Aesthetic Concept*.” *Daidalos* 68, Constructing Atmospheres (June 1998): 112-115.
- Böhme, Gernot. “*Atmospheric Architectures, The Aesthetics of Felt Space*. London: Bloomsbury, 2017
- Jones, Lynette. 2009. “Thermal Touch.” Scholarpedia. Accessed 10 June 2020. http://www.scholarpedia.org/article/Thermal_touch
- Seamon, David. “*Goethe’s Way of Science as a Phenomenology of Nature*.” *Janus Head* Vol. 8 No. 1 (2005): 86 - 101.
- Sumartojo, Shanti. Edensor, Tim & Pink, Sarah. “*Atmospheres in Urban Light*.” *Ambiances* Vol. 5. (2019)
- Thibaud, Jean-Paul. “*The backstage of urban ambiances: When atmospheres pervade*.” *Emotion, Space and Society* 15. (2015): 39-46.
- Wagenfeld, Malte. “*The Aesthetics of Air: Experiments in Visualising the Invisible*” *Architectural Design: Interior Atmospheres* Vol. 78 No. 3 (2008): 20 - 25
- Wagenfeld, Malte. “*The Phenomenology of Visualizing Atmosphere*.” *Environmental & Architectural Phenomenology* Vol. 26 No. 2 (Spring 2015): 8 - 16

02

ARTIFICIAL LIGHTING AND DARKNESS IN
THE ARCHITECTURAL AND URBAN PRACTICES

03

ATMOSPHERES + DESIGN

04

BODY, CULTURE, IDENTITY

05

DIGITAL ARCHITECTURE. ATMOSPHERES IN DESIGN
AND NEW RESPONSIVE & SENSITIVE CONFIGURATIONS

06

FROM A SENSITIVE ECOLOGY OF
AMBIANCES/ATMOSPHERES TO A POLITICAL ECOLOGY

Body, Culture, Identity

Session 4 – Introduction

Cristina PALMESE¹,
José Luis CARLES²

The objective of this thematic session is to explore how the relationship between artistic and scientific tools can overcome divisions and conceptual schemes that do not correspond to our contemporary condition, exploring the complexity of its open, broad and varied development.

The city, apart from being a potential receptacle of images and sensations dealing with all the senses, experiments deep social, political or technological changes (a reorganization of structures, fluctuations and populational migrations, an architecture of cultural spaces, etc.) in such a quick way that there is hardly time for a critical reflection or for creating a state of consciousness about it. Moreover, in a culture submitted to the power of images, we hardly pay attention to the perceptual complexity of our body. Our perceptions are submitted to geometry, and to discreet and simplified observation, which enables a better control by means of prototypical designs and remote control, handling our interaction with the environment, of our desires, aligned bodies.

There is a common consensus about the need of interdisciplinary or rather, transdisciplinary approach to research, but often this agreement does not correspond to a real application of this idea. The criticism of the Western schematic, quantitative and reductionist tradition is maintained within the criteria of tradition itself, usually limited to a mere disciplinary and methodological juxtaposition. This does not address the complexity and it does not facilitate the construction of a common language nor the achievement of common objectives.

The challenge of this session is to stress the importance of a collaborative and participative way to understand through our senses.

The direct experimentation of space helps us understand it, as well as “to perform it,” it helps us understand the aesthetic and emotional relationships we have with it. A new approach to the knowledge could be the basis of the conception, formulation and construction of a new landscape capable of highlight the role and diversity of embodied expression. We invited papers (theoretical, actions, field studies...) that address the above points within themes including:

- How to explore connections between thinking and acting in everyday city experiences,

1. *Architect Paisaje Sensorial OfficeLab.*

2. *Senior Lecturer Universidad Autónoma de Madrid.*

- How to develop processes of appropriating public spaces (sensibilization, activism, citizenship...) by means of a sensorial consciousness and the experience of the inhabitants (cultural landscapes, immaterial heritage)?
- How do the collective, community exploration of the vital flow of the urban space, altering the classical relationship between expert, artist, landscape and inhabitants?
- Can we consider our body, not as something defined, but as a flow of relations with the environment? How can we explore this theoretically and methodologically?
- Is it possible to create experiences and experimentations that provide knowledge through the embodiment of urban space?
- How to create new dynamic and participatory performative environment as a dynamic dialogic process, in which a citizen, constructed space and technology are regarded as co-creators?

The authors take ownership the proposed topics along various axes. We briefly summarize the similarities and differences in terms of methods, results, and impact. These are the topics collected in the contributions:

- The æsthetic, and social aspects of soundscape to create alternative and subjective narratives (S. Balbontin and M. Klenner).
- The experience of re-acting contemporary urban routines and rituals through public improvisations and interventions. (R. Atienza, M. Sand and R. McGinley)
- The implementation of a virtual reality specific environment (G. Loukakis, S. Papadopoulos and V. Bourdakis)
- The body-space relationship towards expanded architectural and cognitive perspectives (M. Grigoriadou and E. Mantzari)
- The analysis of interiors as cultural atmospheres and an external history (J. Cunha)

These are partial aspects, complementary approaches that demonstrate the significance of the body in interdisciplinary creation. The situations, the experiences studied and the narratives of the works are multiple and diverse and framed in a singular and precise space-time.

The body-space-culture relationship is captured both in the concrete experiences observed and in the different atmospheres evoked, so the results obtained provide answers, while posing new questions. The “in-situ” experiences developed in different environments raise questions about the research processes themselves. The involvement modes of the actors, experimenters, citizens, experts are of particular interest, whose roles are sometimes exchanged and altered.

The transverse procedures and methods implanted are especially important and delicate. In all of them we can highlight the importance given to the body movement, to the body experiences and the perception in several scientific-creative processes, emphasizing the importance of feelings and bodily actions in a physical and social environment.

The immersive environment of Olympus Mountain is represented by G. Loukakis, S. Papadopoulos and V. Bourdakis with three scale versions enhanced with additional layers of information, narration, interaction and alloæsthetic experiences. These “sediments” of information and interaction provide an additional, unique way to experience the spatial characteristics and the ambiance allowing a new dialogue between the user and the represented environment.

Applying an empirical, case study approach inside virtual reality (VR), M. Grigoriadou and E. Mantzari make up observations about how virtual embodiment can be experienced as an instance of otherness embodiment that generates a sensation of alloæsthesia. The architectural design can be approached with a neuroscientific perspective on perception and æsthetics as the role of embodied cognition through the mirror neuron system is connected with æsthetic responses through sensory perceptions. This post-human condition can be bi-directionally fed into re-establishing the body-space relationship towards expanded architectural and cognitive perspectives.

Three concrete examples an experimental artistic research environment will be presented here by R. Atienza, M. Sand and R. McGinley in which actors and audience were invited to investigate together the rhythmic order of urban routines and rituals, through the re-enactment of daily urban atmospheres. The ateliers presented aims at responding to today's deep physical, sensorial and social transformation of the city by re-acting contemporary urban routines and rituals through public improvisations and interventions.

As an attempt to converge the thinking of social sciences and the theoretical and practices of sound spatialization architectures, S. Balbontin and M. Klenner presented the series of artworks "Resonant Spaces." *Based on different theoretical reflections on the evolution of artistic disciplines around sound and space, they face "Resonant Spaces" as a resignification, from subjectivity, performance and body, to the symbolic, affective and representational apparatus of architecture and, finally, to our society. The case studies for experimentation are abandoned infrastructures in the margins of memory and the urban, inhabitable places with unique and exacerbated acoustics.*

The argument of J. Cunha is that interiors reflect a cultural atmosphere that is neither simply based on tradition nor in state-of-the-art innovation. In fact, they are crossed by history such as are cities, homeland landscapes and countryside settings, pointing to a wide traditional element that can incorporate what the hegemonic cultures have considered for so long as inferior objects from colonized territories.

Olympus VR

Sediments of Information and Interaction

Giorgos LOUKAKIS¹,
Spiros PAPADOPOULOS²,
Vassilis BOURDAKIS³

Abstract. This paper discusses the design approach that was followed during the implementation of the mountain Olympus in a virtual reality environment. Due to certain limitations of data acquisition, time and asset management, the creation process demanded a hybrid approach in order to implement the environment of the virtual mountain as well as the supplementary levels of information and interaction. The immersive environment is represented with three scale versions which are enriched with additional layers of information, narration and interaction. These noetic 'sediments' provide an additional way for unique alloæsthetic experiences and enhance the ambiance of the mythical mountain, allowing a new dialogue between the user and the represented environment.

Keywords. *Virtual Reality, Game Engines, Representation, Digital Landscape*

Introduction

Nowadays, in the second decade of the 21st century, virtual reality (VR) technologies are advancing fast and via big leaps. Recent improvements in head mount displays, graphics processors, motion sensors and body tracking algorithms are forming a technological landscape that offers new ways to perceive and interact with the represented worlds. (Rubio-Tamayo, Gertrudix Barrio and García García, 2017). Furthermore, the advancement of visualization software as well as the increasing popularity of game engines usage in the design and implementation of virtual spaces, have led to a renewed interest in the research of representational, immersive, interactive environments of any kind.

These digital environments constitute a category of multi-sensory media technologies that allow an intuitive interaction with spatial data, as they directly involve presence and human senses (McLellan, 1996). Moreover, they allow the mental registration of dynamic, experiential and mnemonic imprints, while redefying the concepts of identity, space and ambiance. The immersive exploration of such an environment can enhance the æsthetic and emotional experience of the represented space and provide unique, personalized narrations.

The Virtual Olympus

According to this theoretical framework, the authors are conducting a research entitled *Use of game engines in the design and implementation of Mount Olympus in a*

1. Post-Doctoral Researcher, Department of Architecture - LECAD, University of Thessaly, Greece, gloukak@uth.gr

2. Professor, Department of Architecture, University of Thessaly, Greece, spap@uth.gr

3. Professor, Department of Architecture, University of Thessaly, Greece, vas@uth.gr

virtual reality environment, which is funded through a scholarship by the Stavros Niarchos Foundation. The main scope of this project is the exploration of the representational capabilities of the VR medium as well as the multi-sensory approach and understanding of virtual space that can directly reveal additional aspects of the design processes such as the comprehension of the represented information, the modes of interaction, the requirements of immersive ambiance conditions and the compositional elements of dominant narrations. These extra qualities and perspectives of virtual space, and especially the ability to immerse in it, are the main advantages of this methodological approach. Furthermore, virtual Olympus can broaden the significance and perception of an important Greek landscape and introduce it to a digital interactive study environment for a variety of applications such as the environmental, architectural and spatial design, tourism development, cultural heritage preservation, education, advertising, development of various entertainment products such as video games or in other areas of interest, where virtual reality and digital representation can be applied.

The Implementation of the Virtual Odel

The basic condition that is met during the use of a virtual environment is the need for modeling and visualization, the simulation of various scenarios and conditions, the integration of any cultural, educational and historical elements or any other metaphors that are related with the area. In order to explore these requirements in a VR environment, we decided to utilize a game engine and more specifically the Unreal Engine 4.

The implementation methodology of the represented mountain included three distinct design stages (terrain data, surface textures and 3D assets) which concurrently constitute the primary layer of information and the creation process of the basic physical environment of Olympus. For the needs of our research, elevation data from the satellite system ASTER (Global DEM V2) were used. These height data are the most recent, free satellite data set with resolution of 30 meters per pixel.

The Scales and the Layers of the Representation

An important condition that is met during the research of the Olympus digital environment, is the utilization of information and interaction layers which are successively added to the basic model and thus expanding its primary properties and capabilities. Usually, the degree of spatial and narrative immersion that is caused by virtual environments and the narrations that unfold in them, is high enough to convince that the digital space of Olympus is a new, “other” parallel space of existence and experience. In addition, given the fact that experience is an important factor of knowledge (Bot, Gossiaux, Rauch and Tabiou, 2005), we can consider that the digital representation of Olympus can be a new methodological approach during the dissemination of the knowledge, the cultural content and the affective experience of the mountain.

Consequently, the cultural heritage of any digital representation can be considered not only as a set of objects but also as a set of processes and practices that have the characteristics of a contemporary or previous culture and are highlighted through a variety of interpretive systems. Therefore, one of the biggest advantages in constructing virtual environments is the creation of dynamic representations that are transformed from simple representations of objects into simulations of cultural expressions and other related processes (Affleck and Kvan, 2005; Champion, 2002).

With all that in mind, the representational space of Olympus Mountain was divided

into three separate scales of representation and three layers of information, narration and interaction which are present - more or less - in every scale and concurrently constitute the dynamic elements of the model that can be altered or enhanced if needed. The macro, the meso and the micro scale of the mountain constitute different modes of representation in terms of size, view, movement, immersion and experience. The information, interaction and narrative layer of each scale can be considered as notional sediments that contain various elements of meaning and representation. These sediments “settle” consecutively on top of the primary landscape of the mountain while elements of each one of them may also be occasionally present in other layers. This way, a digital “stratigraphy” of experience and meaning is formed by the sum of all layers, which contributes significantly to the creation of a holistic, alloaesthetic, experiential layer. The description of each scale and the layers that have been introduced in them is as follows.

Macro Scale. The Mountain. Flying

The macroscopic scale of the representation is related with the catholic, far view of the mountain. Olympus is visualized as a whole, solid landform, while the total acreage of the area of interest is approximately 900km². The surface texture that is used is composed of many satellite aerial photo tiles that have been compiled together in a single texture. In this scale, the user camera moves freely above the mountain by using hand controllers and performs a “fly by” style movement. This mode allows the user to experience the geomorphology of the area, the location and size of the mountain, its juxtaposition with the sea and the rest of the nearby Greek landscape. In this representational version, the information layer serves mainly as a map due to the fact that contains the locations of geological, archaeological, historical and cultural points of interests. In this scale the user can also view the network of the main paths of the mountain and browse information such as the path’s length and height difference between start and end point, approximate travel time etc.

The landscape experience of the virtual mountain does not only originate from the simple depiction of the natural environment, but can also be seen as a form of spatial narration or narrative construction. As Griffero (2017) states “[...] forms, whether they are in a static or in motion, do not express merely apparent causal relations and pragmatic affordances but also tertiary qualities or sentimental (and therefore atmospheric) ones, which permeate the space in which they are perceived.” According to that, the user of a representation contributes significantly to the narrations that are produced by space and forms, while being the cause and occasion for new, often unprecedented actions and experiences. Hence, virtual Olympus becomes the spatial frame that hosts the “backstage” parts of a holistic experience, such as the individual interactions, spatial metaphors, noetic suggestions and environmental stimuli. These additional qualities and perspectives of virtual space and the ability of immersion and interaction are the novel elements that characterize the ambiance and the affective experience of the virtual Olympus Mountain.

Meso Scale. The Path. Walking

In the mesoscopic scale of the VR environment, the paths of the mountain constitute the basic level of representation and immersion. Gortsia, one of the most popular paths that lead to Petrostrougga refuge, was chosen for an experimental implementation that would attempt to immerse the user in the physical environment of the forest which covers a vast area of the mountain and offer the chance to walk on a real path. The user in this scale can walk by using a first person view and a hybrid, phygital (physical+digital) type of movement. This movement is accomplished either by

walking in physical space (HTC Vive system allows for 25sq meters of free movement in a 5x5m area) or by performing the popular teleport “leap” that many VR environments use.

In this scale, the virtual paths of Olympus allow and enhance a new, expanded conception of cultural and ambient information about the mountain through the creation of experiential narrations and the procedure of walking (Loukakis and Papadopoulos, 2019), while at the same time consist a valuable tool for learning, researching and disseminating cultural heritage. The narration properties of this scale will also be enhanced with gamification scenarios inspired by the mythology and history of the mountain but also with additional texts of personal stories of visitors, hikers and climbers that were collected from various blogs, forums and online communities. The interaction layer of this scale involves the development of a typical treasure hunt game that takes places on Gortsia path. Also, at the end of the first part of the path, there is a glade where the user can play with virtual toys such as balls, dices, miniature figures, building blocks, wooden sticks and a piñata.

The use of new technologies and especially virtual reality in the process of highlighting and preserving the cultural references and all emergent ambiances can redefine the paths of Olympus as interpretive elements of a new, potential place and also increase the usefulness of interactive representation through virtual presence.

Micro Scale. The Rock. Climbing

The microscopic scale of the representation focuses on the interaction aspect of climbing and thus the corresponding layer is dominant. The basic calcareous bedrock of Olympus top and the force of gravity are the user’s opponents. More specifically the representation involves a climbing experience to the top of Olympus (Pantheon peak, 2917m) via a well-known steep route called Louki Corridor. The user starts at the base of the route and by using the first person perspective follows the signs that mark the way to the top. The simulation of climbing is achieved by using hand controllers. When the user has reached the top and touched the concrete pillar that marks the highest point of the mountain, the climate and ambient conditions are changed radically and the top of Olympus transforms to an “other” place. The landscape textures are removed, the heightmap is turned into a grid relief and then it is duplicated, reversed by rotation (180° around y axis) and placed on top of the original relief and parallel to it. In this way, the two reliefs are forming an hourglass shaped landscape which marks the beginning of a new experience of the mountain.

Hall (1997), studying the relationship between representations and culture, states that we interpret and signify things in the way we represent them, the stories we tell about them, the images of them we produce, the emotions we associate with them, the way we classify and conceptualize them, the values we place on them. He characteristically states that “Things ‘in themselves’ rarely if ever have any one, single, fixed and unchanging meaning. Even something obvious as a stone can be a stone, a boundary marker or a piece of sculpture, depending on what it means.”

According to this statement, the alloaesthetic layer that forms by the radical spatial and ambient changes transcends the mountain to an abstract, surreal space of action and experience. The events that occur in this version are similar to a hallucinating experience filled with changing colors and abstract sounds. The mountain that the user climbed is no longer Olympus. It can be any place or any mountain that is defined by his personal memories and experiences and allow a new idiosyncratic noetic dialogue between the user and the digital environment. A dialogue that is influenced by

the abilities and limitations of a virtual body but also by the digitally enhanced ambiance of Olympus.

Conclusion

The virtual representations of cultural information and consequently the digital environment of Olympus Mountain are able to incorporate various elements during the documentation, synthesis and implementation of these environments such as additional information, enhanced visual and noetic translations and metaphors, idiosyncratic narrations and interactive additions of any kind. In this way they produce a new, non-consolidated and flexible digital object, which may remain open to analysis, further fragmentation and repositioning, reproduction through its use and finally its interpretation by the users. In addition, they are able to constitute an alloæsthetic reality of perception and understanding which allow for the common sharing and transmission of knowledge and meaning which incorporates and combines broader theoretical frames and practices with the contemporary virtual reality technology.

The representation of Olympus Mountain in a VR environment consist a digital implementation of an important natural monument of global heritage. Concurrently, enhances and transforms the perception of space to an alloæsthetic place by contributing to an innovating experience in a variety of ways (accurate or abstract representation of the synthetic elements, expansion and enhancement of human senses and abilities in VR, integration of various narratives, addition of mythological, geological, historical and cultural elements); but mainly due to the ability for active participation through interaction, in the creation and development of a new multiple narrative about the mountain. Each new interpretation of virtual Olympus is a personal mnemonic imprint, perception and experience of the represented elements, while maintains the primary metaphoric dimension of the representation. Virtual Olympus remains the Olympus of the 12 gods, of Pantheon peak, the climbers, the history and culture, but at the same time it transforms into a mountain of multiple metaphors and translations, interactions and idiosyncratic interpretations of each user.

References

- Affleck, Janice & Kvan, Thomas. "Reinterpreting Virtual Heritage." In *Digital Opportunities. 10th International Conference on Computer-Aided Architectural Design Research in Asia Proceedings*, 169-178. New Delhi, India: Architexturez Imprints, 2005.
- Bot, Ludovic, Gossiaux, Pol-Bernard, Rauch, Carl-Philippe, & Tabiou, Safouana. "Learning by doing: a teaching method for active learning in scientific graduate education." *European journal of engineering education* 30(1): 105-119. 2005.
- Champion, Eric. "Cultural Engagement In Virtual Heritage Environments With Inbuilt Interactive Evaluation Mechanisms." In *Fifth Annual International Workshop PRES-ENCE Proceedings*, 117-128. 2002.
- Griffero, Tonino. *Quasi-things: The paradigm of atmospheres*. p. XIII. New York, USA: Suny Press, 2017.
- Hall, Stuart. *Representation: Cultural representations and signifying practices*. p 3. London, UK: Sage Publications, 1997.
- Loukakis, Giorgos, Papadopoulos, Spiros. "Walking in the abode of the gods. Virtual wandering on the paths of Olympus." In *3rd Pan-Hellenic Conference on Digital Cultural Heritage Proceedings*, Athens, Greece 2019.
- McLellan, Hilary. "Virtual realities." In *Handbook of research for educational commu-*

nications and technology. ed. Jonassen, D.H., p 457-487. New Jersey, USA: Lawrence Erlbaum, 1996.

Rubio-Tamayo, Jose Luis, Gertrudix Barrio, Manuel & García García, Francisco. “Immersive environments and virtual reality: Systematic review and advances in communication, interaction and simulation.” *Multimodal Technologies and Interaction*, 1(4): 2017. <https://doi.org/10.3390/mti1040021>

Physical Body Awareness and Virtual Embodiment

A Hybrid Experience of Otherness

Magdalini GRIGORIADOU¹,
Eleni MANTZARI²

Abstract. *Body awareness and embodiment are core terms and research topics being used to comment on the new interdisciplinary aspects of virtual immersive experiences. In this article, we present the methodology adopted in the Disembody research project with the aim to explore body-space relationship through the lenses of interdisciplinary considerations drawn from architecture and cognitive science. Employing an empirical, case study approach inside virtual reality (VR), we came up with observations about how virtual embodiment can be experienced as an instance of otherness embodiment that generates a sensation of alloæsthesia. This post-human condition can be bi-directionally fed into re-establishing the body-space relationship towards expanded architectural and cognitive perspectives.*

Keywords. *Body awareness, Virtual Embodiment, Space Perception, Expendable Bodies*

Introduction

This article provides an overview of the methodology and the orchestration of the empirical research conducted under the project *Disembody: Augmented corporeal experiences in the hyper-tectonic environment of a digital platform*³. *Disembody* explores diachronically dominant architectural research questions concerning aspects of the body-space relationship through the lenses of the latest interdisciplinary considerations of cognitive sciences and architecture. Architecture and contemporary neuroscience research present similarities in the way they deem the human mind and body, as they are both founded upon human corporeal experiences and the innate nature of humans' biologically grounded perception, either conscious or unconscious. Indicatively, the awareness of the complexity of cognitive and emotional processes involved in the daily experience of designed environments has rapidly grown with implications for a *sensory intensification* in architectural design (Van Kreij, 2008).

The project's objective is two-fold: (a) to analyse corporeal necessities-conditions, considering them as psychosocial and psychosomatic patterns, either material, anatomical or biochemical, making use of both qualitative and quantitative metrics (e.g., pre- and post-questionnaires and motion capture of users' body experiences in virtual

1. Postdoctoral Researcher, Laboratory of Environmental Communication and Audiovisual Documentation (LECAD), Department of Architecture, University of Thessaly, Greece, mgrigoriadou@uth.gr

2. Postdoctoral Researcher, Laboratory of Environmental Communication and Audiovisual Documentation (LECAD), Department of Architecture, University of Thessaly, Greece, mantzari67@gmail.com

3. The project is funded by the Hellenic Foundation for Research & Innovation (July 2018/P73) and run by the Laboratory of Environmental Communication and Audiovisual Documentation (LECAD), Department of Architecture, University of Thessaly.

reality (VR) environments), (b) to implement the findings of the empirical research towards the design of an experimental VR platform.

The Background: Physical Body Awareness and Virtual Embodiment

The notions of ‘embodiment’, ‘body awareness’, ‘body-space’ and ‘proprioception’ explored and mapped by neuroscience (De Vignemont et al., 2005) have provided a scientific breakthrough that has inspired research in the fields of architecture, planning and urban studies, and architectural thinking (Papale et al., 2016). The architectural design can be approached with a neuroscientific perspective on perception and aesthetics (Albright, 2015), as the role of embodied cognition through the mirror neuron system is connected with aesthetic responses through sensory perceptions. Thus, embodiment is considered the main body’s ability to spread and appropriate the environment, as an internal habitation mode for perceiving the complexities of the world. In space perception procedures it is not only the vision that adapts a semiotic operation of recognition, but the whole body which participates in the process; it is a kinetic expression of the spatial sensation, a multi-sensorial participation, a combination of a body-impulse and a movement technique. Consequently, space does not constitute an *a priori* experience, a separate objectual phenomenon; rather it is a component of the embodied experience that arises in the over neuro-sensitive procedure, which means that other multisensorial stimuli intervene in this process as well.

In contemporary context, new emerged atmospheres offer an approximation to this expansion of the spatial experience, as the sense of immersion is increased when the body is mirrored or duplicated by avatars (Fels, 2000); thus the VR environment presents even more multiplied characteristics and experiences than the physical one. Virtual embodiment, then, seems to invite the physical body to embody ‘another’ identity and sensoriality. The embodied cognition evolves from an initial grounded perception to a hybrid unstable experience of otherness as the avatar’s ‘mereology’ forces a double sense of “being really in place.” These embodied conditions present further interpretations for the notions of the ‘egocentric’, ‘allocentric’ (Ekstrom et al., 2014) and ‘peripersonal’ space articulations in interaction realities with the ‘otherness’ as a newly emerged entity (Roncone et al., 2016).

Interaction engagement in VR is closely related to full-body ‘extended’ experience and it is perceived as threefold: (a) as the feeling of presence in the digital environment - fantasy; (b) as affective aspects of human-human interaction - communication; and (c) as regulatory properties of emotion - affect (Bianchi-Berthouze et al., 2007). Thus, the virtual ambiances activate the ‘incorporative memory’, a function of embodied learning processes (Panhofer, 2017), since the body is connected with the highly incorporative capacity of new postures, gestures and movements leading to an internal constitution of hybrid identities, in constant movement and diversity. According to our perspective, these experiences are the new contexts that comprise the current ‘post-human’ condition; the ‘de-/multi-subjectivity can be bi-directionally’ fed through the embodied interactions in virtual reality worlds into re-establishing the traditional relation of body and space towards a new expanded architectural context with embodied cognitive perspectives.

The Hybrid Otherness in Motion: the Methodological Path

The research under *Disembody* aims to shed light on the exploration of the ‘expansion’ of human corporeity in architectural practice. To accomplish this the project is structured into three main stages:

1. Compiling an extended list of bibliographic references, an archive populated with theoretical and experimental accounts of human body-space interaction selected from the relevant inter-disciplinary literature;
2. Conducting an empirical research with 25 participants, students of architecture at the University of Thessaly. A mixed type of instruments have been used, such as a pre- and a post-questionnaire and a motion capture recording session during which the participants have been engaged with four different video games in VR environments.

By analysing the pre-questionnaires, we came up with different profiles based on notions discussed in the literature of philosophical phenomenology (Colombetti, 2011). Participants' profiles were marked as 'high-, mid- and low-level of experience' according to their previous experience with VR. Having been evaluated for their physical activity and the level of their bodily self-awareness, two main profiles were further recognised: (a) those showing 'reflective self-awareness', corresponding to physical activity conditions where their body comes to the foreground of awareness; (b) those with 'non-reflective self-awareness', where in the same physical conditions their body remains at the background of consciousness. In Legrand's terms (2007), 'reflective bodily self-awareness' is a thematic, observational consciousness of one's own body as an object whereas 'reflective bodily self-awareness' is an unmediated, nonthematic way of being aware of one's bodily self.

The post-questionnaires, filled in after the participants' engagement with VR, were based on the standardized embodiment questionnaire proposed by Gonzalez-Franco and Peck (2018), which were extended to explore and measure, apart from the 'level of avatar embodiment', whether the participants had experienced 'a reflective or a pre-reflective bodily awareness', 'the level of the space embodied perception' (high, medium, low), and 'their self-evaluated level of immersion' inside VR (high, medium, low).

By using correlation analysis as a statistical method to evaluate the strength of the relationship between the variables related to the participants' profiles in the pre-questionnaire (i.e. previous experience with VR and *reflective* and *pre-reflective* bodily awareness in physical space) and those related to the post-questionnaire, we concluded with the following findings:

- There is a strong relationship between the reflective bodily awareness of the participants in the physical space and that experienced inside the VR;
- The more the reflective bodily awareness shown by the participants in the physical space the higher is the level of the space embodied perception inside the VR;
- There is a strong relationship between the reflective bodily awareness of the participants inside the VR with the degree of their enjoyment and freedom they experience therein.

Apart from the analysis of the questionnaires, the empirical stage of the project provided an additional methodological procedure for the exploration of body-space relation, focusing on four case studies-applications, by means of a head mounted device. The selected applications - Blocks by Google⁴, Freedom Locomotion VR⁵, Kinese⁶, Wave

4. See: https://store.steampowered.com/app/533970/Blocks_by_Google/

5. See: https://store.steampowered.com/app/584170/Freedom_Locomotion_VR/

6. See: <https://store.steampowered.com/app/632080/Kinese/>

Beta⁷ - present imposed or allowed privilege of movement at different degrees, diverse types of natural or artificial interaction with the environment, fluctuations in complexity of geometrical representations and diversified narrative contexts. Thus, through contrasting different engagement interactive scenarios experienced by the participants, a varied body-movement patterns were revealed for each participant and for each case study (Figure 1).



Figure 1. Empirical stage documentation process of *Disembody* project.

The findings interrelating the questionnaires analysis with the motion capture data confirm that:

- There is a strong relationship between embodied interactions with other virtual entities and the overall body awareness;
 - There are serious indications that virtual embodiment can be related to a better practice of embodying another state of subjectivity, that is embodying an 'alloæsthetic' state.
3. At the final stage, a digital reference platform, called DISEMBODY, an expendable bodyscape, will be developed comprising: (a) methodologies about understanding, registering and categorizing corporeal data in body-space interactions; and (b) a pilot interactive application adaptable within real-time performance conditions in VR. The temporal body-space compounds are called *expendable meta-bodies*, as the digital space interacts along with body's movement, enhancing and intensifying the body awareness and aiming to assign a kind of virtual embodiment to the space itself (Figure 2).

7. See: https://store.steampowered.com/app/453000/Wave_Beta/

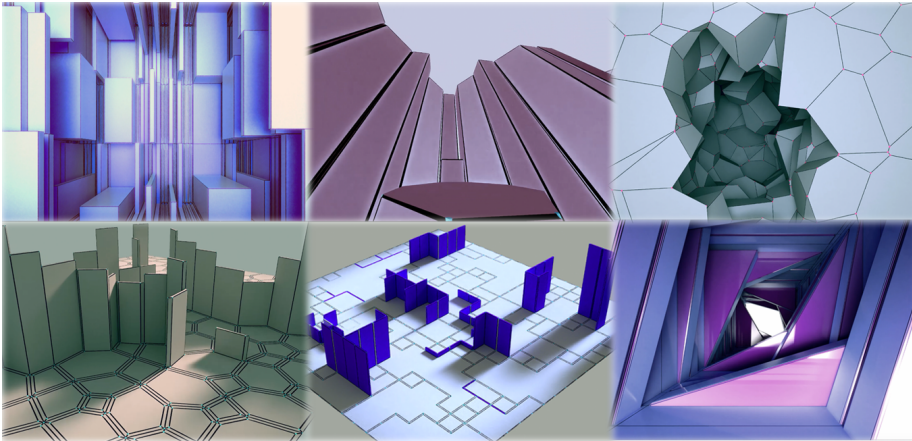

Figure 2. Interactive application images from the animation video demos.

Conclusions

The innovation of the research project lies in applying theoretical, empirical and design procedures in order to associate architectural practices with embodied inter-related environments. We have initiated the exploration of ‘materiality’, ‘de-subjectivity’ and ‘corporeity’ through the bibliographical and empirical research stage. The questionnaires and the main thematic fields have been structured in order to identify the wide range of implications and correlations between the body and the space. The motion capture techniques and the audiovisual documentation provide the context of multimodal data flow that have been used to extrapolate the conclusions of the overall research.

In this vein of performative technology, the bodies are the ultimate mediators and the question of the limit is repeatedly evidenced through corporeity, since bodies have been expanded in time, space and consciousness. Traditional concepts such as otherness and sameness are questioned and our ‘expendable meta-bodies’ inscribed in the assimilation of the partiality, intimacy and proximity, aim to produce and redefine the ‘alloaesthetic’ sensation.

References

- Albright, Thomas. “Neuroscience for Architecture.” In *Mind in Architecture: Neuroscience, Embodiment, and the Future of Design*, edited by Sarah Robinson, and Juhani Pallasmaa, 197-217. Cambridge: The MIT Press, 2015.
- Bianchi-Berthouze, Nadia, Whan Woong Kim, and Darshak Patel. “Does Body Movement Engage You More in Digital Game Play? And Why?” *ACII '07 Proceedings of the 2nd International Conference on Affective Computing and Intelligent Interaction* (September 2007): 102-113. https://doi.org/10.1007/978-3-540-74889-2_10
- Colombetti, Giovanna. “Varieties of Pre-reflective Self-awareness: Foreground and Background Bodily Feelings in Emotion Experience.” *Inquiry*, no. 54 (May 2011): 293-313. <https://doi.org/10.1080/0020174X.2011.575003>
- De Vignemont, Frederique, Manos Tsakiris, and Patrick Haggard. “Body Mereology.” In *Human Body Perception from the Inside Out*, edited by Günther Knoblich, Ian M. Thornton, Marc Grosjean, and Maggie Shiffrar, 147-170. New York: Oxford University Press, 2005.

Ekstrom, Arne, Aiden Arnold, and Guiseppa Iaria. "A Critical Review of the Allocentric Spatial Representation and its Neural Underpinnings: Toward a Network-based Perspective." *Frontiers in Human Neuroscience*, no. 8 (October 2014). <https://doi.org/10.3389/fnhum.2014.00803>

Fels, Sidney. "Intimacy and Embodiment: Implications for Art and Technology." *Multimedia '00. Proceedings of the 2000 ACM Workshops Multimedia*, (November 2000): 13-16. <https://doi.org/10.1145/357744.357749>

Gonzalez-Franco, Mar, and Tabitha C. Peck. "Avatar Embodiment. Towards a Standardized Questionnaire." *Frontiers in Robotics and AI*, no. 5 (June 2018). <https://doi.org/10.3389/frobt.2018.00074>

Legrand, Dorothee. "Pre-reflective self-consciousness: On being Bodily in the World." *Janus Head*, no. 9 (January 2007): 493-519.

Panhofer, Heidrun. "Body Memory and its Recuperation through Movement." In *The Oxford Handbook of Dance and Wellbeing*, edited by Vicky Karkou, Sue Oliver, and Sophia Lycouris, 115-128. New York: Oxford University Press, 2017.

Papale, Paolo, Leonardo Chiesi, Alessandra C. Rampinini, Pietro Pietrini, and Emiliano Ricciardi. "When Neuroscience 'Touches' Architecture: From Hapticity to a Supramodal Functioning of the Human Brain." *Frontiers in Psychology*, no. 7 (May 2016). <https://doi.org/10.3389/fpsyg.2016.00866>

Ronccone Alessandro, Matej Hoffmann, Ugo Pattacini, Luciano Fadiga, and Giorgio Metta. "Peripersonal Space and Margin of Safety around the Body: Learning Visuo-Tactile Associations in a Humanoid Robot with Artificial Skin." *PLoS ONE*, no. 11 (October 2016). <https://doi.org/10.1371/journal.pone.0163713>

Van Kreijl, Kamiel. "Sensory Intensification in Architecture." Master thesis, TU Delft, 2008. <http://resolver.tudelft.nl/uuid:70bfcf66-1e8e-454c-ac37-700d13378524>

Atelier Art et Re-Action (Area)

Performing Urban Routines and Rituals

Ricardo ATIENZA¹,
Monica SAND²,
Robin MCGINLEY³

Abstract. This paper presents a series of contemporary artistic methods and collective actions based on the pioneering work of the French avant-garde group Art et Action (AEA, 1919-1939). AEA actively responded to the fast-changing society of their time through their innovative 'theatre laboratory', an experimental artistic research environment in which actors and audience were invited to investigate together the rhythmic order of urban routines and rituals, through the re-enactment of daily urban atmospheres. Based on AEA's methods and concepts, atelier Area aims at responding to today's deep physical, sensorial and social transformation of the city by re-acting contemporary urban routines and rituals through public improvisations and interventions. Three concrete examples will be presented here.

Keywords. Art et Action, Urban Routines and Rituals, Re-Action, Artistic Research Methods

Performing Urban Routines and Rituals in the Avant-garde

AEA was inspired by, and a result of, the avant-garde movements at the beginning of last century. New technologies, electricity, machines and transportation deeply transformed the city and the modes of inhabiting, with new daily routines and rituals. The city became a performance space, a scenography as well as an actor (Tillberg, 2003). The Futurists, Dadaists, Constructivists, and other avant-garde movements - Bauhaus in Germany, VKhutemas in Moscow as well as the group AEA in Paris - re-interpreted the city through full-scale experiments and re-performances of daily city life, through innovative working processes intersecting art and research. Art and politics were combined, whilst staging urban daily life (Tillberg, 2003; Read, 2014). The aim was to break down the boundaries between disciplines, between audience and performers, and to provoke reactions. Artistic and research-based experiments were conducted both on the street and on stage, evolving a laboratory to critically explore urban structures and movements. Transmission between the unpredictable complexity of the urban and the laboratory's spatial demarcation, created a tension between everyday life, and the effort to stage it, through which it could be re-acted, acted out and played with.

1. Senior lecturer, Konstfack, University College of Arts, Crafts & Design, Stockholm, ricardo.atienza@konstfack.se

2. Senior researcher and Research Adviser, Faculty of Fine, Applied and Performing Arts, University of Gothenburg, Sweden, monica.sand@gu.se

3. Chair of Programme and Course Leader, International MA in Curating Art, Stockholm University, robin.mcginley@arthistory.su.se

Art et Action (AEA)

The group AEA (1919-39), led by artist/actress Louise Lara and architect Edouard Autant, staged an experimental research laboratory. In five 'dramatic structures' they explored different aspects of urban life with an aim to erase the boundaries between audience and performers, between daily life and representation. Actors and audience were invited to investigate, in open improvisations, the rhythmic order of *routines* that define daily urban life, together with social *rituals* as creation of social meaning. Through daily and cyclical re-performances, citizens and visitors relate to the city, as well as each other, by repeating, re-producing and re-performing social beliefs and a cultural rhythmic structure.

AEA's work was founded on the activations of two connected spatial situations: the complex urban reality in which they intervened, and the theatre stage, where this reality could be re-presented, framed and re-activated. This made it possible to try-out alternatives to urban questions, and to bring ideas back in-situ, testing them in real urban situations: a working process that mutually influenced the place and its representations.

AEA compiled an extensive anthology, an inspiring archive that covers much of their work, including among other elements, methodological texts and significant urban questions (Autant & Lara, 1952). Their intense search for methods to re-present contemporary issues, incorporating research through and with art, may certainly be valuable in our contemporary context. Not least since they offered an alternative to the modernist and functionalist architecture promoted by Le Corbusier and CIAM (Congrès Internationaux d'Architecture Moderne). The innovative work of AEA has almost been forgotten, although there are a few texts addressing their work from a single disciplinary perspective, thereby missing its complexity and critical richness. These include a doctoral thesis by historian Michel Corvin (1976) focusing on AEA's theatrical approach, and a recent work by architect Gray Read (2014) on architecture as a performing art. Most of AEA's a-disciplinary working process can still be considered as entirely innovative with respect to artistic practice, academic research or urban planning. We miss an insight into their advanced methods of relating urban situations with explorative laboratory experiments.

Methods by Art et Action (AEA) - Re-Presenting the City

For the modernists, the city was essentially a stage inspired by fine art: a visual set design. AEA instead proposed architecture as a performing art that made citizens collectively engage in a rhythmic simultaneity of actions and voices (Read, 2014). This major difference could explain *per se* their relatively marginal impact. AEA produced creative reactions to urban transformation, and acted these out on the stage. They left their complete material (Autant & Lara, 1952) with no description of conclusions or specific results, inviting instead the reader to try out their methods through action. An archive of methods thus replaced the usual collection of past events. With its creative combinations of performance art, research experiments and creative pedagogy, they legated a highly relevant compilation of strategies to be re-activated for those in search of artistic and spatial tools. For AEA, performing arts should be similar to daily urban life: a fusion of multiple simultaneous events, configuring an open situation impossible to contain or control.

Through a theatre-like laboratory *process* including improvisations, reading, repetitions and re-actions, they combined social, cultural and historical re-presentations of urban complexity. Exploring experimental artistic principles of simultaneous collective

actions, they dissolved the division between daily life and artistic representation. For AEA, theatre embodied a non-hierarchical space where performers and audience could gather, interact and perform the public *piazza*. The complexity of their work resembles human experience: they selected tools and inspiration from every aspect of history, culture and society and tested these out in space. The fragmentation of knowledge into fields and disciplines was thus deeply questioned: human actions and experiences could not be separated into disciplines; their approach moved beyond the notion of inter-disciplinarity, and could rather be characterised ‘a-disciplinary.’

Art et Re-Action (AREA): Working Process and Method

Through this project, the concept *re-action* will be employed as a method of re-activating and re-working history in the footsteps of AEA; to *react* to the contemporary situation by *re-acting* historical material and methods - thus our project title: *Atelier Art et Re-Action*.

Our working process is inspired by and follows the path opened up by AEA with collective interventions and experiments. In line with AEA, we understand routines and rituals as the embodied, rhythmic and spatial expression of the social structure and creation of meaning taking place. Within this frame, this research project connects two key spatial and embodied experiences. The first, in-situ, relating to the use of public space - the complex but common experience of place. The second, in the Atelier, relating to the re-activation and re-presentation of urban complexity. In this second instance, the complex reality can be framed, explored and performed in a more controlled spatial setting.

Explorations and re-activations of contemporary urban experiences provides us with the material and immaterial *content*, whilst the work of AEA offers a *methodological frame* for the process. The research process is built on the innovative relation between explorations in-situ and the space of re-presentation, *the atelier*.

In line with AEA, we extract daily situations from their context and explore their potential out-of-place, in the *Atelier*. Atelier AREA functions as a “place of representation” as a frame for an action-based reflection on the in-situ experiences. Within this frame, the collected material in-situ can be re-presented, e.g. presented again, in a new spatial setting that allows for experiments, explorations, and re-interpretations inspired by AEA’s archive of methods. The aim here is to learn from both the in-situ experiences and the historical narrations, in order to decode present situations and questions.

In a collective process, the collected urban material is re-acted and analysed by groups of invited artists, researchers, practitioners, citizens and students, in staged urban situations in which participants take part, and explore different roles. AEA developed five theatre laboratories⁴, each of them focusing a specific urban situation. AREA is instead structured in five ‘ateliers’, renamed according to the contemporary questions and methods explored. Each one takes place in different public places of representation. In this paper, three of these are presented through a specific action:

Atelier Resonance

Re-interpretation of AEA’s *Théâtre choréique*, focused on the sonic and sensorial

4. AEA’s 5 theatre laboratories: *Théâtre choréique* (Choral Theatre), *de l’espace* (of Space), *du livre* (of the Book), *de chambre* (Chamber Theatre), *universitaire* (University Theatre).

urban experience. Atelier Resonance is conceived for an auditorium or stage in which participants re-play the sound of public life, the sonic signatures of collective/individual actions and of sensorial experiences collected in-situ (Sand & Atienza, 2016). Playing with, repeating, re-interpreting roles and rhythms through resonance and different open and interactive forms of corporeal, instrumental or electro-mechanical sonic manifestations.



City experiment, a part of the exhibition *Experiment Stockholm*, Färgfabriken, 2015⁵. During the course *Sound Art: listening, resonating, intervening*, students from Konstfack (University of Arts, Crafts & Design, Stockholm) experimented with sound, movement and choreographies both in the city and in an exhibition space. The aim was to re-act, activate and interact with this space by using sonic objects of different nature as well as collective body movements. By playing the space we learn an awareness of how to resonate with and in space.

Each participant brought along a series of ‘sonic objects’, either in the form of everyday materials, urban recordings and compositions, or their own body and voice as a sound source. These materials and tools were necessarily related to existing urban sounds, movements and objects, and they were collected during preparatory in-situ experiments in Stockholm. In the exhibition space, we collectively performed a series of preparatory sound and motion exercises, exploring how we were simultaneously activated by the room, while also activating it with our presence and actions. During multiple short sessions, focusing on different characteristics of ambience, we devised together a series of methods and tools to improvise in an increasingly complex interactive context.

The purpose of these spatial experiments was to build an awareness of, as well as an active approach to the complex social, sensorial and mobile elements composing our daily urban environments. Through collective interaction, we studied how meaningful relationships are created between the city and its inhabitants, and how these can be consciously developed and influenced.

Atelier Revival

Re-interpretation of AEA’s *Théâtre du livre*, focused on artistic and literary representations of the city. Within the Atelier Revival, historical urban situations re-presented in literature, music, film, and the scenic arts in general, are re-acted, confronted and hybridised with re-presentations of contemporary urban situations and physical configurations. It takes its form through collective reading sessions, historical walks, and sonic corporeal improvisations.

5. Video documentation of this action at: <https://vimeo.com/149003424>



Cries of London, collective action at the symposium *Archives, Art and Activism: Exploring Critical Heritage Approaches to Global Societal Challenges*, University College London, UCL, 2016⁶. This action staged an urban public situation connected to the UCL-site. With our voices and other expressions, we re-activated the historical market presented in Orlando Gibbons' musical piece *The Cries of London*, 1620. This historical atmosphere was brought into confrontation with the contemporary/future market described in the policy document *UCL 2034. A new 20-year strategy for UCL*⁷. The activation staged the transformation of the market from material products to fulfil daily needs (Gibbons) into abstract future products with uncertain modes and needs. Education has become a commodified product on the market possible to be sold and consumed.

Atelier Traces

Re-interpretation of AEA's *Théâtre de l'espace*, focused on collective and simultaneous urban experience and construction. The aim of Atelier Traces is to explore the experience of the ordinary material and immaterial components of the urban environments. On the multiple and diverse traces of our daily activities and routines. These elements are collected, observed and presented in a new frame of experience in friction with their original context. A tension that should provide a new perspective, an acknowledgement of their presence and what they represent as traces of daily life.

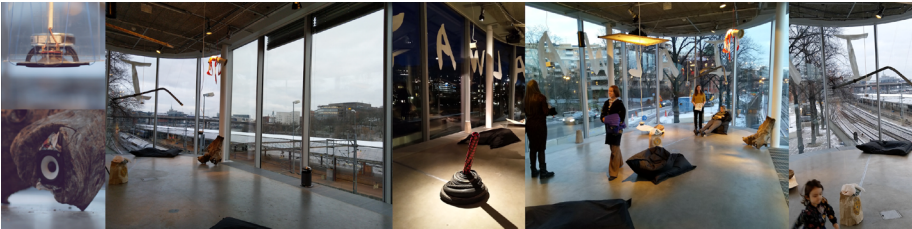

Sonopticon, collective sound installation, Bonniers Konsthall, Stockholm, 2018⁸. In collaboration with the *Sound in Interaction* Professional Course at Konstfack, in December 2018, this sound intervention arose from the remarkable architectural form and placement of Bonniers Konsthall's library space: a panopticon within the heart of the city, a lighthouse from which the dense and complex surrounding urban atmospheres can be observed in silence, insulated by a glass curtain wall. The intervention thus took the form of a sonic overlay - playing with this simultaneous inside/outside orientation, and the resulting disjunctions between what the audience will see and hear.

The installation was conceived and realized collectively, through a series of custom-built sounding objects created from found materials in the area, and distributed in the space to create a sonic ecosystem. A large collection of sonic textures and objects was also collectively drawn from the surrounding atmospheres, with each

6. Video documentation at: <https://vimeo.com/140061139>

7. See: <https://www.ucl.ac.uk/2034/>

8. Video documentation at: <https://www.youtube.com/watch?v=aZ3uQmlox5Q>

material simultaneously referencing a point on the visual horizon. All these physical and aural elements were spatialized and placed in dialogue to create a site-specific and immersive experience.

This immersion into quotidian urban sounds, in friction with the visual contemplation of their original environment, aimed at triggering an awareness and a new attention in the audience. Awareness of their daily physical and sensorial environment, and of the interactions established. Furthermore, drawing attention to the collective construction of these surrounding atmospheres, and thus to our role and responsibility as active constructors of our everyday environments.

Conclusion

The latin prefix *re-* marks that something either is repeated, comes back or is made anew, re-constructed and re-interpreted. The concept *re-search*, with the meaning to search and search again, cannot be abstracted mainly to methods, theories, and concepts. Rather a spatial rhythm of difference and repetition engages the body of the researchers in performing re-search as an achievement and enactment in a spatial and temporal context (Sand, 2018). Human actions, such as daily routines and social rituals are re-actions in its double sense: repetition of embodied spatial expressions and response to the social configurations and transformations taking place in and by society. There is important knowledge to be gained through re-turning, but also re-inventing through re-activations and re-actions. Rather than a mere repetition of AEA's work, we intend a *re-action*; a reaction to the complex transformations of the contemporary city, a re-activation of art history, a re-action and re-presentation of urban questions in a fruitful and poetic way.

References

- Autant, Edouard & Lara, Louise. *Art et Action, Cinq conceptions de structures dramatiques modernes*, Paris: Corti, 1952
- Corvin, Michel. *Le théâtre de recherche entre les deux guerres: Le laboratoire Art et Action, Théâtre années vingt*, Paris: La Cité-L'Age d'Homme, 1976
- Read, Gray. *Modern architecture in theatre: the experiments of Art et action*, New York: Palgrave Macmillan, 2014
- Sand, Monica & Atienza, Ricardo. *Playing the Space: Resonance, Re-Action and the Conference Re(s)on-Art*, in *Swedish Research Council artistic research yearbook 2016*, p. 52-61, 2016
- Sand, Monica. *Resonance in the Steps of Rubicon*, in *Performance as Research: Knowledge, Methods, Impact*, Arlander, et al. (ed.) International Federation for Theatre Research, Routledge, 2018
- Tillberg, Margareta. *Coloured universe and the Russian avant-garde. Matiushin on colour vision in Stalin's Russia, 1932*. Stockholm: Stockholm University, Eidos No. 10, 2003

Resonant Spaces

The Sound created by Space and the Space created by Sound

Sofía BALBONTÍN¹,
Mathias KLENNER²

Abstract. From the interaction between sound and space, the dimension of soundspace emerges. This research project and its series of artworks focuses on the aesthetic, and social aspects of soundspace as a means to create alternative and subjective narratives, to re-signify and deconstruct the memory of space and the architecture that sustains it. The paper revises the concepts of space and sound in architecture, social sciences and sonic arts of the 20th century, trying to create a link between these diverse practices and theories. Understanding that a major shift in all these disciplines occurred when sound and space coalesce. “Resonant Spaces” takes this tradition and applies it to a series of art pieces.

Keywords. Soundspace, Architecture, Performance, Critical Spatial Practice

Introduction

The concept of space has changed in the last century. In social sciences and humanities, the abstract and geometric space has become social space (Eisenberg, 2015); in music the space has brought time as the main focus of composition (Pardo, 2017); in the fine arts through the development of conceptual art, performance and land-art have revalued the context as the main basis of art work (Rogers, 2013); and in architecture where the static space of the building becomes dynamic (LaBelle, 2006).

The present research and the series of artworks “Resonant Spaces” are presented as a resignification, from subjectivity, performance and body, to the symbolic, affective and representational apparatus of architecture and, finally, to our society.

Sound Lines

Eisenberg (2015) suggests that sound and space are phenomenological and ontologically intertwined. From his perspective, sound is spatial since the listening process contains a spatial narrative for each sound. It is almost impossible to imagine sound without space or space without sound. For Leitner (1978), architect and sound artist, the soundspace becomes a space in constant transformation, defined by sound itself and its evolution over time. It becomes necessary to redefine the term ‘space’, understanding it as a sequence of spatial sensations, that is, a series of temporal events, where space unfolds in time, is developed, repeated and transformed. Leitner presents a series of spaces like sculptures of sound built from listening. His objective is to draw acoustic dynamics to create the sculptural experience of sound (LaBelle, 2006). They are sculptures in movement that work in sync with the movement of the

1. Universidad de las Américas - Núcleo de Investigación en Lenguaje & Creación, Chile, msbalbon@uc.cl

2. Universidad de las Américas - Núcleo de Investigación en Lenguaje & Creación, Chile, mathiasklenner@gmail.com

listener. Leitner's legacy affirms that the interaction of sound, space and body creates new architectures, new soundspaces.

Time in Architecture

The relationship between sound and space, can be understood from acoustics, based on the long relationship between music and architecture to maintain the sonic fidelity of spaces for musical performance (Blessner & Salter, 2007). But it was not until the appearance of the artistic avant-gardes of the 20th century and the emergence of what we call Sonic Arts, that the relationship between sound and space begins to take a dimension that transcends acoustics to become an instrument for experimentation in the arts and architecture. One of the first works to establish a new relationship between sound and space from architecture is the Philips pavilion by Iannis Xenakis and Le Corbusier, presented at 1958 Brussels World's Fair. Licht (2009) establishes that both, the tradition of acoustic architecture and sound spatialization were brought together in the Philips Pavilion. Edgard Varèse's *Poème électronique* and Iannis Xenakis's *Concret PH* were reproduced as an installation through 450 speakers. The pavilion built an architecture of sound that was changing over time and building other spatialities. Pardo (2002) states that geometry and mathematics are the generator of architecture and of the spatialized movement of sound and even of the composition of sound pieces in the Pavilion.

Time enters as a new variable that questions the static nature of architecture and opens up a diversity of design possibilities where the body and subjectivity plays a leading role. Space is not static anymore; it is in motion.

Spatial Turn

For Eisenberg (2015), the spatiality of sound and its sonorous nature were not fully integrated by Western culture until the so-called "Spatial Turn" occurred. The Spatial turn is an intellectual movement that turns to the concepts of place and space in the social sciences and humanities, specifically, under the idea that space is the context for the social, and also affects it (Lefebvre, 1974). According to Lefebvre (1974), space in its definition includes the body, action, energies (sound) and the built environment. He demonstrates that space is a social and political phenomenon and not just an absolute or natural phenomenon (Ouzounian, 2006).

This dialectical and dynamic conception of space is directly related to the processes occurred in art, music and architecture during the 20th century. Both arts and social sciences are transformed by this process where space becomes dynamic. Time penetrates space and space into time in a subjective condition, where space becomes a social space in constant change. Sound takes presence as energy that gives shape to the space in transformation and becomes creative matter for the arts, to declare the dynamic and social condition of space.

Critical Spatial Practice

Architect and critic Jane Rendell coined the term "critical spatial practice" to refer to works that cross the limits of art and architecture to engage with both the social and the aesthetic, and with the public and the private (Rendell, 2006). The term not only emphasizes the critical, but also the spatial, specifically the spatial aspects of interdisciplinary practices that operate between art and architecture. Creative practices and processes that articulate critical responses to contemporary social reality from space.

In the practices of sound resistance, Brandon Labelle (2018) states that sound has the ability to make the invisible visible, to bring to light discourses that are marginalized from hegemonic circuits, at the same time, it has the ability to infiltrate the public space without necessarily being co-opted as the visual image. Taking into account both resistance practices based on sound and the concept of critical spatial practice, the present research works between them. Creative practices that operate at the disciplinary crosses between art and architecture, working within soundspace critically to contemporary society.

Sonic Flux and Background Noise

The noise in the history of philosophy and art of the 20th century takes a leading position, like a murmur that is always there, that forms the basis of our being, from which shapes and sounds appear (Serres, 1982). Each signal is separated from the hustle and bustle of silence, noise and silence come together like two sides of the same coin.

Christoph Cox (2018) raises the idea of “Sonic Flux,” sounds cease to be point elements and can be understood as part of a continuous and lasting flux. For Sterne (2012), space is not only a container or a context for action, but it is generative and always in flux, as well as our perception of it. Would it be possible to speak of a spatial flux? As Cox (2018) establishes, the sonic flux that is part of space, there is actually a continuous relationship where space and sound intersect (Saladin, 2014). If space is dynamic and is also in flux, we can extend Cox’s idea to the concept of soundspace. Soundspace as a continuous flux that is always in motion, of energy and matter where all soundspaces coexist.

Listening of Space

Roland Barthes (1993) makes a difference between hearing, as the mere physiological phenomenon that can be described through acoustics and the physiology of ear, from listening. Hearing is a passive and receptive act, characterized by a state of alert to the environment. While listening, also called decoding, is active, it is no longer only physical, but psychological, it involves the brain, mind and soul, in an interior and creative act. The artist Pauline Oliveros (2005) starts from Barthes’s premise to define her practice, called “Deep Listening,” where space and time merges into the concept of soundspace. Influenced by John Cage, his idea of “Deep Listening” involves listening to the continuum of sound including its silences, as well as Michel Serres (1982) suggests.

Lucier (2014) describes his work “I am Sitting in a Room,” where he records his own voice inside a room reciting a speech which is reproduced and re-recorded several times in the place, until only the resonant frequencies remain. In that piece he makes a fundamental statement: “performing is more a matter of careful listening than of making sounds happen.” It is in attentive and deep listening where the force of sound art resides. The understanding of the world through sound practices changed during the 20th century, because our way of hearing the world has changed.

Relational Vibrations

Aden Evens (2005) presents sound as a vibration that always remains and never goes away, only transforms, resonating on the walls of a room forever. Adolf Loos (1912) affirms that it is not the form of architecture that provides good acoustics but it is its materials, its walls that for years have modified its molecular structure by vibrations of good music. For Amacher (1979) the limits of architecture do not end in the walls,

but go from space through the body, transforming the notion of what it means to inhabit space. The space becomes inhabiting the body in an active way from vibration (LaBelle, 2008).

The vibrations going through sound, the body and space are intrinsically relational, leaving the walls to go through air, connecting bodies, generating air pressure, connections are built. The vibrations destabilize the architecture and also ourselves. In their relational action, vibrations and resonances build atmospheres and environments. Jean-Paul Thibaud (2011) states that the environment of a place works as an energy flux that influences the space and its situational conditions, while at the same time building a feeling of belonging. The relational condition of soundspace, as a means through which we build social relationships between humans, non-humans and architecture itself, promotes a sense of belonging with the built environment.

Performance and the Voice of Space

Rogers (2013) describes the transformation of the concept of space meant for music, the arts and architecture, going from a geometrical dimension to an ideological and social one. At the same time, that art began to open up to other expanded fields, performance became the main component of experimental music. The relationship between the elements became increasingly important, allowing the context to become the content (Albers, 1952). As music began to break its obstacles with space, and art and architecture broke its obstacles with time, they began to converge in a new space, the space of performance (Rogers, 2013). That can also be understood as the soundspace.

In 1969, Alvin Lucier presented his piece “I am Sitting in a Room.” Lucier not only makes the space build sounds specific to its architecture through reverberation, but also transports a soundspace to a totally different space, that of the auditorium. With this, what he is doing, through electroacoustic means, is building a space through sound, at the moment it is reproduced. By perception, we can experience the spatiality of the room where Lucier recorded his piece. The soundspace is not only created by the acoustics of the room, but also the sound recreates the original space. Jennie Gottschalk (2016), when referring to the different performance works from experimental music that work with the resonance of spaces, points out a common characteristic that is to fill the space with sound or fill it with sound objects through an additive process. Saturate it, like the act of filling a container with water.

Resonant Spaces

Based on this theoretical reflection on the evolution of artistic disciplines around sound and space, we now face our own research project: Resonant Spaces. Using the tradition of experimental music to fill spaces with sound through action, “Resonant Spaces” uses vocalizations and percussions with found objects, and slow feedbacks to take out the voice of space and its resonant frequencies. From the tradition of acoustic studies, impulse responses and frequency sweeps, as artistic tools, are used to make the space speak.

The case studies for experimentation are abandoned infrastructures in the margins of memory and the urban, sublime architectures from wartimes, inhabitable places with unique and exacerated acoustics: A Gasometer and a Cooling Tower of an abandoned power plant in Belgium, a Flood Cistern, a Textile Residual Water Pool and an Air-Raid Shelter in Catalonia, and two Oil Tanks of the WWII in Scotland, with reverberations (T60) from 5-80 seconds.

As an attempt to converge the thinking of social sciences and sound studies about space, and the practice of sound spatialization architectures, sound art pieces and performances, “Resonant Spaces” creates a series of soundspace artworks: a documentary called “Resonant Spaces Research”³, a performance and installation series called “Resonant Spaces #1⁴, #2⁵ and #3⁶,” and an LP that gathers all the sounds experimentations “Espacios Resonantes”⁷.

Conclusions

Artists, musicians, architects and thinkers from social sciences during the 20th century, have opened up the notions of space and sound, not only as geometrical, physical or abstract dimensions, but as resonant spheres (Dewey, 1934) where the world can be experienced and understood in its social and relational dimension. In this sense, the body appears as a direct link between sound, space and the memory of place.

The performance and the presence of body in space builds a subjective and unique gaze, which is capable to reconstruct space, architecture and memory. The background noise is open, to give rise to the soundspace flux, from its original history as architectures, until today as opportunities for artistic action. Performances that generates a third space, where the public is part of the sound experience and their bodies intervene in the perception of the sounds that travel through speakers.

“Resonant Spaces” was developed as a story that tried to join diverse disciplines and traditions around sound and space. Through an active listening of soundspaces, our perception allows us to think about possible new critical spatial and sonic practices.

References

- Albers, J. (1964). The Origin of Art. In *Theories and Documents of Contemporary Art: A Sourcebook of Artists' Writings*, 131.
- Amacher, M. (1979) Psychoacoustic Phenomena in Musical Composition. *Arcana III*, 9-24.
- Barthes, R. (1993). *El acto de escuchar, lo obvio y lo obtuso*. Paidós.
- Blesser, B., Salter, L. (2007). *Spaces Speak, are you listening? Experiencing aural architecture*. The MIT Press.
- Cox, C. (2018). *Sonic Flux: Sound, Art, and Metaphysics*. University of Chicago Press.
- Dewey, J. (1934). Art as experience. Minton, Balch, and Company.
- Eisenberg, A. (2015). Space. *Keywords in sound*, 193-207.
- Evens, A. (2005). *Sound ideas: Music, machines, and experience* (Vol. 27). U of Minnesota Press.

3. Balbontin, S. & Klenner, M. (2020). *Resonant Spaces Research* [Video file]. Retrieved from <https://vimeo.com/425336402>

4. Balbontin, S. & Klenner, M. (2019). *Espacios Resonantes #1* [Video file]. Retrieved from <https://vimeo.com/339738628>

5. Klenner, M. (2020). *Espacios Resonantes #2* [Video file]. Retrieved from <https://vimeo.com/413820953>

6. Balbontin, S. & Klenner, M. (2020). *Resonant Spaces #3* [Video file]. Retrieved from <https://vimeo.com/407603572>

7. Balbontin, S. & Klenner, M. (2020). *Espacios Resonantes* [LP]. Barcelona, Spain: Soundspace Records. Retrieved from <https://espaciosresonantes.bandcamp.com/album/espacios-resonantes>

- Gottschalk, J. (2016). *Experimental Music Since 1970*. Bloomsbury Publishing.
- Labelle, B. (2006). *Background Noise, Second Edition: Perspectives on Sound Art*. A&C Black.
- Labelle, B. (2018). *Sonic Agency: Sound and Emergent Forms of Resistance*. Goldsmith Press.
- Lefebvre, H. (2013). *La producción del espacio*. Capitán Swing.
- Leitner, B. (1978). *Sound: Space*. NYU Press.
- Licht, A. (2009). Sound Art: Origins, development and ambiguities. *Organised Sound*, 14(1), 3-10.
- Lucier, A., Simon, D. (1980) *Chambers, Scores by Alvin Lucier*. Wesleyan University Press.
- Lucier, A. (2014). The Propagation of Sound in Space. A Point of View (1979). *Tacet*, 3, 31-46.
- Loos, A. (1912) The Mystery of Acoustics. *On Architecture*. Ariadne Press.
- Oliveros, P. (2005). *Deep listening: A composer's sound practice*. luniverse.
- Ouzounian, G. (2006). Embodied sound: Aural architectures and the body. *Contemporary Music Review*, 25(1-2), 69-79.
- Pardo, C. (2002). Del poema al gesto electrónico total: una continuidad en transformación. *Massilia: Anuario de Estudios Lecorbuserianos*, (2002), 194.
- Pardo, C. (2017). The Emergence of Sound Art: Opening the Cages of Sound. *The Journal of Aesthetics and Art Criticism*, 75(1), 35-48.
- Rendell, J. (2006). *Art and Architecture, A Place Between*. I.B. Tauris & Co Ltd.
- Rogers, H. (2013). *Sounding the Gallery: Video and the Rise of Art-music*. Oxford University Press.
- Saladin, M. (2014). Tracing sound space. *Tacet*, 3, 10-27.
- Serres, M. (1982). *Genesis*. 4th ed. Translated by Genevieve James and James Nielson. The University of Michigan Press.
- Sterne, J. (2012). *The sound studies reader*. Routledge.
- Thibaud, J. (2011) The Three Dynamics of Urban Ambiances. *Site of Sound: Of Architecture and the Ear*, Vol. II, 43.

Phantasmagorias of the Post-Colonial Interiors

Abstract. Benjamin has stated in his *Arcades Project*, under “Louis P..., or the Interior”, that “[t]he unreal center makes its place in the home” (Benjamin, W. *The Arc. P.* 1999, 9). For much of the bourgeois homes of today, the vestiges [Spurren] of an exoticism gave the private man the atmosphere of “a box [Kasten] in the theatre of the world” (ibid.). Later, the *Jugendstil* made of homes an illusory, stylish setting and the interior into a *Wunderkammer*. This paper focuses on such a lineage, from ornaments to souvenirs, from arty to do-it-yourself, which now, in ex-colonialist nations, bring a collection of naturalistic-memories and ethno-nostalgia, mingled with a high-tech ultra-modern air, within a sense of hybrid visions of tribalscapes. Nonetheless, they engage in a visible/ invisible complex.

João CUNHA¹

Keywords. *Post-Colonial, Figuration, Ambivalence*

“Just as external history is ‘reflected’ in internal history, semblance [Schein] is in the interior space”
Kierkegaard, T.W. Adorno and Benjamin, Walter. *The Arcades Project*.
Cambridge: Belknap Press of Harvard University, 1999, 219.

Post-Colonial Interiors

The argument of this paper is that interiors reflect a cultural atmosphere that is neither simply based on tradition nor in state of the art innovation. In fact, they are crossed by history such as are cities, homeland landscapes and countryside settings, pointing to a wide traditional element that can incorporate what the hegemonic cultures (Saïd, 1995) have considered for so long as inferior objects from colonized territories. If not inferior, at least, dominated ones, by means of what Homi K. Bhabha calls the “stereotype” effect regarding the relation colonizer/colonized in his essay *The other question: the stereotype and the colonial discourse* (Bhabha, Homi. In *Visual Culture: the reader*, ed. Jessica Evans and Stuart Hall, London, Sage, 370-378).

In fact, it must start to be stated that the interiors which are at stake here, belong to a lineage of what Walter Benjamin was the champion to name the bourgeois dwelling. Therefore, it should not be taken for the castle, the fortress or the palace environment, but instead, that sort of a “compass case” (Benjamin, 1999, 220) [*Zirkelkastens* (Benjamin 1991, 292)] from where the individual grabs hold of historical events. just for the sake of prestige, denouncing a curiosity knowledge that is no other than a dominion of past worlds and times, within a sense of powerfulness:

¹ J.B. CUNHA Lisbon - Universidade Lusófona de Humanidades e Tecnologias - LEAU Research Group, Portugal, borgesdacunha@ulusofona.pt

The private individual, who in the office has to deal with reality, needs the domestic interior to sustain him in his illusions. This necessity is all the more pressing since he has no intention of allowing his commercial considerations to impinge on social ones. In the formation of his private environment, both are kept out. From this arise the phantasmagorias of the interior - which, for the private man, represents the universe. In the interior, he brings together the far away and the long ago. His living room is a box in the theater of the world (Benjamin, 1999, 8).

The unexpected result of what Benjamin calls a box to see the world, as it must be observed, is that the colonial universe, so to speak, entered this dwellings by means of objects and other unsuspected kind of beings that led the nowadays post-colonial interiors to a sort of *Wunderkammer* [a Cabinet of curiosities], which are a scene of what Homi Bhabha calls the “process of *ambivalence*, central to the stereotype” which is still the “major discursive strategy (...) of the colonial discourse” (Bhabha, 1999, 370).

This does not mean that colonialism got to encounter an alternative way of proceeding its program in the form of decoration and interior arrangement, which would be quite a reactionary statement. But on the other hand, like all times interior settings it was captured by an imaginary that brings a taste of all things past, though they might be quite alive and still subjects of exploitation and “epidermal schema” (Fanon and Bhabha, 1999, 376). By means of a reaction to the capitalist mass production utilities, which only give sway to the imperialistic kitsch and arty souvenirs industry.

What is being argued is not that some kind of reversed colonization has happened through the phantasy in which post-colonial interiors have engaged by the exhibition of hunting trophies, tribal monuments and ethnic statuary. It is instead that this ambivalent value, to use Homi Bhabha’s terms, is affected by a double strategy of fixity on the masking of artifacts, which offer them their “phantasmatic quality” (Bhabha, 1999, 376), as well as their revelation under a regime of a “scopic drive” (Bhabha, 1999, 375). All these, surveillance and identity anxiety, sure reproduce the colonial discourse, but as to what the interiors are concerned, it goes further, or at least further back, since the taste for antiques and the matter, which the utmost example is the hanging of old china, means nothing less than a proclivity for the domestic interiors being a mimicry of the temple. And in modern times, of the museum. All in the name of a class-ridden complex, according to which, the nobles and the royals live prestigious past lives.

Because the modern sciences surpassed the hegemonic historical epistemological regime, it is no wonder that, through the precocious colonial sciences, such as anthropology, ethnography, paleontology and evolutionary biology, all dwellings tend to look like a multicultural museum. Like in the *incipit* of L.P. Hartley’s novel, *The Go-Between*, the antique and the foreign are interchangeable. As it goes: “The past is a foreign country: they do things differently there” (Hartley, 1996, 7). However, we can see the same effect in a typical nineteenth century bourgeois household dwelling, in the Buddenbrooks’ Mengstrasse house, where in the 1901 eponymous novel by Thomas Mann, the ancient represents nothing else but the faraway, with a touch that the nostalgic post-colonial ambiance was never capable of go without: places of freedom, well-being and fortune. Just like in *Buddenbrooks*:

The room was hung with heavy resilient tapestries put up in such a way that they stood well out from the walls. They were woven in soft tones to

harmonize with the carpet, and they depicted idyllic landscapes in the style of the eighteenth century, with merry vine-dressers, busy husbandmen, and gaily beribboned shepherdess who sat beside crystal streams with spotless lambs in their laps or exchanged kisses by a pale yellow sunset to match the yellow coverings on the white enameled furniture and the yellow silk curtains at the two windows (Mann, 2020, 5-6)².

A return to the reading of Homi Bhabha's conjecture on colonial stereotypes has to be clearly put. In reality, as might be seen in the images below, the currency of the stereotypical discourse, as equal it was to the historical proven fact, is not based on a simple reduction of human variables, but instead in a functioning of a fixed repeatability:

Fixity, as the sign of cultural/historical/racial difference in the discourse of colonialism, is a paradoxical mode of representation: it connotes rigidity and an unchanging order as well as disorder, degeneracy and daemonic repetition. Likewise, the stereotype, which is its major discursive strategy, is a form of knowledge and identification that vacillates between what is always 'in place', already known, and something that must be anxiously repeated – as if the essential duplicity of the Asiatic or the bestial sexual license of the African that needs no proof, can never really, in discourse, be proved. It is this process of *ambivalence*, central to the stereotype [...] that ensures its repeatability. (Bhabha, 1999, 370)

It is this chain of repeated stereotypes in the form of hunting assets, black statuary and a dark atmosphere that can be seen in Figure 1 as a post-colonial setting, which clearly gives a prophetic tone to the words of Walter Benjamin:

In the end, things are merely mannequins, and even the great moments of world history are only costumes beneath which they exchange glances of complicity with nothingness, with the petty and the banal. Such nihilism is the innermost core of bourgeois coziness—a mood that in hashish intoxication concentrates to satanic contentment, satanic knowing, satanic calm, indicating precisely to what extent the nineteenth-century interior is itself a stimulus to intoxication and dream. This mood involves, furthermore, an aversion to the open air, the (so to speak) Uranian atmosphere, which throws a new light on the extravagant interior design of the period. To live in these interiors was to have woven a dense fabric about oneself, to have secluded oneself within a spider's web, in whose toils world events hang loosely suspended like so many insect bodies sucked dry. From this cavern, one does not like to stir. (Benjamin, 1999, 216)

In a nutshell, a place of phantasmagorias.

2. Die starken und elastischen Tapeten, die von den Mauern durch einen leeren Raum getrennt waren, zeigten umfangreich Landschaften, zartfarbig wie der dünne Teppich, der den Fußboden bedeckte, Idylle im Geschmack des 18. Jahrhunderts, mit fröhlichen Winzern, emsigen Ackersleuten, nett bebänderten Schäferinnen, die reinliche Lämmer am Rande spiegelnden Wassers im Schoße hielten oder sich mit zärtlichen Schäfern küßten...Ein gelblicher Sonnenuntergang herrschte meistens auf diesen Bildern, mit dem der gelbe Überzug der weiß lackierten Möbel und die gelbseidenen Gardinen vor den beiden Fenstern übereinstimmten... (Mann, 2007, 10)



Figure 1. ¡HOLA!, Nr. 3.957, 3rd May 2020, Madrid, p. 8-9

In Figure 2 one can clearly perceive the major fascination that the colonial bric-a-brac exerts in post-colonial, and therefore, modern sensibility, which is the stereotypical gaze towards the so to speak naturalistic irregularities and imperfect handicraft work that allows all of it a commitment to an atmosphere of asymmetries and deviations, going from the tigress and zebra skin carpets to the twisted horns of gigantic beasts. As Benjamin states, denouncing the colonial stereotype of savage disarray and master Vs. slave/conquer Vs. conquered nexus:

In the first place, arranging at an angle enforces a distinction - and this, once more, in a quite literal sense. By the obliquity of its position, the object sets itself off from the ensemble, as the carpet does here... But the deeper explanation for all this is, again, the unconscious retention of a posture of struggle and defense. In order to defend a piece of ground, I place myself expressly on the diagonal, because then I have a free view on two sides. It is for this reason that the bastions of a fortification are constructed to form salient angles... (Benjamin, 1999, 216)



Figure 2. ¡HOLA!, Nr. 3.955, 20th May 2020, Madrid, p. 8-9

In Figure 3, one can find one of the most emblematic tropes of a stereotypical discourse on the colonial environment which was deeply studied by Pierre Bourdieu in his *The Berber house or the world reversed*, among the Kabylla community. The house is a place of inversions. It is never safe, despite one feels its domesticity. It is a place of aggressive negotiations and tends to turn things the other way round. Something that is supposed to be tightly safeguarded is in fact sheer lost. Just like in Figure 3, things that should be busts of real people, are nothing more than flowerpots. Moreover, with swapped skin colour.



Figure 3. ¡HOLA!, Nr. 3.956, 27th May 2020, Madrid, p. 8-9

Conclusion

Post-colonial interiors are ambivalent in their use of a creative nostalgia but also of old-school artefacts. They tend to lead one into a discomfort made by a double effect: a misconception of the faraway, based on repeated stereotyped, combined with a recognition of a natural atmosphere, in a disparaged knowledge of places and peoples. As a matter of fact, they are truly a reproduction of what this paper calls a phantasmagoria scene, or using a zoological metaphor, a cage where the natural and the exotic can be turned endemic and tamed, just like Figure 4 shows and Theodore Adorno asserts:

The ordering of things in the dwelling-space is called 'arrangement.' Historically illusory <*Geschichtlich scheinhaJte*> objects are arranged in it as the semblance of unchangeable nature. In the interior archaic images unfold: the image of the flower as that of organic life; the image of the orient as specifically the homeland of yearning; the image of the sea as that of eternity itself. For the semblance to which the historical hour condemns things is eternal (Adorno and Benjamin 1999, 220).



Figure 4. In Barros, Jacinta, Rui Simões, Production, *Portuguêsses*, Documentary Feature directed by Rui Veiga for RTP- Radio Television of Portugal, 11th June, 2020, 40:07 min.

References

- Benjamin, Walter. *Gesammelte Schriften* 1-2. Frankfurt am Main: Suhrkamp Verlag, 1991.
- Benjamin, Walter. *The Arcades Project*. Cambridge: Belknap Press of Harvard University, 1999.
- Bhabha, Homi. "The other question: the stereotype and colonial discourse." In *Visual Culture: the reader*, edited by Jessica Evans and Stuart Hall, 370-78. London: Sage, 1999.
- Bourdieu, Pierre. «The Berber house or the world reversed» In *Information* (International Social Science Council), Volume: 9 issue: 2, page(s): 151-170, 1970.
- Hartley, L.P. *The Go-Between*. London: Penguin, 1996.
- Mann, Thomas. *Buddenbrooks*. New York: Dover Publications, Inc. trans. Helen Tracy Lowe-Porter, 2020.
- Mann, Thomas. *Buddenbrooks*. Frankfurt am Main: S. Fischer Verlag, 2007.
- Saïd, Edward W. *Orientalism*. London: Penguin Books, 1995.

03

ATMOSPHERES + DESIGN

04

BODY, CULTURE, IDENTITY

05

DIGITAL ARCHITECTURE. ATMOSPHERES IN DESIGN
AND NEW RESPONSIVE & SENSITIVE CONFIGURATIONS

06

FROM A SENSITIVE ECOLOGY OF
AMBIANCES/ATMOSPHERES TO A POLITICAL ECOLOGY

07

INFINITE ATMOSPHERES? ETHIC DIMENSIONS
OF AND FOR THE DESIGN OF PUBLIC SPACES

Digital Architecture. Atmospheres in Design and New Responsive & Sensitive Configurations

Session 5 – Introduction

Amal ABU DAYA¹,
Philippe LIVENEAU²

Since the 1960s, the digital shift in architecture has shaped the evolution of the discipline, both in terms of academic research and operational practice. Preliminary explorations on the generation of forms was followed by the issue of performative design and the control of atmospheres, then the renewal of design methods using parametric modeling tools.

Since the 90s, material embodiment, manufacturing tools, and interactive technologies constitute new theoretical, methodological and aesthetic horizons for architecture. Notions of non-standard architecture, the design-manufacturing continuum (from file to factory, from design to production) or even the renewed interest in ornamentation, directly question the ambiances ; those of design situations, on one hand, and the situated experiences of contemporary architecture, on the other hand.

Are there unique atmospheres likely to characterize the digital architecture of the 21st century, whether we focus on the terms of design, manufacture or perception of these "new" ambient environments ?

- How has the transition from digital virtuality to the of (physical) prototypes transformed the activity of designing architecture and / or atmospheres ?
- How does the possibility of embodying design objects, also known as the design-manufacturing continuum, have the effect of refocusing the project activity on the perceptual quality and the sensitive interactions of the designer with the artefacts produced ?
- How does the renewal of design practices induce new ecosystems of actors, enabled the development of new "workshops" of design-production and generated new "working atmospheres," within schools of architecture, research laboratories or in operational practice?
- Is it possible to single out, through the joint reintroduction of technique and materiality in the field of architecture, a "phylum machinique" specific to the digital era, whose expression features question the atmospheres, in terms of variation, configuration or renewed aestheticism of our built and perceived environments ? Are there arrangements and / or devices specific to digital architecture?

1. AAU Laboratory, Cresson, France.

2. AAU Laboratory, Cresson, France.

- How does the development of a non-standard architecture, which we will associate with the possibility of the serial production of differentiated components, allow us to think of an architecture that is more attentive to users (mass customization) and the environment (energetic performance)? Can the digital turn of the architectural discipline be understood as the renewal of a socio-ecology of atmospheres to be designed ?

The Formation of the Technological Sensitivity

Gaining a New Perspective on Existing Objects

Sebastien BOURBONNAIS¹

***Abstract.** This article aims to clarify how recent transformations in the field of architecture, chiefly the availability of new digital design tools, have introduced new ways of approaching projects. It will delve into the philosopher of science Gaston Bachelard's thought and the notion of phenomenotechnique in order to explore the off-centre position of the architect. Mastering these tools has inculcated in architects a 'technological sensibility'. The formation of this sensibility has expanded architects' vision beyond the potential of the technologies themselves to finding new perspectives on more traditional architectural considerations.*

***Keywords.** 1 Digital Architecture, Technological Sensibility, Phenomenotechnique*

Digital technology has introduced new methods to architectural practice, bringing about many transformations, both big and small, which some architects have integrated to their existing considerations. Consequently, this adoption process involves matching this technological potential with the intentions of the architects. These intentions are somewhat nebulous, as they combine zeitgeist-driven motivations, questions passed down from the architects that came before, unique approaches, and an evolving 'digital' imagination. In spite of the complexity and interwovenness of these various intentions, one could say that the adoption process is complete when it finds a unique, relevant application to a specific project. It is through these diverse considerations that digital technology has been introduced into practice and transformed sensibilities - to the extent that it could be said that the technologies themselves 'constructed' these sensibilities.

In his epistemological work, philosopher Gaston Bachelard laid out a number of areas for exploration that may be helpful in attempting to understand the contributions of digital technology to the field of knowledge of architecture. While it is not our intent to equate architectural practice with a scientific endeavour, some concepts, such as *phenomenotechnique*, may be extended to help understand the changes some architects have adopted in their practice. This short article aims to establish a possible analytical method, rather than provide a true in-depth, exhaustive analysis. It will involve examining the evolution of the works of Achim Menges and his multidisciplinary team in order to understand which aspects of architecture have been expanded to gain new perspectives on more traditional architectural considerations, by these complex, sophisticated technologies.

1. Research Associate at l'Evcau and Research consultant at Asynth. sebastien.bourbonnais@gmail.com

The Transformation of Architectural Practice

It is important to remember then, since the end of the 1990s, new technologies have radically transformed the architectural field. Focusing our study of the digital transition on the new technological tools highlights the power dynamics that were created between the architect and the technology. In this sense, the focus is no longer only on the physical reality of the buildings themselves, nor even on their morphogenetic processes, which are complex and varied, but it also extends to the experimental conditions of these practices, and especially on the technical difficulties architects face. It also involves broadening our vision to include what Bachelard would call the “epistemological obstacles” that architects have had to overcome.

Bachelard develops this idea of epistemological obstacles in *The Formation of the Scientific Mind*, in which he aims to explore the efficacy of scientific thought through the prism of normative judgement. The philosopher argues that it is rarely a matter of merely extending or refining an intuition - this intuition must instead be corrected. For this reason, he proposes a series of methods for investigating the disruptions and reversals that *construct* scientific knowledge, such as this one: “Knowledge [must be] brought back into contact with the conditions that gave it birth; we must keep returning to that ‘nascent state’ which is the state of psychic vigour, at the very moment when the answer has come from the problem” (Bachelard, 1938, 49). This method reveals how practices have evolved over time and makes it possible to set aside any biases in order to revisit ideas that had previously been discarded.

It is important to note here that in referring to Bachelard’s work on scientific knowledge we do not mean to imply that architecture is a scientific endeavour. Indeed, our aim is instead to attempt to redefine sensible knowledge, or at least to rethink it in light of the changes wrought by the adoption of digital technologies, which we assimilate to the notion of *phenomenotechnique*.

We are exploring Bachelard’s thought surrounding the role of technique, and more specifically, that of the instruments that are involved in the ‘construction’ of the objects of our study, as well as of the meanings being used. The philosopher insists on this point: “science *realises* its objects without ever just finding them ready-made. *Phenomenotechnique extends* phenomenology” (Bachelard, 1938, 70). Phenomena which would *prima facie* be inaccessible to perception become perceptible through the technical tools that are put into place to observe them. As the philosopher points out, the phenomena do not simply appear, but they do so within the logic of the tool that revealed them.

Extending the Concept of *Phenomenotechnique*

Bachelard’s notion of *phenomenotechnique* was intended to emphasise the significant position of technical mediation in understanding and perceiving phenomena. “[The purpose of *phenomenotechnique*] is to amplify what is revealed beyond appearance. It takes its instructions from construction” (Bachelard, 1934, 13). Through this notion, which Bachelard limits to scientific phenomenology, the philosopher warns against what appears self-evident to human perception by drawing out the rupture caused by differences in scale. Consequently, contemporary science “is no longer a science of facts, but instead a science of *effects*. The technical device of observation causes the *actualisation* of the phenomenon under observation” (Bontems, 2010, 55). It is within this logic that “a decentring from the initial agreement between perception and the things under consideration” (Bontems, 2010, 53) occurs. Could we not see this type of observation as useful to understand the rippling effects of digital technology on

some architectural practices? If so, we could ask ourselves the following questions: What phenomena are these architects attempting to produce with their simulation software? What previously hidden facts does computational power reveal?

It is, of course, impossible to answer these questions in a general sense. We can only provide an answer for a specific case, as we will show below, with Achim Menges' pavilions. For now, the goal is to draw attention to the reconfigurations brought about by the updated knowledge that is being constructed by these digital tools. It would likely be a worthy endeavour to conduct a deeper analysis of how this specific knowledge, as applied to architectural practices, is constructed, as this would make it possible to understand the thought processes used to reach it from the vague knowledge, imprecise concepts, and fluctuating ideas that are used to describe such experimentations². This knowledge, which is 'objectified' by the instruments, emerges both from the potential of technology, which provides adjustments and changes, and from the heterogeneous intuitions of the architect. This complex arrangement *forms* a technological sensibility, step by step.

The Formation of Technological Sensibility

The notion of technological sensibility is, of course, distinct from that of the *scientific mind*, as described by Bachelard. It remains that sense and aesthetic knowledge comes to architects through an apparatus that could be described as phenomenotechnical.

This is why it is worth exploring Bachelard's investigations into the process of formation and of the epistemological obstacle to the formation of the scientific mind. Bachelard describes an opposition between the *formative* instinct and the *conservative* instinct. "There comes a time when the mind's preference is for what confirms its knowledge rather than what contradicts it, for answers rather than questions" (Bachelard, 1938, 17). It is in this sense that Bachelard specifies that even a scientific mind that is experimenting and attempting to gain the most objective perspective on what is being observed, without bias, is still confronted with a series of epistemological obstacles preventing it from 'correctly' seeing what it is observing. What does an architect observe with digital tools?

The architect is not attempting to see reality or observe nature in the same way a scientist might. Indeed, the architect is trying to hatch a complex idea, which may be vague, until he/she reaches a proposed spatial configuration that suits the relevant project. There is no need to insist on the chaotic journey required for the architectural object to take form. Of course, the architect does not have a mental image that he/she simply must put to paper. And yet, current digital tools provide the methods to go about the process in another way - perhaps even to create something else altogether. Before exploring what this *something else* might be, we should specify that the formation of a technological sensibility may involve the architects' reflexive ability to be 'sensitive' to the technological dimension of their experimentations as well as to the shift that these technologies have introduced into their practice. In other words, the architect is made aware of the changes in scale that the instrument brings about in some aspects of the project and of how they are integrated with one another.

This is why technological sensibility cannot be fully assimilated to a rational, scientific

2. I began this work in my dissertation (2014): *Sensibilités technologiques. Expérimentations en architecture numérique 1987-2010*. [Technological Sensibilities. Digital Architectural Experimentation from 1987 to 2010]

mind, instead, it is a deviation of architectural thought brought about by phenomenotechnical instrumentation, which uses simulations to bring fresh knowledge to the project. This fresh knowledge rearranges different parts of the project. Our idea is to argue that it is not the fresh knowledge itself that radically transforms the project, nor the 'objectivation' of data, but its relationship with the traditional intuitive way of designing certain elements of a project.

Gaining a New Perspective on Existing Objects

This is why it is not surprising that in the 1990s, arguments attempting to destabilise several foundational notions of architecture were formulated. An enthusiasm for incidental findings and the role of chance, or an opposition to gravity, or a fascination with the processes that drive emergence, are just a few examples of themes that were explored in these early experimentations. Over the years, it was revealed that many of these themes that were expected to renew architecture were ineffective and disappointing, much in the same way as digitally generated architecture has been. Thus, for many architects, these attempts to formulate new theories were redirected to questions of materiality and construction.

The example of the 'wall' illustrates the various shifts in terminology that followed the adoption of digital technology. At the end of the 1990s, many architects used the concepts of surface and hypersurface to provide a more detailed description of the idea of the wall, although evidence from more recent works shows that these singular characteristics could best be described as a membrane. These shifts highlight the tension generated by the different software solutions used to describe the distinction between indoor and outdoor space. Indeed, while the envelope 'envelops' the inside of a building, or if a wall separates and divides the space between inside and outside, the notion of a membrane puts more emphasis on its chrono-topology, its polarity or its porosity. The term accentuates its dynamic character, as it is undergoing a continual process of stabilisation and organisation. It would be possible to write an entire volume about terminological shifts in the timespan separating early experimentation from recent ones. While exploring the idiomatic productions that followed experimental productions, it is interesting to take an additional step and attempt to not only understand the novelties, but to also retrospectively observe what already existed in light of these experimentations. This idea echoes the argument Bachelard proposed in *The New Scientific Spirit*, that is to say that new theories do not contradict past theories, instead, they give them a new, extended foundation, much as non-Euclidean geometry did for Euclidean geometry. "First constructed in the margins of Euclidean geometry, non-Euclidean geometry sheds a revealing light on the limitations of its predecessor. The same may be said of all the new varieties of scientific thought, which have time and again pointed up gaps in earlier forms of knowledge" (Bachelard, 1934, 8). Would it be possible to understand the new perspective architects have gained on what already exists?

Two Pavilions

The evolution of the projects completed under the guidance of the architect Menges and the engineer Knippers may shed light on some of the issues related to the transformation of practices we have described. It may be helpful to specify here that this team's work is closely tied to scientific thought. Biologists have contributed to several projects, and the team used instruments of measurement with a great deal of precision to analyse the particular morphology of sea urchins, the processes for fiber-reinforced structures of water-spiders, and to predict the self-shaping of wood during the drying process.

For our purposes, it is not relevant to explore the fact that these data have been gleaned from living organisms and that the architects describe their approach as ‘biomimetic’. The main criterion is the disruption of data generation caused by instruments in the process of perceiving the observed phenomenon. As previously stated, what matters most is not that the information is external to the architect, because in this logic, the generated data remain an extension of the architect’s intuition. Indeed, what we aim to highlight in this instance is that the data leads to a redistribution of power balances within a project. In particular, because of the value placed to this data.

We will illustrate our argument with two projects: the *Landesgartenschau Exhibition Hall* (2014) and the *Buga Wood Pavilion* (2019). These two buildings were designed based on the same morphological principle, taking inspiration from the skeletal structure of the sea urchin. Indeed, since it is constructed using plates, it saves a considerable amount of materials. In the few years separating the erection of these two pavilions, the team acquired the know-how to build a higher structure: the first pavilion was 11 m span, and the second 30 m. These gains were primarily achieved by creating lighter plates. In fact, the additional complexity of each plate’s structure was key to creating a more stripped-down, minimalist design for the second pavilion. The uneven surface of the interior of the *Landesgartenschau*’s two domes, with its visible finger joint connections, was supplanted by a smooth, vented surface in the *Buga Pavilion*. The general shape of the pavilions was also softened, shifting from two fused domes to a single central lowered dome with three raised areas, marking the entrances and mimicking the shape of the surrounding dunes. It is somewhat surprising to notice that the work involved during the years separating the construction of these two pavilions was primarily focused on better mastering the technology, freeing up the architects to address traditional architectural considerations, such as site insertion, the ability to integrate a programme using adapted morphology, or be able to integrate basic technical devices, to name a few. This observation is especially striking in the *Urbach Tower* (2019), which displays astonishing sobriety. The technological potentialities are no longer directly visible to the naked eye, are no longer roughly expressed, but are incorporated into the layers of the building.

These examples show that digital technology, far from entirely revolutionising the field of architecture, as was the hope of some architects in the late 90s, has revealed the immutability of some aspects of architectural design. Contemporary architects’ increased focus on the characteristics of some materials and construction processes demonstrate that technology has successfully opened up and built its own scope for intervention that leaves room for their own expression. Most importantly, there is a reconfiguration between the architect’s intuitive knowledge and the knowledge obtained through digital tools. This data no longer merely validates the initial intuitions, but participates in the construction of a new type of expression, which is neither entirely scientific, nor entirely sensitive, but a combination of the both.

References

- Bachelard, Gaston. *The New Scientific Spirit*. Boston: Beacon Press, 1985 [1934].
- Bachelard, Gaston. *The Formation of the Scientific Mind*. Bolton: Clinamen, 2002 [1938].
- Bontems, Vincent. *Bachelard*. Paris: Belles Lettres, 2010.

Architecture and its Double

The Expanded Medium of Architecture and Spatial Affect

Yasmine ABBAS¹

Abstract. The digital has expanded the medium of architecture, bringing with it a focus on architectural surfaces. This paper presents a theoretical discussion centered on spatial affect or how architecture operates as an atmospheric machine. The argument is that architecture's double, atmospheric and meaningful architecture, architecture that affords mental transport across time and space, emerges when instead of focusing on the backdrop to the action or on surfaces, architects consider dimensionality and play with the experiential assemblage of the many material and immaterial elements that constitute space. Engaging in the production of architecture's double is not only necessary for creativity and spatial diversity, but also for enchantment, which can drive attachment to places and help create and sustain a sense of belonging.

Keywords. Spatial Affect, expanded medium, double, surface, kissing architecture

Double Take

What if one role of architecture was to expand the spatial experience beyond its physical boundaries, to serve, using design and technological tricks, as an instrument for people to construct space, as a vehicle for mental transport, for being carried away - physically and emotionally - across time and space?

In "Le Théâtre et son double," Artaud (1938) explored the creation of a dynamic, total, immersive, and intense spectacle, the theater of cruelty, which puts in relation - spatializes and orchestrates - bodies, gestures, sounds, scenic elements, and technology.

Later, in his essay "Architecture and its Double," Bernard Tschumi "introduced new themes and references through the definition of spaces of desire, of performance, of exhibitions, of manifestos, of lust, of sensations, and of borders" (Martin, 1990, 31). Tschumi was committed to playing creatively with the text or medium of architecture to produce its "triadic" constituents, the "conceived, perceived, and experienced spaces," which became "space, movement, and event" (Martin, 1990, 31)². From Artaud and Tschumi, I draw the idea of space and space making as a performance. The arrangement in space and time of the many different elements that contribute to architecture as a performance constitute a spatial assemblage which effect that transcends the sum of its parts.

I posit that architecture's double is the enchanting phenomenon of an all-embracing spatial affect - effect and affect - produced through the playful, complex, and dynamic

1. The Pennsylvania State University, yxa54@psu.edu

2. Chapter 7 of Manfredo Tafuri's *Architecture and Utopia: Design and Capitalist Development* (1976) is titled "Architecture and its Double: Semiology and Formalism."

design of a spatial assemblage of geometrical, material, sensorial, climatic, and allegorical elements. Although architecture's double may be incorporeal, it is nonetheless very real.

Architects summon architecture's double by creatively playing with the many possible combinations of spatial constituents. The enchantment that architecture's double can induce may keep us dynamically engaged with the world or, as neuroscientists say, keep us "doing cognitive work,"³ and bring into being a sense of belonging to a given place.

Surface Tension

How can we reconcile an interest in creating æffects that are spatial (have dimension) when flat surfaces, décors, or screens are deemed sufficient to invite an atmosphere? In his essay, "The Art of the Stage Set as a Paradigm of an Aesthetics of Atmospheres," Gernot Böhme writes that "it is, after all, the purpose of the stage set to provide the atmospheric background to the action, to attune the spectators to the theatrical performance and to provide the actors with a sounding board for what they present" (Böhme, 2017, 30). Mark Wigley connects the idea of creating atmosphere to the very surface of buildings, projecting from the "thinnest layer of paint, texture or wallpaper" (Wigley, 1999, 19). According to Wigley, architecture takes place, operating as a mediating "device," or as an interface between different microclimates, some nested within larger ones (Wigley, 1999, 19). But to create a "poetry in space" or an atmosphere, Artaud preconized having no backdrop, as everything, from gesture, sound, and lighting to architecture and scenic props, participated in combination in communicating the drama of the action (Artaud, 1938). Akin to "the artist as ecologist" as foreseen by Gene Youngblood in the 1970s, architects can "expand our reality" through the "revelation of previously unrecognized relationships between existing phenomena, both physical and metaphysical" (1970, 346). Similarly, architecture is not just a flat backdrop to an event; yet, digital culture has led contemporary architecture to become enamored with surfaces.

The digital has made it easy to fabricate ornate building surfaces (Picon, 2017). Too often cosmetic, skin-deep, and a spectacle, they are designed for today's consumerist-flâneur, and thus contribute to the commodification of the building experience. Ornament has made a return, at least in terms of æsthetics and the status that it affords, but this ornament is looking for expressiveness or to enable a "cognitive dimension" (Picon, 2017, 54). Sometimes, however, building envelopes wear a veil of respectability inasmuch as they summon sustainability values and/or our engagement with place. Think of, for example, the geologically and culturally inspired geometrical patterns of Eliasson's "kaleidoscope,"⁴ the atmospherical device designed as a building envelope for the Harpa Concert Hall in Reykjavík (2005-2011). The facade has dimensions: not only does it have a thickness, but it also affords a mental transport across space. Eliasson translates Icelandic rock formations (a local geological element that contributes to the identity and culture of a place) into a spaceframe composed of a stackable geometry ("quasi-bricks"). In concert with the changing weather, the direction of the sun, and the corresponding (interior) reflection of faceted mirrors on the ceiling, the dichromatic glass adorning the facade structure creates a dynamic effect that calls people's attention. In addition, positioned to embrace the elements, the geometry in

3. Quoted here is neuroscientist and artist Joseph Julian, with whom I regularly exchange thoughts on architecture, art, and the brain.

4. Joseph Grima, 2011, *Eliasson's Kaleidoscope, Domus*. Accessed June 10, 2020.

synchronization with the weather allegorically references local cultural identity and perhaps an ecological consciousness. Some of us may be more attuned to the architectural message that “has more signification for the mind than the clarity brought by the analysis of a speech” (Artaud, 1938, 76-77). The experiential assemblage contributes to a spatial affect, architecture’s enchantment, and possibly our connection to a place.

Surfaces are not solely interfaces between indoor and outdoor microclimates. They don’t just exude atmospheres. Their very materiality, geometry, location in space relative to other surfaces and to environmental vectors (light and sound direction, air flow), and their affordances, as well as the cultural signifier of the ensemble - implicit, rather than explicit - contribute to their dimensionality, i.e., to what deserves emphasis in contemporary architectural practice and discourse.

The Expanded Medium of Architecture

Throughout history, architects have experimented with tactics to concoct architecture’s double. In *The Drama of Space: Spatial Sequences and Compositions in Architecture*, Holger Kleine analyses how the “dramaturgy of spaces” operates (Kleine, 2018). The “dramatic effect of successive surfaces,” “the interplay of floors, walls and ceilings within a single room,” “the formation of rooms,” or “dramaturgical development,” and the “dramaturgical idea” that governs an ensemble of spaces, all speak to the precise and deliberate ways in which architects have endeavored to define our involvement with space. As he argues, “All phenomena that stimulate us to engage with (or disengage with) a space, as well as the parameters that help us understand these phenomena and our reaction to them, pertain to the realm of spatial dramaturgy” (Kleine, 2018, 9). The ensemble of architectural operations that weave the geometrical, material, sensorial, climatic, and allegorical elements together yields the message. What happens when the digital expands the medium of architecture?

Through analyzing the moment video art and architecture “kissed,” Sylvia Lavin came to define a contemporary architecture of effects made of augmented and animated surfaces (Lavin, 2011). These surfaces can be thought of as producing particular ambiances, interior or exterior, but each enveloped atmosphere is independent of all others (Lavin 2011). Thus, architects are freed from creating the coherent “dramaturgical idea” that Kleine was exploring (Kleine, 2018). Kissing allows architecture to become “superarchitecture” (Lavin, 2011) and has inspired architects to treat the surface as an element that can have “mood swings” (Lavin, 2011, 83).

As an example of kisses, *Perspective Lyrique*, the interactive “device” designed in 2010 by 1024 Architecture, provided an opportunity to distort through voice a very ornate 19th-century French facade⁵. Participants in the interactive event were asked to blow sound into a microphone (thereby almost kissing it) to command the relative distortion of a digital image projected onto the static Théâtre des Célestins (Lyon, France), with video mapping enabling a close fit to the building’s many architectural protrusions and ribs. Sometimes, the animated facade, which could only be seen at night, morphed into a large face or a theater mask, with a mouth that opened as if it wanted to devour the public or invite people into a virtual world beyond the facade. There are many ways in which the immaterial medium of the projection kisses the material medium of architecture, but how can architecture be designed so that its surfaces, instead of serving merely as a prop for projections, contribute to meaning-

5. 1024 Architecture. Accessed June 9, 2020: <https://www.1024architecture.net/projects/>

ful spatial assemblages?

Through the Looking Glass

Designed by Ateliers Jean Nouvel, the courthouse in Nantes, France (1993-2000) exemplifies the idea that architects use “diversionary strategies” to create “seductive” and immersive spaces, “virtual spaces of illusion” (Baudrillard and Nouvel, 2002, 6). On one hand, the “just”⁶ and precise geometry of the building is based on a square grid that expands or compresses in a fractal way, defining its total organization, from the structure layout to the floor, ceiling, and wall patterns, from the square apertures to the square paving. The rigorous arrangement is designed to translate and symbolize the ideal concept of justice, structured, impartial, and universal (which, it should be noted, has a variable geometry depending on who decides the laws at play). On the other hand, the color and materiality of the building surface, black and, in some instances, polished and reflective, transcend the idea of the screen and give a virtual double to the physical space, expanding it beyond walls and in multiple dimensions. People experience the spatial æffect as they move through space.

In the same lineage, *Longing*, the atmospherical machine by Jennifer Newsom and Tom Carruthers of Dream the Combine, creates an infinite projection space by placing a mirror at either end of an urban structure such that they face each other. These mirrors were also designed to move in order to create an enchanting effect of spatial distortion or elongation⁷. Much like for the “theater of effect” of Mies’s building in Berlin described by Stan Allen, the location and materiality of surfaces as well as their controlled movement (as in the case of *Longing*) contributes to “complex optical and experiential effects that can never be simulated or predicted by drawings” (Allen, 2009, 99).

Computing the Im/material

The increasing simulation and computational capabilities of architectural software facilitate the design of spatial æffect. Architects can choose from many outputs the preferred and/or optimized solution for the effect they seek. These options result from the assemblage, in space, of surfaces that have, each, a particular geometry and certain material properties and that respond to the direction, movement, and quality of immaterial parameters such as light, sound, air flow, or temperature. For example, Greg Lynn’s Sociópolis housing block in Valencia, Spain (2002-2010), is “clad in six different anodized aluminum panel finishes, each of a slightly different color and degree of brilliance, and each set at a different crystalline angle” writes Lavin (2011, 105). The facade “appears to break and reflect light into a range of sparkly grays, like a disco ball under a pulsating strobe” (Lavin, 2011, 102), thus animating other surfaces in the urban space, and creating an urban spectacle. Materials have both properties and “atmospheric potentiality,” meaning that a material in and of itself or in conjunction with other materials evokes the prior perceptions of that said material (Griffero, 2010, 97). Also, unintended double effects result from their assemblage with immaterial elements. Consider in the example of the Sociópolis housing block, the role that the reflective facade may play in the temperature of the immediate urban microclimate. Kissing architecture, a concept introduced by Lavin, calls for an investigation of “material phenomena” (Mori, 2002), but these expand beyond visual perception. Iannis Xenakis was, for example, interested in the “three-fold link [that] exists

6. Ateliers Jean Nouvel’s website. Accessed June 15, 2020:

<http://www.jeannouvel.com/en/projects/palais-de-justice/>

7. *Longing* by Dream the Combine. Accessed June 15, 2020: <http://www.dreamthecombine.com/longing>

between audience - [sonic] source -architecture” (Kanach, 2008, 155). He stressed the variable typologies that could emerge from, for example, the spatio-temporal relationship combined with the nature of the sound and the materiality of surfaces, thus opening a Pandora’s box of sound and sensory computational explorations in architecture. As a final example, Dana Cupkova and Nicholas Azel’s “mass regime” research into the relation between mass, geometry, and the material capacity to store and release heat included the construction of a wall strategically located in the Hsu House (2010), which played a role in controlling thermal flow, thereby improving energy efficiency within the home.

Spatial Affect

Finally, what is the project? Why would spatial affect matter? First, it relates to creativity: Even though architects cannot be expected to foresee (forefeel) all the double effects that could arise from any given experiential assemblage, it remains critical for them to play with the endless possibilities of spatial affects. Such play, experimentation, is also the means for diversifying the typologies of affective space and for avoiding reducing them to a collection of hyper-controlled environments or eternal springs. Second, spatial affect matters in relation to belonging: Like “Inter-media environments,” architecture’s doubles “create ‘a matrix for psychic exploration, perceptual, sensorial, and intellectual awareness’” (Youngblood, 2020, 348). It is, therefore, important to explore the spatial affects of assemblages that can afford enchantment. As political theorist Jane Bennett writes in the *Enchantment of Modern Life: Attachments, Crossings, and Ethics*, “this life provokes moments of joy, and [...] joy can propel ethic” (Bennett, 2016, 4). Likewise, enchantment can drive our attachment to places and, at the time of the neo-nomad, a much-needed sense of belonging. However, a lot remains to do, if the enchantment of architecture’s double is to move beyond catering to the wealthy to also pervade everyday life and so reach everyone with a need to belong.

References

- Artaud, Antonin. *Le Théâtre et son double*. Paris: Gallimard, 1938.
- Baudrillard, Jean, and Jean Nouvel. *The Singular Objects of Architecture*. Minneapolis, MN: University of Minnesota Press, 2002.
- Bennett, Jane. *The Enchantment of Modern Life: Attachments, Crossings, and Ethics*. Princeton & Oxford: Princeton University Press, 2016.
- Böhme, Gernot. *The Aesthetics of Atmospheres*. London: Routledge, 2017.
- Cupkova, Dana and Nicolas Azel. “Mass Regimes: Geometric Actuation of Thermal behaviors,” *International Journal of Architectural Computing*, issue 2, volume 13, (2015), 169-193.
- Griffero, Tonino. *Atmospheres: Aesthetics of Emotional Spaces*. Burlington: Ashgate Publishing, 2014.
- Kleine, Holger. *The Drama of Space: Spatial Sequences and Compositions in Architecture*. Basel: Birkhäuser, 2018.
- Kanach, Sharon E. *Music and Architecture by Iannis Xenakis: Architectural Projects, Texts, and Realizations*. Vol. 1. Hillsdale, NY: Pendragon Press, 2008.
- Lavin, Sylvia. *Kissing Architecture*. Princeton & Oxford: Princeton University Press, 2011.

Mori, Toshiko (ed). *Immaterial, Ultramaterial: Architecture, Design and Materials*. Cambridge, MA: Harvard Design School in association with George Braziller, 2002.

Martin, Louis. "Transpositions: On the Intellectual Origins of Tschumi's Architectural Theory," *Assemblage* 11 (1990), 22-35. Cambridge: The MIT Press.

Picon, Antoine. *Ornament: The Politics of Architecture and Subjectivity*. 1st ed. Chichester, West Sussex, UK: Wiley, 2014.

Youngblood, Gene. *Expanded Cinema, Fiftieth Anniversary Edition*. USA: Fordham University Press, 2020.

Atmospheric Gestures of Architecture in Cinematic Aided Design Framework

Abstract. Atmosphere and ambient properties can be hidden dimensions of architectural space. How can students design with atmosphere in mind? Unlike artists, architects often do not considering multisensory modalities as resourceful possibilities for creativity. In a Cinematic Aided Design framework, we can tap into the potentials of these hidden dimensions in architectural or urban scale. How does the affective atmosphere translate to knowledge for design? A synthesis generated through experimental moving image techniques can be used as source materials for a cinematic architecture that can be influential forces in different stages of design process. This paper suggests atmosphere as a concept is instrumental for decoding architectural gestures and generating meaningful associations.

Amir SOLTANI¹

Keywords. Atmosphere, Gesture, Architecture, Cinematic

Potential Spaces From Atmosphere to Gesture

“Architecture is experienced primarily through the atmospheres it generates” (Janson and Tigges, 2014, 26).

Atmosphere is unseen yet illusively perceptible², a hidden dimension as well as gestural force, it is felt by body and revealed through everyday multisensory experiences of spaces that leaves impressions from body’s initial encounter. For a designer these impressions function with atmospheric potentials, but require decoding of invisible moods into gestures, which helps define the functions of ambient dimensions; in a way gesture works like an inner-eye for ‘ways of seeing’ atmosphere. The aim here is to investigate how perception of atmosphere can be part of heuristic process in design. The word ‘atmosphere’ is already in danger of being clichéd; according to Gernot Böhme, it has been applied to humans, to spaces, and to nature (2017, 13). There has been also a surge in its use in architectural literature, as in environmental ambient, the mood of a place. The main curiosity for atmosphere in the context of built form is through engaging in multisensory design strategies that embodies experiences of architectural elements, as suggested among others by Pallasmaa and Zumthor’s holistic approach to beautiful architecture through harmony, hapticity, attentiveness, and attunement to all aspect of the environment (Pallasmaa, 2000, 2008). Spatial configurations can produce meaningful atmosphere expressions and film can help decode these ambiances and translate them to complement architectural geometric spaces.

1. Cambridge University, Department of Architecture, UK, www.expressivespace.org, amir@metrowave.uk

2. “One can only determine the character of an atmosphere by exposing oneself to it” (Böhme, 2001, 41, 52).

“In our disposition, we sense where we are. Sensing our own presence is simultaneously to sense the space in which we are present. Where we are (where we find ourselves) can still be interpreted topologically, as a positioning in space. And indeed, in sensing our bodily presence, both the distances to things (or, better put, their oppressive closeness or their receding expanse) and the geometry of space come into play” (Böhme, 2017, 49).

When interacting with everyday objects we are presented with their particular ‘means’ and gestures; in a multisensory experience spatial boundaries are felt as gestures that are ambient descriptors. Therefore, while sensing objects, the surroundings and our ‘disposition’ or one’s ‘bodily presence’ contribute to the atmospheric perception that signify that space as a particular place. Janson and Tigges describe common spatial atmospheres to “form a peculiar relationship between object and subject” (2014). “Since atmospheres depend on total situations, they cannot be entirely controlled by architectural means, but can nonetheless be substantially influenced by them” (2014, 28). Likewise, Agamben considers gesture to be “pure means” (2000, 59) or “means with no ends.” The concept of atmosphere is mutually endless in form. “An atmosphere is the expressive force through which a situation that has been engendered by architecture seizes us in affective terms all at once and as a totality” (Janson and Tigges, 2014, 26).

Architectonic Gestures

“How is atmosphere constructed? Atmosphere seems to start precisely where the construction stops. It surrounds a building, clinging to the material object. Indeed, it seems to emanate from the object” (Wigley, 1998).

F.L. Wright’s drawings often blended the sky with the architecture through series of horizontal lines echoing the gesture of building lines. “The air becomes an architectural element. Often this architectonic sky is framed off with a line as heavy as the one that defines the intersection of the building and the ground. The air becomes a suspended plane like those that define Wright’s architecture. This plane is not simply a backdrop that pushes the features of the project forward. It is an integral part of the building” (Wigley, 1998, 20). As Agamben suggest “the gesture is the exhibition of a mediality: it is the process of making a means visible as such” (2000, 57), thus, a suitable device in making atmosphere perceptible.

Architectural design starts as a set of desires, that at the very early stages it resembles a gesture of possible characteristics of space and form, ideology and requirements. In that sense “the architect begins with the gesture of space - a piece of folded paper” (Eckler, 2012, 222). Therefore, gesture is a “simple motion or position used to express an idea” starting with a compositional strategy leading to programmatic complexity (2012, 223); frequently, design processes start with some simplified form of gesture that signifies the design intent, or configuration of desired space. “Ultimately, the gesture is a basic framework for design that evolves through iteration; through process, the gesture can be incrementally translated into architecture.” Gesture is also a “signifier of the process” of design “that allows the gesture to be a tool of analysis” (Eckler, 2012). Constructing with atmospheric tones is like working with gestural layers of space; as Mark Wigley states “atmosphere might even be the central objective of the architect. In the end, it is the climate of ephemeral effects that envelops the inhabitant, not the building” (1998, 18).

“Architecture is a gesture. Not every purposive movement of the human body is a gesture. And no more is every building designed for a purpose architecture” (Wittgenstein, 1980, 49e).

Wittgenstein stated, “architecture is a gesture,” referring to architecture as a potentially expressive space as opposed to just a building with no expression. He designed a one-off architectural project³, a house for his sister that expressed his spatial logic as metaphoric gesture connected space to the abstraction of language and meanings. Wittgenstein’s feelings and emotive values, simplicity and perfection of his spatial order, which he literally sculpted to his own personality with a serious attitude towards its design (Wijdeveld, 1999, 159-183). His expressive architectural style had similar connections with Loos’s style (Wijdeveld, 1999). Wittgenstein described architecture as the one that provokes a gesture, provoking a privileged sense of meanings; in the same way, gesture is not just a plain movement rather it becomes a meaningful expression for architecture appearance. Wittgenstein used linguistic logic to depict the difference between architecture and a building, which is architecture, brings a gesture (or signification). Through Wittgenstein lens, we can frame it this way: genuine architecture is continually morphous, as opposed to a typical building, which its shapes are generic hence, amorphous.

“The form of the house is not amorphous, not a free for all form. On the contrary, its construction has strict boundaries according to the scale of your living. Inherent life processes determine its shape and form” (F. Kiesler, from *Elastic Architecture*, Philips, S. 2017, 287).

According to Andrew Ballantyne the type of buildings that are understood as gesture are the kinds of architecture that has been “resolved in persistence, determination” (2002, 8). These architectures are noteworthy and noble, not just to do with their shapes, size or form, rather the types of buildings that would be Wittgenstein’s “philosophic architecture as gesture” (2002, 10). “Remember the impression made by good architecture, that it expresses a thought. One would like to respond to it with a gesture” (Wittgenstein, 1980, 26e).

Sensing Atmosphere in Architecture

“We sense what kind of a space surrounds us. We sense its atmosphere. This has consequences for the perception of architecture: if it is true that architecture creates spaces, then to evaluate them, one must go inside these spaces. One has to be bodily present” (Böhme, 2017, 49).

Frederick Kiesler’s designs “exploded the limits of traditional architecture” by using the impression of “flexible space” as his storefront projects that extend their limits beyond the interior surface “while his cinema and theatre projects sought to expand the entire interior atmosphere” (Phillips, 2017). Kiesler’s iconic image of him ceaselessly working with his model of Endless House “becoming ever more ‘elastic’, ‘porous’, and ‘atmospheric’, seems only to further employ tactics of display, advertising, and

3. In 1925, Margaret Stonborough-Wittgenstein commissioned Austrian architect Paul Engelmann and her brother Ludwig to design a large house on Kundmanngasse in Vienna. See Wijdeveld, P. 1999.

mass media that manipulate the habits of everyday life, until we become increasingly comfortable assuming our position before the cinema screen” (Phillips, 2017). Kiesler’s avant-garde designs for theatre stage, and cinema created atmospheric spaces to go beyond art and architectural limits. Kiesler produced an array of stimulating works that are pedagogically relevant to today’s dynamic design disciplines, ranging from “time-motion studies and early experimental animated films to his vast study of the scientific, philosophic, and even pseudo-psychoanalytic debates surrounding contracting and expanding perceptions of continuous forms and enfolding spaces” (2017, 11). Kiesler’s particularly poignant architectural is his final gesture and only built project in collaboration with Armand Phillip Bartos, Shrine of the Book, in Jerusalem, a predominantly haptic and atmospheric structure, “The shrine itself is built as a white dome, surrounded by a reflecting pool. The structure it contains is placed two-thirds below ground, and is entered through a long dark passageway imitating the environment in which the scrolls were found.”

Contemporary architect Peter Zumthor is another advocate of atmospheric spaces; by endorsing Turner’s expression to John Ruskin, “atmosphere is my style,” he hints to shapeless and immaterial means of atmosphere as his own style in design (Zumthor, 2006, title page). Zumthor through a series of reflections, using images and film defines how he benefits from atmospheric nuances of a scene or situation by embracing all of its sensory intensities. For students of architectural design it may be daunting to try applying Zumthor or Pallasmaa’s haptic and multisensory visions. This study model would include experimental design inspired by multisensory experiences, observing the limits and the processes of everyday life affects, using moving image in a cinematic aided design framework that can help decipher the space of atmosphere from film.

Cinematic Gestures as Atmosphere

Can atmospheric consciousness and gestures become further tangible through the medium of film? Agamben declares, “gesture rather than image is the cinematic element” (1993, 138). In film, the city is always portrayed with its atmospheric gestures, through post-processing of colour, light, sound, but most effectively through weather. As an example, *Twelve Angry Men* (1957) directed by Sidney Lumet, has memorable atmospheric elements in its scenes that expresses the disposition, mood, and in particular temperature of its place; ultimately indicating feeling of exertion, discomfort, struggle, and other climatic gestural forces. According to Böhme, “the atmosphere of a city is always also determined by regional climate and the seasonal patterns characteristic of an area” (2017, 79); for instance, as Böhme states, old European cities with coloured roof schemes, give distinct atmosphere for each city. Colour effectively controls atmosphere by being both visible and having gestural affects. Extreme colours in *Apocalypse Now* (1979) by Francis Ford Coppola, contributed to the emotive effects of exceptionally dystopian atmosphere as well as the film noir elements such as fan shadow, sweat, haze and fog, which expanded the film’s gesture of conflict. The colours in particular created a warfare atmosphere of an unexpected place. Every film in existence has an atmospheric feature to interpret, and as François Penz points out, “films constitute the most comprehensive lived-in building data in existence - a largely ignored and untapped resource that can be mined in many different ways” (2018, 4).

For increasing design imagination, “film provides us with a formidable array of interpretive human situations, and that it exposes hidden strata of everyday life that would otherwise be inaccessible to us. Film helps us to attain something like fragments or

moments of atmospheres, pertaining to everyday life situations” (2018, 7). The ‘lived space’ approach in decoding cinematic language is a ‘complex model’ but one that in the context of architecture, “opens potential new avenues yet to be investigated, and one that pertains to the world of cinematic-assisted imagination.” Therefore, film is to interpret from cinematic situation the architectural atmosphere. “Cinematic Aided Design, being a play of words on Computer Aided Design (CAD), implies that we need this injection of cinematic intelligence to enrich the design process” (2018, 7). Another advantage of cinematic model is the inclusion of ‘human dimension’, that are lacking in today’s conventional design software, as well as a required dimension in understanding atmosphere.

Cinematic Aided Design in Research

“To build houses like Kaurismäki makes films - that’s what I would like to do” (Zumthor, P. 1998, 48).

How can students study concept of ambiance and atmospheric effects in a spatial design framework? Can atmosphere be tangible as a repeatable effect, albeit invisible? Utilizing words, ‘linguistic’ and explore ‘gestures’ of architecture. There are other sensory modalities that should also be considered. In the phenomenological sense, experiencing architecture is to find other values besides pure visual style, and pure formal consideration. Architectural theoretician Alberto Pérez Gómez says that the true meaning and translation of the experience of architecture means it is “always mediated linguistically” (Pérez-Gómez A. et al., 2006, 8); yet, architecture is not something that after it is created is translated into words, rather architecture exists as space and has formal presence that necessitate embodied experience. In a research settings, moving image discipline as linguistics can aid in decoding layers of atmospheric meaning (to reverse engineer atmosphere for use in design), that is capable of generating atmosphere, even without presence.

The two cinematic research examples mentioned here, funded by AHRC, at the University of Cambridge, Department of Architecture, explore urban and architectural elements in terms of everyday life and cinematic spaces. The studies employ cinematic means to explore archives of lived space scenarios that each tells about the atmosphere among other gestures of our daily spatial practices. *Cinematic Geographies of Battersea* (2012-2014) is an “urban interface and site-specific spatial knowledge” project on community of Battersea, by studying how this area is portrayed in films in the 20th century⁴. The results of the study is combined in an interactive interface called *the Ghost Cinema*, which through location-based GPS app plays a film excerpt from the original historic film made in that area, creating an immersive multi-sensory experience between the user’s body and the place, and blending the atmosphere of Battersea-based film with reality. François Penz also directed project *CineMuseSpace* (2017-2020), building on André Malraux’s idea of the *Musée Imaginaire* (Museum without Walls)⁵. The research aimed to generate an understanding of different cultures and societies in the usage of architecture and space of everyday home. The “architectural records folded away in the film medium” is like a directory for “idiomatic local development of culturally rooted architectural design” as well as helped identifying ambient gestures of everyday life.

4. See at: <https://cinematicbattersea.blogspot.com/>

5. See at: <https://www.cinemusespace.arct.cam.ac.uk/>

In summary, “Gesture, be it bodily, linguistic or musical is meaningful communication” (Albertsen 2000, 91). In design process, generating expressive atmosphere involves a haptic body attuned to objects, places, actions and movements. Cinematic and architectural atmosphere share gestures of being “between possibility and reality,” and “intermediary between force and action” (2000, 95). Since gesture has no end to its means, there are endless potentials for deciphering impressions of atmospheres through gesture using film.

References

- Agamben, Giorgio. *Means without End: Notes on Politics*. Minneapolis: University of Minnesota Press, 2000.
- Agamben, Giorgio. “Notes on Gesture.” In *Infancy and History: The Destruction of Experience*, NY: Verso, 1993.
- Albertsen, Niels. “The Artwork in the Semiosphere of Gestures: Wittgenstein, Gesture and Secondary Meaning.” In *Architecture Language Critique*, edited by Bakacsy, j., et al., 65-104. Amsterdam: Rodopi B. V, 2000.
- Böhme, Gernot. *Atmospheric Architectures: The Aesthetics of Felt Spaces*. Germany: Bloomsbury Publishing, 2017.
- Borch, Christian. “Introduction: Why Atmospheres?” In *Architectural Atmospheres: On the Experience and Politics of Architecture* edited by Christian Borch, 6-16. Germany: Birkhäuser Verlag, 2014.
- Eckler, James. *Language of Space and Form: generative terms for architecture*. London: Wiley, 2012.
- Janson, A. and Tigges, F. *Fundamental concepts of architecture: the vocabulary of spatial situations*. Basel/Berlin/Boston: Birkhäuser Verlag 2014.
- Pallasmaa, Juhani. “The Sixth Sense: The Meaning of Atmosphere and Mood.” *AD*, 126-133. NY: John Wiley & Sons Ltd. 2016.
- Pallasmaa, Juhani. *The eyes of the skin: architecture and the senses*. London: Wiley-Academy, 2007.
- Penz, François. *Cinematic Aided Design: An Everyday Life Approach to Architecture*. UK: Routledge, Taylor & Francis, 2018.
- Phillips, Stephen J. *Elastic Architecture: Frederick Kiesler and Design Research in the First Age of Robotic Culture*. NY: MIT Press, 2017.
- Wigley, Mark. “Architecture of Atmosphere.” *Daidalos* 68, 18-27. Germany: Berlin Architectural Journal. 1998.
- Wijdeveld, P. *Ludwig Wittgenstein: Architect. (Design Book)* Amsterdam: Pepin Press, 1994, 1999.
- Wittgenstein, Ludwig. *Culture and Value*. Chicago: University of Chicago Press, 1980.
- Zumthor, Peter. *Atmospheres: Architectural Environments - Surrounding Objects*. Berlin: Birkhäuser GmbH, 2006.

Ornamental Atmosphere & Digital De-lights

The Reactivation of Light Ornaments Through Digital Design

Amal Abu DAYA¹,
Noha Gamal SAID²

Abstract. “Ornamental Atmosphere & Digital De-lights” focuses on the reactivation of traditional and cultural craftsmanship of ornamentation using contemporary digital modeling and manufacturing tools. Conducted in the framework of a Franco-Egyptian collaboration between Ain Shams University - Egypt and the Grenoble School of Architecture - France, this communication proposes to describe the experiential methodology of an intensive workshop that took place in ENSA Grenoble in September 2019. The aim is to parametrically design and digitally fabricate prototypes of architectural envelopes whose patterns and light effects are a reinterpretation of traditional Egyptian architecture and its light atmospheres, while introducing variants to adapt the design to different situations and usages.

Keywords. Ornamental Atmosphere, Egyptian Light Heritage, Digital Design, Prototypes

Ornamental Atmospheres and Digital De-light

The theoretical context on which this paper is based is that of the envelope (skin, membrane) and digital contemporary ornamentation as evolving architectural elements. Linked to the traditional moucharabiehs (ornamental wooden carved window), and the jalis (carved stone screen), the status of ornament was subject to a major change during the 20th century. As for envelopes, their status changes in the 21st century, as they become skins and membranes. As Manuel Gausa said so well, “Contemporary architecture replaces the idea of façade with that of skin: an exterior layer mediating between the building and its environment. Not a neutral elevation, but rather an active, informed membrane; communicative and in communication [...] an authentic interface between individual and environment; and the façade, into an (inter) active screen, the frictional boundary between the building and a context which changes overtime” (Gausa et al., 2003). Today, performative membranes must deal with issues linked to: perception, to the environment, structure and usage.

The question is how may we use the contemporary parametric modeling and fabrication tools (robotics, CNC machines) available today in order to revive, reactivate and reinterpret traditional architectural forms (that were usually made by hand) so as to create singular atmospheres and usages that are linked to them.

1. Lecturer at ENSA Grenoble, Researcher at the CRESSON laboratory - UMR AAU, Member of the Digital RDL Chair, abudaya.a@grenoble.archi.fr

2. Associate Professor, Department of Urban Design and Planning, Faculty of Engineering - Ain Shams University - Cairo // Associate Researcher at the CRESSON laboratory - UMR - AAU- ENSA Grenoble said.n@grenoble.archi.fr

The Status of Ornament Over the Years

From a historical perspective, Adolf Loos in his 1929 essay ‘Ornament and Crime’ classifies ornament as superfluous and criminal stating that “Ornament is no longer an expression of our culture” (Loos et al., 2015). In the era of the 2nd industrial revolution, modernist notions of ornament were more specifically derived from the manufacturing processes as we can witness in Le Corbusier’s work at l’Unité d’Habitation de Marseille, 1952, or by the sensory richness of materials used, like in Mies van der Rohe’s Barcelona pavilion (1929). As Antoine Picon reminds us, “the differences between today’s ornament and the design that prevailed in the Vitruvian tradition is that in Renaissance architecture and Baroque architecture, the ornament was usually concentrated at certain key points” (2013).

The 19th century English theorist John Ruskin, specified that one of the main roles of ornament is to keep in mind the productive hand of the construction worker and the technique used in building. With the advent of digital modelling and fabrication tools, ornament in contemporary architecture has taken a new turn: a more ubiquitous nature, adaptive to users and the environment, less repetitive and non-standard, but is still linked to the manufacturing process as in modernist times. Today the tool, the tool path and the implementation method used in digital fabrication is part of the expressive, symbolic and ornamental dimension, inheriting (and redirecting) modernist notions of ornament resulting from manufacturing processes.

New Technical Sensibilities and Expressive Techniques

It is worth mentioning that technology is here at the service of culture, in a prospective logic, (inciting design innovation) and a resilient posture, (prolonging symbols inherited from the past) rather than in a disruptive attitude. “Architecture needs mechanisms that allow it to become connected to culture”(Moussavi, 2006). The digital surface becomes a medium of cultural expression linking past and present. This ornamentation reflects the convergence of the technical, the cultural, and the experiential. “The digital surface is not just the technical expression of the production tool, and the tool path, it is also the cultural expression as a tool for restoring traditions of craftwork” (Pell and Hild, 2010).

Fundamental to this technological and material experimentation achieved by varying different parameters like depth, porosity, density and testing different materials and matter organizations, new material and phenomenological effects are created. It is important to note that these material effects are not only visual effects, but experiential ones that can be lived at a body-wide experience. “Why the emphasis on the body? The renewed topicality of corporeality in architecture is a renaissance, revisiting a development that commenced at the end of the 19th century. Heinrich Wölfflin established, for example, that the spatial shape of architecture was not merely a matter of what you see, but is rather experienced in and by the body. Architecture was no longer characterized by its load-bearing properties, its works were judged in terms of the movement of experiencing them” (Böhme, 2013).

Mass Customization or a Bespoke Approach

By the early 1990s, digital design emerged as fresh territory for architectural innovation. Computer Numeric Controlled (CNC) fabrication technologies in the late 1990s further enabled the realization of complex digital work. In the 1990s, the architect Bernard Cache explored the decorative field of pattern, texture and relief. He defended a vision of design in which the user, until then simply free to choose pre-existing elements, can intervene in the manufacturing choices.

The modification of design parameters, allows the manufacture of unique objects in the same series, thus making mass customization, or a bespoke approach possible. In his book *Le Pli*, published in 1988, Gilles Deleuze introduced the term *objectile* to designate the ability of differential and integral calculus to generate an infinite number of objects in a continuous series. Bernard Cache proposed the concept of “non-standard architecture” in his book *Terre Meuble* in 1995, to designate both the form of the works and the prefabricated, non-repetitive and often complex parts that digital architecture allows to realize.

Building Atmosphere: an Embodied and an Empathetic Experience

The differentiated serial production made possible by the expansion of digital design and fabrication technologies has generated an exploratory profusion of pattern-making. Digital patterns are no longer repeated identically, they are dynamic, non-standard and adaptive to the environment, to different usages, and to situations creating changing light effects and visual relationships with the context. The continuum Design - Fabrication - Experience process that digital tools make possible is conducive to creativity and innovation. This feedback loop between design and production creates an iterative process introducing variations in the initial design pattern that can be tested by the users and the designer, thus creating new forms of experience and building new atmospheres. According to the architect Pallasmaa, “atmosphere is immediately experienced as a unity, in which all senses are simultaneously at work. The experience of atmospheric quality in architecture, then, is by definition an embodied experience. However, since architecture is subject to use, atmosphere is by no means a merely individual task. [...] it is crucial for architects to empathize with users, clients and other perceivers of architecture. He thus considered, next to embodiment, compassion as a necessary skill for architects to be able to build atmosphere” (Havik, Teerds and Tielens, 2013).

Reactivating Light Ornaments in Traditional Egyptian Architecture

Antoine Picon states that “pattern that used to play a relatively minor role in the Western ornamental tradition, contrary to the Islamic one, now appears as one of the most common forms taken by ornament in contemporary project” (2013).

On this basis, we proposed an intensive summer school on Ornamental Atmospheres and Digital De-light that aimed to revive and reactivate the know-how of craftsmanship, both cultural and ancestral, of traditional Egyptian ornamentation by means of architectural robotics and digital design.

This one-week workshop was conducted in the framework of a Franco-Egyptian scientific collaboration between Ain Shams University in Cairo and Grenoble School of Architecture - France. This partnership mobilizes the cross expertise between the Digital RDL Research by Design Lab Chair (Label of the French Ministry of Culture), the Cresson laboratory (UMR CNRS AAU), the Grands Ateliers de l'Isle d'Abeau (GAIA), the Ecole Nationale Supérieure d'Architecture de Grenoble in addition to those of the Department of Architecture and Urban Design - Faculty of Engineering - Ain Shams University. This workshop took place in September 2019 in Digital RDL Research by Design Lab at the Grenoble School of Architecture. It permitted twenty Egyptian architecture students to work together with French architecture students from the RDL Master program: *Architecture, Ambiances et Cultures Numériques*.

Methodology

The workshop is based on an experiential learning methodology of architectural

atmospheres that have been developed for several years at Digital RDL at the Ensa Grenoble. The principle is to develop a protocol which combines: an in-situ experience, abstraction by digital redrawing, the integration of non-standard architecture parametric design methods in a mass customization logic to develop an “ergonomic” design adjusted to the user, control of the design-manufacturing continuum to develop a serial production of artifacts to be tested before proposing a finalized version of a prototype to be manufactured, and finally the real or scenographic setting to take “inhabited” photos by the students of their project.

The start of the workshop consisted in choosing in Cairo, references of traditional architecture, (such as moucharabiehs, claustra or zenithal lightning of engraved or sculpted patterns) from the Islamic, Coptic, Nubian or Pharaonic cultural heritage, to be photographed. We therefore realized, with 7 groups of students 4 reference fields that Noha categorized with Egyptian students into a set of emblematic prototypes of a reactivation of traditional ornamentation using contemporary modeling and manufacturing tools available in Digital RDL and in the GAIA. One of the qualities of this workshop is the collaborative work between the students of each of our universities for the drawing, the production, the staging in LEICA (an immersive space of architectural design) and the final presentation. Finally, as part of the “Resilience” exhibition for which Amal was the curator, she chose to show and make visitors experience the passage from the representation in mock-up to the sensitive space of the experience. Each project is presented according to this tensioning of the small scale and the scale of the moving body.



Figure 1. Fabrication with Robotic arm in RDL - ENSAG (to the left); Photos of the fabricated panels in “Resilience” exhibition

Parametric Light Effects

This process has allowed new effects and forms of light to emerge: filtered, diffused and scattered light (Fig.2).

Lacework - Filtered Light

The original motif is found in a wooden door located in a Coptic religious complex called the “Hanging Church” in Cairo. The lacework as a light effect defines a form of filtered light resulting from the complex geometric form of the ornament composed of numerous tiny voids. The usage of parametric tools has enabled to vary the degree of light porosity by differentiating the density of the apertures throughout the membrane, creating therefore a light gradient.

Dynamic Light - The Overlap

Here, kinetic light is created by playing with the depth of the façade. Students designed a double-skin membrane with two variant scales in which one or both layers slide and may be adjusted according to the desire of the space users and the quantity of light needed. Two projects tackled the overlap concept. In the first, the motif is inspired from a moucharabieh located in the Qälwäoun complex, a building representing Mamluk Architecture in Fatimid Cairo. The superposition of the two layers creates a new form of light. Used as window panels, this device provides both intimacy and dynamism in the visual experience. The second project is a fusion of two pharaonic drawings: the lotus and the Horus' eye. Here, the motif is applied identically on two wall panels that are overlapped.

Scattered Light

The scattered light is defined as streaks of light that are found at intervals or on various locations rather than all together. It is a small quantity or amount of light sprinkled over an object or a surface. This form of light appears in a pattern initiated from the Nubian motif, in which students chose the triangle form. Parametric tools have enabled an irregular change in the size of the triangle, which creates large and small spots of light that penetrate the shaded zones.

Diffused Light

The diffused light defines a zone of light with a homogenous distribution. Diffused light is a soft light with neither the intensity nor the glare of direct light. It is scattered and comes from all directions. Thus, it seems to wrap around objects. This effect results from two forms of motifs, originating from a moucharabieh located in different mosques: one in the Hanging Church above the gatehouse of the Babylon Fortress, while the other is found in the Hussein mosque in Fatimid Cairo, Egypt.

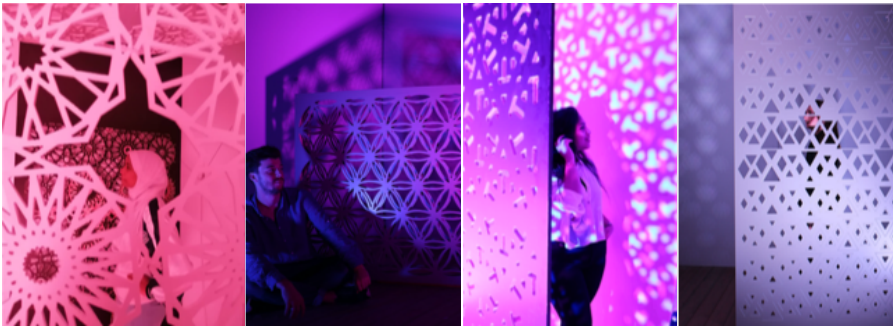

Figure 2. Panels: Lacework, Overlap, Scattered light, Diffused light

Conclusion

The parametric redrawing of the existing geometric patterns enabled the regeneration of authentic geometric forms composing the architectural light elements through varying different parameters: depth, overlap, porosity and density. This process has allowed new effects and forms of light to emerge: filtered, diffused, and scattered light.

Digital design and robotic fabrication have played an important role in dealing with light as a design material for creating ambiances. The variation in densities and scales

of the geometric pattern provided a dynamic and adaptive non-standard pattern. The emerging pattern can respond to different environmental conditions and usages, offering therefore multiple atmospheres and various experiences.

The continuum “Design - Fabrication - Experience,” which singles out the experiential pedagogy offered by Digital RDL, has made it possible to develop a reflexive attitude in students’ thinking and has allowed them to explore the aesthetic qualities, as well as the ambiance and perception qualities of these contemporary envelopes.

This integration of non-standard architecture parametric design methods in a mass customization logic aims to develop an “ergonomic” design adjusted to the user, with a bespoke approach.

References

Gausa, M., Cros, S., & Metápolis (Eds.). *The Metapolis dictionary of advanced architecture: City, technology and society in the information age*. ACTAR, 2003.

Loos, A., Cornille, S., & Ivernel, P. *Ornement et crime: Et autres textes*. Payot & Rivages, 2015.

Moussavi, F., Kubo, M., & Hoffman, J. S. (Eds.) *The function of ornament*. Actar [u.a.], 2006.

Pell, B., & Hild, A. *The articulate surface: Ornament and technology in contemporary architecture*. Birkhäuser, 2010.

Picon, A. *Ornament: The Politics of Architecture and Subjectivity - AD Primer*. John Wiley & Sons, 2013.

Böhme, G. (2013). Atmosphere as Mindful Physical Presence in Space. *Building atmosphere, OASE*, (91), 21-32. Retrieved from <https://oasejournal.nl/en/Issues/91/AtmosphereAsMindfulPhysicalPresenceInSpace>

Havik, K., Teerds, H., & Tielens, G. (2013). Editorial. *Building atmosphere, OASE*, (91), 3-12. Retrieved from <https://oasejournal.nl/en/Issues/91/Editorial>

Homunculus Nimbus

Abstract. This paper discusses the concepts and process in the creation of *homunculus nimbus*, an installation made of several sculptural bodies (*homunculi*) that are used to cover shell-like pavilion that acts as a habitat for the *homunculi*. *Homunculus Nimbus* is a projection of a future where synthetic life-forms are commonplace. The exhibit simulates the life-like resting and wake cycles in nocturnal beings by providing quiet and shade in the day and by activating with light and sounds at night through a continuous flow of light patterns in response to each other. From a distance the work is sculptural, but it is a destination as well as an object. Visitors are invited to enter the work, benches provide a place to rest and contemplate, inhabit, and commune.

Mark-David HOSALE¹

Keywords. *Architectonic, Biomimetic, Emotive, File-to-Factory, Digital Fabrication*

Introduction

Homunculus.nimbus (fig. 1) is the re-imagining of a previous work called, *homunculus. agora* (Hosale, 2015), which was exhibited for one year in the Markham Museum, Ontario, Canada from September 2013 to August 2014. *Homunculus.nimbus* and *homunculus.agora* are both installations made from the same sculptural bodies (*homunculi*) but with different treatments and contexts.

In *homunculus.agora* the *homunculi* were suspended in an eighteen by nine-meter double-height gallery and shown as part of a group exhibition in a museum context. As an *agora*, the work was imagined as a forum where people could come and reflect on the concepts of the work. The scale of this particular installation afforded the modality of assembling, as it was in a fairly large, reverberant space. Therefore, the use of the term *agora* was an invitation to gather there and exchange ideas.

For *homunculus.nimbus*, the *homunculi* are used to cover a seven-meter diameter, shell-like pavilion that was custom designed as part of the work and exhibited in an outdoor public space. The experience of *homunculus.nimbus* is intended to be both an alien and familiar, a projection of a future where synthetic life-forms may be commonplace. The exhibit simulates the life-like resting and wake cycles in nocturnal beings by quietly providing refuge and shelter in the day, while exhibiting dynamic patterns of light and sound that contribute to the activities of the festival at night. When awake, the sculptural pieces exhibit a continuous flow of light patterns in response to each other affecting visitors in the pavilion and the environment around them. Benches are placed on either side of the pavilion that are large enough for people to

1. Computational Arts, School of the Arts, Media, Performance, and Design, York University - nD::Studio-Lab, Toronto, Ontario, Canada, mdhosale@yorku.ca

gather and have closer, more private conversation.



Figure 1. *homunculus.nimbus* at Camp Wavelength (Fort York, Toronto), Photo: Mark-David Hosale, August 17, 2017

Architectonic Media Interventions

Homunculus.nimbus is connected to an ongoing research project called, *Architectonic Media Interventions*. This research-creation project is articulated by a series of works, developed in the *n-D::StudioLab*, that explore the integration of computational art and architecture. Experimentation in this research area focuses on building media-centric architectural components in existing built environments. These components take on many forms, ranging from furniture scale objects, to integrated building components, to building scale, such as a pavilion or intervention.

Artworks are the primary driver for innovation in AMI research-creation. AMI outputs include the development of hardware, software, and design workflow strategies that help streamline the process of working across multiple platforms and domains in large teams of contributors. This project provides a unique vantage point for exploring questions of how the digital is influencing the built environment. Through this project technical methods are used to facilitate artistic expression and to explore the impact that ubiquitous digital technology has on the built environment and our everyday lives in a social and experiential manner. AMI research critically engages the role of rising technologies in order to gain a deeper understanding of how technology and the built environment have merged in the past, are continuing to merge in the present, and what impacts on society, industry, individuals and the environment this integration will have in the future.

Concept

The inspiration for *homunculus.nimbus* was to explore the emotive connections we form with the technological objects we make. Both *homunculus.nimbus* and *homunculus*.

agora derive the name *homunculus* from an alchemically made creature that looks like a miniature of its creator. There are several recipes for making a homunculus, but they all commonly call for the use of the creator's ejaculate to grow a mandrake as part of a potion in which the homunculus is grown. After the creature is a fully formed homunculus, "[...] he comes out and puts himself at your service. And they never die. Imagine: they'll even put flowers on your grave after you're dead!" (Eco, 1989).

Conceptually, we form similar connections with our own technological creations as the alchemist did with the homunculus. I believe we form these connections because the technology we make is part of our ideas, our culture, and our bodies. And as we pass on the technology remains, it holds our thoughts, and the shape we give to it is deeply connected to the way we perceive the world. Technology is often seen as a disruption, or something alien when it is actually something that emerges from us and is more part of us than we are willing to accept. While we resist technology and the change it brings, we are actually resisting ourselves. Technology may be disrupting our lives, but we are the driving force behind that technology creating a paradoxical cycle between disruption, resistance, change, and becoming.

When we make built environments and objects and put them into the world we need to think critically about their impact on the environment and our culture. Objects that have permanence should be made with the intent of long-term impact and the affect of technology on ourselves. The project asks, can we form a symbiosis with the things we create so that they are a part of us and nurture our world and society for future generations to come? One approach to this question is to develop the environment as an immersive artificial ecological system with whom we can cohabitate. With this in mind *homunculus.nimbus* proposes what this connection could be like.

Behaviour

The behaviour of *homunculus.nimbus*, expressed through patterns of light and sound, is conceived of as a continuous lifecycle that mimics the resting and wake rhythms in living beings. Light behaviours are expressed through LED modules that are attached to each of the four petals of the *homunculi* sculptures. The LEDs on the petals light in sequence, oscillating in clockwise and counter-clockwise patterns in a gradient from fast to slow over time. The LEDs oscillate fast at first, then slow to a stop before changing direction and speeding up again. Every parameter of the LED light (hue, saturation, and luminosity) changes according to independent oscillations. Parameters shift in and out of phase with the oscillations of other parameters. These patterns move through the flock of sculptures in the pavilion in phasic ripples from front to back, then back to front in an interconnected tidal pulse in nearly endless combinations.

The inspiration for this approach to the light behaviour comes from the music of Steve Reich, in works such as *Come Out* (Reich, 1966) and *Piano Phase* (Reich, 1967). Reich used shifting time (in tape speed and rhythm respectively) to create the phasic patterns and sonic tapestries characteristic of minimalist music. In this same manner light events are driven in *homunculus.nimbus* by phasic relations between parameters to create a visual tapestry of fluttering and flowing light.

Sound in *homunculus.nimbus* is embedded in the benches of the pavilion, creating a stereo field within the pavilion. Sonic events are mapped to the patterns in the light parameters with motion mapping to rhythm, hue to frequency, saturation to timbre, and luminosity to volume. In *Camp Wavelength*, synthesis was realized using additive synthesis techniques that layered sine wave oscillators to make various timbral shifts

with (perhaps too) subtle pulsating effects. In *Winterlights*, the sound used frequency modulation synthesis with vibrato effects and timbral shifts resulting in a better mapping to the movement and oscillation of light patterns described above. The result was also reminiscent of the ambient sounds of John Chowning's *Stria* (Chowning 1977). The unfolding of the sound was articulated by large dynamic shifts, creating waves of sound slowly followed by moments of silence. At times, the sound would almost unnoticeably disappear and then return again subliminally, then gradually becoming a feature that is consciously present and integrated with the light behaviour of the work.

Exhibitions – Reflections

Homunculus.nimbus was exhibited twice, once for four days at *Camp Wavelength* 2018, Fort York, Toronto, August 18-19, 2018; and then for four months at the *Winter Lights Festival*, Ontario Place, Toronto from November 23, 2018 - March 17, 2019. The setting of summer versus winter, and the short and long duration between the two *homunculus.nimbus* exhibitions offered a very different experience of the work.

Camp Wavelength

Homunculus.nimbus was originally commissioned for *Camp Wavelength*, an annual festival that is held by *Wavelength*, a non-profit arts organization dedicated to the curated promotion of independent music in Toronto. When working with the *Wavelength* team it was important to create a work that had added value to the venue, could provide a place for festival goers to rest and enjoy the artwork. To this end, the project has an architectural program while simultaneously being an artwork, not purely being either, but something in between.

The *Camp Wavelength* festival was a four-day event that lasted from noon until midnight on each day. During the day, it was not possible to see the lights working on the pavilion because they would be overpowered by the sun. The only downside of this being a summer event was that it was night for only the last three hours of the event. The pavilion remained in a dormant state until dusk, and the behaviour of light and sound events were not apparent until then. There was, however, an emergent beauty at sunset that allowed for a lengthy transition from a dormant state to awake, which became a feature of the work. As the sun set, the patterns of light became brighter and brighter until illuminating fully as night fell. This process took 90-minutes. During the day it was mainly a location to sit and commune with others (but also to appreciate and admire). At night it became much more of an object of curiosity, and much more attention seemed to be focused on it as an artwork than during the day. For the participants of the festival the pavilion would transform from a peculiar architectural object, to a spectacle, an emergent attraction.

Beyond the diurnal patterns above, the ebb and flow of visitors to the pavilion was largely influenced by the scheduling of performers on the stage, with participants spending more time in the pavilion between sets and moving towards the stage when the music was playing. The biggest impact of the schedule on the pavilion behaviour was to the sound, which had to be redesigned so as not to compete with the music being performed during the festival. The sound levels of the work were kept low so that they were mostly heard when someone was sitting on one of the benches inside the pavilion. There were also moments throughout the day and night that sound could be heard between sets, and for an hour after the music stopped each day.

Winterlights

Winterlights is an annual festival that is truly Canadian in its conception. It takes place at night in winter at *Ontario Place*, a public park on the shore of Lake Ontario. In addition to the light works that are part of the festival, there is an ice-skating rink and concessions are available to visitors of the event.

Exhibiting at *Camp Wavelength* was rewarding, but it felt rushed as it was a short event in the hustle of an ambitious music festival that left only a short amount of time to appreciate and experience the work in its most expressive state (at night). By contrast, *Winterlights* had a slower feeling about it, nights were longer, and there was more time to appreciate it in its setting. The pavilion was located on a hill and was oriented to have views of trees in one direction and the lake itself in another. It was situated in a serene setting that invited calmness and contemplation.

A major difference was that participants were coming specifically to *Winterlights* to see the works of the festival and have some leisure time by the lake. While the main activity of the event happened at night, the park was open throughout the day. The lack of schedule meant that there was a pretty consistent flow of people throughout the event, with more people on the weekends and during the evening, and less people in the late hours. It was clear that many people were coming to the festival for a second, and even a third look.

While the light behaviour was primarily the same for *Winterlights* as it was in *Camp Wavelength*, the sound, as described above, changed dramatically and was more present during the event, allowing it to complement the light behaviour of the work more completely and without compromise as before.

Experiences – Reception

Homunculus.nimbus is not purely an artwork or an architectural object, it is situated between the two domains. It is designed to be inhabited, it has purpose and function, but its drive is aesthetic and experiential. *Homunculus.nimbus* intentionally avoids the modality and affordances of common place technological objects (such as a computer or phone), instead suggesting a different approach to technology that allows for time that is not dependent on immediacy. The work asks you to rest, slow down, and contemplate. It is a subtle work that prioritizes the atmospheric over technophilia by suggesting a way that we can take comfort in world we are making and understand it as part of ourselves and no longer alien.

While no scientific level study of *homunculus.nimbus* was conducted, several observations can be made:

- As with any work of art, most walk by, some linger, some longer;
- While the technology (wires, junctions, LEDs) that made the work were exposed and purposefully not hidden, visitors were not focused so much on the how of the work, but the why;
- For those keen to observe, they would wait and see how it would change over time, waiting patiently, curiously;
- Others would leave quickly, but if they returned, would notice something different and frequently stay longer the second time to see what might happen next;
- During the *Winterlights festival* I was visiting the exhibition regularly to check on its health and conduct any needed repairs. From time to time there was damage from the winter storms that were passing through. On one occasion

when I came to check on the work I discovered a stranger tending to it, adjusting wires that were hanging down too far, reattaching LEDs that had fallen off, etc. I watched him quietly from a distance until he was done. He stayed a while longer, contemplated the work, and then left. I said nothing.

Credits

Camp Wavelength installation team:

David Han, Filiz Eryilmaz, Rohan Likhite, Christina Paik, and Michael Palumbo

Winter Lights Exhibiton installation team:

Hrysovalanti Maheras, Michael Palumbo, and Jamie Twine

Project preparation and assistance:

Filiz Eryilmaz, Hrysovalanti Maheras, and Amirbahador Rostami

The homunculi were created in 2013 for *homunculus.agora*:

Homunculi Fabrication Consultants: Marco Verde (ALO [architecture | research and fabrication lab | education]) and Brandon Vickerd

homunculi Fabrication Production Team:

Nicole Clouston, Brandon Davis, Qendrim Hoti, Rhianna Paul, Karen Pham, and Erika Roshan

Realized in the nD::StudioLab, Transmedia Lab, and Digital Sculpture Lab at York University, Toronto, Canada

References

“Architectonic Media Interventions (AMI).” Accessed June 30, 2020.

<http://ndstudiolab.com/AMI>

Chowning, John. *Stria*. Composition for electronic tape. IRCAM. 1967.

Eco, Umberto. *Foucault’s Pendulum*. 1st trade. San Diego: Harcourt Brace Jovanovich, 1989. p. 248.

“*homunculus.nimbus*.” Accessed May 6, 2020.

<http://www.mdhosale.com/homunculus-nimbus>

Hosale, M.D. “*homunuculus.agora* (h.a), an architectonic art installation.” In: Proceedings of ISEA2015: The 21st International Symposium on Electronic Art; Vancouver, Canada, August 2015

“n-D::StudioLab.” Accessed June 30, 2020. <http://ndstudiolab.com/>

Reich, Steve. *Come Out*. Composition for electronic tape. Concord Music Publishing, BMI. 1966.

Reich, Steve. *Piano Phase*. Composition for two pianos. Concord Music Publishing, BMI. 1967.

“Wavelength.” Accessed June 30, 2020. <https://www.wavelengthmusic.ca/>

“Winterlights 2019” Accessed May 6, 2020.

http://ontarioplace.com/en/special_programs/winter-light-exhibition-2019/

Extending sensibility for metabolic processes in immersive media environments

Abstract. How can we experience the relation to our surroundings as processual and at the same time meaningful, and not from a perspective that is solely function-oriented but as the expression of meaning that lies in the nature of our relational being itself? In this paper I explore how an aesthetics of atmospheres in spatial installations can heighten our sensitivity for ecological interdependencies (external) and at the same time for the responsiveness of our bodies previous to semantic reference (internal). In this responsiveness I locate an openness towards patterns in the internal and external surroundings that allow a specific situation to make sense for a perceiving subject.

Desiree FOERSTER¹

Keywords. Atmosphere, Metabolism, Phenomenology, Aesthetics, Media Ecologies

Introduction

The term atmosphere goes back to the Greek *atmos* (vapor, steam) and *sphaira* (sphere), and refers to the layer of gas that surrounds the Earth. Besides being the subject of scientific inquiries, atmospheres have also been the subject of philosophers and, in the last 60 years, have been increasingly explored as a theme in both art and architecture. One reason for the theme's appeal lies in its ephemerality. For philosopher Gernot Böhme, atmospheres mark the in-between of things - they neither belong to subjects nor the physical environment alone, which caused him to argue that they become the ontological principle par excellence (Böhme, 1993, 125). However, this way of framing atmospheres has been criticized as reductionist because it hinges on the dichotomy of subjects and objects (Schmitz, 1998).

This dichotomy returns in another context of negotiating the relation between humans and their environment: ecosystem services. This design principle understands processes of life forms as productive for the established economic system. Particular aspects and processes in the environment are managed and employed which are considered to be supportive of the well-being and security of human inhabitants. Vertical gardens in urban areas, or the use of materials and structures with additional properties for urban wildlife, are some examples that obviously come with positive effects on humans and other animals. However, it becomes problematic if one takes a closer look at the rhetoric of ecosystem services.

Terminologies typical of this discipline, such as *habitat enhancement techniques* and *resiliency infrastructures*, emphasize the focus on narratives that regard the human habitat as vulnerable in the face of external environmental influences - a distinction

1. University of Chicago, Cinema and Media Studies, USA, dfoerster@uchicago.edu

that seems inevitable and yet manageable. Despite the fact that the concept of ecosystem services can have positive effects on biodiversity, it remains selective and reductionist.

This paper explores an aesthetic that represents the relation of humans and their environments differently. A special focus lies on the articulation of the sharing of the atmosphere with others. First, I will look at an example from architecture where algae and their photosynthetic activity are represented as ecosystem services. I argue that this leads to a reduction of the nonhuman other to benefit human consumption. In contrast, I explore an art work in which the negotiation processes between algae and their environment are represented in a way that preserves their absolute difference, but still suggests a possibility of connection. Finally, I present a virtual reality (VR) project I co-developed as a part of my research practice, which proposes an experiential situation in which the sharing of metabolic pathways with a vegetal other can be experienced in different ways.

The Green Curtain: PhotoSynthetica

PhotoSynthetica is a system designed by Ecologic Studio to reduce carbon concentration (CO₂) in the atmosphere. It looks like a green curtain and combines three components: an urban carbon tool used to measure the CO₂ concentration in the air as well as the performance of the overall system, an algae species that metabolizes carbon into oxygen (O₂), and sensors that measure the microclimate to ensure the optimal conditions for algae growth in relation to the number of people in the space. The surrounding air is pushed into the system and enters the algae culture, where it is supposed to be filtered and then reintroduced into the atmosphere.

PhotoSynthetica can be seen as a typical case of ecosystem services: the metabolism of a living organism is embedded into a context of anthropocentric consumerism, the algae are bred, monitored, and controlled in order to ensure the best atmospheric condition for human needs.

Such a reduction of living organisms to forces of labor without the potential for spontaneous, unwanted, difference-generating process-development is typical of many approaches found in ecosystem services. The living organism is rendered *smart* and *adaptable*. What is needed to counter such a reduction of natural processes to a utilizable essence and economic terminology, I argue, is an aesthetics that highlights potential relationships with environments and others we are sharing environments with, without reducing them to manageable conditions.

The phenomenology of Maurice Merleau-Ponty offers a different way of imagining the relationship between the sensitive and sensual body and its surroundings. His concept of the “flesh” designates an intermediate zone of mediation, which interrelates bodies and their environments: “Expression is always a sort of schema of the carnal other side of the flesh of the intersubjective world, exposed for the first time to the public eye as a visible trace of the indirect, symbolic texture of the invisible reality which constitutes it.” (Merleau-Ponty, 1995, xxii). The human subject extends to this “other carnal side of the flesh” and thereby engages with an “intersubjective world” that constitutes a realm in which the distinction between the other, the not-me, and the me is momentarily lifted. This other is not only the other I encounter in the form of a person or object, but also the other that is me: my body, for Merleau-Ponty, is also always an object in the world, always transcends itself. Merleau-Ponty’s approach to perception as embodied and mediation as an embodied practice provides in the following analysis an alternative to the tool-based approach towards natural systems in ecosystem services.

This foundational embeddedness of bodies in the world means that they expand sensually into their surroundings, whereby they enter into relationships with other bodies. Bodies in this view would not be defined as having clear borders but are instead recognized in their openness to affect and to be affected. In *PhotoSynthetica*, the precondition for this mutual affection does not rely only on the metabolic capacities of the bodies involved but also the built environment, the atmosphere of the space, and the digital system that mediates those metabolic processes. A processual aesthetics has to account for both the similarities and differences that enable these involvements in the first place and how they become available to the senses.

One way to start such an aesthetic approach is with the sensual body itself. Merleau-Ponty explains the interrelation of body and environment with the notion of the lived body. The lived body is at once the sensing body, and the object of conscious reference in its sensing. As a medium, the lived body is not static but transformative: the way a subject experiences its world and itself as a subject changes because those experiences transform the lived body in turn. Meaningful reference, therefore, is enabled by the body, because it is at the same time sensorially extended towards the world and sensual in itself.

With the next two projects, I will explore how the effects of metabolic processes that register in the external environment can be re-contextualized aesthetically. I will use these examples to further specify this aesthetics as processual and atmospheres as the media used here to enable an aesthetic experience of difference within interrelations.

Attuning to Alien Rhythms: The Molecular Ordering of Computational Plants

The piece *The Molecular Ordering of Computational Plants* by artist Andreas Greiner and composer Tyler Friedman brings together algae, sound, and science fiction to create what Greiner calls a *living sculpture*. What makes the sculpture *living* is that it highlights processes instead of displaying a static object. When exhibited at *basis*, Frankfurt, in 2018, the installation featured an aquarium filled with *pyrocystis fusiformis*, an algae species that displays bioluminescence when disturbed. In response to sound coming from subwoofers mounted underneath the aquarium, the algae would illuminate rhythmically. The sounds were heard alongside a recording of a story describing a future in which humans enter into a symbiotic relationship with algae.

I will argue in the following that the bodies of the visitors in the exhibition participated in forming a resonant body for the rhythmical illuminations of the algae and audible vibrations. They entered, figuratively, the first phase towards a symbiotic relationship as described in the recording. This first phase, I propose, consists of the sharing of a rhythm. According to Merleau-Ponty, attuning to a shared rhythm suggests an intimate relationship with others. It stands in as sharing a “manner of handling the world” (Merleau-Ponty, 2012, 370). This observation lies at the heart of intersubjectivity, by which a subject extends its own intentions into space and time, thereby creating a rhythm that can be recognized and taken up by others: “[I]t is precisely my body that perceives the other’s body and finds there something of a miraculous extension of its own intentions, a familiar manner of handling the world” (Merleau-Ponty, 2012, 370). Intersubjectivity then relies on modes of perception that enable the perceiving subject to recognize a familiarity in the way others are handling the world.

But can intersubjectivity be extended towards nonhuman others while leaving their

difference in tact? Jane Bennett proposes with her notion of onto-sympathy a concept for a more extensive understanding of our account for otherness. Onto-sympathy renders the world “as full of propositions waiting to be registered by interested bodies” (Bennett, 2017, 91). In order to register those propositions in the world, we have to “become alert to nonhuman-human affinities” (Bennett, 2017, 103). Her way of doing so is in parsing the operational process of sympathy into phases: the *gravitation* of bodies towards other bodies, the *cooperating* of bodies whereby those bodies are transformed, and *annunciation*, the recognition of others.

If we translate the human experience of the installation into this model, the first phase could be a visitor leaning towards the algae, becoming aware of their specific light intensity and illumination patterns. The second phase is marked as transformation: the sound stimulates skin receptors that register vibrations, muscle receptors detect the rhythmical changes in force and pressure and can interoceptively be sensed. Additionally to the sound resonating in the visitor’s body in this way, the illumination of the algae is captured by the retina of the eyes, transmitted to the nervous system. The visitor literally takes the shared rhythm under its skin. The last phase might be similar to the becoming-familiar with the thus encountered body of the nonhuman other, the recognition of a mechanism of life as it responds to the environment rhythmically.

An approach that brings together the concept of intersubjectivity and onto-sympathy does not start from the human subject or the nonhuman other as an individual, nor their surroundings as a base for manipulation. Instead it regards the relations between organisms and their surroundings as processual - a process from which the human subject and the nonhuman other as individuals as well as their surroundings are continuously composed. The aesthetic situation of *The Molecular Ordering of Computational Plants* enables an encounter whereby the nonhuman other is not simply supplemented to a functional logic. Instead, the sharing of a rhythm offers ways of attuning to otherness, of becoming attentive to a resonance formed within the encounter. With the project to follow, I propose an aesthetic practice to explore the potential of digital media to facilitate such an encounter between the human and the nonhuman.

Sharing the Metabolism of Plants: Give and Take

The VR-project *Give and Take* was not developed as an art piece but rather as a philosophical tool to study how our aesthetic experience changes in immersive media environments. Over the course of five minutes, the user moves through a virtual environment consisting of plants. Particles of different colors float through the air. Some of these particles emanate from the plants, while others come from the user’s body, synchronized with their breathing. The particles that the user exhales enter the leaves of the plants, and the particle stream emanating from the plants becomes denser.

What we represent with this feedback loop is the basic process of photosynthesis: the plants turn parts of the CO₂ exhaled by the user into O₂. The particle streams that represent O₂ and CO₂ disperse into the air around the user and give it a light blue color. Besides the visualization of this atmospheric exchange, the user also sees the plants grow.

About halfway through the experience, a change becomes noticeable: the plants take in less CO₂ and give out less O₂, and the surrounding atmosphere changes as well: as it fills up with the particles exhaled from the user, its color turns red, slowly fading

to black. The plants start to wither and the temperature gets noticeably warmer. The last seconds of the experience leave the user in darkness, feeling the temperature increasing.

Give and Take is not about perceiving and interacting with a plant as a virtual object, but about experiencing an interrelation with an environment through different sense modalities. To integrate our sense of temperature, we use heating lamps, to integrate our sense of breathing, we use a microphone that captures the sound of exhalation and matches it with the particle stream that represents CO₂. In integrating these different sense modalities, we want to provoke a shift in attention, away from the visual sense to those other senses, which are usually not prominent in our every-day experience. Through this shift towards the ways our bodies register effects of changing atmospheric conditions, I propose we also shift to an aesthetic mode of perception (Seel, 2005): away from the perception of an object in its being-so and towards the way we perceive in that particular moment. The *how* of experience starts to matter, rather than the *what*. The lived body can thereby be experienced as being extended towards its environment via different sense modalities, which allow us to gravitate towards other bodies, cooperate with them and announce their co-existence.

Conclusion

My interdisciplinary research practice is concerned with novel ways to aestheticize interrelations between bodies and their environment and how the experience of the processuality of these interrelations provides an alternative to the understanding of subjects and objects as arising from a presupposed essence. Crucial thereby is an openness towards difference - as found in our own bodies as they extend towards their environments, and the bodies of others. In developing my own aesthetic practice, I have been able to explore articulations of self and other that do not necessarily put the human at the center of activity. Elements in the environment such as air and light, but also sensing technologies, can mediate and express different temporalities of actions in the space. Developing a processual aesthetics in atmospheric media, I propose, can highlight that meaning-making is not only reserved for conscious thought but happens on a pre-reflective layer as well. While design projects that employ ecosystem services emanate from a more or less given human subjectivity that comes with an array of needs, projects like *The Molecular Ordering of Computational Plants* and *Give and Take* might provide perspectives that move beyond our immediate self-interest, and provide a context to articulate human subjectivities and non-ordinary forms of representations of others. How such an aesthetics could be adopted for the design of our everyday environments remains to be explored further.

Acknowledgments

The installation *Give and Take* was created in collaboration with Sarah Hermanutz, Andreas Rau, and Michaela Büsse at the Bauhaus University Weimar (Germany), Lacuna Lab (Berlin, Germany), and the Critical Media Lab (Basel, Switzerland).

References

Bennett, Jane. "Vegetal Life and Onto-Sympathy." In *Entangled Worlds*, edited by Catherine Keller, and Mary-Jane Rubenstein, 89-110. Fordham University Press, New York: 2017.

Böhme, Gernot. "Atmosphere as the Fundamental Concept of a New Aesthetics." *Thesis Eleven* 36, no. 1 (1993): 113-126.

Merleau-Ponty, Maurice. *Phenomenology of Perception*. London: Routledge, 2012.

Merleau-Ponty, Maurice. *Signs*. Evanston: Northwestern Univ. Press, 1995.

Schmitz, Hermann. *Body, Space, and Emotions*. Ostfildern: Edition Tertium, 1998.

Seel, Martin. *Aesthetics of Appearing*. Stanford: Stanford Univ. Press, 2005.

"Give and Take - event page" Accessed June 2, 2020. <https://www.ixdm.ch/give-and-take/>

"Photosynthetica." Accessed June 2, 2020. <https://www.photosynthetica.co.uk/>

"The Molecular Ordering of Computational Plants." Accessed June 2, 2020. <http://www.andreasgreiner.com/works/molecular-ordering-of-computational-plants/>

Development of the Integrated Approach on the impact of the Climate Adaptive Building Shells

on the Performance and Energy Efficiency of Building

Lilija ISYK¹

***Abstract.** The consolidation of environment, and technology represents an ample conjunction of developed and innovative elements to serve the landscape. Construction performance depends not only on the operation of individual elements in the building but also on how they behave as integrated approach to satisfy the user demands. In architecture, projects are contained of different phases of architecture process, and several factors need to be considered among this cycle, such as climate, building shape, comfort levels, materials and systems, occupant health and security. Climate Adaptive Building Shells are important, as they are starting point of energy efficiency measures, the main determinant of the amount of energy required for heating, cooling and ventilation.*

***Keywords.** Climate Adaptive Building Shells, Energy Efficiency, Building and Environment, Sustainable Architecture, Facade Design*

Objectives

The objective of our research is to generate an integrated approach on the performance and energy efficiency of buildings. Discovering potential of CABS, by establishing the connection between optimization techniques and adaptive, rather than static building shells. The focus is not on the eccentricities of individual cases, but the problem is approached from a general perspective.

In our investigation we use the following definition:

A climate adaptive building shell has the ability to repeatedly and reversibly change some of its functions, features or behavior over time in response to changing performance requirements and variable boundary conditions, and does this with the aim of improving overall building performance.

Research project will contain of the investigation of the changing of CABS in the performance and variable boundary conditions. To do this, we will create a research model and after, we will develop a strategy to proceed with making a simulation, in according to the certain criteria. All the simulations will be focused mainly to measure the density, surface absorptance, thermal capacity, thermal conductivity, window to wall ratio, in the two positions of the research model: long-term adaptation and short-term adaptation. After the simulations all the data will be collected, organized and structured into the tables, and diagrams to be able to analyze the new knowledge on the performance and energy efficiency of buildings. Based on the results and outcomes of our investigation, we will determine and create an integrated approach.

¹ Ph.D. student, and young researcher, Lusofona University of Humanities and Technologies, Lisbon, Portugal, isyk.lilija@gmail.com

State of Art

Improvements in design and construction of building shells plays an important role in recent efforts that aim to connect the gap from current practice towards meeting our future energy saving targets. Notwithstanding the fact that good progress has been made, these attempts usually do not get around the status quo that building shells are typically designed as static elements in a dynamic environmental context. By being static or fixed, the conventional building shell has no means of responding to the changes in weather conditions throughout the day and throughout the year, and the variable nature of occupants' preferences. In contrast, climate adaptive building shells (CABS) do offer the ability of actively moderating the exchange of energy across a building's enclosure over time. By doing this in a sensible way, in response to prevailing meteorological conditions and comfort needs, it introduces good energy saving opportunities. A growing interest in CABS therefore speculates on an added value on top of passive design solutions, and considers the concept as one of possible ways to accomplish the shift towards net zero energy buildings. The concept of CABS is referred to by a multitude of ambiguous terms, including: active, intelligent, dynamic, interactive, smart etc.

Current progress in the field of CABS is characterized by fragmented developments; either driven by specific advances in material science (e.g. switchable glazing, adaptable thermal mass and variable insulation), or originating from creative processes in design teams. Literature on CABS in relation to building performance simulation (BPS) shows the same degree of fragmentation, as it mainly deals with performance evaluations of specific case-studies such as: dynamic thermal insulation, and smart windows. Despite these efforts, it remains unclear what type of building envelope behavior, actually results in the best building performance.

Within research settings, it has been demonstrated recurrently that the application of optimization techniques as a design aid, can move building performance beyond the level of "trial-and-error" designs. Initially, these developments led to the specification of generic design rules, derived on the basis of simplified building models. The advent of more efficient optimization algorithms, and the continuing trend of increasing computational power, now also enables optimization studies to be performed at a higher level of detail.

First results of the Research Project

Figure 1 shows the results of the whole-year simulation. In this graph, each dot represents a single building shell design. A solution is said to be Pareto optimal if, and only if it is not dominated in one or two directions by any other solution, in the decision variable space (Wang et al., 2005). In Figure 1 these Pareto designs are indicated in red.

From Figure 1, we observe a rather sparse cloud, and thus a relatively quick convergence towards optimal solutions. In addition, the plot shows a smooth trade-off curve. This means that many compromise points are feasible, and that it is up to the design team to make a rational decision, by taking their preferences into account.

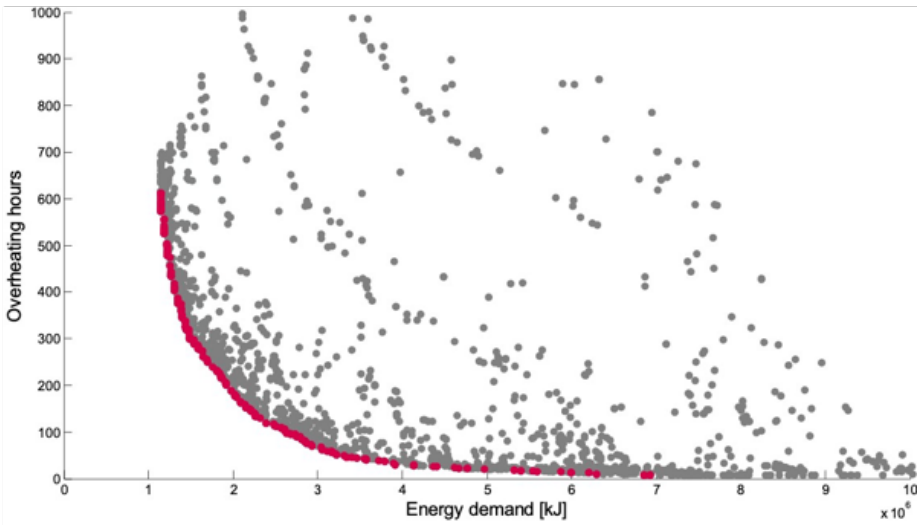

Figure 1. Scatter plot - Results of optimization for static building shell design

Whereas the scatter plot provides a clear overview of performance aspects, it gives no insights in terms of the design space. Figure 2 shows results for the same optimization run, but this time in a plot with parallel coordinates. In this figure, each line represents a single building design. The five left-most axes in the graph show the design parameters under evaluation. The two right-most axes show the performance that is associated with each of these input sets. By using the technique of ‘brushing’ (Martin and Ward, 1995), a sub-selection of the multi-dimensional space can be visualized. This type of analysis proved to be useful in facilitating more insights in the mapping from input parameters to performance space.

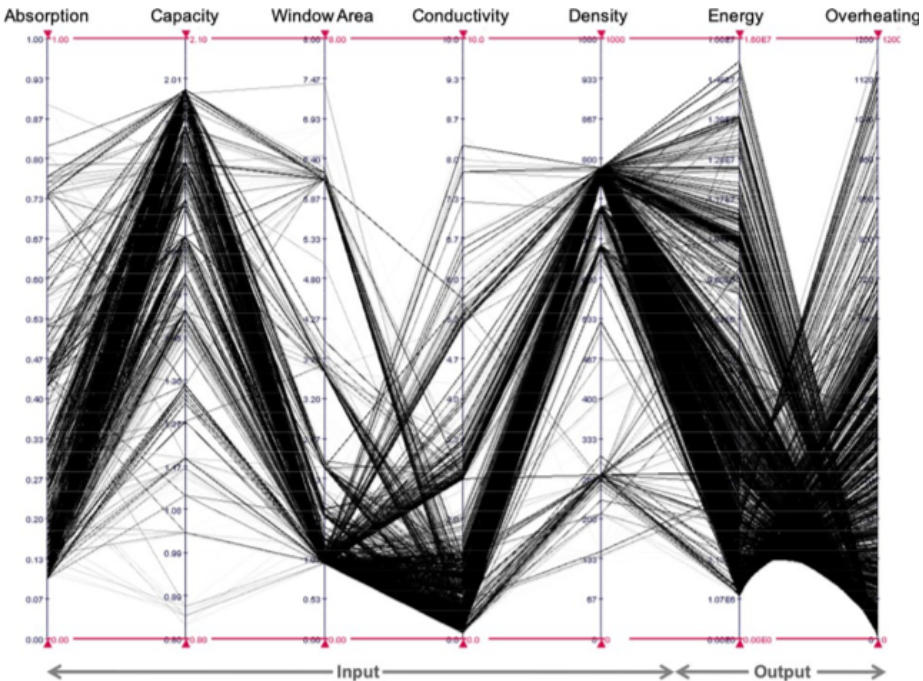

Figure 2. Parallel coordinates - Results of optimization for static building shell design

By contrasting the results with lowest energy demand to those with lowest number of overheating hours, Figure 3 and Figure 4 respectively, show that the designs with high levels of comfort tend not to coincide with those that result in low energy consumption. This result indicates the existence of conflicting goals, and the inability to meet them simultaneously. Likewise, complementary analysis also revealed that there exists a disparity between designs with low heating and low cooling energy demand. Decision-makers looking for well-balanced annual trade-offs will likely find their solution of preference located in the knee-point area of the Pareto set. This outcome indicates that performance of static building shells is at best only a good compromise for the whole year. In turn, it gives rise to the hypothesis that even the best static building shells can be outperformed by CABS.

Figure 3. Results with lowest energy demand

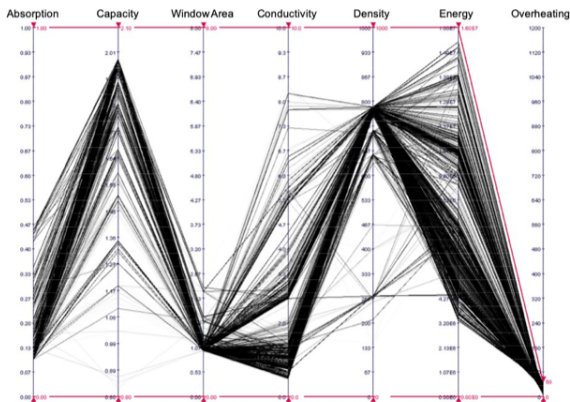
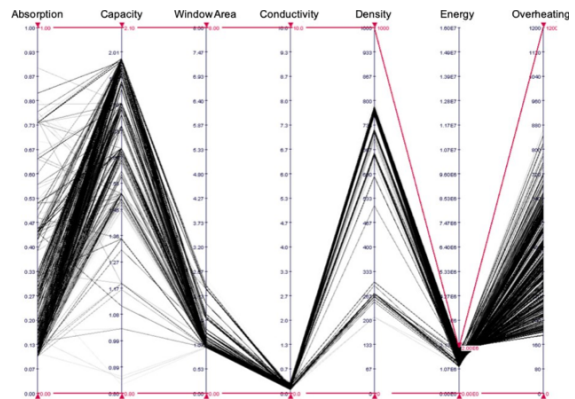

Figure 4. Results with least overheating hours

Observations

Based on the optimization study for the best performing static building shell design, the following observations can be made: The results of optimization tend to end up in the limits of the option space. Careful specification of possible parameter ranges is thus of primary importance.

The best performing building shell needs to make compromises in order to satisfy performance requirements throughout the whole year. This signals clear opportunities for the use of CABS. In the next section, the performance of the best static building shells will be compared to the performance of a CABS that is able to adjust its behavior at relatively long time-scales.

References

- Bosman P, La Poutré H (2007) Learning and Anticipation in Online Dynamic Optimisation with Evolutionary Algorithms: The Stochastic Case In Proceedings of Genetic and Evolutionary Computation Conference - GECCO-2007 London, UK, p. 1165-1172.
- Burdajewicz F, Korjenic A, Bednar T (2011) Bewertung und Optimierung von dynamischen Dämmsystemen unter Berücksichtigung des Wiener Klimas. *Bauphysik* 33:49-58
- Chantrelle F, Lahmidi H, Keilholz W, El Mankibi M, Michel P (2011) Development of a multi-criteria tool for optimizing the renovation of buildings. *Applied Energy* 88:1386-1394
- Clarke J, Cockroft J, Conner S, Hand J, Kelly N, Moore R, O'Brien T, Strachan P (2002) Simulation-assisted control in building energy management systems. *Energy and buildings* 34:933-940
- Coffey B, Haghighat F, Morofsky E, Kutrowski E (2010) A software framework for model predictive control with GenOpt. *Energy and Buildings* 42:1084-1092
- Crawley D, Hand J, Kummert M, Griffith B (2008) Contrasting the capabilities of building energy performance simulation programs. *Building and Environment* 43:661-673
- Deb K, Pratap A, Agarwal S, Meyarivan T (2002) A fast and elitist multi-objective genetic algorithm: NSGA-II. *IEEE Transactions on Evolutionary Computation* 6:182-197
- Esteco (2011) modeFRONTIER - the multi-objective optimisation and design environment. Available at: http://www.esteco.com/home/mode_frontier/mode_frontier.html [Accessed May 2011].
- Gero J, D'cruz N, Radford A (1983) Energy in context: A multi-criteria model for building design. *Building and Environment* 18:99-107
- Gyalistras D, Gwerder M, Oldewurtel F, Jones C, Morari M, Lehmann B, Wirth K, Stauch V (2010) Analysis of energy savings potentials for integrated room automation In Proceedings of 10th REHVA World Congress Clima
- Hoes P, Trcka M, Hensen JLM, Hoekstra Bonnema B (2011)(a) Investigating the potential of a novel low-energy house concept with hybrid adaptable thermal storage. *Energy Conversion and Management* 52:2442-2447
- Hoes P, Trcka M, Hensen JLM, Hoekstra Bonnema B (2011)(b) Optimising building designs using a robustness indicator with respect to user behaviour In Proceedings of Building Simulation 2011 Sydney, Australia.
- Hopfe CJ (2009) Uncertainty and sensitivity analysis in building performance simulation for decision support and design optimisation. Ph.D. Thesis. Eindhoven University of Technology.
- Loonen RCGM (2010) Overview of 100 climate adaptive building shells - MSc Thesis Report.
- Loonen RCGM, Trka M, Cóstola D, Hensen JLM (2010) Performance simulation of climate adaptive building shells - Smart Energy Glass as a case study In Proceedings of SSB 2010: 8th international conference on system simulation in buildings Liège.
- Manzan M, Pinto F (2009) Genetic optimisation of external shading devices In Proceedings of Building Simulation 2009 Glasgow, p. 180-187.
- Martin AR, Ward MO (1995) High dimensional brushing for interactive exploration of

multivariate data In Proceedings of the 6th Conference on Visualization'95 IEEE Computer Society, p. 271.

Rosen R (1985) Anticipatory systems. New York: Pergamon.

Ross A, Rhodes D (2008) Using Natural Value- centric Time Scales for Conceptualising System Timelines through Epoch-Era Analysis In Proceedings of INCOSE International Symposium 2008 Utrecht, The Netherlands.

Ross AM (2009) Combining Pareto Trace with Filtered Outdegree as a Metric for Identifying Valuably Flexible Systems In Proceedings of the 7th Annual Conference on Systems Engineering Research

Trcka M, Loonen RCGM, Hensen JLM, Houben JVF (2011) Computational building performance simulation for product and integrated design development and optimisation In Proceedings of Building Simulation 2011 Sydney, Australia.

Wang W, Zmeureanu R, Rivard H (2005) Applying multi-objective genetic algorithms in green building design optimisation. Building and Environment 40:1512-1525

Wright J, Mourshed M (2009) Geometric optimisation of fenestration In Proceedings of Building Simulation 2009 Glasgow, p. 920-927.

Zavala V, Constantinescu E, Krause T, Anitescu M (2009) On-line economic optimisation of energy systems using weather forecast information. Journal of Process Control 19:1725-1736

04

BODY, CULTURE, IDENTITY?

05

DIGITAL ARCHITECTURE. ATMOSPHERES IN DESIGN
AND NEW RESPONSIVE & SENSITIVE CONFIGURATIONS

06

FROM A SENSITIVE ECOLOGY OF
AMBIANCES/ATMOSPHERES TO A POLITICAL ECOLOGY

07

INFINITE ATMOSPHERES? ETHIC DIMENSIONS
OF AND FOR THE DESIGN OF PUBLIC SPACES

08

INHABITING INSECURITY.
PRACTICES AND REPRESENTATIONS

From a Sensitive Ecology of Ambiances/Atmospheres to a Political Ecology

Session 6 – Introduction

Damien MASSON¹,
Rachel THOMAS²

Recently, there has been an evolution in urban practices and sensibilities that bear more or less directly the mark of the effects of certain “ambiances policies” which translates in the urban realm in terms of sensory marketing, feeling of safety creation, pacification, aestheticization, hygiene, entertainment, and so on. However, these “ambiances proposals” also generate pervasive forms of normativity that make certain practices, some forms of attentiveness, some ways of being and being together in public more or less acceptable.

Most of research in the field of architectural and urban ambiances show how they affect the experience of spaces and place, by giving a certain tone to the situations in which we find ourselves, we act and interact. In doing so they contribute to open up the field of urban ecology by paying attention to the sensory dimensions of the environment, and by contributing to show in which manners these dimensions contribute to making such environments livable for city-dwellers. Nevertheless, few of these works address issues of sensory un-livability or highlight the role ambiances play in situations of unrest, marginalization, stigmatization - in short, in situations that increase our sensory vulnerability and undermine our ability to participate in ordinary social life.

One of the challenges of this session is to give a precise attention to the ways in which descriptive approaches to ordinary social life - attentive to their sensitive and affective dimension - can help to understand the social, cultural and ethical issues involved in the current transformations of urban atmospheres, notably when these transformations reflect climates of tension, vulnerability, intranquillity, threat... A second range of challenges of this session concerns the global environmental crisis that translates locally into deeply altered sensory worlds. Such transformations contribute to create uncertainty, unease and certainly affect our modes of living.

By addressing these challenges, this session aims at laying the first steps of a critical reflection on the conditions of moving from a sensitive ecology of atmospheres to a political ecology of these. The session also aims to provide some answers to the following questions: How does an ambiance-based approach allow us to apprehend these issues in terms of symbolic violence, hierarchy, inequality? How does it allow the researcher to access these phenomena below their visibility and enunciation? In which

1. CY Cergy Paris University, MRTE Research group.

2. AAU Laboratory, Cresson, France.

ways do they upset our affects, ways of feeling, tones of experience? How can this become a critical research category that addresses changes in our living environments?

All the chapters of this session question the production of space as a problem not only political, social and cultural but also sensitive, affective and atmospheric. Based on case studies from both the North and the South, or on literary explorations, they all deal with the issue of demonstrating that policies that act on living together, whether they are conducted by public authorities or planners, or grassroots, whether they concern the shaping of material or socio-cultural public space, have sensitive effects, which can be characterised in terms of atmosphere, and which act on the situated bodies. Finally, they all contribute to show how these effects contribute to creating situations of discomfort, loss of reference, and even stigmatisation. They also show, in hollow, the environmental resources potentially contained in urban environments, be they social, material or sensitive, and which are likely to provide critical levers for action to overcome these limits.

The session is introduced by the chapter by Masson and Thomas who question the political dimensions of the uses of ambiances, and in turn ask how to raise awareness of the political dimension of research on ambiances. Based on a theoretical reflection using the concept of living well together, they lay the groundwork for a political ecology of ambiances, its conditions of possibility and its effects.

Their article is followed by Appel's, which questions the secular colonial logics in Canada, their consequences on the construction of a controversial collective memory and their socio-æsthetic effects. The text thus shows how colonialism pervades atmospheres in Canada, and what bodily forms of resistance and agency can be opposed to it.

The chapter of Di Croce explores the sensitive dimensions - sonic, in particular - of the social vulnerability of the Quartiere San Giovanni e Paolo in Palermo (Sicily). In doing so, the author uses the ambiances as a witness, which makes it possible to account for the sensitive and cultural effects of a situation of social and economic fragility. But he also uses them as a critical tool, aiming at transforming the situation by mobilising æsthetic experiences to raise the awareness and empowerment of the inhabitants.

This text is followed by the chapter of Vyzoviti and Chalvatzoglou which starts from the refugee crisis that began in 2016 in Greece to question the ordinary practices and sensitive forms of social life in refugee camps in Athens and Thessaloniki (Greece). Their chapter helps to show how the urbanity of the camps, and the identities of the refugees are constructed in the daily practices, particularly the sensitive ones, of the inhabitants of these spaces.

For their part, Lamounier and Tângari examine how the attractiveness of a neighbourhood on the outskirts of Rio de Janeiro (Brazil), marked by a high level of conflict, and its socio-environmental vulnerability is constructed. To this end, they propose the notion of a preference atmosphere which articulates the material, visual and emotional dimensions of the relationship to place. From there, they construct a methodology to account for the paradoxes inherent to this territory, in which attractiveness does not appear as directly being opposed to the experience of risk.

Soeiro's text questions the logics of urban renewal and territorial promotion in Lisbon (Portugal) since the financial crisis of 2008. It postulates that the success of urban

renewal processes depends in particular on their capacity to take into account the sensitive ecology of the situations that will be created, not only with a view to producing quality spaces, but also to limit the phenomena of gentrification.

Also questioning the mobilisation of affects and sensitivities in the logics of production of lived spaces, Laffont's text questions the contemporary transformations of sensitivities. To this end, he examines the urban evolutions experienced by the cities of Nantes and Saint Etienne (France) in recent decades. His text contributes to showing clear logics of the instrumentalization of ambiances for the purposes of territorial revitalization and to criticizing the forms taken by these logics, leading to a strong standardization of proposals for sensitive and affective urban landscapes.

Finally, Barchetta's text concludes the session by linking together ecological stakes, atmospheres, and political issues. Starting from the case of the city of Turin (Italy), this work reports on the dynamics of environmental and urban degradation, and ruination. Thanks to an atmospheric-based analysis of these dynamics the author allows us to grasp the specific forms of the socionatural assemblages at stake, which articulate, planning decisions, situated practices, and ecological dynamics.

From a Sensitive Ecology to a Political Ecology of Ambiances

Issues and Challenges?

Damien MASSON¹,
Rachel THOMAS²

Abstract. The interest in ambiances or atmospheres largely contributed to the clarification of the role of sensory phenomena of space, perceptual modalities and affects in the construction of social life. Among the research on ambiance and atmospheres, some of them question the effects of ambiance policies on forms of civility in public, and on ways of being in the world as well as living together. In doing so, they contribute to the politicization of urban ambiances. With a prospective aim, this chapter extends this strand towards the field of urban political ecology. By questioning the modalities and issues involved in opening up this latter field to the sensory, this text aims to indicate what a “political ecology of ambiances” could be and what it could do.

Keywords. Urban Ambiances, Social and Sensory Ecologies, Politics, Living Well Together

Introduction

“For nearly a month, there’s been no honking, no whirr of vehicular engines, no echo of loudspeakers and no clanking of machinery in factories. For nearly a month, since the lockdown was clamped, Delhiites have been waking up to the chirping of birds”³ comments on a recent article in the Times of India, describing the exceptional sound situation that New Delhi, like more than half of the world’s metropolises, experienced during the lockdown linked to the Covid-19 epidemic.

This situation of sonic contrast makes the absence of ordinary urban ambiances particularly obvious. It also reveals their meaningfulness as a descriptive and analytical category of the functioning of urban environments. Indeed, this example shows how a political decision - lockdown - driven by sanitary requirements has, at least, the following consequences:

- Material, by implementing measures to restrict and channel traffic;
- Social, by organizing the restriction of interactions;
- Environmental, as in the temporary improvement of air quality rapidly observed in many metropolises during this lockdown;
- Sensory, as shown in the previous example.

These dimensions, in their multiplicity, are to be thought together and in their interactions, and the notion of ambiance allows this type of articulation (Kazig, Masson, Thomas, 2017).

1. *CY Cergy Paris University - MRTE Research Group, France, damien.masson@cyu.fr*

2. *Ambiances, Architectures, Urbanités Laboratory (UMR CNRS 1563) - CRESSON Research Group - France, rachel.thomas@grenoble.archi.fr*

3. See at: <https://timesofindia.indiatimes.com/india/covid-19-noise-pollution-falls-as-lockdown-rings-in-sound-of-silence/articleshow/75309318.cms>

Among the existing research on ambiances and atmospheres, certain articulate explicitly these concepts to social and political issues. For example, some questions the atmospheric consequences of urban policies - whether intentional or not (as in the example cited above) - on forms of civility in public and ways of being in the world as well as living together (see part. 1). In doing so, these works think of ambiances as not only a characteristic of urban environments, but also a form of urban life. With a prospective aim, this chapter proposes to extend this strand towards the field of urban political ecology. By questioning the ways and the stakes of an opening up of this latter field to the sensory topic, this text aims to indicate what a “political ecology of ambiances” could be and what it could do.

The chapter is organized in three parts. In the first one, we will show how existing work on ambiances raises political questions, even if these are not necessarily explicit. In the second part, we will set up the theoretical foundations of an articulation between ambiances and politics. To do this, we will develop the argument of “living well together” as one proposal for an explicit politicization of ambiances. From there, we will set up the milestones allowing us to articulate this political approach of ambiances to the field of urban political ecology. In doing so, we will show what questions these fields share, but also what project and what issues their articulation makes possible.

Ambiances: An Inherently Political Topic That Does Not Tells Its Name

Over the last thirty years, the growing interest for ambiances or atmospheres largely contributed to the clarification of the role of sensory phenomena of space, perceptual modalities and affects in the construction of social life. From æsthetic thought to phenomenological, non-representational, pragmatic and ecological approaches, and by describing in-situ forms of experience, research works on ambiances reveal how they operate on the sensory forms of ordinary social life and affect their tonalities. Nevertheless, by giving a certain tonality to the milieus we live in and the situations we experience, ambiances also affect, in a diffuse and discreet way, our sensitivities, our ways of being and of being together in public.

More recently, international empirical works analyse the consequences of the ambiance setting in public spaces - whether it deals with aesthetisation policies, pacification or securing - on the tonalities and forms of social life (Thomas, 2014; Tixier et al., 2012; Fiori and Sanchez, 2014; Masson et al., 2014; Thomas, 2018). They also question the reconfiguration of forms of civility in public⁴. These works show that by transforming in small, often imperceptible steps our movements, our modes of attention, even our “states of body” (Thomas, 2014), the ambiance affects permanently our ways of perceiving and sensitively inhabiting our environments. In doing so, the critical scope of these works is implicitly political. By describing the in-situ forms of experience, these studies reveal how the ambiance settings test the citizen, affect the quality of his or her relationship to the Other and to his or her environment.

4. By “civility,” we intend the ability to live within a society, to adjust our behaviour to context-sensitive normative expectations, to tune our personal pace and to act in synrythm (i.e. to tune our personal pace to the collective pulse).

Studies on affective atmospheres coming from English-speaking geography⁵ show how the atmospheric properties that surround situations give them a more or less favorable tone to the individuals' engagement (Adey, 2013; Simpson, 2014; Edensor and Sumartojo, 2015; Sumartojo and Pink, 2019), place them in comfortable or destabilizing states, activate or fail their competences (Duncan, 1996; Brennan, 2004). Some of these works question more directly the sociopolitical implications of ambiances, especially as they use the notion of affective atmosphere as an analyzer of problematic contemporary situations at a political level. Others are interested in the ability of ambiances to convey political affects (Anderson, 2015; Closs-Stephens, 2016). Lastly, further works reveal the way atmospheres evolve and participate in the diffusion of affects in situation of conflict (Fregonese, 2017). These works address atmosphere as a medium, as it ensures communication from political to sensitive. In doing so, they produce a critique of the tacit governance of societies.

Whether they come from the field of urban ambiances or that of affective atmospheres, these works recognize their pervasive and diffuse characters. In doing so, they place urban ambiances at the crossroads between body and space, thus recognising their political dimension. Both these fields share the interest - without necessarily making it explicit - in the social scope of all the forms taken by the ambiance setting in urban situations.

Setting Politics Within Ambiances

The works mentioned previously express an implicit approach to politics. How moving to an explicit one? In other words, how to politicize ambiances?

The question of politics has only recently been addressed in the field of urban ambiances, but it is not always precisely named and defined. Furthermore, it is more related to a theoretical reflection on the conditions of production of the sensory framework of daily life than to an empirical investigation of the ways in which forms of life are deployed or constrained. In Bonicco-Donato's work (2016), the question of politics is articulated within a philosophical reflection on the government of conduct and the condition of urban dweller. With a view to contribute to the field of architecture, she extends the reflections on septicization of contemporary urban worlds by examining their effects on bodies and the flowering of the minor rituals of urbanity. On his side, Albertsen (2016) relies on Böhme's works to reflect upon a power of atmospheres that manipulates implicitly our moods and emotions. Lastly Pecqueur (2015) questions the scale of the infra-political within ordinary civilities, assuming an ambient bedrock for the civil link. He invites us to understand how the diffuse qualities of situations of interactions have an influence on their happiness or unhappiness.

These proposals ask us two questions. Firstly, how do these authors conceptualize politics? - with the exception of Albertsen, who clarifies the difference between "political" and "politics," the other lack at defining this term. Secondly, how - or, upon what - do they politicize ambiances?

5. Works on ambiance developed in the field of French architectural and urban research, share a common interest (on the sensory dimension of space) with those developed in English-speaking geography around affective atmospheres. Nevertheless, ambiances describe the material, social and sensitive construction of lived spaces, while affective atmospheres examine rather ontological implications of political, affective and sensitive considerations in social situations. Because our work falls within urban research, we will privilege the use of the notion of "urban ambiance" in this article.

To answer these questions, let's agree first on *politics* term. We understand politics as a "way of life" (Dewey, 1927; Lefort, 1986). In that sense, politics takes place every time individuals are in contact, organize themselves and negotiate between one another, act together to defend the common good from singular positions and perspectives. This conception of politics does not limit the question of politics to the modes of government of individuals. It defines politics as the gaps where, from each individual world, a common one is built. Such a conception of politics allows to pay attention to the ways in which spaces and ambiances sharing is made on a daily basis, and is embodied in gestures, attitudes, forms of attention, and words exchanged between anonymous people.

Secondly, let us specify one of the possible objects of the politicization of ambiances. Considering the politics as a form of life invites us to address the fundamental question of "living well together" (Arendt, 1958) and its conditions of existence. For the philosopher, "living well together" is not only about establishing a legal and institutional framework accepted by all, and that manages the forms of appearing in public. It also means engaging in, participating in, and sharing with others the public space. This "living well together" is also embedded in a material ecology (Cefai, 2011). It falls within architectural or urbanistic forms and ambiance configurations as much as within the interactions between bodies and words. In our case, we understand it more precisely as a form of coexistence between citizens that relies less on the sharing of practices and homogeneous experiences. It relies more on the possible cohabitation of many modes of sensory dwelling the urban world, and on plural ways of being and being together in public. From this point of view, politicizing the work on ambiances consist in examining, explicitly, the way that everyday routines and sensations they produce entwine into atmospheric configurations that enable or hinder them. In doing so, it grasps politics by describing, questioning, but also by affectively appreciating and evaluating the potential of ambiances for urban habitability. Politicizing the work on ambiances would also consist into addressing explicitly the question of stigmatizations in connection with processes of standardization, control and setting of ambiances. This question of inequalities, games of hierarchy or symbolic violence is lacking in the work on ambiances. It is now about questioning the role of ambiances in the implementation of standardization processes regarding urban uses that can create a disruption within the mechanisms of civility, enhance the citizens' vulnerability, replicate forms of exclusion.

Tu sum up, putting the argument of "living well together" on the agenda of the works on ambiances direct them towards a clarification of the moral, ethical and social stakes of their transformations. On a political level, it questions the way forms of cooperation, negotiation and adaption interact once trials (physical, practical, perceptual, affective, evaluative) operate during the experience. Such an approach could resonate with the manner that urban political ecology questions the relationship between urban dwellers and their environment, since, like it, it would assert a concern for what we care about and a willingness to stand up for what we desire.

Political Ambiances, Political Ecology of Ambiances. How and What For?

By introducing this chapter with the contemporary crisis linked to the Covid-19 pandemic, we sought to illustrate the co-dependence of urban, social, political, environmental, health and sensory issues. Then we suggested a politicization of the ambiances through the use of the notion of living well together. This working track allows us to go beyond a measurable, phenomenological or aesthetic apprehension of ambiances, by highlighting

their power to shape social and political relations between individuals. It also allows us to apprehend the upheaval of the frames in and through which these relations and relationships unfold. These upheavals result from fundamental changes, that are not only social and political (cf. parts 1 and 2), but also ecological. To take them into account contributes to the broadening of the thematic spectrum of this politicization of ambiances.

By questioning the nature and transformations of the artificial worlds in which human societies live, the field of Urban Political Ecology (UPE) raises similar questions. The UPE's main challenge is to consider the evolution of "natural" environments (biodiversity, hydrology, etc.) embedded in urban realm, which by definition deals with social, political and cultural problems. In so doing, it enables us to think of the urban as a composition of "socio-natural" (Swyngedouw, 1996) assemblages that are "political worlds" (Angelo and Wachsmuth, 2014), in which either qualities, and degradations of human and non-human living conditions, are articulated in a systemic way⁶.

Through its conceptual model, UPE provides an interesting breeding ground for the politicization of the ambiances we are considering. Because this field does not directly question the sensitive and ambient dimension of the processes it considers, we formulate the following lines of work:

- To affirm, at the theoretical level, the pivotal role of ambiances in the clarification of the ordinary forms of manifestation of the "socio-natural," or environmental, social and material processes that the UPE has set itself the task of studying;
- To articulate scales considering that the ordinary sensitive experience is a place of crystallization, percolation and filiation of the historical dynamics that contribute to the formation of observable situations;
- To hybridize, methodologically, forms of inquiry and of inquiry narrative, which are grounded on the situated corporal engagement for the understanding of the above-mentioned processes and dynamics.

These tracks are intended to open up the work programme of a political ecology of ambiances. It is now necessary to put it into practice in order to be able to evaluate its consequences.

References

Adey, Peter *et al.* "Pour votre tranquillité: Ambiance, atmosphere, and surveillance." *Geoforum* 49 (2013): 299-309. DOI: <https://doi.org/10.1016/j.geoforum.2013.04.028>

Albertsen, Niels 2016. "Atmosphere: power, critique, politics. A conceptual analysis." In *Le futur des ambiances. Actes du 3e Congrès International sur les Ambiances*, edited by Rémy Nicolas and Tixier Nicolas, 573-578. Volos, Réseau International Ambiances, 2016. <https://hal.archives-ouvertes.fr/hal-01414027>

Anderson, Ben. "Neoliberal Affects." *Progress in Human Geography* 40 (2015): 734-753. DOI: doi.org/10.1177/0309132515613167

Arendt, Hannah. *The human condition*. Chicago: University of Chicago Press, 1958.

Bonicco-Donato, Céline. "De l'aménagement des milieux à la technologie ambiante du pouvoir" In *Le futur des ambiances. Actes du 3e Congrès International sur les*

6. These works thus consider processes of ruinification, or ecological degradation, by observing in the same movement their urban, environmental, social and political effects.

Ambiances, edited by Rémy Nicolas and Tixier Nicolas, 593-598. Volos, Réseau International Ambiances, 2016. <https://hal.archives-ouvertes.fr/hal-01404383>

Brennan, Teresa. *The transmission of affect*. London: Cornell University Press, 2004.

Cefai, Daniel. "Vers une ethnographie (du) politique : décrire des ordres d'interaction, analyser des situations sociales." In *Du civil au politique. Ethnographies du vivre-ensemble*, edited by Berger Mathieu, Daniel Cefai, and Gayet-Viaud Carole, 545-598. Bruxelles: Peter Lang, 2011.

Closs Stephens, Angharad. "The affective atmospheres of nationalism." *Cultural Geographies* 23 (2016): 181-198. DOI: [10.1177/1474474015569994](https://doi.org/10.1177/1474474015569994)

Dewey, John. *The public and its problems*. Holt Publisher, 1927

Duncan, Nancy. *Bodyspace: Destabilizing Geographies of Gender and Sexuality*. London: Routledge, 1996.

Edensor, Tim & Sumartojo, Shanti. "Designing Atmospheres: introduction to Special Issue" *Visual Communication* 14 (2015): 251-265. DOI: [10.1177/1470357215582305](https://doi.org/10.1177/1470357215582305)

Fiori, S., Garcia Sanchez, P., 2014. "Les espace-temps de la mobilité labile." In *MUSE : les énigmes sensibles des mobilités urbaines contemporaines*, edited by Thomas, Rachel et al., 91-161. Grenoble: Cresson, 2014.

Fregonese, Sara. "Affective Atmospheres, Urban Geopolitics and Conflict (de)Escalation in Beirut." *Political Geography* 61 (2017): 1-10. DOI: [10.1016/j.polgeo.2017.04.009](https://doi.org/10.1016/j.polgeo.2017.04.009)

Kazig Rainer, Masson Damien and Thomas, Rachel. "Atmospheres and mobility: an introduction." *Mobile Culture Studies. The Journal* 3 (2017).

Lefort, Claude. *Essais sur le politique*. Paris: Seuil, 1986

Masson, Damien et al. "Surveillance(s) en public." In *MUSE : les énigmes sensibles des mobilités urbaines contemporaines*, edited by Thomas, Rachel et al., 165-245. Grenoble: Cresson, 2014. DOI: [10.25364/08.3:2017.1.1](https://doi.org/10.25364/08.3:2017.1.1)

Pecqueux, Anthony. "Ambiances et civilité. Ambiances." *Ambiances, Varia*, 2015. DOI: [10.4000/ambiances.580](https://doi.org/10.4000/ambiances.580)

Simpson, Paul. "Spaces of Affect." In *Ashgate Research Companion on Geographies of Media*, edited by Adams Paul, Craine Jim and Dittmer, Jason, 329-345. Aldershot: Ashgate, 2014.

Sumartojo, Shanti & Pink, Sarah. *Atmospheres and the experiential world. Theory and methods*. London & New York Routledge: Coll. Ambiances, atmospheres and sensory experiences of space, 2019.

Swyngedouw, Erik "The city as a hybrid: On nature, society and cyborg urbanization," *Capitalism Nature Socialism*, 7:2, 65-80, (1996), DOI: [10.1080/10455759609358679](https://doi.org/10.1080/10455759609358679)

Thomas, Rachel. *Une critique sensible de l'urbain*. Habilitation Thesis (HDR). Grenoble: Université Grenoble Alpes, 2018. <https://hal.archives-ouvertes.fr/tel-01818999>

Thomas, Rachel et al. *MUSE : les énigmes sensibles des mobilités urbaines contemporaine*. Grenoble: Cresson, 2014. <https://halshs.archives-ouvertes.fr/hal-01022664>

Tixier, Nicolas. "The recuperation of public space: a closer look at Bogotá, Colombia." In *Pressures and Distortions: City Dwellers as Builders and Critics. Four Views*, edited by Ned Kaufman, 338-433. New-York, Éd. R. Viñoly Architects PC, 2012.

Anxious Atmospheres of the Apologetic State

The Reconciliation Narrative and Contemporary Settler Colonialism

Seraphine APPEL¹

Abstract. This article explores how atmospheres in Canada are informed by a colonial attitude, logic of replacement, and hegemonic narratives of relationships to place to suggest that the inconsistencies between the politics of apology and the colonial response when the spatial order is challenged generates settler anxiety. This provocation is offered by considering the ongoing reconciliation rhetoric and decolonial resistance. The former illustrates the stage-value of the aesthetics of reconciliation manifest in politically charged sensitive atmospheres and the latter shows how colonial reaction to the deviant or resistant body illuminates the political potency of corporeal space.

Keywords. Settler Colonialism, Atmosphere, Political Apology, Reconciliation

Colonial Space

The emotional tones of a space are created and altered by traces of what has passed through, by which histories are affirmed and which are erased, and by physical and narrative constructions of how people relate to the land. In settler colonial spaces, the atmospheres that this manifests enforce descriptions of relationships to space that are informed by the replacement of people and place. In Canada, this is an ongoing and intentional project, and is coupled with the staging of a soft colonialism: a sustainable green aesthetic, colonial apology, and rhetoric of recognition and reconciliation. I suggest that the inconsistencies between this narrative and colonial responses to decolonial resistance generates settler anxiety and demonstrates the politicality of the body.

Distinct from enterprise colonialism, the project of settler colonialism is not only to profit from the land but to replace the existing population. Patrick Wolfe (2006) calls this the 'logic of elimination'. Armand Garnet Ruffo articulates that "[w]hen you have a people whose values are at odds with the fundamental structure of the society, a society built on the exploitation of people and the land, then that society can only do two things to accommodate those people: eliminate them - incarcerate them, for example - or assimilate them, pay them off" (Dewar in Robinson et. al., 2016, 225). In Canada, the explicit colonial relationship has been re-written, and has shifted "from a more or less unconcealed structure of dominance to a form of colonial governance that works through the medium of state recognition and accommodation" (Coulthard, 2014, 25). Despite the reconstructed benevolent identity, the colonial state relies on continual Indigenous disenfranchisement through tools of law, urban planning, and industrial development which physically, narratively, and legally alter

1. Pompeu Fabra University, Spain, serafina.appel@gmail.com / seraphine.appel@gmail.com

connections and claims to space. The examples that follow illustrate how the notion of reconciliation is aestheticised, and how alterations of natural and built landscapes affect the atmosphere through redescribing relations to space.

Reshaping the Land

The Okanagan Valley is an arid desert-like grassland landscape, but was marketed to settlers in the early 1900s as a lush Eden-like oasis. John Wagner (2008) shows how Okanagan fruit boxes quickly coalesced around the image of orderly rows of sun-drenched fruit trees backed by panoramic views of the lake and mountains. As well as the displacement of the people that lived there, creating this rentable aesthetic required extensive irrigation and other physical alterations such as the straightening of rivers, resulting in an environmentally unsustainable aesthetic. Agricultural development which began as a tree-fruit industry has now shifted to vineyards, and the new leisure economy of wine tourism and golf courses in addition to the orchards represents a variation on the theme. This oasis aesthetic serves a colonial economy and contrasts with the arid landscape known by the Syilx who are Indigenous to the valley.

Replacing the natural landscape with marketable landscape aesthetics alters subjective emotional relationship to land. It was developed as a marketing tool to attract settlers, providing a ready-made European perspective as well as a charter for colonisation and ecological transformation (Wagner, 30), securing settlers to the aesthetics of space because their arrival is intrinsically linked to its existence. Settler land use has also been described as superior, as Indigenous land use has often been characterised as seasonal, nomadic, non-agricultural, or otherwise not intrinsically linked to specific plots of land, whereas agriculture is inherently sedentary, and its connectedness to land has made it a tool to organise space and a symbol of settler identity.

Staging, Renaming, and Historical Erasure

One of Canada's most visited attractions is a group of nine totem poles at Brockton Point in Stanley Park, Vancouver. This is unceded territory of the Coast Salish peoples; home to the Squamish, Musqueam and Tsleil-waututh, it was never signed over in treaty. The villages of Xwáyxway and Chaythoos were first occupied in 1888 and the last residents lost their land claim at the Supreme Court in 1925 (Barman, 2007). The Totem poles were bought from Indigenous groups elsewhere and the only local totem pole, by Robert Yelton of the Squamish Nation, was erected in 2009. Yelton (2015) describes the battle over the placement at Brockton Point, where he asserted that he would only situate it there, in front of where his grandparents' home once was, where his mother was born. He expressed the importance of the connection to place, while the city pushed for an alternative location, prioritising spectacle.

Indigenous art and aesthetic symbols are featured prominently in imaginal space, and I suggest that this functions to bolster the image of the inclusive state as well as to incorporate indigeneity into national identity to legitimate the country's heritage. This symbolic prominence functions to strengthen the politics of allowance and apology as well as the elimination/preservation logic that Wolfe observes, which is necessary for the logic of replacement. Where there is a replacement of people and environment, symbolic indigeneity is reinstated to legitimise the colonial state. Renisa Mawani argues that these visible markers are a reminder "that while Canada no longer [has] an 'Indian problem', it [does] indeed have an 'ancient past'" (2004, 44). Natalie Baloy (2015) conducted interviews with Vancouver residents on the Squamish Nation's proposal to change the name of Stanley Park back to Xwáyxway, and many of the responses

illuminated the anxiety generated by the inconsistencies between the ‘politically correct’ identity of the benevolent state and the emotional importance of naming. That this was not even a land claim but a name reclamation proposal exposed how crucial and thorough the attitude of replacement is to the project of colonialism and how destabilising is the reminder or creation of Indigenous spaces. Baloy observes that the “spectral colonial past and uncertain future make space and time feel uncanny and ‘out of joint’ in the city” (227), gesturing to the palpability of this affective atmospheric anxiety in the felt body.

Aesthetics of Reconciliation

The physical stage and the narrative backdrop of Canada’s reconciliation rhetoric, I suggest, largely aestheticises reconciliation in a perpetuation of the colonial project. Examples of this can be identified in the proceedings of the Truth and Reconciliation Commission (TRC).² The mandate states that there is “an emerging and compelling desire to put the events of the past behind us so that we can work towards a stronger and healthier future.”³ David Garneau argues that when read as a colonial desire, this constitutes a continuation of the settlement narrative (in Robinson et. al., 2016, 31). This is not to say that the intention is insincere nor that the initiatives are not constructive; many have expressed that they have offered rich opportunities for healing. However, because it was a legal settlement rather than a state-led initiative, testimony came almost exclusively from survivors.⁴ Intimate stories and communication through the arts were highlighted throughout, the visceral impact of which can lead to a settler-witness consumption of Indigenous trauma which offers what Roger Simon describes as “idealisations of empathy, identification, and facile notions of solidarity that simply promote settler state citizenship” (2013, 136), collapsing the distance that might otherwise cause them to question their complicity (Robinson and Martin in Robinson et. al., 2016, 12). Dominick LaCapra argues that this can lead to ‘empathic unsettlement’, which “places in jeopardy harmonising of spiritually uplifting accounts of extreme events from which we attempt to derive reassurance or a benefit (for example, unearned confidence about the ability of the human spirit to endure any adversity with dignity and nobility)” (2001, 41-42). Individuals may absolve themselves if they are confident that the government and churches are paying compensation. As stated by Taiaiake Alfred, “without massive restitution, including land, financial transfers and other forms of assistance to compensate for past harms and continuing injustices [...] reconciliation would permanently enshrine colonial injustices and itself a further injustice” (2005, 152).

Moreover, the ways that acts of apology are linguistically and culturally constituted are reflective of worldviews embedded in language - in this case, an inherent settler ontology. The language of ‘healing’, ‘forgiveness’, and ‘moving on’ place the burden of restoring relations on survivors and Indigenous peoples (Robinson and Martin in Robinson et. al., 6), but even more deeply-rooted are the underlying belief systems.

2. Active from 2008 to 2015 and established as a mandate of the Indian Residential Schools Settlement Agreement of 2007 between various residential school survivor groups, the Assembly of First Nations, various Church bodies, and Canada. The residential school system was a violent state- and church-led effort to destroy Indigenous communities and assimilate the children into Euro-Canadian society. Children were forcibly removed from their families to attend Christian boarding schools, and the physical, sexual, and psychological abuse, death, malnutrition, disease, and loss of culture and language are well documented, as is the subsequent intergenerational trauma. The last residential school closed in 1996.

3. See at: <http://www.trc.ca/about-us/our-mandate.html>

4. It could not accuse or hold perpetrators accountable as it had no powers of subpoena nor to offer amnesty.

Garneau argues that while “it acknowledges that the abuses were the result of (past) systemic policy, Canada does not do anything that would risk the integrity of current dominant structures. Because the system is premised on the eventual elimination of the Indigenous, it is cautious about recognising that it is in a perpetual relationship with First Nations, Métis, and Inuit, and so it imposes a time limit on ‘healing’” (in Robinson et. al., 33). Furthermore, ‘reconciliation’ itself is constrained by Christian concepts such as the spectacle of individual accounts (confessions) and healing narratives (forgiveness and penance), and non-Indigenous understandings of healing and closure (ibid.).

The physical stage of the proceedings also upholds assumptions of impending closure. Dylan Robinson and Keavy Martin consider the sensory provocations of the aesthetic choices such as the ambiance of rooms, the music and art included in the proceedings, and the arrangement of chairs to argue that the resulting “connection, interest, empathy, relief, confusion, alienation, apathy, and/or shock [...] worked powerfully to shape participants’ engagement” (2) and affect the bodies moving through these spaces. Knowledge is produced, conveyed, and understood through the body (11), and exploring “the actions of telling, making, talking, walking, sharing, giving, and receiving [...] [and] the ways in which such actions were read, witnessed, and understood by the multiple audiences that experienced them” (9) revealed unsurprisingly that the sensual experiences and responses differed in those carrying different personal and inherited experiences. As Gernot Böhme notes, an audience that experiences a stage set in roughly the same way must have a certain homogeneity, “a certain mode of perception must have been instilled in it through cultural socialisation” (2017, 30), and so it is crucial to question who has created these spaces, and for whom.

Decolonial Disruptions and the Body as a Site of Resistance

To resist the colonial attitude that desires full access, ownership, and visibility, Garneau emphasises the importance of cultivating distance and spaces of non-Indigenous inaccessibility, of creating ‘irreconcilable spaces of Aboriginality’ which includes a refusal of translations and full explanations (in Robinson et. al., 23) and disrupts this monopoly on ambiance.

Narrative Reclamation

In one potent moment of guerrilla revision, a residential school survivor identified the photographed children in a TRC archive display and began to add their causes of death with Post-it notes. Others began to do the same: correcting names, re-identifying former students in terms of their kinship relations rather than their status as institutional wards, identifying those who never returned home, and adding stories of what happened later in life (Angel and Wakeham in Robinson et. al., 2016, 119). These Post-it amendments disrupted both the archival nature of the museum-like spatial structure and the colonial narratives in what had been framed as a benevolent sharing of images from a nurse’s personal archives.

In Robinson’s encouragement of public expressions of sovereignty that illuminate the colonial erasure of Indigenous spaces, he cites the group Ogimaa Mikana, who visually redescribed the landscape by renaming street signs and historical plaques in Toronto with Indigenous histories of place. They directly address the public through signage that asks: “‘Welcome to our community. How do you recognise it?’ Through this address, the readers are asked not whether they recognise Anishinaabe sovereignty and history of the location, but rather how they do” (2016, 61). This reclamation work contrasts with the state-sanctioned memorial plaques which, although they acknowledge Indigenous histories, read as odes rather than recognition of contemporary

Indigenous presence. “As Maria Campbell states with reference to a commemoration ceremony held at Batoche: ‘There’s a plaque, but the people still have no land’” (Robinson and Martin, 1).

The Disobedient Body

Disruption of colonial space and insistence on illuminating its inherent violence is continually being enacted through the disobedient bodies of decolonial resistance. The state asserts itself by monopolising space, demonstrating its unwavering ownership, and policing spatial social structures. Saladdin Ahmed (2019) argues that the state affirms its omnipresence through the visual proliferation of its marks that often function solely as a reminder that the state oversees that space: a sign in the forest, statues and monuments in public squares, the imposing architecture of government buildings (92); and “[t]he body is free to be in public space only insofar as it does not represent a threat to the ownership of the means and relations of spatial production” (59).

The marginalised have long been aware of the politicality of the body, that the mere presence of their bodies can expose the fragility of the spatial order. Indigenous assertions of sovereignty often reject the colonial state’s jurisdiction over physical and legal space, such as ignoring the international border and blockading economically-important sites. Negating the state monopoly on space and illuminating the spatial foundations of these systems of oppression, the space of the deviant or resistant body comes under attack when it questions the demarcations of the legitimate use of space and the body’s place in it. The disobedient body is met with disproportionate militarised force, as we have seen throughout the history of decolonial resistance and most recently in the colonial response to the Wet’suwet’en-led resistance of 2020. The precarity of the state’s spatial economy is revealed when its ownership is challenged through demonstration or through simply living in a way which accomplishes any de-bourgeoisification of space (Ahmed, 58).

Settler Colonial Atmospheres

Atmosphere - “feelings poured out into the surrounding space” (Griffero, 2014, 10) - mediates between the environment and the body. This can be violent, fostering the participation of certain bodies and exclusion of others, and the state desires to control this atmosphere to enforce which kinds of lives can be lived comfortably and safely. Physical and narrative alterations of space and history, such as those illustrated in this article, redescribe connection to land to discredit Indigenous ownership, and space and time are further redescribed through the historicisation of colonialism which obscures ongoing colonial efforts with an aestheticised staging of reconciliation. The project of replacement continues today through attempted assimilation, segregation through city planning, incarceration, enforcing poverty-inducing conditions, and the crisis of uninvestigated murders and disappearances. I argue that the orchestrated replacement of Indigenous people and spaces with a spectacularized aesthetic manifestation of manicured Indigenous presence - such as in the case of the totem poles at Brockton Point - is a phenomenon that plays prominently in this politics, and that this historicisation of colonialism is further reinforced by the closure that reconciliation promises. The dissonance between the stage-value⁵ of the polite state and the reactions to decolonial resistance generates perceptible insecurity which becomes clear whenever the colonial state is challenged, and manifests in colonial expressions of

5. Gernot Böhme (2017) proposes that the new production of stage-value bolsters aesthetic capitalism, offering an economic understanding of a staged space or lifestyle, which I suggest is applicable to national identity and the apologetic state.

defensiveness and emotional uneasiness in the state itself and in individual settler citizens. This was exemplified by the responses of Vancouver residents to Baloy's questions about place renaming, revealing the anxiety caused by this tension between their acknowledgement of Indigenous connection to land and, perhaps, fear of land repossession (219). Atmospheres are not the causes of emotional influence but the influence itself (Griffero, 120), and it is significant who has created our environments and who they have been made for. I have suggested the atmospheric violence of the Canadian state, that reactions towards the disobedient body reveal colonial insecurities, and that the body which challenges the spatial order is an existential threat to colonial claims to space and its structures of atmosphere.

References

- Ahmed, Saladdin. *Totalitarian Space and the Destruction of Aura*. New York: SUNY Press, 2019.
- Alfred, Taiaiake. *Wasáse: Indigenous Pathways of Action and Freedom*. Peterborough: Broadview, 2005.
- Baloy, Natalie. "Spectacles and spectres: settler colonial spaces in Vancouver." *Settler Colonial Studies*, 6.3 (2015): 209-234.
- Barman, Jean. "Erasing Indigenous Indigeneity in Vancouver." *BC Studies*, 155, Autumn 2007.
- Böhme, Gernot. *The Aesthetics of Atmospheres*. Edited by Jean-Paul Thibaud. New York: Routledge, 2017.
- Coulthard, Glen. *Red skin, white masks: Rejecting the colonial politics of recognition*. Minneapolis: University of Minnesota Press, 2014.
- Griffero, Tonino. *Atmospheres: Aesthetics of Emotional Spaces*. Translated by Sarah de Sanctis. New York: Routledge, 2014.
- LaCapra, Dominick. *Writing History, Writing Trauma*. Baltimore: Johns Hopkins UP, 2001.
- Mawani, Renisa. "From Colonialism to Multiculturalism? Totem Poles, Tourism, and National Identity in Vancouver's Stanley Park." *Ariel: A Review of International English Literature*, 35.1/2 (2004): 31-57. Robinson, Dylan and Martin, Keavy (eds.). *Arts of Engagement: Taking Aesthetic Action In and Beyond the Truth and Reconciliation Commission of Canada*. Waterloo: Wilfrid Laurier University Press, 2016.
- Simon, Roger. "Towards a Hopeful Practice of Worrying: The Problematics of Listening and the Educative Responsibilities of Canada's Truth and Reconciliation Commission." In *Reconciling Canada: Critical Perspectives on the Culture of Redress*, edited by Jennifer Henderson and Pauline Wakeham, 129-142. Toronto: University of Toronto Press, 2013.
- Wagner, John. "Landscape Aesthetics, Water, and Settler Colonialism in the Okanagan Valley of British Columbia." *Journal of Ecological Anthropology*, 12.1 (2008): 22-38.
- Wolfe, Patrick. "Settler Colonialism and the Elimination of the Native." *Journal of Genocide Research*, 8.4 (2006): 387-409.
- Yelton, Robert. Interview by Ryan Pugh, Simon Fraser University, February 12, 2015. "Robert Yelton 'Squamish Nation Cultural Heritage.'" *Indigenous Environmental Activism 2015*. Oral Testimony Archivists: Robyn Weasal Bear and Don Harrison. Principle Investigator: Dr. Annie Ross.

Sensing Vulnerability, Listening to Urban Atmosphere

The Political Possibility of Participatory Sound Art Practice Within Palermo's Suburbs

Nicola DI CROCE¹

***Abstract.** The article discusses how the sonic environment reflects and shapes the atmosphere of vulnerable urban areas. It aims to investigate the potential of critical listening as a tool for attuning and exploring everyday public feelings, and it seeks to engage collaborative sound-art practice as a relevant means for empowering local communities. The contribution provides the outcomes of a case study developed in Palermo at “Quartiere San Giovanni e Paolo” where the author was involved in a public art process as researcher and sound artist, and developed a participatory project named Voci Fuori Campo. The action-research uncovered unprecedented perspectives on the relationship between vulnerable neighborhoods, power hierarchies, social inequalities, and gender issues.*

***Keywords.** Sonic Environment, Social Vulnerability, Participatory Sound Art Practice, Policy Analysis, Design*

Social Vulnerability and Collaborative Design Processes

The term vulnerability, used in social sciences in opposition to resilience, describes the exposure to adverse impacts and triggers including social exclusion and natural disasters (see Alwang et al., 2001). In particular social vulnerability deals with the incapability experienced by individuals and communities to endure problematic issues (such as poor living conditions, racial, religious, and gender issues) that are not easily addressed by institutions. Particularly, it spreads in areas undergoing transformations, affected among other factors by depopulation, segregation, and expiration of local identities.

By acknowledging the urban atmosphere of a vulnerable neighborhood, the contribution shows how the sonic environment serve to make an area attractive, as everyday sounds are crucial for the proliferation of urban vibrancy and livability (Atkinson, 2007). Therefore, it seeks to demonstrate how climates of tension and social exclusion could be sensed (and specifically listened to) within a vulnerable area, for “affective atmospheres” reverberate in public space and influence its pleasantness (Thibaud, 2015). In this regard, the investigation of everyday sound-related public feelings (Gallagher and Prior, 2013) is presented as the core of the participatory sound art intervention Voci Fuori Campo (namely “voices out of bound”), which points at the empowerment of local communities, and aims to impact on the urban policy level (see Davies et al., 2013).

During fall 2019, Palermo-based cultural association “Sguardi urbani,” together with a team of artists, researchers and designers, launched the project “Riconessioni” in

1. Università Iuav di Venezia - Department of Architecture and Arts, S. Croce 1957, 30135 Venezia, Italy, ndicroce@iuav.it

the framework of the Italian Ministry of Culture's funded action "Creative Living Lab." The project specifically aims to deepen the social vulnerability of Palermo's suburbs, and concentrates on "Quartiere San Giovanni e Paolo" (usually named as CEP). CEP is a public housing neighborhood located in the outskirts of the city, which suffers from poor living conditions, illegal occupation of public properties, and a high rate of criminality. All these issues result in a mostly abandoned and underused public space, which the project intended to revitalize through a collaborative process and a series of public art interventions. The cultural association assumed the bocce court situated in the middle of the abandoned main park - entitled to Peppino Impastato, victim of the mafia, and surrounded by unused greenfield and illegally occupied buildings - as the symbolic center of its revitalization process.



Figure 1. The bocce court situated in the middle of Peppino Impastato park, Nicola Di Croce, November 2019

Sguardi Urbani's approach makes use of collaborative design as it addresses to engage local communities by: listening to their expertise (Rohe, 2009), and implementing place-based knowledge (Deakin and Allwinkle, 2007), thus building collectively a shared image of vulnerable areas. On this basis the sound art project *Voci Fuori Campo* acknowledges that public relational art supporting participatory practice has proven to strengthen inclusiveness within wider processes of urban regeneration² (Sharp et al., 2005). Likewise, it recognizes to what extent the contribution of a collaborative approach to urban planning through sonic environment's analysis and sound art practices has recently increased (Claus and Pak, 2019; Lappin et al., 2018). Specifically, collaborative sound art practices have demonstrated the capability to deepen the

2. *Voci Fuori Campo* was the first of three different workshops developed in the framework of the project "Riconnessioni." For further informations visit *Sguardi urbani* cultural association's website. See at: <https://sguardiurbani.com/riconnessioni/>

social and cultural basis of vulnerable communities (Ultra-red, 2012), thus contributing to re-orient future urban interventions.

Collaborative sound art practice's focus is the empowerment of citizens and local institutions through the raise of critical listening, as a crucial device for community building (Farinati and Firth, 2017), then for the enhancement of social coexistence (LaBelle, 2018). Accordingly, the action-research and participatory sound art project *Voci Fuori Campo* promotes the development of listening awareness as a political possibility for citizens to enhance a deeper understanding of the social dynamics entangled within a vulnerable area's sonic environment. By focusing on listening practice, the project establishes a new connection between citizens and their everyday sonic environment. Such engagement is assumed as the starting point of a collaborative debate that addresses local development, as it prioritizes a place-based approach, it invites non-experts to contribute in decision making process, and it constitutes an essential preliminary step toward sustainable and inclusive urban regeneration.

Voci Fuori Campo: a Participatory Sound Art Project

The project *Voci Fuori Campo* took place during November 2019 and used a mixed-method approach that included: informal group interviews, soundwalks, field recordings, roundtables, collaborative design, and a final participatory sound performance.

The first workshops were open to youngsters at different ages (14-16, and 16-18) all attending the cultural association "San Giovanni Apostolo" sited in the local parish, which offers playgrounds, security, social services, and organizes classes dedicated to younger affected by learning issues, and/or coming from difficult family situations. The workshop proposed soundwalks and open discussions aiming to raise youngster's sonic awareness, and reached very interesting findings. It asked them to critically engage with their everyday sonic environment, and encouraged to acknowledge their public feelings connected to the area. In particular the teenagers noticed how the neighborhood's pedestrian streets were very often populated by local inhabitants (exclusively men) enlivening public space through their talking and particular tones of voice; while the most silent and out of the way areas were perceived as potentially dangerous, for they were used as gathering places by other (not recommended) groups of people. Close to the busier roadways the group noticed how the sonic environment was dominated by scooters' engines - often souped up by their owners in order to be as loud as possible and drawn people's attention. Another characteristic sound coming from the roadways was the car stereo's music, which was often diffusing "neomelodico" throughout the neighborhood: a style originally coming from Naples and widespread in Palermo.

The following workshop engaged a group of woman attending the sport activities organized by the local association "San Giovanni Apostolo." Through an open discussion regarding the everyday sonic environment perceived by those women a strong feminine perspective emerged, and underpinned the rest of the research. In particular, woman reflected upon their habit to chat with their neighbors from window to window, and to rarely walk down the street except for shopping during the morning. By reflection on their everyday activities they realized how they normally perceive the neighborhood's sonic environment mostly from their homes. Since they constantly feel insecure about going out - due to frequent acts of intimidation - they contribute only in part to the area's everyday sonic environment, which is dominated by man's voices and activities over day and also overnight (for example through illegal car competitions).

After the first workshops a series of soundwalks (partly guided by groups of teenagers) contributed to critically engage with CEP's sonic environment. Widening the circle of the previous explorations, the soundwalks reached the borders of the neighborhood, where the shopping mall "La Torre" is located. Here it was possible to listen both to the music spread by the shopping mall's parking lot, and to the activities of many of those youngsters that were meeting and playing in a safer and more controlled area (compared to most of neighborhood's spots).

The following soundwalks reached CEP's inner roads, where street vendors usually pass by with their trucks twice a week addressing their distinctive call to housewife through loud megaphones. Again, street vendors' male voice explicitly refers to woman supposed to be at home, and remarked to what extent woman's role in public space's sonic environment is constantly rejected. Additionally, the residential inner streets were extremely quiet, and from the backyards it was possible to listen to watchdogs barking at passersby, caged birds, and chickens scratching and pecking on the ground. These elements stood for a resisting rural environment which permeated private spaces' uses, and contrasted evidently the massive gated complex built alongside the CEP. There, a privatized and surveilled open space discouraged any spontaneous everyday practice to take place.

Finally, a performance aiming at recomposing the archive or field recordings taken during the workshops and soundwalks was presented to the participants and to all the CEP's inhabitants. The bocce court turned into a sonic field in which a short description of every single sound of the archive - such as "street vendor" or "scooter engine" - was drawn on the playground through a collaborative design process. The idea was then to playback during the performance the field recordings through an audio system as soon as a bowl would reach the corresponding bocce court section.

Kids flocking and willing to help were involved in coloring the sections, all of which took a title and a number for a total of 33. Before starting, four simple rules explained the participants how to interact with the sounding bocce court: (i) one single player at the time can enter the field and cast the bowl; (ii) every section drawn on the bocce court corresponds to a field recording: the bowl entering the section activates that specific sound; (iii) the number of bowls playing simultaneously is limited to three, so if all the bowls have been already casted the player can select which one to withdraw from the field and cast it again; (iv) after casting the bowl the player is invited to leave the bocce court and listen to the sonic environment produced by her/his move. On the other end of the field I was monitoring the sections reached by the bowls, and I was ready to play back and mix the corresponding sounds through a computer connected to an audio system. The overlapping of field recordings was then resulting from three sounds at the time, that were changing one after the other throughout the performance. The event took place during the weekend and was advertised all over the neighborhood; in the end an open party provided music, free food, and beverages for all the participants.

Empowering Local Community by Raising Sonic Awareness

The performance lasted about half an hour and was enthusiastically received by the participants³. In particular, youngsters were fascinated by the way they could identify their everyday sounds or even their voices within the stream of sounds, and cast the

3. An excerpt of the performance is available at *Sguardi urbani's* webpage. See at: <https://soundcloud.com/user-244842146/performance-suoni-in-campo>

bowl few times in their favorite spots (such as those referring to the association playground or the pedestrian streets). More generally the participatory process succeeded at de-contextualizing and re-actualizing sonic fragments that represented some of the most critical issues concerning the neighborhoods: the polarization of public space uses, the ouster of the feminine presence within the sonic environment, the difficult relationship between teenagers and dangerous urban spots. By using the bocce court as the core of the event the performance also served to shift the neighborhood's image of abandonment toward a new collaborative re-appropriation of public space.

In summary, the overall project, and specifically the final performance, initiated a long process of re-signification of the neighborhood's commons. In fact, by raising inhabitants' sonic awareness and by stimulating a participatory approach to the critical engagement and recomposing of urban sonic atmosphere, locals were asked to confront each other and to imagine a future vision for CEP. Thus, the target was to challenge the sounds that were mirroring those social issues usually taken for granted by the inhabitants, yet strongly emerging during the sonic environment's investigation and the following discussions. From this perspective *Voci Fuori Campo* represented an empowerment device that understood listening practice as a powerful emancipatory tool. A device that contributed to raising consciousness and stimulating social change within a socially vulnerable neighborhood that (like CEP and many others) have long suffered the lack of social assistance, high school-drop-out and unemployment rates, and a regular absence of urban safety.

The process initiated by *Voci Fuori Campo* was, in conclusion, the first step toward a critical reframe of CEP's sonic environment. The sonic investigation shared with local inhabitants during the workshops and soundwalks underlined an environment dominated by a strong male dominance over woman and the most vulnerable. Therefore, the open discussions and the final performance intended to foster a "sonic possible world" (Voegelin, 2018) where the symbols and schemes of prevarication could first be re-oriented and then shared with the younger generations, which inevitably absorb and reproduce the detrimental mainstream narrative enacted by the neighborhood.

References

- Alwang, Jeffrey; Paul B. Siegel, and Steen Jorgensen. *Vulnerability as Viewed from Different Disciplines*. Social Protection Discussion Paper Series, 2001
- Atkinson, Rowland. "Ecology of Sound: The Sonic Order of Urban Space." *Urban Studies* 44, n. 10 (settembre 2007): 1905-17. <https://doi.org/10.1080/00420980701471901>
- Claus, Caroline, and Burak Pak. "Masterstudio_L28 and the Vibrational Nexus. Urban sonic design research as critical spatial practice." In *Sonic Urbanism*, edited by George Kafka, Sophie Lovell, Fiona Shipwright. London: Theatrum Mundi, 2019.
- Davies, William J., Adams Mags D., Bruce Neil S., Rebecca Cain, Angus Carlyle, Peter Cusack, Deborah A. Hall, et al. "Perception of Soundscapes: An Interdisciplinary Approach." *Applied Acoustics* 74, n. 2 (February 2013): 224-31. <https://doi.org/10.1016/j.apacoust.2012.05.010>
- Deakin, Mark, and Sam Allwinkle. "Urban Regeneration and Sustainable Communities: The Role of Networks, Innovation, and Creativity in Building Successful Partnerships." *Journal of Urban Technology*, 14:1 (2007):77-91. <https://doi.org/10.1080/10630730701260118>
- Farinati, Lucia, and Claudia Firth. *The Force of Listening*, Berlin: Errant Bodies Press, 2017.

Gallagher, Michael, and Jonathan Prior. "Sonic Geographies: Exploring Phonographic Methods." *Progress in Human Geography* 38, n. 2 (April 2014): 267-84.
<https://doi.org/10.1177/0309132513481014>

LaBelle, Brandon. *Sonic Agency: Sound and Emergent Forms of Resistance*. London: Goldsmith Press, 2018.

Lappin, Sarah; Gascia Ouzounian, and Rachel O'Grady. *The Sound-Considered City: A Guide for Decision-Makers. Recomposing the City*. Belfast, 2018.

Rohe, William M. "From Local to Global: One Hundred Years of Neighborhood Planning," *Journal of the American Planning Association*, 75:2 (2009): 209-230.
<https://doi.org/10.1080/01944360902751077>

Sharp, Joanne; Venda Pollock, and Ronan Paddison. "Just Art for a Just City: Public Art and Social Inclusion in Urban Regeneration." *Urban Studies*, 42: 5/6 (2005): 1001-1023. <https://doi.org/10.1080/00420980500106963>

Thibaud, Jean-Paul. "The Backstage of Urban Ambiances: When Atmospheres Pervade Everyday Experience." *Emotion, Space and Society* 15 (May 2015): 39-46.
<https://doi.org/10.1016/j.emospa.2014.07.001>

Ultra-red. "Protocols for the Sound of Freedom," in *Ultra-red: nine workbooks 2010-2014*. Berlin: Koenig, 2014.

Voegelin, Salomé. *The political Possibility of Sound: Fragments of Listening*, London: Bloomsbury Publishing, 2018.

Ambiences of Empathy and Fear

Cartography of Refugee Encampments in Mainland Greece 2019

Sophia VYZOVITI¹,
Thodoris CHALVATZOGLOU²

Abstract. Divergent social sensitivities deriving from the ongoing since 2016 refugee crisis in Greece have undoubtedly redefined the landscape of ordinary life accentuating contradictions to the extreme. Focusing on the largest refugee reception facilities of mainland Greece Eleonas in Athens, and Diavata in Thessaloniki, we discuss social and spatial practices responding to refugee accommodation and integration, three years past the peak of the crisis. Featuring original architectural documentations based on situated research, the paper addresses methods of investigation within camps and speculates on the impact of the spatial layout on the redefinition of refugee identity.

Keywords. European Refugee Crisis, Camps, Shelters, Inhabitation, Agency

Uncanny Protocols of Philoxenia

By mid-2016, European Refugee Crisis had stirred a controversy in collective sensitization. A dichotomy in public opinion, extrapolated to the extreme as an impossible compromise between the “humanitarian idealization of refugees and the fear of Islamization of Europe” (Žižek, 2016). While anti-immigration far right parties capitalized their political assets on the overwhelmingly growing fear of refugees, solidarity movements across Europe cultivated empathy, best exemplified by the practices of *Refugees Welcome International*. Autonomous solidarity initiatives around Greece eagerly responded, while many cases of individuals hosted Syrian families in their own homes. That is what Derrida calls an ‘unconditional hospitality’: the capacity to “open up my home and give not only to the foreigner, but to the absolute, unknown, anonymous other, and that I give place to them, that I let them come, that I let them arrive, and take place in the place I offer them, without asking them either reciprocity or even their names” (Derrida, 2000).

However, the institutional answer on migrant accommodation was far from the creation of a welcoming ambiance. It is also true that media and extreme right parties in Greece exaggerated segregation, cultivating exclusion and xenophobia. The humanitarian apprehension of refugees as victims of enforced displacement suffering of personal loss and trauma, appears to be annihilated in their encampment, their treatment as *urban outcasts*, as *undesirables* that need to be kept in *places apart*, out of civic sight. Yet, under the circumstances of a rather prolonged situation of emergency, encampment is an impossible but necessary compromise.

Philoxenia, the ancient Greek virtue of hospitality expressed in the cultural archetype

1. Associate Professor, University of Thessaly - Dept. Architecture, Greece, svizovit@arch.uth.gr

2. Postgraduate student, National Technical University of Athens, Greece, theochalv@hotmail.com

of Xenios Zeus, presupposes the creation of a lasting bond of friendship between the stranger (*xenos*) and the local (*xenistis*). The ambiance of *philoxenia*, the set of situated practices and ideas enhancing a place as *philoxenos topos* - a place of respect and honor bestowed to strangers- denoting an a priori empathetic stance to the other, is challenged in the protocols of refugee reception. Saturated with the fear of transgression and abuse of its bounds *philoxenia becomes uncanny*. In this framework *alloæsthesia* refers to the divergent social reflexes, the cultivation of contradicting sensibilities of empathy and fear, taking place within and around the landscape of emergency habitats.

In their constitution refugee camps in mainland Greece today combine securitarian and humanitarian principles. Managed by the United Nations High Commissioner for Refugees (UNHCR) camps are secured enclaves of registration and identification yet open reception facilities. There are strict protocols of entry to be followed by external visitors, while daily mobility of registered inhabitants is free. Despite their overtly mediated image of closed enclaves that demarcate exclusion, discrimination and marginalization, within them there is a plethora of activism; grassroots solidarity, artistic practices, national and international NGOs, that invigorate life in the camps and enhance their connectivity to the city.

The Janus-faced ambiance of camp environments

As Jean-Paul Thibaud claims “the notion of ambiance involves rethinking the relationship between the human organism and its environment,” grasping the “feeling of a situation” unleashing the potential of its “affective value” and establishing an “activist relationship with the world” by “sensibilising practice” (Thibaud, 2015). In this framework investigating camp ambiance encounters two methodological difficulties: overwhelming mediatization and limited access to the field. The mediated feeling of the camp conditions captured in the prolific number of photographs available on the world wide web is divergent and contradictory, it ranges from empowering to intimidating.

In the emblematic imagery of the newly erected refugee reception facilities in mainland Greece circulating in the national press and television, we encounter architectural expressions of what Mike Davis has described as an ‘ecology of fear’; dense cohorts of living containers, whose austere and immaculate whiteness behind barbed wire fences recalls incarceration facilities rather than dwelling settlements. The creation of such a generic image of the camps, a military spatial layout with impermeable borders, and day long surveillance, that nurtures fear produces a feeling of vulnerability and fragility among their residents, demarcates a sterile and disinfected environment were strangers (*xenoi*) are received. On the other hand, Al Jazeera’s article (Kritikou and Myrillas, 2015) praises the Eleonas open hospitality and promotes its connectivity to Athens ethnic communities, capturing in heartwarming photography their engagement in festivities such as the celebration of the Muslim holiday of sacrifice, Eid al-Adha.

Investigating inhabitation within encampments is a challenge to the researcher lacking the possibility of full immersion in the field that a volunteer, an NGO/UNHCR employee would be granted. The engagement with the social fabric necessary in ethnographic approaches was not possible in our case. We were limited to escorted visits within the camps of Diavata in April 2019 and Eleonas in November 2019, abiding to the visitor protocol of first reception facilities administration. During our four-hour-long field trips, we conducted unstructured interviews with camp management staff, observation through silent walks in the territory and employed photography to document

strictly urban and architectural features. It was clearly prohibited to photograph people or interact with them. The uncanny, heterotopic ambiance of the camp settlements affected us deeply, our time spent within was in fact an intense sensitive experience. Having delivered our passports at the gate we felt temporarily incarcerated. Observing life within the camps and gaining insight by discussing with staff encouraged us. Since the production of architectural models denoting patterns of inhabitation was our research objective, capturing the camps' ambiance became a medium of interpretation.

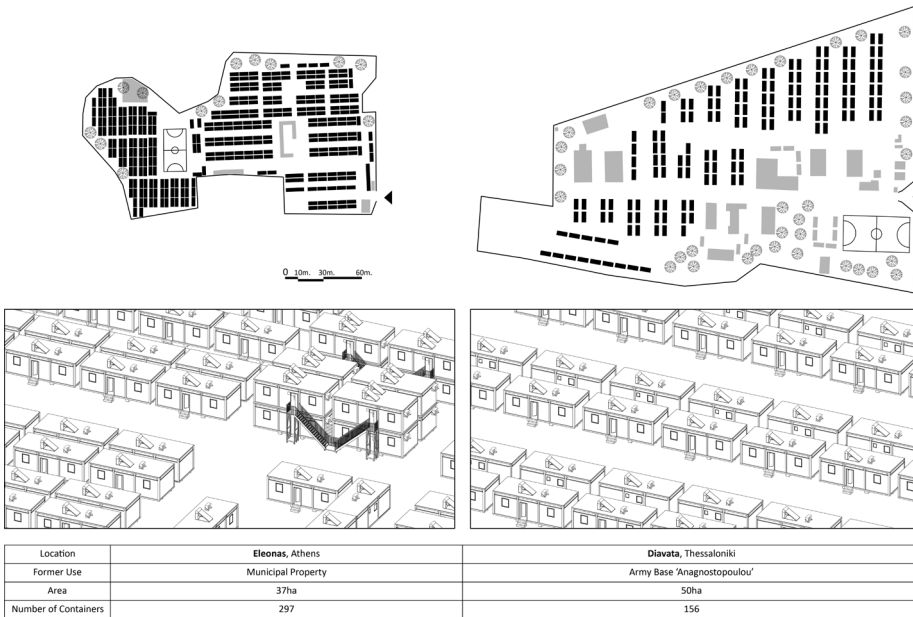

Figure 1. Urban Fabric Samples of Eleonas and Diavata Refugee Reception Facilities, Vyzoviti and Chalvatzoglou and Emseeh 2020

New Towns of Permanent Temporariness

Eleonas was established in August 2015 at the peak of European refugee crisis. It was designed as a model accommodation facility, open to host 700 people in 96 containers for a 3-day maximum stay (OECD 2018). Four years later, its capacity has tripled into 297 containers and its area has expanded hosting a multinational population of 1470 (UNHCR 2018). Diavata was set up in February 2016 in the premises of a former military base. Initially consisting of UNHCR Tents and IKEA Better Shelter units it got refurbished with container homes in 2017. At the beginning of our research project, it hosted 816 people (UNHCR 2018) in addition to 600 unofficially (according to interview). The necessity of refugee accommodation in Greece has not decreased since 2015. Project ESTIA, the Emergency Support to Integration and Accommodation Programme, funded by the [EU Civil Protection and Humanitarian Aid](#) provided 25.000 places within existing apartments and houses in the mainland and the islands. While both camps have reached their maximum capacity, they are most popular accommodation choices among the incoming population, receiving hundreds of applications.

Literature proves that emergency shelter frequently evolves into long-term settlement. Sandi Hilal and Alessandro Petti exemplify the condition of 'permanent temporariness' in the Palestinian Refugee Camps, some of which have withstood since the 1948

conflicts. In their words “Camps are established with the intention of being demolished. They are meant to have no history and no future; they are meant to be forgotten... Yet life and culture in the camp exists, and should be understood, beyond suffering and marginalization” (Hilal and Petti, 2018). The evolution of camps prolongs temporality, into a situation of emergency that becomes permanent.

Eleonas is highly congested, presenting a dense fabric in a military layout of rows, with few yet vibrant open spaces. Diavata presents ample open spaces and areas of green and it is well equipped with public facilities. As prefab dwelling containers replaced the UNHCR tents and IKEA better shelter units, a landscape of uncannily Cycladic-white volumes was created, perceived by the distanced observer as an elusive reminder of vacations past. The generic dwelling container depicts the extreme living conditions of refugees in these two largest camps of mainland Greece. A floorplan of 8,50 by 3,70 meters includes two bedrooms, a small kitchenette, and a bathroom. Originally designed to host 8 people, it can serve up to two families, groups of single mothers or single men. A double decker version is seen in Eleonas, adopted to cover the increasing need for shelter. The container is equipped with the necessary electric appliances, bunk beds, cooker, sink, air-condition units and hot water solar panels. It is plugged into the electricity and water networks of the camp.

Inhabitation as Agency

Michel Agier daims that camps should be considered “as new forms of urbanity,” as the “marginal borderlands at a global scale and as loci of politics beyond the existing national and urban frameworks” (Agier 2016). Therein lies the necessity to produce a cartography of their urban and architectural constitution. We speculate on the impact of spatial conditions upon the redefinition of refugee identity, not only as a victim whose liberty may be compromised in a humanitarian life support system, but as a biopolitical subject with origins, history, culture and intentions. We document the physical environmental setting of the camp recognizing its potential to support *agency*. We observe the camp’s *inhabitation* where subjects gain initiative through appropriations, customizations and modifications of the standard shelters and compounds.

During our field trips to the camps, we documented a series of additions and small expansions of the dwelling containers. In most cases, the metal frames of the bunkbeds provided were moved outside, freeing space in the bedrooms where mattresses were laid on the floors and lined with carpets. Relocated and dismantled the bed frames were used as building material to form storage and seating, to outline areas at the front of the dwelling combined with wooden pallets, chicken wire and recycled UNCHR tent material. In this way, porches and yards were created demarcating a threshold between the living interior and the public space. These typical vernacular in between spaces reveal the residents need to place making, to acquire a sense of belonging, expressing agency in the rearrangement and recombination of their allotted household goods. We can also note that a standard piece of furniture - the bunkbed- becomes a vehicle of transforming boundaries between private and public, an element to be reconfigured, unravelling an unintentional yet empowering aspect of Western design standardization.

Further appropriation patterns observed in Diavata include the conversion of a dwelling container into a mini market and one Falafel restaurant with a nylon covered open-air dining area. Small-scale business development capitalizes the awareness of a prolonged accommodation in a state of emergency. Toleration of ad hoc modifications can be appreciated as empathy from the side of camp managers, as if solidarity

towards refugees is expressed in allowing residents' appropriations that acquire the agency to transform their living environment.

In the self-made porches and front yards we observed ambient traces of inhabitation; humming birds in cages, occasional plant pots and cats, small groups of men having a coffee or others taking the sun in solitary dazed contemplation, women hanging washing and children playing between containers. The atmospheres emerging here, in their uncannily idyllic conduct are composed of the physical presence and the material expressions of refugees' cultural backgrounds. They are affective, dynamic, and fragile.

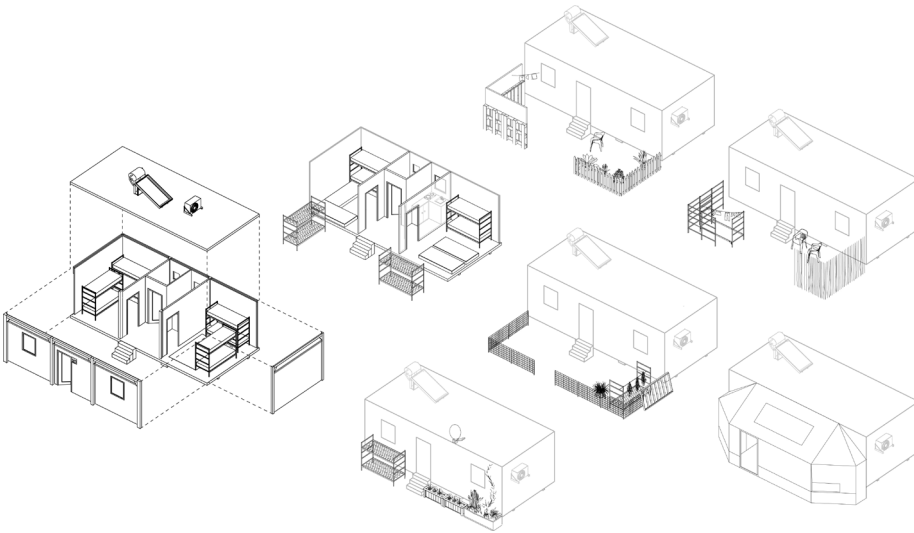

Figure 2. Generic Container Shelter and Modifications made by the Refugees. Vyzoviti and Chalvatzoglou and Emseeh, 2020

Between Camp and City

As new towns of permanent temporariness, Eleonas and Diavata have become the most popular accommodation choices among the incoming refugee population. Not only due to their allocation in proximity to urban centers but also by the quantity and quality of social integration programs taking place within their premises. Eleonas has incorporated in its operation a plethora of notable social integration and assimilation programs by creating powerful bonds with international and Athens based NGOs, non-profit organizations, local volunteer groups and artistic practices. In addition to those focusing on encouraging refugee agency in collaborative projects that humanize the arid, intimidating camp environment, there are a number of groups operating as bridges between the camp and the city. These practices contribute to the creation of belonging among the displaced subjects, the temporary and transient residents of the camps providing craftsmanship skills, know-how and opportunities for social integration. They verify the openness of these refugee reception facilities, mitigating their status as an apparatus of control that generates exclusion and marginalization. In addition to the residents self-made structures, NGO driven small-scale projects humanize the military architecture of the settlements through ephemeral structures and installations, creating clusters, neighborhoods and thresholds within the panopticon street layout, providing opportunities for social interaction and cultural exchange, establishing public spaces.

We could argue that Eleonas and Diavata, despite the extraterritoriality of their camp status, may be considered as places of belonging, with a brief history and a future of becoming interlinked with the city. Refugees social engagement is articulated in a dense solidarity network, demonstrating a non-hegemonic stance towards integration and assimilation, genuine empathy, and an almost unconditional hospitality.

References

Agier, Michel. "Afterword: What Contemporary Camps Tell Us about the World to Come" in *Humanity: An International Journal of Human Rights, Humanitarianism, and Development*, Volume 7, Number 3, Winter 2016.

<https://muse.jhu.edu/article/643498>

Derrida, Jaques. *Of Hospitality*. Stanford: Stanford University Press, 2000.

Hilal, Sandi and Petti, Alessandro. *Permanent Temporariness*. Stockholm: Art and Theory Publishing, 2018.

Kritikou, Ilena and Myrillas, Menelaos. "Greece's only refugee camp" Accessed February 12, 2016. <https://www.aljazeera.com/indepth/inpictures/2015/09/greece-refugees-camp-150928101923759.html>

OECD. *Working Together for Local Integration of Migrants and Refugees in Athens*, OECD Publishing, Paris; 2018. <https://doi.org/10.1787/9789264304116-en>

Thibaud, Jean-Paul. "The backstage of urban ambiances: when atmospheres pervade everyday experience." *Emotions, Space and Society*, Elsevier, 2015, pp. 39-46. Accessed June 26, 2020. <https://hal.archives-ouvertes.fr/hal-01560172/document>

UNHCR. Site profiles August - September 2018. Operational Portal Refugee Situation, Site Management Support. Accessed June 26, 2020.

<https://data2.unhcr.org/en/documents/download/66038>

Žižek, Slavoj. "What our fear of refugees says about Europe." Accessed June 12, 2018.

<https://www.newstatesman.com/politics/uk/2016/02/slavoj-zizek-what-our-fear-refugees-says-about-europe>

Preference Atmospheres in the 'Carioca Gaza Strip'

Manguinhos Favela Complex, Rio de Janeiro

Alex Assunção LAMOUNIER¹,
Vera Regina TÂNGARI²

Abstract. In this work we analyse preference atmospheres, investigating attractiveness and affectivity in conflict and vulnerability territories located in peripheral urban areas. Preference atmospheres are conceptions of world that contemplate multiple meanings attribution. This conceptualization is based on various studies, whose dialogues enabled a methodology development that has been applied, in this work, in the Manguinhos favela complex - the 'Carioca Gaza Strip', located in Rio de Janeiro's North Zone. Our analysis focuses on the so-called 'Marcelo Square', a small square constructed by local residents in a prohibited area, and Estrada de Manguinhos Street, symbolic open spaces of affectivity and attractiveness in an area widely known for its socio-environmental vulnerability.

Keywords. Preference Atmospheres, Vulnerability, Political Ecology, Favela Complex

Introduction



Figure 1. Manguinhos Location (left), Rio de Janeiro City Council, 2003, Google Earth, 2020; Aerial View (middle), Tângari, 2019; 'Marcelo Square' photos (right), Lamounier, 2019

This work aims to analyse preference atmospheres in urban peripheries, investigating attractiveness and affectivity in vulnerability areas located in Rio de Janeiro, Brazil.

1. Fluminense Federal University (UFF); Adjunct Professor of the School of Architecture and Urbanism (EAU-UFF); Postdoctoral researcher PNPD CAPES on the Postgraduate Program in Architecture (PROARQ/FAU/UFRJ); SEL/RJ-PROLUGAR-PROARQ/FAU/UFRJ Researcher; alex.a.lamounier@gmail.com

2. Federal University of Rio de Janeiro (UFRJ); Associate Professor of the Faculty of Architecture and Urbanism (FAU/UFRJ) and of the Postgraduate Program in Architecture (PROARQ/FAU/UFRJ); SEL/RJ-PROLUGAR-PROARQ/FAU/UFRJ Coordinator; vtangari@uol.com.br

The studied territory is Manguinhos, favela in the city North Zone, a high demographic density region and consolidated urban fabric, but with very few open spaces (Tângari, 2019). Popularly known as the 'Carioca Gaza Strip,' Manguinhos is characterized as a socioenvironmental vulnerability territory that suffers from diverse violence types, specially the everyday conflicts between State security agents and the parallel 'commands,' and the State large projects' neglect. In this context, 'Marcelo Square' and *Estrada de Manguinhos* Street stand out as local level attractiveness and affective symbolism open spaces.

Our photos show virtually no people and are limited in their visual angles. In the 'Carioca Gaza Strip,' pointing mobile phones or cameras towards particular scenes can carry risks, both for researchers and for the people photographed. Such 'invisibility' as an internal defense mechanism tell us much about Manguinhos's vulnerabilities.

Preference Atmospheres

The preference atmospheres concept is founded on dialogues between diverse knowledge fields'. Berque's contributions (1998, 84), which emphasize the importance of the "study of the (global and unitary) sense" which society attributes to the relations that it maintains "with space and nature," includes meanings and feelings connotations and points to the atmosphere idea. Griffero (2013, 3) defines "atmosphere" as the "sensorial skin of the city," resulting of the combination of urban configuration, sensory stimuli and sociocultural aspects that involves "topographic appropriation, spatial realization of the place and pragmatic negotiation." Thibaud (2015, 284) understands "atmosphere" in terms of "situated experience," "continuous creation" and perception related to the experience enabled by a given "situation." He points out that ordinary atmospheres can become memorable according to how they affect us. Thus, the attributions of "sense" (Berque, 1998) to an atmosphere may vary not only for different individuals, but also according to the different "experiences" (Thibaud, 2015) that this atmosphere provides to a person. Reflections concerning "ordinary landscapes" (Meinig, 1979) stress, by analogy, that not every attractive atmosphere is exceptional or widely diffused.

Preference atmospheres are understood as memorable atmospheres of everyday life. Although they may be diffused and recognizable to a certain extent in the collective imaginary, they are related to lived experience at a more intimate scale. Investigating for whom certain atmospheres are configured as a preference involves reflections on the "construction and maintenance of public space" as a guarantee of the "public freedom of democratic participation" (Arendt, 2007, 350-352); and the understanding of space as a product of interrelations, based on "plurality," permanently under construction, a product of relations necessarily "embedded in material practices which have to be carried out," (Massey, 2009, 29-32).

Preference atmospheres thus comprise a form of conceiving the world that contemplates attributions of sense that also involve the other's gaze contemplation. Their configuration and diffusion depend on how they enable multiple senses contemplation, related to different people. The proposed method enables preference atmospheres analysis shaped by the interrelations between four categories, described below.

Physical Components: concrete structural elements whose visible relations and attributions of sense define other categories: natural site; paths and connections; implantation; urban grid; structuring elements; buildings; remarkable details.

Visual Attributes: relations between Components, resulting in aspects referring to the

visible configuration: contrast; order; layers; visuals; rhythm³.

Attractiveness: that the area exerts on its surroundings and on the broader city context. It emerges from the Carvalho (2009) studies on "landscape's DNA" and its six dimensions: "morphological"; "institutional"; "social"; "economic"; "environmental"; "accessibility."

Sense: includes diverse atmosphere conceptions provided by the relations between the other three categories. Since it involves conceptions, emphasizes the atmosphere idea vague character. It is analyzed according to the Thibaud's criteria (2015) to understand atmosphere in terms of "diffuse quality": "sensitive unit"; "motor solicitation"; "time dynamics"; "shareable experience"; "affective tonality"; "diffuse field." In our studies, these criteria are analyzed considering the contributions of several other authors, presented below, in the explanation of each criterion.

The first three categories comprise aspects related to the landscape character. They combine previous methodologies that involve studies on atmospheres, landscapes of preference, affectivity, attractiveness, among others: the method for analyzing urban atmospheres developed by Lamounier (2006), based on several authors, especially Norberg-Schulz (1980), applied in open spaces in Londrina, medium city in the south of Brazil; the Yamaki's method for assessing railway landscapes in northern Paraná (Lamounier & Yamaki, 2012), also in southern Brazil; the method for analyzing the "landscape DNA" (Carvalho, 2009).

Sense, in turn, is derived from Berque's reflections (1998) on the 'sense' attributed to the relations between society and landscape, associated with the criteria of Thibaud (2015), already mentioned, amplified by the contributions of several other studies on atmosphere and related themes. It is the category that applies to the characterization of the atmosphere, as it involves the investigation of preferences in the use and appropriation of the territory, affectivity and various attractiveness factors.

So, this four categories method resulted from dialogues between different studies on atmospheres, landscapes and related themes, and field investigations in Rio de Janeiro's open spaces systems. Here we analyze the set of open spaces making up the territory selected for this work in accordance with the Sense category and its various components. The objective is to investigate conceptions that show residents preferences in a territory that, in the Rio's imaginary, evokes an atmosphere of risk and vulnerabilities.

Analytic Application

"Sensitive Unit"

Quality of generating memorable situations, distinguishing the atmosphere as a "coherent unit" (Thibaud, 2015). It involves first impressions, emotions, synaesthesia (Griffero, 2013); identity, legibility (Meinig, 1979); visual attributes (Yamaki, 2011); morphological and environmental dimensions (Carvalho, 2009); vivid character (Massey, 2009).

Contrasts between 'Marcelo Square' colorful playground and its tree canopies versus the rubble and constructions in the favela alleys; open spaces amid the buildings' density; flat local terrain versus distant hills; signs of sporadic care in despite a general aspect of neglect and abandonment; as well as the sensation of danger and the affective territories demarcations, are aspects of this atmosphere as a "sensitive unit."

3. *Physical Components and Visual Attributes are based on the Yamaki's Railway Landscapes evaluation method (Lamounier & Yamaki, 2012) and on Street Atmospheres analyse's earlier methodology (Lamounier, 2006).*

“Motor Solicitation”

“How [the atmosphere] convokes the plane of movement” and induces behaviour rhythms (Thibaud, 2015). It involves “suggestions of movement” (Böhme, 2013); “synchronized kinetic styles” (Griffero, 2013); structure, order, rhythm (Yamaki, 2011); ‘functional’ attractors (Carvalho, 2009).

‘Marcelo Square’ is a central place connecting open spaces and attractive elements in Manguinhos. The main movement axis connects two attractors: the Railway Station and *Estrada de Manguinhos* Street, bordered by a surprising commercial establishments diversity. On this axis, ‘Marcelo Square’ provides a place to pause and for children to play.

“Time Dynamics”

The diverse phases articulation that allow an atmosphere understanding in terms of “continuous creation” (Thibaud, 2015). It involves “permanent construction” (Massey, 2009); oriented evolution (Yamaki, 2011); structures and uses consolidation (Carvalho, 2009); imaginaries’ consolidation (Meinig, 1979).

The growth of trees and the wear of equipment are visible passage of time marks in ‘Marcelo Square’. In the immediate surroundings, the main transformation marks refer to the appropriations and their expressions, not always particularly visible, in the landscape. Next to the ‘society’ soccer pitch, the *Mães de Manguinhos*⁴ Movement, formed by women whose children have been killed by the police, has erected a small monument, called “Our Dead Have a Voice”⁵. Inaugurated in May 2016, it presents a 10 young people names updated list, aged between 13 and 29 years old, who were killed there or in the nearby area by State security agents in recent years. It marks the time of absence and struggle through resistance, justice and memory.

“Shareable Experience”

Quality of enabling the customs and values sharing that singularize an atmosphere (Thibaud, 2015). It involves determined uses attraction (Griffero, 2013); morphology, accessibility, sociability (Carvalho, 2009); “social characteristics” (Böhme, 2013); appropriations and diverse uses (Meinig, 1979); cultural aspects (Yamaki, 2011); different stories’ simultaneity (Massey, 2009).

‘Marcelo Square’ configures an interaction place between children from different localities (nearby and beyond the railway) who share similar everyday lives in terms of vulnerability. Under the Manguinhos strong sun, the benches under the trees invite people to rest in the square shaded areas, enabling interactions among the adult frequenters. However, barricades made from railway tracks, blocking the access of the police ‘*caveirão*’⁶, denote that the experiences shared there involve living with the daily risk of violence between the conflicting powers: the parallel ‘commands’ and the police.

“Affective Tonality”

This is related to the capacity to stir emotion and sensitivity, resulting from the combination of aspects like spatial configuration, activities and collective or individual conceptions (Thibaud, 2015). It involves meanings attributions (Berque, 1998); affective identification (Yamaki, 2011); familiarity sense (Griffero, 2013); different views recognition (Massey, 2009).

4. *Manguinhos Mother’s Movement*.

5. “*Nossos Mortos Têm Voz*.”

6. ‘*Big skull*’. Nickname given to the armoured car used by the Rio de Janeiro State Military Police.

'Marcelo Square,' an illegal appropriation under high voltage power lines, and the continuous fight for its maintenance, reveal a major local importance affective territory. In the square southern portion, the *Mães de Manguinhos* planted trees with plaques that remember their killed children. There, affectivity is associated with resistance and the fight for the absent children memory and dignity, as one of the mothers emphasizes.

"Diffuse Field"

The quality of "irradiating through the surroundings," atmosphere as a field that involves and connects its diverse components, although it cannot be delimited with precision (Thibaud, 2015). Atmosphere as an "influential presence" (Griffero, 2013); visual landmarks (Yamaki, 2011); range of imaginary (Meinig, 1979); space/time as a product of interrelations (Massey, 2009); landscape singularization (Carvalho, 2009). As a conflict territory between parallel power factions and police forces, Manguinhos is known in the media as the 'Carioca Gaza Strip'. However, elements of diffusion at a smaller scale that can configure preferences in its atmosphere are also observed. The attraction that *Estrada de Manguinhos* commercial axis exerts is a diffusion factor at local level. The affective senses, invisible at a larger scale, have become diffused thanks to the *Mães de Manguinhos* work. At the microscale, this can be perceived in the recognition of this region as a strong affectivity territory, with an atmosphere imbued with the senses of solidarity and the fight for the right to the city, the open spaces' enjoyment and life itself.

Conclusion

Constructed under high voltage power lines, 'Marcelo Square' denounces the neglect in the urban legislation in response to the vulnerable territories populations needs. The *Estrada de Manguinhos* commercial diversity emphasize that, even in risk areas, it is necessary to live. This both open spaces are key elements in the configuration of a microscale Preference Atmosphere that involves the nearby surroundings. There, where the more vitality places are also the most violent, the public space appropriation is a resistance form expressed in the affect symbolism and of being in the street.

Affectivity, attractiveness, symbolism indicate a preference atmosphere imbued with a resilience sense grounded in solidarity. Where exercising the right to the city involves contravening official regulations, appropriations and senses commonly considered marginal are essential components. It reflects the "process, hopefully subversive, of topographic appropriation, spatial realization of the place and pragmatic negotiation" (Certeau, cited in Griffero, 2013, 3), as a response to "distributive conflicts" and "environmental racism" (Alier, 2017) characteristics of vulnerability territories, primarily located in peripheral areas.

Acknowledgments

We thank the CAPES (Coordenação de Aperfeiçoamento de Pessoal de Nível Superior) for the financial support (postdoctoral scholarship PNPd PROARQ, 2019-2021); and also, to the Manguinhos residents: the architect and urbanist Patrícia Oliveira, Ana Paula Oliveira and the *Mães de Manguinhos* Movement, for the information made available.

References

Alier, Joan Martinez. *O Ecologismo dos Pobres: conflitos ambientais e linguagens de valorização*. São Paulo: Contexto, 2018.

- Arendt, Hannah. *A Condição Humana*. Rio de Janeiro: Forense Universitária, 2007.
- Berque, Augustin. "Paisagem-Marca, Paisagem-Matriz: elementos da problemática para uma geografia cultural." In *Paisagem, Tempo e Cultura*, edited by Roberto Lobato Corrêa, and Zeni Rosendahl, 84-91. Rio de Janeiro: EDUERJ, 1998.
- Böhme, Gernot. "Atmosphere as Mindful Physical Presence in Space." *OASE Journal for Architecture - building atmosphere*, v. 91 (2013): 21-32.
- Carvalho, Thereza; Coelho, Carlos. "O Capital Genético das Redes de Espaços Públicos: mutações e persistências." In *Ordem, desordem, ordenamento - urbanismo e paisagem*, edited by Gazzaneo, Luiz Manoel; Amora, Ana, 284-303. Rio de Janeiro: Coleção PROARQ/FAU-UFRJ, 2009.
- Griffero, Tonino. "The Atmospheric 'Skin' of the City." *Ambiances - International Journal of Sensory Environment, Architecture and Urban Space: enjeux - arguments - positions* (2013): 1-14.
- Lamounier, Alex. *Atmosferas de Preferência na 'Cidade Maravilhosa'*. Tese (Doutorado), Programa de Pós-Graduação em Arquitetura e Urbanismo, Universidade Federal Fluminense. Niterói: UFF, 2017.
- Lamounier, Alex. *Atmosferas de Ruas - identificação de componentes e qualidades em Londrina-PR*. Dissertação (Mestrado), Programa de Pós-Graduação em Geografia, Universidade Estadual de Londrina. Londrina: UEL, 2006.
- Lamounier, Alex; Yamaki, Humberto. *A Ferrovia e o Norte do Paraná: métodos para identificação de paisagens e estratégias à preservação*. Monografia (2º Edital de Pesquisa IPHAN - A Preservação do Patrimônio Cultural no Brasil). Rio de Janeiro: IPHAN, 2012.
- Massey, Doreen. *Pelo Espaço: uma nova política da espacialidade*. Rio de Janeiro: Bertrand Brasil, 2009.
- Meinig, Donald. *The Interpretation of Ordinary Landscapes: geographical essays*. Oxford: Oxford University Press, 1979.
- Tângari, Vera. *Rio de Janeiro: espaços livres e forma urbana* (in press). Rio de Janeiro: FAU-UFRJ, 2019.
- Thibaud, Jean-Paul. *En quête d'Ambiances: éprouver la ville en passant*. Genève: MétisPresses, 2015.
- Yamaki, Humberto. *Paisagem Cultural - notas de aula*. Programa de Pós-Graduação em Geografia, Universidade Estadual de Londrina. Londrina: UEL, 2011.

Ambiance Is Key in Any Innovation Strategy

A Case Study on Urban Design, Sensitive Ecology and Political Ecology

Diana SOEIRO¹

Abstract. In the aftermath of the 2008 financial crisis, innovation became a key element to promote economic growth. Cities started playing a significant role in promoting it quickly becoming torn between authentic urban regeneration processes and gentrification. We argue that ambiance, and the concept of atmosphere, is a highly-relevant strategic element able to trigger city development that avoids gentrification. We take the inner-city parishes of Marvila and Beato (Lisbon, Portugal) as a case study currently undergoing significant changes due to strong investment after decades of neglect.

Keywords. *Economics, Spatial Justice, Sustainable Development, Urban Regeneration*

Introduction

In the aftermath of the 2008 financial crisis, innovation became a vital element to promote economic growth recovering the approaches of economists John Keynes and Joseph Schumpeter (Dosi et al., 2016). Against the previous free market approach and a policy that privileged austerity in order to reverse the recession, Keynes' tactic that combined fiscal stimulus and expansionary monetary policy was slowly favoured. Economics Nobel Prize winners, Joseph E. Stiglitz (2001) and Paul Krugman (2008) widely voiced their support for this approach. Across Europe, a mix of austerity and expansionist approaches varied from country to country. However, as stability increased, when looking for an alternative to promote economic growth Schumpeter's strategy seemed to find a wider consensus: innovation economics. While Switzerland, Sweden, Finland, Germany and Austria were forecasted to emerge from the crisis with a relatively stronger innovative capacity, the United Kingdom and France, and to a larger extent, the Southern European countries, were likely to lose additional relative positions (Filippetti and Archibugi, 2011).

This paper² takes Lisbon (Portugal) as a case study, in particular the inner-city parishes of Marvila and Beato currently branded as the city's innovation centre. After decades of neglect, within the framework of a neoliberal policy agenda, they were targeted by local authorities as the city's main large-scale property-led urban regeneration project, encouraging investment partnerships between private and public parties (Tasan-Kok, 2008). Due to a stark contrast between its past and future, we claim that

1. Instituto de Ciências Sociais, Universidade de Lisboa (ICS-UL), Av. Prof. Anibal Bettencourt 9, 1600-189 Lisboa, Portugal, dianasoeiro.drphil@gmail.com

2. This research was supported by the H2020 European funding on the project "ROCK - Regeneration and Optimisation of Cultural heritage in creative and Knowledge cities", hosted by Instituto de Ciências Sociais, Universidade de Lisboa (ICS-UL), Av. Prof. Anibal Bettencourt 9, 1600-189 Lisboa, Portugal, under the Grant Agreement Number 730280.

the concept of ambiance is crucial to assess the strategy's success or failure. Our assumption is that ambiances can either promote or hinder urban development.

First, we describe the approach that Lisbon took in order to support innovation and what should we understand as innovation. Briefly, under the leadership of Lisbon's City Hall, a specific part of the inner city was circumscribed (Marvila and Beato) and decreed as the new innovation city centre. However, this particular territory over the 20th century went from a thriving industrial site, to an industrial abandoned site and since the 1980s it gradually came to accommodate different social housing projects. The experienced past and the decreed future of the territory embody a huge clash of ambiances. Both constrict each other, creating tension and bringing to surface vulnerabilities and inequalities. How to overcome this?

Second, we take as main reference Edward W. Soja (*Seeking Spatial Justice*, 2010). According to the American geographer space should not be perceived as passive but instead as an active element able to shape and define historical, anthropological, sociological and psychological circumstances. Expanding on this idea, the way-built environments are designed, create particular atmospheres that can either have a positive or a negative impact. In this paper we use 'atmosphere' and 'ambiance' interchangeably though we acknowledge that they stem from different schools of thought (Adey et al., 2013).

Thirdly, we evaluate up to what extent was Lisbon's territory-based innovation strategy well thought-out, providing a critical assessment that allows us to elaborate new solutions where past and present ambiances can flourish and grow. We argue that urban design and the creation of experiences where past and present ambiances are shared can be the key to demonstrate how sensitive ecology (Otálora-Luna and Aldana, 2017) and political ecology (Benjaminsen and Svarstad, 2018) can positively influence each other.

Lisbon's Innovation Strategy in the Aftermath of the 2008 Financial Crisis

In 1942, Schumpeter (2010) introduced the concept of innovation in economics, arguing that the core of economic growth were institutions, entrepreneurs and technological changes. Being perceived as disruptive for centuries, innovation experienced a resurgence with a positive connotation through the discipline of economics in the 19th century becoming associated with the idea of progress (Godin, 2015). Throughout the 20th century, innovation slowly transitioned to other disciplines, generating concepts such as "sustainable innovation," encompassing the economic, social and ecological realms (Boons and McMeekin, 2019) and the widely discussed concept of "social innovation" (Godin and Gaglio, 2019).

Recently, urban environments and in particular the concept of 'smart city' (SC) highlighted the importance of innovation, in particular associated with information technologies (ITs). Some authors, like Yigitcanlar (e.g. 2018) have argued for a multi-dimensional approach of the SC beyond technology.

We now describe our case study based on knowledge produced in the context of the project ROCK - Regeneration and Optimisation of Cultural heritage in creative and Knowledge cities (2017-2020), funded by the European Union under the programme Horizon 2020. The project area focused particularly in the riverside area but for contextualization purposes we refer to the totality of both parishes.

In May 2011, Lisbon's City Hall President, António Costa, invited Paulo Soeiro de Carvalho to create, lead and manage a new Economics and Innovation department (which Carvalho did, up until December 2018) (Barbosa, 2019). During this time, a strong investment

in entrepreneurship became evident at first spatially spread out across the city. Slowly the inner-city parishes of Marvila and Beato became the privileged innovation centre and started undergoing a process of urban regeneration, led by the concept of “creative city” where artists, co-working spaces and start-ups started being promoted by the municipality reconverting old and abandoned buildings, factories and warehouses, breathing new life to an area neglected for many decades (Azevedo, 2019).

Once a thriving industrial area, during the 20th century it gradually became less vibrant and overtime it has lost its place as a relevant industrial site. In the 1980s, it started being used as an area to relocate inhabitants from informal housing that had settled in the area overtime to apartment buildings - migrants from the North of the country that came to Lisbon in look for a better life during the 1960s and onwards; migrants from the old Portuguese colonies in the African continent, from the late 1970s and onwards. Also, other apartment buildings run by the City Hall, available as social housing were built to house other inhabitants because the area had a lot of available space to be urbanized. To this day, though located in the inner-area of the city it represents the most available land space in Lisbon.

Due to its historical past, the area’s landscape is highly heterogeneous featuring old churches and convents that span from the 17th century onwards: urban farms, still some informal housing, apartment buildings spread out across the territory that seem to create small islands within the territory. Due to its low mobility and accessibility it feels like an area that has stopped in time - though one would have a hard time identifying in which century. Since 2011, having become the new innovation centre of Lisbon, many buildings were rehabilitated and a new use and a new crowd were attracted to the area. Permanent residents and temporary new residents are also very different. Original residents of the area are generally characterized by a low education level, old age, and above average unemployment rate (ROCK Survey, 2020). New residents are college educated and innovators embodying new technologies, state of the art knowledge and the future. These two processes undergoing in the same area create a paradox that one would describe in traditional terms as one that hesitates between an urban regeneration process true to its historical past and gentrification where “foreign” elements to the area are favoured over old ones (Couch & Fraser, 2003).

The concept of ambiance is useful to both describe the paradox and to solve it.

Urban Regeneration vs Gentrification

Ambiance refers to a particular atmosphere, feeling or mood sparked by an environment. The archaeology of the concept of atmosphere, taken in this sense, has been undertaken by Soeiro (2020a) being traced back to J.W. von Goethe (1749-1832).

The Marvila and Beato area is currently characterized by a clash between two processes, urban regeneration and gentrification. This clash is palpable within the area both visibly and invisibly. Visibly, there are buildings being rehabilitated with a new assigned function; these attract a new crowd that features radically different socio-economic characteristics than its original residents; new cafes, bars and restaurants offer trendy and contemporary gastronomy; and a couple of luxury condominiums under construction signal the area’s ability to attract foreign investment. This creates a stark and palpable contrast with old residents that roam the streets and seat on park benches; social housing apartments; urban farms where animals can still be seen pasturing (mainly goats and sheep); old residents’ and worker’s associations, and *tascas* (Portuguese style pubs) are spread out across the territory where time seems to stand still.

In 2010, American Geographer Edward Soja (2010) proposed the concept of ‘spatial

justice' assigning space an active role. Space and the way space is designed has the ability to create and define historical, anthropological, sociological and psychological circumstances. In that sense, urban design has the ability to create different atmospheres that can either have a positive and negative impact, being able to segregate or harmonise. In the case of Marvila and Beato, how does the concept of atmosphere contribute to clarify the ongoing segregational process?

The area of Marvila and Beato is experiencing a clash of ambiances between the past and the present in such a way where each seems to be in each other's way. Having conducted observational research, engaged in informal conversations and participated in local meetings and workshops in the area during the project, it is possible to observe that a segregation process is undergoing at several different levels generating a fragmented territory where each element (or small set of elements) seems to exist on its own, cut off from any relation with its surrounding environment. This is physically visible and also very quickly perceived by the body and the senses that have a hard time making sense of the heterogenous landscape, constantly appealing to a sense of displacement.

1) Due to its low mobility and accessibility the area is cut off from the rest of the city; 2) Apartment buildings are placed with a sense of randomness, creating what seem to be small islands; 3) New rehabilitated buildings, temporary residents and luxury condominiums were carefully placed, either by the riverside (with a higher ratio of old buildings and less social housing) or inner-areas that cause a less intense clash; 4) Inhabitants are segregated from the rest of the city and from other parts of the area itself.

This spatial segregation creates also an atmospheric segregation. An accurate description of the area's spatial and atmospheric segregation is presented by Soeiro (2020b) under the concept of heterotopia, pioneered by Foucault. However, there are spaces within the area where atmospheres are starting to juxtapose resulting in a chaotic and directionless feeling. When walking through the area one feels torn and the mood is very unstable: is one touring Lisbon's past or witnessing first-hand the upcoming future?

Shared Ambiances as Innovation Strategy

When decreeing Marvila and Beato as the new innovation area, we argue that because there was no transition strategy put in place to bridge the area's past (both its landscape and inhabitants) and the current innovation process, the area seems to be stuck, at a loss and at a breaking point. Original residents are suspicious and often unaware of the aim of the investment being done in the area. When they do, they feel threatened and unwelcome ongoing changes. As for new temporary residents, they feel disconnected both from the area and from its inhabitants which hinders a sense of orientation when establishing goals and going forward with the innovation strategy (ROCK Workshop 2020).

Being this the current situation, our proposal is to harmonise both spaces and atmospheres using as resources: urban design, sensitive ecology and political ecology. What all these elements have in common is that they focus on the surrounding environment and spaces that connect existing elements within the landscape (natural and artificial). Very briefly we address each one of them.

Urban design should prioritize mobility and accessibility, creating a transport system that encourages intermodality supporting the use of more than one mode of transport

for a single trip (Goletz et al., 2020). Also developing strategies that favour human scale mobility, to create a more flexible sense of space within the area, through plans that improve conditions for walking and biking (DesRoches, Russell and Guo, 2019).

Sensitive ecology is a key element to rebuilt a sense of place that can be addressed by recurring to its expression as ecological landscape. The goal is to elaborate a plan that connects existing natural elements in the area creating a sense of unit. This implies to carefully manage and craft natural elements, propelling them as landscape: horizon, sound, wind and movement (air), gardens and urban farms (earth), the riverfront (water), food/ cooking sites and careful public lighting (fire). These elements, when incorporated in the landscape, promote sensitive ecology.

Political ecology is the study of the intersection and relationship between the political, broadly understood, and environmental and ecological phenomena (Minch, 2011). It is a broad research area to which many different disciplines contribute where the ecological and environmental realms are always at the forefront keeping at its core human-environment relations. Research topics range from community engagement and governance to strictly biophysical ecology (Walker, 2005). Judging on the experience during the ROCK project, in the case of Marvila and Beato, to create a strategy that would be able to identify and engage relevant stakeholders so that each would be able to contribute to the area's future, aiming at its economic, social and ecological sustainability - where ecology would be at centre - would be highly desirable to achieve a renewed innovative ambiance that both embraces its past while looking into the future.

References

- Adey, Peter et al. "‘Pour votre tranquillité’: Ambiance, atmosphere, and surveillance." *Geoforum* 49 (2013): 299-309. <http://dx.doi.org/10.1016/j.geoforum.2013.04.028>
- Azevedo, Sara Ribeiro Couto Saldanha de. *(Re)branding Marvila*. Lisboa: FA, 2019. Dissertação de Mestrado. Accessed May 6, 2020. <http://hdl.handle.net/10400.5/19991>.
- Barbosa, Mariana de Araújo. Lisboa muda Economia e Inovação com saída de Paulo Soeiro de Carvalho. *Eco*. 2 January 2019. Accessed June 30, 2020. <https://eco.sapo.pt/2019/01/02/lisboa-muda-economia-e-inovacao-com-saida-de-paulo-soeiro-de-carvalho/>
- Benjaminsen, Tor A. and Svarstad, Hanne "Political Ecology." *Encyclopedia of Ecology*. Vol 4 (2018): 391-396. <https://doi.org/10.1016/B978-0-12-409548-9.10608-6>
- Boons, Frank and McMeekin, Andrew (eds.), *Handbook of Sustainable Innovation*, Edward Elgar: Cheltenham, UK & Northampton, MA, 2019.
- Couch, Chirs and Fraser, Charles. "Introduction: the European Context and Theoretical Framework." In *Urban Regeneration in Europe*. Edited by Chris Couch, Charles Fraser, Susan Percy, 1-16. Oxford, Blackwell, 2003.
- DesRoches, Chris; Russell, Kathleen; Guo, Yuxuan. (2019). Human Scale Mobility in Minneapolis, Measuring the conditions for walking, biking and other modes of 'human scale' transportation. Retrieved from the University of Minnesota Digital Conservancy, <http://hdl.handle.net/11299/208716>.
- Dosi, Giovanni, Roventini, Andrea and Treibich, Tania. "The Short- and Long-Run Damages of Fiscal Austerity: Keynes beyond Schumpeter." In *Contemporary Issues in Macroeconomics*. Edited by Josph E. Stiglitz, and Martin Guzman, 79-100. Palgrave Macmillan, London, 2016. https://doi.org/10.1057/9781137529589_9

Filippetti, Andrea and Archibugi, Daniele. "Innovation in times of crisis: National Systems of Innovation, structure, and demand." *Research Policy* 40 (2011): 179-192. <https://doi.org/10.1016/j.respol.2010.09.001>

Godin, Benoît. *Innovation Contested: The idea of innovation over the centuries*. London: Routledge, 2015.

Godin, Benoît and Gaglio, Gerald (2019). How does innovation sustain 'sustainable innovation'?. In Boons, F. & McMeekin, A. (eds.) *Handbook of Sustainable Innovation*, 27-37. Edward Elgar: Cheltenham, UK & Northampton, MA.

Goletz, Mirko, Haustein, Sonja, Wolking, Christina, L'hostis, Alain. "Intermodality in European metropolises: The current state of the art, and the results of an expert survey covering Berlin, Copenhagen, Hamburg and Paris." *Transport Policy*, 94 (2020): 109-122. <https://doi.org/10.1016/j.tranpol.2020.04.011>

Minch, Michael (2011) Political Ecology. In *Encyclopedia of Global Justice*. Edited by D.K. Chatterjee, Springer, Dordrecht. <https://doi.org/10.1007/978-1-4020-9160-5>

Otálora-Luna, F., Aldana, E. "The beauty of sensory ecology." *HPLS* 39: 20 (2017). <https://doi.org/10.1007/s40656-017-0149-y>

ROCK Survey. *Project ROCK - Lisbon Survey: Statistical Report*, 2020. Accessed June 30, 2020. <https://lisboa.rockproject.eu/categoria/publicacoes-policy-brief/>

ROCK Workshop. *Project ROCK - Workshop with cultural agents in Marvila Library*, 2020. Accessed June 30, 2020. <https://lisboa.rockproject.eu/rock-coffee-talk-5-agentes-culturais-de-marvila/>

Schumpeter, Joseph. *Capitalism, Socialism and Democracy*. New York & London: Routledge, 2010.

Silva, Margarida Reis. "Where the industry led them: urban growth of the Marvila and Beato boroughs since 1835." *Cadernos do Arquivo Municipal* 2(12) 2019. <http://www.scielo.mec.pt/>

Soeiro, Diana. "The Concept of Atmosphere: From Goethe to Bratton - How atmosphere is key to create Smart Cities." In *Reconstructing Urban Ambiance in Smart Public Places*. Edited by Hisham Abusaada, Ashraf M. Salama and Abeer Elshater, IGI Global, 2020a.

Soeiro, Diana. "Heterotopia and Governance Strategies: A case study on cultural heritage-led urban regeneration and fragmented urban contexts." Online Conference Spatiality and Temporality, 4-5 July, 2020b. London Centre for Interdisciplinary Research (*conference volume to be published soon*).

Soja, Edward W.. *Seeking spatial justice*. Minneapolis, MN, University of Minnesota Press, 2010.

Tasan-Tok, Tuna. "Entrepreneurial Governance: Challenges of large-scale property-led urban regeneration projects." *Tijdschrift voor Economische en Sociale Geografie* 101 (2) (2010): 126-149. <https://doi.org/10.1111/j.1467-9663.2009.00521.x>

Walker, Peter A.. "Political ecology: where is the ecology?." *Progress in Human Geography* 29(1) (2005): 73-82. <https://doi.org/10.1191/0309132505ph530pr>

Yigitcanlar, Tan et al (2018) Understanding "smart cities": Intertwining development drivers with desired outcomes in a multidimensional framework. *Cities*. <https://doi.org/10.1016/j.cities.2018.04.003>

Affects as Foam of the Balance of Power at a Time of Urban Aesthetisation?

About an Exploratory Research on Nantes and Saint-Etienne (France)

Georges-Henry LAFFONT¹

Abstract. In the society of affects, inhabited spaces are designed and the urban experience is conditioned. Based on preliminary observations realized during several editions of the Voyage à Nantes and the Biennale Internationale Design Saint-Etienne, this paper addresses theoretical, methodological and analytical questions in order to contribute to the research on the urban environment. This research postulates that this material, symbolic and discursive transformation of our sensibility perpetuates the structural relationships of force linked to cultural and social capitals while promoting, through the instrumentalization of affects, a standardization and normalization of individual and collective feelings and actions.

Keywords. Urban Atmosphere, Affects, Saint-Etienne, Nantes, Production of Space, Normalization, Conflicts

Introduction

This contribution is an exploratory research² on the processes and practices of normalization and resistance in the face of the “aestheticization of the world” (Lipovetsky and Serroy, 2013) and is part of the spectrum of research on atmosphere³, taken here as a socio-aesthetic relationship - sensitive, emotional, temporal (Amphoux et al., 2007) maintained with our living environments

On one hand, urban becomes decor, sensorial urbanism, sensual architecture, daily events (Laffont, 2019; Guiheux, 2017; Lucas and Mair, 2008). On the other hand, in a society of affects (Lordon, 2015), people are encouraged to know, value and express their emotions. Thus, not only living spaces are designed, but the living experience (Lussault, 2015) is itself conditioned. By paying as much attention to the atmosphere as to the affects, everything seems to be done to offer and guarantee calm, luxury and pleasure.

Two assumptions are made in the light of these findings. Firstly, this ambient aestheticization (Mons, 2013) by an instrumentalization of affects, would smooth out the

1. Lyon University - UMR 5600 EVS - ENSA Saint-Etienne, France, georges-henry.laffont@st-etienne.archi.fr

2. Since 2017, non-contractual research aims to inform the role of affects in the contemporary production and experience of the urban. On the occasion of the Journey to Nantes (2017-2018-2019) and the International Design Biennial in Saint-Etienne (2017-2019), an immersive field survey was conducted. It consisted in directly observing both individual and collective practices “in situation” and thus to try to analyze the behaviors, attitudes, arts of dealing with space during these events, as well as the material or immaterial staging of the spaces where these events took place. In 2021, this method will be supplemented by others, which are presented in the latest developments of this contribution.

3. Atmosphere will be discussed here as a synonym, in the English language, of ambiance used in the French language

sensitive roughness that would spoil this collective celebration and pacify social relations by creating a climate of apparent appeasement between social groups. Then, it would infantilize people through the deployment of material, symbolic and discursive codifications leading to a playful, mercantile and convivial urbanity. On the basis of these two hypotheses, which are in the process of being consolidated, this article proposes theoretical, methodological and analytical questions for debate, which could feed into research on setting the urban atmosphere.

First of all, it synthetically presents this new urban era through the first observations made in Nantes and Saint-Etienne, two industrial cities that have alternately “mutated” into creative cities after 1990 and are now collaborative cities. Then, it discusses the transformation of our sensibility that is being experienced there thanks to two cultural events, the *Voyage à Nantes* and the *Biennale Internationale Design Saint-Etienne*. Finally, it specifically addresses the research protocol that will be set up in these two cities to support the hypotheses formulated and consolidate these initial observations and reflections.

Towards General Urban Standardization and Air Conditioning?

For more than thirty years, the urban environment, an experiential environment, has been characterized by buildings with forms that rival each other in boldness, wastelands reinvested in festive spaces, and events of all kinds that mark a new rhythm of life. The material and symbolic transformation of the urban space and the staging of events at set dates, in set places and in playful and convivial ways of reappropriating public spaces would be the preferred tools of public and private actors to renew their financial rents (Adam and Laffont, 2018).

Nantes and Saint-Etienne, two cities chosen both for their cultural, social, etc. differences but also in view of their common trajectories, namely as industrial cities, having made culture and architectural or public space excellence their assets to be part of the metropolization phenomenon. Moreover, both of them relied on events, as illustrations of this transformation of the urban environment.

Since 2012⁴, in Nantes, an 8 km long green line painted on the ground invites every summer tourists and inhabitants to live a city adventure punctuated by the discovery of works of art and unusual places to demonstrate the cultural, architectural, urban and social excellence of the city.

Nantes guarantees a festive atmosphere and conviviality for everyone. During the various field observations, it was common to observe that these adventurers scrupulously followed this breadcrumb trail from the SNCF railway station, stepped on their feet, went to the wrong place or entered shops without noticing when a clever shopkeeper diverted the green line. In Saint-Etienne, a biennial event has been held since 1998 to mark the cultural life of this former industrial and mining stronghold⁵. After a few editions where the event was confined to a single venue, the Cité du design⁶, Biennial “is coming to town” and design is colonising all the public space (parades, festivals held in the city, etc.).

The observations made during the last two biennials, illustrate the ambivalence of the event and the urban atmosphere. On one hand, both are supposed to offer everyone,

4. See at: <https://www.levoyageanantes.fr>

5. See at: <https://www.biennale-design.com/saint-etienne/>

6. See at: <https://www.citedudesign.com/fr/home/>

whatever their social condition and cultural capital, the “design experience.” On the other hand, they target an elitist public with amenities that enable it to distinguish itself from other social categories.

Beyond the temporality specific to these two events, what we observe in these two cities is that, with the help of animations, events and other architectural, urban and landscape productions, it is not only the whole urban space that is aestheticized, but above all the sensitive experience of the urban that is transformed. Thus, in this setting of the contemporary urban environment, the tones, atmospheres, intensities, etc. felt become the alpha and omega of the production of space.

A Reloaded Urban Experience?

In the neo-liberal era, the use of events, the object architecture and the narration of urban projects contribute to the uniform and ambient aestheticization of our living environments. If the observation and analysis of social practices, memories, imaginary inhabitants, customs and sociabilities show the existence and persistence of atmospheres specific to Saint-Etienne and Nantes, initial elements show that this aestheticization contributed to an impoverishment of the sensitive experience and a reduction in the field of perceptions. The atmospheres observed in these cities, even if this remains to be substantiated, would translate and illustrate a massive process of standardization and codification of the urban in its material, symbolic, social and experiential dimensions, a process in which affects become an operative dimension.

Affect has become so prominent in the social debate that it has become an emotional watershed (Clough et al., 2007). In fact, affects now dominate the vast majority of research in the human and social sciences, neurosciences, cultural or urban studies, etc. This “emotional turn” would qualify an era characterized by a strong propensity to express one’s emotions, feelings (Illouz, 2006), or even an injunction. Consequently, for any research on the production and experience of contemporary urban life, one understands the infatuation for affects and its double challenge. On one hand, it is a question of grasping and understanding the nature of the relationships that an individual, a group, a society, maintains with its environment. On the other hand, it is important to be able to account for the values and ideologies that animate and structure these relationships, that oppose and confront each other in the arena that each urban situation constitutes.

In this way, it is possible to postulate and analyse the urban experience of a city in particular or of the urban in general, as a series of performances that engage corporeality, the being in its entirety (sensation, reflection, enunciation, action). Bodily experienced, limited in time, changing, affects are the products of a subjective perception and appreciation, with a view to an action, a situation that involves the individual (Laffont and Martouzet, 2018). As part of a society, the individual seeks to find meaning in what he or she experiences by adjusting between the values of the society and his or her own. What both an individual and a group feel is informed, defined and shared by society, which produces, legitimizes or prohibits ways of feeling, sensing and expressing that feeling (Bernard, 2015).

By a game on, with and through affects, the ambient aestheticization of the urban environment puts to the test the mastery of what an individual feels in a situation, the means and admissibility of expressing it, the ability to act accordingly. Being “out of place” or being “in the right place” results in significant differences in feelings and actions. A city with a singular and familiar atmosphere confers a certain ontological

security to the person who frequents it daily or discovers it and can quickly feel at ease there. On the other hand, this same city, as a discursive, material and symbolic translation of a process of standardization and codification, but also as an illustration, as it were, of a transformation of our sensitivity, can lead us to feel a relative insecurity, an unease for those who do not master the ad hoc code of behaviours.

Throughout a few exchanges, what we have learnt is that, in Saint Etienne, living the Biennial affects individuals by testing their legitimacy to feel and act or simply to be there. On a different note, in Nantes, the people interviewed, although they feel legitimate to take part in the *Voyage à Nantes* or to be there, do not seem to be experiencing an extraordinary event, which affects them individually in a singular and profound way. They will confess to “go with the flow,” or “be entertained.”

A twofold hypothesis can therefore be founded: on one hand, this codification of environments and practices would perpetuate the structural power relations linked to cultural and social capital. On the other hand, through the instrumentalization of affect, this same codification would aim to guarantee everyone a relationship without pain, without worry or surprise, without expectations and therefore without disappointment. In this way, the aestheticization of the urban environment and its setting would function as a social imaginary (Taylor, 2004). On one side it would aim at the fusion of the members of society in order to curb the tendency to friction, on the other side it would maintain the illusion that this same society is not a field and therefore cannot be subject to and governed by power relations.

Methodological Assumptions and Research Perspectives

During the last editions of the *Voyage à Nantes* or those of the *Biennale Design*, a whole range of behaviours have been expressed, from mastery to lack of mastery of the situation, of what it provokes and what it leads to do. In certain attitudes, postures, and speeches, it has been possible to detect that in situations of discomfort, individuals make adjustments to correct it. Adjustments that, in many ways, are emotional work (Hoshchild, 2003): changes in the physical or somatic manifestations of feeling (body or arm position; change of place, etc.), modification of expressiveness (use of superlatives with positive connotations, cries of joy, etc.) in order to communicate to others an impression of mastery, etc. Of course, at this stage of the research, these are only initial observations and their analysis, understanding and confirmation call for an investigation protocol. The protocol should also allow for a more detailed analysis of the behavior, what motivates them for the individual, how external determinations affect the behaviour, how, again, the individual manages or fails to act, etc.

In the new developments of this research in 2021, the challenge is to be able to appreciate this process from feeling to action and to reconstruct the chain (explanatory, causal, etc.) and to understand how and by what means the spatial devices and the setting of the contemporary city's atmosphere perform. To do this, several methods of investigation and analysis will be used, combining quantitative objective and qualitative reflexive analysis, methods that have been tested in previous research. First of all, observation in situations, in order to identify several clues on the composition, layout and action of spatial devices on and with individuals. Then, the commented path, which, by allowing us to gauge the influence of the situation, will prove to be a way of expressing feelings. Then, the mental map which, leading to a description of the situation and its spatial configuration will offer access to personal preferences and interests. Finally, a reactivation interview will allow the unveiling of the justifications for the behaviour, linking the situation to a previous personal event. A complementary

work of textual and lexicographical statistical analysis could complete this protocol (signify-significant); fine analysis of the discourse; identification of recurrent elements for each field and for the whole corpus of respondents).

Insofar as the focus here is on what affects, how it affects, what it does in a situation, this experimental protocol should make it possible to grasp how, through cognitive work, the disturbed individual will seek to regain calm, balance and harmony, by conforming to or resisting the stimuli of the situation.

Atmosphere is what makes the experience possible, but it is also what frames it, guides it and allows the sensitive to exist. To be affected means, in a situation, to feel, express and overcome a sensitive experience in order to give meaning - to rationalize - to what is lived, according to the possibilities established by society. Today, on one hand, discourse on the urban environment calls for the expression of affectivity, pleasure and desire, while on the other hand, their urban planning, architectural, landscape and experiential translations suggest a predetermination and typification of behaviour.

The observations made in Nantes and Saint-Etienne have made it possible, in a progressive and iterative approach, to build an interpretative framework. This leads to the thesis that the contemporary urban atmosphere produced materially, discursively and symbolically, just like the atmosphere as a way of feeling a situation, becomes an instrument at the service of keno-urbanization (Dear, 2002).

By combining the observation of situations where individuals and groups experience contemporary urban life and the analysis of the discourse that these individuals and groups bring to bear on their own experiences, research developed for the 2021 editions of the *Voyage à Nantes* and the next *Biennale* will have two objectives. Firstly, to identify the capacity of the atmosphere to animate, condition, air-condition, atmosphere and tone an urban environment and its experience. Secondly, to put forward that this sensorial government operates by an instrumentalization of affects in order to unify, normalize and neutralize feelings and actions in a kind of entertaining, soothing and alienating.

References

- Adam, Matthieu & Laffont Georges-Henry. "Conjuguer singularité et conformité pour se positionner sur le marché international de l'urbain." *Confins* (2018). DOI: [10.4000/confins.14614](https://doi.org/10.4000/confins.14614)
- Amphoux, Pascal, Thibaud, Jean-Paul & Chelkoff, Grégoire (dir), *Ambialces en débats* ; Grenoble, A la croisée, 2004.
- Bernard, Julien. "Les voies d'approche des émotions: enjeu de définition et catégorisations." *Terrains/Théories 2* (2015). DOI: [10.4000/teth.196](https://doi.org/10.4000/teth.196)
- Clough, Patricia Ticineto & Halley, Jean. *The affective turn: Theorizing the social*. Durham; Duke University Press, 2007.
- Dear, Michael J. (Ed.). *From Chicago to L.A., Making Sense of Urban Theory*. Thousands Oaks; Sage Publications, 2002.
- Guiheux, Alain. *Le grand espace commun*. Paris; Métis Presse, 2017.

Han, Byung-Chul. *Psychopolitique. Le néolibéralisme et les nouvelles techniques de pouvoir*. Paris ; Circé, 2016.

Hochschild, Arlie R. "Travail émotionnel, règles de sentiments et structure sociale." *Travailler* 9, (2003/1): 19-49. DOI: [10.3917/trav.009.0019](https://doi.org/10.3917/trav.009.0019)

Illouz, Eva. *Les sentiments du capitalisme*. Paris ; Editions du Seuil, 2006.

Laffont, Georges-Henry, "Une troisième (et dernière) révolution ? Ou le tourisme comme rapport unique à l'urbain et au monde." *Mondes du Tourisme* 15 (2019). DOI : [10.4000/tourisme.2021](https://doi.org/10.4000/tourisme.2021)

Laffont, Georges-Henry & Martouzet Denis. "L'affectif révélateur de l'"être-là"." *NPSS* 13 N°2 (2018): 185-214. DOI: [10.7202/1051115ar](https://doi.org/10.7202/1051115ar)

Lipovetsky, Gilles & Serroy, Jean. *L'esthétisation du monde. Vivre à l'âge du capitalisme artiste*. Paris; Gallimard, 2013.

Lordon, Frédéric. *La société des affects*. Paris; Points Essais, 2015.

Lucas, Raymond & Mair, Gordon (Eds.). *Sensory Urbanism Proceedings*. Edinburgh; The Flañeur Press, 2008.

Lussault, Michel. "L'expérience de l'habitation." *Annales de géographie* 704 N°4 (2015): 406-423. DOI: [10.3917/ag.704.0406](https://doi.org/10.3917/ag.704.0406)

Mons, Alain. *Les lieux du sensible, Villes, hommes, images*. Paris; CNRS Éditions, 2013.

Taylor, Charles. *Modern Social Imaginaries*. Durham and London; Dukes University Press, 2004.

Politicising the Atmospheres of Urban Environmental Changes

Abstract. Building on field research conducted during my Ph.D., which focused on urban natures and - in particular - post-industrial, riverside Turin (Italy), the presentation discusses urban political ecology and atmosphere literature, considered as two different, yet potentially complementary, fields of research. I will examine how an atmospheric-based critique of processes of decay can determine an interpretation of the dynamics of environmental degradation and - more broadly speaking - of urban environmental changes. I will conclude by offering some reflections on the extent to which the political ecology of atmospheres has helped me to formulate a different language, through which to capture the tenacious effects of processes of decay and territorial stigma.

Lucilla BARCHETTA¹

Keywords. Atmospheres, Environmental Change, Temporality, UPE, Urban Natures

Background

Turin, for centuries the kingdom of the Royal House of Savoy, is a city in the north-west of Italy. During the twentieth century, the city was known as the archetypal Italian 'one-company town', and viewed as the representation of the 'Other Italy': the symbol of Italian productivity, forced to manage massive flows of internal migration, especially from the southern part of the Italian peninsula. The aftermaths of industrialisation became visible through the intensification of social distress, environmental deterioration and conflict, which exposed the negative implications associated with the collapse of the 'car empire.' Since the 1980s and 1990s, Turin's post-industrial transformation has gradually developed. Municipal rehabilitation initiatives were put in place, which aimed to recolour the greyness and demolish the ugliness of long-term decay, for example through the enhancement of streets, housing and public spaces.

Urban transformations have partly foregrounded the focus on natural environments, viewed as a means to recover from the ghosts of the industrial past. This period was perceived as a 'golden era,' in which to fast track the urban regeneration agenda and bring the city's position out into the global arena of territorial competitiveness. The chronological contrast between before ('ugly atmosphere') and after ('happy atmosphere') emphasised the idea of a political momentum that circulated across the city. However, with the financial crisis of the late 2000s, the initial enthusiasm progressively waned. Indeed, Turin's transition to the post-industrial age has been fraught with contradictions and paradoxes. Over the last decade in particular, the city's kaleidoscope of social realities frequently clashed with the representation of a city capable of changing its own destiny by endorsing a neoliberal rationality of urban growth. Devoured by the financial crisis and debts (partially as a consequence of the

1. University of Turin - Department of Cultures, Politics and Society, Italy, lucilla.barchetta@unito.it

2006 Winter Olympic Games), suffocated by air pollution and betrayed by the major political changes that have traversed the city's government after the rise of the Five Star Movement (an Italian populist party), Turin has been at the heart of my Ph.D. research. The aim of the latter has been to capture the major changes in city life and environments, in order to build a political reading of the atmospheres of decay that seem to envelop the city. In particular, Turin's interstitial spaces along its watercourses, and the beings that grow in the midst of these, were the protagonists of my Ph.D. research, which questions urban environmental changes through the prism of metropolitan temporalities. My research has followed a comparative case study design, consisting of an in-depth analysis of two riverbank spaces that are located in Turin. I have used a combination of qualitative research techniques for the collection and analysis of data, primarily walking ethnography and interviews.

Degrado as a Social and Historical-Affective Atmosphere

In the Italian context, the term *degrado* stands for neglect and exhaustion, and is an antonym of decorum. The latter has its roots in the Renaissance theory of architecture, and refers to the main ideas about an organised and beautiful urban setting. Throughout the country, the word *degrado* is usually adopted in discussions about 'urban decorum', a theme that nowadays has gained new value and importance within the context of security culture (Pitch, 2013). In fact, it is in the name of security and urban decorum that local mayors have imposed a set of policies to regulate behaviour in public space, primarily via the application of municipal ordinances, which have been conceptualised precisely as 'measures against *degrado*.' Understood as the direct opposite of a humanist ideal (i.e. decorum), *degrado* therefore extends to include the social, political and moral issues that are provoked by the landscape transformations of living environments. Indeed, *degrado* has developed as an ecological imaginary and discursive framework of the Italian contemporary landscape, which associates structured neglect and environmental dilapidation with political corruption and moral-social decay (Barchetta, 2020). The question of *degrado* has shown what appears to be a distinct ability to convey a broad variety of issues regarding urban life: the securitisation of urban spaces as a consequence of the 'preventive turn' in the government of urban security; the diverse imaginaries of Italian ruins; the difficulties of post-industrial cities to put a new future into being; the processes of decay and ruination that are affecting global environments in the face of climate change and the spread of planetary environmental risks, wastes and toxins, and social exclusion.

Building an atmospheric-based critique of *degrado* through the 'political ecology of atmospheres' has thus entailed, above all, moving across different and conflicting, spatial and temporal scales. In order to investigate the geographies of decay of Turin's post-industrial riverside, I have used this concept to denote the socio-political entanglements with the sensory and biophysical realms that characterise urban natures as an ensemble of concrete forms, which range from the intra-level of the body to a variety of open spaces. By foregrounding temporality, I have also shown that it is possible to understand *degrado* not only as a socially constructed concept; at the same time, it can be defined as a time-specific, ontological dimension that is produced by a friction between the processes of planetary urbanisation and local singularities, which emerges in the form of a poorly defined atmosphere. The intellectual collaboration between UPE and the field of atmosphere studies has thus offered an opportunity to examine these divergent spatialities and temporalities without reproducing the dichotomy between denigration vs. romanticisation of decay, or that between decay vs. progress.

Interrupted Mobilities

Kazig et al. remind us that “mobility is the sine qua non condition of the atmosphere” (2017, 10). In the same vein, Pink and Sumartojo observe that “we might see atmospheres as being constituted, at least in part, through the movement [...] of tangible and intangible materialities.” They add that “movement enables people to label atmospheres, making them momentarily tangible” (2018, 75). It is important to stress that the advantages of the walking method include not only the possibility of entering the research field site and developing research from the bottom up; it also strongly supports an atmospheric approach to a site, as motion offers great potential for engaging with the material and political qualities of sensory encounters. However, as Mimi Sheller (2018) argues, movement is influenced and interrupted by a wide range of social vulnerabilities: personal, bodily vulnerabilities; biased policing; citizens’ exclusion from the legal entitlement to freedom of movement, and the exclusion from exercising freedom of movement, including the ability of women, POC and LGBTQ people to move freely in public. Over the course of my Ph.D. field research, I have experienced these ‘interruptions’ in relation to my own privilege of mobility, which has allowed me to reflect on the implications of being a white, female researcher walking in open spaces of riverside Turin that have experienced neglect and degradation.

Turin has been the base of my professional career and life for ten years. In this sense, doing ethnography at home and preparing to write a monograph has offered new perspectives on a city I assumed I partly already knew. The choice of case studies was in part influenced by my knowledge of the city, and by direct and indirect memories of the places. I didn’t go anywhere that was distinctively ‘elsewhere,’ but I became acquainted with the sites of observation, in a way by walking, and to some extent also by chance.

The stigma strongly impacted on the visitors’ rather low use of the riverside spaces, albeit in different ways. The common perception that both the edges of the Stura and the ruins of the former zoo are unsafe zones to a certain extent impacted on my sensual disposition towards the environments of my research. Auto-ethnographic solo walks became a means of exploring how the shaping of space influenced personal feelings of unease, which blocked me in my attempts to enter places I had never visited. Also, solo walks made me increasingly aware of the emotional labour of gaining and maintaining access to the field, and how this process influenced my perception of negative atmospheric qualities. Emotional reflexivity is important for qualitative research, especially when doing qualitative research on atmospheres of decay. Every walk therefore helped me to prepare for the next walk, and to outline my future ethnographic observations, which in turn helped me to gain self-confidence inwards, and build trust outwards.

Beyond the specific destination and duration of the pedestrian experience, performed alone or in small groups, the “felt mobility” (Kazig et al., 2017, 17) has been at the centre of my analysis, especially when conducting fieldwork in rather lonesome areas (during certain times of the day or in particular seasons), or in areas perceived as masculine spaces because men - rather than women - would congregate in these areas. Discourses and imaginaries of decay aim to secure particular types of public spaces by reproducing securitised, conservative and masculine imaginations of public order, which threaten the playful potentialities of public space through a gendering of urban exploration. Indeed, the walker can be a problematic figure of mobility in contemporary qualitative research and in walking methodologies, if this figure doesn’t question the very grounds of any axes of difference (race, gender, class, sexuality, ability) and the resulting power relations. Exploring the atmospheres of decay through

the political ecology of atmospheres has provided a unique opportunity to reflect on the politics of knowledge production, particularly in relation to the social organisation of difference both in my fieldwork experience and in the everyday understanding of urban landscapes.

Searching for the Vocabularies of Atmospheric Life

The appropriateness of the walking method for an atmospheric-based critique of processes of decay primarily relates to the possibility of multiplying social, material, political and sensorial encounters, and accordingly, the possibility of expanding the registers for understanding urban processes. Indeed, I claim kinship with Pink and Sumartojo, especially when they argue - drawing on Tolia-Kelly (2006) - that “any understanding of atmospheres must be empirically grounded in the categories by which people might understand their experiences as atmospheric in their own terms” (2018, 4). Hence, the analytic work on atmosphere consists of multiple processes of translation from and to different linguistic registers, which include the words used by ordinary people, experts and politicians, as well as those of the researcher. The emphasis on the significance of listening to, and telling, stories is at the heart of this approach. The “atmospherisation” (Thibaud, 2014, 7) of *degrado* is reproduced and sustained by the - sometimes random and unintended - correspondences between meaning-making processes, the eruption of moods, the movement of beings and materials, the circulation of substances, the mobility of discourses and the formation of collective feelings. Atmospherisation can shape the ways and contexts in which people feel and use the flow of time, though this doesn’t have to hide the fact that atmospheres can be experienced and negotiated in radically different ways. Searching for a vocabulary of atmospheric life that includes a possibly infinite number of atmospheric experiences, thus highlights the frictions that arise between discourses of *degrado*, considered as dominant temporal narratives, and the embodied and shared experience of degradation. The ways in which subjects relate to collective feelings can be varied. There is, indeed, a difference in the way environmental change is lived and felt. There is also a difference, however, in the way the temporality of environmental change is understood.

Metropolitan Temporalities

Looking at the past of urban-riverine relationships has allowed me to demonstrate that the issue of *degrado* in metropolitan natures is linked to the specific ways in which cultures of nature have evolved in relation to the development of the city’s socio-economic complexity, governance systems and conservation frameworks. This has confirmed my hypothesis of riverside Turin as a mosaic-like, fragmented and uneven type of landscape, framed by non-linear processes of development. It has also enabled me to explore the “social life” of open space designs and plans: how long it takes for plans to leave the drawing board, and what happens as they move closer to realisation or are revised, disrupted and even derailed altogether (Bissell, 2016). Plans, beyond specialised fields of practice and expertise, work behind the scenes, and they do so in an ordinary and everyday context. The unpredictable combination of ideas, actors and governance arrangements, along with the problems caused by delays and incomplete designs and planning, challenge the idea of riverside Turin’s socio-ecological temporality as a timeline of progressive steps, which become visible through the mixture of planned and unplanned natures, on the one hand, and never attempted and half-finished interventions, on the other. As a consequence, *degrado* is the result of a cumulative process that extends across a thick temporal field. Such infrastructural and administrative temporalities of environmental change interact with the histories of trees, plants, animals and other beings, such as rivers. The latter’s “time-making

projects” (Tsing, 2015, 21) are never the result of mechanistic programs; they are indeterminate and condense pasts, presents and futures. In this sense, the political ecology of atmospheres has proven to be helpful for an investigation into the social and biophysical temporalities that shape urban environmental changes. Riverine ecologies are shaped and framed by non-linear processes of development. The impossibility to reduce biophysical times to the rational, social times of the city is one of the sources of the conflict over the temporal regimes of metropolitan change. From this perspective, *degrado* denotes a time-space of crisis that flattens difference and renders time linear, cyclical and homogeneous, by erasing the historical processes that have produced environmental change. However, these processes are already there or in the process of being constituted.

References

- Barchetta Lucilla. “Walking with plants: disrupting the material logics of *degrado* at the banks of Turin’s Stura River.” In “The Botanical City” edited by in Sandra Jasper and Matthew Gandy. Berlin: Jovis Verlag, 2020.
- Bissell, William Cunningham. “Design and Temporality: Provocation.” *Correspondences, Fieldsights* (June 6, 2016). <https://culanth.org/fieldsights/design-and-temporality-provocation>
- Kazig, Rainer, Masson Damien, and Thomas Rachel. “Atmospheres and Mobility.” *Mobile Culture Studies. The Journal* 3 (January 1, 2017): 7-20. [hal-01882685v2f](https://doi.org/10.1111/j.1475-4762.2016.00682.x)
- Pitch, Tamar. *Contro il decoro: l’uso politico della pubblica decenza*. Bari; Roma: Laterza, 2013.
- Sheller, Mimi. *Mobility justice: The politics of movement in an age of extremes*. Edinburgh: Verso Books, 2018.
- Sumartojo, Shanti and Pink, Sarah (2018). *Atmospheres and the Experiential World: Theory and Methods*. Oxon: Routledge, 2018.
- Thibaud, Jean Paul. “Urban Ambiances as Common Ground?” *Lebenswelt. Aesthetics and Philosophy of Experience* 4 (2014): 282-295. [hal-01560138](https://doi.org/10.1111/j.1475-4762.2016.00682.x)
- Tolia-Kelly, Divya Praful. “Affect: An Ethnocentric Encounter? Exploring the ‘Universalist’ Imperative of Emotional/Affectual Geographies.” *Area* 38.2 (Jun 16, 2006): 213-217. <https://doi.org/10.1111/j.1475-4762.2006.00682.x>
- Tsing, Anna Lowenhaupt. *The mushroom at the end of the world: On the possibility of life in capitalist ruins*. Princeton; Oxford: Princeton University Press, 2015.

05

DIGITAL ARCHITECTURE. ATMOSPHERES IN DESIGN
AND NEW RESPONSIVE & SENSITIVE CONFIGURATIONS

06

FROM A SENSITIVE ECOLOGY OF
AMBIANCES/ATMOSPHERES TO A POLITICAL ECOLOGY

07

INFINITE ATMOSPHERES? ETHIC DIMENSIONS
OF AND FOR THE DESIGN OF PUBLIC SPACES

08

INHABITING INSECURITY.
PRACTICES AND REPRESENTATIONS

VOLUME 2

09

PHYSICAL/DIGITAL SPACES COLLISIONS. SO WHAT?

Infinite Atmospheres? Ethic Dimensions of and for the Design of Public Spaces

Session 7 – Introduction

Théa MANOLA¹,
Evangelia PAXINO²

The proposed title of the session aims to encounter theoretical proposals based on the subjective dimensions of the atmospheres, and on the ethical and political consequences resulting from their architectural creation. These fundamental questions applied on the design of public spaces, contribute to the discussion about the qualities of the contemporary public space which are capable to build “commons.” How does atmospheres participate in the definition of “common” in the design of public spaces and what ethics does it engage on the part of the designers - users? The cultural dimension of this question allows the selection of papers from different countries and the comparison between European (French and Danish) and American (Brazil and California) case studies. This chapter therefore brings together 5 contributions that we propose to put in dialogue:

Evangelia Paxinou, with her paper about the **Infinite Atmospheres**, questions the architectural and urban practices of the *Encore Heureux* collective and shows how these projects contribute to a praxeology of the creation of atmospheres, which opens to infinity the potentials of public spaces to produce new forms of commons. This paper responds to the one of Ole B. Jensen who shows how, on the contrary, dark design produces **Atmospheres of Rejection** in order to exclude homeless people from public space. These two proposals provoke the discussion about the creation of flexible spaces with possibilities of actions, without restrictions, suitable for everyone. In this sense, Marina Chavez’s Brezillian proposal on **Entangled Ambiance** invites readers to study everyday bodily practices as a tool for understanding and designing public space.

The above papers are based on a series of in-situ case studies with living atmospheres, while the two last ones work on non-realized projects with projecting atmospheres. The paper of Jennifer A. E. Shields, entitled **Displacement, architectural collage**, is about a studio exercise in architecture, where collage techniques are used to investigate the arising atmospheres of a heritage project. In other words, the author shows how collage techniques in architecture can activate contemporary atmospheres inspired by the stories and writings of the past. The paper of Nicolas Remy and Evangelia

1. AAU Laboratory, Cresson, France

2. AAU Laboratory, Cresson, France

Paxinou attempts to redefine the canons of underground spaces by working with the **Happy Atmospheres**, as the author defines them. Both papers question the ethical dimension of the architectural design of public spaces, on an analysis axis that crosses the question of the rehabilitation of the atmospheres of the past and the creation of happy atmospheres in public places.

This session thus provides a series of discussions through the comparative and cumulative reading of these papers.

Infinite Atmospheres

Ambiance as a Praxeological Tool for Public Space Design

Evangelia PAXINOU¹

Abstract. How does the notion of “infinite places” allow us to question the production of a contemporary architectural space? For creators, what are the new challenges for the design of the atmospheres of these new forms of public space? This article aims to bring together the urban practices identified by the *Encore Heureux* collective with a praxeological thought of the design of atmospheres. Infinite places through ambience are analyzed in their potentials to create infinite conflicts, infinite negotiations and infinite sympathies between the back plan and the emerging events.

Keywords. *Infinite Places, Infinite Atmosphere, Public Spaces, Architecture, Design*

Ambiance Design and Infinite Places

Today, the architectural work is more and more concentrated on the unilateral production of the architectural object and the satisfaction of its client’s needs, and less on its sensible qualities and the improvement of the human’s living conditions. Especially in public places, “architecture for architecture’s sake” creates “predetermined molds” (Zask, 2018, 87-88), based on extreme or stereotypical situations, in which the residents must adapt, suppressing their dynamics and needs, often cut off from their environment. The spaces become either uniform, “sterile,” without outbreaks, or completely differentiated from the environment, inaccessible, and restrictive.

In contrast to these approaches, we are interested in these modern places of collective creation “Infinite-Places” which was the main theme of the French pavilion of the Venice Architecture Biennale, in 2018, under the direction of the architecture office *Encore Heureux*. It is a team of architects who are looking for economically and ecologically feasible construction methods, which are not necessarily based on the destruction of the pre-existing framework and the consumption of significant resources and costs in order to create impressive works. Each context has and offers infinite resources, so the correctness of a project is based on systematic analysis and synthesis of what exists, and on how we can re-explore and enrich it².

The idea proposed by the group is that spaces should be considered as “endlessly incomplete” (Pérez, 2018, 100). According to the *The Yes We Camps Team* (2018, 224-225), architecture must allow people “to occupy the site” while it opens up to “the

1. Univ. Grenoble Alpes, ENSAG, AAU Cresson - CNRS, 38000 Grenoble, France, evangelia.paxinou@gmail.com
 2. *Encore Heureux* (Nicolas Delon, Julien Choppin et Sébastien Eymard) in <https://www.inexhibit.com/case-studies/infinite-places-the-french-pavilion-venice-architecture-biennale-2018/> (consulted, June 2020).

reception of other functions and social groups.” In this way, it is never “fixed” but “continues to transform adapting to the emotions and uses that arise. Through these forms, circulations, colors and views offered up to us, this architecture addressed itself primarily to the senses and the perception of our bodies within an inhabited system.” The question now is how do these (infinite) places “become an environment and promote a spiritual climate,” we can say an *ambiance*, “that extends beyond the actual building”? (Encore Heureux, 2018, 19).

Infinite Atmospheres?

The creation of Infinite Places is a system, a process, and by no means a final object. Matthieu Poitevin characteristically states that “the finished is death, life lies in the infinite” (2008, 282). For the “infinite” to work however, all those involved in the creation of the place (users, creators, managers, etc.) must complement each other and participate in shaping their own living conditions. As Pascal Dubois reports on *Les Grands Voisins*, Infinite Places are abandoned spaces that are transformed “and take on a new soul depending upon the person who moves in there, their activity, their sensitivity” (Dubois, 2018, 220). The role of the architect as the “conductor of an orchestra” (Pajot, 2018, 178) which consist of the contracting authorities, the team of experts and the users, is to ensure the conditions of emerging infinite/unfinished activities and consequently sensitivities, within a given - finished space (Encore Heureux, 2018). Therefore, the architecture of Infinite Places is a link for the creation, revelation and projection of the infinite atmospheres of spaces that inspire unpredictable situations and unplanned events. The creation of an *ambiance* in architecture is based on the management of the dialectical relationship of back-planning/events (Thibaud, 2015) that ranges between three interrelated situations: the *conflict* of motley elements, the *negotiation* of sensible spatialities and the emotional identification of sensible experiences (*sympathy*) (Paxinou, 2017). The aim of this article is to prove that the above principles of creating atmosphere in public spaces facilitate the dialogue between the dynamic and moral performance of “infinite places.” And vice versa, can we pretend to design infinite atmospheres when we wonder about these infinite places?

Infinite Conflicts

The conflicts have a political and æsthetic character in order to ensure the public character of the place. The public character opens to the activation of events through the conflict of diverse elements and sensible contrasts that are activated through the possibilities of actions provided by the material design. The public space that activates conflicts and encourages the participation of different social groups is considered as a “living” public space that opens to improvisation.

Infinite Places are places where take place infinite social, ecological, technical, political conflicts that arise from the proximity and diversity of participants, socio-economic regimes and dominant techniques. The challenge is to deal with the conflicts between their private and public character, their residential/professional status and the entertainment, the order and the disorder, the urban and the rural, without losing their competitive and provocative character.

Everything is Wrong

According to Patrick Bouchain (2018, 140-142), the abandoned, difficult places where “everything is wrong” are mostly open to the infinite. They are mono-functional, infected, damaged, too big or too small, illegal, unhealthy or uncomfortable, trying to turn into places of collective creation, without a specific program. Their permanent danger is the possibility of failure, and their unparalleled value is their transformation

into success. But “their real risk would be to do nothing at all.” During their re-invention, the place itself bothers again and again, including the methods we use to transform it, and as P. Bouchain puts it, “this is what makes it live again.” In other words, spaces where everything is wrong have strong potentials for infinite conflicts and therefore for the creation of remarkable atmospheres.

Freedom of Expression

The goal of Infinite Places is to ensure the freedom of expression of all participants who occupy a space and try to develop it without relying on pre-existing models. In order to achieve this, however, the creators face many tensions and concerns.

In these places are formed “micro-societies” by communities with common experiences and feelings often opposite to each other, which influence and “create, with their rules and esthetics *zones of temporary autonomy*, taking much from pirate ideologies” (Gwiazdzinski, 2018, 46-47). According to M. Poitevin (2018, 282), architect of La Friche La Belle de Mai, freedom of expression means creating spaces that allows the unexpected and inspire confidence at the same time. It is a matter of conflict between “trust and risk taking.” Such places are the abandoned, ugly, polluted, industrial spaces, because they challenge the participants (and not only the architect) to transform them into beautiful, useful and functional, through a process that never ends.

Contradictory Feelings

Even the emotions are mixed. A combination of sadness at the thought of history that comes to an end, and excitement at the intensity of the new life that begins, as new users wander and interact with the space, its history and others. In Le Tripostal, the old Avignon mail sorting center, which was an abandoned space full of rubbish, is being turned into a reception center for the homeless. As a result of this controversial development, there have been many conflicting sentiments, such as the local community’s suspicion during the winter, and the solidarity during the summer, where they have been actively involved in organizing various workshops (bicycle repair, film production) (Encore Heureux, 2018, 185). These contradictory feelings become the expression of the dynamic relationships between the back plan of the atmosphere and the events that mark it. They become temporal markers of the constitution of an ambiance.

Infinite Negotiations?

Design ‘negotiates’ the assurance of sensible (individual) and social distance and proximity. It often tends to weaken conflicts between identities and favors individual experiences and actions, creating events that rely solely on entertainment, and have no political meaning (do not bother). The result is the immobilization and the distancing of the person who is not actively involved. An example is the phenomenon of the overstimulation by external stimuli in the modern city, where the emotional intensification of a person can exclude him from the society. Negotiation between the organization/control of architectural design (back-plan) and the freedom of individual expression/action (events) ensures the public character of the space (Böhme, 2014). Excessive differentiation of events and back-plan leads to the creation of predictable spaces that try to impose themselves and determine action. This is achieved either by creating many “impressive” events, for the immediate satisfaction of the users’ senses (i.e. Disney Land, shopping malls), or by creating “sterile spaces” which, due to the lack of events, homogenize the perception of the built space (sounds, lights, smells, activities) (Paxinou, 2017). In both extreme cases the public character of the space is weakened. Infinite Places are examples of modern spaces that do not succumb to the

price of impression and homogeneity, and in which infinite negotiations take place in order to avoid social inequalities and tensions.

Without a Program

According to Sophie Ricard at Hotel Pasteur, the place is “conquered” by the different uses chosen by those who participate, the remnants of the past and the values of the new purpose. The goal is to create a place suitable for everyone, without a specific program of use. The program is flexible and arises from the needs of the civil society, the participants and the Authorities. A two-way relationship develops between creators, citizens and politicians. Together they explore alternative ways of living (outside the classical context), occupying exclusive-abandoned spaces which were not built for these purposes (Ricard, 2018, 157). Conflicts are ‘negotiated’ in-situ. Architecture simply provides the conditions for creating infinite negotiations and atmospheres.

The Role of Art

The art has an important role in the above negotiations between the participants. The artistic creations assure the democracy, the respect, the exchange, the evolving of the space and its sustainability. According to Encore Heureux, in Les Grands Voisins, the combination of social and artistic activities with simple and popular facilities such as camping, thermal baths or games has ensured the vitality of the area, by offering social inclusion, local transactions, joint meetings and self-sufficiency in actions. Agathe Chiron (designer) states that in Tripostal, the team negotiated its new controversial use as a homeless shelter, by organizing during the summer months, various cultural events such as exhibitions, galas, auctions, which allowed the space to become functional, not only for the vulnerable, but also for the residences. It is the art and the creativity that enabled all to sit “around the same table in their finery: the prefect, the homeless, the directors of the hotel manager, architects, the educators,” in a “place of kindness and coexistence.” (Chiron, 2018, 203). Atmospheres can therefore deal with these infinite negotiations.

Infinite Sympathies?

The ideal form of negotiation necessities all the participants to work together and not on their own. For that to happen, they need to feel sympathy for each other. Lars Spuybroek (2012, 311-314) argues that living with each other means feeling each other. It is the feeling of sympathy that enables the coordination of the actions of the participants of a group, in order to cooperate and help each other (ex. the swans who create the whole but do not control its form).

Based on the above relations, the concept of sympathy extends to the way in which the design of Infinite Places affects people’s lives. Infinite refers to the flexibility of spaces and uses, with the result that everyone feels free to create or explore and be enriched through collective diversity. Places emerge at any time from the coordination of these infinite transformations with their environment (infinite atmospheres).

Architecture of Presence

They are never fixed spaces - they continue to transform and adapt to the emotions and uses that occur. For the Yes We Camp Team (2018, 224) at Grands Voisins, what matters most is the process, the journey, not just the outcome. “It is an architecture of presence born of the everyday, practiced in a collective manner and interfaces with other professions.” The project is not fully defined before its implementation. It is being built progressively, in sympathy with the real situations prevailing in the area, allowing the participants to live and appropriate the space (infinite sympathies between creators and users). It’s all about the infinite “transformations in sympathy

with the environment” which enables architects “to respond to the cultural, political and public issues inherent in the project” (Pajot, 2018, 178).

Living Material

In *Tripostal*, the most intense moments are when the “dreamers” of the project, as mentioned by Sébastien Thiéry (political analyst), began to meet and appropriate the space, in order to start the action (architects, clubs, residents and region). They started visiting the area, talking to the homeless and the residents, dreaming and conceiving ideas at the same time, in an undoubtedly more productive method, than the one where the architect is obliged to predetermine ideas and concepts. The architect becomes the “messenger from a utopia,” trying to project what does not yet exist in the realm of logic. According to Tiéry, the hut made of mud and straw and the people who will live in it, become the tool for composing the “living material” of the space, that is, the atmosphere created by the expression of the participant’s desires (sympathy between participants and space) (Tiéry, 2018, 199-200).

Aesthetics of the Do-It-Yourself (bricolage)

Finally, the transformations in sympathy with the environment are activated by the “aesthetics of the do-it-yourself” (*bricolage*), which coordinate the existing back-plan with the “idea” and the activation of events. According to P. Perez (2018, 105), based on Levi-Strauss, the aesthetics of the craft are the opposite of the engineer. “While engineers conceive their designs in abstracto, validating them with simulation and sophisticated evaluation (drawing, calculation, use of scale models, etc.),” and then having them materially constructed by workmen, the bricoleur with the materials to hand, searches through the “already there” and among his or her stock of available tools and conceives by doing.” The object is gradually defined and the gap between idea and result is constantly reviewed (Pérez, 2018, 105-106).

Based on the above, we can argue that “*bricolage*” expresses the dialectical relationship between thought and instinct and is based on the development of feelings of sympathy. It is activated by the emotions felt by the creator while he experiences the space and the mental and physical processing of the object he wishes to construct. For the creator to feel the changes, he must move along with the changing object. Consequently, if the forms activate sensory-motor experiences (affordances) then the emotion can configure a form through sympathy. The atmospheres are its witnesses.

References

Böhme, G. Eliasson. Pallasma, J. Borch, C. *Architectural Atmospheres: on the experience and politics of architecture*. Basel: Birkhauser Verlag AG. 2014. 112 p.

Encore Heureux (Edts) : Nicolas, Delon. Julien, Choppin. Sébastien, Eymard. *Infinite Places - constructing Buildings or places ?*, Institut Français, Editions B42 : Paris, 2018, 357 p.

Bouchain, Patrick. *Daring to Experiment*, in *Encore Heureux* (Edts), *opus cit*, pp. 139-145.

Chiron, Agathe. *Le tri postal*, in *Encore Heureux* (Edts), *opus cit*, pp. 202-205.

Dubois, Pascale. *Les Grands Voisins*, in *Encore Heureux* (Eds), *opus cit*, pp. 219-229.

Gwiazdzinski, Luc. *Localixing the in-finite*, in *Encore Heureux* (Edts), *opus cit*, pp. 39-52

Pajot, Jacques. *Le Centquatre*, in *Encore Heureux* (Edts), *opus cit*, pp. 175-183.

- Pérez, Patrick. *Desire and the "already there,"* in *Encore Heureux* (Edts), *opus cit*, pp. 99-108.
- Poitevin, Matthieu. La friche La Belle de Mai, in *Encore Heureux* (Eds), *opus cit*. pp281-285.
- Ricard, Sophie. *L'hôtel pasteur*, in *Encore Heureux* (Edts), *opus cit*, pp. 157-161.
- Thiéry, Sébastien. *Le tri postal*, in *Encore Heureux* (Edts), *opus cit*, pp. 198-201.
- The Yes We Camps Team. Les Grands Voisins, in *Encore Heureux* (Edts), *opus cit*, pp. 221-225.
- Zask, Joëlle. The utilization of places, in *Encore Heureux* (Edts), *opus cit*. pp 87- 97.
- Paxinou, E. *Ambiance Creation in Architecture. A challenge for the design of the urban public space*, Aristotle University of Thessaloniki, School of Architecture: Thessaloniki, 2017, 392 p., ([tel-01527083](tel:01527083))
- Paxinou, E. Playing with the ambiances in the city. International and interdisciplinary conference "Children's spaces or spaces for children," May 2017, Thessalonique, Greece. ([halshs-01700384](https://halshs.archives-ouvertes.fr/halshs-01700384))
- Spuybroek, L. *The sympathy of things: Ruskin and the ecology of Design*. Rotterdam: New York, NY: nai010 Publishers, 2012, 400p.
- Thibaud, Jean-Paul. *Vers une grammaire générative des ambiances*. In : En quêtes d'ambiances. 193-220, Genève : Métiss Presses. Collection Vues d'Ensemble. 2015.

Atmospheres of Rejection

How Dark Design Rejects homeless in the city

Ole B. JENSEN¹

Abstract. You are looking for a place to sleep. You have no job, no money, and no place to stay. The night is closing in, and the city is changing its face from day to night. What will you do? Where will you go? This is the situation for millions of homeless people ‘sleeping rough’ in cities every night all over the world. This paper explores in more depth how the rejection of homeless people in urban spaces is an interplay between public space design and human bodies. The framework of ‘dark design’ is utilized to illustrate how social exclusion by design (e.g. spikes, leaning benches, inserts of metal frame etc.) is materializing, and how this is felt. The paper explores how the material exclusion of homeless people through dark design is enrolled into an ‘atmosphere of rejection’.

Keywords. Dark Design, Social Exclusion, Multisensorial Embodiment

Atmospheres of Rejection

The social acceptance of individuals within societies small or large is recognized to be one of the most fundamental aspects of what it means to be human (Goffman, 1964; Young & Petty, 2019). Feeling accepted in social circles of various kinds is essential to the ‘social animal’. In this paper I wish to address how rejection can be framed in the light of atmosphere. In more specific terms, the paper will use the case of so-called ‘dark design’ (Jensen, 2019) which is when urban spaces are being re-designed so that for example homeless people cannot sleep on benches because they are angled in a steeper way by designers, or when spikes and other sharp objects are being set into corners and small spaces where homeless would aim for temporary shelter. Dark design has affinities with so-called “hostile architecture” (Rosenberger, 2017). This paper leans on the broader notion of dark design since it is wider in its framing (e.g. also including for instance socially exclusionary dimensions of traffic light coding for elderly, a case that would fall out of frame had ‘architecture’ been the lens).

There is, however, more to rejection than simple material and physical impossibility of particular practices. As these practices (e.g. sleeping under a bridge or lying flat on a bench) becomes impossible due to the material design of things, they slowly establish a particular atmosphere of rejection primarily felt by the homeless people (Jensen & Lanng, 2017, 89). The hypothesis is that the way in which homeless people experience the increased number of socially exclusionary interventions and designs slowly and gradually pushes them away from urban spaces, but also from society per se. Even though there (might) not be a coordinated and ‘sinister plot’ to exclude homeless people via dark design (I will return to the notion of design intentionality)

¹ Department of Architecture, Design and Media Technology, Aalborg University, Denmark, obje@create.aau.dk

the experience from the point of view of the homeless is clear. In a city full of dark design, you feel rejected even by the bench that other people just pass by unknowingly about its role in an atmosphere of rejection.

The structure of this paper is the following. After the introduction, section two shortly explain the notion of dark design. Hereafter section three explore how the phenomenon of dark design might connect to the notion of atmosphere. Section four is devoted to the pivotal theme of the body. The paper end in section five with some concluding remarks and pointers for future research within the areas of atmospheres of rejection.

Dark Design

Dark Design is the deliberate shaping and design of urban spaces and artefacts with the intention of excluding particular activities and social groups (Jensen, 2019). In this context we are not including the exclusion of for example skate boarders by mounting the so-called 'skate-stoppers' on edges in the urban fabric. We want to reserve the discussion about dark design to the exclusion of vulnerable social groups in the city such as for example homeless people suffering from lack of mobility justice (Sheller, 2018). This paper explores how this may be better framed by engaging with the notion of atmosphere. However, let us start by listening to an account of how it feels to be rejected by the spaces and artefacts of the city. Here is a statement from a person who became homeless as an effect of a personal crisis:

From ubiquitous protrusions on window ledges to bus-shelter seats that pivot forward, from water sprinklers and loud muzak to hard tubular rests, from metal park benches with solid dividers to forests of pointed cement bollards under bridges, urban spaces are aggressively rejecting soft, human bodies. We see these measures all the time within our urban environments, whether in London or Tokyo, but we fail to process their true intent. I hardly noticed them before I became homeless in 2009. An economic crisis, a death in the family, a sudden breakup and an even more sudden breakdown were all it took to go from a six-figure income to sleeping rough in the space of a year. It was only then that I started scanning my surroundings with the distinct purpose of finding shelter, and the city's barbed cruelty became clear (Andreau, 2015, quoted in Jensen, 2019, 122-123)

What is striking in this first-person account is the language of 'urban spaces rejecting soft bodies' and further the 'city's barbed cruelty'. The vulnerability of the human body and the fragility of human flesh is coming across quite forcefully here. This is indeed what it is about: the fact that the body might be cut, hurt, and damaged by some of these interventions. Benches are often examples of dark design since they already are resting places in the city that afford staying and occupation (Armborst et al., 2017; Rosenberger, 2017). A 'classic' intervention is to separate the horizontal surface with what might look like an armrest. However, very often we see 'armrests' that are very poorly designed had this been their true purpose. Mostly, they are about 5-10 centimetre high and not really meant for any comfortable armrest, but rather for preventing the horizontal placement of a human body.

The effect of various dark design interventions and installations across the city means that homeless people will face these as they drift through the city seeking for shelter. This, then results in a new geography of power that renders the city scripted with a 'mosaic' of places one cannot go, and places still able to offer shelter:

Some of the interventions and designs directly orchestrate flows and movements by rendering benches, doorways and grass lawns uninhabitable. [...] Urban no-go areas and design blockings force movement to ‘free zones’, areas not yet imprinted with dark design. So, while bum-proof benches and metal spikes nested into concrete are stationary and sedentary interventions and devices, they afford and enforce movement to other places, establishing an urban mosaic of ‘go/no-go’ areas. Places of forbidden access exist alongside places of access, creating an urban jigsaw puzzle constituted through corridors of movement/access and immobility/exclusion. Furthermore, these meticulous interventions work directly on unwanted subjects’ bodies by denying them a public space of being, excluding them from this sphere of social life. Over time, such acts of citizen denial surely contribute to a general erosion of self-confidence amongst people who already are at the bottom of societies (Jensen, 2019, 123-124)

The manifestation of dark design is, however, not only a matter of artefacts and objects. In Denmark, as in the US, design is not alone in creating atmospheres of rejection. As Rosenberger points out: “design and law come together to unjustly and unethically push the unhoused out of shared public spaces” (2017, 35). The complex relationship between laws prohibiting people to gather and make shelter is together with the concrete artefacts of dark design working to create an atmosphere of rejection.

Atmospheres

Atmospheres are both a very tangible and ephemeral. They are materially manifest and sensorial perceived. They are effects of materials, spaces, and artefacts as well as they are sensed throughout all the sensorial and effectual registers. Atmospheres are characterised as the “prototypical ‘between’ phenomenon” (Böhme, 1998, 114). Precisely this ‘in-between’ status is the key to the ephemerality of atmosphere, but also to why the notion has proven to be central in the recent research on mobilities and urban design (Jensen & Lanng, 2017). In the words of Böhme: “To be sure, the designer also gives objects form. But what matters is its radiance, its impressions, the suggestions of motion” (1998, 115). The in-between dimension and the radiance (or “ekstase,” Böhme, 2013, 14) that certain materials and spaces manifest is key. Shade or sunlight, slopes or flat surfaces are all complex material configurations that connects bodies and minds that senses, and make sense.

The history of architecture is rich on examples of how atmospheres can be crafted, manufactured, and staged (Borch, 2014). The *Third Reich* and its spectacular crowd gatherings (Borch, 2014, 61) are *legio* but also other more mundane acts of staging would testify to the political potential of atmosphere: “the staging of politics, of sporting events, of cities, of commodities, of personalities, of ourselves” (Böhme, 2013, 6). However, there are also atmospheres that are less loud and explicit. The small and meticulously installed elements of dark design are most often not meant to communicate explicit political agendas, but simply to remove the unwanted. The ‘stealth ambitions’ of dark design does not make it less political and normative, but it takes away some of the spectacle and requires close attention and observation. As David Bissell argues: “affective atmospheres are central to everyday conduct whilst on the move since different atmospheres facilitate and restrict particular practices” (2010, 272). This resonates with Ben Anderson, to whom atmospheres emerge in the relational “assembling of the human bodies, discursive bodies, non-human bodies, and all other bodies that make up everyday situations” (2009, 80). Thibaud notices this when he points at the subtle interweaving of synaesthesia and kinæsthesia and the affectual resonance (2011, 1). Urban atmospheres and ambiances reach out and connect

bodies, spaces, and artefacts in ways that render themselves often best described by “non-representational” ways of description (Bissell, 2010; Vannini, 2015).

We are facing material interventions that pushes bodies away in a very tangible manner often afforded by basic conditions such as gravity. However, we are also seeing how the push from the artefacts and materials in their subtle way becomes parables of self-perception of the homeless. The constant rejection ‘radiating’ from the artefacts and spaces is part of a larger discourse of rejection that ultimately expresses a deep and profound case of identity rejection in a context of demand of ethical recognition (Duff, 2017, 528; Justesen, 2020, 263). One does not belong, and hence one is not even a citizen of this city! In this sense even ‘quiet’ artefacts are political and play their part in an atmospheric politics. Or in the words of Borch: “the design of architectural atmospheres amounts to a subtle form of power, in which people’s behaviour, desires, and experiences are managed without them being consciously aware of it” (Borch, 2014, 15). It should now be clear that the body and the way in which it registers, senses, and relates with the material and physical environment is a pivotal theme.

It All Comes Together in the Body - Assembling Atmospheres of Rejection

Humans are placed in material situations with an openness between the world and bodies that has the character of “osmosis” (Jensen, 2016). In the words of Richard Shusterman:

To focus on feeling one’s body is to foreground it against its environmental background, which must be somehow felt in order to constitute that experienced background. One cannot feel oneself sitting or standing without feeling that part of the environment upon which one sits or stands. Nor can one feel oneself breathing without feeling the surrounding air we inhale. Such lessons of somatic self-consciousness eventually point toward the vision of an essentially situated, relational, and symbolic self rather than the traditional concept of an autonomous self-grounded in an individual, monadic, indestructible and unchanging soul (2008, 8)

The concrete, physical situation of say walking through a public space looking for shelter is then always situated into the material environment. When trying to find shelter utilizing the material props of the city, artefacts and materialities such as benches, doorways, tunnels, and underpasses are assessed in relation to their affordances (Ihde, 2016). The nature of atmosphere as in-between, “reaching out” and bridging can be combined with the ideas of “osmosis” (Jensen 2016) and the insights from gerontology on what is termed the “extended body”: “The extended body’ refers to the ways in which one’s body always extends into its environment, just as its environment extends into it” (Reynolds, 2018, 33).

The multi-sensorial and affectual experiences of e.g. homeless people when it comes to dark design is thus pivoting around the notion of the body and its relational coupling to spaces, artefacts and wider legal and social discourses. The atmospheres of rejection perform via this complex and relational interplay.

Concluding Remarks

The role of the body is vital for understanding the atmospheres of rejection. There is no doubt that rejection is felt and experienced by the homeless people on the street. However, one question that keeps coming up when one speaks with architects and city

planners is the question of intentionality. As already mentioned, we might not only be looking at bad intentions (even though that surely is the case in many instances). Sometimes we may even face what I would term the 'unintended consequences of design'. However, with the specific artefacts of exclusion that have been discussed in this paper we need to face the fact that these artefacts are inserted into the urban fabric on purpose. Hence, we may speak of 'embedded rationalities' where:

The materials have not chosen to locate themselves in these particular sites, but are meticulously and strategically inserted into the urban fabric to create socially exclusionary effects in particular situations. Put differently, we may think of these exclusionary rationalities as processual, situational and relational phenomena, which require assemblages of different (but particular) bodies, artefacts and objects in time and space (Jensen, 2019, 125)

A future research agenda for dark design must be concerned with exploring the relational assemblages of institutions, humans, organizations, artefacts, and spaces. The notion of atmosphere is a key dimension of this exploration as it bridges spaces, artefacts, and human bodies in a search for atmospheres of rejection.

References

- Anderson, B. (2009) 'Affective atmospheres'. In: *Emotion, Space and Society*. pp. 77-81
- Arnborst, T., D. D'oca, G. Theodore & R. Gold (2017) *The Arsenal of Exclusion and Inclusion*, Barcelona: Actar
- Bissell, D. (2010) Passenger mobilities: affective atmospheres and the sociality of public transport, *Environment and Planning D*, vol. 28, pp. 270-89
- Borch, C. (ed.) (2014) *Architectural Atmospheres. On the Experience and Politics of Architecture*, Basel: Birkhäuser
- Böhme, G. (1998) Atmosphere as an aesthetic concept, *Daidalos*, 68, pp. 112-115
- Böhme, G. (2013) The art of the stage set as a paradigm for an aesthetics of atmospheres, *Ambiances: International Journal of Sensory Environment, Architecture and Urban Space*, <http://ambiances.revues.org/315>. Accessed October 12 2015
- Duff, C. (2017) The affective right to the city, *Transactions of The Institute of British geographers*, 2017, 42, 516-529
- Goffman, E. (1964) *Stigma. Notes on the management of spoiled identity*, London: Penguin
- Ihde, D. (2016) *Husserl's Missing Technologies*, New York: Fordham University Press
- Jensen, O. B. (2016) Of 'other' materialities: why (mobilities) design is central to the future of mobilities research, *Mobilities*, vol. 11, no. 4, pp. 587-597
- Jensen, O. B. (2019) *Dark Design. Mobility Injustice Materialized*, in N. Cook & D. Butz (eds.) (2019) *Mobilities, Mobility Justice and Social Justice*, London: Routledge, pp. 116-128
- Justesen, P. (2020), *From the Periphery - Real-Life Stories of Disability*, Chicago: Lawrence Hill Books/Chicago Review Press
- Reynolds, J. M. (2018) The Extended Body: On Aging, Disability, and Well-being, *Hastings Center Report*, 48, no. 5 (2018), pp. 31-36. DOI: [10.1002/hast.910](https://doi.org/10.1002/hast.910)

Rosenberger, R. (2017) *Callous Objects. Designs Against the Homeless*, Minneapolis: University of Minnesota Press

Shusterman, R. (2008) *Body Consciousness: A Philosophy of Mindfulness and Somaesthetics*, Cambridge: Cambridge University Press

Sheller, M. (2018) *Mobility Justice. The Politics of Movement in an Age of Extreme*, London: Verso

Vannini, P. (ed.) (2015) *Non-representational Methodologies. Re-Envisioning Research*, London: Routledge

Young, A. & J. Petty (2019) On visible homelessness and the micro-æsthethics of public space, *Australian & New Zealand Journal of Criminology*, 2019, vol. 52(4) 444-461

Entangled Ambiance

Bodily Practices as a Fundamental Instance for Founding the Places

Marilia CHAVES¹

Abstract. In face of changes on living collectivity and human bonds on the informational age, we question which mechanisms preserve the capacity to promote a shift in the centrality of the subject towards the acceptance of alterity and differences. This operation is important for maintaining social cohesion and constructing public spaces as truly democratic places. In this sense, we briefly analyze the Maua Square, Rio de Janeiro, Brazil, a touristic spot that contains many layers of history and uses. This study shows how the same physical space can be characterized by an entangled ambiance that simultaneously harbor distinct microenvironments, offering multiple possibilities of engagement and indicating that the mode of attention can be decisive in establishing the constitution of the place.

Keywords. *Cities, Collectivity, Multiplicity, Social Bonds, Entangled Ambiances*

Ambiances, Heterogeneity, and Complexity

The concept of ambiance embraces heterogeneity: of sensorial stimulus, of lived experiences, of diverse relations on (and with) space and built environment. Instead of being a clear and one-sided perception, an ambiance is more defined by a wholeness in which our bodies are immersed, and it is not possible to completely distinguish the ends and beginnings of an ambiance, because they are formed in the micro processes of appropriation, on daily life, continuously. “An ambiance has no contours, no precise shapes and no defined limits” and all ambiances are at the same time “spatialized and spatializing” (Thibaud, 2017).

These statements are essential for understanding the complexity of the lived experience and the relevance of human activity as an indissociable component of the quality of built environment. In other words, “Ambiances allow to complexify the sociology of action [...] developing a sensitive approach towards forms of life” (Bonicco-Donato, 2012). Here we understand complexity as defined by Edgar Morin (2015, 13): A fabric of heterogeneous constituents inseparably associated, placing the one and the multiple in paradox, composing an infinite game between actions and retroactions that constitute our phenomenal world. To name this game, the author adopted the term ‘tangle’ - in the sense of a system that is relational in a non-linear way. Facing the uncertainty and contradiction that this tangle contains is one of the biggest challenges when it comes to understanding the logic of complex thinking. According to the author, “not only is there no longer a simple empirical basis, but also a there is no simple logical basis (clear and distinct notions, unambivalent, non-contradictory, strictly determined reality) to build the physical substrate” (Morin, 2015, 19). Situating the built environment from this perspective advances in an understanding more linked

¹ FAU-UFRJ - Proarq - LASC research group, Brazil, mariliachaves.arq@gmail.com

to an inclusive logic, that accepts the users' role on shaping the character of places, instead of creating towards the figure of architects and urban planners a mythology of purity and complete control over the city. As Donato said, "it is more deep to think of the intertwining of urban atmospheres and forms of coexistence to reflect on the design of places where urbanity marks coincidence not only spatial and social, from the perspective of the sociology of action, but also of the sensitive aspects" (Bonicco-Donato, 2012).

Thinking about these intertwined atmospheres, or this tangle, seems a reasonable way to discover other methods to conceive the urban design of a city that is also marked by other new influences, such as a change in modes of attention, due to facts as the immersion technological and informational in everyday life and the increase in communication and transport flows in a globalized society. In the metropolis of virtual information networks, our existence is, more than ever, abstract, virtualized, generally with a great tendency to reduce tactile bonds, and always walking on the limit of what could be characterized as a process of de-realization (loss of material reality), and the constitution of a "disembodied" universe where our physical body is no longer the strongest and only anchorage of life: it surrounds us and disturbs us the construction of an aesthetic of disappearance, as treated by Paul Virilio (2015). Guattari (2012, p. 150), on the other hand, understands that subjectivity is threatened with paralysis: at the same time that people more than ever physically move between places, they maintain a paralyzed existence, a false nomadism, which cannot actually move our subjectivity. However, although many authors see disembodiment as a catastrophic threat, Lipovetsky and Serroy (2015, p.407) understand that, in a paradoxical way, the more the world becomes virtual, the more it hopefully ascends a culture that seeks to value eroticization and the pleasure of existence. The more virtual communication tools there are, the more individuals try to meet, see people, feel a quality environment.

Considering that perceptions and experiences in place are different, deepening the inclusive logic of complexity brings out many other questions, specially related to the plurality of meanings, representations and desires expressed on urban environment today. Regarding the study of ambiances, during the development of my master's dissertation, a particular issue captured my attention: If an ambiance cannot be distinguished with precision; If it is composed of many dynamic components that change all the time; How is it possible to point out certain tonalizations for the places, on a collectivity perspective? Is it possible to recognize a collective pattern for characterizing an ambiance?

With these questions, I do not want to minimize the importance of the subject on apprehending an ambiance, once it is not possible for a subject to put itself aside and make an impartial observation and once we are deeply affected by the environments in which we are immersed, but rather investigate how this phenomenon would occur in a more collective level. My questions refer to the problem of multiplicity, collective memory, and meanings on the city, whose relevance is presented when we observe the necessity of making urban spaces more adequate to human desires and necessities in a fast-changing world.

The Power of the Body: Daily Practices and Extrapolation Capacity

Intrigued by the questions presented before, I developed my master's dissertation between 2017 and 2019, using as a case of study the Maua square, situated on the city center of Rio de Janeiro, Brazil. The Maua square is also a spot place in the city, marked by historical dualism between being a marginal space and a showcase space,

or postcard, revealing on the present two main different dynamics, marked by tourists flux and local users flux. This site was considered an ideal place for conducting the study, due to the fact that there I found hints of an inconsonance between the layouts and languages of architecture of the place, in its newest renewal, and some of the uses founded on place. In the phase of ethnographical observations², I realized the different character potentials that some appropriations established. These uses seemed to be concentrated, precisely in the interstitial spaces, in almost separate universes or microenvironments, which did not always interact and were not always in sync with the message pointed by physical environment.

To base these observations, the notion of agency (Deleuze and Guattari, 2012a, 19-36) was used as key concept. An agency is a set of actions, statements, and interactions that the bodies operate, and that has territorial power. It works, on the one hand, as machinic agency, that is, as a mixture of bodies reacting over each other - in the material dimension of life; and on the other hand, as a collective enunciation agency, that is, any and all act of enunciation through language (code), but which refers to regimes of signs and meanings, operating instantaneous transformations on the character of these bodies. These transformations are incorporeal, they occur in statements, in performances, in readings about the world, in communications, and from the moment they are enunciated, they promote a change in the construction of meaning, so they are instantaneous in this instance. Although they arise from immaterial means - the construction of meaning - they have an effect attributed to bodies on space.

It was possible to observe agencies of groups of people that gather to fish, occupying the gardens at the edges of the square - that were not made to stay, but as a safety margin for water. But also in people who dived in Guanabara bay, despite warnings prohibiting activity; on skate activities; on people dipping their feet in water mirrors (also prohibited), on the hottest days; on groups of urban dancers who suddenly established a festive atmosphere; We also found these agencies on micro adaptations of the facilities of the place: the signal lights on the floor being used at night to prepare hooks, small machine houses being used as bar tables, trees used as hangers, People sitting on uncomfortable postures on the benches, in order to contemplate better the landscape - not the museum. Operations that shifted, even for moments, the utility of the built environment.

Overall, we noticed the strong presence of water, as an element that appeals to other temporalities and senses. On the second part of the research, collecting data from interviews and conversations, were founded similar propositions on the enunciated expressions of desiring there some different structures. I evaluated shades and affections expressed that could provide clues in the investigation about the character of the place through affections mentioned in the narratives obtained from the interviews. In addition, people were asked to compare the Maua square to other places in the city. Many local people expressed for example the desire of having a beach there or a place designed for contemplation, meeting, fun, and a more physical proximity and interaction to water. And many people compared the Maua square to landfill of Flamengo, another big urban equipment that has more leisure and sports facilities. One interesting data, is that the tourists couldn't associate Maua with Flamengo (even if they are morphologically similar), and associated Maua with other very morphologically discrepant pairs, such as statue of Christ the redeemer, and "Pão de açúcar" hills - all of them touristic spots.

2. I adopted mixed research methods, that included the etnotopography (DUARTE E PINHEIRO, 2013) and the ethnographical sketches (DUARTE ET AL, 2015) - developed by LASC-UFRJ - in conjunction with interviews.

Was possible to conclude that a “Maua Beach” was already “installed,” intertwined on the square, through the persistency of the uses (dive, fishing, contemplating, taking sunbaths). This confirms the argumentation that “installing an atmosphere is both taking place and giving place, both registering in a place and transforming it, adapting to it while activating it” (Thibaud, 2017). After all, the body is both a rhythm machine and a producer of space, capable of expressing and sharing, in addition to hiding the meaning (Lefebvre, 2004, 102); The folding of the body over itself is accompanied by an unfolding of imaginary spaces, since at each moment we demarcate one here and one now, in layers of heterogeneous spaces (Guattari, 2012, 135). Therefore, is possible to affirm that the body has an extrapolation capacity: of overcoming certain limitations by the physical environment. That is why one could affirm the bodies as one fundamental instance for founding places, firstly because place is directly related to meaning, and secondly because of the capacity that uses and relations have to express reinterpretations, desires, propositions for action that creates opportunities to engage.

The Entangled Ambiance: Memory Networks

The study developed led to a more intense reflection towards the concept of entanglement or intertwine. The definitions in the Portuguese language about the meaning of the word intertwine refer to linking, joining, interweaving, uniting different things in a loop. In the English language, the meaning of the word “entanglement” presents yet another dimension, that of strength: “entwined with” means to be involved in such a way with something or someone that it is difficult to escape; it is also related to capture, being captured in something like nets or ropes. In addition, there is a phenomenon of quantum mechanics, also called quantum entanglement that derives from this meaning of strong bond. This is the phenomenon that occurs when two subatomic particles can become so strongly connected that the actions taken on the first are able to immediately affect the second, even if they are separated by a very large distance (Fuwa et al., 2015). The approach to this understanding served to elucidate the meaning of the words intertwine/entanglement and clarify some effects observed on the urban scale by our research.

Entangled atoms are capable of mutually affecting and matching each other even if they are in different places in space. Making a poetic analogy, it is also possible to perceive in the city the existence of **emotional places** that permeate the physical-visible places. As observed on the research and discussed by some authors (Certeau, 2012; Fischer, 1993; Duarte, 2002;) - the lived space is distinct and not necessarily corresponds to the built space. Therefore one could use the term entanglement to refer to an urban reality where the physical place (a specific point in space) is able to host many different emotional places, both in the individual and collective spheres of subjectivity (non-physical), and that can be linked with memories of faraway places - as was observed in associations of memory networks regarding the character of the square. We also observed that the more collective assemblies establish a place through uses, the more the notion of that place is strengthened, through collective memories and a sense of identity. The quality of possible social ties in the same physical space facilitates the creation of specific emotional places, with specific characters. So, according to emotional places, there are several physical places. There are segregated places from which the different is physically excluded, where the mere existence of the other and otherness is considered a risk and removed physically; There are physical places where the different coexist, in a “democratic” aura, while quality of social ties is not changed. That is, physical places where alterities coexist and mix physically, but not emotionally: the emotional place can be separated from the physical. But

there are times when, in any type of physical place, the possibility of creating new emotional places arises through different propositions about the quality of the social bonds: this is the liberating power of bodies in action.

Acknowledgements

To the Coordination for the Improvement of Personal Higher Education (CAPES) for granting a scholarship during a year and half of this research. And to LASC, for all the support.

References

Bonitto-Donato, Céline. “Une lecture politique des ambiances urbaines: Entre hospitalité émancipatrice et stratégie disciplinaire.” *Ambiances in action / Ambiances en acte(s)* - International Congress on Ambiances, Montreal 2012, Sep 2012, Montreal, Canada. pp.609-614. halshs-00745869.

<https://halshs.archives-ouvertes.fr/halshs-00745869>

Deleuze, Gilles and Guattari, Felix. *Mil platôs: capitalismo e esquizofrenia 2, vol.2*. São Paulo: Editora 34, 2012a

Deleuze, Gilles and Guattari, Felix. *Mil platôs: capitalismo e esquizofrenia 2, vol.3*. São Paulo: Editora 34, 2012b

Duarte, Cristiane Rose; Pinheiro, Ethel. “Imagine uma tarde chuvosa... pesquisas sobre ambiência, alteridade e afeto.” Rio de Janeiro, 2013.

Duarte, Fábio. *Crise das matrizes espaciais: arquitetura, cidades, geopolítica, tecnocultura*. São Paulo: Perspectivas. FAPESP, 2002.

Fischer, Gustave-N. *Psicologia social do ambiente*. Lisboa, Portugal. Edições Piaget, 1994.

Fuwa, Maria, et al. “Experimental proof of nonlocal wavefunction collapse for a single particle using homodyne measurements.” *Nature Communications* 6.1 (2015): 1-6.

Guattari, Félix. *Caosmose*. 1ª ed. 1992. São Paulo: Editora 34, 2012.

Lefebvre, Henri. *Rhythmanalysis: Space, time and everyday life*. A&C Black, 2004.

Lipovetsky, Gilles, and Serroy, Jean. *A estetização do mundo: viver na era do capitalismo artista*. São Paulo: Editora Companhia das Letras, 2015.

Morin, Edgar. *Introdução ao pensamento complexo*. Trad. Eliane Lisboa. 5ª ed. Porto Alegre: Sulina, 2015.

Thibaud, Jean-Paul. “Installer une Atmosphère.” *Phantasia*, Université Saint-Louis, Bruxelles, 2017, Architecture, espace, aesthesis, vol 5. <https://popups.uliege.be/0774-7136/index.php?id=789.10.25518/0774-7136.789.hal-01878768>

Displacement: Architectural Collage

Investigating Atmospheres in a Design Studio

Jennifer A. E. SHIELDS¹

Abstract. During the construction of Hearst Castle in CA, W. R. Hearst purchased architectural antiquities from throughout Europe. His motivation was to create an atmosphere providing both rich multi-sensory perceptions and meaning through the cultural values embedded in the European spolia. In 1929, Hearst purchased a 14th century English tithe barn that was disassembled and shipped to CA, but never used. The current owner asked an architectural design studio to investigate how atmospheres might arise through the introduction of fragments of this ancient structure into public spaces in Cal Poly's Brutalist library. This paper will present the methodology and outcomes of the design studio that investigated how an architectural collage could prompt multiple modes of engagement.

Keywords. Atmosphere, Architecture, History, Collage, Bricolage

Displacement: Architectural Collage

During the construction of Hearst Castle in San Simeon, CA, William Randolph Hearst purchased art, architecture, and antiquities from throughout Europe to incorporate into his properties. Philosopher Umberto Eco describes William Randolph Hearst's acquisition of architectural fragments, saying: "The striking aspect of the whole is not the quantity of antique pieces plundered from half of Europe, or the nonchalance with which the artificial tissue seamlessly connects fake and genuine, but rather the sense of fullness, the obsessive determination not to leave a single space that doesn't suggest something, and hence the masterpiece of bricolage, haunted by *horror vacui*, that is here achieved" (Eco, 1986, 23). Eco suggests that Hearst's obsession stems from the lack of history (from a European point of view) in California. The architectural collages thus created were the result of architect Julia Morgan's creativity and adaptability to the whims of Hearst. Architectural collage can be a vehicle to foster atmosphere, utilizing architectural fragments in an ambiguous and incomplete composition which demands greater attention from the perceiver. This is true for both an embodied experience as well as the perception of an image.

Our individual experience of the built environment is bound by our perceptual capacities, including the intertwining of multi-sensory perception and meaning. These viewer-dependent aspects conspire with objective characteristics of architecture including physical context, style, age, dimensions, proportions, and materiality to produce atmosphere. In *Atmospheres and the Experiential World: Theory and Methods*, Sumartojo and Pink argue: "... atmosphere must be thought of as pulling together affect with sensation, materiality, memory and meaning, and call for close attention to what comprises such combinations and what they make possible or draw into being"

1. California Polytechnic State University, San Luis Obispo, Assistant Professor of Architecture, jeshield@calpoly.edu

(30). Sumartojo and Pink identify two perspectives by which atmospheres have been studied - in theory and in design - yet suggest that there has been little dialogue between the two (48). This paper seeks to parse out the role(s) of the architectural fragment in facilitating atmospheric experience in the application of theory to design.

Multi-Sensory Perception and Meaning

Our experience of a space is a result of our multi-sensory perceptions and meaning, which can't be studied in isolation. Sensory perception and meaning are bound by memory. In the Merriam-Webster dictionary, perception is defined as: "physical sensation interpreted in the light of experience" (perception, 2011). Individual memories as well as cultural factors shape our experience. As a semiotician, Eco emphasizes the meaning found in architecture as an "oscillation between primary function (the conventional use of the object, or its most direct or elemental meaning) and secondary functions (its related meanings, based on cultural conventions, and mental and semantic associations)..." (Eco, 1997, 203). Appropriated architectural fragments (*spolia*) have been utilized over millennia for both their potential to engage the senses as well as the multiple meanings they carry with them. "For *spolia* to succeed as evidence of the swing between two sites, the original source cannot be fully obscured if the newly combined elements are to have meaningful saliency in the present..." (Brilliant, 2011, 158). The displacement and reconfiguration of architectural fragments adds an additional layer of complexity to the oscillation of meaning described by Eco.

Graphic Representation: Suggesting Atmosphere

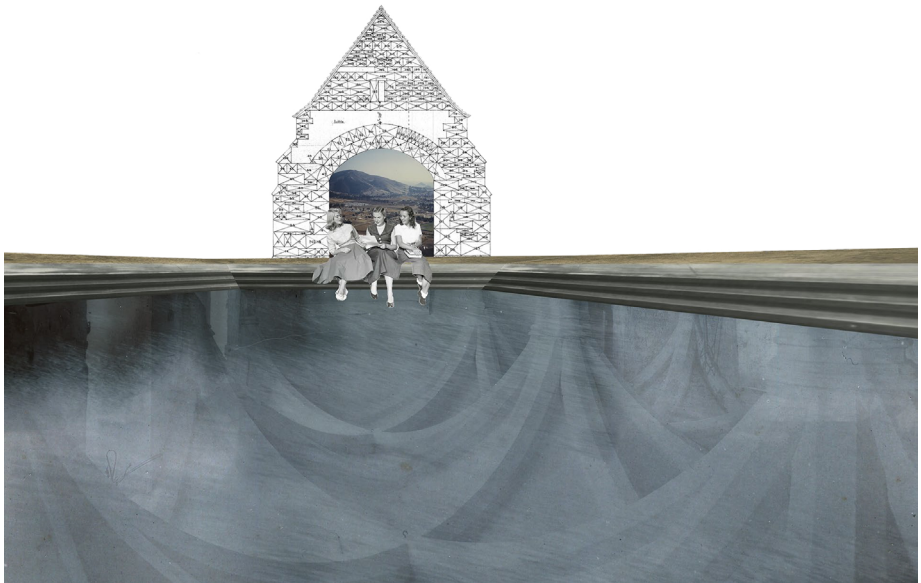

Figure 1. Concept Collage, Pacific Austin, 2020

Architects have a variety of representational tools at their disposal with which to communicate their design ideas. Drawings that speak to the experiential qualities anticipated in a design are imaginative drawings (drawing-as-provocation), in contrast with notational drawings (drawing-as-instruction), as defined by architectural theorist Sonit Bafna (2008). The imaginative drawing is intended to explore form, space,

materiality, scale, light, and/or use - which together can suggest atmosphere. Architects may choose either rendering or collage as media to convey atmosphere, though the veracity of the rendering can't be validated until the building is constructed. "There is always a gap between representation and reality... Sometimes architecture practices turn to digital collages either as a counteraction to hyper-realistic renderings, or simply because it can represent intention in design without formulating a specific image..." (Cutieru, 2020). In the absence of some of the previously stated characteristics, the collage, in its ambiguity, allows for multiple readings by the viewer. Collage as a tool for graphic representation provides a media through which architectural atmospheres can be suggested, if not comprehensively visualized. Juhani Pallasmaa claims: "Collage combines pictorial motifs and fragments from disconnected origins into a new synthetic entity which casts new roles and meanings to the parts. It suggests new narratives, dialogues, juxtapositions and temporal durations. Its elements lead double-lives; the collaged ingredients are suspended between their ordinary essences and the new role assigned to them by the poetic ensemble" (Shields, 2014, ix). With this parallel to the use of *spolia*, collage was the media through which students ideated and communicated their designs.

William Randolph Hearst's Spoliation of Bradenstoke Abbey

Bradenstoke Abbey, founded in 1142 in Bradenstoke, Wiltshire, England, emerged from its hilltop site over centuries. Limestone from nearby quarries and locally harvested English White Oak were used to construct the prior's hall, the priory church, the tithe barn, houses, cottages, and farm buildings through the 15th century. The tithe barn served to store tithes to the parish, as farmers were required to give one-tenth of their produce to the church. Upon the dissolution of the monasteries ordered by King Henry VIII in 1536, the buildings began to fall into disrepair. The abbey was privately owned by numerous English families over the following centuries, until a sales brochure caught the eye of William Randolph Hearst in 1928. In 1929, Hearst purchased the abbey, deconstructing the priory and rebuilding it at his castle in Wales. The 14th century stone and timber tithe barn was meticulously documented by employees of architect Julia Morgan, disassembled, and shipped to San Simeon from England.



Figure 2. Bradenstoke Tithe Barn interior photomontage, office of Julia Morgan, 1929 (image courtesy of Madonna Family Archive / Robert E. Kennedy Library Project)

"Hearst bought, in bits or whole, palaces, abbeys, and convents in Europe, had them dismantled brick by numbered brick, packaged and shipped across the ocean, to be reconstructed on the enchanted hill, in the midst of free-ranging wild animals" (Eco, 1986, 22). Hearst's motivation was to create an atmosphere providing both rich multi-sensory perceptions and meaning through the cultural values embedded in the European *spolia* (or their imitations). The Bradenstoke Tithe Barn was never reconstructed and was acquired in 1960 by a San Luis Obispo entrepreneur, still stored in

the original Hearst crates. To this day, the original stones and timbers of the barn sit crated and unassembled on a ranch in San Luis Obispo.

Architectural Design Studio: Methodology

The current owner of the tithe barn, whose father acquired it from Hearst in the 1950s, wants to give new life to the stone and timber fragments. He asked a fourth-year architectural design studio to investigate how atmospheres might arise through the introduction of fragments of the 14th century tithe barn into public spaces in Cal Poly's Brutalist library. The following sections present the methodology and outcomes of the design studio that investigated how an architectural collage could prompt multiple modes of engagement by intertwining multi-sensory perception and meaning. Considering a design intervention from artist Olafur Eliasson's perspective offers potential. "... we are often numb to the atmospheres that surround us. Here, architectural detail and artistic intervention can make people more aware of an already existing atmosphere. That is, materiality can actually make atmospheres explicit - it can draw your attention and amplify your sensitivity to a particular atmosphere" (Gernot Böhme et al., 2014, 95).

The methodology for this design studio prioritized research and analysis as critical precursors to a thoughtful design proposal. A deep understanding of the existing site and program, and the tithe barn itself, was crucial to envisioning atmosphere. Students completed a site/program analysis. Since we were intervening in an existing building, our site and program could not be viewed in isolation. This analysis asked students to thoroughly investigate the physical, functional, and experiential contexts in which they would intervene. Students were assigned to one of three sites for analysis and design: Entry Plaza, Courtyard (future Atrium), or Fourth Floor Terrace (future Reading Room).

Next, students studied Heart's *spolia*, the 14th century Bradenstoke Tithe Barn. Julia Morgan's documentation, coordinated with numbers stamped on stones, timbers, and crates, was to facilitate its reconstruction after being dismantled and shipped from England to San Simeon, CA. Students worked off of the original photographs and drawings to digitally reconstruct the barn for use in the design phase. In addition to the digital reconstruction, this phase included a historical and diagrammatic analysis, and a study of the material properties of the limestone quoin stones and oak timbers that were transported to California.

The schematic design phase asked students to conceptualize the role of the tithe barn in the library's public spaces. They were expected to develop a clear conceptual framework and narrative as well as a defined spatial and material strategy for integrating fragments of the barn with new construction and the existing structure of the library. Collage, as the broader theme for the studio, anticipated that disparate elements would be combined into a new, synthetic, composition. Students initiated their design process through collage: the drawings and photographs of the library and the barn that they had collected were used to create collages, which would suggest ways of integrating fragments of the barn into new public spaces for the Library. They created three digital collages ranging from the most minimal yet impactful intervention to a Hearst-inspired *horror vacui* collage. After the collage charette, students translated the results of their analyses and collage interpretations into an architectural proposal. Design development and graphic representation for presentation invoked collage, 3D modeling, and orthographic.

Architectural Design Studio: Outcomes

Multiple stakeholders were involved throughout the quarter, advising and guiding students in the design process. Contributors included library faculty and staff, the owner of the tithe barn, the Director of Hearst Castle, and architects and landscape architects from around the country. Understanding that “Atmospheres cannot make people feel particular things...anticipation, foreknowledge and pre-existing views of different material and immaterial elements play a crucial role in how atmospheres are co-constituted and perceived (Sumartojo 2016),” it was valuable to have the input of a range of stakeholders (Sumartojo and Pink, 2019, 5).



Figure 3. Design Proposal for Library Reading Room, Anja Wimmer, 2020

In order to assess the design proposals, each student evaluated every other proposal. The four data sets collected were:

1. Multi-sensory experience;
2. Communication of meaning - in graphic representation;
3. Multi-sensory experience
4. Communication of meaning - as imagined if the project were built.

The data showed that some projects had consistency between the graphics and the anticipated experience, while some were poorly represented, and others may have oversold the experience graphically (at least in the imagination of the viewer). From the perspective of communicating meaning, students rated more highly those projects that retained the integrity of the barn fragments and often their spatial relationships, as well as those projects that minimized the introduction of new construction (Fig.3). We did not receive quantitative feedback from the stakeholders, but their responses in the final review were consistent with the student evaluations.

Conclusions

Pallasmaa observes that ambiguity - in representation and in architecture - provides space for the imagination of the viewer or occupant. This is validated by neurologist Semir Zeki's research on “the neural ground of artistic image and effect” in which he points to the power of Michelangelo's unfinished slave sculptures (Pallasmaa, 2015, 66). This suggests that the incomplete collage-like nature of the proposed interventions could be experientially powerful. Like Hearst's appropriated fragments, “With its voracious vitality, history robs architecture of its meaning and endows it with new meaning” (Eco, 1997, 203). Engaging fragments of a 14th century barn with a Brutalist library could create new narratives with new potentials for individuated sensory experience and meaning.

References

- Bafna, Sonit. "How Architectural Drawings Work - and What That Implies for the Role of Representation in Architecture." *Journal of Architecture* 13.5 (2008): 535-564.
- Brilliant, Richard, and Dale Kinney, eds. *Reuse Value: Spolia and Appropriation in Art and Architecture from Constantine to Sherrie Levine*. London: Taylor & Francis Group, 2011.
- Cutieru, Andreea. "Architects' Diverse Positions on Visualization: From Hyper-Realistic Renderings to Digital Collages." Accessed June 25, 2020.
<https://www.archdaily.com/941870/architects-diverse-positions-on-visualization-from-hyper-realistic-renderings-to-digital-collages>
- Eco, Umberto. *Travels in Hyper Reality: Essays*. First edition. San Diego: Harcourt Brace Jovanovich, 1986.
- Eco, Umberto. "How an Exposition Exposes Itself." In *Rethinking Architecture: A Reader in Cultural Theory*, edited by Neil Leach, 201-204. New York: Routledge, 1997.
- "Atmospheres, Art, and Architecture." In *Architectural Atmospheres*, edited by Christian Borch, Gernot Böhme, Olafur Eliasson, and Juhani Pallasmaa, 90-107. Basel/Berlin/Boston: Birkhauser, 2014.
- Pallasmaa, Juhani. "Body, Mind, and Imagination: The Mental Essence of Architecture." In *Mind in Architecture: Neuroscience, Embodiment, and the Future of Design*. Cambridge, Massachusetts: The MIT Press, 2015.
- Shields, Jennifer A. E. *Collage and Architecture*. New York: Routledge/Taylor & Francis Group, 2014.
- Sumartojo, Shanti, and Sarah Pink. *Atmospheres and the Experiential World: Theory and Methods*. New York: Routledge/Taylor & Francis Group, 2019.
- "perception" in *Merriam-Webster.com*. Accessed May 8, 2011.
<https://www.merriam-webster.com/dictionary/perception>

Happy Atmospheres

Metro Stations as Sound Places of Happiness

Nicolas REMY^{1,2}, Evangelia PAXINO²

Abstract. Taking up the slogan of the teams of architects “for happy architecture” for the design of the new E line of the metro in the Lyon area (France), this paper defends the idea of a happy atmosphere as a design tool. The research presented here focuses on the sound dimensions of the architectural project. Principles of a sound charter are discussed and ambiance creation is thought through the design of tensions between the material, sensitive and symbolic conditions of the experience of a back plan and the conditions of appearance of sound events. Ambiance design is a means of liberating the perception and representation of metro’s users and a method to design sensitive worlds for the public, participating in this way in the renewing the ordinary experience of the metro.

Keywords. 1 Metro, Ambiances, Events, Sounds, Acoustics, Charter, Happy Places

Introduction

In the frame of a project management assistance mission for the definition architectural identity of the future E metro line in Lyon agglomeration (France), the architects and landscape designers Gautier and Conquets, with Paul Vincent architect, helped by several technical studies offices (sustainable design, lightning design, acoustic design, engineering) worked in 2019 in the redaction of the an architectural charter in order to renew the metro’s stations design. The metro stations, designed today to be delivered in 10 years, are designed in a way that let the architects to set a simple question for the future of the metro line: how we can renew the canons of architecture in order to offer to the future user an “happy experience” when they will practice these spaces?

The Sytral³ mixed transport union designs, builds and maintains the main metro lines in the Lyon metropolitan area. It therefore also carries development projects and had therefore initiated an in-depth reflection on this type of transport in 2019. The future line E would be a line with little traffic and would link the municipality of Alaï to the Place Bellecour in the historic center of Lyon - it even in connection with the other metro lines of the city. It is therefore a question of rethinking for Sytral 4 metro stations so that they are the expression of an architectural renewal of these services spaces.

1. University of Thessaly, Department of Architecture, Greece, nremy@uth.gr

2. CRESSON, School of Architecture, Grenoble Alpes University, France, evangelia.paxinou@gmail.com

3. Sytral is Mixed transport union for the Rhône and the Lyon metropolitan area, see <http://www.sytral.fr>

Gautier and Conquet architects⁴ with Paul Vincent architects⁵ had an original proposal based on the following principles. Experiencing metro station need to be renewed mainly because of the several crises that our societies cross. Obviously, the global environmental crisis and the injunctions of the different European governments regarding the energy transition push all the actors of the construction to rethink the different modes of transport in our contemporary cities. If we are to build the transports of tomorrow, these transports, through their technical progress, must offer future users a different experience of these places. The originality of the architectural team is to propose an architectural charter which gives the contours of a conception of a happy architecture. Designed as a guide of good practices that articulates architectural principles and a technical and sensitive guide, this charter is an opportunity to go beyond energetic performance labels for buildings (certification LEED, HQE⁶, WELL⁷) and aims to offer criteria of comfort or even criteria of well-being.

The architectural charter as formulated by the architects clearly aims to offer future metro station users an “happy architecture.” We take this slogan to the letter and try to show how the charter can promote the appearance of a happy experience in terms of building acoustics and in the set of sounds that users can hear during the practice of these future spaces.

Happy Architecture for Happy Atmospheres

We base our reflection on the notion of ambiance as proposed by several authors from CRESSON⁸ research team at the Grenoble School of Architecture, Alpes University. (UMR CNRS Ambiances, Architectures, Urbanités). An atmosphere takes on meaning in our perception when, through our actions and our perception, we perceive a certain number of events (sound, visual, tactile, olfactory, etc.) which emerge from the background. For example, the highly reverberated sound of a woman’s heels in a subway gallery can potentially trigger feelings of worry and fear. On the other hand, the same space, if it offers many footsteps for listening, coupled with that of conversations, will thus be perceived in a more positive way and can participate, in the same way as the other sensitive dimensions of architecture, to establish a public, lively, comfortable and cheerful atmosphere. We thus use the works of Bohme and Thibaud (Bohme and Thibaud, 2018) which show that an atmosphere is composed of different sensory solicitations (sound, sight, touch, movement) which participate in creating in the ordinary perception of the passer-by a back plan from which events emerge. These events give the general meaning to the atmosphere and thus give it a tone. Our work therefore aims to design the architectural spaces of metro stations in order to give them a happy tone by the sounds. Evangélia Paxinou sees this dialogue between the back plan and the events as a dynamic tension (Paxinou, 2017a) and shows how many public places in Europe have been designed and built according to this principle. This tension oscillates between three states - conflict, negotiation and sympathy - and then becomes for the end user and for the architect designer a game from which a remarkable atmosphere emerges (Paxinou, 2017b). In other words, it is possible to design the ambiance of a place by considering the sensory solicitations which will participate in

4. Gautier and Conquet architects, <http://www.gautierconquet.fr/fr/>

5. Paul Vincent Architect, <http://paul-vincent-architecte.com/index.php>

6. HQE for “Haute Qualité Environnementale,” LEED for Leadership in Energy and Environmental Design.

7. Certification WELL is a certification tool for advancing health and well-being in buildings globally, <https://www.wellcertified.com>

8. CRESSON Team, laboratory “Ambiances, Architecture, Urbanités”, CNRS, School of Architecture of Grenoble, Alpes University.

establishing a back plan and those which will participate in the creation of events. With regard to acoustics, we can therefore “assess” today the main principles of the architectural charter to try to “pre-hear” the sounds that will participate in the creation of the soundscapes of the sites.

It is very difficult to predict people’s happiness, especially in a busy public space with significant climatic variations (summer/winter, day/night) and with variations of uses. The metro station must be able to offer happy moments to everyone, at every moment of the day and year through its atmospheres. We interpret this ambition of “happy architecture” as a desire to offer spaces with an assertive, differentiated identity for which the acoustic comfort of these spaces is comfort that goes beyond the regulations. In other words, we believe that the architectural charter should push future project management teams not to offer neutral spaces “which do not please and which displease anyone” but rather to offer spaces and a “unique” experience for each.

Games and Pathways for a Happy Sound Ambiance

Designing an atmosphere therefore means thinking about the tensions between the sensory (sound for us) solicitations of the events and those which participate in the back plan. We hypothesize that the games and the pathways are the potential sound responses to the charter’s injunction to offer happy architecture. It is therefore possible to think of a series of sound events (affordances) within the architectural charter, which will have every chance of being perceived and activated by future users.

For us, the joy of walking through spaces is precisely this joy of becoming aware of a series of (sensitive) events that reveal the (public and happy) back plan of these places. It is becoming aware of where I am, it is participating in the creation of the atmosphere; It is becoming aware of your own feelings and it is also understanding that my actions, along with those of others, contribute to the construction of one or more remarkable atmospheres.

Work on human voices (their intensity, their intelligibility) can promote the appearance of a playful and happy atmosphere at the level of the platforms and this regardless of the use of spaces (with or without public). The idea is to present what future users of the metro line might hear coming from the public space to the metro train, distinguishing what would fall to the acoustics of the places crossed (passive acoustics: insulation, reverberation) and what would be linked with the presence of sound sources and events produced: the noisy and sonic technical objects met during the pathway, the sound sources produced by users in place - sound design of the sound sources, noise reduction, “musical” composition of sound paths (Rémy, 2001).

The ambition is to offer a sonic pathway (sounds) that is constantly renewed (which does not fall into the routine), comfortable (which is not aggressive as regards sound levels, sufficiently clear as regards intelligibility sources), which would be recomposed on each journey according to the sound qualities of the spaces crossed and the possible presence of sound sources.

In this sense, from an acoustic point of view, spaces crossed are relatively differentiated (change in volume, sound color) and thresholds between these spaces are also designed from the sound point of view (Rémy, 2001) - sound help users to perceive they change spaces during their pathway. Visual communication is also available in sound communication (choice of appropriate jingle, variation of the acoustic qualities of spaces according to their depth - surface, basement, underground spaces, galleries and metro platform).

Material and geometry of the spaces are also set in order to minimize reverberation and increase speech intelligibility. The sound and the acoustics of the places promote in the perception an image of a domestic space in which users recognize themselves and enjoy finding their visual and sound reference points associated to their travel. Spaces welcome artists and activities from the neighborhood and thus participate in a sound composition that is constantly renewed. The materials are not reflective, they offer matt acoustics and interactive sound games between the surface and the underground revitalize sometimes difficult spaces such as underground galleries.

It also seems important that sounds fully participate in the (universal) accessibility of places. Regulatory constraints related to fire safety and the diffusion of announcements are obviously participating in the series of recommendations but we believe that the charter is an opportunity to go beyond these recommendations by offering in each place a peaceful and clear listening and clear of messages broadcast but also of the sound atmosphere of the site.

Sounds of nature are also present and change the image of these technologic places. Machines and trains are chosen to reduce as the maximum noise emitted and the whole space is sounds familiar because of the presence of the human voices. Sound is by definition a dynamic phenomenon, architectural space is also dynamic, but surely the atmospheres created are therefore the response to a happy architecture. Let's compose the soundtrack for future users, this is to give the architectural charter a tone of happiness atmospheres to share

Discussion

The ethical dimension of the design of environments therefore becomes very important to discuss. The technical and architectural solutions proposed in this charter obviously raise the question of capacity, but we would say of the right of the designer, to offer happy spaces. The client of the architects is obliged to apply the regulations to ensure the smooth running of his services and of course to ensure the safety of goods and people. These constraints are very important and often appear in contradiction with the proposals of the charter. For example, the maintenance constraints of surfaces (floors and walls) of underground spaces are difficult and require the use of hard, reflective and washable materials. The consequence of this is to create spaces that are often too much reverberating that scramble the speech intelligibility and thus make the acoustics uncomfortable.

Our proposal also implies the active participation of users in the co-construction of spaces but also of future atmospheres of these spaces. This thus poses problems of security and respect for private life for spaces which are not legally completely public spaces. The degradation of the equipment of this typology of space often forces the addition of architectural prostheses which aim to exclude a part of the population and which obviously go against a sharing of the atmospheres of a happy architecture.

Finally, as a designer, what to think of a proposal aimed at the happiness of users? There is here a semantic trap for which the architectural design but in general, the production of architectural spaces must be ethically positioned. It is obvious that it is unacceptable to think of the happiness of people without their consent. In the same way, to think of the design as a sum of small pleasures while thinking these proposals are a happy way of practicing the spaces of the metro, it is a way to say that creators can foresee the feelings of the future users. This idea is also completely unacceptable. There is every chance that these proposals are valid only for a small majority of people and that this soft design that is to say a design that does not displease anyone but

which no one likes either.

The atmosphere therefore becomes a notion that allows the designer to escape these determinist traps. The atmosphere is a tone, it is partly designed by the architects but it is indeed the future users who, through their practices, create it through their co-presence and their co-practices in the space. The architect is perhaps at the origin of a mold which perhaps defines the contours of an experiment. By giving users the freedom to perceive and practice a space, that is to say by giving them the possibility of composing their soundtrack of their way, we give back the capacity, through the atmosphere, to the users to feel and build freely the atmosphere of the place. To think of a happy architecture is therefore to think of a differentiated, clear, articulate sound experience of places where sound events give a different tone, we hope happy, to a more uniform background linked to the practice of metro spaces.

References

Böhme, Gernot, Thibaud Jean-Paul (Ed.), *The æsthetics of Atmospheres*, London: Routledge, 218p. 2018.

Gautier and Conquet architects, Accessed, June 2020.
<http://www.gautierconquet.fr/fr/>

Paul Vincent Architect, Accessed, June 2020.
<http://paul-vincent-architecte.com/index.php>

HQE for “Haute Qualité Environnementale,” Accessed June 2020. www.behqe.com

LEED for Leadership in Energy and Environmental Design, Accessed June 2020.
<https://www.usgbc.org/leed>

Paxinou, E. *Ambiance Creation in Architecture. A challenge for the design of the urban public space*, Aristotle University of Thessaloniki, School of Architecture: Thessaloniki, 2017, 392 p., (tel-01527083)

Paxinou, E. *Playing with the ambiances in the city*. International and interdisciplinary conference “Children’s spaces or spaces for children,” May 2017, Thessalonique, Greece. (halshs-01700384)

Nicolas Rémy. *Maîtrise et prédictibilité de la qualité sonore du projet architectural: Applications aux espaces publics en gare*. Mécanique [physics.med-ph]. Université de Nantes, 2001. Français. (tel-00087818)

Rémy, Nicolas, Tixier, Nicolas. *Ατμόσφαιρες, αύριο. Ambiances, demain. Ambiances, tomorrow*: Proceedings of 3rd International Congress on Ambiances. Volos, Grèce. vol. 1 ; Vol. 2, International Network Ambiances ; University of Thessaly, 1015 p., 2016. (hal-01459043)

Sytral: Syndicat mixte des transports pour le Rhône et l’agglomération lyonnaise, Accessed, June 2020, <http://www.sytral.fr>

WELL Certification WELL is a certification tool for advancing health and well-being in buildings globally, Accessed June 2020, <https://www.wellcertified.com>

06

FROM A SENSITIVE ECOLOGY OF
AMBIANCES/ATMOSPHERES TO A POLITICAL ECOLOGY

07

INFINITE ATMOSPHERES? ETHIC DIMENSIONS
OF AND FOR THE DESIGN OF PUBLIC SPACES

08

INHABITING INSECURITY.
PRACTICES AND REPRESENTATIONS

VOLUME 2

09

PHYSICAL/DIGITAL SPACES COLLISIONS. SO WHAT?

10

PRESENCING ATMOSPHERES

Inhabiting Insecurity. Practices and Representations

Session 8 – Introduction

Alia BEN AYED¹,
Olfa MEZIOU²

Within the current prevailing insecurity climate, humans develop and integrate, to their daily life, individual and collective strategies to continue living an ordinary life, to ensure a continuum of habits and corporality. These strategies, be they more refuge or navigation, rely on space devices, prosthesis, high-tech gadgets, specific movements and practices, etc. The immunity issue (Sloterdijk, 2005) underlies, more than ever, living practices in their uses, their representations and their cartographies of the place, the city, the world and their own body. How is this insecurity cartography built and what practices does it generate? What are their impacts on the construction/conception of both our paths (Virilio, 1996) and our interiors, that is to say, on our relationship to both the public and the private spaces? Can we say, like Virilio concerning speed, that insecurity is a milieu?

In order to answer these questions, we have proposed some clues for reflection :

Sense of Self and space representation

If inhabiting is a sense of self in space (Sloterdijk, 2005), how does insecurity impact this sense? What are their atmospheric determinants ? How do they affect our “body status” (Guisgand, 2012) ? what is the share of the factual and the psychological in our representations of territory security or insecurity?

Stays and paths in insecurity

In 1993, Morphosis published *Connected isolation*. The monography title sums, according to Sloterdijk, the big principle of modernity. Six centuries before, around 1300, Guillaume de Saint-Pathus distinguished two aspects of existence: the home and the ride (la demeure et la chevauchée). How is insecurity expressed through these modalities of existence: stay and journey, openness and isolation? For Sloterdijk (Sloterdijk, 2005), being is inhabiting an island, investing an interior. In the most private space to the most public one, in our staying spaces as on our paths, we are supposed to continually try to build interiors, bubbles. How are these atmospheric interiors shaped? How are their limits, their thresholds and their openness to the world defined?

Safeguard atmospheres

Due to the increase of insecurity, barricades are rising, surveillance is amplifying,

1. ENAU (National School of Architecture and Urbanism), ERA Laboratory, Tunisia.

2. ENAU (National School of Architecture and Urbanism), ERA Laboratory, Tunisia.

“pacification,” security and labelling operations are widespread. What are the atmospheric consequences of security? Do they hinder our freedoms? Do they exacerbate inequalities or, on the contrary, do they smooth them out? Do they in fine change the feeling of insecurity? How do they affect our ways of being together? Can we really live in the “guarantee city” (Breviglieri, 2013)?

The papers presented here may have taken for thought, other routes. They show that insecurity perception is a matter of senses and sens more than a matter of reality. For Farzaneh Semati and Hamidreza Ghahremanpour but also for Isabel Barbas, the common hypothesis is probably the link between insecurity and incomprehension of space. Semati and Ghahremanpour show that the unknown lead to the emotion of fear while Barbas expose the capacity of ephemeral artistic practices to enlighten us about a world blurred by the virtual whose reality now escape us.

Ari Koivumäki confronts the field. His text shows the difficulties in constructing and complementing a method - especially in times of Covid 19 - to define the real factors of safety (and unsafety) sense.

But for all, the question remains the same, a question for designers : how to build a more livable city.

References

Marc Breviglieri, “Une brèche critique dans la “ville garantie” ? Espaces intercalaires et architectures d’usage”, in Cogato-Lanza, E., Pattaroni, L., Piraud, M. et Tirone, B., De la différence urbaine. Le quartier des Grottes / Genève, Genève: Métis Press, 213-236, 2013.

Philippe Guisgand, Étudier les états de corps. In : Spirale, n°242, pp. 33-34, 2012

Antoine Picon, « Le temps du cyborg dans la ville territoire. Vers de nouvelles métaphores de l’urbain. » In : Les annales de la recherche urbaine, n°77, Emplois du temps, pp.72-77, 1997.

Peter Sloterdijk, Ecumes. Sphères III, Paris, Libella Maren Sell, 2005.

Paul Virilio, Cybermonde la politique du pire, entretien avec Philippe Petit, Paris, les éditions textuel, Collection Conversations pour demain, 1996.

MAG

Material Atmosphere Gravity

Abstract. This essay reflects on ephemeral artistic practices in the contemporary city and their critical capacities in the face of the alienation, insecurity and fear that we feel in the public space. We live in an atmosphere of anguish in today's liquid society. Our relationship with the Media, mainly digital, with the public space and with knowledge, is mediated by an 'economy of attention', which reduces space by expanding time. How do architects and artists answer these questions? Based on artistic interventions in the urban space, we intend to verify how their approaches/installations contribute to critical thinking in the face of contemporary environmental, political and social circumstances.

Isabel BARBAS¹

Keywords. *Urban, Art, Installation, Architecture, Ephemeral, Atmosphere, Landscape*

MAG (magazine)

“Literary performance can only be meaningful if it emerges from a rigorous alternation between action and writing; it has to elaborate on flyers, brochures, newspaper articles and posters, the unpretentious forms that better correspond to its influence on active communities than the ambitious universal gesture of the book.” (Benjamin, 1992, p. 37)

If we replace “literary performance” with “architectural performance” and “book” with “building,” this paragraph could summarize this essay: show that through small ephemeral and playful projects, of an architectural and artistic nature, it is possible to influence more the active communities of determined urban environment, than through the universal gesture of building.

Cities have always been centers of artistic production and social reflection. In the 20th century, from the Dadaist urban ready-made, through the surrealist wanderings, through Benjamin's walks, through the Lyricist drift, the Situationist's playful-constructive-action and the more recent urban-art, the action of intervening in the urban space has been used as an aesthetic form of replacing the representation of the city (ideal) by 'intervening' in the city (banal). Since then, cities have been the scene of many reflections by artists and architects.

More than ever, this reflection is urgent in cities comparable to forests - a concept that we can interpret according to the urban spaces in which we live, which are

1. LEAU, *Laboratório Experimental de Arquitectura e Urbanismo, Universidade Lusófona, Lisboa, Portugal*, isabel.barbas@ulusofona.pt, <http://isabelbarbas.blogspot.com/>

increasingly complex and often alienating. Questions of value, use, scale, form, rhythm, time, overlap and dialogue with our inner space (our dreams, expectations, values) hostage to a digital age that simultaneously seduces and imprisons us in a virtual context that we do not dominate, creating feelings of insecurity and fear. Bauman talks about these issues in *Confiança e Medo na Cidade* (2006).

Other studies reveal that we are victims of an “attention market” that isolates us. Our relationship with digital media, public space and knowledge is mediated by the “economy of attention,” which reduces space by expanding time, while compressing it as explained by Bruno Patino in *La Civilization du poisson rouge* (2019).

Byung-Chul Han also warns of the excess of stimulus and information that we are subjected to daily, establishing a parallel between current society and wildlife. Man, like the wild animal, has to be attentive to everything around him, which is why he is losing perception skills and developing a new form of attention: *hyperattention* - a way that does not favor the contemplative attention proper to the creative and artistic minds. According to Han, this capacity can only be rescued by art and culture - propitiating “deep attention” (2014).

On the other hand, the concept of Forest, as an architectural space, offers ample stimuli for the peripheral vision, that is, the type of phenomenological vision that Pallasmaa defends to be the one that most authentically apprehends the space itself and defends us from the alienating egocentrism of the neoliberal world and digital hyper communication that separates us from real space: “A walk in the forest is invigorating and healthy thanks to the constant interaction of all types of senses; Bachelard speaks of the ‘polyphony of the senses’. The eyes collaborate with the body and the other senses. Our sense of reality is reinforced and articulated by this constant interaction. Architecture is, in the final analysis, an extension of nature in the anthropogenic sphere, providing the basis for the perception and horizon of experimentation and understanding of the world” (2011, 39).

The architect Sou Fujimoto argues that the architecture of the future will be like a forest: “Everything will harmonize in the diversity that will characterize the city of the future. This new space will emerge from the relationship between order and chaos” (2013).

The city is the privileged center from which we can assess the human condition. Since Henri Lefebvre, the hegemony of the urban over society as a whole has been problematized. Lefebvre has always argued in favor of the social construction of space, arguing that the city is not the physical expression of a set of buildings. The city is, instead, the social, sensory and emotional life that takes place between them, that is experienced in the spaces of the streets and squares, and in the significant encounters that take place in these in-between spaces.

Subjugate to certain innovative strategies, urban spaces can deepen the crisis of the city and dissociate itself from it. The question to ask is how these spaces can be socially rescued and brought back to the “city center.” Lefebvre would respond “by strengthening citizenship, by the right to urban life, transformed and renewed” (Fortuna, 13-14).

The city is an unfathomable field and there are many possibilities to act on it, from urbanism to urban design, from large-scale policies to local decisions, from architecture to sociology; there are countless players in the process of making cities. However,

the city only has meaning as a place of daily life. For centuries, the ‘streets’ have offered its inhabitants a public space complementary to the domestic space. The layout of the city’s streets and squares was compatible with walking, because the inhabitant was, above all, a city walker.

The modern city, due to the supremacy given to transport as a fundamental element of urban design and the legacy of functionalist principles, passing through the issues of control, fear, value and alienation mentioned above, reached a point where its streets and squares expel the people rather than integrating them. They are ‘centrifugal’, not ‘centripetal’ spaces and, therefore, do not promote socialization.

We think that Art (artists and architects), refusing the commercial, mercantilist, digital, transparent and flat society (Han, 2016), acting in the textured city, with a social sense, can contribute to catalyze critical and collective energy necessary to regenerate urban space.

As social networks compromise the social dimension, putting the ego at the center - Han tells us in an interview with *El País* that despite digital *hyper communication*, loneliness and isolation increase in our society², it is urgent to encourage coexistence and social participation in the collective life of the city. Ephemeral-artistic installations can function as spaces for socializing and proximity.

Despite the moment in which we live (Covid-19 crisis) and the physical proximity is increasingly limited, leading to a loss of community experience, the ‘street’ is still the place where we can interact and establish community bonds, as it happened at celebrations and ancient rituals. Nancy Duxbury, in *Animation of Public Space Through the Arts*, defends the idea that the passage of artists through a city can open potential spaces for reflection on the daily use of public space.

The artist António Olaio writes, in that same book, about the importance of Art in the city: “The experience of a city can be a very complex thing, which art can help us to understand. Through the eyes of the artists, through the relationships between the visual and the conceptual, artists can reveal some complexities of the aesthetic experience of a city” (Duxbury, Olaio, 2013, 115).

People have a natural capacity to adapt to the transformation of external conditions in the urban landscape. Placed before ephemeral ‘artistic objects’, they are confronted with the *before* and *after*, that is, these objects create a ‘friction’ in the relationship with the daily space creating a critical discourse in relation to the place: “The content is produced when people pass by from a state of indifference to a state of difference,” explains Eliasson (2012, 120).

Material-Atmosphere-Gravity

To understand the relationship between architecture and ephemerality, we would have to travel until the emergence of the first dwellings in which the need for mobility overlapped the durability. Vegetable materials (fabrics and wood), animals (skins and bones) and natural materials (ice or clay) built the nomadic habitat. In the transition to sedentary lifestyle, previous structures evolve. They start integrating more durable materials such as stone, then cement, followed by iron, steel, up to new technologies and contemporary materials such as plastic, sound and light. The history of architecture illustrates it, but also the whole complex genealogy of ephemeral structures for

2. See at : https://elpais.com/cultura/2020/05/15/babelia/1589532672_574169.html?ssm=FB_CC

agriculture, industry, housing (emergency), commerce for leisure and celebrations (parties, scenarios or pavilions).

We highlight, due to their high degree of experimentation and innovation, the pavilions of universal exhibitions that seek to express in a striking way the scientific, technological, artistic and political advances of a nation. Take, for example, the Philips pavilion for Expo 58 in Brussels, designed by Le Corbusier and Iannis Xenakis, whose architectural principle and shape follows the same parabolic line as the frequency curve flows used in the musical pieces *Metastasis* and *Concret PH*, by Xenakis, enabling an intimate relationship between music and architecture, conceiving an innovative and symbiotic space.

This type of ephemeral structures tests questions of lightness, speed and prefabrication in their construction processes and explores contents that are part of an artistic genealogy. The artistic pavilion that has emerged in the art in the city is a hybrid between the design disciplines and the artistic disciplines emphasizing the idea of performativity and temporality. The series of ephemeral pavilions granted by Serpentine³, self-titled “global platform for experimental projects by some of the world’s greatest architects” well illustrate this. Many of these examples point to the conversion of the ‘pavilion’ into an ‘environment’. We can also call these ambiances “architectural landscapes.”

Take, for example, the Sou Fujimoto Pavilion. It was conceived as a free-flowing social space that the author described as “transparent ground.” With this experience he wanted to investigate the possibility of fusing architecture and nature, or, how architecture can be part of nature, and what are the boundaries between the natural and the artificial⁴. This geometric ‘cloud’ expands the boundary between the interior and the exterior, inviting users to explore this undefined frontier. While it is a meeting space, it is also a ‘game’ space that invites the exploratory movement of the body over the ambiguous three-dimensional surface (constructed by cubes defined only by its metallic edges). This transparency works as an ‘atmosphere’ onto which perspective images are projected (of the palace in front and of the surrounding garden) inhabited by the participants themselves, who thus become part of this diluted ‘whole’. The propositions are several, as a child will be able to see in this environment a giant amusement park. Like Van Eyck’s playgrounds, the lack of definition of use presupposes a degree of freedom of use that attracts the user and places him in a scenario of experimental inquiry. In *Homo Ludens*, Huizinga observes that the difference between play and seriousness is always fluid and that “playing becomes a serious thing and a serious thing becomes a game” (1955, 10).

Modernism and its vanguards established a lineage of disciplinary reconfigurations through the exploration of concepts such as the *fourth dimension*, the *total work of art* (which will find its fulcrum in the idea of environment) and more recently the *expanded field* - or art in general that includes *play*.

The penetrability situation inherent in the formulation of a sculptural/architectural model that has been problematized since Kurt Schwitters’ *Merzbau* (introducing the spectator’s ambulation), passing through Tatlin and his *Monument to the III International* (synergetic exercise between architecture, sculpture and painting, praising the physicality of the tactile), to the *Parangolés* by Hélio Oiticica (wearable sculptures -

3. See at: <https://www.serpentinegalleries.org/whats-on/explore/pavilion/>

4. See at: <https://www.serpentinegalleries.org/whats-on/serpentine-gallery-pavilion-2013-sou-fujimoto/>

painted tissue - inspired by the organic architecture of the *favelas* and *samba*), to the *Bichos* of Lygia Clark (one of the pioneers of participatory art) until Robert Morris 'objects' that use wood or metal, soft, flexible or recycled materials, investigating qualities of weight, gravity and balance applied to his *Judson concerts* or in the exhibition *Bodyspacemotionthings*⁵ (in which the spectators were invited to manipulate huge sculptures as if they were in an amusement park), we witness the "transmutation of sculpture into another practice, immersion in the real space and, later, in the real body" (Sardo, 2017, 155-182).

The "real space," referred to by Sardo, is the public space of the city (where the *parangolés* perform), but it can also be the space of the theater as seen in Morris. The instability of the sculpture's liquid identity, poured into three-dimensionality, corporeality, cocoon or practice, reflects the "increasing fluidity between the themes of the great event of collective narratives for the themes of the small event of individual perceptive expansion, with everything that would result in restructuring the sociability contract, now centered on the negotiation of contact zones between subjectivities" (Sardo, 2017, 173).

This new possibility that is established between the work and the participant, adding up the dissolution of the 'figure-ground' relationship, claiming the peripheral vision, when taking the floor as a walking territory in the sense of Guy Debord's drift, enables another type of landscape intervention - a field of objects that do not have a focal center.

By tradition, intervention in the public space was associated with the statuary and the great monument charge of celebratory meaning. In Bauman's current *Liquid society*, public art has been replaced by this type of "landscape intervention" of ephemeral objects, materialized with light, sound, interactivity, movement and recycled or natural materials.

The phenomenon of land-art is worthy of mention in the genealogy of these ephemeral constructions and its influence is felt in contemporary artistic approaches. See the example of Olafur Eliasson's *Ice Watch*⁶ with the installation of giant blocks of arctic ice in prominent public places warning of climate changes: direct and tangible experience of melting arctic ice, aesthetically creating an environment that changes from solid to liquid, marking, like clockwork, the passage of time - beautiful metaphor that could illustrate Zygmunt Bauman's thinking about liquid modernity. Bauman's analysis of the consumer society that could be summarized in the axiom: "I am only if I consume," took the planet to the current emergency condition that is exalted by these works by Olafur.

Space cannot be defined if we do not include our experience of it. And individual experiences have an impact on the formation of collective spheres. I believe that this is an important socializing potential. Artistic and architectural interventions in the city can activate a state of presence, involving the public, fostering social relationships.

"In my city, for me, I'm invisible but I can see, I can see everything but me" António Olaio sings to us in an artistic assault on the city of Coimbra showing that as city dwellers it is the other that makes us what we are.

5. See at: <https://www.youtube.com/watch?v=leUiL5vzSZA>

6. See at: <https://olafureliasson.net/archive/artwork/WEK109190/ice-watch>

References

AA.VV., Duxbury Nancy (coord.). *Animation of Public Space Through the Arts / Toward More Sustainable Communities*. Coimbra: Edições Almedina, S.A. 2013.

Bauman, Zygmunt. *Confiança e Medo na Cidade*. Lisboa: Relógio D'Água, 2006.

Benjamin, Walter. *Rua de Sentido Único e Infância em Berlin por volta de 1900*. Lisboa: Relógio D'Água, 1992.

Debord, Guy. *Internazionale situazionista 1958-69*. Torino: Nautilus. 1994.

Eliasson, Olafur. *Ler es respirar, es devenir - Escritos de Olafur Eliasson*. Barcelona: Editorial Gustavo Gili, 2012.

Fujimoto, Sou. *Arquitetura como Floresta*, Catálogo da Exposição. Lisboa: CCB, 2013.

Han, Byung-Chul. *A Sociedade do Cansaço*. Lisboa: Relógio D'Água, 2014.

Huizinga, Johan. *Homo ludens: A study of the play element in culture*. Boston: The Beacon Press, 1955.

Lefebvre, Henri. *O direito à cidade*. Lisboa: Letra Livre. 2012.

Pallasmaa, Juhani. *Os olhos da pele, A arquitetura e os sentidos*. Porto Alegre: Bookman, 2011.

Sardo, Delfim. *O Exercício Experimental da Liberdade*. Lisboa: Orfeu Negro. 2017.

Fear of the Unknown in Urban Atmospheres

Abstract. In today's world of insecurity, we are feeling less and less secure in our urban environments. In recent years, there has been much focus on reducing crime rates and crime prevention. However, there are times when we feel unsafe in a place where there is no real threat. This will directly affect our cities and their atmospheres as one avoids places of insecurity. In this paper, by reviewing the existing literature on actual safety and perceived safety, the perception of atmosphere, fear and fear of the unknown, we aim to suggest that it is fear of the unknown and the lack of sensory information as the mediums of atmospheres that can lead to the emotion of fear in an otherwise safe seeming place.

Farzaneh SEMATI¹,
Hamidreza GHAREMANPOURI²

Keywords. *Urban Atmosphere, Ambiance, Perceived Safety, Fear of the Unknown, Fear*

Introduction

Environments, are first and foremost, perceived through their atmospheres (Böhme, 1993). Atmospheres are what give us a feeling of safety and attachment in an environment, or at the same time, can make us feel alienated and fearful. One of the most important factors in the quality of urban environments, is the feeling of safety. However, we often feel afraid and unsafe in environments that do not lack actual safety. There seems to be a clear distinction between actual safety and perceived safety. In this paper, our main focus is on the perception of safety. There is something about certain atmospheres that makes us feel unsafe and provoke the emotion of fear. Atmospheres are emotional powers that impregnate us. They are perceived through different mediums, such as, air, sound, light, odor, etc. (Thibaud, 2015; Böhme, 2016). We then, come across the question of: how are atmospheres with the resonance of fear created?

In this paper, by focusing on the proposal that fear of the unknown or the absence of sufficient information can be fearful (Carleton, 2016a), we try to identify the cause of fear in urban environments in the absence of any real threat. We suggest that, it is in fact, the lack of sensory information as the mediums of the perception of atmosphere, which ultimately create a fearful atmosphere.

Safety in Urban Environments

Over the years there have been many studies on the links between safety and environmental factors. For example, Jacobs' "eyes on the street" theory (1961), Newman's "Defensible Spaces" theory (1972) or the integration of Jacobs' and Newman's ideas

1. Independent researcher, No.37, Rahbarmah Street, Maaliabad Blvd, Shiraz, Iran, farzaneh.semati@gmail.com

2. Independent researcher, No.37, Rahbarmah Street, Maaliabad Blvd, Shiraz, Iran, hamidreza.ghahremanpouri@gmail.com

into “Crime Prevention Through Environmental Design” (CPTED) (Iqbal and Ceccato, 2016). All mentioned theories suggest that crime rates could be affected by urban elements and environmental design (Shach-Pinsly, 2019) and that these elements could be modified in order to reduce the opportunities for the occurrence of crime. However, one can have a feeling of insecurity in a situation where there is no risk of any real crime or danger. This perception of unsafety, could have many incentives, one of which being environmental factors (Warr, 1990).

Perceived safety, as an experienced feeling, differs from actual safety, risks, and dangers in the environment. The feeling of insecurity in different environments, apart from elements which could cause a fearful atmosphere, is mostly related to the fear of crime, not the actual crime (Jansson et al., 2013). In other words if you feel afraid or unsecure in an environment, it is not necessarily a sign of imminent danger (Brantingham and Brantingham, 1995). Although, perceived safety, as a subjective feeling, is not directly related to incidents of crime and criminality (Moser, 2012), it does however, seem to influence behavior, and also the preference of a certain environment (Blöbaum and Hunecke, 2005; Li, Zhang, and Li, 2015). Many studies have shown a persistent negative correlation between perceived safety and preference in urban environments (Blöbaum and Hunecke, 2005; Herzog and Smith, 1988). Similar to actual safety, perceived safety is also affected by urban variables and their arrangements. For instance, two adjacent locations with different urban variables and arrangements, could differ in the sense of security and safety that they project (Shach-Pinsly, 2019). However, the conditions in which a safe environment is created, are not necessarily aligned with the conditions that create a perception of safety (Brantingham and Brantingham, 1995).

As mentioned previously, environments are perceived through their atmospheres (Böhme, 1993) and atmospheres are perceived via sensory stimuli, in a holistic manner (Pallasmaa, 2012, 23). However, most studies that have been conducted on the elements that could enhance the perception of safety, have only focused on, and analyzed one or two aspects of the environment such as, light, sound, vegetation, entrapment, concealment, etc., and their effects on perceived safety (Sayin et al., 2015; Atkins, Husain, and Storey, 1991; Li, Zhang, and Li, 2015). For this reason, we feel, a review on atmosphere and its perception is needed.

Concept of Atmospheres and its Perception

We live in a “world of sensory atmospheres” (Thibaud, 2015), and all places, whether we are aware of it or not, acquire a certain atmosphere or ambiance (Anderson, 2009). Upon entering an environment, what is first and foremost perceived is its atmosphere (Böhme, 1993). Atmospheres are emotional powers, radiated by the environment, that captivate the subject. They are the primary objects of perception (Böhme, 2016). The perception of atmosphere is a complex phenomenon that engages all the senses and has an emotional effect on us (Albertsen, 2019). We enter an environment and instantly have a feeling about it (Zumthor, 2006, 13). This feeling can be a positive or a negative one. There are places that, through the perception of their atmosphere, make us feel calm, safe, and emotionally attached. And, there are also places that frighten us, without being able to identify the cause. It is only after its perception, that we might try and detect the origins of our emotion (Böhme, 2016, 235). Pallasmaa believes that the environments in the first category activate our senses, whereas the second group alienate us and don’t give sufficient sensory information (Pallasmaa, 2019).

Atmospheres have the ability to be designed, generated and experienced (Thibaud, 2015; Böhme, 2016). Thibaud (2013) proposes five operating modes through which atmospheres can be installed in the field of urban design: establishing the sensory as a field of action, composing with affective tonalities, giving consistency to urban situations, maintaining spaces over time and playing with imperceptible transformations. In this proposal for a new way of designing urban environments, he suggests that atmospheres are perceived through *mediums*, such as, air, sound, light, odor, etc. These mediums create a certain *resonance*, an emotional value, such as lively, gloomy, fearful, chilling, etc. These tonalities are what *impregnate* us and make us feel the way we feel in an atmosphere (Thibaud, 2015).

One of the most important factors in reducing fear and heightening the perception of safety in urban environments is social presence (Warr, 1990; Sayin et al., 2015). However, much of the research carried out on perceived safety in urban environments, have considered a low or lack of social presence in their research, as social presence could automatically eliminate fear from urban environments. So, in a situation that lacks social presence (by social presence, we mean an acceptable presence of people) what can cause fear? What are the generators of fearful atmospheres? For this reason, we suggest looking into the emotion of fear or perceived lack of safety, to try and identify its generators.

Fear

Fear is considered as one of the basic emotions of humans, making it innate, easy, categorical and immediate (Sander, 2013). It is a negative emotion which, not only effects behavior, but also influences different aspects of cognition such as, attention, memory, judgment, decision making, etc. (Adolphs, 2013; Moreland-Capua, 2019a). The human body, collects information via the senses (Dias, Correia, and Cascais, 2017) and we are ultimately connected to the environment through our sensory channels (Rouby, Fournel, and Bensafi, 2016). Fear is provoked through sensory stimuli (Moreland-Capua, 2019b) and intervenes between the eliciting stimuli and behavior responses (Adolphs, 2013).

The perceived lack of safety or fear is a complex interaction between personal or socio-psychological attributes, social or socio-demographic attributes and physical or environmental attributes (Loukaitou-Sideris, 2006; Sreetheran and Van Den Bosch, 2014). However, there are fears that are common amongst all humans, regardless of socio-demographic and socio-psychological factors (Bauman, 2013, 20). Brantingham and Brantingham (1995) suggest five categories as fear generators: direct fear of another person, fear of being alone, fear at night in the dark, fear of unknown areas and fear of encounters with scary people (Brantingham and Brantingham, 1995). In this paper, we focus on fundamental fears which we believe are provoked by urban environments.

Fear of the Unknown

There are many types of fear, however, some are acknowledged as being fundamental. One of the criteria for fundamental fears, is that they are present at some level, in most healthy individuals and do not require prior knowledge or learning (Carleton, 2016a). Carleton has proposed that fear of the unknown meets all the criteria for being a fundamental fear and could in fact be recognized as one (Carleton, 2016a). The unknown or “the perceived absence of information at any level of consciousness or point of processing” is frightening. It seems like, one of the first references to the fear of the unknown (FOTU) has been made by Lovecraft in 1927. In his book, *Supernatural Horror in Literature*, he writes “*The oldest and strongest emotion of mankind*

is fear, and the oldest and strongest kind of fear is fear of the unknown" (Lovecraft, 2013, 1). Fear is one of the emotions that is shared by animals and humans. However, what distinguishes humans from animals is the fact that fear in humans can be provoked, without being exposed to threatening stimuli and just thinking about it (Adolphs, 2013). In the absence of information, the mind wonders, and this wonder alone can lead to fear. As Bauman writes, "Darkness is not the cause of danger, but it is the natural habitat of uncertainty- and so of fear" (Bauman, 2013, 2).

From a neurological standpoint as mentioned before, fear is provoked through sensory stimuli. The cognitive processing of these stimuli at the earliest stage classifies the received stimuli as knowns and unknowns, and recognizes the unknown stimuli as threatening (Carleton, 2016a). Also, intolerance of uncertainty (IU), is a human trait that indicates the level of threat caused by uncertainty or the unknown (Tanovic, Gee, and Joormann, 2018) caused by the "perceived absence of salient, key, or sufficient information"(Carleton, 2016b).

Furthermore, in terms of environmental behaviour research, the results show that unfamiliar and unknown places lead to the triggering of fear, caused by overstimulation and the number of unrecognizable stimuli (Day, Stump, and Carreon, 2003). Also in virtual reality and video games, research indicates that one of the factors that causes fear is in fact the unknown (Lynch and Martins, 2015).

However, the unknown, apart from causing fear, may also provoke curiosity and mystery (Clasen, 2018). Mystery is defined as the promise of gaining more information by delving deeper into the mysterious setting (Herzog and Smith, 1988). In other words, partially unknown, if balanced correctly with the perceived information, can cause a positive feeling of mystery (Clasen, 2018). If the environmental stimuli is rightly balanced, the created mystery will have a positive effect on preference (Herzog and Smith, 1988), but if not, the unknown will cross the threshold of fear.

Conclusion

Fear as a primary emotion and atmospheres, as emotional powers, both are communicated to us through our sensory stimuli. Also, fear of the unknown, or the absence of sufficient information and certainty, seems to be a fundamental fear in humans. Environments which are not well lit, or are too quiet, or leave some areas visually unattainable, etc., could provoke fear. As designers, architects and city planners, our main aim is to focus on "installing urban atmospheres" (Thibaud 2015) in the process of design. We have to manage and balance the information that an atmosphere communicates with the user. If an environment is dark, the lack of information may be balanced out, by heightening the other senses. In the end, we believe, everything is about the balance of information in the generating of atmospheres.

References

- Adolphs, Ralph. 2013. "The biology of fear." *Current Biology* 23 (2): R79-R93.
- Albertsen, Neils. 2019. Urban Atmospheres. *Ambiances. International Journal of Sensory Environment, Architecture and Urban Space* [Online]. <https://doi.org/10.4000/ambiances.2433>
- Anderson, Ben. 2009. "Affective atmospheres." *Emotion, space and society* 2 (2): 77-81.
- Atkins, Stephen, Sohail Husain, and Angele Storey. 1991. *The influence of street lighting on crime and fear of crime*. Home office London.

- Bauman, Zygmunt. 2013. *Liquid fear*. John Wiley & Sons.
- Blöbaum, Anke, and Marcel Hunecke. 2005. "Perceived danger in urban public space: The impacts of physical features and personal factors." *Environment and Behavior* 37 (4): 465-486.
- Böhme, Gernot. 1993. "Atmosphere as the fundamental concept of a new æsthetics." *Thesis eleven* 36 (1): 113-126.
- . 2016. *The æsthetics of atmospheres*. edited by Jean-Paul Thibaud: Taylor & Francis.
- Brantingham, Patricia, and Paul Brantingham. 1995. "Criminality of place: Crime generators and crime attractors." *European journal on criminal policy and research* 3 (3): 5-26.
- Carleton, R Nicholas. 2016a. "Fear of the unknown: One fear to rule them all?" *Journal of Anxiety Disorders* 41: 5-21.
- . 2016b. "Into the unknown: A review and synthesis of contemporary models involving uncertainty." *Journal of anxiety disorders* 39: 30-43.
- Clasen, Mathias. 2018. "The Evolution of Horror: A Neo-Lovecraftian Poetics." In *New Directions in Supernatural Horror Literature*, 43-60. Springer.
- Day, Kristen, Cheryl Stump, and Daisy Carreon. 2003. "Confrontation and loss of control: Masculinity and men's fear in public space." *Journal of Environmental Psychology* 23 (3): 311-322.
- Dias, Joana Afonso, Antónia Correia, and Teresa Cascais. 2017. "Traits in tourists' experiences: Senses, emotions and memories." In *Co-Creation and Well-Being in Tourism*, 179-194. Springer.
- Herzog, Thomas, and Gregory A Smith. 1988. "Danger, mystery, and environmental preference." *Environment and Behavior* 20 (3): 320-344.
- Iqbal, Asifa, and Vania Ceccato. 2016. "Is CPTED useful to guide the inventory of safety in parks? A study case in Stockholm, Sweden." *International criminal justice review* 26 (2): 150-168.
- Jansson, Märit, Hanna Fors, Therese Lindgren, and Björn Wiström. 2013. "Perceived personal safety in relation to urban woodland vegetation-A review." *Urban Forestry & Urban Greening* 12 (2): 127-133.
- Li Xiaojiang, Zhang Chuanrong, and Li Weidong. 2015. "Does the visibility of greenery increase perceived safety in urban areas? Evidence from the place pulse 1.0 dataset." *ISPRS International Journal of Geo-Information* 4 (3): 1166-1183.
- Loukaitou-Sideris, Anastasia. 2006. "Is it safe to walk? 1 neighborhood safety and security considerations and their effects on walking." *Journal of Planning Literature* 20 (3): 219-232.
- Lovecraft, Howard Phillips. 2013. *Supernatural horror in literature*. The Palingenesis Project (Wermod and Wermod Publishing Group).
- Lynch, Teresa, and Nicole Martins. 2015. "Nothing to fear? An analysis of college students' fear experiences with video games." *Journal of Broadcasting & Electronic Media* 59 (2): 298-317.
- Moreland-Capuia, Alisha. 2019a. "Digging Deeper into "Fear."" In *Training for Change*, 239-262. Springer.

- . 2019b. "Trauma Informed: The Intersection of Fear, Trauma, Aggression, and a Path to Healing." In *Training for Change*, 59-84. Springer.
- Moser, Gabriel. 2012. "Cities." In *The Oxford Handbook of Environmental and Conservation Psychology*, edited by Susan D Clayton.
- Pallasmaa, Juhani. 2012. *The eyes of the skin: Architecture and the senses*. John Wiley & Sons.
- . 2019. "The Atmospheric Sense: Peripheral Perception and the Experience of Space." In *Atmosphere and Aesthetics*, 121-131. Springer.
- Rouby, Catherine, Arnaud Fournel, and Moustafa Bensafi. 2016. "The role of the senses in emotion." In *Emotion measurement*, 65-81. Elsevier.
- Sander, David. 2013. "Models of emotion: The affective neuroscience approach." 19-53.
- Sayin, Eda, Aradhna Krishna, Caroline Ardelet, Gwenaëlle Briand Decré, and Alain Goudey. 2015. "'Sound and safe': The effect of ambient sound on the perceived safety of public spaces." *International Journal of Research in Marketing* 32 (4): 343-353.
- Shach-Pinsly, Dalit. 2019. "Measuring security in the built environment: Evaluating urban vulnerability in a human-scale urban form." *Landscape and Urban Planning* 191: 103412.
- Sreetheran, Maruthaveeran, and Cecil C Konijnendijk Van Den Bosch. 2014. "A socio-ecological exploration of fear of crime in urban green spaces-A systematic review." *Urban Forestry & Urban Greening* 13 (1): 1-18.
- Tanovic, Ema, Dylan G Gee, and Jutta Joormann. 2018. "Intolerance of uncertainty: Neural and psychophysiological correlates of the perception of uncertainty as threatening." *Clinical psychology review* 60: 87-99.
- Thibaud, Jean-Paul. 2015. "The backstage of urban ambiances: When atmospheres pervade everyday experience." *Emotion, Space and Society* 15: 39-46.
- Warr, Mark. 1990. "Dangerous situations: Social context and fear of victimization." *Social forces* 68 (3): 891-907.
- Zumthor, Peter. 2006. *Atmospheres: Architectural Environments. Surrounding Objects*. Birkhäuser.

Ambiences and Safety?

Methods for Security Experience Design

Abstract. TAMK is taking part to Smart Urban Security and Event Resilience Project (SURE) funded by the EU's Urban Innovative Actions initiative since 2019 and ending 2022. Our objective in SURE is to get data how the safety sense of ambiance affects to act and participate in ordinary social life? Due COVID-19 the method changed from go-along with the special groups to different places and occasions around the city center to virtual walks using 360-technologies, simulating and dramatizing the experience. The aim remains to develop and update the situation awareness of safety, for the improvement of urban planning and development of security by design concepts. In my paper, I will study the methods for safety experience design.

Ari KOIVUMÄKI¹

Keywords. *Ambience, Security, Safety, Urban Planning, Service Design*

Introduction

Safety issues in public spaces are common problem of modern societies. Public spaces have always represented the best picture of society and constant problem of mixed interests of its users. The task is to make space available to everyone (Keränen et al., 2013, 158-159). One of the objectives of SURE2 is “How to make the daily lives of citizens and urban environment safer by using innovative co-creation methods, to develop and test security in connection with actual urban development projects and public infrastructure in Tampere, Finland.” In TAMK’s work package, our original idea was to use go-along method (Kusenbach, 2003, 455-485; Keränen et al., 2013, 132) with the special groups, discussing, visiting and walking in different occasions and places around the city center. The aim was to share it with comments and analytical data to stakeholders for security.

There are various popular and busy event areas in the Tampere city center and events are important factor for the attractiveness of the city³. Safety and security are more and more important factors when competing for major events (Klauser, 2012, 1039-1052). Events will lead to lower safety and security level - how to handle the dilemma? How to maintain the high level of urban security in Tampere in connection with the rapid urban change and facilitate new kind of urban capabilities to predict the movement of crowds, secure usability of public space and facilities as well as effects of various urban security services and infrastructure, on the behavior of people in exceptional security situations?⁴

1. Tampere University of Applied Sciences (TAMK), Finland, ari.koivumaki@tuni.fi

2. See at: <https://www.uia-initiative.eu/en/uia-cities/tampere> Accessed June 21, 2020.

3. Safe living in the Tampere region: <https://www.youtube.com/watch?v=SliK3nF2V3s>

4. See at: <https://businesstampere.com/tampere-gets-over-meur-3-of-eu-funding-for-improving-urban-and-event-security-2/> Accessed June 21, 2020.

Service Design as a Tool for Safety

TAMK's work package includes a structured participatory service design and co-creation process, which will be implemented in other work packages to produce event related incident simulations and exercises. In the SURE project, as a whole, we are developing safety concepts for two key locations: Tampere Central Square and Ratina Stadium, and later we will scale the concepts up citywide and apply to similar locations elsewhere in Europe.

Tampere University partners developed a structured discussion process methodology involving local authorities and interest groups for the urban security planning and implementation. The other work packages will also provide policy support, capacity building and guidelines for the City on the deployment and integration of latest digital and data driven solutions for the development of more secure urban environment. Simulations and exercises in other packages will use same use case scenarios and cover different types of potentially disastrous events.

Co-Creation Workshops for the Development of Urban Security Scenarios

In the first phase, our Tampere University partners developed baseline scenarios. The other participants of SURE project represent both local administration, other security/safety authorities, business and civic organizations. After co-creation workshops with project partners, we entered in three scenarios: constant safety, dynamic safety and exceptional security.

For the Tampere Central Square, constant safety describes the ambiance as if it was a living room for a citizen. Dynamic safety expresses the atmosphere felt during events, parades, rallies or during market days, and in Ratina Stadium when visiting a spectacle with tens of thousands other people and having special arrangements in traffic and passageways. Dynamic safety as a concept includes peace officers in case of disturbance and visible police force against rioters either in or outside the event, before or after it takes place.

Exceptional security describes the atmosphere when something unpredictable happens like a thunderstorm causing blackout and panic, which escalates. Terrorist attack is included in this scenario as well.

Methods for Security Experience Design

In the Nordic context in particular, safety highlights when something happens that affects the customer's sense of security. One of our methods was to research service concepts increasing the event security and event customers' feeling of security, to produce guidelines for smart and secure urban space.

In SURE we needed to concentrate on individual security experience and this is what service design does: represent the users' perspective. Within this methodological framework, we were able to focus on special features in customer journey related to safety and security services and integrate expertise from different disciplines. At its best service design is also interactive and ongoing (Moritz, 2005, 42-47).

Our research group organized workshops for security experience design to students and special customer groups. To begin with, we had to define the concept of safety and security with the people who participated the workshop. From Tampere City perspective the definition would be the following "Safe city allows its citizens to live in a healthy environment and have simple access to healthcare, to achieve readiness

and quick response to threatening or arising emergencies” (Lacinák & Ristvej, 2017, 522-527). From the perspective of a citizen, visitor or a tourist the feeling of safety is another, it is both social value and a human right as such, but it is impossible to create a secure place to anyone at every time. Usually, when something unpredictable and hard to understand happens, the consequence is to feel threats (Keränen et al., 2013, 130). I think the COVID-19 pandemic has once again proved it. Safety is something we trustworthily expect to happen as an everyday routine. In workshops, we started defining safety and recognizing problems related to security services and concepts.

Service Design Workshops

During discussion with a special group in 5th of May 2020, Satu Kylmä and Tuija Ylä-Viteli from TAMK’s research group made remarks from Central Square’s safety during market events: the most important issue is peaceful environment, clear lighting, passageways with proper signs, secure meeting point to get together and means to get help if needed.

Crowded places are challenging in terms of security. City centers are often densely constructed, however easy to reach by traffic. A modern citizen needs to be able to communicate and stay within reach all the time via mobile networks. Otherwise, we are ‘lost’.

Events are targeted to certain people, who nowadays might come from anywhere and not be familiar with the surroundings or the locals. Sometimes different habits just clash when people meet in strict circumstances, not to mention special groups, age or ethnicity issues. The feel of being equal with the others and treated accordingly, is the key.

Proper lighting is important for orientating inside the event area in safe - and needed to avoid pick pocketing. The nightfall albeit cozy, has its neglects. The signs and info highlighted with bright colors, otherwise e.g. several entrance points create a mess as does a sign without a clear indication of direction.

Tampere Central Square is a well-known place for locals, especially the fountain in front of the City Hall. The meeting point need to be there to find your friends among the crowd. As important is to get there and back in safe. The special group who participated the workshop 5th of May 2020 asked for exclusive exit route as well as safe passageways to pass the events they want to avoid. Moving from one place to another is also challenging especially for the elderly people.

Simulating Safe and Unsafe Places

To get further info from everyday safety in Central Square, Antti Perälä planned a 360 simulation. Our original plan was to make go-along walks, but due to Covid crisis, we could not. We needed to define the visiting routines, paths, customer experience, motifs and meaning making during the service journey in order to create customer profiles, design drivers and better service concepts related to safety and security. Perälä put up the simulation and a questionnaire to address <https://surewp4.fi/>. It is in Finnish with the following instructions:

- Safe and unsafe places;
- Mark the places where you like to visit and feel safe with 1-3 green balls and with red, the places you want to avoid;
- Drag the balls accordingly to the map.

After pressing “Valmis” (Ready), the program creates a 360-panorama view seen from one of the spots and a question to describe which things would add your feeling of safety.

The questionnaire has been open for two weeks in the end of May 2020 and we have got around 70 responds. The results will be analyzed in the autumn. Some themes of safety came up already on the first glance: clear visibility is important. You need to know where you are in order to know where to go. Another theme is safety related to traffic: how pedestrian, bicyclist or scooter fit to narrow sidewalk. The main concern for safety is people behaving unpredictable from either drugs or alcohol near and inside the Central Square park area, especially during nightfall.

Dramatizing Exceptional Events

What we are still missing, is to simulate the security for exceptional accidents. Carita Forsgren created another simulation of the Central Square to a different platform⁵. Now we are able to attach photos and video footage from different happenings, riots and events to the same 3D site. With this method, we hope to trigger eye witnessing and detailed memories. The basic scenery is calm and empty, photographed during Covid pandemic on May, so the contrast is remarkable to the events that has been there. I made the binaural recordings to accompany the 360 sights.

In the same platform, there are pictures and short animations by Ere Kreula and Anna Laukkanen. They are dramatized acts describing situations like “leaving friends and left alone” or “going home in the evening” and used for discussion during workshops.

Finally, Carita Forsgren wrote, directed and performed a Ratina Monologue, fictional 360 short film about a young woman looking for help to find a way from Central Square to Ratina Stadium⁶. The virtual tour unfolds the theme of being alone in a strange city. With the 360 view, it is possible to see the urban environment through the main characters eyes, immersed in binaural soundscape. The idea with this is to get people identify emotionally to the same situation and share the experience when answering the questionnaire attached. We have delivered the film in YouTube and Facebook and we will analyze the results in autumn 2020. It would be interesting to see how different data we will get from this virtual street tour questionnaire compared to the aforementioned ones.

Go-Along Safety Walks

In autumn if Covid pandemic allows, we are planning to put go-along walks into practice. After analyzing the results from the workshops and questionnaires, we can recognize places, routes and situations, which create unsecure feelings. Going along in real places and situations, making notes “on the fly” when something actually happens; the data will be different and detailed.

I hope go-along routes will activate thoughts, minds and make a change in mindsets for the familiar environment, to see it in another way, and to understand the value of the meaning making made in the lived, mundane environment.

5. See at: [https://digicampus.fi/my/Choose "SURE-hanke WP4: kokemuksia.."](https://digicampus.fi/my/Choose%20SURE-hanke%20WP4%3A%20kokemuksia..) Accessed 29.6.2020.

6. See at: <https://www.youtube.com/watch?v=czBGeWXVj4Y> Accessed 30.6.2020.

Conclusions

The first results from our online experiment indicate that clear visibility, as well as safety related to traffic, are important for the feeling of security. The main concern for safety is people behaving unpredictably, due to either drugs or alcohol, especially during the night. It is obvious that our research will require more time to create proper concepts on how to make urban environments feel safer in general. Maybe the mission is impossible and we have to accept that when many people come together, the risk of insecurity accumulates. The risk is where the people are. With our senses, we use to control each other's behavior and react accordingly, sometimes with fear. Therefore, it is not always about the wrong place, event or time to get into trouble. It is the other people, whom we cannot avoid in densely populated community. On the other hand, desolate places, streets and alleys are fearsome for many of us, while there is no one to ask help and the social control is missing.

In the autumn, if the Covid pandemic allows, we are planning to put go-along walks into practice. After analyzing the results from the workshops and questionnaires, we can recognize places, routes, and situations, which create unsecure feelings. The results of going along in real places and situations, making notes "on the fly" when something actually happens, leads to the data being different and more detailed. I hope go-along routes will activate thoughts and minds, and make a change in the mindsets for the familiar environment. We need to see it in another way, and to understand the value of the meaning making in the lived, mundane environment. The ambiance experienced is an everyday experience for the city dwellers, which puts us in immediate contact with a situation in its entirety, and consequently involves an ecological approach to perception. The listening subject synchronizes to be part of the lived milieu (Thibaud, 2002, 2011, 43-53).

Hearing is one sense to control our surroundings. In nature, sonic events are ephemeral and follow stochastically each other. Hearing embodies when controlling the acoustic environment (of embodied cognition see e.g. Wilson & Foglia, 2017). Yet we are not actively listening at all times, quite often absent-minded, heading to somewhere with haste. Traffic noise, distractive sound sources, bad hearing, health condition, age, the quality of terrain to name just a few gives more obstacles sensing the place and its sonic atmosphere.

The perceptions we sense are from our environment and we comprehend them in context. The meaning making depends from the situation where we stand and what we are going to do. While we are social beings, the interaction with the others is always there. The same goes with the experiences and memories we have. As Ingold wrote: "Whereas sensations are private and individual, representations are public and social" (Ingold, 2000, 158).

Keränen with her research group has noticed that in relation to security, citizen act based on their feelings than to reality as it is around them. Getting along in a neighborhood depends from everyone's own experiences: in familiar environment, the ambiance is different compared to strange one. While ordinary life is full of routines, you are not aware to foresee risks. This is why it is important to analyze which kind of phenomena are unsafe for real and which kind of events might be felt unsecure, but in fact belong to normal urban life, e.g. youngsters gathering up on weekends. Sometimes it is too easy to project racial prejudices on people or stigmatize for drug abusers and call that a threat. The visible presence of police forces or guards does increase the feeling of safety but not for everyone (Keränen et al., 2013, 134-188). Opening up late night libraries with different kinds of activities for teenagers near

shopping malls and the visible use of youth workers to prevent the distraction might be better, these are just examples of service concepts we are aiming to create within SURE-project. The other means to adjust the results thus far are to ensure passageways are equipped with proper signs, and to secure meeting points for getting together and means to get help, if needed.

Acknowledgements

For TAMK (Tampere University of Applied Sciences) SURE team: Petri Murtomäki, Tuija Ylä-Viteli, Satu Kylmä, Kirsi Karimäki, Carita Forsgren, Antti Perälä, Ilmari Huttu-Hiltunen, José Pesu-Inácio and Mark Malyshev as well as for Anniina Autero, the general manager of SURE from the City of Tampere and also to Ilari Karppi and Iina Sankala from Tampere University.

References

- Ingold, Tim. *The Perception of the Environment*. London: Routledge, 2000.
- Keränen, Jaana., Vaattovaara, Mari., Kortteinen, Matti., Ratvio, Rami., Koski, Hannu &
- Rantala, Tuija (eds.). *Turvalliset kaupunkiympäristöt. Rakenteelliset taustat, asukkaiden kokemukset ja arjen turvallisuusratkaisut*.
- Espoo: VTT Technical Research Centre of Finland, VTT Technology 88, 2013.
<https://www.vttresearch.com/sites/default/files/pdf/technology/2013/T88.pdf>
- Klauser, F.R. "Interpretative flexibility of the event-city: Security, branding and urban entrepreneurialism at the European football championships 2008."
International Journal of Urban and Regional Research 36, issue 5, (2012): 1039-1052.
<https://core.ac.uk/reader/20660430>
- Kusenbach, M. (2003). Street phenomenology: The go-along as ethnographic research tool. *Ethnography* 4(3), (2003): 455-485.
- Lacinák, M. & Ristvej, J. "Smart city, safety and security." *Procedia Engineering* 192 (2017): 522-527. <https://doi.org/10.1016/j.proeng.2017.06.090>
- Moritz, S. *Service Design: Practical access to an evolving field*. London (2005): 42-47.
https://web.archive.org/web/20120816041535/http://stefan-moritz.com/_files/Practical%20Access%20to%20Service%20Design.pdf
- Thibaud, Jean-Paul. From situated perception to urban ambiances. First international Workshop on Architectural and Urban Ambient Environment, February 6-8 2002, Nantes: Cerma, Ecole d'architecture.
- Thibaud, Jean-Paul. The three dynamics of urban ambiances. In *Sites of Sound: Of Architecture and the Ear* Vol. 2. Brandon LaBelle & Claudia Martinho (eds.) Errant Bodies Press, Berlin, 2011: 43-53.
- Wilson, Robert A. and Foglia, Lucia. "Embodied Cognition," edited by Edward N. Zalta, *The Stanford Encyclopedia of Philosophy*, 2017. Accessed 04 Jun 2020.
https://plato.stanford.edu/archives/spr2017/entries/embodied_cognition/

INDEX OF
AUTHORS,
VOLUME 1

Index of Authors, Volume I

ABBAS, Yasmine	226
ABU DAYA, Amal	218, 238
ALBERTSEN, Niels	58, 74
APPEL, Seraphine	274
ATIENZA, Ricardo	198
BALBONTÍN, Sofía	204
BALEZ, Suzel	58, 86
BARBAS, Isabel	354
BARCHETTA, Lucilla	310
BEN AYED, Alia	352
BISSON, Brieuc	62
BOURBONNAIS, Sebastien	220
BOURDAKIS, Vassilis	186
CARLES, José Luis	182
CHALVATZOGLOU, Thodoris	286
CHAVES, Marilia	332
CHYON, Gyungju	168
CUNHA, João	210
DEVISME, Laurent	58
DI CROCE, Nicola	280
DUNN, Nick	114
FOERSTER, Desiree	250
FOLMANN, Birgitte	126
GHAHREMANPOURI, Hamidreza	360
GRIFFITHS, Rupert	108
GRIGORIADOU, Magdalini	192
HOSALE, Mark-David	244
HOUEL, Nicolas	100
ISYK, Lilitia	256
JENSEN, Ole B.	326
KELLOUGH, Bethan	68
KLENNER, Mathias	204
KOIVUMÄKI, Ari	366

LAFFONT, Georges-Henry	304
LAMOUNIER, Alex Assunção	292
LANZ, Francesca	150
LIVENEAU, Philippe	218
LOUKAKIS, Giorgos	186
LUGLI, Daniele	138
MANOLA, Théa	318
MANTZARI, Eleni	192
MARAGKOU, Afroditi	92
MASSON, Damien	264, 268
McGINLEY, Robin	198
MEZIOU, Olfa	352
NIELSEN, Stine Louring	132
PAKHALÉ, Satyendra	162
PALMESE, Cristina	182
PAPADOPOULOS, Spiros	186
PAXINOI, Evangelia	318, 320, 344
PROIETTI, Tiziana	162
RASPAUD, Michel	144
REMY, Nicolas	344
RIMENIDIS, Yorgos	92
SADAR, John	168
SAID, Noha Gamal	238
SAND, Monica	198
SCOTT, Jennifer	102
SEMATI, Farzaneh	360
SHIELDS, Jennifer A. E.	338
SOEIRO, Diana	298
SOLTANI, Amir	232
SUMARTOJO, Shanti	122
TÂNGARI, Vera Regina	292
THEODORSON, Judy	102
THIBAUD, Jean-Paul	58, 80
THOMAS, Rachel	264, 268
TZIRTZILAKIS, Yorgos	92
VYZOVITI, Sophia	286
WAGENFELD, Malte	174
WIECZOREK, Izabela	156

4TH INTERNATIONAL CONGRESS ON AMBIANCES
E-CONFERENCE, 2-4 DECEMBER 2020

The topic of ambiances and atmospheres has been unfolding for more than four decades, and the questions associated with it are constantly being renewed. The vitality of ambiance and atmosphere as an object of study and as a field of research and practice is particularly sensitive through the continuous development of the International Ambiances Network.

After the Congresses of Grenoble (Creating an Atmosphere, 2008), Montreal (Ambiances in Action, 2012) and Volos (Ambiances, Tomorrow: The Future of Ambiances, 2016), this 4th International Ambiances Network Congress, entitled "Ambiances, Alloaesthesia: Senses, Inventions, Worlds" questions the renewal of the forms of feeling in a world that is undergoing major changes. It aims to consider how the contemporary environmental, social, technological, political and ethical changes are likely to affect the sensitive worlds, their ambiances, and the ways of experiencing them.

These conference proceedings bring together about a hundred contributions written by an international base of academics, practitioners, artists and PhD students working on ambiances and atmospheres. They offer an up-to-date account of the variety of themes and issues within this field, showcasing the latest research and methodological approaches. Organized in sixteen complementary topics, these chapters examine the ongoing preoccupations, debates, theories, politics and practices of this field, drawing on multidisciplinary expertise from areas as diverse as anthropology, architecture, computer science, cultural studies, design, engineering, geography, musicology, psychology, sociology, urban studies and so on.

30€

ISBN 978-2-9520948-7-0



9 782952 094870



AMBIANCES, ALLOÆSTHESIA: SENSES, INVENTIONS, WORLDS.

Proceedings of the 4th International
Congress on Ambiances.

Edited by Damien Masson

2

ambiances

RESEAU INTERNATIONAL
INTERNATIONAL NETWORK

Edited by
Damien Masson

Publishing Secretary of Proceedings
Chloé Pestel

ISBN 978-2-9520948-7-0

© International Ambiances Network, 2020

Cover design © Les murs - Pauline Gorge

All rights reserved. No part of this publication may be reproduced in any form or by any means without the written permission of the authors and the publishers.

Ambiances, Alloæsthesia

Senses, Inventions, Worlds

**4th International Congress on Ambiances
December 2020, e-conference**

VOLUME 2

Edited by
Damien Masson

ambiances
| RÉSEAU INTERNATIONAL
INTERNATIONAL NETWORK |

Contents

SESSION 9

PHYSICAL/DIGITAL SPACES COLLISIONS. SO WHAT? 11

Introduction 12

Thomas LEDUC, Myriam SERVIÈRES, Vincent TOURRE

Ambiance In and Around the Virtual Reality Headset 14

Paul ROQUET

Adapting Sensibilities Beyond 'Screen-Deep' Spatial Experience 20

Gillian TREACY

From Attention to Spatial and Informational Mobility 26

Myriam SERVIÈRES, Steven SAULNIER-SINAN, Barbara PIGA

SESSION 10

PRESENCING ATMOSPHERES 33

Introduction 34

Niels ALBERTSEN

Reasonance 36

Marie KOLDKJÆR HØJLUND, Anne-Sofie UDSEN

Playable Sound 42

Marilena GEORGANTZI, Polyxeni MANTZOU

Narrative Presencing of Architectural Monuments 48

Angeliki SIOLI

Traces of Invisibility: Readings From Artistic Records 54

Maria Rita PAIS, Luis SANTIAGO BAPTISTA

Urban Atmospheres in Pandemic Times 60

Fatma MRAD

Testimony of a Congolese Refugee 66

Ilana SANCOVSCHI, Cristiane Rose DUARTE

Re-Sensitizing as New Sensitizations Process 72

Bárbara THOMAZ, Juliana QUEIROZ

After the Ruins 78

Elisa MORSELLI, Federico DE MATTEIS

Photographic Driftings as a Method to Intercept the Atmosphere of the Sprawlscape 84

Martina LOI

SESSION 11	
SENSE AND SENSIBILITY OF AFFECTIVE ATMOSPHERES	91
Introduction	92
<i>Andrea JELIĆ, Aleksandar STANIČIĆ</i>	
Through the Ambiguous Objects of Benjaminian Thought	96
<i>Katarina ANDJELKOVIC</i>	
Ambiance Production in Virtual Interiors	102
<i>Vahid VAHDAT, Judy THEODORSON</i>	
Atmospheres of Transformation	108
<i>Christos KAKALIS</i>	
Atmosphere, Resonance, and Immanent Transcendence	114
<i>Anders PALSTRØM</i>	
Atelier de la traversée	120
<i>Alice SALIMBENI</i>	
Ambient Outlines of Children's Urban Experience	126
<i>Nathalie AUDAS, Fanny VUAILLAT, Sandrine Depeau</i>	
SESSION 12	
SENSITIVE SPACES AND URBAN PRACTICES	133
Introduction	134
<i>Cristiane DUARTE, Ethel PINHEIRO</i>	
Sensitive Topologies Configurations in the Milieu and the Urban Landscape	136
<i>Mohammed BOUBEZARI</i>	
The Great Soccer Stadium	142
<i>Natália RODRIGUES DE MELO, Cristiane ROSE DE SIQUEIRA DUARTE, Paula UGLIONE</i>	
Urban Sonic Research and Sound Map	148
<i>Sena KARAHAN</i>	
The Ambiance of Tension	154
<i>Rachel IAMPOLSKI</i>	
Women's Action of Urban Guerrilla	160
<i>Cândida ZIGONI</i>	
SESSION 13	
SENSORY EXPERIENCE, ENVIRONMENTAL EXPERIENCE, POLITICAL ENGAGEMENT	167
Introduction	168
<i>Théa MANOLA, Edith CHEZEL</i>	
Symbiotic Atmospheres	172
<i>Thalia MAROU</i>	
How Surfing Creates an Ecosystem?	178
<i>Lilia KHELIFI</i>	
The Tangible Presence of Human Labor in Architecture	184
<i>Eric CREVELS</i>	
The Ambiance of Rome Self-Managed Spaces as Dispositif de Sensibilisation	190
<i>Simone RANOCCHIARI</i>	

Participate in the Atmosphere	196
<i>Olivier OCQUIDANT</i>	
Towards a Sensory Patrimoine?	202
<i>Victor FRAIGNEAU</i>	
Normativity and Aesthetics	208
<i>Claire PELGRIMS</i>	
Investigating the “Climate Subjectivation” in Urban Furnaces	214
<i>Fabian LEVEQUE, Karl BERTHELOT</i>	

SESSION 14

SOUND STAKES OF THE ATMOSPHERE	221
Introduction	222
<i>Grégoire CHELKOFF, Théo MARCHAL</i>	
Field Recording, Technology and Creative Listening	226
<i>Jean-Baptiste MASSON</i>	
Second-Order Ambiances	232
<i>Heikki UIMONEN</i>	
The Kite Choir	238
<i>Firat ERDIM</i>	
Ascolto il tuo cuore, città	244
<i>Giuseppe GAVAZZA</i>	
A Workshop on Sonic Ambiances at the School of Architecture of the University of Talca, Chile	250
<i>Susana MORENO SORIANO, Andrés MARAGAÑO LEVEQUE, Edgard TORRES TORRES</i>	
Spatial Design Praxis Using the Sound Sketching Environment Tool “Esquis’Sons”	256
<i>Petros FLAMPOURIS, Théo MARCHAL</i>	

SESSION 15

THE WAY OF AMBIANCES: SCIENTIFIC PRACTICES, ARTISTIC PRACTICES	263
Introduction	264
<i>Didier TALLAGRAND, Nicolas TIXIER</i>	
Making the Most of Parisian Quarries’ Air	266
<i>Guillaume DURANEL, Frédéric BLAISE</i>	
Raw Materials and Emphasis on Tactile Perceptions to Create Atmospheres	272
<i>Nuria ALVAREZ COLL</i>	
In-Between Art, Architecture and Landscape	278
<i>Fabiola ZONNO, Lis PAMPLONA, Daniel MILAGRES, Claudia NÓBREGA</i>	
Realities aren’t Real!	284
<i>Neoklis MANTAS, Alex DEFFNER</i>	
Heritage / Fiction	290
<i>Nicolas TIXIER</i>	
<i>Fragile entities at work in ambiances</i>	296
<i>Sandra LORENZI</i>	
Three Avant-Garde Masterpieces: <i>Atmosphères, Aura, Stimmung</i>	302
<i>Giuseppe GAVAZZA</i>	

SESSION 16	
WHAT PLACE FOR AMBIANCE IN THE URBAN RENATURING PROCESS?	309
Introduction	310
<i>Emeline BAILLY, Sylvie LAROCHE</i>	
Ambulatory Ambiance	316
<i>Fredric BELL, Gwenaëlle DE KERRET</i>	
The Urban Spontaneous Beach, an Idle Ambiance in the Urban Space	322
<i>Maroua EN-NEJJARI</i>	
PANELS	329
Toward the possibilities of urban sound parks	330
<i>Jordan LACEY, Raquel CASTRO, Paul CRAENEN, Stephan MOORE</i>	
The Architecture of the Virtual	336
<i>Karan AUGUST, Zakaria DJEBBARA, Stavros KOUSOULAS, Andrej RADMAN</i>	
Scaling Sensory Experiences	342
<i>Rennie TANG, Lisa SANDLOS, Elisa SEIDNER</i>	
The Urban Spontaneous Beach, an Idle Ambiance in the Urban Space	348
<i>Sana LAYEB</i>	
Ambiance Narrative Design as an Innovation Tool	354
<i>Laurent LESCOP, Eric STEVENS</i>	
Temporary Altered Perception of Birth Space Ambiances	360
<i>Ichraf AROUA, Faten HUSSEIN, Raja GHOZI, Meriem JAIDANE</i>	
INDEX OF AUTHORS, VOLUME 2	328

07

INFINITE ATMOSPHERES? ETHIC DIMENSIONS
OF AND FOR THE DESIGN OF PUBLIC SPACES

08

INHABITING INSECURITY.
PRACTICES AND REPRESENTATIONS

VOLUME 1

09

PHYSICAL/DIGITAL SPACES COLLISIONS. SO WHAT?

10

PRESENCING ATMOSPHERES

11

SENSE AND SENSIBILITY OF AFFECTIVE ATMOSPHERES

Physical/Digital Spaces Collisions. So What?

Session 9 – Introduction

Thomas LEDUC¹,
Myriam SERVIÈRES²,
Vincent TOURRE³

In recent decades, the use of new technologies in mobility situations has fostered the emergence of new forms of society. The empirical and tangible world of proximity, of short distances, of small communities, backdrop of our traditionally recognized senses, has suddenly collided with a set of virtual, networked universes operating on a world scale, capable of interconnecting billions of humans and non-humans.

In an article from 1992, the American geographer H. Couclelis "begs the philosophical question of the most appropriate conceptualization of geographic space" in the context of a controversy between the "object" and "field" views of geographic space. She first notes that this question is "closely analogous" to the atomic-plenum debate in the philosophy of physics before exploring "the theoretical and practical implications of the plenum ontology for geographical modeling." In such an understanding of space, the latter is a continuous and ubiquitous field of potentials.

The question now arises as to the relevance of this model to the above-mentioned collision. How does physical/digital collision occur in urban space? What is the impact of this collision on our experience of space?

What are the impacts and consequences of these interaction on the perception of space, on urban ambiances, on the way of the city are design today and on the way the people can live and interact into these city?

Reference

Couclelis, Helen. 1992. "People Manipulate Objects (but Cultivate Fields): Beyond the Raster-Vector Debate in GIS." In *Theories and Methods of Spatio-Temporal Reasoning in Geographic Space*, International Conference GIS - From Space to Territory: Theories and Methods of Spatio-Temporal Reasoning, Lecture Notes in Computer Science, eds. Andrew U Frank, Irene Campari, and Ubaldo Formentini. Pisa, Italy: Springer, 65-77.

1. AAU Laboratory, Crenau, France.

2. AAU Laboratory, Crenau, France.

3. AAU Laboratory, Crenau, France.

Ambiance In and Around the Virtual Reality Headset

Abstract. Ambient perception in virtual reality is split between perceiving the virtual space inside the headset and perceiving the surrounding physical environment. While promises of VR “immersion” frequently ignore the surrounding space, an ambient perspective reveals how immersion in VR is always at least double: any immersion in virtual space comes nested within an immersion in the atmospheres already surrounding VR use. This essay seeks to understand how these two layers cohere both spatially and temporally across the interface of the VR headset. An ambient perspective on VR demonstrates how even the most immersive media must be understood as shaped by the spaces surrounding the interface itself.

Paul ROQUET¹

Keywords. *Ambiance, Atmosphere, Immersion, Spatial Mediation, Virtual Reality (VR)*

Introduction

Virtual reality researchers Maria Sanches-Vives and Mel Slater (2005, 332) note how “immersive virtual environments can break the deep, everyday connection between where our senses tell us we are and where we are actually located and whom we are with.” As with most VR research, Sanches-Vives and Slater’s paper quickly moves on from this observation to focus on how VR environments can substitute for this everyday sensory emplacement, producing feelings of immersion within virtual environments instead. Yet wearing a virtual reality headset not only provides access to virtual environments, it necessarily transforms a person’s relationship to the surrounding space as well.

Research on ambiance and atmosphere has begun attending to how media can alter a person’s emotional and affective relationship to their surroundings, including my own earlier work (Roquet, 2016). Most media aiming to intervene in the “tuning” of a space do so by attempting to blend in to existing environments, including everything from early background music on record players to more recent computational interfaces using algorithms driven by environmental sensors. Ambiance modulated via digital interfaces has become an increasingly common approach in the last few decades. Mark Weiser’s influential vision for ubiquitous computing in the 1990s imagined it as a “calm” technology that can “disappear into the background” (Weiser and Brown, 1997; Weiser, 1991, 98), an approach later described by Eli Zelkha and others as “ambient intelligence” (Wright et al., 2008, 24).

¹. *Comparative Media Studies/Writing, Massachusetts Institute of Technology. 14N-427, 77 Massachusetts Ave, Cambridge, MA 02139 USA. proquet@mit.edu*

While often forgotten today, Weiser (1991, 94-95) initially positioned ubiquitous computing in opposition to virtual reality, which at the time was at the peak of its first era of popular attention and hype. VR, Weiser (1991, 94) writes, “focuses an enormous apparatus on simulating the world rather than on invisibly enhancing the world that already exists.” This opposition continues to shape the understanding of virtual reality today both among VR researchers and in popular discourse surrounding the technology. While many consumer technologies today take up the ubiquitous computing call to blend into existing environments, VR’s primary aim appears to be the exact opposite: to perceptually bring a person elsewhere, allowing a VR user to transcend wherever they currently find themselves. Facebook’s inaugural campaign for their Oculus Go headset, for example, promised the device would allow a user to “go anywhere.”

In contrast, philosophical work attending to mood, ambiance, and atmosphere emphasizes how there is ultimately no getting away from the atmospheric determinants of an existing space. Martin Heidegger’s writing on *Stimmung* (2010, 132-33) is explicit on this point: “Mood has always already disclosed being-in-the-world as a whole [...] We never master a mood by being free of a mood, but always through a counter mood.” The most media can do in this understanding is to help reshape and remediate the current tuning of the environment. Media are better understood as tools to help remaster the given mood, rather than offering an opportunity to jettison it and start over from scratch. Departing from VR orthodoxy, I argue that this is even - and perhaps *especially* - true of “immersive” media like virtual reality.

From an ambient perspective, virtual reality is best understood not as a departure from the given environment, but as a computational space nested inside the atmosphere already surrounding the VR user. As Andreas Philippopoulos-Mihalopoulos describes (2015, 142), atmospheres are themselves already an immersive enclosure: “once inside the atmospheric interior, one cannot see outside.” Like VR space, the physical environment is perceptible in every direction. There is no turning away. The VR interface in this sense replicates the already-existing ambient enclosure of the everyday human-scale environment, but shrinks it down and straps it to an individual human head. VR leverages stereoscopic (3D) visuals, binaural (3D) audio, and a positionally-tracked headset and controllers to perceptually fix the VR user at the very center of a virtual environment. This virtual space is continuously re-rendered through screen and speakers in response to every shift in a user’s perspective, much like the external world continuously registers on human retinas and eardrums as a person moves through space. VR users thus find themselves within two immersions simultaneously, their attentions stretched across both a computer-driven ambiance and the given atmosphere of the surrounding world. The two spaces may complement one another, or they may be in tension. In either case, the VR user is tasked with being inside two places at once. The “break” Sanches-Vives and Slater describe is never absolute, but rather splits the immersion across the environments inside and outside of the headset. The rest of this essay seeks to begin thinking through how exactly VR splits ambiance across the interface, and what is at stake in bifurcating a person’s environmental situatedness in this way.

The Vacuum of Virtual Space

First, let’s consider what aspects of the ambiance of a physical environment can and cannot be currently reproduced within a VR headset. Virtual environments for VR are nowadays commonly constructed using game design software like Unity or Unreal Engine. The ambient quality of the space is directly affected by environmental design

choices like the use of light, shadow, polygon modeling, graphics shaders, and spatial audio, all of which may be limited by the processing power required. These areas are all sites of active research, and will likely come to more closely approximate perception of a non-virtual environment over time, if never matching it entirely. New approaches to rendering virtual light, for example, are shifting more and more towards replicating what James J. Gibson (1979, 65-92) called the “ambient optic array,” or how the angles of light rays reflecting off surfaces change in real time as a viewer shifts position in space. Of course, just because current VR environments have less detail than those of existing physical spaces doesn’t mean they have *less* ambiance, just a different kind. To the extent the computational origins of a virtual environment are perceptible within the space itself, this might even be considered a *computational* ambiance, with all the varied associations this might carry for a specific individual. As Lombard and Ditton (1997) suggest, a VR user with a background in programming and 3D design will likely be less inclined to understand a virtual environment as equivalent to an actual physical space, and more likely to perceive it as a set of computer-driven parameters. As with other forms of ambiance, a person’s past experiences and social positioning intersect with the forces shaping the environment itself, informing how and how much a person fits into the space - whether that space is actual or virtual.

Even taking this into account, however, many perceptual qualities shaping the ambiance of a non-virtual space are simply missing from most current VR interfaces. A virtual ambiance will thus necessarily be defined in part by what is missing: smell, for example, or gravity, including physical resistance from objects and surfaces. Perhaps the most important missing element of all is air, the literal atmosphere of a space. The lack of air also means a lack of temperature, humidity, and atmospheric pressure. The virtual space on the other side of the screen and speakers can only gesture towards these qualities indirectly. VR environments sometimes attempt to hint at the presence of air by using particle effects to give texture to the otherwise empty space between objects - randomly drifting polygons approximating dust or pollen reflecting the light. But (in my experience at least) this can easily backfire, drawing attention instead to the lack of oxygen in the vacuum of virtual space. The otherwise immersive qualities of the environment make these absences all the more noticeable.

If the virtual space itself lacks these properties, the existing atmosphere of the environment surrounding VR use will continue to provide them. In this way, the ambiance surrounding VR use will always necessarily be hybrid. Some aspects will be tied directly to the computational rendering inside the headset: visual elements coming within the headset’s field of view and sounds coming through the headphones, along with the small degree of haptic feedback available when the controllers vibrate in the hands. Simultaneously, ambient aspects falling outside the interface will continue to be drawn from the immediate surroundings: all the qualities of the surrounding air, the Earth’s gravity, the solidity of the ground and any other surfaces in the area, any sounds leaking in around the headphones, and any light peeking in through the nose bridge of the headset.

As Brendan Keogh (2018, 22) argues in relation to videogames, spatial mediation bridges actual and virtual worlds as a player’s attention flits back and forth between the screen and the surrounding environment. While “an experience of immersion by the player may very well be the *æsthetic* goal of many videogames, immersion as a critical and evaluative tool tends to obscure the full machinations of embodiment *across worlds* that videogame play constitutes” (Keogh, 2018, 35, emphasis in original). Any experience of mediated ambiance, likewise, is shaped not just through the virtual spaces produced by the interface, but how these spaces perceptually intersect with the actual environments they arrive nested within.

Felt Time Between the Sun and the Sky Box

Just as spatial experience is shaped by the confluence of actual and virtual ambiance, so too is the experience of time. The discourse of virtual “immersion” tends to assume a VR user will forget the passage of time outside of the virtual experience, implying virtual time has no relation to the time of the outside world. However, much like space, the felt time of a VR experience necessarily intersects with and further mediates the temporality of the surrounding environment. Here too past experiences play an important role. While popular VR discourse often focuses on the awe and wonder often felt by a first time VR user, the experiential quality of VR is very different for someone frequently returning to VR over a sustained period, whether for work or entertainment. Virtual perception is shaped by practice and familiarity over time, weaving the perception and navigation of virtual space into embodied habits. As Kiri Miller (2017, 22-23) succinctly describes, “practice is how you get from virtual to visceral [...] repetition and structuring practice gradually change the quality of experience.”

The importance of practice in shaping experience is particularly clear in the case of VR developers, who are currently the population most likely to spend many hours a day inside a headset. Here the possible asymmetries between actual and virtual time may even start to interfere with individual biorhythms. American VR artist Danny Bittman (2018) speaks of the unsettling experience of taking off the VR headset after spending all afternoon working inside the *Tilt Brush* VR painting program. While the virtual sun of the software’s “sky box” stays bright in the sky throughout, Bittman describes feeling depressed when taking off the headset after a long shift and realizing the actual sun had already set long ago. This disconnect in experiential time - the direct result of a mismatch between the ambient light inside and outside the headset - forces VR users to stretch their bodies across multiple temporalities at once. While this anecdote may at first appear to provide evidence of how fully “immersive” VR can become, Bittman’s strategy for overcoming the alienation of VR’s mismatched temporality runs in precisely the opposite direction: he recommends taking frequent breaks from the headset to reconnect with the surrounding environment and “ground” perception back in the real world.

Other contexts, such as VR software for relaxation or virtual travel, may call for a more deliberate “counter mood,” replacing the ambient conditioning of the immediate environment with a markedly different virtual space and slowing down or speeding up the experience of time accordingly. But here as well, the virtual ambiance will be deeply shaped by how it intersects with the broader environment around the VR user, including the experiential time immediately prior and immediately following the period spent inside the headset. The relationship between these spaces has emerged as a key theme in location-based VR installations, including theme parks and film festivals, where participant ‘on-boarding’ and ‘off-boarding’ rituals and carefully staged physical environments can be designed to enhance rather than conflict with the in-headset ambiance - a conjoining of actual and virtual Saker and Frith (2020) describe as “coextensive space.” ‘Deeper’ immersion here emerges not from virtual space alone, but through a careful syncing of ambiance across actual and virtual environments.

This ambient overlap becomes especially complex in the case of multi-user VR experiences where users are not co-located in the same physical space. In these contexts the ambiance can spread across not only the user’s actual and virtual surroundings, but across the network into the physical spaces surrounding other VR users accessing the same virtual environment. When I play player-vs-player in *Eleven: Table Tennis*

VR, for example, I can not only listen to my networked opponent speak during our match, but also hear occasional background sounds leaking into their headset microphone from their local environment, such as noises from kids or other family members. Stretching ambiance across a network like this is nothing new in itself: the telepresent sounds on the other end of the telephone line have long offered clues to a caller's local environment. Networked VR raises the complexity level, however, weaving this network of background physical atmospheres into the shared perceptual volume of a VR space, which itself often serves as an ambient background for a foreground virtual activity (in this case, ping pong). None of these layers fully replace the others; rather, the overall ambiance is established by how they do or do not come together.

Will this convolution of different ambient layers enhance the experience, as in the most immersive location-based VR installations? Or will it further break the connection between actual and virtual space, leading to the kinds of alienated feelings Bittman describes? In either case, an ambient perspective on VR highlights the importance of how atmosphere spreads across a media interface, bringing actual and virtual spaces into both conflict and cohesion. In using any medium, some aspects of the actual environment will be supplanted by the virtual space provided by the device, while other aspects of the existing atmosphere will persist in conditioning the virtual experience. VR is especially helpful for thinking this process through, because despite the frequent promises of complete virtual immersion, it remains an interface deeply determined by the actual spaces surrounding the headset itself.

References

- Bittman, Danny. "Making Art in VR." Talk at the Massachusetts Institute of Technology, April 12, 2018. Recording available at https://youtu.be/v_R0aQzaxHI.
- Gibson, James J. *The Ecological Approach to Visual Perception*. Boston: Houghton Mifflin, 1979.
- Heidegger, Martin. *Being and Time*. Trans. Joan Stambaugh. Albany: State University of New York Press, 2010.
- Keogh, Brendan. *A Play of Bodies: How We Perceive Videogames*. Cambridge, MA: MIT Press, 2018.
- Lombard, Matthew and Theresa Ditton. "At the Heart of It All: The Concept of Presence." *Journal of Computer-Mediated Communication*, 3.2 (1997): n.p.
- Miller, Kiri. *Playable Bodies: Dance Games and Intimate Media*. Oxford: Oxford University Press, 2017.
- Philippopoulos-Mihalopoulos, Andreas. *Spatial Justice: Body, Lawscape, Atmosphere*. New York: Routledge, 2015.
- Roquet, Paul. *Ambient Media: Japanese Atmospheres of Self*. Minneapolis: University of Minnesota Press, 2016.
- Saker, Michael and Jordan Frith. "Coextensive Space: Virtual Reality and the Developing Relationship Between the Body, the Digital and Physical Space." *Media, Culture & Society* (forthcoming 2020).
- Sanches-Vives, Maria V. and Mel Slater. "From Presence to Consciousness Through Virtual Reality." *Nature Reviews Neuroscience* 6 (2005): 332-9.
- Weiser, Mark. "The Computer for the 21st Century." *Scientific American* (September 1991): 94-104.

Weiser, Mark and John Seely Brown. "The Coming Age of Calm Technology." In *Beyond Calculation: The Next Fifty Years of Computing*, edited by Peter J. Denning and Robert M. Metcalfe, 75-85. New York: Springer, 1997.

Wright, David, Serge Gutwirth, Michael Friedewald, Elena Vildjiounaite, and Yves Punie, eds. *Safeguards in a World of Ambient Intelligence*. London: Springer, 2008.

Adapting Sensibilities Beyond 'Screen-Deep' Spatial Experience

Materiality and Atmosphere in Our Screen-Deep Virtual Excursions

Gillian TREACY¹

Abstract. Looking within and beyond our current situation it is clear that new sensibilities of spatial experiences are emerging that can no longer be defined by our physical presence alone. Working with screen-deep spatial encounters, virtual 'visits' or 'excursions', challenged by a depleted range of sensorial information, our situation demands new methods of representation and interpretation. This study explores how can we define and adapt our understanding of architectural sensory information. It provokes questions into our relationships with the atmosphere of architectural space and the data that might help define it. Findings propose how, as designers, we might provide increased opportunities through virtual excursions, to glimpse into a tangible embodied understanding of architectural spaces.

Keywords. Virtual, Screen, Architectural Space, Embodied, Atmosphere

Introduction

The normalisation of worldwide spatial confinement of 'lockdown' in the early part of 2020 due to the Covid-19 pandemic was reassuringly contradicted by the easily accessible open door to infinite screen-deep digital worlds through our computer screens. The internet provided virtual visits to architectural spaces allowing exploration of new and familiar places anywhere in the world from our own homes. Yet, the tangible, experiential understanding of spaces, that of physical space, materiality and atmosphere of place, remained seemingly untouchable.



Figure 1. Photograph of physical site visit to St Benedict's chapel, Sumvitg, Switzerland, G Treacy, April 2019

1. School of Design, Edinburgh College of Art, the University of Edinburgh, UK, gtreacy@ed.ac.uk

Looking within and beyond our current and evolving situation it is clear that new sensibilities of spatial experiences are emerging that can no longer be defined by our physical presence (Fig. 1). Working with screen-deep spatial encounters, challenged by a depleted range of sensorial information, demands new methods of representation and interpretation. This provokes questions into our understanding of the ambience of each architectural space and the data assisting in defining it. A hypothesis is proposed that we can develop our sense of touch through our eyes and ears to provide cues to the atmosphere of a virtually experienced space.

This research questions and tests examples of how we might shape evolving human sensitivities to work autonomously, replacing our traditional appreciation of spaces only through direct physical emotions. It explores and tests a selected architectural space through the accumulation and layering of spatial and environmental data using basic digital tools, common sensor technologies and video capture to explore the missing 'essence' of materiality and atmosphere in our screen-deep virtual excursions. This paper highlights the successes and limitations of a proposed new methodology for heightening our awareness and reconfiguring our understanding of the physical materiality of new spatial experiences.

The Contextual Setting

Few studies have been conducted in this area specifically. Therefore, this paper aims to start a new conversation by investigating how a screen-based experience of an architectural space as a physical or virtual journey influences how we perceive spatial atmosphere. The main contribution of this paper is to identify the primary layers and elements of an architectural space that need to be understood when we experience spaces virtually in order to better appreciate the spaces and places we visit in a tangible way.

"If people are attuned to the spaces that surround them, they will be moved. Knowing how to 'see space', or how to be spatially attuned, is an ability with which we are all born" Royal Academy of Arts (2020).

This study commences by investigating varying representations of a 3-dimensional physical environments through a new lens, that of the digital flat screen. The following examples aim to identify the basis and context for the approach taken within this research.

The larger emerging field of study within which this research positions itself relates to both virtual environments and phenomenology of place. Current dialogue in this area implies spatial immersion often understood as a simply synthetic experience or, through more complex interactive computer simulations delving into AR or VR. Artistic imagery, architectural renderings, cartography and games often exploit abstraction to clarify, exaggerate, simplify or emphasise the visual content of the spatial experience. These techniques allow artists to highlight specific visual information and thereby direct the viewer to important aspects of the structure and organization of the scene .

In addition, if we consider the level of detail within a virtually rendered architectural scene in comparison to a video of a physical experience or photograph, this too is understood to have an impact on the emotional engagement of the participant. Duke et al. (2003) These researchers hypothesized that participants perceived the higher the level of detail as more intriguing for exploration.

However, Pallasmaa (2014) argues that “The quality of a space or place is not merely a visual perceptual quality as it is usually assumed. The judgement of environmental character is a complex multisensory fusion of countless factors, which are immediately and synthetically grasped as an overall atmosphere, feeling, mood or ambiance.” This study seeks to begin addressing these hidden complexities, beyond the visual.

The Research Study

Building on these research themes this study sought to question how the data contained within physical architectural spaces; such as light and sound might supplement the experience of virtual spaces to help us code our screen-deep environments in new ways.

When explored through spatial environments, the nature of both of these interactive elements purports to ontological complexities that imply a continuation within a space regardless of our presence. Sound can exist in a space with or without a listener. Light can exist in a space visible by someone in that space and it exists without anyone seeing the light interactions within the space. This idea therefore suggests that we might still learn to understand architectural spaces viewed through the medium of a flat screen by exploring their unique atmospheres even without our physical presence by engaging with the interactions of sound and light; by seeing and hearing the space itself.

This research therefore considered two aspects of this notion through experiencing videos of the interior of an architectural space to seek to identify the possibilities in both the built 'virtual' space and the built 'physical' space as a viewer, through the lens of the computer screen. Further, through an additional layer of sound and light applied to the video material, the possibilities and value of this type of information in assisting the atmosphere of the space could be evaluated. The first study proposed addressing physical presence within a space through a recording of a physical visit to this same space. The second provided manipulation of layered elements of the recording to magnify selected sound and/or lighting information. The third context engaged the viewer with an architectural space built virtually, allowing light and sound interactions to be viewed as additional visual representational layers to emphasise the interactions between the built fabric and its sensorial characteristics.

An exemplar architectural space was used to explore data collected through physical and 'screen deep' research. Environmental measurements, photographic and video data were collected and collated in April 2019 during an architectural trip to Switzerland and in April 2020 from a virtual architectural trip to the same building during 'lock-down' from Scotland, UK. The selected building for this study is St Benedict's Chapel in Sumvitg, Graubünden, Switzerland, designed by Peter Zumthor (1988). This modestly sized chapel interior expresses a vocabulary of minimalist timber columns, beams and benches with clerestory windows providing daylighting. The simple, considered, craftsmanship evident in the selection of materials and the detailing defines Zumthor's famed approach to materiality of place and the unique design response this demands.

This paper summarises a series of experiments carried out through April 2020, investigating affective (emotive) qualities of videos that explore the interior of the chapel. A set of videos of St Benedict's Chapel were sourced from Youtube and my own library resources collected in 2019. These videos were then developed to use as prototypes for a survey of 60 architects in the UK. Sensorial inputs were adjusted for each set of presentation information. Various apps were used to develop and add this information

to the videos including iMovie, After Effects, 3dsMax, Wavepad, Edenapp, Oria wireless thermometer and Photolux app. Each video contained varying sensorial inputs as listed below and assigned to 3 separate survey groups. The sequence within which participants were exposed to each video scenario was considered to ensure indicators of atmosphere were not used as a reference too early in the testing process but provided a development of understanding. Further, at each stage, participants were asked to complete answers to questions in relation to the material provided and their understanding of the atmosphere and materiality of the space.

Set 1 - Raw data: Peter Zumthor's recording of a visit to the chapel² - 3 variations of combined or omitted audio and video.

Set 2 - Raw data: Peter Zumthor's recording of a visit to the chapel³ and on-site measurements of temperature data (Oria) - 3 variations of combined or omitted audio and video.

Set 3 - Raw data: 3DSMax model walkthrough of chapel developed from measurements and photographs from site visit, April 2019 (Oria, laser distance measure, Samsung phone, Edenapp, Photolux and Wavepad) and audio from Peter Zumthor walk-through - 3 variations of combined or omitted audio and video.

Findings

61 architecture professionals took part in the survey, each test set was assigned to a group of approximately 20 participants. Set 1 and Set 2 considered Peter Zumthor's own recording of a visit to the chapel and Set 3 provided a virtual 3-dimensional model experience.

The key findings related more closely to the use of audio than any of the other visual data layers that were developed or revised. The Set 1 'audio only' mp3 file provided interesting descriptions and these varied from, 'an ancient space', 'somewhere hidden' to a 'community gathering space' or space 'close to nature'. Over 50% of Set 1 participants noted the movement in the floor was audible. In addition, using the audio only file, participants were able to identify that the space was not a particularly small room and had hard surfaces due to the acoustic appreciation of the reverberation time. When answers were analysed it was clear that Set 3 participants benefitted most from the introduction of audio. When the same audio track from Set 1 and 2 videos was added to the 3DSMax model virtual video view participants were immediately able to discuss the materiality in the space (timber, wooden benches etc.) and they were able to talk of the atmosphere with more confidence.

Discussion

This research concludes by highlighting the successes and limitations of this new methodology in heightening our awareness and reconfiguring our understanding of the physical materiality of new spatial experiences.

In the creation of the videos, basic cameras, measurement tools and 3-dimensional drawing software was used. The resulting videos and the experience of viewing these, sought to inform the viewer of the acoustic and lighting interactions with the built

2. Peter Zumthor - St Benedict's Chapel: <https://www.youtube.com/watch?v=mOPWNid856c>

3. *Ibid.*

fabric providing indicators of the properties of the spatial physical environment. It was understood and noted that this viewing experience was influenced by many other factors such as the screen size, the physical space the video was viewed from (ambient light and visual adaptation and sound interruptions) and the affective and cognitive state of the viewer and listener. The level of skin-deep screen experience was ultimately influenced by a combination of factors. Further limitations in this study exist due to the single space used to carry out the analysis and visualisations.

However, by collecting and visualising the various interactional spatial elements of light and sound together it became possible to demonstrate how reliant we are in the understanding of them to appreciate a space beyond an insubstantial 'skin deep' approach providing a platform from which to further explore. For instance, the experience of viewing the different videos allows different associations to be drawn between proprioceptive feelings as the viewer is taken into the space to the memory of similar spaces previously experienced, raising the question of how the elements of light and sound in a space may influence each other and collectively determine our perception of an architectural space.

Janson (2014) discuss that materials address our senses to varying degrees, for the most part, the properties of materials are not perceived in isolation, but in their interaction with other materials, which modulate, contrast, or accentuate one another. In the right proportions, a variety of materials can be coordinated with one another to shape the atmosphere of the room so that it 'resounds' with a characteristic chord. The layer of audio in the video recording by Peter Zumthor during his visit clearly when in the real physical space clearly heightens our understanding of the atmosphere more than we might have previously imagined. Janson (2014) also comment that, "As expressions of total situations, however, atmospheres are also generated through use, and through our knowledge of places." It would be nonsensical to argue against the fact that background knowledge augments appreciation. However, these findings imply that even the knowledge of places as recorded by someone else can provide us with missing data and supplemental cues to understand the atmosphere of the space that we cannot be physically present in.

We can also enjoy screen-deep experiences in a more embodied way if we seek to add audio that helps to define the characteristics of the space and allow us to imagine we are really there. Böhme (2017), proposes, "In the church space, though, silence is most intensively articulated by one's own footsteps." Through the echoing sound of "one's own footsteps," allowing one to experience "one's own lostness in space" it can become possible once again to feel physically present during our virtual excursions through our digital screen.

This research sets out not to teach people what to understand about architectural space but to understand above all else that architecture is a personal experience embodied with various sensorial levels of complexity. When a single layer of this encounter is missing we too miss this part of the experience. What we enjoy most is the opportunity to glimpse into an embodied understanding of the space, even if temporarily, and even if virtually - its atmosphere and associated unique complexities.

References

Böhme, Gernot. *Atmospheric Architectures : The Aesthetics of Felt Spaces*. Edited by Anna-Chr Engels-Schwarzpaul. London : Bloomsbury Academic, 2017.

Duke, D. J., P. J. Barnard, N. Halper, and M. Mellin. "Rendering and Affect." *Computer Graphics Forum* 22, no. 3 (2003): 359-68.

Janson, Alban. *Fundamental Concepts of Architecture : The Vocabulary of Spatial Situations*. Edited by Florian Tigges. Basel: Basel : Birkhäuser, 2014.

Juhani, Pallasmaa. "Space, Place and Atmosphere. Emotion and Peripheral Perception in Architectural Experience." *Lebenswelt* (Milano), no. 4 (2014).

Nan, Liangliang, Andrei Sharf, Ke Xie, Tien-Tsin Wong, Oliver Deussen, Daniel Cohen-Or, and Baoquan Chen. "Conjoining Gestalt Rules for Abstraction of Architectural Drawings." 30, no. 6 (2011): 1-10.

Royal Academy of Arts, 'Royal Academy Eye Revolution - Sensing Spaces' - Accessed June 1, 2020. <https://www.eyerevolution.co.uk/tours/SensingSpaces/>

'Peter Zumthor - St Benedicts Chapel' Video Recording, Accessed June 1, 2020. <https://youtu.be/mOPWNid856c>

From Attention to Spatial and Informational Mobility

Towards a Digital Common to Design a Dynamic City

Outcomes of Mobiance 4 workshop

Myriam SERVIÈRES¹,
Steven SAULNIER-SINAN²,
Barbara PIGA³

Abstract. The 4th edition of Mobiance workshop, held in Grenoble in October 2019, brought together 18 international students (engineers, architects, marketing experts, and urban planners) from 6 different countries. The workshop goal was to focus on spatial and informational mobility without any technological limit, starting from a real transportation hub in Grenoble, namely Chavant. Their proposals show a city automatically adapting to the needs of citizens and continuously collecting data, even the most intimate one. They proposed omniscient digital universe that fluidly links the real and the digital spaces. Keeping in mind the limits and the drawback of such concepts, the future shared city might be a city made as a common.

Keywords. *Ambiance, Urban design, Mobility, Digital Common, Attention*

Introduction

The interplay between analogue and digital practices redesigns our attention and changes our understanding of the physical world. Sensitive urban environments evolve with the emergence of what is now called ambient intelligence (Aarts and Marzano, 2003; McCullough, 2013). Those modifications are especially noticeable in mobility spaces that are increasingly equipped, amplified, or augmented.

The first Mobiance in Nantes (2013) questioned mobile tools as devices for analysing and designing the built environment, highlighting the problem of urban ambiances. The second edition in Nantes (2015) focused on the effects and practices of interacting sensors in the city. The third edition in Milano (2017) explored and considered future urban scenarios in the context of the sharing cities paradigm. For this fourth edition in Grenoble (2019), we focused on the increasing influence of Digital Information and Communication Technologies (DICT), which might be studied in two ways: from urban sensory environment evolution and ambient intelligence emergence, from mobility practices and experiences, which is increasingly equipped, amplified and enhanced. In such a context, the focus of ambiances leads to the diffuse and omnipresent phenomenon which permeates daily experiences of commuters and involves multiple technical interfaces that reconfigure the contemporary urban environments (Crag and Graham, 2007). This informational environment in which commuters are immersed impacts their perceptions and practices, their movements, and daily shifts. This new sensory ecology of the urban experience requires a turn to the central issue of attention and its various processes (Citton, 2014) when you want to study urban

1. AAU/CRENAU ECN/IRSTV - Laboratoire AAU, FRANCE, myriam.servieres@ec-nantes.fr

2. AAU/CRESSON - Laboratoire AAU, FRANCE, steven.saulnier@grenoble.archi.fr

3. Laboratorio di Simulazione Urbana 'Fausto Curti', Politecnico de Milano (DASTU), Italy, barbara.piga@polimi.it

from a sensory way.

What shapes could be designed for future mobility spaces? How does this hybridity transform our experience of spatial and informational mobility? How to contribute to developing a sustainable design of mobility situations and transportation spaces? What kind of evolution could be highlighted from these new urban requirements? What attention modality could be experienced from the urban environment?

In the following paper, the outcomes of the students will first be reported then analysed. Their proposals were based on a place in Grenoble, Chavant, with a focus on spatial and informational mobility.

Framework and Proposals

The 4th edition of this workshop, held in Grenoble in October 2019, brought together 18 international students (engineers, architects, marketing experts, and urban planners) from 6 different countries. They were invited to redefine a given context without any limits in technology. For 3 days they worked on one of the major transportation nodes of the city, named Chavant. For the first time in the Mobiance editions, we proposed students an existing place to research on. They had to anchor their concepts to a delimited physical space with its own pros and cons. Tramways, bus and car lanes, pedestrian streets, bike lanes, cross this space in several directions often without clear signage.

The following section describes four out of the five students' proposals for this area.

CoMobile

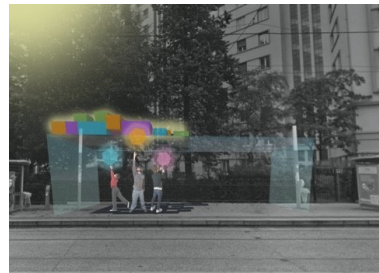
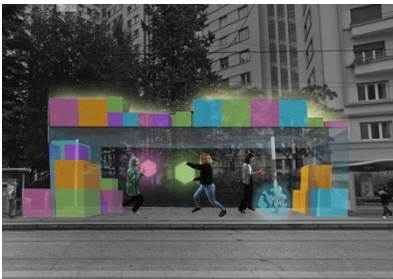

Figure 1. Two illustrations of the use of CoMobile at a tramway stop in Chavant, Grenoble - [CC-BY-NC 4.0 A. Gupta, A. Moustaine, O. Palic]

CoMobile stands for collaborative mobility. This group observed that social interactions were weak in mobility nodes. Hence, the CoMobile system aims to encourage playful interaction while waiting at public transport stops. It reacts to people's unconscious behaviour and mood while they are waiting, and it encourages passenger attention to each other using Mixed Reality. This project aims at reinventing stations with a playful approach. Virtual blocks (e.g. blocks, balls, Tetris, etc.) appear around the station and people can interact with them together with other people (Figure 1). As soon as they move away, the simulation disappears. The tool is able to automatically adapt itself to the environment and is different for each station. According to the authors: "CoMobile thus envisions a future that is collaborative, adaptable, conscious, inclusive and a crucial part of the city."

The Sand City

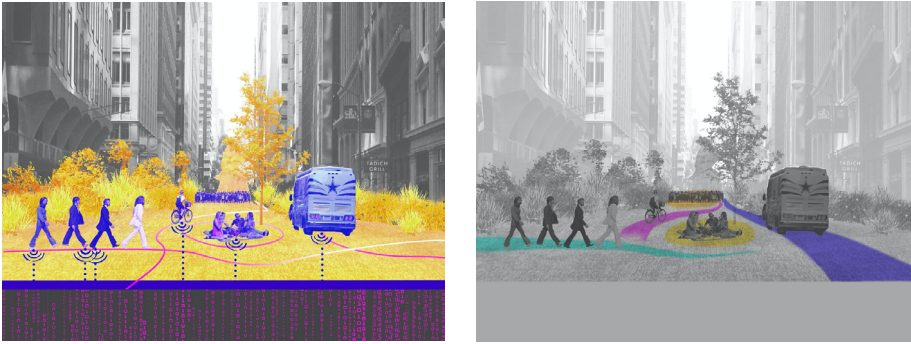

Figure 2. On the left, the Sand City captures users' desires and uses through the set of sensors; on the right, it adapts itself to the input. [CC-BY-NC 4.0 M. Dubreil, A. Hmidouch, I. Morel, E. Talvard]

For this group, current urban mobility solutions (e.g. bus lane, car lane, pedestrian pathway) drive the flows in a rigid way. Each modality has its path defined by a specific signaling system, which results in a division of space that often does not correspond to human dynamics and might cause stress, conflicts, and inefficiencies in transportation. The goal of Sand City is to increase the livability and accessibility of mobility spaces for citizens. Open urban areas become a responsive interface adaptable in real time to urban flows. Mobility flows dynamically rearrange the urban space, as the water makes its way through the sand as the sea retreats. The city becomes an interface mobility draws its path thanks to the analysis of sensors detecting the activities of users. The city is continuously redesigned through the capture of quantitative (e.g. number of people in each modality) and qualitative data (e.g. user emotions). It reshapes the spatial experience (through temperature, colours, sounds, textures) while capturing personal data (destination, schedule, mood) and sensory data (transport means, size, speed) interacting with users (Figure 2). It is a self-regulated model that maximises time and size per flow.

Moodility - from mood to mobility



Figure 3. Moodility illustration: if enough people want to cross the light turns green and pedestrians take precedence over cars - [CC-BY-NC 4.0 C. Gauchet Dumortier | C. Derue | E. Braconnier | N. Brooks]

This group focused on the people's mood and how mobility could affect it. They aim at accommodating people's moods during its movement through the city through a *moodity* microchip implanted in the brain that allows them to be interconnected between them and the city. This chip continuously monitors the person's physical and

emotional state and an algorithm allows to produce personalised suggestions to alleviate the mental stress of mobility and consequently improve the traffic efficiency. Through Moodility, the city is connected (Figure 3). This group aimed to accommodate people's feelings through mobility.

City: Sustainable Interface

Figure 4. Representation of the uses of the city through coloured paths - [CC-BY-NC 4.0 A. Mounereau; F. Brett; M. Abdallah; J. Bricot]

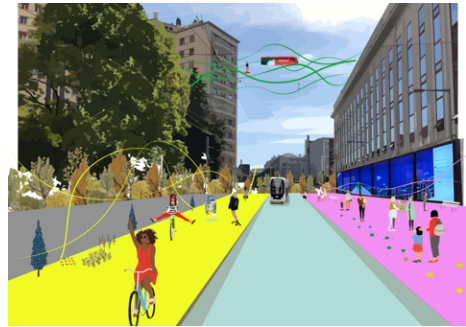

This group imagined a (car-free) city as a sensitive interface that reacts to the sensory needs of people (four on five senses). It does it through touch, sight, hearing, and smell. This group aims at creating a calm and relaxing space where people can be surrounded by natural sounds that counterbalance the urban noise. As interface, the city physically interacts with citizens reshaping itself according to people's needs detected through sharing data. Different colours of pathways, bike paths, buildings, and walls will create a much more visually pleasing place than the typical grey city ambient; this will encourage to appreciate city places as a singular system. Colour is a means of communication from the town to its inhabitants (Figure 4). The abolition of the car will make the city's atmosphere much more breathable.

Analysis

In this edition, as in the previous ones, students were fostered to think with no technological constraints, even if some solutions would have been appeared as science fiction. Anchoring their concepts to a real place has improved the materiality to the proposed solutions, but, compared to the other editions, it has been more difficult for them, at the very beginning, to think to solutions far from really feasible ones. The chosen place is a particularly complex urban hub in Grenoble, and the analysis of its functioning has influenced the proposals. Spatial as well as informational mobility was not new to the workshop participants, as it is a daily practice in their lives as young urban dwellers. However, the *Mobiance* prospective approach was a novelty that enabled them to rethink the relationship of people-space and the signals received in a transport hub. The common aspect of their proposals is a search for a dynamic city and the ever-increasing influence of data.

Design of a Dynamic City

One common denominator of these proposals was the design of dynamic spaces that allows the city to adapt itself to people - as individuals or community - through interfaces, but not people to adapt themselves to the city, through the use of any kind of digital technology. The traditional city is considered to be monolithic by the *Sand City* proposal looking for spaces that adjust themselves in real time. In *CoMobile* the space around the bus stops is collaboratively modified. In *sustainable interface* the city

adapts to the needs un/expressed by its users to provide a calm and relaxing environment, mainly through colours. In *Moodility* the users' emotional state is directly analysed and transmitted to the city that adapts itself to people's needs in order to support them (e.g. making traffic more efficient to reduce stress).

In all these proposals the concept of *Fab-city* (Diez and Posada, 2013) is traceable and taken to extremes. In *Fab-cities* citizens collaboratively use technologies and become manufacturers, in so doing they can express and meet their needs. In the original idea, it was rather the advent of the *fablabs* movement that was put forward through the example of a citizen empowerment project for the creation of environmental measurement sensors; in these cases, these were tools in the city, here the city itself responded by re-creating itself. This allows citizens to "regain local control through network reconfiguration" (Rumpala, 2018). The city is no longer only intelligent, it is made according to the desires of its users, and their moods play an important role in shaping it.

Gathering the Data - From Sensors to Mood

Attentions but also emotions, perceptions, and habituations are collected through these digital interfaces. In all the proposals, centralisation and agglomeration of a lot of personal data allow them to "make the city." There are tons of data collected everywhere, all the time. The city as an underlying layer of data like an extra flow in motion that runs through it. Who is collecting data? Who decides? Who is in charge of it? The resulting *Data City* (Peugeot, 2014) could be seen as ambivalent within its spectre of centralised control, which is frequently evoked but rarely explored; indeed, these questions were not addressed except for one group.

The data is considered as a common that needs to be shared to shape according to its citizens' needs. Students' concepts foresee the future city as an outcome of 'sharing': community data on citizens and space, where everything melts. Above all, it emerges a "digital commons" of a shared urban living. As Zandbergen and Uitermark (2019) asserts, the produced and shared data "afforded the sensing citizens the power of speech, mediating between these citizens and the larger community by virtue of their representational and argumentative quality." The issue of decision makers may not even be addressed because it may no longer be relevant. Citizen empowerment, which is currently illustrated by bottom-up approaches as in Carton and Peter (2017), is here pushed to its paroxysm, the city is made by citizens for citizens.

Conclusion

The participants made proposals where they envision an urban space that is not just a common space, but a redefinition of places modulated by citizens' most intimate emotions, embedded in an omniscient digital universe that fluidly links the real and the digital spaces. The digital/analogue space complementarity is keen on present and future issues, particularly in urban spaces, since, beyond the utopias/dystopias developed in *Mobiance*, the digital information available is already modifying the way we design and experience mobility. The proposals unload the attention processes of mobility users even at the cost of a systematic monitoring of citizens' data, movements and moods. As Zandbergen and Uitermark (2019) conclude in their article, this type of experiment "may contain seeds of alternative ways of organizing urban life," then keeping in mind the limits and the drawback of such concepts, the future shared city might be a city made as a common. The 'next' interface is the city itself. The interface would be the common, the shared territories that we do make better and valuable.

References

Aarts, Emile, and Stefano Marzano. *The New Everyday: Views on Ambient Intelligence*. Rotterdam (NL): nai010, 2003.

Carton, Linda and Ache, Peter "Citizen-sensor-networks to confront government decision makers: Two lessons from the Netherlands," *J. Environ. Manage.*, vol. 196 (2017):234-251.

Citton, Yves. *Pour une écologie de l'attention*. La Couleur des idées. Paris: Seuil, 2014.

Crang, Mike, and Stephen Graham. "Sentient Cities : Ambient Intelligence and the Politics of Urban Space". *Information, Communication & Society* 10, n°6 (2007): 789-817.

Diez, Tomas and Posada, Alex, "The fab and the smart city. The use of machines and technology for the city production by its citizens," *TEI 2013 - Proc. 7th Int. Conf. Tangible, Embed. Embodied Interact.*, (2013): 447-454.

McCullough, Malcolm. *Ambient Commons: Attention in the Age of Embodied Information*. Cambridge (US): MIT Press, 2013.

Peugeot, Valérie, " Collaborative ou intelligente ? La ville entre deux imaginaires ", in *Carmes, M. and Noyer, J.- M. (eds), Devenirs urbains, Presses des Mines, Paris, (2014): 43-64.*

Rumpala, Yannick, "Intelligente autrement: de la "Smart city" à la "Fab city". Émergence d'un modèle alternatif de ville "intelligente" et logiques de reconfiguration du collectif urbain," *Métropoles, no. Hors-série, (2018).*

Zandbergen, Dorien and Uitermark, Justus, "In search of the Smart Citizen: Republican and cybernetic citizenship in the smart city," *Urban Stud. (2019).*

VOLUME 1

08

INHABITING INSECURITY.
PRACTICES AND REPRESENTATIONS

09

PHYSICAL/DIGITAL SPACES COLLISIONS. SO WHAT?

10

PRESENCING ATMOSPHERES

11

SENSE AND SENSIBILITY OF AFFECTIVE ATMOSPHERES

12

SENSITIVE SPACES AND URBAN PRACTICES

Presencing Atmospheres

Session 10 – Introduction

Niels ALBERTSEN¹

For this thematic session contributions that have been invited interrogate and exemplify different ways of ‘presencing’ atmospheric experiences to different others in other spaces and times. ‘Presencing’ here indicates that original ‘in-situ’ - present - atmospheric experiences can and should somehow be made sensibly recognizable for outside others *as atmospheric*. The presencing of atmospheres should, one could say, *itself be atmospheric*. Another dimension of this problematic is the idea that the presencing of atmosphere can take place in-situ *itself* by enhancing people’s attentiveness to atmosphere through atmospheric intervention.

There are many ways of presencing atmospheres atmospherically. They may include poetry, literature, ‘thought pictures’ and other forms of verbal gestures, visual, auditory, haptic and olfactory arts, sculpture and architecture, exhibitions, and a host of new electronic media. They may include combinations among these as well as with more traditionally research oriented modes of representation, the point being that in case of atmosphere there does not seem to be such a thing as pure representation without expression or pure expression without representation; these are idealised poles between which we have only intermediaries of both, more or less oriented toward one or the other (‘rerepresentations’ or ‘reexpressions’!).

The idea then is that this issue calls for different approaches from different arts and sciences as well as the interaction between them. Contributions have been asked to exemplify atmospheric ways of presencing atmospheres, but were also allowed to interrogate more principled theoretical, philosophical and conceptual questions.

The outcome of the call is the exciting collection of papers to be read on the following pages. A quick overview runs like this:

All together the papers present different modes of presencing atmospheres. Two papers are focalised on sound. **Højlund and Udsen** report on the presencing of the aura of a shitstorm through a sound installation, which allows listeners to be affected by an atmosphere that was earlier only felt by the exposed individual. **Georganzi and Mantzou** explore how sound in video-games can evoke “a nostalgic atmosphere of a lost future.”

¹. Aarhus School of Architecture, Denmark.

Three papers investigate different ways in which the presenting of atmosphere occur through (other) artistic forms. **Sioli** demonstrates how literature can enable the presenting of atmosphere through the example of narrations of monuments of architectural heritage. Architectural heritage is also on the agenda in **Pais and Baptista's** paper. Against the background of Merleau-Ponty's distinction between the visible and the invisible and his insistence on the intertwining of both - and hence also their entanglement in atmospheric experience - the authors interrogate different artistic experiments occupied with architectural heritage. In **Mrad's** paper the artistic medium is film, more precisely the horror film. Through the example of Steven Soderbergh's *Contagion* (2011) the author discusses how epidemic horror film can serve as an investigative tool for the emotional understanding of the sensitive world of urban atmospheres in pandemic times.

Atmospheres presented by *the actors themselves* turn up in two papers. **Sancovschi and Duarte** present a case-study of the presenting of atmosphere through sensitive listening to testimonies, in casu a Congolese refugee sharing her life story with students from a public school in Rio de Janeiro. **Thomaz and Queiroz** approach the presenting-issue as a question of intensifying attention to atmosphere in-situ (re-sensitizing as presenting in actu/situ) by asking passers-by in the streets of Rio de Janeiro to take photographs. They also show how the observing researchers themselves are affected by such re-sensitizing.

The urban has been present as context in some of the above papers. Two papers address urban atmosphere more directly. **Morselli and De Matteis** investigate how atmospheric situations in post-earthquake cities in Italy can be presented through the variety of media utilized in *phenomenographical* mapping. **Loi** reports on how walking and photography through (situationist) drifting into the sprawling urban landscape of Cagliari together help to explore, capture and interpret the divergent atmospheres of the differing urban spaces of the landscape.

Resonance

Sensing a Shitstorm

Abstract. In this paper we explore how the affective and bodily experience of being the centre of a written shitstorm, can be translated to others through sensification. Through the 3D system Sound-O-Matic³, our installation aims to explore how an auralization of a shitstorm can allow the listeners to be affected by an atmosphere that was earlier only felt by the exposed individual. The paper describes the design process guided by the concept of resonance through an infraesthetic approach, as a way to explore, how we should not only resonate with the experience, but also critically reflect on the entanglements of resonance and reason. We identify four main refrains in the shitstorm that can be translated into the present through the installation, extending the shitstorm into a new sensory space that we can hear, feel and discuss.

Marie KOLDKJAER HØJLUND¹,
Anne-Sofie UDSEN²

Keywords. Sound installation, shitstorm, resonance, infraesthetic, affective atmosphere

Background and Context

In 1995, the artist Elle-Mie Ejdrup Hansen created “Peace Sculpture: Line - Light.” The work consisted of a 532 kilometres line of laser light, starting at the north tip of Denmark, to the German border in the south. It took place on the date of the Danish liberation from WW2. The event gained massive attention in the media in the months up until the artwork was shown, resulting in a large number of articles, creating what we today call a ‘shitstorm’.

To mark the 25 years since the artwork took place, an exhibition will take place in September 2020 at Viborg Kunsthall. In this context we have been invited to make a sound installation composed of quotes from the large archive of written articles. This paper unfolds the design process, with a focus on how the empirical data together with the concept of resonance have been used to guide the design process.

Empirical Data

The notion of shitstorm has gained public attention as part of the social media sphere. We use the term as described as “[...] the sudden discharge of large quantities of messages containing negative WOM⁴ and complaint behavior against a person, company, or group in social media networks.” (Pfeffer et al., 2014, 118). Ejdrup Hansens artwork was exhibited in May 1995, before the concept of shitstorm saw daylight, but

1. Aarhus University, Department of Communication and Culture, Denmark, musmkh@cc.au.dk

2. Aarhus University, Department of Communication and Culture, Denmark, asu@cc.au.dk

3. Developed by CAVI (Center for Advanced Visuals and Interaction);

<https://cavi.au.dk/technologies/sound-o-matic/>

4. WOM : Word-of-Mouth

as we now 25 years later re-exhibit the material, it calls for reflection on both how it existed then, and how it echoes in the present.

The empirical data used in the installation consists of quotes from Danish newspapers, gathered through a collection of approximately 2,800 articles about the artwork (Danish pop.: 5.8 mil.) written between August 1994 and May 1995.

Camilla Reestorff describes how shitstorms take on strength through strong emerging *refrains*. Through repetitions, the refrains create a specific form of intense atmosphere and become *sticky* (Reestorff, 2019). Referring to Sarah Ahmed (Ahmed, 2004), Reestorff argues that the refrains capture and transport affect as well as mobilize and intensify anger in defence of an undefinable “we” (Reestorff, 2019, 8). The refrains provide the affective cues and orientations that allows the crowd to be rendered into a public, inviting others to tune into the issue, but also affectively attune with the refrains that were sticking to it. Through this process the battleground is drawn, on which affect is governed and thus determined who are deemed legitimate players and which voices are heard in the debate. Through the refrains, it is negotiated which affects can be oriented towards which bodies (ibid., 17).

Reading through the 2,800 articles, we chose 190 quotes (36 females, 123 males, 31 unidentified) from 35 different newspapers and magazines, centred around the following four main refrains:

- Nazi associations:** the artwork evoke reminiscence of WW2 (e.g. through the inclusion of bunkers and laser light).
- Anti-feminism:** the artist is a young and inexperienced female incapable of creating ‘good’ art.
- “Is this art?”:** the art is not lasting and is only made of light, which is not a real art-material.
- Generation gap:** the young generation (including the artist) does not understand how it felt to be at war.

Furthermore, the quotes were chosen based on their ability to affect the authors of this article; their sheer ability to shock, disgust or by having a tragicomical character.

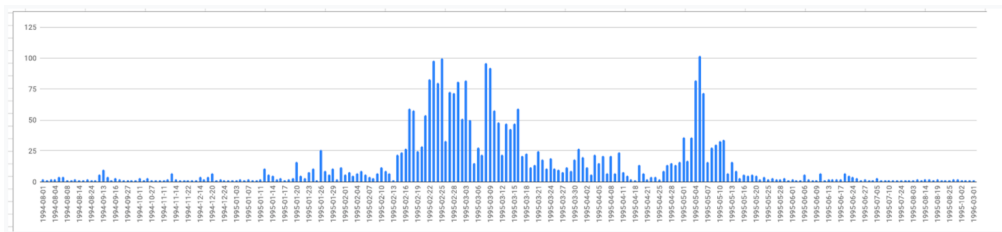

Table 1. Articles per day (1994-1996), Jakob Brask, 2020-06-18

Beside the collection of quotes, we also use the statistical data showing the chronological rhythm and the peak of the shitstorm (articles per day) to guide the development of the sound composition.

The Experience of a Shitstorm

Through Facebook we called for individuals who had been exposed to a shitstorm, to anonymously answer a questionnaire and symptom-chart entitled *The Feeling of Being*

in a *Shitstorm*. The survey was conducted in May 2020, and we received 13 answers (see Table 2).

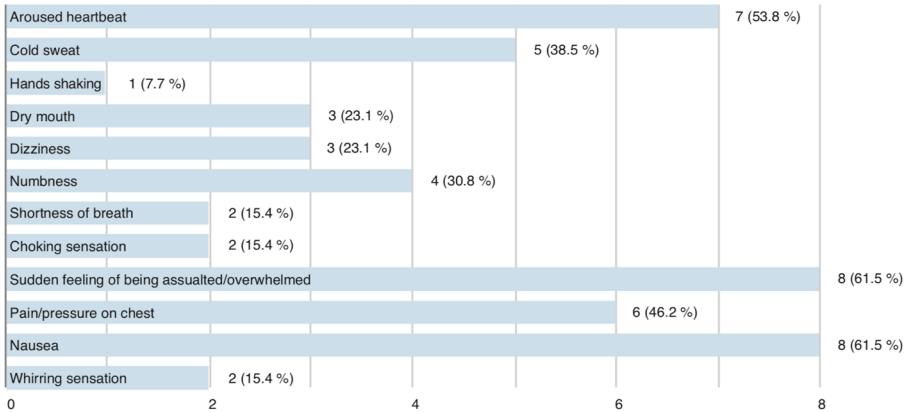

Table 2. Symptom-chart of *'The Feeling of Being in a Shitstorm'*, Højlund & Udsen, 2020-06-18

Apart from the pre-chosen symptoms, three participants added extra symptoms: sleeplessness, alert mode, rage, quivering in the whole body and stomach pain⁵. Even though the affects and bodily feelings of being in the middle of a shitstorm are experienced differentially, it is clear that arousal of bodily rhythms (heartbeat, pulse, breathing), feeling of dizziness and nausea and the intense feeling of a sudden assault is repeated in both symptoms and comments:

“High pulse pumping like a techno-drum, heartbeats, flicker of the eyes, tinnitus sound”

“I have two breaths, one where it is ‘me’ that breathes and one where it is the body [...] The body’s breath uses the muscles for a state of emergency, which is barely every one of them, from the toes to the eyes. The body is capable of moving my chest as an accordion in and out, and I can hold ‘my own’ breath and still breathe through the body. It is infinitely hard!”

Furthermore, several participants highlighted the feeling that the atmosphere around them changes as well, e.g.:

“It was as if, the room I was in, became much smaller, the ground disappeared under my feet, and my body turned itself inside out.”

Taken together, the participants describe the feeling as an intensely anxiety provoking experience, where the control of both body and surroundings are distorted. The bodily and affective experience of being in a shitstorm is a particularly powerful and intense atmosphere, that can be understood as “something which can come over us, into which we are drawn, which takes possession of us like an alien power” (Böhme, 2008, 3) as they “bathe everything in a certain light, unify a diversity of impressions,” and moreover, are “a quality of environmental immersion that registers in and through sensing bodies whilst also remaining diffuse, in the air, ethereal” (McCormack, 2008, 413).

5. All quotes are translated by the authors from Danish.

Designing for Resonance

Ejdrup Hansen's new exhibition is not only a retrospective work, but also a contemporary artwork that points to how our memories help in shaping how our lives and future unfold. Thus, we consider it to be the role of us as designers to translate not only the affective qualities as these risks to create an unbalance where cognition, interpretation and motivation becomes minor processes (Endensor, Sumartojo, 2015, 252). Thus, the goal of the installation is not only to create resonance in the audience with the affective quality of being attacked by a shitstorm, but also to invite for reflections on the historical and cultural conditions of a shitstorm.

Resonance is often described as a sort of affective attunement, a way of being 'in sync' with the world, people and things (Erlmann, 2010; Rosa, 2017). By contrast, reason is normally aimed at reflection and the cognitive domain. Nesting reason and resonance into one-another, Veit Erlmann describes his concept *reasonance* (2010) as a 'double duty' in which it is the natural mechanism that governs interactions of vibrant matter (Bennett, 2010): in this case, the collective attunement around the refrains, war and peace, art and shitstorm, past and present. On the other hand, reasonance is what creates unity between body and mind that the reflective human must unthink before it can "uncover truth" (Erlmann, 2010, 7).

Will Schrimshaw argues that such critical and reasoning distance can be hindered through overwhelming affectivity and immersion, as it presents us with the ability to enter an artwork as a multisensory enveloping environment rather than a distant object (Schrimshaw, 2017, 184). He argues that we then lose our capacity for decisions. We therefore need a critical approach to the immersive that does not shy from allowing the force of conceptualization and representation into the circle of immersion, as a space for critical distance, thought and action (ibid., 193).

Schrimshaw suggests an *infraesthetic* approach as an exit strategy from purely affective and aesthetic sufficiency through the use of sound as a means of generating movement and displacement within bodies and artworks (ibid., 57). This approach can be unfolded e.g. through the following gestures:

- Shifting focus from audible quality towards intensive quantity of sound;
- Addressing physical realm of signals towards how the forces of omnidirectionality affect change on the body through the extremes of audition in the lower end and upper of human hearing;
- Presenting real events, beyond subjective experience, e.g. sound that cannot be heard by human, but can be seen in its force on other objects.

Through these gestures it becomes difficult to locate the interior and exterior of hearing and the artwork. This confusion of limits points the limits of hearing and thus invites for critical reflection and allows us to explore boundaries of experience.

Schrimshaw's ambition is that the *infraesthetic* approach can open towards an ecological ethics that decentres human subjectivity, by e.g. exploring the limits of sensory experience. A decentring required to navigate and orient ourselves in relation to challenges of our time (Schrimshaw, 2017, 192). Jane Bennett furthermore describes that the aim of ethics should be to distribute value generously to the bodies (Bennett, 2010, 13). The value in this case being more attentive to the affects of digital behaviour. By exposing the public to the affects of the written word, we want to emphasize that "all bodies are kin in the sense of inextricably enmeshed in a dense network of relations." (Bennett, 2010, 13). Hereby creating an *infraesthetic* approach

that takes us away from pure aesthetics, and instead orients the installation towards being an affective atmosphere where reasonance can take place between bodies and artwork.

Shitstorm Installation

In the installation, the goal is for the guest to feel reasonance, firstly on an embodied and affective level, where the guest becomes resonant with the soundscape; tuning into the installation's frequency e.g. by feeling their pulse grow faster as the rhythm of the soundscape becomes faster. Furthermore, we want to create a space where the embodied feeling of being part of the sensoric atmosphere creates room for reason-making: what is a shitstorm? how are we interacting with it? are we participating? etc.

The installation consists of 20 speakers placed throughout a room, approx. 6x6m². In the middle of the room a circle is marked on the floor, inviting the listeners to stand in the auralized shitstorm experience. In the circle the listener is met by a galvanic skin response sensor and pulse interface asking them to place their hand on the screen to start the experience. When the installation starts, whispering voices will be heard from the corner speakers evolving to the remaining speakers in a storm like motion. Through the performance (3 min) more voices will be entangled in the experience, creating a soundscape of ambient voices that demonstrates the spreading of WOM, and end with a withdrawal of voices that leaves the listener in a soundscape of *bodily sounds* such as breath, heartbeat and ringing noises.

To sense the uncontrollable character and how the atmospheres takes over the body and breathing, the installation express power through conditions and activates pre-disposed affects, emotion and habitual unreflexive responses. In the installation, the infræsthetic focuses on orienting the listener towards embodied rhythms of reason-making practices that can re-habituate the listener. In order to translate this need, we consider the design as an attuning relation between the visitors' bodily rhythms and the installation (Højlund & Kinch, 2014). Hereby the installation conditions a thick immersive and potent atmosphere through quantity of loud sound, spotlight, swirls of movement in sound, sudden shifts, etc. that highlights the uncontrollable character of shitstorm.

Acknowledgements

We thank first of all Elle-Mie Ejdrup Hansen, and her assistant Jacob Brask for letting us dive into the archives and design the sound installation. Thank you to CAVI at Aarhus University, that developed Sound-O-Matic and helped us unfold the installation. In addition, we thank Asger Bruun Hansen for the technical assistance and discussions.

References

- Ahmed, Sara. *The Politics of Emotions*. Edinburgh: The University of Edinburgh Press, 2004
- Bennett, Jane. "Preface" and "The Force of Things" in *Vibrant Matter*. Durham and London: Duke University Press, pp. vii-xix and 1-19, 2010
- Böhme, Gernot. "The art of the stage set as a paradigm for an aesthetics of atmospheres." *Direction Générale des Patrimoines - DAPA - MCC, UMR 1563 - Ambiances Architectures Urbanités (AAU)*, 2008
- Endensor, Tim & Shanti Sumartojo. "Designing Atmospheres," *introduction to Special issue, Visual Communication*, SAGE p. 252-265, 2015
- Erlmann, Veit. *Resonance and Reason: A History of Modern Aurality*. New York: Zone Press, 2010
- Højlund, Marie & Sofie Kinch. "Alarming Atmospheres: Embodied Sound Habituation as Design Strategy in a Neuro-Intensive Care Unit." *Journal of Sonic Studies*, Vol. 06, 2014
- McCormack, Derek. "Engineering affective atmospheres on the moving geographies of the 1897 Andre Expedition" *Cultural Geographies* 15: 413-430, 2008
- Pfeffer, Juergen, T. Zorbach & Kathleen M Carley. "Understanding online firestorms: Negative word-of-mouth dynamics in social media networks," *Journal of Marketing Communications*, 20:1-2, 117-128, 2014
- Reestorff, Camilla. Møhring. "Affective Politics and Involuntary Autoethnography: Backlashes Against #Metoo" *Capacious: Journal for Emerging Affect Inquiry*, 1(4), II-XIX, 2019. <https://doi.org/10.22387/CAP2019.32>
- Rosa, Hartmut. "Dynamic Stabilization, the Triple A. Approach to the Good Life, and the Resonance Conception." *Question de communication*, no. 31, 2017
- Schrimshaw, Will. *Immanence and Immersion: On the Acoustic Condition in Contemporary Art*. Bloomsbury Publishing, 2017

Playable Sound

Hauntology in Bioshock, a Video Game for a Lost Future

Marilena GEORGANTZI¹,
Polyxeni MANTZOU²

Abstract. The medium of VideoGames, recognised as a hyper-sensory event and a new “form of literacy” according to Zimmerman, allows for the creation of atmospheres which exceed the sum of the parts, meaning audio, graphics, mechanics, etc. This paper focuses on the immersive, Dionysian aspect of sound which can create a nostalgic atmosphere for a lost future. Bioshock, displaying all sorts of atmospheric qualities, is a multi-awarded, first-person shooter game with RPG, horror and stealth game references. Its soundtrack will be analysed through the spectrum of hauntology, a term coined by Derrida, aiming to show how audio can be used to evoke extra-musical memories and contribute to the creation of a rich synthetic reality resulting in the longing of an unrealised utopia.

Keywords. Soundtrack, Video Game, Hauntology, Memory, Referential Listening

Introduction

Bioshock’s (BioShock 2007) story takes place in a decayed art-deco underwater city built in the 60s while the political ideas of Ayn Rand, George Orwell and Aldous Huxley form an interesting spine around which flourish the concepts of severe individualism, biopolitics and mind control. The city, named Rapture, houses a group of people who aspire to share the same ideology. This video game, having an extremely rich narrative with important plot twists explores a possible future which raises a series of political, technological, moral and social questions. The player, a plane crash survivor who finds seemingly accidentally shelter in the city, fights his way through the remnants of the city guided by a mysterious voice and explores the *fabula* behind this destruction through audio diaries of previous citizens. However, unknown creatures and voices from the past are not limited in these narrative devices. Even though there is an extended body of literature on Bioshock examining its relation to popular music (William Gibbons, 2011), to the concept of uncanniness (Robert Yeates, 2015) and to nostalgia (Andra Ivănescu, 2019), the intent of this paper is to accentuate that Bioshock’s soundtrack, following the principles of hauntology, results in the player’s immersion into an eerie and nostalgic atmosphere without indulging into mere anachronisms. Hauntology, a linguistic blend of haunting and ontology, derives from *Spectres of Marx* by Jacques Derrida (1994). However, Mark Fisher along with Simon Reynolds and Adam Harper brought back the concept in order to analyse a music genre which emerged after 2005, especially in the United Kingdom. The aforementioned genre displays a “ghostliness” as an aesthetic effect but most of all it reveals a grief for “a cultural impasse” (Mark Fisher, 2012, 1). Bioshock’s soundtrack offers an opportunity to emphasize on its hauntological aspect and its atmospheric capabilities since its quality

1. Hellenic Open University - Applied Arts, Greece, marilena.georgantzi@gmail.com

2. Democritus University of Thrace - Department of architecture engineering, Greece, polmantzou@gmail.com

has been greatly acknowledged (winner of “Best Use of Sound” from IGN in 2007).

Audio Atmospheres, the Sound of the City of Rapture

Atmospheres as much as an abstract idea as they seem; they influence us emotionally instantly before we are able to decipher them while we surrender in a multisensory experience (Böhme et al., 2014, 32). Maurice Merleau-Ponty (1964, 48) underlines this experience by saying that he perceives and senses at the same time in his whole being the overall scene and not its separate elements.

However, atmospheres are often studied as an experience connected to a material world while other media have shown the potential of creating atmospheric immaterial worlds. Questions like what is the atmosphere we sense in a room or how does a city’s atmosphere affect us limit the concept of atmosphere in a physical presence. Brennan supports the idea that our skin is an interface between us and our environment (Teresa Brennan, 2004) which anymore is not limited to physical entities. Atmospheres evolve constantly through time and can be sensed in many ways which involve abilities of seeing, orientating, moving, tasting, smelling, hearing etc. It is this paper’s intention to highlight the involvement of hearing in the perception of atmospheres in contrast to the modernity’s prioritisation of vision. Sound surrounds us, allows for the creation of immaterial spaces to be experienced and can deliver strong emotions. In addition, it has no limits and can travel no matter the obstacles since it has an innate property of diffusing. According to Elisabeth Bronfen, “As our sight diminishes, other senses - notably our faculties of hearing and of the imagination - come to be increased” (2008, 51).

Video games constitute a Dionysian condition, characteristic of the electronic era where the player is in the centre of the information, being at the same time inside and outside of the storyworld. The player is an observer and a participant, especially in a First-person shooter game like Bioshock, while the story unfolds as the immersion deepens in the “fictional” space (Michael Nitsche, 2008, 15).

Bioshock³ is an example of a thorough-detailed storyworld with a greatly authored atmosphere. A key theme (and a citizen’s obsession) is gene modification and super powers. Unexpected socioeconomic segregation gradually grew underlined by the controlled access to a number of genetic modification substances. It was not long till social rivalry would arise and with that the start of the ending of Rapture. Movement in the decayed city, anymore inhabited by few mutated residents, is guided by the narrator’s instructions, the voice of Atlas who is the man who called for the revolution against Andrew Ryan, the founder of the city. However, this audio layer is not the only one that contributes to the creation of an atmosphere. Nostalgic well known recordings of other decades are interspersed with music composed⁴ especially for the game. Ivănescu emphasises on the popularity of the tracks saying that this selection builds a strong connection to the past (Andra Ivănescu, 2019, 124). Its original symphonic score, characterised by a main theme, underlines the solidity and coherence of Bioshock’s storyworld. Showcasing aleatoric, dark ambient and music concrete styles it creates from evocative, scary and mystery to devastation moments. In addition, the score utilises a number of samples of real-world sounds, used in a different context which detaches them from their initial meaning. The juxtaposition of the

3. It received the “Best Game” award in 2007 by the British Academy of Film and Television Arts, to name one of the multiple awards.

4. Original Score by Garry Schyman and 30 licensed tracks constitute the soundtrack of Bioshock 1.

score to licensed popular jazz & blues tracks from the 30s, 40s & 50s (Django Reinhardt, Billie Holiday, etc.) is elevating the audio experience creating a rich sensory experience.

The period songs are heard through radios, phonographs and jukeboxes and while their lyrics and their overall musical tone is optimistic and happy they contrast the actual action in an ironic way as Gibbons shows in his research on the topic (William Gibbons, 2011). He focuses on the lyrics of the songs, highlighting the way they operate in a narrative way, associating the on-screen action with their content. Gibbons considers the track selection as a sarcastic comment on the story which allows for further reflection. The score constitutes an extra-diegetic sound, while the period tracks turn from being initially acousmatic (Michel Chion, 1994, 32), meaning that their source is unseen, into diegetic. Their source can be first off screen making the player to look for it. The player adopts the role of a referential listener whose, according to Leonard Meyer (1956), emotions are influenced by music in the sense of the context that the music is referring to. This listening mode is in contrast to the absolutist position which states that music perception relates only to itself, a closed loop depending on its composition. In addition, an expressionist approach highlights that a series of emotions can arise due to musical organisation while it does not assert that these feelings are connected to concepts outside the musical spectrum. The author supports that throughout the gaming experience of Bioshock, the player perceives the soundtrack as a referential listener and his or her mind evokes extra-musical images, contextualising the music while linking it to cultural references of emotional content.

Immersive Nostalgia, Haunted by the Lost Utopia

According to Greg Kasavin (2012) the concept of atmospheres in video games aims to create an immersive and uninterrupted gaming experience while leaving a positive lasting impression to the player. From a design perspective, Kengo Kuma (1997) reflects on the importance for the designer to adopt a gardener's point-of-view, who inserts in the field of intervention. From the above, it becomes apparent that the concepts of immersion and atmosphere are interrelated. However, the concept of atmosphere includes the need of immersion while an immersive state is not necessarily atmospherical. Bioshock is carefully crafted in order to maintain the player's engagement while almost ironically the protagonist is literally immersed in this undersea story. Sound, as an "event" (David Toop, 2010, 45) which constantly evolves through time, being a ghost on its own, aims to immerse the player into a state of "reflective nostalgia," a will to return to a past without processing its real aspects, which evolves to a "restorative" one, where a fruitful contemplation on it occurs (Boym Svetlana, 2001, 13). Layers of sound, including the symphonic score, the licensed tracks, sounds of dripping water and travelling whales, allow for the appearance of ghosts as "mark of the absence of a presence, an always-already absent present" (Gayatri Chakravorty Spivak 1976, xxxvi). The choice of devices for the emission of on screen sound is consistent with the storyworld, considering that action takes place in the 60s, maintaining the presence of the player. Music from phonographs, radios and jukeboxes as well as narration from audio diaries constitute disembodied voices representing ghostly existences. These technologically obsolete devices are "spectralised bodies," meaning vessels of ghosts. The haunting voices, which do not belong neither to the past nor to the present, animate the "bodies," while they are blended with other sound layers, resulting in the hauntological aesthetic effect. The dilapidated surroundings reflect the source music, which is heard in fluctuating volumes because of the protagonist's movement, evolving into a destroyed musical instrument which reveals that the whole city has turned into a "haunted house" (Sigmund Freud, 2003).

Hopes of the past are evoked repeatedly through the period track choices which reminds us of a mid-century America, the land of opportunity and the American dream. The art deco city, symbolising an era of wealth and self-promoting, half destroyed and anymore given back to the ocean, is turning gradually into a dystopia haunted by the vision of a neo-liberal utopia. Yeates (2015, 70) attributes Rapture “a lost innocence” in the name of greed for technological advancement and refers to it “as a melancholy, (a) haunted environment” reminiscent of American film noir movies. There is a continuous contrast between a past which envisioned a better future and a present which is characterised by a nostalgia for the ability of envisioning. As Mark Fisher (2012, 19) notes, capitalism can be thought of contracting and homogenising time and space through teletechnologies as well as through the city’s development via “Non-Places” (Marc Auge, 2009), creating non-places and non-time. Even though the idea of founding Rapture is an ode to objectivism, a theory deeply connected to capitalism, hauntology here reveals that “a place is stained by time” (Mark Fisher, 2012, 19). The story is deeply connected to the era that it takes place and the fictitious world offered in Bioshock is retrofuturistic in the sense that it showcases an alternate possible future of a particular historical and stylistic period. However, Jacques Derrida in the movie *Ghost Dance* (Ken McMullen, 1983) says that “to be haunted by a ghost is to remember something you’ve never lived through. For memory is the past that has never taken the form of the present” which is a comment on the ability to imagine a different world. However, Bioshock is not only about the vision of a utopia but mostly about the nostalgia for this virtuality contradicting the current absence of any vision. Different time layers, like the time that the video game takes place, the *epoque* brought by the selected tracks as well as the actual time that the video game is experienced by the player, are superimposed. There is a past inside a present as the actuality of the game within the present as the time-space of the player to extend the words of Adam Harper (2009). Irony is employed here again, since the “idealised” layer of sound, the period tracks which represent the ideal future, is “obfuscated” by its reproduction and the rest of game sounds giving it “a satirical doubt” (Adam Harper, 2009).

Conclusion

While a successful video game is not necessarily atmospheric, building an atmosphere for a virtual story world enhances the game’s power over the player. Atmospheres can spread and cannot be limited in space while it is unclear if the emitted moods characterise the objects or the subjects (Gernot Böhme, 1993, 119). Emanating sound forms space and its existence proves to be crucial when designing an impactful atmosphere. In this case, its hauntological aspect offers the possibility for the player to sense a failing utopia. Bioshock makes a comment outside the game’s world while feeding the player’s self-reflection. The soundtrack, reviving partially a previous era, evolves from feeding a restorative nostalgia to growing a critical thinking on the lost world, once idealised. The familiar as well as obsolescent technology featured in the story world reminds the player of the continuously evolving technology in everyday life and especially in the gaming field. However, the choice of familiar technologies can be considered a common practice in order to distance oneself from an alienating progress. In Rapture, radios and phonographs being the source of the diegetic music bring out this retro soothing feeling beneficial when facing an unknown future. The ephemerality of atmospheres and the audible aspect of them reinforce the meaning of these words by Derrida, who argues that being in this world after the end of history is at most existence in a world of spectres with intertwined marks of the past that will not depart (Olga Drenda, 2013, 50). In the end, what the player mourns for is not the failed future but “the disappearance of this effective virtuality” (Mark Fisher, 2012, 16).

References

- Auge, Marc. *Non-Places, Introduction to an Anthropology of Supermodernity*. 2nd ed. Verso Books, 2009.
- BioShock (version 1). Boston: Irrational Games. 2007.
- Böhme, Gernot. "Atmosphere as the Fundamental Concept of a New Aesthetics." *Thesis Eleven* 36 (113) (1993): 113-126. <https://doi.org/0.1177/072551369303600107>
- Böhme, Gernot, Eliasson, Olafur and Pallasmaa, Juhani. *Architectural Atmospheres On the Experience and Politics of Architecture*. Edited by Christian Prof. Borch. Walter de Gruyter GmbH, 2014.
- Boym, Svetlana. *The Future of Nostalgia*. New York: Basic Books, 2001.
- Brennan, Teresa. *The Transmission of Affect*. Ithaca and London: Cornell University Press, 2004.
- Bronfen, Elisabeth. "Night and the Uncanny." In *Uncanny Modernity: Cultural Theories, Modern Anxieties*, edited by Jo Collins, John, and John Jervis. Houndmills: Palgrave Macmillan, 2008.
- Chion, Michel. *Audio-Vision: Sound on Screen*. Edited and translated by Claudia Gorbman. New York: Columbia University Press, 1994.
- Derrida, Jacques. *Spectres of Marx*. Translated by Peggy Kamuf. New York: Routledge, 1994.
- Drenda, Olga. "The Alphabet of Hauntology." *CzasKultury/English* 2 (2013)
- Fisher, Mark. "What Is Hauntology?" *Film Quarterly* 66, no 1 (Fall 2012): 16-24. <https://doi.org/10.1525/fq.2012.66.1.16>
- Freud, Sigmund. *The Uncanny*. Translated by David McLintock. London: Penguin, 2003.
- Gibbons, William. "Wrap Your Troubles in Dreams: Popular Music, Narrative, and Dystopia in Bioshock." *Game Studies* 11, no 3 (December 2001)
- Harper, Adam. "Hauntology: The Past Inside The Present." *Rouge's Foam* (blog). 2009. <http://rougesfoam.blogspot.com/2009/10/hauntology-past-inside-present.html>
- Ivănescu, Andra. *Popular Music in the Nostalgia Video Game*. New York: Palgrave Mcmillan, 2009.
- Kasavin, Greg. "Creating Atmosphere in Games." *Game Developers Conference*, 2012
- Kuma, Kengo. *Digital Gardening*: Kengo Kuma. Tokyo: Kajima Institute Publishing Co, 1997.
- McMullen, Ken. *Ghost Dance*. 1983; London: McMullen, Ken, 1983.
- Merleau-Ponty, Maurice. *Sense and Non-Sense*. Translated by Hubert Dreyfus and Patricia Allen Dreyfus. Evanston: Northwestern University Press, 1964
- Meyer, Leonard B. 1956. *Emotion and Meaning in Music*. Chicago: Chicago University Press, 1956.
- Nitsche, Michael. *Video Game Spaces Image, Play and Structure in 3D Game Worlds*. London: The MIT Press Cambridge, 2008.
- Spivak, Gayatri Chakravorty. "Translator's Preface" in *Of Grammatology*, by Jacques Derrida. Baltimore: John Hopkins University press, xxvii-cxiii, 1976.

Toop, David .*Sinister Resonance: The Mediumship of the Listener*. New York: Continuum International Publishing Group, Inc., 2010.

Yeates, Robert. "Bioshock and the Uncanny: The City of Rapture as Haunted House." *Foundation* 44, no 120 (2015).

Zimmerman, Eric. "Gaming Literacy: Game Design as a Model for literacy in the Twenty-First Century," *The Video Game Theory Reader 2*, ed. Bernard Perron and Mark J. P. Wolf , New York: Routledge, 2008.

Narrative Presenting of Architectural Monuments

Atmospheres in Seibo There Below

Angeliki SIOLI¹

Abstract. Engaging a selection of narratives from the episodic novel *Seibo There Below* (2008) by László Krasznahorkai, this paper discusses how literature can enable the atmospheric presenting of architectural monuments. It examines how the reader can partake of the multilayered atmosphere of three famous places of heritage, that are spatial manifestations of different civilizations: the Athenian Acropolis (Greece), the Ise Grand Shrine (Japan) and the palace of Alhambra (Spain). The paper unpacks atmospheric descriptions related to these monuments, through the affective and emotional accounts of the novel's characters. By doing so, it allows architects, historians and theoreticians to understand significant places under a light that may even contradict canonized interpretations.

Keywords. Literature, Narratives, Monuments, Presenting Atmospheres

Presenting Atmospheres through Literature

Nobel laureate Octavio Paz, in his work *The Bow and the Lyre*, discusses the capacity of literature to present and reveal atmospheres of place. He argues that a real author amplifies the meanings and moods present in the world, rather than imposing personal feelings upon perceptions (Paz, 1956, 75-81), thus attributing to literature the capacity to communicate valuable and valid knowledge for the world we live. Philosophical voices from the field of phenomenological hermeneutics have argued along with Paz on this front. In *Truth and Method* (1960) Gadamer advocates that works of art are forms of knowledge and not mere aesthetic objects (Gadamer, 1960, 77-87). For the poetic language of literature and poetry, in particular, Heidegger points out, that it is not a conveying of pure interiority, but a sharing of a world; it is neither a subjective nor an objective phenomenon but both together (Palmer, 1969, 139).

This is why the poetic language of literature, as an intersubjective sharing that amplifies moods of the world, is a unique means to presence atmospheres of place. Through the affective and emotional accounts of a narrative's characters, the readers can partake of in-situ atmospheres. Literature has the wondrous capacity to transmit the elusive, short lived and situated elements of a place's specific atmospheres, revealing aspects of this place not necessarily included in historical or scientific descriptions. Unlike history and science that focus mainly on quantitative and measurable data, literature works with the emotional quality of a given *lived space*, meaning the space we experience in real life and to which plane geometry turns out to be blind (Griffero, 2014, 36). From an architectural perspective this promises to enrich our understanding of place, offering an alternative to established interpretations

¹. Delft University of Technology - Department of Architecture and the Built Environment, Julianalaan 134, 2628 BL, Delft, Netherlands, a.sioli@tudelft.nl

that prioritize quantitative approaches. Tonino Griffero, in his recent work *Atmospheres: Aesthetics of Emotional Space* poignantly points to the fact that “geometry is incapable of justifying the (not only metaphorical) volume of the Sunday silence or the narrowness of a living room” (2014, 36). This extradimensional and non-epistemic sense of space is tied to the experiences of the felt-body and its actions (Griffero, 2014, 36-37), elements with which literature deals *par excellence*. Thus, the presenting of spatial atmospheres that literature can provide, becomes a valuable tool in an extended and renewed study of place.

To this end, I show how literature presents the atmospheres of well-known architectural monuments, by studying three selective narratives from László Krasznahorkai’s episodic novel *Seibo There Below* (2008)². The novel depicts historical locations and buildings with verisimilitude, offering readers the possibility to experience moods of geographically and culturally diverse places of heritage, in unique and often unexpected ways. I examine how the reader can partake of the multilayered atmosphere of three famous monuments: the Athenian Acropolis in Greece (5th C. BC), the Ise Grand Shrine in Japan (7th C. AD) and the palace of Alhambra in Spain (13th C. AD). I unpack atmospheric descriptions related to these monuments, through the affective and emotional accounts of the novel’s characters.

Intense Ghastly Brilliance: Acropolis

The protagonist of “Up on the Acropolis” arrived in Athens on a hot summer day driven by his desire “to see the Acropolis one day” (Krasznahorkai, 2013, 133)³. He stepped on the path towards the monument as soon as he landed in the city, despite the locals’ warning to wait “until evening, as the sun up there will be scorching, dreadfully so.” The protagonist dismissed their advice. The sun was indeed scorching, “the noise from the traffic was practically unbearable.” But for him:

“it didn’t matter, as the only thing that mattered was that he was getting ever closer to the Acropolis [...], and that he was going to see the Temple of Nike, and he was going to see the Erechtheion, [...] the unsurpassable Parthenon—and most of all he would be up on the summit of the Acropolis.”

It is with exuberant enthusiasm that he arrived at the entrance of the archeological site, wishing to sense the atmosphere of the monument in person. His deepest desire was to understand the temples’ actual proportions, their actual size. The pictures of the Acropolis he used to study as a kid never offered “any clarity especially in regards to the proportions.” He actually believed that one could not “on the basis of [...] drawings or photographs, be sure of the dimensions, if one tried to judge the size of the *temenos*, as the Athenians called the district of their sacred buildings.” He could “never picture to himself [...] how big for instance was the Propylaea, how big was the Parthenon,” by looking at drawings and illustrations. The intention of the novel’s protagonist is thus to immerse in the monument’s *lived space* and understand dimensions and proportions. Despite the countless historical accounts discussing the proportions of the Parthenon and the surrounding temples the protagonist insists on the experience of *lived space* to reveal the impression these proportions have on him.

2. I first heard about the novel through: Lending, Mari. “Fabrics of Reality: Art and Architecture in László Krasznahorkai.” In *Reading Architecture: Literary Imagination and Architectural Experience*, edited by Angeliki Sioli and Y. Jung, 49-60, New York: Routledge, 2018.

3. Unless otherwise indicated all the quotes in this section come from: László, Krasznahorkai, *Seibo There Below*, trans. by Otttilie Mulzet (New York: New Directions Books, 2013), 127-145.

The literary account instead presents an atmosphere emerging from the monument's characteristic materiality on a hot Athenian summer day. It is the atmosphere that countless tourists experience every summer. A few steps into the path leading up the Acropolis and the protagonist immediately realized that he could not bear the bright white light reflected on the white marble of the monument. He looked down but this did not help him either. The paving, "made of the same white marble as the rest of the *temenos*, completely blinded him." The narrative describes the protagonist walking towards the Parthenon, but without really being able to see. He only knew:

"that there on the left rose the so-called Pinacotheca of the Propylaea, and on the right was the garrison building, then high above in the Temple of Athena Nike, with its four wondrous columns; but he only knew this, he couldn't see anything, he just went upward, squinting."

The narrative evocatively communicates the pain in the protagonist's eyes, the heat from the sun on his face, his dry mouth in need of fresh water, the emotional frustration in not being able to fully take in what he had longed for, as "the entire *temenos* was built on a colossal snow-white limestone cliff." The presenting of an atmosphere very real, but so very unexpected, emerges strongly. With the "sun right above his head," and "no kind of soothing corner, niche, roof or recess [...] anywhere," the protagonist left the monument defeated. What:

"completely astounded him, the grave import of which he was not at all aware, was the effect of the sunlight on the limestone, he was not prepared for this intense, ghastly brilliance, nor could he have been, and why, what kind of guidebook, what kind of art-historical treatise relates such information."

Due to a "ridiculous, commonplace, ordinary detail," his trip to Athens "turned out to be an ignominious failure." But even now, after this lurid experience, he would still refuse to visit the monument with sunglasses, "because the Acropolis in sunglasses has nothing to do with the Acropolis."

Sweet Fragrance of Hinoki Trees: Ise Shrine

The overwhelming disappointment experienced by the protagonist on the Acropolis is a different kind of disappointment than the one experienced by the visitors of the Ise Shrine. Two friends "take part in the 71st rebuilding of the Ise Shrine, in the ceremony known as *Mimosa-Hajime-sai*" (Krasznahorkai, 2013, 374)⁴. The ceremony consists of the ritualistic cutting of two hinoki trees, the wood from which will be used for the new shrines. The two friends wished to grasp the atmosphere of this ceremony, as it is connected with the very essence of the Shinto religion. "According to legend [...] the Emperor Temmu in the seventh century, [...] commanded [...] that every twenty years the entire structure of shrines in both Naikū and Gekū [...] would be rebuilt again and again." The new buildings could not be copies of the old buildings. They had to be "the *same* buildings," "and everything - every beam, piece of masonry, dowel, corbel - really, with a hair's breadth accuracy" had to be rebuilt," so that the buildings remain "in the true vividness of creation, in the realm of a truly eternal present." Mesmerized by such powerful tradition, the two friends arrived at the monument dreaming of encountering a solemn, metaphysical atmosphere.

4. *Ibid.*, 373-421.

Instead, they found themselves in front of a big stage, where the empress and the priest led a ceremony, completely devoid of solemnity and mysticism, up until the moment that the woodcutters appeared. The two friends:

“both felt that [...] up until the point when the woodcutters appeared, it was simply impossible to take this entire Misoma-Hajime-sai seriously, [...] that it was the complete absence of sacredness [...] taking place on the stage, because the whole thing was so untrue, and there was no credibility to anything, not one movement, not a single gesture of the chief priest, [...] betrayed anything but [...] sheer exertion, [...] nothing was true, not true, not sincere, not open, and not natural.”

This lack of authenticity in the air, the tension felt by protagonists and guests, and so strongly communicated to the reader, dissolves the moment that “the echoing axes blows” fill the air. The sound from the absolutely calibrated rhythmical movements of the specially trained woodworkers created an atmosphere so overpowering that “the entire gathering watched the operation for close to two hours with bated breath.” The literary description presences the strength of this new atmosphere very clearly, and is a reminder of Heidegger’s understanding on moods as *attunements* that are directly shared and beyond the control of any one person, drawing in each new participant like a raindrop into a hurricane (Heidegger, 1995, 66-67).

After the impressive cutting of the two trees, which fell in the exactly predetermined location, the two friends were further drawn into the encompassing atmosphere because of “the astonishingly powerful fragrance” that was everywhere. The “particular fragrance of the two felled hinoki trees practically burst onto the section of the forest like a cloud,” and “it drew them in.” And they felt happy that they were “not experiencing disappointment again, and they would not return home beaten down, although that really happened too.” It is with this elevated feeling and the evocative presencing of a mystical, echoing, sonorous and fresh atmosphere that the reader of the story leaves the Ise Shrine and moves to the next pages of the novel.

Marble-lace Intangibility: Alhambra

The third story from *Seibo There Below* presences the atmosphere of Alhambra, a monument that has excited the imagination of many writers, musicians, and filmmakers in recent history. Strictly, historical accounts classify the monument as a palace and a fortress. Though the protagonist of the story finds it difficult to classify the wondrous architectural ensemble as such. His “jaw drops” when he enters the monument, “because something like this, but like *this*, [...] he has really, but really never even seen, this [...] surpasses anyone’s imagination” (Krasznahorkai, 2013, 296)⁵. The amazement that overwhelms him translates into a feeling of disorientation. The architecture does not guide him in navigating the place. He “proceeds in utter confusion,” heading hesitant towards the Cuarto Dorado courtyard, where he stands felling lost amidst the “breathhtakingly harmonious magnificence” of the Arab architecture. Stepping accidentally in the Mirados de la Daxara he feels elevated by “the rooms’ stalactites swimming in gold,” and he “grows blinded from the radiance of the vaulted fenestration as the light streams from without.” Finding himself into the Baths he immerses into “the marble-lace intangibility descending ethereally onto the slender columns.”

5. *Ibid.*, 289-311.

As the readers take in the wonderous atmospheres of the different rooms, the colors, the sounds and the astonishing hieroglyphs, they soon discover, along with the protagonist, that the “Alhambra does not recognize within itself the concept of a right direction.” Indeed, the more time the protagonist spends wondering “from the Patio de los Arrayanes to the Sala de la Barca, the Patio de Comares to the Patio de los Leones, the Sala de los Hermanas to the Mirador de las Daxara,” the more he realizes that in the Alhambra there are no paths at all:

“every single room and every single courtyard exist for its own sake [...] every courtyard and room just represents itself, within its own self, and at the same time within its own self, represents the whole, the entirety of the Alhambra.”

The narrative moves on to also present also the atmosphere the monument communicates from the outside. The exterior walls of the Alhambra “originally whitewashed with lime,” were “in a military sense [...] not able of defending anything.” Their presence seems to bewilder even the scholars who have studied and written about them. The narrative humorously questions the official scholarship, “the entirely serious monograph” by professor Grabar (“an instructor at both the University of Michigan and Harvard”), who wrote “how the story of the Alhambra is in fact nothing but the story of a great conspiracy.” Krasznahorkai opposes the historical analysis and vouches for the embodied perception prevalent in the atmosphere of the monument itself: “that the Alhambra—already far beyond its really being neither fortress nor palace nor private residence—stands there with no explanation, it is wholly extant.” The narrative, presenting an atmosphere of utmost and inexplicably overpowering wonderment, comes to an end with the conclusion that the “Alhambra offers everyone the understanding that it will never be understood.”

Conclusion

The three narratives present unique atmospheric conditions of the monuments' *lived space*, as experienced by their protagonists. The atmospheres of these monuments even contradict established historical views, which tend to create specific expectations for these monuments' understanding. The proportions of the Acropolis, cannot be communicated through drawings, photographs and the traditional means of architectural representation. The protagonist, although unable to fully enjoy the place, still senses the brilliance of its materiality. The Ise Shrine feels authentic and real because of the fleeting elements of axe sounds and hinoki fragrance, and not because of the Shinto tradition associated with it. The Alhambra is sensed neither as a fortress nor as a palace, but as a mesmerizing conglomeration of ethereally magnificent rooms and courtyards.

This literary presenting suggests an architectural approach towards place that prioritizes embodied and emotional interpretations. The power of literature to *amplify the meanings and moods present in the world* emerges from the narratives by László Krasznahorkai in the most convincing way. Literature becomes a way to experience, presence, and study the multiple, real, unabbreviated atmospheres of historical monuments. It exhibits how intellectual experiences and expectations crumble before our sensory and empirical understandings of a place in-situ.

References

Gadamer, Hans-George. *Truth and Method*. Translated by Joel Weinsheimer and Donald G. Marshall. London; New York: Continuum, 2006.

Griffero Tonino, *Atmospheres: Aesthetics of Emotional Spaces*. Translated by Sarah de Sanctis. London; New York: Routledge, 2010.

Heidegger, Martin. *The Fundamental Concepts of Metaphysics: World, Finitude, Solitude*. Translated by W. McNeill and M. Walker. Bloomington: Indiana University Press, 1995.

Krasznahorkai, László. *Seibo There Below*. Translated by Otttilie Mulzet. New York: New Directions Books, 2013.

Palmer, Richard E. *Hermeneutics, Interpretation Theory in Schleiermacher, Dilthey, Heidegger, and Gadamer*. Evanston: Northwest University Press, 1969.

Paz, Octavio. *The Bow and the Lyre: The Poem, the Poetic Revolution, Poetry and History*. Translated by Ruth L.C. Simms. Austin: University of Texas Press, 1973.

Traces of Invisibility: Readings From Artistic Records

Abstract. This research presents the concept of *ambiance* with its roots in user's or beholder's point of view. We believe that in this relation with inhabitant perception, *ambiance* gathers visible space perception together with layers of invisible space interpretation. Therefore, we introduce Maurice Merleau-Ponty's idea from *L'Œil et l'Esprit* (1960) that argues the importance of art experimentation as a form to understand the relation between visible and invisible, and we advocate that art production and art interpretation bring up new space readings that enrich space comprehension beyond the visible and the Cartesian thinking. This paper presents two examples, through a series of works of art: Cartuxa Monastery, Felipe Terzi and Giovanni Casale (1587-1598) and Miguel Bombarda Panoptic Hospital, José Maria Nepomuceno (1892-1896).

Maria Rita PAIS¹,
Luís SANTIAGO BAPTISTA²

Keywords. Art and Architecture, Ambiances, Invisible Space, Spatial Records

Introduction

“Meaning is invisible, but the invisible is not the contradictory of the visible: the visible itself has an invisible inner framework (membrane), and the in-visible is the secret counterpart of the visible. [...] The sensible, the visible, must be for me the occasion to say what nothingness is. Nothingness is nothing more (nor less) than the invisible. Start from an analysis of the total philosophical error which is to think that the visible is an objective presence (or the idea of this presence) (visual picture).” (Merleau-Ponty, 1968)

What is the invisible in architecture? What relationship does it establish with the visible? What motivates, determines and conditions our experience of visibility and invisibility? Maurice Merleau-Ponty elaborated between 1959 and 1960, in his latest work *Le Visible et l'Invisible*, a work he left incomplete and would be posthumously published, about the relationship between the visible and the invisible. For Merleau-Ponty, the task of philosophy is to question the founding distinction between body and mind, establishing the inseparable links between perception and reflection. If the subject of perception is inseparable from the perceived thing, what he calls the “enigma” of the “body” as both “seer” and “visible,” then the invisible cannot be merely what is not visible or what escapes visibility regimes, but their own condition of possibility. In his latest works, he assumes the problematic but inescapable dimension of this relationship, a fundamental non-coincidence between the sensitive experience and the conceptual understanding sought in what he defines as “silence of

1. Lusofona University of Humanities and Technology - LEAU Research Group, Portugal, mariaritapais@gmail.com

2. Lusofona University of Humanities and Technology - LEAU Research Group, Portugal, lsantiagobaptista@gmail.com

language,” implying the invisible manifestations of “latent” or “hidden” that support and structure the visible. In 1960, he published the short essay *L’Oeil et l’Esprit* where he affirms the centrality of the experience of art in this “intertwining” between the visible and the invisible. Here, Merleau-Ponty begins by distinguishing art from science, art relates to the lived and living world, the body and existence, while science takes the world as an object of knowledge “dissociated” from the existing subject, in order to identify laws beyond phenomena. In *L’Oeil et l’Esprit*, Merleau-Ponty gives the example of the water, a viscous and shiny element, about which we cannot say that it is in space: it is not elsewhere, but it is also not in the pool. It inhabits it, materializes there, but it is not contained there, and, if we look up at the cypress screen where the weave of reflections plays, we cannot dispute that the water also visits it, or at least sends it there its active and expressive essence. It is this internal animation, this irradiation of the visible that the painter seeks under the names of depth, space and color (Merleau-Ponty 1960, 37-38).

What interests us here is this structural relationship that links the visible to the invisible in the experience of the world, a relationship in which memory and creation have a fundamental role in the revelation of invisibility in the visible itself. The speculation is based on two case studies selected from their artistic representations, producing analytical and critical readings that open up the works. These examples of invisibility in architecture will be understood through the interpretation of its records in film, photography, drawing and illustration. The following examples explore, through art interpretation, some invisible reading possibilities that compose their space ambiance, a more complete and intricate space compression, that go beyond the visual, material and Cartesian comprehension.

Cartuxa Monastery, 1598



Figure 1. Covers Deserto/Nuvem, Francisco Sousa Lobo, 2017

The Stay

In 1960, after 126 years of profane life following the *Extinction of Religious Orders*, Vasco Maria, Count of Vilalva and Cartuxa Monastery and estate heir, sends a messenger to *La Grande Chartreuse* to invite the original inhabitants to return to their home. This messenger carried a book in his hand, a detailed building restoration record, made by *Portuguese General Directorate of National Monuments*. The building was

designed at the end of the 16th century by Giovanni Casale and Filippo Terzi to produce an invisible world of closure. This beautiful book documents the renovation, presenting in parallel and from the same angle, photographs of the physical state before (1948) and after (1951) the intervention. It emphasizes the attempt to imitate and replace the original layout. This important historical record witnesses the incredible history of Cartuxa Monastery, a history that somehow ended with the recent departure of the last monks.

Some, like Jack Kerouac, try to live by looking for something outside of themselves, *On The Road* (1957), while others, like Georges Rodenbach, look for it inside, in *Le Règne du Silence* (1891). Through these two ways of life, we find many of the great journeys we know. Cartuxa is a journey and resists to an existence in the continuous and connected world. Cartuxa is like a silent capsule of pure existence. Its walls carefully draw this silence and prepare the body for the journey into your skin, into your soul.

Francisco Sousa Lobo, in his double book in comics, with two covers and two titles, presents the duality between concept and experience, between the order spatial rule and his personal experience in the monastery. The experience of staying inside Cartuxa reflects exactly his interior trip. It is a personal and dichotomous reflection that wanders between doubts about his own religiosity and his worldly existence: "First there is the desert, or the Alentejo; then the walls of the monastery, then the walls of each cell; and then the skin of each cartridge. Inside the last, only god knows what's going on - inside the heart of each Carthusian." The duplicity of the author's response is surprising, the temporal and mundane versus the spatial and metaphysical. The dilemmas irresolution is transferred to the conceptual and material construction of the book, in two parts that are inseparable, but opposed, without crossing. The open plan of the double page versus the narrative sequence of the squares, self-reflection confronts dialogue in two inseparable books. As he tells us, "Cartuxa is not visited, it is Cartuxa who visits us."

Let us return to Rodenbach, to analyze Daniel Blaufuks' *Prece Geral* (2015), a work carried out on another rare visit and stay at Cartuxa Monastery: "*Les chambres, qu'on croirait d'inanimés décors, - Apparat de silence aux étoffes inertes - Ont cependant une âme, une vie aussi certes [...] Les chambres vraiment sont de vieilles gens Sachant des secrets, sachant des histoires, - Ah! Quels confidentes toujours indulgents! - Qu'elles ont cachés dans les vitres noires, Qu'elles ont cachés au fond des miroirs Où leur chute lente est encore en fuite Et se continue à travers les soirs, Chute de secrets dont nul ne s'ébruite!*" Blaufuks captures exactly the expression of these mute inhabitants, an intellectual and elevated sense of suspended time, through a spatial displacement that spells out a greater truth by concentrating on some scarce objects that inhabit each space. There is also an explicitness of some kind of ritual, not merely sacred, but also profane, showing the time flow in space of the life inside Cartuxa. The artist's vision is like a close-up of a secret camera that questions Carthusian mundane side of the spiritual experience. Blaufuks presents the exact moment of a framework, in which we can see the real, everyday and familiar things in a certain way, but which clearly involve us, due to its almost macro-photographic proximity.

Blaufuks and Sousa Lobo present experiences interiorizing the mystery of this closed and circumscribed space. Because they are faithful images to the experience of reality, these representations transcend the real. They do not represent reality as it is. Rather, it is the reality that is observed here according to the fidelity of its interpretations, crossed by their own experiences. Therefore, these representations cannot

be understood only as records of an external reality, but as constructions of their inner journeys of personal discovery and of capturing the mystery of this sacred place.

Miguel Bombarda Panopticum, 1896



Figure 2. João César Monteiro, Still
Recollections of the Yellow House,
1989

Observer and Observed

Five days before *April Revolution*, João César Monteiro published in *Cinéfilo* his interview with António Reis on the occasion of *Jaime* premiere. Between documentary and fiction, the film construes with great intensity the life and work of Jaime Fernandes, an artist interned in the Security Pavilion at Miguel Bombarda Hospital, since 1938. If the empathy between the two filmmakers is evident - until then they did not know each other -, the interview reveals the intentions of Reis in approaching the artist's life, who he had never known. In the film, Jaime returns to the places he inhabited, mainly the Security Pavilion and his childhood village in *Beira*, which intersect with the artist's works. The filmic environments are activated by the chromatic treatment of images and work of sound. Later, César Monteiro will film in the same building the final scenes of his award-winning film *Recollections of the Yellow House* (1989), the first work of his famous trilogy around his alter ego João de Deus. But, taking into account what interests us here, how do Reis and César Monteiro interpret the space of the Security Pavilion?

The Security Pavilion is a pure panopticon that was built in 1896 at Rilhafoles Hospital which had occupied since 1848 an old convent to implement the country's first psychiatric hospital. In 1892, the doctor and alienist Miguel Bombarda had assumed the direction of the institution, becoming responsible for the construction of the Security Pavilion, a project designed by architect José Maria Nepomuceno. The panopticon disciplinary model was a proposal by reformist thinker Jeremy Bentham in 1791, a system of behavioral surveillance and body control. In Rilhafoles it is not known whether this typology was adopted by proposal of the doctor or the architect. A convinced republican, Miguel Bombarda would suffer an attempt of assassination by a patient in his office in Rilhafoles, tragically dying few days after at S. José Hospital on October 3, 1910, two days before the Republican Revolution. The Hospital adopted his name then on.

The Security Pavilion is the main space in the first part of Reis' film. Filmed from the cell, in the position that would be Jaime's, we observe the open courtyard with the presence of human figures in sepia tones, as in old photographs. Framed by the door circle dark background, it is from inside that Jaime's vision is constituted. Poetry on the threshold of abstraction captures characters and shadows, sometimes indistinguishable from one another, wandering through the whiteness of the endless circular

wall. The choreography melancholic beauty, with the slow movement of the camera and without any sound, captures the courtyard as if inhabited by ghosts, filmed as “frieze sculptures,” in the words of Reis. Jaime is reflected in his fellows, in their daily gestures, bodies in idle suspension or infinite waiting. Some inmates look out from the entrance closed gate. In the center of the courtyard, where briefly there was a small watchtower - only registered in a photograph published in 1899 - is now a fountain, filmed in black & white shot ascending to the sky. Color enters in an upper courtyard panoramic view, assuming the position of an outside observer, followed by an almost blind exterior building wall and several interior spaces, such as the refectory, collective dormitory and bathroom, filmed with a sense of intrusion with a low-pitched camera. For Reis, panopticon space is a shadow theatre punctuated by sublimated men as Jaime.

César Monteiro himself returns to the Security Pavilion a decade and a half later in his film *Recollections of the Yellow House*. In the final scene, the filmmaker gives us a full and purposeful interpretation of the panoptic space, assuming an opposite perspective to that presented by Reis. A continuous 360° plane filmed from the center introduces the point of view of panopticon invisible observer, where the surveillance watchtower was positioned, following the accelerating course of João de Deus circular turn. The idea of circularity is manifested in the coincidence of the place of departure and arrival, a movement of inertia, a time as the character says to “think.” The interiorization of the simulated control device is João de Deus path to freedom, his proof of sanity before the disciplinary system of exclusion. The entrance gate opens to him, who leaves the panopticon to fulfil the “go and give them work” intent, reflected in João de Deus’ final analogy as Murnau’s vampire Nosferatu rising in old Lisbon.

Conclusion

In all of these authors’ interpretations, we can find political, social and psychological readings of territorial and architectural conditions. The subjective potential of space is presented in this paper through the creative interpretations of each artist. Merleau-Ponty claims the relevance of the freedom of the artistic approach. We try here through reading of such approaches to understand the constitution of a space at the border between the conscious, sub-conscious and unconscious that allows just the unfolding of time. Following Merleau-Ponty, ambiance is not just the visible but the inscription of invisibility in the real and material. Through the artist’s work, the invisible becomes visible, but this invisible is an immanent invisible, interior to the artist himself. As if the pictorial world to which he gave birth were the manifestation of his “inner world,” a world made up of the impact left in him by the encounter with the visible, with the sensitive world.

In the case of Cartuxa Monastery, we understand the solitude atmosphere as we were living in it, not because we have the visual framework, but because we understood artists/visitors’ sensibility to that sensation. The freedom of Francisco Sousa Lobo and Daniel Blaufuks artistic experience and readings represent here the possibility of transgression of the visible. The same happens through João César Monteiro endless circular space reading and through António Reis bodies in idle suspension or infinite waiting. In this sense, space and ambiances do follow more than the current architectural rules of understanding, asking for a more penetrating relation between conception and use, between author and inhabitant.

Artistic readings bring another layer regarding the user experience of places and contribute to the rewriting of our understanding of space and architecture. In this sense, ambiance adds understanding to the existence of the architectural object.

References

- Borden, Iain; Jane Rendell, ed. *InterSections: Architectural Histories and Critical Theories*. London: Routledge. 2000.
- Colomina, Beatriz. *Privacy and Publicity. Modern Architecture as Mass Media*. Cambridge, Massachusetts: MIT Press. 1996.
- Davidson, Cynthia, ed. "Curating Architecture." *Log - Curating Architecture* (20). 2010.
- Gadanhó, Pedro; Oliveira, Susana, eds. 2013. *Once Upon a Place*. Lisbon: Caleidoscópico.
- Leach, Neil, ed. *Rethinking Architecture: a Reader in Cultural Theory*. London/New York: Routledge. 1997.
- Lefebvre, Henri. *The Production of Space*. Vitoria: Anthropos. 1974.
- Merleau-Ponty, Maurice. *Le Visible et l'Invisible*, Claude Leffort (Ed.), Alphonso Lingis (Trad.), Northwestern University studies in Phenomenology Existential Philosophy, 1968 (1959). 1959.
- Merleau-Ponty, Maurice. *L'œil et l'esprit*. Paris: Gallimard (1960). 1964.
- Pais, Maria Rita; Santiago Baptista, Luís ed. *Viagem ao Invisível*. Lisboa: Purga. 2019.
- Rendell, Jane. *Site-writing: The Architecture of Art Criticism*. London: I.B. Tauris. 2011.
- Traganou, Jilly; Miodrag Mitrasinovic, ed. *Travel, Space, Architecture*. Burlington, USA / Farnham, England: Ashgate. 2009.

Urban Atmospheres in Pandemic Times

Between Science Fiction and Reality

Fatma MRAD¹

Abstract. March 2020, I find myself in confinement at home feeling a myriad of intense emotions with the impression of living the scenario of the film *Contagion* by Steven Soderbergh (2011). I am thinking about this anticipation thriller that describes - or predicts? - similar atmospheres to those that the world is currently going through. The aim of my proposal is to explore some links between the filmic atmospheres of epidemic horror films and urban atmospheres of our daily lives through the emotions they arouse. Through this example that we will analyze, we will discuss whether it is possible to consider science fiction cinema as an investigative tool on the way in which contemporary environmental and social changes affect the sensitive world, its atmospheres and the way of living them.

Keywords. Urban Atmospheres, Filmic Atmospheres, Epidemic Horror Films, Emotions

The Transformation of the Sensitive Experience of the City

The Covid-19 health crisis that has recently hit the world was qualified as the worst crisis to which the humanity was confronted since the Second World War. Considered as common enemies of humanity, epidemics are disrupting our relationship with the world. Within a few weeks, our lifestyles have been completely jostled, half of the world's population has been confined.

The most disturbing aspect of this extraordinary event was the fact that our awareness was brutally heightened. No anticipation was planned beforehand, the unpredictable blew up in our faces and the world was disarmed in the face of its threat. And yet, films, which never cease to feed our imagination, have already warned us, offering us the spectacle of the speed of the spread of the contagion, the geographical extent and the impact that an epidemic can cause on our relationship with the world.

Priscilla Wald², a specialist in contagion studies, speaks of "epidemic horror films," referring to a film corpus regrouping films that describe an epidemic process of contagion; in her book *Contagious: Cultures, Carriers, and the Outbreak Narrative*, she postulates that these films would allow us to better understand the interconnectedness of our world.

1. UMR 1563 AAU - CRESSON, France, mrad20fatma@gmail.com & mrad.f@grenoble.archi.fr

2. Literary critic and professor at Duke University. In her book *Contagious: Cultures, Carriers, and the Outbreak Narrative* (2008), she explores the methods used to describe disease by highlighting the social impact of disease through the creation of fictional narratives.

Hugo Clémot³, also a specialist in contagion studies, postulates in his article “*Une lecture des films d’horreur épidémique*” that these films would lead to a form of skepticism about the world.

Indeed, by opening up infinite possibilities of existence, they liberate and nourish our imaginations but also our perception of our environment. By confronting us with our reality, filmmakers “like poets, seek more to restore presences of the world than to create representations of it”⁴.

On the other hand, the diegetic cities in epidemic horror films provide the built environment and spatial organization that reflect the dysfunction of societies that have been affected by a virus. The work of the filmmaker reveals an unprecedented atmospheric potential. It transforms cities that were once home to ordinary and rather peaceful lives into worrisome, even threatening, cities.

With the aim of highlighting the potential of filmic atmospheres to report and reveal new aspects of our urban atmospheres, the objective of this article is to attempt a reflection on the transformation of urban space that this coronavirus epidemic has induced through a comparative descriptive approach between the change in our daily lives and the atmosphere that epidemic horror films portray. To this end, we propose an analysis of some scenes from Steven Soderbergh’s film *Contagion* (2011) using ambiances as a method of investigation. The aim here is not to provide a film critique but to weave connections between fiction and reality in order to contribute to the reflection on how contemporary environmental and societal changes affect the sensitive world, its ambiances and the way they are experienced.

How do epidemic horror films contribute to our apprehension of the world in the event of a health crisis? And what can they teach us about our relationship to the city? Can we talk about the influence of our emotions and feelings in this report? In what way does the quality of our presence in the world and especially in our cities depend on our emotions?

These films project disturbing possible scenarios using plausible aesthetic representations of a world affected by phenomena beyond our understanding.

If we consider Cavell’s thesis, in his book *Pursuits of Happiness - The Hollywood Comedy of Remarriage*, which states that the reason we adhere to a film is that it has something to teach us about our world and the order of things, we can be interested in the contribution of epidemic horror films as a tool for reflecting on our urban condition in times of crisis.

To argue in favor of this thesis, we will study some sequences from the film *Contagion*, which is particularly remarkable for the disturbing similarity of its actions to the recent events we have been through, namely the health crisis created by the Covid-19 virus.

This feature film describes the spread of a pandemic caused by a virus called MEV-1, which appeared first in China by contaminating a pig with a bat virus followed by genetic recombination. Its mode of transmission is close to that of coronavirus and influenza viruses responsible for severe acute respiratory syndrome (SARS).

Let’s go back to one of the highlights of the film: the opening scene.

3. Professor of philosophy at the University of Tours, associated with the Centre for Contemporary Philosophy at the Sorbonne, specialist in film philosophy and author of several articles on the cinema of horror.

4. Maury, 2011, p. abstract.

First of all, we can see that the narrative scheme of the film as well as the question of the spread of the virus and its mode of contagion seem to be exposed from the first scene. Indeed, the narrative scheme follows a chronological breakdown by day of contagion. We are directly in the second day of the spread of the virus, the scene begins with the coughing sound of a young woman from Minnesota returning home from Chicago airport, she is back from a business trip in Hong Kong. A close-up on the bowl of dried fruit that the woman has touched, then another on her credit card that the waitress retrieves to make the payment gives us a small glimpse on the spread of the contagion which, obviously, can be by fomite⁵.

This scene is directly followed by sequences that fragment the filmic space by showing scenes of the first affected people all over the world: Hong Kong, London, Minneapolis, Tokyo. We will return later to the scene that explains the transmission of the virus in these cities.

This fragmented aesthetics specific to films allows us to travel from one country affected by the virus to another. This sequence is striking in this respect, since its function is to introduce the chain of transmission and to set the spatio-temporal context of the fiction. The property of the medium to articulate several spatialities through editing and teleporting us from one place to another shows the causal relationship between the events.

Another scene sheds light on how the virus has spread in the cities of different countries. Indeed, a WHO⁶ epidemiologist suspecting the American to be patient zero returns on a surveillance video filming the woman in a casino in Hong Kong, which allows us to link the first affected cases. The American woman participating in a poker game contaminates the Japanese player next to her, who travels to Beijing a few days later, blowing into his dice before he throws them on the table. Then, on her way to the bar for a cocktail, she calls an old friend and offers to meet him in Chicago since she will have a stopover there before returning home to Minneapolis. While picking up cocktails at the bar, she forgets her phone and an Ukrainian woman, who went to London a few days later, notices it and hands it to her. The waiter clearing her glass will be the first Chinese she has contaminated.

This scene films the microscopic, i.e. the virus which is invisible to the naked eye, the sequence here reflects the contagion. By placing the camera as close as possible to the individuals, this scene emphasizes the fact that our most insignificant gestures can be threatening. It seems that the film has the capacity to let the most banal movements draw attention to them and allow them to offer themselves as a spectacle to us. Moreover, wouldn't the images of this last scene lead us to think that "the interactions that make us sick are also those that constitute us as a community"?⁷

In another scene, Steven Soderbergh shows us a Minneapolis emptied of its inhabitants and means of transport; the streets no longer resonate with the conversations of pedestrians; the roads are deserted. An almost apocalyptic atmosphere resulting from an unprecedented health crisis. From then on, we can see that a health catastrophe creates new relationships between human beings and their environment. Indeed,

5. A fomite is any inanimate object (also called passive vector) that, when contaminated with or exposed to infectious agents (such as pathogenic bacteria, viruses or fungi), can transfer disease to a new host.

<https://en.wikipedia.org/wiki/Fomite>

6. World Health Organization.

7. Wald, 2008, p. 2.

these films explore the world we have in front of us and make us see that the city, which constitutes our social environment and place of interactions, is fully constructed when its users make it exist through a logic of appropriation of urban space by actions, the simplest everyday gestures, which normally go unnoticed, and which would manifest the harmony of what Kracauer calls, in his book *Theory of film: the redemption of physical reality*, “the flow of life.” From this, we deduce that “the place is based on the idea of an active subject who must constantly weave the complex links that give him his identity while defining his relationship to his environment”⁸.

In fact, during the Covid-19 health crisis that we are experiencing, our daily life has become punctuated by new notions that were foreign to us: confinement, barrier gestures, the use of masks, physical distancing, quarantine. By isolating the individual and cutting him off from his world, the only possible means of social interaction is now through a screen.

In view of the new circumstances, the typical behaviors of urban users have changed and harmony has broken down. Inhabitants who used to take over the terraces of bars and restaurants, enjoying the good weather in society with serene carelessness, are now suspicious of each other and content to stock up on food and go home. The urban experience is lived in a completely different way, being outside, in the city has become synonymous with risk; the city becomes an unknown and enigmatic space. Our relationship to the world has literally been turned upside down.

In reality, urban materiality has remained unchanged, yet its atmosphere has been transformed, a heavy, even claustrophobic atmosphere hovers over the cities. This reflection highlights the fact that urban space is conceived through forms but also through typical behaviors that have a considerable effect on the atmosphere. The urban atmosphere during these crises pushes us to reexamine the balance of the collective life of an urban population. Thus, we can postulate that health crises affect the sensitive world, its ambiances and the way of living them.

It can be seen that the narrative pattern is very similar to the course of events linked to the Covid-19 pandemic, firstly by the mode of contagion of the virus, which is respiratory and by fomite, and secondly by the crisis management which had a considerable impact on the general atmosphere in the cities affected by the virus.

Arriving on day eighteen, after the Emergency Operations Center drew up the crisis plan, the authorities decided to close the airports, mobilize the National Guards to block the roads, stop public transportation and close the Board of Trade and schools. The patients have been isolated and those who may have been in contact with the virus were quarantined.

We watch the urban wanderings of Mitch who, after losing his wife and stepson to the virus, is now thinking only of his daughter’s survival. Fear and despair are written on his face as well as on the urban space that he crosses.

The horror reaches its peak when the fear of the inhabitants turns into panic. They rush to banks, gas stations, food stores and pharmacies. Thus, little by little, the long queues in front of the shops turn into crowds of inhabitants who lose patience and turn to violence. They jostle each other, break up, vandalize the shops to get supplies and set fire to the streets to show their dissatisfaction with the state’s policy in dealing with the crisis.

8. Berdoulay & Entrikin, 1998, p. 118.

These images convey the fear and anguish of city dwellers in the face of the unknown, the feeling conveyed is similar that of having to deal with a war against an invisible enemy.

Appalled by the animosity of the people and by this collective paranoia, Mitch abandons the idea of making food supplies and prefers to go back home. On his way, he drives through the city and shows us the anarchy that this health crisis has created.

Each fragment of the city that the film brings to our attention exposes the chaos that society is experiencing. Streets, successions of buildings, squares, commercial buildings: bits of the city reflect an apocalyptic atmosphere where time seems petrified. The urban space presented to the spectator is fully productive of meaning and emotions, it is a reflection of his anguished and disoriented society. The representation of the city as a place of perdition reinforces the horror and the dramatic effect of the situation. This scene highlights the influence of the emotional relationship to the urban space on the perception and representation of the city by underlining the porosity of human beings to their urban space. Thus, by emphasizing the interactions between body, emotions and environment, the epidemic horror films expose the way in which the atmosphere transforms us and how we transform it individually and collectively.

The different aesthetic features of this scene of urban chaos come together to express the horror of the epidemic scenario, bringing to a climax the anxieties of a society whose emblem is the city. As the matrix of the narrative, the film city offers an image of what awaits the city dweller in his confrontation with the world during a pandemic by sending back to him the image of his own behavior in the city. In short, such a health catastrophe reveals to us the importance of the active part played by the users of the urban environment, which strongly affects the sensitive world.

In sum, the use of fiction to illustrate experiences of global health crises exposes our human need for security and makes us see the invisible: the fragility of our mastery of these phenomena as well as that of our daily safety and comfort.

At the crossroads where filmic and real-life atmospheres meet, this analysis highlights how sensitive the urban environment is and how it can be reactive to societal transformations. That is to say that our projections in the city where we evolve are in close connection with our emotions and feelings that allow us to qualify the quality of the atmosphere of the place.

Thanks to the richness of its potential, the film medium makes us attentive to the sensitive world and the quality of our presence in the world. Epidemic horror films allow us to spot the sensitive characters of the city and the way in which it affects us and the way in which we affect it in return through our emotions and our actions/ behavior.

Such horror films reveal the unprecedented ambient factors in the transformation of the sensitive experience of urban space.

Finally, can we say that the city is defined not only by its urban forms but also by the movements that animate it, which themselves translate the emotions of its users? And finally, could the city really have fixed characteristics if it is constantly metamorphosing according to the experience of its users?

What can we conclude from this, except that the virus is perhaps not the most dangerous enemy? Isn't it a transformation of the atmosphere that is in itself monstrous?

References

Berdoulay, Vincent & Entrikin, J. Nicholas. *Lieu et sujet: Perspectives théoriques*. In: L'espace géographique. Tome 27. n° 2. pp 111-121. 1998.

Clémot, Hugo. *Une lecture des films d'horreur épidémique*. In: Tracés: Revue de Sciences humaines. Tome 21. pp 167-184. 2011.

Kracauer, Siegfried. *Theory of Film: The Redemption of Physical Reality*. Princeton University Press. 488 p. 1998.

Maury, Corinne. *Habiter le monde: Éloge du poétique dans le cinéma du réel*, Exhibitions International. 190 p. 2011.

Wald, Priscilla. *Contagious: Cultures, Carriers, and the Outbreak Narrative*. 2008. Duke University Press. 392 p. 2008.

Testimony of a Congolese Refugee

Presencing Atmospheres Through Listening

Ilana SANCOVSKI¹,
Cristiane Rose DUARTE²

Abstract. The aim of the current article is to point out notes about a research method focused on investigating atmospheres based on sensitive listening of testimonies. Based on a research conducted in the migration and refuge field, it presents the case of a field experience where a Congolese refugee shared her story with students from a public school in Duque de Caxias, Rio de Janeiro. This case study enabled concluding that it is possible presencing a certain atmosphere by listening to ones' testimony. Moreover, the field experience showed the feasibility of seeing the emergence of other atmospheres that gradually intertwine and overlap in the space shared by different individuals.

Keywords. Atmosphere, Sensitive Listening, Testimony, Refuge

Introduction

When we started our research about the association between culture and space based on the ambiance five years ago at LASC³, we believed that a present and concrete experience was essential to assure the success of our study. However, our research has gained such spatial and temporal proportion that has stopped us from achieving the success through the concrete spatial experience. Literature became a great ally in our research, aimed at understanding how Jewish culture was materialized in spaces (Sancovski, 2017). We developed a tool, "Imagined Walks"⁴ to 'experience' ambiances at different times and spaces by following the narratives. Therefore, we decided to deepen our research and pursuit new ways of presencing atmospheres and ambiances mediated by narratives that could highlight the subjectivities interested us.

Currently, we investigate the (de)construction of "inhabiting the exile" in the migration and refuge field. Based on the approach of diaspora theorists, we understand inhabiting based on the being-space dialectic (Brah, 2011) and consider ambiances as constitutive and fundamental part of experiencing life in a new place. Over the last year, we have dedicated to listen to testimonies of refugees who have narrated their life experiences during the process of (de)constructing their inhabiting. Thus, the current article points out notes about a method under construction, based on a field experience whose listening process enabled perceiving atmospheres already experienced, as well as building new ones. The first part of the article addresses the field experience context, which was the basis for the conceptual and methodological

1. LASC/PROARQ. Federal University of Rio de Janeiro, ilana.sancovschi@gmail.com

2. LASC/PROARQ. Federal University of Rio de Janeiro, crsduarte@gmail.com

3. Architecture, Subjectivity and Culture Laboratory. See at: www.lasc.fau.ufrj.br

4. Inspired in the "Commented Walks" methodology (Thibaud, 2002)

development of the current study. The second part, presents notes about the adopted method. Then we present the field experience report, which enabled concluding that one can experience an atmosphere through sensitive listening mediated by other individuals.

Testimony and Context

One of the biggest challenges we faced before starting our research lied on convincing refugees and asylum seekers to share experiences, since being acknowledged - researchers - as trustworthy “listeners” by them was not a simple task. Thus, the pre-existence of a space to share and exchange experiences was a valuable and fruitful field for our research.

The current article presents the testimony of a Congolese refugee who lives in Rio de Janeiro, nowadays. Sophie’s⁵ story was told by herself in one of the lectures held by the program promoted by PARES-Caritas. On 2019, we followed the program called “Refugees in Schools”⁶, whose refuge topic was mainly addressed to students of schools in Rio de Janeiro. The idea is that educating these students creates vectors of the awareness about the refuge topic, forming empathic networks to the cause, promoting greater acceptance of a new social reality capable of favoring refugees’ integration.

It is essential emphasizing that we listened to Sophie’s testimony in a classroom of a municipal school in Duque de Caxias; this event counted on the presence of approximately twenty children (mostly Afro-Brazilians at the age group 12 years), one teacher, the social worker trainee at Caritas, Sophie and the researcher. We focused our analysis Sophie’s testimony in interaction with students, based on the listening method. As the field report shows, listening enabled presencing different atmospheres experienced by the refugee in her testimony; it also enabled presencing an atmosphere in motion in the space shared by us; thus, somehow it constituted what Foucault ([1967] 2013) calls heterotopy.

Testimony, Listening and Atmosphere

According to Selligman (2010), testimony must be understood since a complex set encompassing individuals’ perspective, narrative and ability to judge. Moreover, the superficial understanding about the testimony can lead to the spectacularization of pain that - in cases like the herein reported one, i.e., the traumatic experience of a refugee - can become quite recurrent and hide shades of the experience to be shared. The complexity of a testimony claimed by the aforementioned author is an important key in our research field. Thus, issues such as empathy, sensoriality and spatial sensitivity were also added to our understanding about testimonies to enable a sensitive listening capable of experiencing different atmospheres.

Lacapra (2005) addressed trauma in the context of history in order to highlight interaction between the claim for absolute truth and other historiographic factors or forces. Based on this perspective, the subjective dimension is an important factor in the history composition, since it gives relevance to testimonies, life reports, among others. According to the author, “empathy is a type of virtual, vicious experience [...], according to which individuals’ emotional response is associated with their respect for

5. *The refugee’s name was changed to preserve her identity.*

6. See: www.caritas-rj.org.br/refugiados-nas-escolas.html

the other and with the awareness the experience of the other is not their own experience” (Lacapra, 2005, 62).

In compliance with Lacapra’s perspective, we herein acknowledge that empathy is essential to enable effective sensitive listening. In addition, our research does not aim at finding the veracity of narratives; it is mainly focused on investigating the subjective experience of the other. Our listening experience has operated in an empathetic way - not in the sense of putting ourselves in the other’s place, but in welcoming and understanding the other’s place. Thus, sensitive listening enabled presencing the atmosphere mediated by the experience of others and, simultaneously, the atmosphere shared by us as listeners.

Barbier (2002) has defined sensitive listening based on his research on education, training and psychotherapy. He also stated that sensitive listening is based on empathy.

“Researchers must know how to feel the affective, imaginary and cognitive universe of others in order to deeply understand their attitudes, behaviors and system of ideas, values of symbols and myths” (2002, 1).

Interestingly, Barbier (2002) did not approach the spatial field in its strict sense, but we can understand that the sensitive approach used by him can lead to the understanding of space and of the atmospheres composing such a space. Finally, Barbier has also argued that sensitive listening should not be restricted to one interpretation. “Interpretive propositions” can only be made in a second moment, when meanings are borrowed from the cultural capital resulting from researchers’ experience (2002, 4).

As researchers in architecture and urbanism field, we used sensitive listening to adhere to the sensitive experience of space lived through testimonies. We presenced atmospheres in the transversality of meanings. We witnessed atmospheres mediated by others, which gained meaning throughout the listening, not only due to the narrated story, but also to voice tones and impositions, to reactions of listeners who shared the present space with the narrator, and to affections shared in this common space where refugee and students have gathered. Thus, listening gained much greater proportion than just hearing and it adds values and meanings to the space experienced at the time of listening.

Therefore, listening is the basis of our research; it is the initial moment when we make ourselves available to the sensitive experience of an atmosphere that gains new life in our own experiences. Our field experience in the case of the Congolese refugee concerned the record of her narrative, as well as her interaction with students. Reflections about this experience took shape from the first listening, and gained volume based on the re-listening process and on our own memories.

The Refugee Experience in Overlapping Atmospheres

According to Augoyard (2007), *ambiance*, or atmosphere, is a concept easy to be felt, but hard to be explained. If the experience of a given atmosphere is directly linked to individuals’ sensations, perceptions and actions in space, the current study should overcome two obstacles: the first one lies on presencing atmospheres through listening and the second one concerns conveying the action in motion to readers. Thus, we made the option for presenting the written narrative of the field experience. Although we knew that writing could hide shades of sensitive experience, we tried to portray as much of the research and analysis process as possible.

As previously mentioned, our listening procedure took place in a school. We entered the classroom with students; they were excited about the opportunity to listen to a refugee⁷. The teacher apologized to Sophie for the mess. Sophie replied to him: "We were once like that too! This is normal." After children's anxiety was overcome, Sophie started telling her story.

Sophie started her testimony by introducing herself. She kept her voice in a lower tone at the time she approached her listeners, which indicated stress and introspection for having to go back to unpleasant places associated with her life experience. Yet, by using a very shy tone, she apologized for her Portuguese. Despite her accent, she was very fluent. The first sentences shared with the class allowed us witnessing an atmosphere, which appeared to involve her life. Her stress and shyness brought us to the experience of being in a new place where communication is an obstacle to overcome, where sounds of words are different and mean nothing. We witnessed an atmosphere that highlighted the feeling of being "out of place," of "not belonging."

Sophie moved on in her narrative, at this time, she talked about her professional training - "I studied in my country! I graduated in international relations" - full of pride. She also said she had a good job "when it all happened"; from here, her voice became sad, what suggested she wanted to erase what happened from her memories. Her testimony made clear, her sense of belonging and identity is linked to a place. Although Sophie has a job in Brazil, she associates her identity (including professional identity) with her original country, where she studied and worked.

Sophie explains the reason for conflicts taking place in her country before she talked about the hard times she experienced. She spoke about her country, and her voice was filled with pride, "my country ... is a rich country!" then, she compares it to Brazil when she said "it is ... like Brazil, where we are." Sophie's narrative seems to claim a sense of belonging, her voice and speech seek identification space. It is as she carried a double atmosphere; her identity was transited and changed in these atmospheres, she sometimes identified herself with the present place, sometimes with the place of origin. "I don't want what is happening to my country, to happen here!" She ended this passage by saying that whenever she talked about her country in her narrative, she would return to Brazil, her new country - once again she claimed the sense of belonging to the place.

Sophie's testimony also reports atrocities such as invasion, killing and rape taking place in several villages. Her angry tone of voice presented us a picture with strong colors and tense movements. These reports allowed us to witness an atmosphere of terror, which we shared with students. At that time, we perceived attentive and tense looks in the classroom. However, Sophie's voice assumed a lower and sad tone when started to talk about her personal experience, which indicated that it was really hard for her to talk about.

Sophie said that she left early that day and left her relatives at home. When she returned, it was no longer possible to enter her city because it had been taken by rebels - her voice even broke at that moment. "They were already...", she said, "people were screaming and crying." Sophie's narrative presented several gaps at this

7. Although periphery zones are the common destination of many refugees seeking residence in Rio de Janeiro (Cidade, 2018), it was not possible knowing whether there are refugees in the place where the research was conducted.

point; although she fully expressed the atmosphere of tension, fear and suffering experienced by her, the narrative was not localized, we were not able to visualize for sure the physical space where Sophie was. We ended up experiencing the idea of confusion in this atmosphere, as well as the previously mentioned tension, fear and suffering.

The moment when she agreed to ‘flee’ from her city appeared in Sophie’s testimony in a very painful way. She had met a neighbor who convinced her not to go looking for her family. Sophie did not know whether they had managed to leave the house or whether the rebels had taken her ones as prisoners. However, the preservation of “family blood” spoke louder and Sophie accepted to escape. At the time Sophie finished telling her story, we could see shock and fear in the faces of the children; as if they were mirrors of a given space, of a represented atmosphere.

After Sophie’s narrative was over, students were allowed to ask questions. The very atmosphere of the classroom started to change as the questions brought the refugee’s reality closer to that of the children. Laughter, whispers and a certain amount of excitement about sharing an experience have gained room and overlapped a new atmosphere to that experienced by Sophie. A student asked: “Did you suffer any prejudice here?” and then the refugee told about an experience she had on a bus in Rio de Janeiro. The identification between the refugee and the children was very clear throughout her narrative, since sympathetic laughter and amazement interrupted and followed the story. Prejudice is a fact in atmospheres experienced by children who live in periphery zones in Rio de Janeiro. It is as if they witnessed their own experiences on Sophie’s narrative. The experience sharing and the mutual acknowledgement of the experience lived by the other have led to the acceptance of an unknown social reality, it also opened room for the likelihood of including the other in city spaces.

Final Considerations

Since the scope of this article is limited, we only presented few moments of our field experience, which led to preliminary conclusions. We must say that the experience of sensitive listening in the context of our research led us not only to presence a different atmosphere but also to build new ones. The place described by the refugee, the place we imagined and the place the students imagined were overlapped at the same time. Thus, the herein presented atmospheres comprised the subjectivity of each individual attending the lecture in order to build a collective “inhabiting” and, mainly, to (de) construct the refugee’s “inhabiting”; this dialectical experience has shown her the possibility of social inclusion. Our field experience enabled seeing the environment gaining complexity throughout the listening and exchanging processes, which overlapped and interweaved the atmospheres in the classroom, both in the present and imaginary spaces. We all started to experience an atmosphere of sharing and hope.

Acknowledgement

The authors are grateful to Coordination for the Improvement of Higher Education Personnel (CAPES), for granting the Ph.D. scholarship; to LASC/PROARQ/UFRJ, for the support; and to PARES-CARITAS, for making available the research space.

References

AUGOYARD, Jean François. “A comme ambiances” In: Les cahiers de la recherche architecturale et urbaine. N. 20-21- Paris: Ed. Du Patrimoine, 2007. P.33-37

BARBIER, René.. L’écoute sensible dans la formation des professionnels de la santé. Conférence à l’Ecole Supérieure de Sciences de la Santé. Brasília, 2002. Available in: <http://www.barbier-rd.nom.fr/ecoutesensible2.htm>

BRAH, Avtar. Cartografias de la diáspora: Identidades en cuestion. Traficantes de Sueños. [1996] 2011

CIDADE, Natália da Cunha. Refugiados Urbanos: estudo sobre a distribuição territorial de refugiados no Rio de Janeiro e seu impacto no processo de integração local. Dissertation. UFRJ/PROURB, 2018

FOUCAULT, Michel. De espaços outros. Estudos Avançados 27(79) p.113-122, 2013. Available in: www.revistas.usp.br/eav/article/view/68705

LACAPRA, Dominick. Escribir la historia, Escribir el trauma. Ed. Nueva Vision. Buenos Aires, 2005.

SANCOVSCHI, Ilana. A Invenção do Lugar Judaico: uma vivência das ambiências nas narrativas de I.B. Singer, Moacyr Scliar e Amos Oz. Rio de Janeiro. UFRJ/FAU/PROARQ. 2017

SELIGMANN, Marcio Silva. O lugar do testemunho. Tempo e Argumento. Revista do Programa de Pós-Graduação em História. V.2 n.1 p3-20. Florianópolis, Jan/jun 2010.

THIBAUD, Jean-Paul. Une approche des ambiances urbaines : le parcours commenté. In: Espaces publics et cultures urbaines. Paris, 2002, pp.257-270.

Re-Sensitizing as New Sensitizations Process

Experiences on/of the Street

Bárbara THOMAZ¹,
Juliana QUEIROZ²

Abstract. Ambiances affect us in several ways. Our everyday lifestyle has guided us to a lack of time to feel, raising questions about our sensitiveness. Questioning if re-sensitizing activities would create new ways of sensitivity, we decided to explore the points of view of passersby from the streets of downtown Rio de Janeiro. Experiences on/of the streets have derived from the look of the flâneur. Each passerby was invited to analyze the street in sensible ways such as sounds, smells, and with the help of a frame - as in when one is about to photograph something - an angle of the street. The experience has shown that the sensitive is in everyday life and is apprehended when we let ourselves be carried away by the affections, the feeling stripped of the analytical eye.

Keywords. *Re-Sensitizing, Flâneur, Street, Photograph*

Understanding a Sensible Approach

The power of impregnation of ambiances concerns not only the environment, but also ourselves, as we are conditioned to detect subtle differences. Sensitivity expands our field of perception, letting us more susceptible to the force of ambiances.

Sensitivity becomes a faculty to capture these forces. It can also be understood as receptivity to external stimuli. In other words, sensitivity allows its bearer to recognize quite different environmental stimuli or to ignore them (Schmitz, 1995). Thus, to speak of the powers of impregnation is, in a way, to speak of sensitivity (Thibaud, 2019).

Although sensitivity is inherent to every human being, some studies (Haroche, 2013; Baumann, Dokins, 2014) have reported people's loss of sensitivity. Our lifestyle is increasingly guided by our lack of time to feel (Haroche, 2013) lead us to a consumerist and individual view of current resources and to a weak and fragmented social bonds.

If it is through sensitivity that we are taken by the force of ambiances, the detection of loss of sensitivity leads us to explore new sensitizations. "How to open our emotions to secondary qualities, open our senses to secondary qualities: the timbre of a voice, the brightness of light, the momentum behind a gesture." (Thibaud, 2019, 179).

Like ambiances, sensitivity is clear in a real situation and cannot be learned theoretically.

1. Universidade Federal do Rio de Janeiro, Laboratório Arquitetura, Subjetividade e Cultura- LASC/ PROARQ UFRJ, Rio de Janeiro, barbarathomazln@gmail.com

2. Universidade Federal do Rio de Janeiro, Laboratório Arquitetura, Subjetividade e Cultura- LASC/ PROARQ UFRJ, Rio de Janeiro, jqueirozrtm@gmail.com

It occurs only through the experience of the psychological process in which the individual is not only present passively, but also participates emotionally and actively in a specific situation or event. It is in the search for an emotional and active engagement, that the person understands and explores not only new sensitizations, but those that were also dormant within us, forcing us to re-sensitize.

The use of the prefix 're' brings a notion of repetition or reinforcement; it is a new interpretation of a state or process. Re-signifying or re-sensitizing is being focused on making a new analysis, creating new meanings, and deepening thoughts and sensations.

If it is only by experience that we can understand sensorially, then experimenting places not only send us to a sensitive dimension, but also to sensible places (Thibaud, 2018). And even if some places carry some preconception within themselves, a sensible experience is personal and unique.

To raise awareness is to make the pedestrian pause and explore, consciously, the sensible possibilities of a place and create new meanings. In this perspective, affection appears combined with perception. Being in an active process during the walk is a fundamental and essential mean to make the body connect with places, emerging a sensitive and participatory approach.

Considering the process of walking aimlessly through the streets, just like a *flâneur*, this research brings the experiences on/of the streets. With the point of view of a careless walker, we aimed to use photographs, not only to capture what beholds the sight, but also the feeling present when the picture is being taken.

This experience showed us that, in addition to being able to collect data of sensible events that occur in urban spaces, as we seek to bring new sensitizations alive to another person, we also are in fact a part of the process itself.

Dynamics on/of the Streets

Thinking about ambiances leads us to find what emphasizes our ability to be affected by our surroundings, as well as allowing them to be affected by us. In this context, the street is much more than just its constructed materiality: it is created physically and sensorially. The role of the body at the street becomes essential as a vehicle for experiencing environments and the appropriation of places, since the exchange of movements and actions makes the space diverse and significant.

Thibaud (2019) states that it can be difficult to approach a feeling in its essence empirically; when working on perceptual axes, and borderline situations, there is a great chance that it will reveal itself. As a means to establish a mutual resonance, borderline situations usually require ourselves to be carried away by the perception of the other's point of view (Breviglieri, 2013). In this case we understand that it would not be just to trigger new sensitizations, but to allow the sensitive to emerge.

When dealing with the other's point of view, we would be required to leave ourselves, recognizing ourselves from otherness, which is when we are aware of the Other (Eisenberg, 1986). Being in the public space, experiencing it leads us to the possibility of recognizing otherness, enabling the expression of individuality within a necessarily plural universe. In the plurality of the street we are brought to the encounter of affections, materialized in urban scenes.

The *flâneur*, a figure of the modern city, has been transforming itself throughout the times. Before, only an observer of the daily life of the cities but, now photography has also been added as a method of tracing down the walk.

Each photograph taken is a direct action of the person taking it. When taking a photo, the person chooses “the permanence of a certain moment.” At that gaze, the specific angle chosen creates identification with the scene.

Using photography as a means of recording experiences that take place on the street, it helps us to become intimate with the urban scene and its actors. For Kossoy (2003), every author of a photograph begins with a purpose, because at that moment, the chosen framework shows the photographer’s vision, imagination, and the form of personal expression.

In view of a better understanding of how pedestrians relate to the street, we found it pertinent that we would bring up an exercise about the perception of urban sensitivity with random passersby on the street.

Planning the Unplanned: the Experience on/of the Streets

Considering the street as the main environment to study processes of urban re-sensitization, our group of researchers identified that walking would be the most suitable way to gather different perspectives on the experiences on/of the street. During the idealization of the experiment, the intent was to go out to the streets and re-sensitize pedestrians.

As previously discussed, to be engaged in a sensitive experience we need to sharpen our senses. So, the aim was that those who researchers approached on the streets could first pause and focus on that moment, and then be a part of the re-sensitization experiment. The idea was to encourage the invited ones to have a practical and viable way of expressing themselves, in a sensible bias. As a means of expression, photography becomes a possible and interesting method to grasp the actions on the streets. It is also a way to promote an exchange between pedestrians with their surroundings.

During the experiment the passersby, who previously walked the streets just experiencing flanerie, become actors of their own experiences. Turning passersby into photographers, we could begin to sensitize people to their surroundings, which often go unnoticed in daily life. Therefore, we developed the first form of interaction between researchers and the pedestrians asking them to take a photograph of something on the street that grabs their attention, something that would captivate their senses. They could choose anything that had a positive or negative aspect. The goal was to make the pedestrians stop walking and focus on the action. To give the pedestrians full authorship of their framings, we created giant and festive frames to make the whole experience more palpable.

The walk-through experiment started downtown of Rio de Janeiro, a place with a lot of movement and a wide variety of pedestrians, such as: traders, businessmen, shopkeepers, and tourists. We decided to split the researchers into three groups to prevent a feeling of discomfort for those we approached. The starting point was at Tiradentes Square, a historical and central portrait of the city’s urban landscape. From that point on, we instinctively went in different directions to approach the first passerby.

A small questionnaire was developed to be completed as we talked to the pedestrians. First, we asked the participant to frame something in their surroundings that seemed interesting. Then we asked them to describe the scene in the frame with one word and asked if the person visited that place frequently. In order to reach more sensitive levels. We also decided to explore other senses beyond sight and asked what smells and sounds were the most represented at that very moment.

Just like the flaneur who walks around without a planned direction, the researchers decided that it would be the participants of the experience that would dictate our course. Thus, when framing a view of the street, without knowing it, the participant was guiding us to our next direction. We were putting ourselves, literally, in the other's point-of-view and generating walks guided by the passersby. As much as the purpose of the drifting is to walk being led aimlessly, we wanted to be able to document the experience and our path. Therefore, we photograph the frames being used and recorded the route of each group using a GPS application.

Our aim, as researchers as the experiment proceeded was to raise the awareness of inattentive pedestrians “entering” the frames. The research was so captivating that it was not noticed that the groups physically encountered each other multiple times (according to GPS). We were all so focused on looking at the city with new eyes, listening to the brakes of the cars, the music coming out of stores, smelling food and the old beer washed of the sidewalks of a previous party, that all the sensitive elements that had been shown to us, had reached us.



Figure 1. Framing option of a participant, Juliana Queiroz, 2019



Figure 2. Framing option of a participant, Marília Cavalcanti, 2019

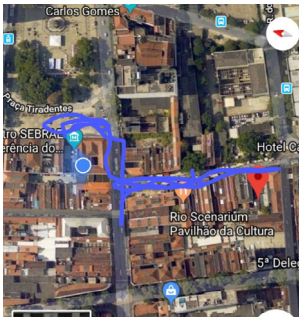

Figure 3. Map of group 1's path, Juliana Queiroz, 2019

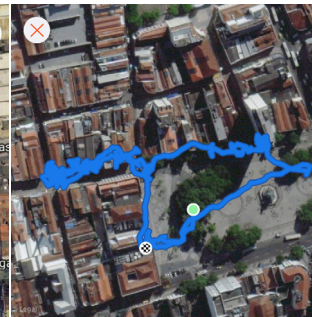

Figure 4. Map of group 2's path, Eliene Tozetto, 2019



Figure 5. Map of group 3's path, Matheus Mota, 2019

Framing the Action: Outcome of the Experience

To explore the sensitization of the process, the experiment was designed to invoke sensitive experiences on/of the street from the pedestrians' points of view. Each frame invited the participant to stop and look at the street in a more sensitive way. However, although the experience started with the aim of awakening the passersby's senses, it ended up taking another direction: affecting the researchers.

The perception that *I* only exist from the *Other* means that otherness is what allows

me, also, to understand the world from a different perspective. This demonstrates how much we could be sensitized by the experience. In experiences that focus on understanding the sensitive space and how people perceive an emotional and active participation of the involved ones is required, including researchers. The analytical eye of the researchers is usually turned to the space and its actors, forgetting that they are also part of the scene.

Exploring a sensitivity sight within the framework went beyond those who were passing by, leading the researchers to a new interpretation of their own state and process and re-sensitize them. The researchers reported that being part of the experiment made them transpose their own world views. It was an experience that seemed to bring borderline situations, since those involved were urged to disassociate themselves, triggering new sensitizations in a re-sensitizing process.

Thus, although the exploration was turned to study the street through the sensitive point of view of the passerby, it was the researchers who reported the nuances detected in each route. It was the body of the *flâneur* who, even sensitized by their own affections, demanded to expand their perception in relation to their surroundings.

Finally, perhaps one of the most unexpected results of the experiment was the different ways in which new sensitizations were instigated. From the use of the digital camera to the flanerite taken from a photo shared by the other, it was possible to explore the experiences on/of the street under a sensitivity bias. As much as the researchers and passersby were related to the same source - both were submerged in the same ambiance - the experience prompted the researchers to revisit and reconsider the sensitive aspects pointed out by the pedestrians. As the researches were trying to explore a new sensation process through pedestrians, they were, additionally, led to re-sensitize themselves.

Conclusion

When people are exposed to a certain situation here and now, they are not only confronted by measurable factors, but also by the sensitive ones. In the same way that subjectivity is produced in the relationship of forces that pass through the subject, it is considered that the sensitivity that emerges from an ambiance impregnation, also (re) sensitizes us. To think about the street ambiances and the way that it spreads and takes hold, the experiment shows that we must allow the sensible to emerge.

The street for some has a spatial poetics, for others it is a transition. Some have it as a home while for others it is just a place of passage. How we see the street, how we frame it in our perspective and how we allow ourselves (or not) to experience it, based on how we framed it was the guide of our practical experience. Experiencing it involved not only being in your physical space but also letting yourself be carried away by its affective tones (of affection and its effects). The smells and the sounds that are part of their narratives, our relationship with each other and with ourselves: we are in a certain way at some point flâneurs, part of the same experience. In this process, what we had was the confirmation that when re-sensitizing cities, we are not only talking about the other, but also, and above all, about ourselves.

References

- Bauman, Zygmunt.; Donkis, Leonidas. *Cegueira Moral: a perda da sensibilidade na modernidade líquida*. 1. Ed. - Rio de Janeiro: Zahar, 2014.
- Benjamin, Walter. "Flâneur." In__ : *Obras Escolhidas III*. Tradução de José Carlos Martins Barbosa e Hemerson Alves Baptista, 3ª ed. São Paulo: Brasiliense, 1994
- Eisenberg, Nancy. *Altruistic Emotion, Cognition and Behavior*. New York: Psychology Press, 1986.
- Breviglieri, Marc. *De la difficulté à entrer en contact*. L'enjeu phénoménal d'instituer des espaces sensoriels pour le travail social hors mur. *Ambiances* [En ligne],2013 Accessed jun 15, 2020. <http://journals.openedition.org/ambiances/345>
- Grossman, Evelyne. *Éloge de l'hypersensible*. Paris: Minuit. 2017.
- Haroché, Claudine. *A condição sensível*, Rio de Janeiro: Contracapa, 2008
- Kossoy, Boris. *Fotografia & História*. São Paulo: Ateliê Editorial, 2003.
- Pallasmaa, Juhani. *A Imagem Corporificada*. São Paulo: Bookman, 2013.
- Schmitz, Herman. *Der unerschöpfliche Gegenstand*. Grundzüge der Philosophie. Bonn: Bouvier, 1995.
- Thibaud, Jean-Paul. The Lesser existence of ambiance In *Atmosphere and Aesthetics: A Plural Perspective* edited by Tonino,Griffero an Marco Tedeschini, 175-188. Berlin, Springer Verlag, 2019
- Thibaud, Jean-Paul. Les puissances d'imprégnation de l'ambiance. *Communications*, no 102,(1), 2018 67-79. <https://www.cairn.info/revue-communications-2018-1-page-67.htm>

After the Ruins

An Affective Topography of Post-Earthquake Cities

Elisa MORSELLI¹,
Federico DE MATTEIS²

Abstract. The research we present focuses on a phenomenographical mapping of a mountainous region of Central Italy which, between 2009 and 2017, was struck by several catastrophic earthquakes. As the reconstruction efforts are variously proceeding to reinstate a questionable status *ante quem*, there is a widespread feeling that this rebuilding is in fact ignoring the “human space” that animated the towns before the dramatic events. This affective topography thus aims at presencing the atmospheric situations we have encountered by means of a variety of media, among which drawing, photography, cartography and commented walks.

Keywords. *Phenomenography, Affective Topography, Urban Atmospheres*

Introduction: a Shaken Landscape

Between 2009 and 2016, vast portions of Central Italy’s mountainous areas were struck by severe earthquakes, resulting in widespread destruction and a harsh death toll. Both major cities such as L’Aquila and smaller towns, for example Amatrice, suffered extensive damage. If in the latter case the centers affected by more recent events still today largely lie in ruins, in L’Aquila the reconstruction has made substantial progress, bringing back to life wide portions of the historic fabric. Nevertheless, the outcomes of this process of rebuilding have been harshly criticized due to the intention - common among administrators, political decisionmakers and technicians - that the reconstruction should strive to reinstate a condition *ante quem*, bringing the city back to what it was *before* the traumatic event (Varagnoli, 2019). In our opinion, such position embodies an implicit act of “removal,” ignoring the affective dimension of urban space (De Matteis, 2019, 83). In this sense, there is little possibility of negotiating the trauma embedded in the inhabitants’ corporeity, allowing the onset of a healing process unfolding on both practical and existential levels.

Starting from this consideration, our project consists in producing a *phenomenography*, i.e. a differed presentation of a spatial situation encountered in first person (De Matteis et al., 2019). We have selected a territorial route across the central spine of the Apennine mountains in the Abruzzi region, connecting the areas damaged by the 2009 earthquakes with those hit in 2016. Using a variety of tools - cartography, drawings, photography, and commented walks - we created a narrative of the spatial encounters made in five distinct locations along the route, covering the varying degrees of destruction and reconstruction that these wounded territories are found in today. Our wider

1. Sapienza University of Rome, Italy, elisa.morselli@uniroma1.it

2. Associate Professor of Architecture, University of L’Aquila, Italy, federico.dematteis@univaq.it

goal consists in attempting to grasp and “make present” (Gumbrecht, 2004) the atmospheric conditions of these towns and landscapes, not with the intent of producing an immediate design alternative, but to allow the spatialized affects to come to the surface, becoming visible and potentially orienting a discussion on the future of the reconstruction process.

Affective Topography

Exploring these ruined or rebuilt places of Central Italy, the quake’s traumatic effects become manifest through a variety of entities and hues. In some cases - such as Onna - the damage on the city’s physical structure has been so extensive as to make any reconstruction nearly impossible. Other situations, most notably L’Aquila, are on the other hand witnessing a dynamic rebuilding effort, which has returned many of the city’s urban spaces to usability. Yet despite this, only a small fraction of the original population has returned to live in the historic center, which is mostly used for daytime activities only. The deliberate ‘erasure’ of the earthquake’s traces, as can be observed in L’Aquila, Paganica or in other rebuilt portions of towns, merges with the absence of stable residents to express an affective response to both the catastrophe and the ensuing reconstruction.

In performing our observation, as a research group we started from the consideration that, differently from the local residents, our degree of familiarity with the places we explored was very varied. We put our ‘strangers’ eyes’ at work to map the affective space by means of a *phenomenographical* exercise. The tools we adopted to record the lived experience in the sites of the earthquake territories have been deployed in two distinct stages. In the first, during the exploration of the various areas, we commented our sensations as they were unfolding (Thibaud, 2013), live-recording the group’s voices and documenting the sites through photography. The walking exploration of the places progressed in different ways, depending on their being inhabited or abandoned, the degree of visible physical damage or reconstruction, or even fleeting atmospheric elements such as the wind, sunlight and temperature. All these variables concurred in soliciting from each of the explored sites a distinctive corporeal disposition, a subjective stance largely shared by all group members as we discussed in real-time what we were experiencing.

The routes through the sites were not strictly fixed in advance, but rather proceeded in relation to the encounters we made along the way, since our attention was drawn to various elements: in the more damages areas, for example, it could be a fractured building, the overwhelming presence of wild vegetation, or an open door allowing a glimpse onto dust-covered personal objects still visible in a former domestic space. Equally, the rhythm and pace of the exploration was dictated by the encounters, which we commented as they were taking place.

The photographic work followed the exploration and proceeded as a ‘live stream’ of visual recording. In a second stage, as we selected and organized the images shot by the various members of the group, we could critically outline the entities that had captured our attention during the walks, from the fragments of urban space to the mountainous landscape, to the details of architecture and the traces of human presence emerging from personal items or domestic interiors. Through the critical work on the photographs we identified a number of salient situations that appeared as being affectively charged: these spaces were then re-drawn to strengthen their expressive power, removing color and in some cases increasing the contrast to bring to the foreground the emotional content of the spatial situations. The composite

result of the exploration, combining the narrative of the lived experience of the exploration and the ex-post work on the images, is our synthetic phenomenographical documentation of the atmospheric space we encountered during our walks through the earthquake-stricken towns.

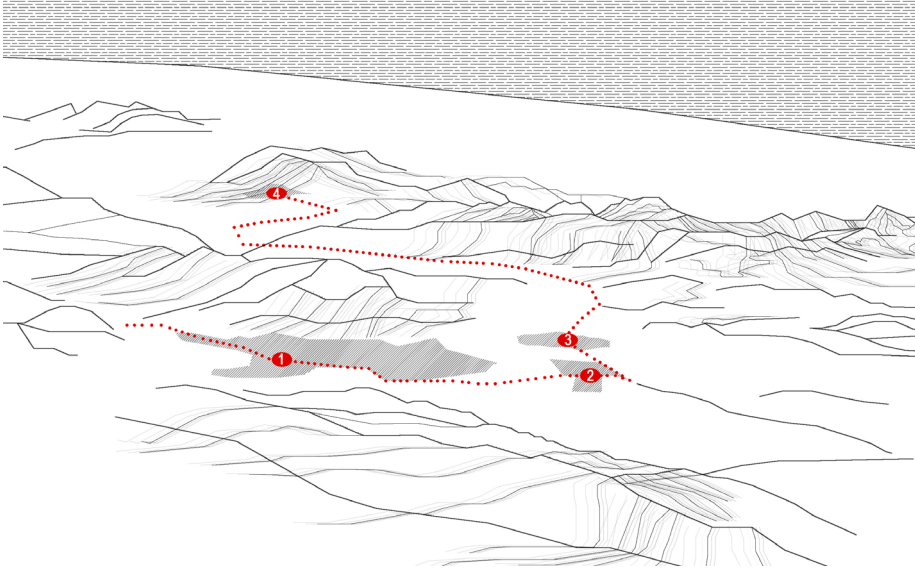

Figure 1. Commented walks route with its main stops:
1. L'Aquila, 2. Onna, 3. Paganica, 4. Campotosto

A Fragment of the Walk

Our exploration through the earthquake towns took place over several days and included five locations along a territorial path across the Apennine mountains. Sampled fragments of these walks can provide a notion of the method and of the observations' outcomes. In Paganica, a small historic center located in L'Aquila's suburban area, we met what was perhaps the most intense spatial experience, one that affectively engaged us with an atmosphere eventually following us throughout the journey, later extending and lingering into the process of production of our phenomenographical observation.

We entered the town through the square of Santa Maria Assunta, the largest local church, then walking along the main street and later returning by way of a secondary road. The neatly restored square offers insight into the contradictory condition of the reconstruction process: the church faces onto two renewed corner buildings painted a "reassuring" pastel color erasing not only the traces of the earthquake's damage, but also any historical patina (Sørensen, 2015). This restored part of town lies entirely empty, the sole living presence being heralded by the sound of the fountain's waterspouts.

Beyond this entrance threshold, the street opens into an altogether different urban condition, an almost surreal, uninhabited landscape of ruined buildings. Here the sensation experienced was one of uncanny disorientation, as we first entered the deserted wasteland of semi-collapsed buildings. Many of the town's houses have been consolidated, but these partially restored architectures dot the urban fabric in a piecemeal fashion. One house, for example, sported brand-new window casing, while the adjacent elevation was still encased in temporary bracings to prevent collapse.

The rebuilding, contrasting with the nearby traces of destruction, was suggesting something: the erasure of the traces of what had occurred. In some way that was difficult to decipher, we sensed that Paganica’s original atmosphere had vanished. Walking further into the heart of the town, this initial impression became stronger, and one member of the group commented: “By erasing the earthquake’s traces, the place’s history was removed as well.”

This early shock slowed down the pace of our exploration, as we moved among the streets and buildings in a reduced tempo. Walking on and around piles of debris and dirt, our movement was directly guided by the earthquake’s traces. Penetrating secondary alleys leading towards the houses’ entrances, a broken window or half-open door revealed personal objects mixed with rubble. All these entities were *expressive* of a present situation while also evoking the haunting of human life past, a twofold condition towards which we sensed a felt-body resonance (Griffero, 2016).



Figure 2. Paganica, November 2019. Photos by authors

As the walk progressed, our comments expressed an increasing density of emotions: “The more we walk, the worse I feel”; “The atmosphere is *haunted*.” The *presence* afforded by the expressive array *moved* us by generating continuous physical movement and corporeal stirrings (Schmitz, Müllan, and Slaby, 2011). The atmosphere became increasingly heavy, with a burden of vague anxiety, and as our steps grew slower, the spoken comments left more space to photography. The disemboweled houses, abandoned objects, a crushed car, the photographs of people who had lost their lives on the night of the earthquake, all somehow ‘froze’ a dramatic atmosphere from which it was impossible to subtract oneself.



Figure 3. Drawings and photograph by authors
From left to right: L’Aquila (1&2), Paganica, Onna

Conclusion: From Mapping to Design Thinking

Our phenomenographic description of the earthquake-stricken landscapes and towns strives to be a non-objective, non-representational *making-present* of spatial situations. In its ontology lie both limitations and potential: it is *subjective*, in the sense that it reports the experience of specific subjects, not a universal and measurable condition; yet it brings to the surface a sense of the atmospheres we encountered, as emanations of the urban and human environments that we corporeally resonated to. This acquired visibility, the *presencing* of such phenomena, is for us the added value of an exploration grounded on the primary evidence of the felt-body's response, in an attempt to elevate it from its ineffable latency.

The ensuing question relates to the use that can be made of this explorational tool. Once we have brought to light entities that are otherwise unavailable - since they remain opaque to conventional, distancing descriptive mechanisms - how can they become foundational for the process of reconstruction of these damaged urbanities? In fact, what we are observing are traces of the human depth of these towns, the testimony of their past life and of the trauma they have suffered. It is a type of evidence that does not appear in the dry representations normally serving as the basis for the mimetic reproduction of an ideal pre-catastrophe condition. We believe that in the critical process of rebuilding, such traces must not be overwritten: we are not speaking of the calligraphic precision of recorded history, rather of the patina, the dust, the dirt sedimenting where real human life unfolds. Along with these stains, the cracks and fissures created by the earthquake should turn into the scars of the trauma, in a process no longer relying on the naïve aspiration to removal, rather on the thoughtful negotiation of mourning. Instead of pretending that *nothing has happened*, it is on these grounds that a healthier and more solid future urban life can emerge.

References

- De Matteis, Federico. "On the natural history of reconstruction. The affective space of post-earthquake landscapes." *Studi di Estetica*, IV, 47:14 (2019): 65-87. <https://doi.org/10.7413/18258646083>
- De Matteis, Federico, Mikkel Bille, Tonino Griffero, and Andrea Jelić. "Phenomenographies: describing the plurality of atmospheric worlds." *Ambiances* 5 (2019): 1-22. <https://doi.org/10.4000/ambiances.2526>
- Griffero, Tonino. "Atmospheres and felt-bodily resonances." *Studi di Estetica*, 4, 44:1 (2016): 1-41.
- Gumbrecht, Hans Ulrich. *Production of presence: What meaning cannot convey*. Stanford: Stanford University Press, 2004.
- Schmitz, Hermann, Rudolf Owen Müllan, and Jan Slaby. "Emotions outside the box – the new phenomenology of feeling and corporeality." *Phenomenology and the Cognitive Sciences* 10:2 (2011): 241-59. <https://doi.org/10.1007/s11097-011-9195-1>
- Sørensen, Tim Flohr. "More than a feeling: towards an archaeology of atmosphere." *Emotion, Space and Society* 15 (2015): 64-73. <https://doi.org/10.1016/j.emospa.2013.12.009>
- Thibaud, Jean-Paul. "Commented city walks." *Wi: Journal of Mobile Culture* 7:1 (2013). <http://wi.mobilities.ca/commented-city-walks/>
- Varagnoli, Claudio. "L'Aquila, dieci anni di ricostruzione." *Opus*, 3 (2019): 3-4.

Photographic Driftings as a Method to Intercept the Atmosphere of the Sprawlscape

Walking Exploration of the Ring Road Around the City of Cagliari

Martina LOI¹

Abstract. Urban strolls allow to intercept the atmospheres of a space, mediating between the moving body and the context. With a situationist approach, I carried out an exploration of the sprawlscape along the SS554, the urban motorway connecting Cagliari (Italy) and its surrounding centers. The contexts I met, a particular fusion of rural and urban, are considered marginal and degraded compared to the city, thus the choice of exploring on foot, driven by the difficulty that these spaces pose to walking and the possibilities it allows to explore spaces atmospherically. The stroll was integrated by a photoreport called « flat-shades » : photography is a useful medium to explore and interpret the atmosphere of a space, and it allows the (re)presentation and sharing of this personal perceived atmosphere.

Keywords. Urban Motorway, Walking, Visual Methodologies, Photography, Fieldwork, Atmospheres

Introduction: Walking as a Way of Knowing

When thinking about walking, it's easy to figure different activities, all extremely familiar and functional to the performance of daily practices. But we rarely pay attention to the act of walking itself; it is such a naturalized gesture that it is not obvious to be aware of it. But when one pays attention to those automated gestures and regains awareness, walking shows itself as a practice of extreme complexity and requiring great coordination between body movement, sensory perception, kinesthetic, etc., resulting in a “socio-technical assemblage of embodied, material and technological relations” (Middleton, 2010).

The continuous relation and interaction between the moving body and the space it passes through makes walking trace and define a place through the track left by the moving body and the memory of its own movement. In route, the city is continuously “acquired” in a glance and its surroundings are synthesized in and through the body. In this sense, the urban stroll is the simplest and most direct tool to learn, know and tune in to the environment around us and at the same time question the rigidity of political and social boundaries (Macauley, 2000).

While walking, a “continuous stream of ‘information’ parading past and through us [...] loosens, unties and releases the mnemonic knots in the body, triggering an active engagement with the places through which we walk” (ibid.).

In the same way, atmospheric perception is direct and ambulatory, kinesthetic and affectively involving, synesthetic or at least polymodal, but above all it is to make something present with the help of the body (Griffero, 2017).

1. Università degli Studi di Cagliari - DICAAR, Italy, martyloi93@gmail.com

With these premises I carried out a work of atmospheric and walking exploration of the peri-urban context of a high-traffic road and the neighborhoods directly connected to: particular spaces, significant and/or to be (re)defined, thanks to the ability of walking to configure itself as a transformative practice, in which the moving body and spaces are constantly combined revealing the diverse dimensions of urbanity.

Case Study: Walking Exploration of an Urban Motorway

The work is situated in the history of walking as “symbolic, political and aesthetic practice” (Wiley, 2010), as stated by Situationists (Debord, 1956) and philosophers such as Michel De Certeau (1984). The now classic practice of drifting has been adopted by SI as a method “which could sustain a sensitivity to the city’s unconscious while also achieving a heightened political intentionality” (Wiley, 2010). With a less artist-activist approach, De Certeau considers the daily resistance practice of walking as an unstoppable urban force capable of redefining the urban fabric thanks to human action, converting the property value of urban space into use value.

Working on spaces designed for vehicular traffic poses several questions regarding the presence of pedestrians and the ability of these contexts to facilitate or hinder the use on foot. Unlike in a car, there are spaces where the pedestrian is even seen suspiciously, as a stranger or out of place, spaces where “the high-way of the speeding car is contrary to the low-way (and slow way) of the sauntering walker” (Macauley, 2000). Precisely for this reason I carried out an operation of overcoming the limits placed on walking, in the attempt to redefine and re-interpret these marginal contexts.

Roads are devices made to manage traffic in the urban area, but they also recompose spatial balances and with these the social, political and economic ones, configuring new forms of power(s) (Easterling, 2014). Infrastructure could be seen as dense spatiality, socio-technical systems and political devices (Tonkiss, 2013; Amin and Thrift, 2017), and they show both a political and a poetic aspect (Larkin, 2013), configuring themselves as proper places (Amin, 2014) and not only in relational terms (marginal, peripheral, suburban).

Following the example of the Stalker collective, which explored the “current territories” in their *transurbances*² and the exploration that Iain Sinclair carried out around the London Orbital (2003) in which “walking around the M25 turns into an existentialist pilgrimage, and the circularity of the route becomes a metaphor of its meaninglessness” (Ballantyne, 2006), I carried out a similar experiment, trying to experience and bring to light the atmospheres (in the interpretation of Griffero (2017) for which they are affective and embodied feelings aroused by external situations) of the multiform and apparently banal spaces born and grown up around the SS554, the road that runs tangentially to the metropolitan city of Cagliari for about 15 km and gathers the 450.000 inhabitants of the 17 municipalities that constitute it.

The construction of the road meant that a new portion of space was connected to the city, resulting in investments and an urbanization of the area. The peri-urban agricultural fabric has progressively been saturated, in a manner that is typical of the Mediterranean suburbanization (Leontidou, 1993): left to the informal initiative of small groups; with a great hybridization and the lack of a unitary regime of territorial management. The result is a fabric apparently unresolved, partly abusive/informal/spontaneous, and in any case urbanized according to Soja’s post-metropolis (2000): a

2. See at: <http://www.osservatorionomade.net/tarkowsky/manifesto/manifesting.htm>

city no longer understandable with classical urban growth models, with a progressive erosion of the border between urban and rural, and an urban form with a high density of flows, which raises new questions about spatial justice.

The choice to explore on foot the contexts is dictated precisely by the difficulty that these spaces pose to walking and at the same time, the potential that this practice offers to immerse oneself in the atmosphere of a space, narrating thus the self (Wylie, 2005) and recognizing the space an ontological status of its own. Not only, according to the Situationists, the drift around and through the city represents a political statement against rational, ordered, capitalist urban space (Middleton, 2010). This is even truer in the case of a car-oriented context as the one on the edge of an urban motorway.

The SS554 area is made up of very different contexts, which have been explored at different times, according to a completely arbitrary choice criterion, starting from virtual explorations or based on what I have encountered on previous occasions. Together with the walking exploration, I equipped myself with a camera, with which I took a series of photographs, collected in a report that I called *tintepiatte* (literally “flatshades”).



Figure 1. An extract of the photographic report, Martina Loi, January 2020

The photographic report is an attempt to collect and narrate atmospheres: through the use of photography I would like to try to re-signify the infrastructure and de-construct the paradigm of marginality usually associated with new interpretations and meanings. Photography and visual methodologies allow to explore, interpret and represent landscapes, urban forms, architectures, in a way that requires a situated and embodied work that can't avoid the deep interaction with the context. Photography makes possible to carry out a geo-ethno-graphic work of exploration of little-known contexts, to relate oneself with seemingly banal micro-landscapes and spaces, to

provide innovative and creative readings of them and to contribute to their potential re-significant interpretation.

The explorations that have been made and the subsequent reflections have made it possible to highlight some aspects of these contexts that I would like to put in evidence.

The first aspect that can be highlighted is the process at the base of the genesis of this *undecided* urbanity: the urbanization occurred with a great fragmentation and had as a consequence the creation of a large number of residual spaces and the general impression of neglect and incompleteness. But one element of great interest is how, even in informality, there is no escaping from already existing urban models that are reproduced, as if the building ideology that characterizes our suburbs, has been (unconsciously) introjected and is repeated even in the absence of regulations; anyway there is no lack of independent and extremely localized modalities, leading to different situations, to practices of use of space proper to that context and to differential narrations, both in relation to the context and to the “central” city.

This led to a situation in which it is not possible to account of a unitary or homogeneous context, characterized by elements in relation and a coherent development. Although it is a relatively limited stretch, along the route we are faced with extremely different situations, with a great mixture and a high degree of variation. Within a few hundred meters it is possible to move from agricultural contexts to industrial areas to single-family villas districts. This variation is constant and almost always occurs without caesuras or traumas, as if hybridization was the vocation of these spaces.

They are quite well known for those who frequent the city of Cagliari, on the one hand for the commercial functions that are found there, on the other for the fame of marginality and degradation that is associated with them. Exploration has allowed me to try to deconstruct this paradigm, trying to act without prejudices and expectations and immersing myself in space, letting me get enveloped by the atmospheres and bringing back some of these clues in the photographs.

The spaces thus approached have shown a character and a vocation of their own. Yes, they are spaces left a bit to themselves, result of individual initiatives and without a unitary plan, but for this very reason they distinctly bear the mark of its inhabitants and show a particular mix between urban and rural, between city and countryside, which is perhaps the most fascinating atmospheric component and that can explain the rise of this part of the city. The passage from one area to another is constant and without traumas and it is exciting to immerse oneself in this building and urban freedom, collect fragments of shapes and colors, take some notes and continue to explore. The small residential neighborhoods are all similar to a generic mid-range single-family district, but here too there are many variations and every single inhabitant has tried to personalize his or her own small domestic space, disregarding the paradigm that depict this urbanity as characterless and strongly degraded.

Conclusions

The work carried out, of course, is not intended to be definitive and decisive, but is a circumstantial and instinctive collection of spatial elements, aimed at highlighting some atmospheric characteristics of that space, not always evident in everyday practices.

During the explorations, it was possible to experience the spaces in a new way compared to what can be done in daily practices. The approach I adopted is deliberately personal and instinctive: I avoided doing preliminary research and I let myself be inspired and enveloped by the context and the sensations that the spaces communicated to me (McCormack, 2018).

With the help of the photos I was able to frame some of these urban moments, highlighting their forms, construction methods and relationship with the context. In this way the exploration was not limited to my current experience, feelings and memories, but it was possible to share it and make it present even to those who have not made the exploration themselves, but can benefit from the fragments that I have collected and that try to account for all these ineffable sensations. The experience itself, when the exploration is accompanied with photos, is modified. The decision to take a photograph requires a cognitive act, thanks to which I decide to stop, choose the point of taking, set all the parameters and take the picture. It very slows down the exploration, but in the same way it dilates it and allows me to realize many more aspects: I dwell on the light, on the way it enhances the forms and in a certain sense this approach amplifies the whole experience.

In the same way, walking, with all that it requires and involves, radically changes the enjoyment of a space. Through the feet you can measure distances on the body; spaces are reached after a movement that is always relevant and changes every perception; every element encountered is somehow recorded and participates in the experience, cognitively or not.

The union of the two practices therefore contributes to making apparently banal and daily activities (as an urban stroll can be) definitely significant for those who perform them, allowing to acquire new and different awareness of spaces and urbanity (whether known or not), immersing oneself totally in their atmospheres and also producing visual products that somehow participate in highlighting some of these significant fragments.

References

- Amin, Ash. "Lively Infrastructure". *Theory, Culture & Society* 31, n. 7-8 (December, 2014): 137-61. <https://doi.org/10.1177/0263276414548490>.
- Amin, Ash, e N. J. Thrift. *Seeing like a city*. Cambridge, UK; Malden, MA: Polity, 2017.
- Ballantyne, Andrew. "London Orbital Chris Petit Iain Sinclair London Orbital: A Walk around the M25 Iain Sinclair". *Journal of the Society of Architectural Historians* 65, n. 2 (June, 2006): 288-90. <https://doi.org/10.2307/25068270>.
- Certeau, Michel de. *The Practice of Everyday Life*. Berkeley: University of California Press, 1984.
- Easterling, Keller. *Extrastatecraft: the power of infrastructure space*. London; New York: Verso, 2014.
- Griffero, Tonino. *Atmosferologia: estetica degli spazi emozionali*. Roma: GLF editori Laterza, 2010.
- Harvey, David. *Consciousness and the Urban Experience*. Studies in the History and Theory of Capitalist Urbanization 1. Oxford: Blackwell, 1985.
- Larkin, Brian. "The Politics and Poetics of Infrastructure". *Annual Review of Anthropology* 42, n. 1 (October 21, 2013): 327-43. <https://doi.org/10.1146/annurev-anthro-092412-155522>.
- Leontidou, Lila. "Postmodernism and the City: Mediterranean Versions". *Urban Studies* 30, n. 6 (1993): 949-65.
- Macauley, David. "Walking the City: An Essay on Peripatetic Practices and Politics". *Capitalism Nature Socialism* 11, n. 4 (December, 2000): 3-43. <https://doi.org/10.1080/10455750009358938>.

Middleton, Jennie. "Sense and the City: Exploring the Embodied Geographies of Urban Walking". *Social & Cultural Geography* 11, n. 6 (September, 2010): 575-96. <https://doi.org/10.1080/14649365.2010.497913>.

Sinclair, Iain. *London Orbital: A Walk around the M25*. London; New York: Penguin, 2003.

Soja, Edward W. *Postmetropolis: critical studies of cities and regions*. Malden, MA: Blackwell Pub, 2000.

"Stalker through the actual territories." Accessed June 18, 2020. <http://www.osservatorionomade.net/tarkowsky/manifesto/manifesting.htm>

Tonkiss, Fran. *Cities by Design: The Social Life of Urban Form*. Cambridge: Polity Press, 2013.

Wiley, Danielle. "A Walk About Rome: Tactics for Mapping the Urban Periphery". *Architectural Theory Review* 15, n. 1 (April, 2010): 9-29. <https://doi.org/10.1080/13264821003629220>.

Wylie, John. "A Single Day's Walking: Narrating Self and Landscape on the South West Coast Path". *Transactions of the Institute of British Geographers* 30, n. 2 (June, 2005): 234-47. <https://doi.org/10.1111/j.1475-5661.2005.00163.x>.

09

PHYSICAL/DIGITAL SPACES COLLISIONS. SO WHAT?

10

PRESENCING ATMOSPHERES

11

SENSE AND SENSIBILITY OF AFFECTIVE ATMOSPHERES

12

SENSITIVE SPACES AND URBAN PRACTICES

13

SENSORY EXPERIENCE, ENVIRONMENTAL
EXPERIENCE, POLITICAL ENGAGEMENT

Sense and Sensibility of Affective Atmospheres

Session 11 – Introduction

Andrea JELIĆ¹,
Aleksandar STANIČIĆ²

The aim of this thematic session is to bring in different disciplinary and methodological perspectives on affective atmospheres to examine the underlying, intertwined processes of sensing as sensibility (i.e., feeling, experiencing) and sensing as sense-making (i.e., understanding, conceptualizing, meaning making). Recent affective and ‘more-than-representational’ turns in the scholarship and praxis, particularly visible in design of heritage architecture and places of memory, has emphasized the potential of affective and embodied experiences to act as a medium in production and communication of meaning. Such approach to creating interactive spaces assumes a negotiation between the processes of experiencing affective atmospheres and conceptualizing meaning, shaped by the broader socio-political context.

By considering the notion of affective atmospheres in spaces of heritage (and beyond), we ask what is the relationship between sense and sensibility? How can we investigate with different disciplinary and cross-disciplinary lenses - such as architecture, cultural geography, philosophy, cognitive science - the links between these two modes of sensing? What are the possibilities of a range of methodologies and tools - from ethnography to measuring physiological responses, from lived to simulated realities and other phenomenographic representations of atmospheric worlds - for understanding the ways in which we feel and think affective atmospheres? In what ways are sense-making and sensibility affected by the various socio-political factors and multiple stakeholders’ positions? And finally, what are the implications of understanding sense and sensibility of affective atmospheres at individual and collective level for creating a shared sense as a common ground for co-habitation in the future?

The seven papers gathered in this session demonstrate the plurality of approaches through which the question of sensing - sense-making, feeling - thinking affective atmospheres can be investigated. This plurality is particularly visible in the range of methodologies used to capture and describe the affective layer of spatial experiences, including variety of ethnographic research methods, creative participatory workshops, exploratory bodily performances, commented urban walks, questionnaires capturing affect and spatial qualities, among others. Such richness of employed methodologies allows us to examine affective atmospheres and their spatial situation at different scales and levels of detail - from individual’s experience and the role of affect in personal (body) identity, through individual’s relationship to space (built or virtual) to

1. Aalborg University, Denmark.

2. TU Delft, Netherlands.

one's relationship to other individuals and the shared meaning as a product of communal practices and spatial choreographies. At the same time, based on the main focus of their explorations, the gathered contributions can be divided in two sub-sessions: first, centered around the role of different subjectivities in experience of affective atmospheres in architectural and urban settings, and second, centered around the role of the medium for representing and importantly, creating affective atmospheres.

Sub-Session 1

The subject and the affectivity of atmospheric spatial situation. The first set of papers by Christos Kakalis (1), Alice Salimbeni (2), Nathalie Audas, Fanny Vuailat, Sandrine Depeau (3), and Anders Palstrøm (4) tackle the question of sense and sensibility of affective atmospheres through exploration of different stakeholders - of different subjects' perspectives. In his paper "Atmospheres of Transformation: Language, Identity and the Liturgical Experience of a Transborder Orthodox Community," Christos Kakalis examines the rich tapestry of soundscapes and spatial experiences underlying the atmosphere of transborder liturgies. Here, the normativity of religious building typology and of the language of liturgical texts and practices is challenged through the more organic, transborder ritual choreography as the "living architectural brief of liturgical architecture." The diversity of liturgical texts and languages, manifested as soundscapes, becomes the atmospheric medium of shared practices and shared belonging. Second contribution "Atelier de la traversée: A workshop to reflect on a possible mediation between affective and political atmospheres" by Alice Salimbeni focuses on exploring the affective and the political aspect of women's urban experiences and how the two are intertwined in their everyday experiential encounters with the city. Through creative workshop activities and variety of mediums, the paper discusses the capacity of atmospheric spaces to accommodate the projection of individual's identity as an important factor in understanding the conditions of spatial inclusion and exclusion. Nathalie Audas, Fanny Vuailat, and Sandrine Depeau in their paper "Ambient outlines of children's urban experience: A look back at an interpretative methodology" bring forward the study of affective dimension of children's daily urban experiences by addressing the methodological challenges in working with children. Through a novel methodology that includes commented urban walks, inter-subjective listening (of the walks' recording) and interpretative writing (ambiance storytelling), they emphasize not only the possibility of capturing the sensitivities of children's experiences but also provide insight into how the atmosphere of these urban experiences is affected through child-researcher relationship. The final work in this sub-session by Anders Palstrøm "Atmosphere, resonance, and immanent transcendence: Rethinking the aesthetic experience as a threefold" rounds up the discussion on a more philosophical plane by examining the threefold structure of aesthetic experience as a way to account for a variety of our sensitive aesthetic experiences in atmospheric situations—some being mainly affective, others mainly resonant, and others deeply meaningful in a more cognitive sense. The contributions in this sub-session show the fundamental relationality between the subject and space; how this relationship questions the affective atmosphere and changes the feelings and sense-making of spatial settings depending on the subjectivity of the experiencing body - whether it is a woman, a child-researcher dyad, or a transborder religious community.

Sub-Session 2

The medium and tools in experience and creation of affective atmospheres. The second set of papers by Katarina Andjelković (5), Vahid Vahdat and Judy Theodorson (6), and Rikke Munck Petersen (7) explores the role of the medium - images/panoramas,

virtual reality, and drone footage - in representing as well as in creating affective atmospheric experiences. In her paper "Through the ambiguous objects of Benjaminian thought: Politics and affect in design of heritage architecture," Katarina Andjelković argues for the potential of panoramic image to recontextualize architectural atmospheres, and especially to challenge our linear perception of time - when joining past and present representations of the same object. The contribution by Vahid Vahdat and Judy Theodorson "Ambiance Production in Virtual Interiors: Engineering and Assessment of Affective Response in Design Studio Projects" demonstrated how virtual reality technology can be used in design studios to eliminate "outside sensations" - such as structure, program, climate, gravity, materiality - and place affect production at the center of the design process. The work of Rikke Munck Petersen "Ethics of the unseen: Extended sensibility and affection in drone film post-production editing" discusses how the interplay of vision, rhythm, and sound in drone filming and post-production editing produces the effect of "extended sensibility." The papers presented in this sub-session show how the mediatic tools we use can help us extend, enhance, and understand reality and the sense of self, and most importantly for the goals set before this session, how that knowledge can be further applied in actual design, understood here as the process of active creation of meaning.

One of the main goals of this thematic session is to explore the ways in which the meaning (sense-making) - individual and/or shared - can emerge from affective experiences and sensations, language (sounds and texts) included. However, as demonstrated in paper by Christos Kakalis, this is only possible when we all understand (and share among ourselves) the basic meaning behind the words we use, and this of course applies to describing places and atmospheres. As rightfully noted by one of the contributors, we are indeed operating in a complex and somewhat vague field of atmospheres, which more often than not escapes precise definitions. In words of Confucius, "If language is not correct, then what is said is not what is meant; if what is said is not what is meant, then what must be done remains undone; if this remains undone, morals and art will deteriorate; if justice goes astray, the people will stand about in helpless confusion. Hence, there must be no arbitrariness in what is said. This matters above everything"³. Taken together, these papers demonstrate the essence of language as a medium in experience and research: even when trying to explore the 'non-verbal' layer of affective experiences, it is the language that becomes the medium of sense-making between affect and space.

This poses a question of how we can enter into a productive conversation between these different approaches - methodologically as well as disciplinarily - if we are to systematize and develop recommendations for architects and urban designers. How can we be even more rigorous in the language, terminology, and concepts that would allow us to clarify the implications of affective atmospheres for design? Without forgetting the multiplicity of stakeholders' agency, we ask how the agency of a designer, clearly expressed in sub-session 2, is to be negotiated with the intrinsic relationality between the subject-and-atmospheric space, as shown in the first set of papers? Consequently, what are the ethics of atmosphere/sensation manipulation, especially in (teaching) design studios or other design practices? These are some of the open questions we look forward to addressing during the conference discussion.

3. *The Analects of Confucius, Book 13, Verse 3, translated by James R. Ware, 1980.*

Through the Ambiguous Objects of Benjaminian Thought:

Politics and Affect in Design of Heritage Architecture

Katarina ANDJELKOVIC¹

Abstract. There is a poetic force initially created by a desire to recontextualize the image of war through architectural atmospheres enabled by panorama². This research reconstructs and deconstructs discourses that understand architecture as affect, but also illuminates the narrative approach with the aim to speculate experience of affect as meaning making in design of heritage architecture. By inscribing heritage architecture into the register of ambiguous objects of Benjaminian thought, I will contemplate the Gaza war case (2014) and the Böttcherstraße project in Bremen (1922-1931).

Keywords. *Heritage Architecture, Dialectical Image, Affect, Historical Experience*

Introduction

“It’s not that what is past casts its light on what is present, or what is present its light on the past; rather, image is that wherein what has been comes together in a flash with the now to form a constellation”
 (“Awakening,” Walter Benjamin’s Arcades Project, 1927-1940)

In his writings, Walter Benjamin (1892-1940) introduces the dialectical image as part of the description of a radically alternative conception of time and of historical experience. Adopting the dialectical image as a method for distancing an image from the reality it represents, we can observe how our experience of the (history of the) war is conditioned through images. In this paper, I ask if Benjamin’s method can become a mechanism for rejecting any emphatic representation of the war. To be able to do that, I will start by investigating Benjamin’s dialectical image as a method for enabling ‘affect’. The dialectics will be addressed through a two-fold viewers’ reception: 1) image of the past - photographs made during the war as places of memory and which serve for contemplating past events in relation to their historical outcome; 2) image of the present - panoramas made for contemplating past events and their historical outcome in the present. In other words, affect - as the most *immediate response the viewer* experiences when reading dialectics in panoramas and photographs - will lead the past to bring the present into a critical state. Using this method,

1. Atelier AG Andjelkovic, Sindjeliceva 25, 11000 Belgrade, Serbia katarina.code@gmail.com

2. Panorama offers distant views in form of a 360-degree continuous viewing experience, to reflect on the modifying perception of space. It uses its properties to transport past into present, to abolish the feeling of linear duration. What if panorama, which is fundamentally atmospheric rendition of distant spaces, introduces the atmosphere of time through the presentation of the unexpected?

I will demonstrate how the power of affect to bring together a dialogue between past and present can be applied in design of heritage architecture.

Image of the Past

Photographs made during the war serve for contemplating past events in relation to their historical outcome. Vast body of images taken during the war events enter the public discourse. Taken in different times and places, in different resolutions and representations, these photographs form a critical pile of a thousand of viewpoints from not only professional journalists but also from ordinary observers. Instead of allowing interpreters to see the war first hand and thus help them clarify the historical narrative, these photographs lack the means to directly illustrate the events whose course and features they depict. Omitting more than they can possibly include, their frames constrain perception to expose the weakness of the critical tools with which these historical images are comprehended. As a result, the image is distanced from the reality it represents and histories it narrates. They make photograph a visual language that exposes a dialectic feature through the layers of time. Mediating between the past and the present in order to unravel the course of history, it is the concept of *dialectical image* that distances the image from the reality it represents to rather confuse the historical narrative. Observed through the nineteenth century Benjaminian lens, things were coming to seem more entirely material than ever and, at the same time, more estranged. And from the historical materialism perspective, which cuts through historicism, the true picture of the past fits by. The past can be seized only as an image which flashes up at the instant when it can be recognized and is never seen again (Benjamin, 1968). For every image of the past that is not recognized by the present as one of its own concerns threatens to disappear irretrievably (ibid., 1968).

In the “phantasmagorical” tone of *Passagen-Werk* (The Arcades Project, 1927-1940), Benjamin documented in an extremely detailed and precise manner the scene of revolutionary change that was the nineteenth century. Moreover, his discussion offered the description of a radically alternative conception of time and of historical experience. Dialectical thinking required operation through the juxtaposition of different stances, most notably, a thesis with an antithesis. The product of their synthesis could become a new thesis. As a thesis, Benjamin put that the arcades of 19th century Paris present residues of a dream world and temples of commodity capital (Benjamin, 2002). As an antithesis, Benjamin put that the desire for arcades is lost in the early twentieth century under the onslaught of modernism. Namely, critiquing the bourgeois experience of nineteenth-century history, Benjamin suggested that we can recognize the suppressed “true history” that underlay the ideological mask in the arcades. What is normally meant by progress, through these monuments of the bourgeoisie becomes a ruin. As a synthesis, the arcade represents a dialectical image: the picture of “the dialectic at a standstill that brings together the present with a past wish or dream in an image to make possible the (revolutionary) experience of a historical truth” (Missac, 1995). Benjamin’s dialectical image is far from the linear progress of time and differs in an attempt to withhold the dialectical contradiction at the moment in the form of a visual image or object, instead of developing arguments over time: “dialectics at the standstill creates an image” (Tiedemann, 2002).

In the manner of Baroque drama of the nineteenth century, melancholic reflection on the transience of human and materialistic existence turns the dialectical image into politically instructive concept. Benjamin hoped for a shock from the recognition offered by the dialectical images, as he believed that every epoch precipitates the

awakening of a political collective. For Benjamin, the key quality of dialectical images is the ability to “shock.” The dialectics affect both the content of the tradition and its recipients. As the most immediate response the viewers experience when reading dialectics, affect appears to be a way to neglect usual mode of thinking, as thinking means not only establishing a causal connection between things but also “where thinking suddenly stops in a configuration pregnant with tensions, which gives it a shock effect” (Benjamin, 1968). Benjamin’s aim was to juxtapose disparate fragments of historical experience and freeze them in a suspended historical constellation that he called a *dialectical image* (Cvoro, 2008), enabling it to become a method for inducing affect. The image functions as a standard for estimating significance of historical reality, i.e. the way of thinking about the issues of time and experience through visual, material, and spatial registers. As such, the dialectical image method is well aligned with contemporary architectural design practice which tends to reach the world of the senses, and which is governed through the experience of the image. Likewise, Benjamin’s dictum “history is broken down into images” gives past a new meaning: it excavates the past to shake up the present. This method of the dialectical image through affect is generated as a modern reaction against the representation of the nineteenth century ‘commentary on a reality.’

Image of the Present

To pursue dissecting this ‘commentary on a reality,’ *panorama* will be revealed as a method for contemplating past events and their historical outcome in the present. In other words, affect - as the most immediate response the viewer experiences when reading dialectics in panoramas - will lead the past to bring the present into a critical state. In this way, the panorama image depicts not only a representation of objects or events, but rather material replicas of objects and situations. In this case, remote sensing the political background of reality. This method is seen as a way to contemplate past events in relation to their historical outcome, enabling panorama to show its deeper political manifestations in an artistic format. In addition, it introduced “a new standard of evidence” as an opportunity to better understand how society’s political processes in each era decisively influence the type and use of representational agendas of the architectural heritage.

This is visible in contemplating Gaza today, in the recontextualization of a war narrative through the prism of panoramic image. The procedure draws from the basic function of a panorama to contemplate inaccessible locations in a way to transport historical events into the image, and capture them for the re-examination at some other time. In the case of Gaza, the panorama maps past events and raises the question of the political connotation of war, hypothesizing that whoever wins the battle of media determines history, i.e. controls the way we perceive the past. Namely, the case of panoramas today makes it possible to reveal the space consisted of numerous images it integrates and therefore to come closer to the reality, if not truth. Thus, it triggered the re-examination of what is incomprehensible and intangible for the recipient, which exists in as many versions as there are participants, and what is now open to further contemplation, negotiating that coming closer to the reality of the war event is possible exactly by visual means.

London-based research unit Forensic Architecture was recently hired to undertake spatial and media analysis to clarify the historical narrative around the Gaza war, in particular *The Image-Complex* from “Rafah: Black Friday” case (2014). In a renewed attention to informational modes and models, as David Joselit has pointed out, contemporary visual culture “shifted from object-based aesthetics in both architecture

and art to a network aesthetics premised on the emergence of form from populations of images,” which constitute “dynamic mechanisms for aggregating content” (Joselit, 2013). In light of this trend, further reflection on the Gaza war was no different: it took shape based on hundreds of videos and images produced during these events. Namely, the project aimed at locating and reconstructing the story of events in Rafah, Gaza, that took place on the first of August, 2014, by using hundreds of images and video clips existing in disparate locations, on the smart phone of the activists, press and social media posts (Varvia, 2018). The assemblage of evidence (photos of witnesses to those events) were analyzed to establish the perceptual field of each of hundreds of images. By framing the scene, the photograph puts limits to our field of perception and thus becomes the first parameter distancing the image from the reality it represents (Varvia, 2018). In this context, the role of panorama is to replace a single photograph by putting all data around the historical narrative into one view. This is in accordance with the way human perception functions: it blends images together through time (Deleuze, 1986). Accordingly, image creators are operating in the panoramic format to narrate historical events in spatial and temporal terms, and to reconstruct space from the image. In comparison to the limited use of photographs in preservation, conservation, restoration and reconstruction tasks, the panorama image can stand as an image that was crafted to help us understand the whole sites instead of a single building. Diverting from the traditional forms of visualization, these images will offer observation and visual communication of scientific evidence in a way to address the whole heritage sites in a wider perspective. Moreover, the panorama image helps us contemplate past events in their historical outcome in the present, in order to establish a dialogue between past and present in the process of creating an agenda for the protection of heritage architecture. As such, panorama image can be used as a basis for future heritage actions in a broader cultural, political and aesthetic context.

The Continuum Past-Present in Heritage Architecture

However, the instrumentalization of affect for creating new representational agendas has established a critical position in design of heritage architecture. It opened a remote sensing the political background of reality to further contemplation only at specific points, i.e. dialectical images. To realize current tendencies, architecture seeks to renew the means of conceptual thinking by using the dialectical image as a method. One of the most prominent examples, Böttcherstraße in Bremen (fig. 1), is a rare architectural ensemble belonging to a variant of the expressionist style. Böttcherstraße gives the impression of a “walkable sculpture” unrolling a line of buildings and artistic works on the façades with many important contributions to the preservation of the street before and after the Second World War. Namely, the layers of the façades are inverted contrary to the time logic of their formation, so that the first layer we see on the surface is the oldest layer of the façade. Searching for the past that will “shake up” the present, the observer is exposed to an image that does not represent reality. On the contrary, by examining the way of thinking about issues of time through visual, material and spatial registers of heritage architecture, the dialectical historical vision - in which the perspectives of past and present would mutually inform each other - becomes the standard for assessing historical reality. In this way, experiencing the concrete material forms of the past in the original façades is juxtaposed with the changes brought about by the present, in a way that this architecture constantly actualizes the past by renewing its meaning. In conclusion, allowing us to construct an affirmative understanding of fragmented images from the past-present continuum, Benjamin’s method demonstrated the power of affect to bring together a dialogue between past and present, as a critical potential in design of heritage architecture.



Figure 1. Example of a panorama image: Ludwig Roselius with architects Eduard Scotland, Alfred Runge and Bernhard Hoetger, Böttcherstraße in Bremen (1922-1931) © <http://www.boettcherstrasse.de/architektur/>

References

- Benjamin, Walter. *Illuminations*, 155-200, 255. Translated by Harry Zohn. New York: Schocken Books, 1968.
- Benjamin, Walter. "Paris, Capital of the Nineteenth Century." In *Rethinking Architecture: A Reader in Cultural Theory*, edited by Neil Leach, 32-34. London and New York: Routledge, 1997.
- Cvoro, Uros. "Dialectical image today." *Continuum: Journal of Media & Cultural Studies*, Vol. 22, No. 1 (February 2008): 89-98.
- Deleuze, Gilles. *Cinema 1: The Movement-Image*. Translated by Hugh Tomlinson and Barbara Habberjam. Minneapolis: University of Minnesota Press, 1986.
- Joselit, David. *After Art*, 43-55. Princeton: NJ Princeton University Press, 2013.
- Missac, Pierre. *Walter Benjamin's Passages*, 112. Translated by Shierry Weber Nicholson. Cambridge, MA: The MIT Press, 1995.
- Tiedemann, Rolf, ed. *The Arcades Project: Walter Benjamin 1927-1940*, 37, 929-945 (originally published in: Benjamin, Walter. *Das Passagen-Werk*, edited by Rolf Tiedemann. Suhrkamp Verlag, 1982). Translated by Howard Eiland and Kevin McLaughlin. Cambridge, MA. and London, UK: The Belknap Press of Harvard University Press, 2002.
- Varvia, Christina. "On the Retrieval of Depth." *Perspecta 51: Medium, The Yale Architectural Journal* (2018): 45-60.

Ambiance Production in Virtual Interiors

Engineering and Assessment of Affective Response in Design Studio Projects

Vahid VAHDAT¹,
Judy THEODORSON²

Abstract. This pedagogy-based research was conducted through a design studio challenge in which students were tasked with the creation of virtual models that place affect production at the center of the design process. The raster-based environment of VR operated as a site, which permitted a momentary withdrawal from considerations of structure, program, climate, gravity, materiality, and even circulation. The elimination of obtrusive variables allowed us to effectively register the correlation between spatial qualities and affective properties. The aim of the paper is to 1) catalogue affective reactions to these highly abstracted virtual spaces; 2) register any possible consensus among multiple subjects; and 3) identify correlations between affective experience and spatial qualities.

Keywords. Affect, Interiority, Interior Design, Architecture, Virtual, Pedagogy, Language

Introduction

In this paper, we first develop a theoretical framework for discussions about affect in the built environment. This framework situates the spatial experimentations conducted by our students in their interior design studio. It also justifies the formalism and virtuality of the projects, by emphasizing the relevance of affect-oriented design in interior architecture. The second half adopts a descriptive and positivist tone to articulate the methods and results of students' experimentations on affect and how they contribute to the body of knowledge discussed in the first half.

While it has been more than a decade since the reemergence of architectural discussions about affect, theoretical musings about sensation as an architectural drive that can transcend cultural boundaries has a long history. Mitrovic (2009, 24) traces discussions about the sensorial properties of architecture back to Vitruvius. Di Palma (2016, 32) looks at the concepts of character and mood, which were subject of theoretical interest since the second half of the eighteenth century, as predecessors to affect. At the same time, Edmund Burke's conception of the sublime, and its later development by Kant, appeals to the romantics, as a way to discuss buildings "not so much terms of their fixed attributes of beauty but rather in their capacities to evoke emotions" (Vidler, 1994, 72).

The Affective (Re)Turn

To understand how affect was later abandoned from architectural discourse, and feeling of any kind became delegitimized as that which gets in the way of intellection, it is necessary to understand the linguistic turn (Rorty, 1967) and its effects on theories

1. Washington State University, Pullman, WA, vahid.vahdat@wsu.edu

2. Washington State University, Pullman, WA, jtheodorson@wsu.edu

regarding the built environment. The linguistic turn, as Mitrovic (2009, 21) explains,

that all thinking is always verbal and situated in language. If all thinking is always verbal, then it is impossible to think about the visual properties of objects; if it is impossible to think about the visual properties of objects, then one cannot ascribe aesthetic properties to objects on the basis of their visual properties, because one cannot think about these properties.

The domination of architectural theory by textual, symbolic, and iconographic approaches, especially since the 1980s, left little space for spatial and visual explorations of architecture and even less for aesthetic formalism. At the same time, however, new trends in cognitive psychology and philosophy paved the way for post-linguistic theories on the built environment. As early as the 1970s visual imagination assumed a respectable place in psychological research, while by the 1980s, arguments were made for the study of the human thought outside verbal form (ibid.).

The fact that the relationship between humans and their built environment was now understood to be beyond linguistic associations meant that aesthetic sensations can be liberated from rationalization. By operating through direct sensations rather than symbolism, “[affects] bypass the need for codification of language and are able to shift across space and time” (Moussavi and Kubo, 2006, 9). This post-linguistic shift entails that 1) there is no hidden message or an underlying meaning behind architectural affect, 2) affective experiences of the built environment (or any other object for that matter) are unmediated, and thus, 3) they are universal.

The claim of the timelessness and universality of affective experience is questionable. Objects and spaces do not inherently possess affective properties; historical and cultural contexts influence the sensate responses they temporarily host. A calming building may feel haunted at night, a sacred object may come across as entertaining or even comical in a different era or location, and an ordinary artifact might seem uncanny to even the same subject. In his study of uncanny or subliminal affect, Vidler discusses how the very definition of the sublime, as Burke devised, was based on experience rather than artifice. By replacing “uncanny” with “affective,” his articulation of the problem cannot fit this discussion any better:

If there is a single premise to be derived from the study of the [affective] in modern culture, it is that there is no such thing as an [affective] architecture, but simply architecture that, from time to time and for different purposes, is invested with [affective] qualities (Vidler, 1994, 12).

If a body’s engagement with the world, as Kraftl and Adey (2008, 215) suggest, “can engender almost limitless forms and exemplars of affect,” is any attempt to associate particular affective sensations to objects and spaces basically meaningless? And if within the world of human sensations, as Gage and Pita (2009, 8) imply, “there simply are no privileged viewers,” are all affective experiences equally valid?

Affect, Interiorized

To address these questions, it is no longer possible to evade a definition of the affective - especially one that is distinct from the sensorial. In contrast to emotions that is often assumed to function at intimate scales, the affective presents itself socially and relationally, as a force that propels the subject to feel, think, or act (Thrift, 2004, 64). Affect is thus neither an inherent quality of the emitting object nor an attribute of a single (human) subject; it is rather the property of relations, interactions, and

forces. By locating the affective in the relational, and by challenging the unidirectionality of the affective drive, the rigid subject/object distinction is also disturbed (Massumi, 2002). This understanding of affect as reciprocal, impersonal, and nonrepresentational has enjoyed a strong presence in the literature in the past few decades³. Yet, the integration of this subject in interior design suffers from a lack of systematic theoretical digestion. Theoretical attention towards affect in interior design can address concerns over the status of interior design as it remains overlooked under the hegemony of architectural design. Especially because, affect flattens the assumed hierarchy of interior/exterior by treating them as continuous, yet autonomous. Deleuze, for example, adopted Kant's "sense" of space but dissolved the inside/outside separation (Deleuze, 1997; Deleuze and Guattari, 1987; Flaxman, 2005, 177). In their discussions on affect, Moussavi and Lopez (2009) similarly aspire to a radical disassociation between inside and outside. The quasi-autonomy of interior in provoking an affective response allowed us to experiment with the interiority of 360-imagery with a methodic disregard to exterior considerations.

Methodology

The Pixilation of Affect

Aside from, and in parallel to, the "postlinguistic, postsemiotic" shift (Mitchell, 2002), three interrelated developments facilitated the (re)emergence of affect in spatial design discourses: 1) the introduction of digital media and the subsequent formal explorations (Mitrovic, 2009, 22), 2) intense globalization and its demand for universality (Di Palma, 33), and 3) the surge of "paper architecture" in the aftermath of the great recession.

This understanding that architectural experience is not necessarily tied to the built and that the aesthetic content of imagery, drawings, and even spatial imagination can invoke an affective response (Mitrovic, 2009, 23) permitted the design studio to function as a laboratory for affective studies. On the other hand, virtual reality (VR) technologies allowed the students to design - and the subjects (which in this case were the same group of students) to participate in - a more immersive experience of affect, especially when compared to flat environment of conventional renders. VR, in this context, was not treated as a representational technology that accurately mimics the built or replicates a yet-to-be-constructed. It was rather understood as a site, and therefore any design within this site was considered a product of an affect-oriented design process.

By assuming the properties of a site that has its own internal logic, very distinct from the physical laws of the external world, the virtual environment encouraged students to embrace the freedom to investigate space of an unfamiliar kind. The production of these alien interiorities was only conceivable through the digital means, which as discussed before, played an important role in the affective turn.

Affect Hunting

A total of 40 students from two sections of a 4th-year capstone interior design studio at Washington State University took part in this study. Through a deliberate disregard of programmatic, climatic, structural, material, and circulation considerations, each student was challenged to use design strategies as a means of generating profound

3. For a rather comprehensive list of literature in urban geography, sociology, psychology, and neuroscience that contribute to the discussion of affect, see Scheutz (2011).

spatial ambiance. Students were then directed to study the projects of their peers through 360-virtual renders and respond to a series of questions about affective categories for each design.

Many different affective categories have been identified in the literature. From back in mid-eighteenth century when Boffrand associated moods such as gaiety or sadness to building types and Blondel's categorization of moods into pastoral, naïve, frivolous, terrible, mysterious, dissembling, and vague (Di Palma, 2016, 32) to Moussavi and Kubo's (2006) affects of amorphous, scaleless, embroidered, luminous, camouflaged and Tomkins seven affects of excitement, joy, surprise, distress, shame, anger, and fear (Sedgwick and Frank, 1995, 10).

Yet, to ensure that the subjects of the study fully understood the affective categories, they were directly involved in identifying the emotional responses. The questionnaire was developed through multiple sessions of discussions with volunteered focus groups from the students. The final document comprised of 13 questions in four sections. The first section was a closed word choice for emotive response. It asked students to pick three to five words that best described their feeling in relation to the space, from a list of 18 affective qualities⁴. The participatory approach in generating a list resulted in categories that occasionally overlap, lack mutual inclusivity, and are not hierarchically equivalent; yet, the investment of the participants in the development of the categories created a sense of attachment to the study that invoked greater engagement.

In another section, we applied semantic differential. Using a slider, students determined the strength of spatial qualities from bipolar word pairs about space luminosity, color, order, form, familiarity, and enclosure. The other sections, including a five-point Likert Scale and open-ended questions were not used in the study. Aside from the quantitative study, the subjects were also asked to act as a photographer and take a snapshot from the parts of the 360-space they considered to invoke the most affective response. The affective parts of each project were thus registered through 40 still images, some of which strongly overlapped, while others were more diverse. This part of the study is not included in the results.

Results

The questionnaire documented the affective responses to each space based on the categories, while frequency of responses were registered for the intensity of the affect and consensus among participants. A Pearson Product-Moment Correlation Coefficient analysis was conducted to study the relationship between the affective categories and their association to spatial qualities⁵.

The results indicate a strong correlation (0.81) between fearfulness and intimidation of a space, and between peaceful and comforted spaces (0.84). Playful spaces show a strong correlation (0.83) with energized spaces and tend to be joyful (0.75). Stressful spaces are not calming (-0.92); they tend to generate the feelings of anxiety (0.82) intimidation (0.8) and they overwhelm (0.78). Confused spaces are uncomfortable (0.76); uncomfortable spaces make subject anxious (0.7). Feelings of anxiety (-0.7) and overwhelm (-0.78) have a negative correlation with calming spaces. Calming

4. These qualities were energized, intimidated, uncomfortable, welcomed, interested, comforted, confused, tense, overwhelmed, joyful, free, fearful, curious, peaceful, protected, playful, vulnerable, and cautious.

5. It is important to understand that 1) this is a pilot study and the results cannot be generalized until tested on a larger sample population and 2) correlations do not constitute causal relationships.

spaces correlate with comfort and peacefulness (0.85) and they are often welcoming (0.76). Welcoming spaces are comforting and peaceful (0.71). Welcoming and comforted spaces are not stressful (-0.75 and -0.76 respectively). Familiar spaces are more welcoming (0.74) and more calming (0.71) but free and open spaces are often not (-0.7). Colorful and playful spaces tend to be more energized (0.77 and 0.82 respectively). And, the less orderly a space is the more alien it appears (0.81).

Discussion

Given that a few of the affective categories semantically overlap, some correlations were only beneficial to confirm the validity of the survey. For example, the correlation between fearful and intimidating, peaceful and comforted, as well as playful and energized spaces. The synonymous/antonymous criteria were thus adopted as a measure to detect random responding and cleanse the survey for more accurate results. Yet, the fact that occasionally the correlations between similar (not synonymous) affects were not very strong (e.g. 0.7 between anxiousness and discomfort) speaks to the complexity of affective sensations.

While some of the results confirm the expectations that for example, colorful spaces tend to be more energized and familiar spaces are more welcoming and calming, others offered some original (and counterintuitive) insights into the discussion of affect. For example, that disordered spaces tend to appear unfamiliar and that free/open spaces often generate a sensation of discomfort and disorientation.

Finally, a statistical indifference between the spatial variables and affective ones were observed. This weak correlation between spatial qualities and their affective sensibilities confirms that affect is not a property of the object. Spatial features (e.g. size, proportion, color, light, and even geometry) may produce different and even contradictory affects.

Afterword

The affective (re)turn does not necessarily undermine the representational or the semiotic, but can rather add a non-verbal layer to design by privileging the sensate. The reintegration of discussions about affect into interior design theories would empower designers to embrace affective expressions, while being cognizant that affect evades a deterministic relationship with spatial quality. By liberating the interior from the hegemony of the exterior, theories of affect can contribute to interior design's disciplinary autonomy.

References

- Di Palma, Vittoria. "A Natural History of Ornament." In *Histories of Ornament: From Global to Local*, edited by Gülru Necipoğlu, Alina Payne, 20-33, Princeton, N.J Princeton University Press, 2016.
- Flaxman, Gregory. "Transcendental Aesthetics: Deleuze's Philosophy of Space." In *Deleuze and space*, edited by Ian Buchanan and Gregg Lambert, 176-187. Edinburgh: Edinburgh University Press, 2005.
- Gage, Mark Foster and Pita, Florencia. "The Zero Degree of Ideology." *Log*, 17 (Fall 2019): 7-8.
- Kraftl, Peter, and Adey, Peter. "Architecture/Affect/Inhabitation: Geographies of Being-In Buildings." *Annals of the Association of American Geographers* 98, 1 (2008): 213-31.
- Massumi, Brian. *Parables for the virtual: movement, affect, sensation*. Durham, NC: Duke University Press, 2002.
- Mitchell, William. *Picture theory: essays on verbal and visual representation*. Chicago, IL: University of Chicago Press, 2002.
- Mitrovic, Branko. "Architectural Formalism and the Demise of the Linguistic Turn." *Log*, 17 (Fall 2019): 17-25.
- Moussavi, Farsheed and Kubo, Michael. *The Function of Ornament*. Barcelona: Actar, 2006.
- Moussavi, Farshid, and López, Daniel. *The Function of Form*. New York: Actar, 2009.
- Rorty, Richard. *The Linguistic Turn: Essays in Philosophical Method*. Chicago: University of Chicago Press, 1967.
- Sedgwick, Eve and Frank, Adam. *Shame and its Sisters: a Silvan Tomkins reader*. Durham: Duke University Press, 1995.
- Scheutz, Matthias. "Architectural Roles of Affect and How to Evaluate Them in Artificial Agents." *International Journal of Synthetic Emotions*, 2,2 (July 2011): 48-65.
- Thrift, Nigel. "Intensities of feeling: Towards a spatial politics of affect." *Geografiska Annaler Series B* 86, 1 (2004): 57-78.
- Vidler, Anthony. *The Architectural Uncanny: Essays in the Modern Unhomely*. Cambridge, Mass: MIT Press, 1994.

Atmospheres of Transformation

Language, Identity and the Liturgical Experience of a Transborder Orthodox Community

Christos KAKALIS¹

Abstract. The paper explores the role of language in the constitution of religious atmospheres with special emphasis on architectural experience of a multi-national transborder Eastern Orthodox Community based in Edinburgh. Due to its performative and communicative dynamics, language plays an important role in the activities held in a religious place. The performative activation of religious texts through ritual choreographies, reading in different ways, singing and instrumental music is one of the defining spatio-temporal components of sacred architecture. In the examined case, the aurality of the text contributes to the emergence of a shared identity of moving populations having to settle at a new land based on a process of parallel or overlapping transformations.

Keywords. *Language, Atmosphere, Religious Place*

Introduction

It was Sunday, 1 November 2009, when I first visited the Orthodox Christian parish of Saint Andrew in Edinburgh. Having just arrived from Greece, my background had to do with domed churches, Byzantine chanting, rituals and services conducted in Greek. Entering a classroom of an old Parish School, I found myself in a totally different 'religious universe' from the one I was used to. It was a shock for me to see around sixty people of different nationalities celebrating the Divine Liturgy in different languages (mainly English, but also Greek, Russian and Rumanian) and the choir singing in a way that was reminding me the joyous songs of Greek children's instruction schools. Standing as a surprised observer, I could follow the ritual choreographies and define their pivotal moments through either the movements of the clergy or the use of Greek. While it took quite a few Liturgies to find my place in them, leaving this first service I had a weird sense that these very different people were feeling as one body.

Eleven years after my first visit there, I am writing this paper seeking to discuss the way religious atmospheres influence and at the same time are influenced by the repositioning of identity in transborder communities. The life of the multi-national Eastern Orthodox community of Saint Andrew in Edinburgh offers a unique example to unpack the spatio-temporal qualities of these processes. With a congregation of more than thirty different nationalities, the parish has been travelling through the city (since its establishment in 1948), appropriating and re-appropriating diverse spaces depending on its liturgical as well as community needs.

In this paper, I focus on the role of language in the making of inclusive religious soundscapes. Open to moving populations, the examined parish is a place of worship for

¹ School of Architecture, Planning and Landscape, Newcastle University, The Quadrangle, NE17RU, Newcastle upon Tyne, United Kingdom, christos.kakalis@ncl.ac.uk

groups of people that consider Christian Orthodox culture as part of a long-established collective identity (i.e. Russian, Serbian, Rumanian, Greeks) and converts that are recently received in its context (including a considerable number of locals). Using English as the main language for their services the examined community has been working on the creation of an inclusive atmosphere in which the linguistic translation of different parts of the Liturgy in different languages (including even Mandarin and French) is combined with its musical transcription in different notations and the performance of specific choreographies shared between different Orthodox cultures.

Standing between subjects and objects, atmospheres are of vital importance for the experience of the topos, synthesizing sounds, light, wind, incense, objects and human movements. Besides reading and chanting, religious atmosphere also includes a number of other sonic markers, as for example the ringing of bells. Based on formal ecclesiastical documents, the normative orchestration of religious atmospheres in Orthodox Christianity aims to offer a field of communal worship through rituals that are repeated strengthening the bonds between the members of the community. Focusing on sound, here I present a case in which interruptions of these normative atmospheres are not considered as dissonances, but as a part of an integration process in which worshipping inclusivity is practiced.

Performing the Text in Religious Architecture

In this paper, I argue that there are two different kinds of attunement of the religious atmosphere in the Orthodox Christian Church. On the one hand, there is this normative attunement that is based on formal documents that define the order of the services (*Typikon*)². Following established patterns and fixated traditions, this is usually the result of Synodical meetings and is published in books and distributed to the parishes annually. On the other hand, we will see here that there is also a more flexible, organic harmonisation of ritual ambiance that is based on the interpretation of the normative one. While respectful to the doctrine and theological connotations of the typikon, this order is characterised by a sense of controlled fluidity to respond to the needs of the parish in which it is performed. Here I present a rather unique case of congregation demographics that while not the only one, it is not a representative example of what we can consider as the mainstream congregation of an Orthodox church. In the case of Saint Andrew, the minority citizens comprise the majority of the population and the locals become one of the groups of it.

In Orthodox Christian tradition, art and architecture are parts of a liturgical act during which its different components are dynamically interconnected aiming to deepen the participants' embodied knowledge of the divine. For Nicoletta Isar, in this liturgical choreography, ritual movement, the devotees, and the sacred space (either built or part of the natural landscape) are united into "a living space of presence and participation"³. Therefore, a liturgical choreography is a living architectural brief by which the formation of religious architecture is fulfilled. This approach frees us from the need to think of a service only happening in a church building, as it is the movements in the space that perform the consecration of this place. It is not surprising therefore that Saint Andrew's community has used as a church an old Parish School building, a house, or a side chapel of the Episcopalian church of Saint Michael and All Saints without losing its worshipping identity.

2. Archbishop Job Getcha. *The Typikon Decoded. Orthodox Liturgy Series*. New York: St. Vladimir's Seminary Press, 2012.

3. Nicoletta Isar, "Chora: Tracing the Presence," *Review of European Studies*, 1:1 (June, 2009), p. 44.

Critically appraising Isar's theory, Bissera Pentcheva underlines the active contribution of psalmody and censing in a liturgical chorography of the church through the inscription of sonic boundaries and aural intermediate zones. Church buildings were gradually developed into an architectural typology to offer an active context of human liturgical movement. The centrally organized plans, consolidated as a common church pattern during the Middle Byzantine period with their vaulted surfaces and the carefully placed openings giving the devotees the opportunity to perform the Christian drama in a more effective way. Initially all the devotees and later the choruses representing them participate in the drama through responsorial or antiphonal chanting⁴. Sound is reflected on the concave surfaces and thus reverberated and amplified with the succession of echoes acquiring greater tangibility. Eastern Orthodox Church typology is still meant to fully accommodate the normative atmosphere, while in parallel allowing for more organic versions of it to be performed, space, time and people allowing; though limiting them by the unchanging built shell of its structure. The *typika*, institutional texts, have been translated into rituals, and the rituals have called for a built forum to surround them in a performative way.

Two main normative worshipping orders are amalgamated in the case of Saint Andrew, the *Typikon* of Constantinople (followed in Greek Orthodox Church and the areas under the Ecumenical Patriarchate) and the *Typikon* of Jerusalem (followed in Russia and other countries of the Balkans, such as Serbia). Different languages, ancient Greek and old Slavonic, as well as different musical styles, Byzantine chanting and Slavonic polyphonic liturgical singing, are combined to address the different backgrounds of the congregation. Achieving the organic orchestration of soundscapes involves a complex process of transformations of the texts that have to be used during the services. English is used as the main language of the services. Hence, ancient Greek and old Slavonic have been translated into English. All of the three languages are used during the services in a rather careful way, pointing out differences and similarities in performance.

As in the case of different liturgical traditions, the text is also transformed here through scores into to (a) chanting (antiphonic according to the Byzantine tradition and polyphonic according to the Slavonic tradition) conducted by the choir, (b) melismatic reading (something between singing and prose reading) conducted by the priest, the deacon or a member of the choir, as defined in the *Typikon*, and (c) prose reading, performed again by the priest, the deacon or a member of the choir. In addition to these normative transformations, language translations and transliterations have been also employed to meet the needs of the services of Saint Andrew. Finally, there is also a hybrid, and slightly complex, process of transcriptions from one musical notation to another (Byzantine notation to European notation and vice versa) happening in parallel with translations and prosodic adjustments from one language to another.

For this purpose, new 'books' had to be made. These were folders in which the services were transformed from purely ethnical into trans-national ones, through a careful collaging process that was initiated by the Priest in charge John Maitland Moir (1928-2013) and has been kept since then. These folders are big enough to be placed on the lectern for the choir, while in parallel and are considered as 'essential objects for the worship of a service'. The materiality of these books, already challenges established liturgical spatial typologies. The 'normal' size books for Liturgical use is not good enough to cover the needs of a community that is not fully attached to any

4. Bissera V. Pentcheva. *The Sensual Icon. Space, Ritual and the Senses in Byzantium*. Pennsylvania: The Pennsylvania State University Press, 2008.

of the cultures that are traditionally considered as “Christian Orthodox” ones.

For example, in one of the most characteristic spreads of these books, the book of ‘The Divine Liturgy’, we find the *Apolytikion* of St Andrew (the feastal hymn of the Saint) scored in three different ways: in European Notation and Latin alphabet, in European notation and Greek alphabet and in Byzantine notation and Latin alphabet. The apolytikion of St Andrews is chanted during the first third of the Divine Liturgy and it is a fixed part of its order. The page is made to be read by people with different musical and linguistic knowledge. This was transcribed in both notations and languages by Dr George Nabil Habib and further edited by the Reader Gregory Gascoigne (both of them Christian Orthodox that spent a limited time in Edinburgh for studies and work). The people involved in these transformative processes (usually not professional musicians) transcribed specific kinds of notation into other types of notation while in parallel translating from (Ancient) Greek to English in a prosodic way. The lack of proper musical education and the complexity of the project has led into an empirical blended methodology, that keeps being ‘imperfect’ in terms of scientific, more ‘clinical’ approaches but has been able to remain flexible enough to adjust at diverse demographic dynamics as well as different spaces in which the community had to worship⁵.

It is really difficult to describe in text something that has to be lived (either heard or performed) as interrelated to the acting choreographies of the services in order to be fully understood. Even heard from online streaming, we perceive a different soundscape from the actual one, as translated from the phenomenal to the virtual. Writing about the soundscape of this community, allows us to take a distance from it, and think of the effort that is investigated to transform the text, the language that needs to be performed in a typical service, into an ambiental mosaic through: translation, transliteration and transcription. The blended process that is briefly analysed here reflects the demographic mobility of the parishioners.

Tansborder Identity in Transformation

This sense of belonging characterises the transformative mosaic atmosphere of the place. Pieces of different national and cultural backgrounds are put together to allow for everyone to feel, at least partially, at home. What it is described here can be seen as a shared identity that while cannot be characterised as a ‘new’ one, it definitely involves the repositioning of identity, from its usual relation to the nation-state idea and engineering towards purification and unmixing tactics. In the case of Saint Andrew, we find a repositioning that appreciates that migrants and their descendants remain strongly connected to their backgrounds (either consciously or unconsciously). In parallel, it acknowledges the particularities of the new land that the different groups (have to) settle. In it, the local and the global are merged.

To argue that the examined processes suggest a model of repositioning the way identity has been reciprocally interconnected with worshipping places would have been at least premature at this stage, that further research and comparative analysis is needed. Though, I argue that Saint Andrew’s soundscapes suggest the significance of practising inclusivity and respect to ‘otherness’ within the theological limitations, but without losing the controlled organicity of a (cultural, architectural, artistic, ideological) religious tradition should have in order to meet its humanistic qualities. It is

5. Interviews with Mr Thomas Francis Nicholas Donald, Mrs Marina Donald, Mr Stephen Gellaitry and Dr George Nabil Habib. April & May 2020.

part of transborder identity that allows for different people to slightly reposition themselves through worship in a shared, and hence more equal, way. This also suggests the insufficiency of traditional church building typology to embody the dynamics of the parish.

References

- Böhme Gernot. "Atmosphere as the Fundamental Concept of a New Aesthetics," *Thesis Eleven*, 36 (1993), pp. 113-126.
- Getcha Job, Archbishop. *The Typikon Decoded*. Orthodox Liturgy Series. New York: St. Vladimir's Seminary Press, 2012.
- Isar Nicoletta. "Chora: Tracing the Presence," *Review of European Studies*, 1:1 (June, 2009), p. 44.
- Levitt Peggy and Glick Nina. "Conceptualizing Simultaneity: A Transnational Social Field Perspective on Society." *The International Migration Review* 38/3 (Fall 2004): 1002-1039.
- Pentcheva Bissera V. *The Sensual Icon. Space, Ritual and the Senses in Byzantium*. Pennsylvania: The Pennsylvania State University Press, 2008.
- Tweed T. *Our Lady of Exile*. New York: Oxford University Press, 2009.

Atmosphere, Resonance, and Immanent Transcendence

Rethinking the Aesthetic Experience as a Threefold

Anders PALSTRØM¹

Abstract. The paper reinterprets the concept of *æsthetic experience*, combining the neo-phenomenological notion of *atmosphere* with the concept of *resonance*, developed by Hartmut Rosa, and the concept of *immanent transcendence*, coined by Dorthe Jørgensen. It hereby distinguishes between three aspects of *æsthetic experience*, interpreting the *æsthetic experience* as a sensitive interplay of emotional spatiality (*atmosphere*), vibrant relationality (*resonance*), and sensitive cognition (*immanent transcendence*). The paper suggests that this threefold structure can account for a variety of our sensitive *æsthetic experiences* in atmospheric situations, some being mainly atmospheric, others mainly resonant, and others deeply meaningful in a more cognitive sense.

Keywords. *Atmosphere, Resonance, Immanent Transcendence, Sensitivity, Aesthetics*

Introduction

The neo-phenomenological research on atmospheres (ambiances, *stimmungen* etc.) have without doubt led to an actualization of *æsthetics* and *æsthetic thinking* in the last few decades. Returning to the notion of *aisthesis* as the basic form of human experience, combined with the interpretation of feelings as spatial phenomena, the *æsthetics* of atmospheres have successfully emphasized the sensitive qualities of our being-in-the-world; in this regard, *æsthetic experience* is conceived as *atmospheric experience* (Griffero, 2016).

However, *æsthetic experiences* are not all about atmospheres, though we might say that *æsthetic experiences* are always atmospherically attuned in some way or another. I distinguish here between atmospheric situations as basic situations of felt-bodily involvement and genuine *æsthetic experiences*, occurring momentarily within the atmospheric situation. Some *æsthetic experiences* are more cognitive than emotional, some more relational than spatial, while others again seem to be first and foremost spatially emotional and, as such, mainly atmospheric. In order to grasp this variety of *æsthetic experiences*, this paper distinguishes between three different aspects of the *æsthetic experience*, drawing both on the tradition of *new phenomenology*, established by Hermann Schmitz, the *theory of resonance*, established by Hartmut Rosa, and the metaphysics of experience, developed by Dorthe Jørgensen. In doing so, I aim to combine the notions of resonance and immanent transcendence with that of atmosphere in order to better unfold the dynamic structure of *æsthetic experience*, reinterpreting it as a threefold.

1. MA Student in Philosophy, Aarhus University, Denmark, anderspalstroem@hotmail.com

Atmosphere

Drawing on the tradition of new phenomenology, aesthetic experiences are, for a start, atmospheric. The aesthetic situation is, for a start, atmospheric. As Hermann Schmitz have shown, atmospheres can be conceived as spatial feelings, grasping us in the situations of which we are felt-bodily involved (Schmitz, 2019, 94, 100). The spatiality of the atmosphere reveals our situatedness, exposed as we are to the surroundings of this world, while at the same time expressing the pathic qualities of this involvement. In this regard, we always find ourselves felt-bodily involved in atmospheric situations. According to Schmitz, an atmosphere is “the unbounded occupation of a surfaceless space in the region of what is experienced as present” (Schmitz, 2019, 94). This region is what Gernot Böhme also denotes the “in-between” (Böhme, 2020, 14, 159). As enveloping phenomena, atmospheres manifest themselves between subject and object; indeed, around them.

Further, atmospheres are by nature vague but we perceive them anyway as being significant (Griffero, 2016, 12). In other words, the significance of the atmosphere is a vague significance, manifesting itself through our felt-bodily awareness in the atmospheric situation. Drawing on both Schmitz and Böhme, Tonino Griffero likewise emphasizes the pathicity of the sensitive experience. Due to its atmosphere, the vague and meaningful aesthetic situation is, according to Griffero, first and foremost pathic (Griffero, 2019). I will later argue against Griffero’s pathic naivety which I believe, even from a neo-phenomenological point of view, is an unnecessary reduction of the aesthetic experience to mere feeling.

Finally, the notion of the atmospheric situation points toward the preformative character of atmospheres. Typically, we experience the surrounding atmosphere as a dynamic emotional state of already-there-ness. Whether we become aware of the atmosphere in a given situation or not, it has always already enveloped us, as Martin Heidegger also stresses in his famous interpretation of *Befindlichkeit* (Heidegger, 1996, 126). What, then, does the pathic notion of atmosphere as a spatial phenomenon leave uncovered?

Resonance

Though the concept of resonance is not foreign to new phenomenology (Schmitz, 1969; Griffero, 2016, 6; Pallasmaa, 2019, 121-122; Wolf, 2019, 211), I believe it is fruitful to distinguish it from that of atmosphere in order to better grasp the dynamics of the aesthetic experience, i.g. the interrelation between atmosphere and resonance. In this regard, Hartmut Rosa offers a comprehensive concept, highlighting the relational qualities of meaningful human experience as such. I believe this allows us to conceive resonance as an aesthetic phenomenon and, due to its relational character, a constitutive aspect of aesthetic experience. Returning to the notion of an atmospheric situation, resonance is here conceived as a phenomenon that momentarily can occur *within* a given atmospheric situation.

Most importantly, the concept of resonance denotes certain phenomenal qualities of the *relationship* between subject and (segment of) world. While the modern world is, according to Rosa, mainly experienced as mute - reflecting alienation as a fundamental mode of being - momentary experiences of resonance show us that other ways of relating to the world is in fact possible, whether that is in the horizontal spheres of personal encounters, the diagonal spheres of encounters with things, or in the vertical spheres of religion, art, nature or history (Rosa, 2019, 195). To be clear, resonance can occur in all kinds of situations: when having conversations, when drawing and

painting, when praying, or even when playing sports. According to Rosa, resonance is both bodily and cognitively experienced as a vivid, vibrating, and deeply meaningful relationship in which subject and world each have their own voice, an encounter where both subject and world transform each other (Rosa, 2019, 167; 298).

Moreover, as a relational phenomenon, resonance is according to Rosa not in itself an emotional state of being. Rather, resonant relationships consist of both emotional and cognitive involvement (Rosa, 2019, 168, 126), and Rosa even holds that the experience of resonance momentarily repeals the distinction between body and mind (Rosa, 2019, 169), a dualism which Schmitz, too, has profoundly challenged (Schmitz, 2010). Both Schmitz and Rosa thus offer an opportunity to rethink the interplay of feeling and thinking in the atmospheric situations in which aesthetic experience might occur. I will return to this in the final part of this paper.

In contrast to Schmitz, Rosa also emphasizes the importance of active engagement (and even efficacy) for resonance to occur. Whether we are reading a book of poems, dwelling in front of a compelling work of art, or walking through a neighborhood, resonance demands a capability to sensitively relate to what we encounter, e.g. the sensitive capability to read poems and encounter art, or to open oneself to the surroundings of the city (even more so when creating the poems or paintings ourselves). The experience of sudden resonance implicates, thus always a mode of active engagement (Rosa, 2019, 158). However, this does not mean that resonance can be forced to occur, or that it is something we can instrumentally control. Resonance is - just like atmospheres - constitutively uncontrollable (Rosa, 2018).

Finally, Rosa himself reflects upon the intimate relation between resonance and atmosphere (in Rosa, experienced subjectively as mood) (Rosa, 2019, 181-188). As an enveloping phenomenon, the atmosphere now comes to show as the attuned spatial medium of our meaningful relationships to the world. For genuine aesthetic experience to happen, resonance is always atmospherically attuned in a certain way, also when unnoticed. In prospects of establishing the interpretation of the aesthetic experience as a threefold, the notions of atmosphere and resonance, on this basis, denote two equally important aspects of the aesthetic experience; i.e. the aspects of spatiality and relationality.

Immanent Transcendence

How can we, from an aestheticological point of view, understand the impression that the genuine aesthetic experience is experienced as being both sensitive and meaningful? And how can we interpret our way of being both perceptually, emotionally and cognitively engaged in the aesthetic experience? In search for answers, I now turn to Dorte Jørgensen's *metaphysics of experience*, an aesthetically poetic philosophy developed with regard to the aesthetics of Baumgarten and Kant, the metaphysics of Benjamin, and the phenomenology of Heidegger, among others. Moreover, in Jørgensen's interpretation of philosophical aesthetics, we encounter what I conceive as the third aspect of aesthetic experience, namely the 'immanent transcendence' of sensitive cognition.

According to Jørgensen, the aesthetic dimension of the world is in no way mute. Rather, if only we allow ourselves to sensitively engage with the world in open awareness, we are struck by the beauty of its world poetry. Such experiences are, when they momentarily occur, with regard to Baumgarten 'sensitive' experiences in the original meaning of the term: vivid and confused, below the limit of distinctiveness

(Baumgarten, 1750/1986, 17). Sensitive experiences are in other words indistinct, vivid experiences of a “feeling, sensate, and presentiment character” (Jørgensen, 2018, 52). Drawing on the artist, Paul Klee, Jørgensen terms this aesthetic dimension of human experience ‘the intermediate world’. Accordingly, when we enter the intermediate world of aesthetic experience, we expose ourselves to the beauty of sensitivity, an experience which, with regard to both Heidegger, Løgstrup, Schmitz, and Böhme, Jørgensen too conceives as atmospherically attuned (Jørgensen, 2018, 52). And we could add: relationally resonant.

On this basis, I turn to the aspect of cognition in aesthetic experience. In the poetic experience of the intermediate world, Jørgensen holds that an “immanent transcendence” occurs as a sensitively experienced surplus of meaning (Jørgensen, 2018, 57). *Something* appears to transcend itself, and though we certainly might feel ambivalent about it, there is no doubt that such experiences carry their own meaningfulness in an inscrutable way. With regard to both Baumgarten’s sensitive cognition and Kant’s free play, Jørgensen holds that our cognitive involvement in such experiences is “in its own right” a mode of aesthetic reflection. The aesthetic experience is in its sensitivity, with regard to Kant, an expanded way of thinking; by nature cognitive, though not in any rationalistic or psychological way.

In this respect, Schmitz seems to open for similar interpretations of our subjectively situated cognitive involvement, though it might not have been recognized until now. The key is that hermeneutical thinking, according to Schmitz, might even occur without becoming explicative, i.g. as an indistinct mode of cognitive awareness. The reason for this is, accordingly, that hermeneutical thinking originates in bodily thinking but in such a sensitive way that the limit between bodily thinking and hermeneutical thinking is itself indistinct (Schmitz, 2010, 90). Even though hermeneutical thinking is by nature explicative, it follows that it can actually occur as a non-explicative thinking in the experienced situation. Further, the hermeneutical thinking can of course also develop explicatively within such a situation, and it often does. Think about entering a church: we instantly feel the atmosphere of the nave, but according to Schmitz we can also find ourselves implicatively (and of course explicatively) reflecting upon the embedded significance of our being in this sacred church, emotionally attuned by the atmosphere dwelling there. On this basis, it should be clear that cognition - even from a neo-phenomenological point of view - is just as involved as our body in the aesthetic experience, although we cannot really distinguish between bodily and cognitively reflective awareness during the aesthetic experience, or for that matter between body and mind. Thus, the immanent transcendence of the experienced surplus of meaning tells us that we cannot reduce the aesthetic experience to mere pathicity. Rather, the phenomenal aspects of atmosphere, resonance, and immanent transcendence express the comprehensive ambiguity of the aesthetic experience in its dynamic nature of genuine sensitivity. As an aesthetically cognitive phenomenon, I believe that immanent transcendence should be distinguished from the relational aspect of resonance. Resonance does not in itself seem to necessarily imply transcendence, while on the other hand, immanent transcendence only seems to occur within the experience of an atmospherically attuned resonance, transcending the relational mode of experience from within. The cognitive aspect of the aesthetic experience can thus be interpreted to denote the sensitive experience of the significant surplus of meaning embedded in the atmospherically attuned resonance, an interpretation which Rosa does not seem to exclude (speaking instead of deep resonance). Though experiences of immanent transcendence might indeed be rare to most of us, Jørgensen stresses across her work the importance of faithfully exposing ourselves to this transformative dimension of experience.

Finally, Jørgensen emphasizes the creative role of imagination in the æsthetic experience (Jørgensen, 2020). In addition to feeling, sensation, and presentiment, the intermediate world of sensitivity is a world of imagination. Jørgensen holds that imagination creatively conditions the way in which we encounter the world in open awareness, interpreting imagination as an asubjective, quasi-objective power (Jørgensen, 2018, 38). Drawing on Jørgensen, imagination seemingly comes to show as the unifying constituent of the æsthetic threefold, conditioning our engagement in the æsthetic situation in a sensitive and transparent way. For my part, however, it remains to be reflected upon - in accordance with our æsthetic experiences - how imagination more specifically interferes with the way we experience the phenomena of atmosphere, resonance, and immanent transcendence.

Conclusion

On a closing remark, the interpretation of the æsthetic experience as a threefold does not reduce the sensitive nature of the æsthetic experience - either to mere feeling or rational cognition. Rather, it offers an opportunity to æsthetically reflect upon the interplay between the three dynamic aspects of the æsthetic experience occurring in the atmospheric situation. It follows that the threefold æsthetic experience can manifest itself in all kinds of different ways, depending on the particular situation and the content of the relational encounter. Some experiences may be more atmospherically affective than cognitive, some might be more cognitively resonant than atmospherically attuned. Just as the phenomenon of immanent transcendence can manifest itself as an experienced surplus of meaning more or less noticeably. The distinctions of constitutive aspects of genuine æsthetic experience are thus held to be fruitful in prospects of future research on the variety of æsthetic experiences occurring in the atmospheric situations in which we find ourselves to be sensitively involved...

References

- Baumgarten, Alexander Gottlieb. *Aesthetica*. Hildesheim: Georg Olms Verlag, 1986.
- Böhme, Gernot. *Atmospheric Architectures. The Aesthetics of Felt Spaces*. London: Bloomsbury Publishing, 2020.
- Griffero, Tonino. *Atmospheres: Aesthetics of Emotional Spaces*. London: Routledge, 2016.
- Griffero, Tonino. *Places, Affordances, Atmospheres. A Pathic Aesthetics*. London: Routledge, 2019.
- Heidegger, Martin. *Being and Time*. Albany: State University of New York Press, 1996.
- Jørgensen, Dorthe. *Den Skønne Tænkning [Beautiful thinking]*. Aarhus: Aarhus University Press, 2014.
- Jørgensen, Dorthe. "The Philosophy of Imagination." In *Handbook of Imagination and Culture*, edited by Tania Zittoun and Vlad Glăveanu, 19-45. Oxford Handbooks. New York: Oxford University Press.
- Jørgensen, Dorthe. "The Intermediate World: A Key Concept in *Beautiful Thinking*." *Open Philosophy* 1 (July 18, 2018): 50-58. 2018.
- Jørgensen, Dorthe. *Imaginative moods: Aesthetics, Religion, Philosophy*. Aarhus: Aarhus University Press, 2020.
- Pallasmaa, Juhani. "The Atmospheric Sense: Peripheral Perception and the Experience of Space." In *Atmosphere and Aesthetics. A Plural Perspective*, edited by Tonino

Griffero and Marco Tedeschini, 221-231. Basingstoke: Palgrave Macmillan, 2019.

Rosa, Hartmut. *Unverfügbarkeit*. Wien: Revidens Verlag, 2018.

Rosa, Hartmut. *Resonance. A sociology of our relationship with the world*. Cambridge: Polity Press, 2019.

Schmitz, Hermann. *Der Gefühlsraum. System der Philosophie. III, Zweiter teil*. Bonn: Bouvier Verlag, 1969.

Schmitz, Hermann. *Bewusstsein*. Freiburg im Breisgau: Verlag Karl Alber, 2010.

Schmitz, Hermann. *New phenomenology. A brief introduction*. Milan: Mimesis International, 2019.

Wolf, Barbara. "Atmospheres of Learning, Atmospheric Competence." In *Atmosphere and Aesthetics. A Plural Perspective*, edited by Tonino Griffero and Marco Tedeschini, 209-221. Basingstoke: Palgrave Macmillan, 2019.

Atelier de la traversée

A Workshop to Reflect on a Possible Mediation Between Affective and Political Atmospheres

Alice SALIMBENI²

Abstract. As part of my doctoral research, I organized Atelier de la traversée¹ workshop in Brussels, which involved 12 women in individual exploration of their relationship with public spaces. My aim was to investigate from up close some gendered urban experiences and to let emerge atmosphere of spatial inclusion or exclusion. In this paper, I will focus on a moment in the workshop, when women experienced space through the body and express their affective state through a creative medium. This phase produced images, audio, poems that helped me (at least to try) to enter into some atmospheric realities and to reflect on their possible both affective and political meanings.

Keywords. Atmospheres, Feminist Urban Geography, Nomadic Theory, Creative Methodologies

A Nomadic Choice Between Affective and Political Atmosphere

I begin this paper by giving two short and different definitions of atmosphere drawn from the literature: a non-representational, affective one and a situated - and for this reason potentially feminist (Haraway, 1988) - one. Then, I propose my own definition, based on the possible mediation between the two and enabled by the adoption of the nomadic theory (Braidotti, 2011).

The first definition concerns post-affective studies, where the term affection is referred to a set of intensities, forces and energies emanated from human and non-human bodies. (McCormack, 2013) When bodies establish a relation with each other in urban space, affection begin to circulate between (and through) them, thus generating an affective atmosphere. (Anderson, 2009) Affective atmosphere cannot be seen but felt, it manifests itself by invisibly enveloping the body (McCormack, 2018) and it is perceptible only through its direct physical experience.

The second definition concerns the situatedness of atmospheric perception. For Löw and Goodwin (2016), atmosphere is the encounter between *spacing*, *synthesis* and *habitus*: *spacing* refers to the way living beings and social goods position each other in space, and emanate an external effectuality (Löw and Goodwin, 2016) akin to an aura. The sum of all the external effectualities of the elements that make up the space produces a wider aura which may be identified as the overall effect of space.

The perception of this wider aura by the subject happens through the process of *synthesis*. As Bordieu (in Löw and Goodwin, 2016) explained, the habitus of the subject

1. Literally "cross(ed) workshop"

2. University of Cagliari - Italy, alice.salimbeni@unica.it

(social class, gender, race) intervenes in the perception of the atmosphere as lenses that allow to see reality differently. At the same time, the subject projects actively its social structure into space, setting in motion affects from a politically, situated, bodily position.

Despite the debate on the incompatibility of affective and non-representational theories with feminist theories (Cadman, 2009; Colls, 2012) it seems to me that the first conception of atmospheres (affective) and the second (politically situated) can be hybridized and made run together with the mediation of the nomadic theory (Braidotti, 2011). Affective theories are accused of always remaining too close to the non-political exploration of space and of being incapable of reaching and producing valid meanings for everybody, while feminist theories are accused of working on a plane that moves away from the body to pursue political goals, risking flattening the subjective value of women's urban experience (Cadman, 2009; Colls, 2012).

Combining the two points of view, adopting a nomadic approach based on atmosphere, is a way to open up to the possibility that women's urban experience can be read both from a political and affective perspective, due to the concept of nomadic subject. The nomadic subject holds a status of materiality which enables it to experience space from a corporal and affective point of view, but it is also interrelational and in a constant becoming with the social structures that determine power-asymmetries, such as those that produce conditions of gender spatial in-exclusion. A concept of atmosphere, hybrid between the two presented, hence based on nomadism, helped me to interpret the perceptions of the women I worked with, without putting aside their subjectivity and, simultaneously, highlighting the political value of their spatial relations.

Atelier de la Traversée

Between December 2019 and March 2020, I organised in Brussels a creative workshop supported by the feminist association *Le poisson sans bicyclette*. I named it *Atelier de la Traversée*, alluding to the way the body actively crosses space, projecting its habitus into it, generating a political-affective atmosphere, and to the way it is crossed by space, its energies, its forces and power structures.

The aim was to create a context for exploring the public space from a gender perspective to bring out spatial conditions, emotions and affections qualifying women's urban experience.

Focusing on affect required me to develop a theoretical and methodological framework that recognizes the creative approach as a good way to invite participants to express their spatial relations, (Thrift, 2008) through tools that ease the communication of both conscious and unconscious meanings.

The workshop has been advertised on the Facebook page of the association, which has a feminist target population. Indeed, it was attended by 12 feminist women between 21 and 51 years old, in need to find a channel through which to express their urban experience. It was structured in 5 moments. The first consisted in the administration of a survey through which I collected generic information on each woman and a synthetic judgement (comfort and discomfort) on the quality of her urban experience.

The second was conceived as an exercise during which each woman immersed herself with her imagination in some of the public spaces she had indicated in the survey. In the third, an actress expert in public space performance guided them in carrying out different body exercises, inviting them to use the space in a non-regulatory way

(dancing, shouting), to focus on the sensations that these actions produced. This moment was aimed at propel women to pay attention to the way space affects their body and to suggest them an approach that did not want to reproduce daily life. Rather, the exercise was structured as an extemporary performative moment, with the specific aim of *feeling space more intensely* than in everyday life. The third one, which is what I'll focus on in the next paragraph, involved women and their bodies in what I like to call an individual and exploratory performance (Thrift, 2003): a practice beyond the daily habits of using space, during which every woman, inspired by the collective exercise did together, has deliberately let herself be carried away by the events and the atmospheres, while carefully investigating her relationship with space and trying to creatively express it.

Finally, during the last moment we collectively reflected on our path, to detach ourselves from the subjective value of personal perceptions and to discuss about their collective meaning. The outcomes of this last phase are 3 short films that we used to explore more deeply, and then communicate, our experiences.

A Nomadic Approach Based on Atmosphere

The first experience I want to talk about is the one of J, a 27-year-old Belgian girl who took a picture of *rue de l'Evêque* - a street of connection between *boulevard Anspach*, where the Stock Exchange is located, and a well-known shopping street. *Rue de l'Evêque* does not have the æsthetic quality of the main avenue, it is rather an interstitial space occupied by fast-fashion shops, which can be found everywhere in the area, along with fast-food ones. Around *rue de l'Evêque*, bodies move in predictable ways, all quickly following pre-established ordered directions, orbiting around functions that have a precise target, of whom J does not feel she is a part of.

This space is really unpleasant. There are all these cars and these hyper-large buildings, it's grey, and further away there are all these shops and... and for me there's a concentration of capitalism in it all. And then, now it's even worse than usual, there's a sale... voilà! It's not a space I like to be in. It's not nice. The buildings are super tall, super close by, with uninteresting shops. It was raining, too.

J is enveloped in a multitude of forces that go through her body and give shape to her experience of that urban space. She is in what, with Thrift (2008), we could define a storm of affections but, since this one is perceived as a negative storm, J needs to put a certain distance between herself and space. To do it, she performs an objectifying act, taking a photograph of a paper on which she writes what she believes is the dominant character of the atmosphere: *maussade*, meaning gloomy, bleak, dark.

In order to give an atmospheric interpretation of her experience, I recall Massey's conception of space (2005), according to which space is produced by transcalar relationships. I want to include in them the affective ones. Here relationships are mainly global, far from the body, linked to the historical competition between cities that wish to achieve similar global standard. This generates a complex, articulated, chaotic, intensely stimulating atmosphere, which I would otherwise call violent, saturated, frantic, intrusive and overwhelming. It dominates the body, crossing it with strength, and thus shaping its experience more than the body can shape the atmosphere. It is introjected and it clutters up thoughts, sensations, emotions, limiting the intensity with which J manages to project something of herself into space. *Rue de l'Evêque* asks J a lot of attention and diverts her from taking more introspective attitudes perhaps precisely because the relationships that shape that space are far

from the dimension of the individual experience of her body.

The second mechanism is triggered by a shy atmosphere, less dazed and heavy than the previous one, not necessarily less intense or vital, but able to facilitate the moments of introspection that rue de l'Evêque obstructed. This is the case of B, a 52-year-old Belgian woman, and a space with a special charm, where the ancient Abbaye de la Cambre is located, surrounded by a large park, in the Ixelles district. The condition experienced by B allows her to concentrate on a single significant object, a tree that McCormack (2018) would call an *atmospheric thing*, since it dominates her experience, establishing with her a privileged special affective relationship.

I was like this (the lowest tree), all humped, all crumpled up on myself. It's frightening, suddenly I have so many memories. In this picture, there is hope and sadness.

This atmosphere does not monopolize B's attentions, on the contrary, it shapes a space for her feelings to be expressed, it induces her to take a more active role in the space, to own it and, then, to project her own intimacy into things, objects, situations. B does not try to keep a protective distance between herself and the perceived space. Rather, she opens up towards it and the tree with which she feels *tuned* (Löv, Goodwin, 2016).



Figure 1. Mauseade, J; the tree, B.

Open Reflections

This part of the fieldwork has produced pre-discursive impressions, cognitive reflections, clear or unclear suggestions. Through them I tried to grasp something of the great complexity of emotions, memories, affections, desires and fears that have marked these women's experience of urban space.

The nomadic approach based on atmosphere proposed for the interpretation of the urban experiences of the workshop has some significant implications. i.e., first, it produces a reading of space as such, without giving in to the temptation to decontextualize the elements that compose it in order to study them individually and thus withdrawing them from the circulation of affections that depends on their position and function in relation to the whole. Secondly, it is based on the assumption that spatial knowledge is possible only through the direct experience of bodies. As Böhme (2017) writes, the atmosphere is the union of the perceiving subject and what is perceived. It means that the spatial readings that can be produced by mobilizing this concept are inevitably politically positioned and determined by the intersection of the powers to which the body is subject and object. Consequently, such an approach tries to keep together the intimate and personal relationship between subjects and space and political considerations over the body, which aim to reveal some of the

conditions of spatial inclusion and exclusion women lives in their daily life. The way this practically happens is what I am working on in my research, looking at different atmospheric relationships and trying to figure out if there is a pattern behind them, by grasping all the suggestions that come from such an approach.

Without sin of absolute relativism or determinism, it is difficult to understand if, i.e., B's spatial experience can arouse similar feelings in other people as well, gaining a collective value. I moved, then, to a similar (but very different) question. Rather than wondering if, and how, B's experience could be considered of a collective value (what collective value means might deserve a special issue) I felt curious for *the kind and the way* she establishes a relation with space and which political reflections may raise by paying attention to this. Her relation with space is featured by a certain freedom of intimate expression (the kind), allowed by a state of attunement (the way). I began to wonder if her freedom to project herself into space (just as J's lack of freedom to do the same) can be approached by questioning this specific sense of freedom itself. This has pushed me to wonder whether, for some women, the capacity of space to accommodate the projection of intimacy might be an important factor when talking about feeling of spatial in-exclusion. It becomes a question of protection of one's personal sphere, one's thoughts and sensations from powers reproduced by different places of the city, which generate bodily affective state that increase or decrease women's possibility to feel *tuned* to public spaces.

Aknowledgement

Many thanks to A., B., C., F., G., J., M., N., for sharing their precious experiences.

References

- Anderson, Ben. "Affective Atmospheres". *Emotion, Space and Society* 2, n. 2 (December 2009): 77-81. <https://doi.org/10.1016/j.emospa.2009.08.005>.
- Böhme, Gernot, e Jean-Paul Thibaud. *The Aesthetics of Atmospheres*. Ambiances, Atmospheres and Sensory Experiences of Space. London; New York: Routledge, Taylor & Francis Group, 2017.
- Braidotti, Rosi. *Nomadic theory: the portable Rosi Braidotti*. Gender and culture. New York: Columbia University Press, 2011.
- Cadman, Louisa. "Non-Representational Theory/Non-Representational Geographies". In *International Encyclopedia of Human Geography*, Nigel Thrift and Rob Kitchen (eds), 456-63. Oxford: Elsevier, 2009. <https://doi.org/10.1016/B978-008044910-4.00717-3>.
- Colls, Rachel. "Feminism, Bodily Difference and Non-Representational Geographies: Feminism, Bodily Difference and Non-Representational Geographies". *Transactions of the Institute of British Geographers* 37, n. 3 (July 2012): 430-45. <https://doi.org/10.1111/j.1475-5661.2011.00477.x>.
- Haraway, Donna. "Situated Knowledges: the science question in Feminism and the privilege of partial perspective". *Feminist Studies* 3, n. 14 (1988): 575-599.
- Löw, Martina, e Donald Goodwin. *The Sociology of Space: Materiality, Social Structures, and Action*. Cultural Sociology. New York: Palgrave Macmillan, 2016.
- Massey, Doreen B. *For space*. London ; Thousand Oaks, Calif: SAGE, 2005.
- McCormack, Derek P. *Atmospheric things: on the allure of elemental envelopment*. Elements. Durham: Duke University Press, 2018.

———. *Refrains for moving bodies: experience and experiment in affective spaces*. Durham: Duke University Press, 2013.

Thrift, Nigel. *Non-Representational Theory: Space, Politics, Affect*. International Library of Sociology. London: Routledge, 2008.

———. “Performance and ...” *Environment and Planning A* 35 (2003): 2019-24.

Ambient Outlines of Children's Urban Experience

A Look Back at an Interpretative Methodology

Nathalie AUDAS¹,
Fanny VUAILLAT²,
Sandrine DEPEAU³

Abstract. Based on commented walks (school/home) carried out with children between the ages of 9 and 11, this article addresses the interest in an ambiance-driven approach to listen and account for the emotional and sensory elements that recount children's daily urban experience. With a method of interpretative translation in which the analyst is a distanced third person who can listen and pay attention to what happens here and now in the commented walk, initial ambient outlines of children experience appear.

Keywords. *Ambiances, Children, Commented City Walks, Interpretative Methods*

Introduction

This work stems from the Mobikids⁴ interdisciplinary research program, in which we study over a hundred schoolchildren (Rennes, city-centre and Orgères, its suburbs in France) by collecting geo-tagged, quantitative and qualitative data. This long-term study follows children over two or three years (depending on the cases) to document the conditions of their mobility and autonomy, notably during the transition to junior high school. We present here part of the analyses regarding the realization of commented walks, re-adapted from the initial tool (Thibaud, 2001), tested with children (Depeau, 2005). This type of survey in motion has been already experimented with by Kullman (2010) and Bourke (2017), among others, who worked on similar methodologies. The processing of the sound and visual data from the realised walks is a methodological challenge. We aim to report on the elements that constitute it. Aiming to qualify children's daily urban experience, we developed an interpretative methodology focusing on a dual relationship: the child and the researcher, and the child with the spaces crossed. The 'translation' of this dual relationship makes ambient outlines emerge. To that end, the analyst writes synthetic interpretations from the listening of recordings of the walks. Ambient outlines illustrates the dual relationship, between the adult and the child and between the child and the environment *here and now* during the commented walk. The outlines are drawn from the analyst's synthetic

1. Univ.Grenoble Alpes, UMR AAU-Cresson, France, audas.n@grenoble.archi.fr

2. Univ. Grenoble Alpes, Pacte, CNRS & School of Political Studies, France, fanny.vuailat@univ-grenoble-alpes.fr

3. UMR ESO, CNRS - Univ Rennes, France, sandrine.depeau@univ-rennes2.fr

4. "Daily mobility of children in urban areas. Role of urban educative cultures (UEC) in the evolution of daily mobilities and contexts of the life of children. Collection and analysis of geolocated and semantically enriched tracks." 2017-2021 (Sandrine Depeau ESO-Rennes, Pacte Laboratory, UMR AAU, Cresson team)

Funding ANR-16-CE22-0009.

interpretations - i.e. the third person and distanced witness. At different times, a commented walk can borrow from different outlines, as the ambiances of the children's experiences can change with the relationship and the spaces crossed.

Qualifying the Ambiances of Children's Urban Experience

The city is seen as a necessary "playground" (Noschis, 2006) for children. It is considered as a space suitable for children, later teenagers, to explore, discover and gain the autonomy that they need to become adults. The city is thus the ideal space to learn, where children and teenagers arrange their daily spatialities (Abu-Ghazze, 2002; Aragau et al., 2016). In this context, children's autonomous mobility conditions seem to be the main focus in recent works to quantitatively and qualitatively describe children's experience (Depeau, 2008; Christensen et al., 2011; Pacilli et al., 2016). Many studies focus on children's daily trips, where the one from home to school is often studied to document the abilities for learning independence.

Despite emerging security understanding, the evolution of urban forms and sociabilities, we still struggle to consider children's daily and urban experiences. Some sensitive approaches are being explored to understand in more detail child-urban and suburban spaces relationships. How can we account for the everyday experience, the important little things that are too obvious to be said? How can we make the affects and emotions in places talk and tell stories? These objectives require rattling our usual research frameworks. Measurements, observations, interviews are no longer enough because of the high risk of imposing 'adult-centred' models and standards. We do not think that children experience an isolated and self-sustaining world that we should reveal without misrepresenting it. On the contrary, we believe that connections and relations are constituent, and that they require to be taken seriously. *Going on the field* thus involves us differently (Volvey et al., 2012) and children's studies explore forms of co-research with children (Gallacher and Gallagher, 2008; Cope, 2008; Honkanen et al., 2018) and thus hold the turn of a relational geography (Volvey, 2014).

We precisely think that the nature of this research involving relationships is important to study and to understand the fine reality of children's experiences. These relationships are those notably woven between the child and the researcher and between the child and the space. This dual relationship plays a part in the creation of ambiances. By providing a narrative approach⁵ of ambiances, we suggest another way to grasp children's urban experience. Constitutive of these urban walks, sensitive phenomena and perceptive modalities are then highlighted (Thomas, 2018). This analysis of commented walks about ambiances reinforces a slice of reality (Torgue, 2012). It also surely reveals a still-dark part of this way children are in spaces and deal with spaces.

From Revisited Commented Walk to Interpretative Analysis

As part of the Mobikids program, 69 school-home commented walks were performed with children (including 25 with another travel mode). The method was revisited to invite the child to prepare a small report documenting the places visited. The child then becomes the guide or reporter of such daily spaces and freely talks to the researcher. The sounds are recorded, and the child is asked to take pictures of what is important to him. Upon arrival, in a post-walk interview, the child and researcher talk about the journey and talk about the pictures taken.

5. Account of experiences made by the analyst.

Therefore, for each walk, a walk-audio recording, a post-walk interview and several pictures (between two and ten, depending on the child) were obtained. To prepare the collective data analysis, a third person pre-analyses the recording and the audio transcription. The researcher analysing the commented walk is not the field surveyor - he is an outsider, like a neutral witness who is not affected by the investigation or the dual relationship: between the adult and the child, and between the child and the places crossed. The analyst is potentially able to see what is at play while listening in a distanced way to the trust, pleasure, discomfort, familiarity, curiosity, induced responses, judgments or sometimes moralising reactions. By doing so, we realized that what was at stakes *here and now* during the walk told an ambience in which the relation with the researcher and that with the places interconnected and echoed each other.

Here we retrace an ongoing methodology and would like to focus on one of the components . To document what the analyst perceives in the dual relationship at play, he writes a synthetic interpretative text on the walk. In this free text, the analyst finds room to inform the research collective of elements that are hard to detect except with a less constraining, intuitive and almost poetic writing. We can read the tones of voice that translate emotion, silences, hesitations, surrounding sounds and modulations of the walk. The text becomes the possible space to tell the attention that takes place both in the relationship between the researcher and the child and between the child and the space crossed. We can draw the first ambient outlines. The elements recounting the different forms of relationships at play were not indicated in the analysis grid, but they triggered us as they could create the story of ambiances.

We thus have a translation methodology in three successive steps: orality (the child's words during and after the walk), inter-subjective listening (of the recording) and interpretative writing (ambience storytelling). This process, here open to discussion, involves the analyst researcher's intuition and subjectivity and questions the ecological validity of such a process. Our eye and ear, specific in their subjectivity, precisely bring another dimension of the analysis of the research data by revealing "non-verbalised" perceptions and experiences as they are at the heart of these relationships. Those are elements that are not central to the research objective but that inform it nevertheless.

Ambient outlines

Places Crossed "While Holding Our Breath"

The metaphor of holding one's breath refers to a bubble in which the child is enclosed in, to limit or to be protected from the connection with the environment. The minerality of the pavement does not match, traffic is loud and the other can represent a danger, sometimes in the parents' discourse. The journeys are often prescribed by parents and not chosen by the child, which enhances the withdrawal. The physical and/or social relational distance is also understood in the child's emotions. He is careful with security, mostly with road safety. We can hear a form of concern, which is translated in the relationships with the peers, associated mainly with the other's eye and the fear of the unknown. With the researcher, the child is shy or uncomfortable, as witnessed in the terse answers, hesitations and awkward laughter. During the walk, or certain moments, the discomfort seems significant, and the child is withdrawn or defensive. Upon listening, we sometimes understand his desire, even his impatience to go to a more peaceful and familiar environment, as if to extract himself from an uncomfortable place. Certain streets, noise or high schoolers can scare him. The child can also express anger, when he mentions a place that he loved that was transformed, often built upon.

The walk takes place along a boulevard and the child seems uncomfortable because of the traffic that never stops. She appears weary of this phenomenon as she understands that she cannot change anything about it. She advises the researcher never to live on the boulevard. She often mentions the pedestrian crossings as “moments” she does not like and that punctuates her walk, not in a positive way. She qualifies this long boulevard with the adjective “giant,” which conveys efficiently the impression of infinity it represents for her [...]. The remainder of the walk gives the impression that she is holding her breath or floating, i.e. barely connected to the disliked environment, and she cannot wait to be close to home. [...] When she talks about her walk, her voice is monotone, even a little sad, and she struggles to qualify what she feels. At some point, she says “I don’t feel anything,” and her enthusiasm appears when she is close to home. Her voice gets lighter and happier.

Places Domesticated by Children

Other walks or sequences reveal a more familiar ambient outline. The child seems to have domesticated the places. Indeed, the connections appear stronger, since the child knows the routes well that may be emotionally charged. He has known them for long, mastering them as he walks through every day, sometimes alone, with a few friends or parents. Habits, good memories, aesthetic pleasures, comforting connections with home are elements where we know the child feels good. Places can become sources of inspiration to play, hide, meet and they are domesticated reference points.

She only likes the passage where there are trees because of nature, but also because it is aesthetic, even practical (to shelter herself when it rains). Later in the discussion, she mentions a play time when she had to go to school dressed in a tee-shirt and shorts when rain was pouring down. She talks about “struggling” but her voice conveys the opposite, a sort of excitement about running as fast as possible to school while jumping in puddles!

(Re)discovered Places

The commented walk proposed to the child is paradoxically an extraordinary *here and now*, even as it is a daily journey. However, the child never goes through it under the research conditions: walking on foot, with a stranger (researcher) who is trusted by the parents, with a recorder and a camera. Upon listening, some commented walks become an opportunity for the child to discover their living place differently. In some cases, the child is carried by car, and it is the first time he experiences a well-known space differently, by foot. We can hear the desire to fully explore those spaces, where the child can express his desires, which are usually constrained, and now allowed. He chooses the itinerary, explores the spaces and possibilities. The body and verbal expressions that follow show her letting go, unveiling her way of being connected.

On this walk, we easily feel that the child is excited about doing it, living this experience with GPSes that he mentions on several occasions while walking. The child quickly shows the pictures he would like to take, we can imagine that he mentally represents his route before living it. He mentions a few times elements left to be met or crossed or directions to take, or changes in the ground roughness or slopes (holes, mud), which help him orient himself.

Perspectives

Investigating children represents a significant methodological challenge. Here, the ambiance approach offers a solid and flexible theoretical framework to listen and account for emotional, sensory and perceptual elements that tell children's daily urban experience. We worked by trial and error, based on an interpretative translation method where the analyst is a third, distanced person that can listen and pay attention to what happens in the *here and now* of the commented walk. The point is to accept an interpretative process that requires letting go of controlling and monitoring positions before the scientific data that we produce (Despret, 2016).

References

- Abu-Ghazze, Tawfiq. "Children's Spatial Behavior in AL-Rawdah Housing Development in Amman, Jordan" *Architectural Science Review* 45/2 (2002) : 97-115
<https://doi.org/10.1177/001391659803000604>
- Aragau, Claire. Didier-Fèvre, Catherine. Rougé, Lionel. "Enfants, adolescents : des pièces maîtresses du puzzle périurbain" *Les Annales de la recherche urbaine* 111/1 (2016): 42-57
- Bourke, Jackie. "Children's experiences of their everyday walks through a complex urban landscape of belonging" *Children's Geographies* 15/1 (2017) : 93-106.
<https://doi.org/10.1080/14733285.2016.1192582>
- Christensen, Pia. Mikkelsen, Miguel Romero. "Is children's independent mobility really independent?" *Mobilities* 4/1 (2009): 37-58.
- Cope, Meghan. "Patchwork Neighborhood: Children's Urban Geographies in Buffalo, New York." *Environment and Planning A: Economy and Space* 40/12 (2008) : 2845-2863. <https://doi.org/10.1068/a40135>
- Depeau, Sandrine. "Les trajets commentés une manière d'appréhender la mobilité des enfants. (chap. 3.6). Dans A. Legendre (2005) *Le développement de l'usage social et spatial des espaces publics au cours de l'enfance: l'apport des Nouvelles Technologies dans l'analyse des caractéristiques sensibles du milieu urbain*. Rapport de recherche, programme interdisciplinaire Société de l'Information Géomatique, Espaces, Territoires et Mobilités (CNRS)
- Depeau, Sandrine. "Nouvelles façons de se déplacer vers l'école ou l'expérimentation du pédibus dans un quartier rennais. Quelles incidences sur l'apprentissage de l'autonomie de déplacement des enfants et leurs rapports à l'espace?" *Recherche Transport Sécurité* 101 (2008) : 253-271
- Despret, Vincianne. "Entretien avec Vinciane Despret autour de son livre *Au bonheur des morts*." *Socio-anthropologie* 34 (2016) : 109-130.
<https://doi-org.sidnomade-1.grenet.fr/10.4000/socio-anthropologie.2478>
- Gallacher, Lesley-Anne. Gallagher, Michael. "Methodological Immaturity in Childhood Research?: Thinking through 'participatory methods'" *Childhood* 4/15 (2008) : 499-516
- Honkanen, Kati. Poikolainen, Jaana. Karlsson, Liisa. "Children and young people as co-researchers - researching subjective well-being in residential area with visual and verbal methods." *Children's Geographies* 16/2 (2018) : 184-195.
<https://doi.org/10.1080/14733285.2017.1344769>
- Kullman, Kim. "Transitional geographies: making mobile children" *Social & Cultural Geography* 11/8 (2010) : 829-846. <https://doi.org/10.1080/14649365.2010.523839>

Noschis Kaj. "La ville, un terrain de jeu pour enfant" *Enfances&Psy* 4/33 (2006) : 37-47. <https://doi-org.sidnomade-1.grenet.fr/10.3917/ep.033.0037>

Pacilli, Maria Giuseppina. Giovannelli, Ilaria. Spaccatini, Federica. "Children's Independent Mobility: Antecedents and Consequences at Macro- and Microlevels" *Movement, Mobilities, and Journeys* (2016) : 307-327

Thibaud, Jean-Paul. "La méthode des parcours commentés" In : *L'espace urbain en méthodes*, edited by Michèle Grosjean and Jean-Paul Thibaud, Marseille : Editions Parenthèses, 2001

Thomas, Rachel. *Une critique sensible de l'urbain*. Architecture, aménagement de l'espace. Université Grenoble Alpes : Ecole Doctorale 454 Sciences de l'homme, du politique et du territoire, Grenoble, 2018.

Torgue, Henry. "Pour une convergence des expertises. L'ambiance, au croisement du vécu, de la recherche et de l'art" In *Ambiances in action. Proceedings of the 2nd International Congress on Ambiances*, edited by Jean-Paul Thibaud et Daniel Siret, Ambiances, International Network, 2012

Volvey, Anne. "Le corps du chercheur et la question esthétique dans la science géographique" *L'Information géographique* 78 (2014) : 92-117

Volvey, Anne. Calbérac, Yann. Houssay-Holzschuch, Myriam. "Terrains de je. (Du) sujet (au) géographique" *Annales de géographie* 687-688/5 (2012) : 441-461

10

PRESENTING ATMOSPHERES

11

SENSE AND SENSIBILITY OF AFFECTIVE ATMOSPHERES

12

SENSITIVE SPACES AND URBAN PRACTICES

13

SENSORY EXPERIENCE, ENVIRONMENTAL
EXPERIENCE, POLITICAL ENGAGEMENT

14

SOUND STAKES OF THE ATMOSPHERE

Sensitive Spaces and Urban Practices

Session 12 – Introduction

Cristiane DUARTE¹,
Ethel PINHEIRO²

The research on Architecture and Urbanism, provided by the bias of Social and Human Sciences, has sought to work on the strategies of multidisciplinary approach and deliberated studies applied to collective spaces in contemporary cities for many years. Such actions can promote the resensitization of people and spaces, if developed towards though more sensitive approaches.

It is clear that far beyond the role of Information Technology in the modification of spaces, Metropolization and Suburbanization have introduced a degree of detachment, or social indifference, into the experience of public spaces, that is expressed today as a state of exacerbation of opposites (much densified public spaces enlivened by actions of tactical engendering x inert spaces without occupation, bequeathed to an exclusive public of the society). Thus, the current processes of dispersion and division of the city intensify the perception of public space as a destabilized and erratic dimension, which needs to be revised and enlarged to make survive new subjectivities.

In this way, to fully understand collective space, considering it as the locus of action and reaction of social actors, it is our goal with this thematic session to shed new light on the understanding of the emotions and practices experienced in the process of rehabilitation, or lack of it, in small ordinary spaces. By experiencing these places, giving time for awareness and rediscovery, it is possible to make emerge some individual and collective senses, affections, resonances of memory and desire; it is also possible to be asked about the presence of the old and the new and about how to think collective spaces from a harmonious relationship between humans and objects; it is also possible to highlight absences, cast a glance at the remains and perspectives for the future. These thoughts can be instigated by reflexive, theoretical, poetic and critical essays, or even practices that can be archived in a synesthetic and (inter) subjective way - through videos, photographs or drawings.

We hope to receive contributions that may interfere with the expectations of every citizen or passer-by, in relation to the way they experience those collective spaces, raising ideas that may promote the recognition of alterity. We also wish to receive contributions based on the construction of subjective and cultural dynamics on the scale of everyday life, through the intertwining of architecture and urbanism with

1. Universidade Federal do Rio de Janeiro - UFRJ, Brasil.

2. Universidade Federal do Rio de Janeiro - UFRJ, Brasil.

other Social Sciences, and with a view to developing new processes for engendering spaces that are open to differences and also motivators of more humanizing experiences.

These contributions are to be materialized through descriptions of practical actions, carried out in public spaces, and should portray the diversity with which we can think and execute the plans and goals for more politicized and touching urban spaces - beyond the traditional methodologies academically taught.

Sensitive Topologies Configurations in the Milieu and the Urban Landscape

What You Feel Is What You Get

Mohammed BOUBEZARI¹

Abstract. Usually, in questions relating to the landscape, especially the urban one, three sensitive modalities are mobilised in the configurations specific to particular lived situations: the visible, the audible and the tangible. The tangible one is often assumed to be intrinsically linked to the visible modality by visuo-haptic coupling. However, on the basis of the study of concrete cases, and through the paradigm of sensitive topology, we have been given to note that the visible and the tangible are not always linked. Whether in domestic situations of inhabiting, or in public situations. The paradigm of sensitive topology phenomenologically deconstructs the notions of milieu and urban landscape by facilitating the analysis of lived situations.

Keywords. *Sensitive Topologies, Visuo-Haptic Coupling, Territoriality, Urban Design*

Is What You See That What You Touch?

The relationship between sound and space has been widely explored, as long as sound was supposed to obey the geometric rules of propagation in and between visible material bodies. Strange persistence of the visible in the sound spaces. The named object is trapped in its visible topology! Is it an “unjust” sovereignty of the visible on the sound like Jean-François Augoyard has rightly alerted (1991)? There is more sovereign and more rooted, the tangible. As we will see below, before being tangible, the material object is revealed by its visibility or its audibility.

So, to think about sound and space, do we first have to “turn off” the light?

Spatial Versus Local

Since the last 70's, the anthropological approach to sound space has opened two new research paths:

- The first is that of Murray Schaefer's “soundscape” (1977) where sound ecology found all its logic in scientific debate, opened up new artistic horizons and ended up seducing the world of acoustic engineering, especially since the Lisbon congress in 2007 (ICSV12, Lisbon, 2005) where M.Schaefer had the opportunity to address an audience of engineers asking for new developments;
- The second is that of “inhabitant rhetoric” (Augoyard, 1979) rather phenomenological, it opened the way to long and laborious research on the sound dimension in the habitat system, also sound effects and the theory of ambiances which includes today all its sensitive dimensions and not exclusively sound.

1. LEAU research unit, *Universidade Lusófona de Humanidades e Tecnologias, Campo Grande, 376 | 1749-024 Lisboa - Portugal, mohammed.boubezari@ulusofona.pt*

However, the understanding of the concept of landscape is different in these two main streams. For the first, the landscape is understood as a whole, global and encompassing all sound activity (Truax, 2000), aesthetically or culturally sanctioned as “good” or acceptable and where any parasite must be removed from this universal composition. For the second, the approach is phenomenological. The parasite (Augoyard, 1989) must be taken into account as part of the sound production. The soundscape is not this absolute frame of reference, it is only a perspective, a particular point of view on the same sound phenomenon. Pascal Amphoux shed some light on it, and made it operational (1997; 2000).

We will see below how the notion of sensitive topology makes it possible to articulate the environment and the landscape.

A second point that seems common in both approaches is the relationship to space and the signal. If acoustic engineering has made it its field of predilection, the anthropological approaches quoted above allowed an interesting development beyond the traditional disciplinary borders but the spatiality of the sound phenomena was somewhat neglected or at least a return to the problem of its spatiality did not take place. Sound is often considered, despite space, to be qualified time. Moreover, the attempts at sound mapping have not considered the articulation of sound and its perception down to the detail of its spatiality. The quantitative maps have remained topographically more precise than the qualitative ones. These qualitative maps simply give to listen rather than see. The geolocation of sounds replaces their actual spatialization. This challenge motivated our research on the sound topology represented with its spatial limits (Fig.1).

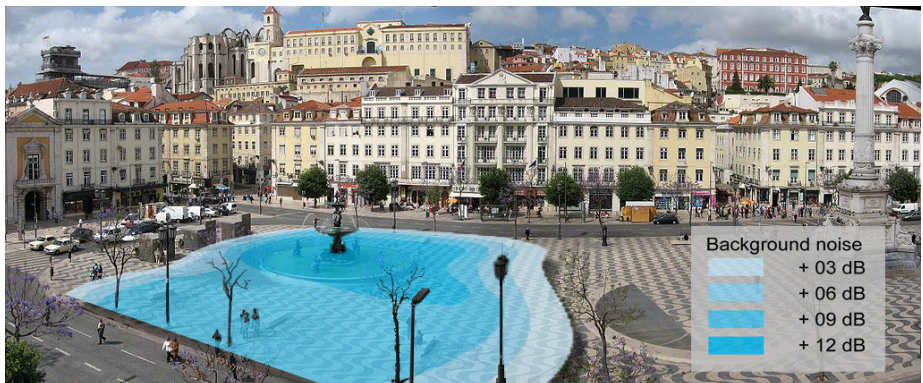

Figure 1. Water sound topology in Rossio square, M. Boubezari, 2012. In what and how can the notion of sensitive topology account for an experienced and perceived phenomenon?

For this, it is necessary to review some cliché concerning the audible, the visible and the tangible and the most common sensitive couplings, because, in questions relating to the landscape, especially the urban one, these three sensitive modalities are mobilized in the configurations specific to particular lived situations. The tangible one is often assumed to be intrinsically linked to the visible modality by visuo-haptic coupling.

Object Versus Body

Although topology was developed especially in mathematics by Henri Poincaré, with the rigor and the necessary precision that this discipline imposes, the fact is that remains initially an intuitive visual representation of envelope beyond from which an object defines its limits in space. So, what do Husserl and Merleau-Ponty tell us about the sensitive experience of this topology?

For Husserl, explains Françoise Dasture (1988), visual perception is distal in the sense that we perceive here this visible limit which is “there.” The signal being the necessary medium which conveys this information to the perceiving subject. This understanding is valid for both a light and a sound signal. For Merleau-Ponty, perception occurs at the level of contact with the body involved in the perceptual experience. The object is also visible “here” just as the body of the perceiving subject is visible “there.” But the main difference between these two understandings is that the signal for the Merleau-Ponty is not a stimulus but it is an integral part of the perceived object. Besides, with this author it is more a question of body rather than of an object.

This subtle difference between these two approaches challenges us on the limit of the perceived thing, object in the first but body in the second. The object emitting a signifying signal while the body already has this signal which gives it meaning and names it.

The immediate consequence, as much philosophical as practical of this comparison is decisive as regards the delimitation of the limit of what is perceived. This envelope which is the sensitive topology which interests us is in the first case, that of the physical body, which in the reality of experience is none other than its tangible limit, and in the second case this envelope is limited only by other surrounding bodies. In this regard Merleau-Ponty writes “Experience reveals under objective space, in which the body ultimately takes place, a primordial spatiality, the first of which is only the envelope and which merges with the very being of the body. To be a body is to be tied to a certain world, we have seen, and our body is not primarily in space, it is space” (1945). What Juhany Pallasma expressed more simply later (2005).

The research we have conducted on sound topology (Boubezari, 2011) has confirmed the Merleau-Ponty approach because when it comes to the auditory modality it is easier to conceive that listening occurs at place of contact and therefore the place of the perceiving body.

When it comes to the visible modality, the third modality which is touch makes this understanding difficult because it is very often coupled with the visible. This visuo-tactile coupling often coating in error but as soon as it is a question of sound phenomena, the sound topology as much as visible are detached from this tangible topology.

Another operational consequence that emerges here is the configuration of these sensitive topologies constituting the same sensitive body. We have shown in this respect that the main difference between domestic space and public space is precisely this configuration where the sound topology exceeds the limit of the visible topology of the domestic sphere while the configuration is reversed in public space where sight goes further than hearing (Boubezari, 1997).

The Paradigm of Sensitive Topologies

These sensitive topologies, when observed in-situ are no longer just simple bodies but are made up of several bodies themselves in what we often call singular or relevant “situations” which define atmospheres.

In a previous research (Boubezari, 2001), we saw how an inhabitant is constituted by being, *modus essendi*, when he realizes his comfort by mobilizing the adequate device for a given situation or atmosphere. It was then a question of observing its interaction

with its built space and immediate sensitive environment. This interaction constituted it into a sensitive topology. And in cases where he was in company with other roommates, or audible neighbors, the situation became more complex because two sensitive topologies came into contact. This contact of two (or more) bodies enters a *modus vivendi* to merge into one, that of a more complex body, otherwise they separate and isolate themselves. To do this, they intelligently mobilize the resources of the system and its own flexibility to be modulated.

From this observation what can we draw from it as a relationship between the three sensitive modalities mentioned above, the visible the audible and the tangible?

First, the tangible topology is always enveloped by the two others and remains the core. It is the very meaning of the inhabited "milieu." Its field of action makes it possible to modify the configuration according to the situations is the inhabited space. Any intrusion being made by the sound or the visible alert on the *modus vivendi* to set up, of repulsion of maintaining distance or fusion. "We don't touch each other, we define how we see and listen to each other."

Secondly, in this incessant movement of sensitive topologies there is a very precise operating mode which depends on the codes which define these topologies. Indeed, we have observed that once constituted as a being, *modi essendi*, the inhabitant ends up constituting himself as a sign. To become one with its direct environment, the information structuring it is readable at the level of its topology because it carries a set of "ambient" codes that will allow the attraction and therefore the fusion: "being together" or "doing together," or else the maintenance or otherwise the separation which leads to isolation and consequently the maintenance of the codes of each of the topologies. They also merge their codes which are often the same. Perceptual attention is the driving force behind this mode of decoding the surrounding topologies. The body is constituted as a sign, *modi signandi*.

Finally, thirdly, strategically, the inhabitant often anticipates these tensions or creates them by what we have called modes of signifying, *modi significandi*, he will introduce his intention. It will translate its intention into readable codes at the level of its visible or audible topology. He takes control of what his environment can or must mean beyond. A metalanguage then starts with its neighborhood.

Once the comfort in its inhabited space has been controlled, the milieu is recognized by the sensitive limits where the tangible topology of the body can move there to the limits of the visible and audible topologies; the appropriated territory. We technically called this topology "usage area."

What then is the window in the domestic space in the light of sensitive topologies? This opening device deploys the visible topologies beyond the domestic sphere, beyond the field of action and movement of the body and its transforming action of the milieu. This territory where only visible and audible topologies are spread, but not tangible topology, is what we can call, from the paradigm of sensitive topology, the landscape or the soundscape.

References

- Amphoux Pascal, *Paysage sonore urbain : Introduction aux écoutes de la ville*. 1997. hal-01563926
- Amphoux Pascal, *Environnement milieu paysage* in Les faces cachées de l'urbain, 11 juillet 2000
- Augoyard Jean-François, *La vue est-elle souveraine dans l'esthétique paysagère ?* in Le Debat, Gallimard, 1991, 9 p. halshs-00380002
- Augoyard Jean-François, *Pas à pas*. Essai sur le cheminement quotidien en milieu urbain, Paris, Éd. du Seuil, 1979
- Augoyard Jean-François, *Réflexions autour de la notion de parasite sonore*, in Urbanité sonore, 1989, vol. (n°), 13 p. hal-02104006
- Boubezari Mohammed, *Habiter l'espace sonore. Quand dire, c'est faire*, Alinéa, n°10 juin 1999, p.25-38
- Boubezari Mohammed, *Predictive Soundscape Mapping*, Forum Acusticum 2011, 27. June - 1. July, Aalborg, Denmark.
- Dasture Françoise, *Monde, Chair, Vision* in actes du colloque "Maurice Merleau-Ponty, le psychique et le corporel" éd Aubier, Breuteuil-sur-Iton 1988.
- Schafer R. Murray, *The Tuning of the World*, ed. Random House Inc, 1977
- Schafer R. Murray, opening session at the 12th International Congress on Sound and Vibration 2005 (ICSV 12), held 11-14 July 2005, Lisbon, Portugal. (Proceedings)
- Merleau-Ponty M., *Phénoménologie de la perception*, Paris Gallimard, 1971 (1945), p.173
- Pallasmaa Juhani, *The eyes of the skin, Architecture and the senses*, John Wiley & Sons; 3rd Edition 2012.
- Poincaré Henri | Analisis Situs. Accessed July 06, 2020. <http://analysis-situs.math.cnrs.fr>
- Truax Barry, *Soundscape Composition as Global Music: Electroacoustic music as soundscape*, Organised Sound 13(2): 103-109 B 2008 Cambridge University Press. Printed in the United Kingdom. (Earlier versions of this paper were presented at the Sound Escape conference at Trent University, Peterborough, Ontario, July 1, 2000.

The Great Soccer Stadium: Ruptures and (Re)significations of (New) Maracanã

Natália RODRIGUES DE MELO¹,
Cristiane ROSE DE SIQUEIRA DUARTE²,
Paula UGLIONE³

Abstract. The aim of the current study is to analyze meanings and resignifications of soccer stadiums based on the concept of *ambiance*, by taking into consideration physical changes applied to them and affective relationships set with them by fans. The study has focused on Maracanã stadium (Rio de Janeiro, Brazil) after the 2014 World Cup renovation. The herein adopted analysis methodology consisted in assessing fans' narratives about the stadium and in listing metaphorical expressions that emphasize the (re)signification process of the new stadium. This (re)signification operates in the atmospheric reconstructions of these "temples of the ball" and in ruptures inherent to any transformation process.

Keywords. *Ambiance, Rupture, Resignification, Maracanã*

Introduction

Ambiance precedes and determines the modes of action and integration of all space elements associated with human relationships (Thibaud, 2004). Everything composing a given environment is surrounded by this "moral and material atmosphere" called *ambiance*. According to the aforementioned author, *ambiance* can only be understood through the embodiment of the space, whereas experience - i.e., body involvement with/movement in the environment - is what enables this environment to be (re)acknowledged. The awareness about the atmosphere of a given place is what allows users to understand it based on its emotional and affective aspects; this process also makes it liable to be stored in users' memories.

Soccer match is the event where the *ambiance* of the stadium emerges. It is in the space-time of a match that bodies/fans - with their passions and affections for soccer - move and get involved with other fans, as well as with the materialities of the place. The *ambiance* of the stadium (re)emerges in these gatherings by moving and involving sensations and symbols that (re)affect individuals and local things, and leave mnemonic marks in the atmospheric corpus of the match. Thus, every new match - which is always unique and different from the others - is a reunion experience, even if the team has changed, or the public is no longer the same, or because the materialities of the place have changed. It is the ritual of soccer that is perpetuated in the stadiums every new match.

1. Collaborating researcher at Laboratory of Architecture, Subjectivity and Culture (LASC), Rio de Janeiro, Brazil; and associate researcher at PACTE Laboratory, Grenoble, France, naty_melo@gmail.com

2. Professor in the Architecture and Urbanism School at Federal University of Rio de Janeiro, Brazil; and LASC coordinator, crsduarte@gmail.com

3. Collaborating researcher at LASC and at Social and Cultural Anthropology Laboratory, University of Liège, Belgium, desvioambiental@gmail.com

Soccer stadiums are an important part of Brazilian culture, architecture and daily life. Renovations made in the main Brazilian soccer stadiums before the 2014 World Cup were justified by improvements in safety, cleanliness and in the soccer spectacle. However, these ‘supposed’ improvements resulted in higher ticket prices, excessive surveillance and new cheering habits.

Soccer stadiums comprise a set of social relationships that corroborate the ownership taking and resignification of these places as territory (Mascarenhas, 2005). However, taking ownership of a given space is not enough to territorialize it; it is necessary accepting it as part of that territory, i.e., it is necessary “legitimizing” it as such (Raffestin, 1980). Based on the analysis conducted by Montaner and Muxi (2011), contemporary times show strong trend to intervene in cities by disregarding social and community networks. According to Roux (2014), improvements made by designers in the construction and renovation of many recently-built stadiums have emphasized another side of this process, namely: the impoverishment of the sensitive quality of these places for fans.

Did these renovations made in Brazilian stadiums change the atmosphere of these places? It was one of the issues that motivated the ethnographic study about Maracanã Stadium after the 2014 World Cup (Melo, 2018), whose main aim was to get to know and understand whether, and how, this renovation had impact on the soccer ritual taking place in the stadium and, consequently, on the atmosphere of the place, based on fans’ perspective. The current study presents metaphorical expressions taken from fans’ narratives about the meanings attributed by them to (new) Maracanã. These narratives indicate that the atmosphere of the place is remade in the experience of every new match.

Maracanã Archive

Maracanã was built for the 1950 World Cup; it was designed to be the “greatest soccer stadium” in the world. The stadium has undergone several changes throughout its extensive history of continuously hosting important matches of national and international championships. Maracanã was acknowledged by UNESCO as World Heritage Site in the 2000s; since then, renovations carried out in the stadium must, as a matter of principle, pay attention to, and respect, its original design and the cultural value linked to occupation by fans (Girão, 2013). Nevertheless, the renovation carried out in the stadium for the 2014 World Cup has significantly changed its architecture, mainly in the inside. In addition, the stadium also underwent a hyper-sectorization process that, according to Ferreira (2017), consisted in rules focused on confining fans within specific sectors that were set based on ticket price. This, and other renovations carried out in stadiums distributed all over the country, before the 2014 World Cup, were wrapped in speeches and promises to improve safety, cleanliness and the spectacle itself; consequently, they brought along higher ticket prices, excessive surveillance and new cheering habits.

The study carried out at Maracanã was based on the ethno-topographic analysis developed by the Laboratory of Architecture, Subjectivity and Culture (LASC), whose scope lied on investigating the configuration of attributes associated with a given space, in order to understand it as the materialization of cultures, subjectivities and projects of life (Duarte et. al., 2007). Participant observations and interviews with fans were also carried out. Report frameworks were built based on collected narratives. These frameworks were inspired in the “Mnemonic Place Archive” tool (Uglione, 2008) used to build collective stories about the place. MARACANÃ ARCHIVE was then

created by gathering together metaphors extracted from the fragments and traces of fans' narratives. The Archives' work lied on collecting and interweaving individual narratives by taking the metaphors shared by them as guiding thread. This procedure enabled identifying metaphorical expressions taken as signs applied to define and qualify the place for a certain group of individuals/narrators. The next section presents the five metaphorical expressions associated with Maracanã, which were identified in the interweaving of narratives by 26 fans who attended matches in the site from 2016 to 2017. The metaphorical expressions comprised Campo de Batalha (Battlefield), Lugar Mágico (Magic Place), Colosso (Colossus), Teatro de Sonhos e Emoções (Theater of Dreams and Emotions) and Engomadinho (Gussied-up).

Metaphorical Expressions

The first metaphorical expression - **Battlefield** - describes soccer matches as a “war,” whereas the stadium is the territory of dispute between opponents. The enemy is temporary, but the ambiance generated in the combat taking place in the stadium creates and invokes the symbolism capable of sustaining present and future battles.

This expression highlights the formation of micro-ambiances⁴, as well as of waves capable of dissolving them. Although both micro-ambiances and waves are different in each match, they accumulate and reproduce great behavioral and symbolic similarities. Micro-ambiances are like trenches created for confrontations outspread throughout the territory. Organized fan groups are an example of micro-ambiance often observed in stadiums. Members of these groups were forced by stadium managers to establish their trenches in the center of the Northern and Southern sectors, at the upper level; however, they spontaneously expanded their territory to the sides and to the lower level of these very same sectors, where they created a border emphasized by chants, flags and t-shirts with team colors and symbols of each organized fan group. Another micro-ambiance typical of Maracanã stadium is the one formed by “former terrace goers,” i.e., fans who used to watch matches from terraces - this term refers to a well-known standing area close to the field, where fans watched soccer matches before the area was terminated in the 2007 renovation. These fans form borders when they lean over the partitions next to the field, sometimes cursing the players and sometimes cheering; thus, they reinforce their territory.

Micro-ambiances help better understanding territory domination due to part of the right acquired in the **Battlefield**. There is no longer the “free territorialization” featured by the free circulation of individuals seen in the past, which is currently hampered by hyper-sectorization into predetermined areas. On match days, fans can transform the stadium into a dispute field; consequently, they take ownership of this territory. According to Haesbaert (2011), this process often takes place through identification, as well as through the combination of controls, functions and symbolizations.

The second metaphorical expression - **Magic Place** - represents the transcendence of Maracanã stadium. It reflects the ascendancy of the ambiance embedded in the enchantment produced by the “soccer giant” in its fans. This expression refers to the

4. *Micro-ambiances are smaller fragments circumscribed to a larger ambiance. They comprise small groups of individuals who “share and/or experience the same event, the same activity in a given space, whose sensitive features enable social practices that constitute lesser reverberating borders” (Lira, 2015, 64). Based on Edensor (2015), micro-ambiances clarify constant changes in sensitive elements and space occupation dynamics. Stadium micro-ambiances exist due to fans' need to mark their territory, to be identified and to give visceral responses to their club.*

magic dimension of the place 'Maracanã', which is wrapped in rites and bears a soul. This soccer temple has launched mass cheering patterns, "invented" idols and created unusual ways to encourage teams. It shelters memories of unlikely championship finals and ghosts of great defeats. It enabled creating a fan identity and resolved differences.

One of the examples of Maracanã's magic emerges when idols, or even great decisive matches, are remembered, which means that this place worked as stage for something memorable. However, the stadium does not lose its magic when it is also remembered for having been the place of defeats. These fragments are activated by fans, who use their memories to find their place and feel like they belong to Maracanã. According to Tuan (1977), the construction of myths is not a thing of the past; it is based on the knowledge people have as individuals and as members of a certain society, and it is strongly adhered to the place.

According to many fans, Maracanã remains the largest stadium in the world. Although its maximum capacity was reduced in the last renovation to approximately 79,000 fans, as opposed to the 200,000 seats that it had before, it remains giant in its potential, echo and representativeness of soccer and world architecture. It is an icon and a monument; many individuals think that way, since the idea of the third metaphorical expression - *Colossus* - has significantly emerged in the narratives of some fans.

However, this dimension of Maracanã's grandeur is mainly guided by the symbolic field and by marks left in time. In addition, the grandeur of the stadium changes based on the ambiance of each match, since it is not only represented by the physical size of it, but mainly by the circulation of sensitive elements.

The fourth metaphorical expression - *Theater of Dreams and Emotions* - synthesizes the role-playing taking place in the stadium during soccer matches, where fans are both spectators and participants of what happens on the football stage. This expression focuses, above all, on representations involving soccer matches and the whole ritual developed by this role-playing.

It is possible saying that the theatricalization of Maracanã's *Theater of Dreams and Emotions* on match days starts with the preparation rituals and extends to the urban surroundings of the stadium before each match. For example, fans duly dressed in their team's jerseys can be seen drinking, talking and singing in bars in the stadiums' surroundings. There are always many vendors selling food, drinks, souvenirs, as well as fans dressed in the colors of their teams, fulfilling the role of pre-match cheerleaders. Although the match is seen as a great battle, the ritual preceding it is quite festive, effusive, with hints of tension, but, above all, it is very representative.

The *Theater of Dreams and Emotions* is the rupture in the everyday life. Cheering is a party where ordinary people dress up as fans, transform themselves and give themselves body and soul to this joyous event of cheering for their teams. At the end of the match, fans go back to their homes and the final ambiance gradually fades away, while their remnants still hang over the stadium and the fans until none of them are seen anymore. The curtain falls.

Finally, the fifth metaphorical expression - *Gussied-up* - summarizes the reverberation of anguish, sadness and outrage associated with the renovation carried in Maracanã stadium. The sentence "it is no longer the same Maracanã" was uttered several times by fans.

According to some fans, Maracanã remains the giant. However, others think that it was greater in the past since its greatness was associated with its previous welcoming and popular nature. The fact that fans were not consulted about the changes made in Maracanã made them feel marginalized and even more resistant to changes, which increased the feeling that the place was diminished.

Fans also feel stunted and monitored by what they consider an excess of security in the *Gussied-up* stadium. The ambiance of the stadium is permeated by controlled surveillance, and it gives a lesser spontaneous nature to the match. However, fans are transgressors; little by little they take ownership of what is rightfully theirs, namely: the right to encourage their teams. They no longer follow the numbering of chairs, they use empty spaces like improvised bleachers (stairs, places with broken seats, sector divisions, ramps), they stand up, jump and try to break away from every order of control. According to Roux (2014), the symbolic victims of the paradigm shift in these facilities - i.e., the “standing places” - are vigorously combated by new stadium designers. *Gussied-up* certainly refers to a process that can be called dis-belonging. According to Heidegger (1966), this process is always associated with the pursuit of meaning when one experiences some loss, which, in the case of these fans, refers to the fact that they no longer feel like part of Maracanã stadium.

Final Considerations

Although the renovation carried out in Maracanã stadium has caused undeniable ruptures in fans’ habits and visions, it is still possible finding traces of the past and seeing how they affect new occupations and new adherence to the current version of the stadium.

The observations of metaphorical expressions enabled noticing the global trend to change the physical space and to dictate fans’ behavior inside new arena-stadiums. However, new signs and syntaxes are adapted, violated or incorporated as fans are introduced to the ambiance of each match.

Maracanã is no longer the same and that is undeniable, but the ambiance remains in the stadium! The herein analyzed metaphoric expressions enabled perceiving some fans will never be able to re-signify the stadium, whereas others will be able to do it by attributing new meaning to the place based on its ambiances, although they know that the stadium will always change, either due to necessity or imposition (Peixoto, 1996). The renewed Maracanã is a palimpsest comprising symbolic layers linked to other symbols and capable of leading to a new order of understanding, perception and affection.

References

- Duarte, C.R.; Brasileiro, A.; Santana, E. P.; Paula, K. L. de; Vieira, M.; Uglione, P. O Projeto como Metáfora: explorando ferramentas de análise do espaço construído. In: Duarte, C. R. de S.; Rheingantz, P. A.; Bronstein, L.; Azevedo, G. *O LUGAR DO PROJETO no ensino e na pesquisa em arquitetura e urbanismo*. Rio de Janeiro: Contra Capa/ PROARQ, 2007.
- Edensor, T. *Producing atmospheres at the match: Fan cultures, commercialisation and mood management in English football*. Emotion, Space and Society, 2015
- Ferreira, F. da C. *O estádio de futebol como arena para a produção de diferentes territorialidades torcedoras: inclusões, exclusões, tensões e contradições presentes no novo Maracanã*. Doctoral Thesis. Rio de Janeiro: UERJ, 2017.
- Girão, C. *Maracanã: destruir ou preservar*. Vitruvius, ano 12, fev. 2012.
- Haesbaert, R. *O mito da desterritorialização*. Do “fim dos territórios” à multiterritorialidade. Rio de Janeiro: Bertrand Brasil, 2011
- Heidegger, M. Lettre sur l’humanisme. In: *Question III*. Trad. R. Munier. Paris: Gallimard, 1966.
- Lira, E. M. R. *Um convite à reciprocidade: Bordejando ambiências e [contra] fluxos urbanos-humanos*. Doctoral Thesis. Rio de Janeiro: UFRJ, 2015.
- Mascarenhas, G. A mutante dimensão espacial do futebol: forma simbólica e identidade. In: *Espaço e Cultura*. Rio de Janeiro: UERJ, nº. 19-20, 2005, p. 61-70.
- Melo, N. R. *O GRANDE PALCO FUTEBOLÍSTICO*. Ambiência e memória no estádio do maracanã pós-reforma para a copa de 2014. Doctoral Thesis. Rio de Janeiro: UFRJ, 2018.
- Montaner, J. M.; MUXÍ, Z. *Arquitectura y política*. Ensayos para mundos alternativos. Barcelona: Editorial GG, 2011.
- Peixoto, N. B. *Paisagens urbanas*. São Paulo: Editora Senac, 1996
- Raffestin, C. *Pour une géographie du pouvoir*. Paris: Litec, 1980.
- Roux, J-M. L’ambiance des stades. In: *Dossier “Grands stades en quête d’urbanité.”* Urbanisme, 393. France, 2014.
- Thibaud, J-P. O Ambiente Sensorial das Cidades: para uma abordagem de Ambiências urbanas. In: Tassara, E. T. O; Rabinovich, E.P.; Guedes, M. C. (Eds.). *Psicologia e Ambiente*. São Paulo: Educ, 2004.
- Tuan, Yi-Fu. *Space and place: the perspective of experience*. Minneapolis: University of Minnesota Press, 1977.
- Uglione, P. *A Memória na cidade e a invenção do lugar*. Doctoral Thesis. Rio de Janeiro: UFRJ, 2008.

Urban Sonic Research and Sound Map

soundinbetweenness.org

Sena KARAHAN¹

Abstract. “Can sound be defined as a factor in the social reproduction of space?” The research culminated in the production of a sound map based on soundwalk recordings, soundscape analysis, and surveys. To better understand the relation of sound, individual & environment in urban fields, we aim to collect crowdsourced data through the website. Soundwalks have been converted into flipbooks of sound postcards - embedded QR codes - allowing users access to the website. Here, users can create postcards (upload field-records), participate in the survey, get to contribute to the body of sonic data pertaining to the urban environment, individual experiences to be then used as a resource for further soundscape analysis and to create awareness of everyday sonic fields in order to discuss urban public spaces.

Keywords. Sound Map, Urban Soundscapes, Everyday Life, Participation, Sound-postcard, Flipbook

Urban Sonic Research

Architecture is not a steady phenomenon. The spaces move and resonate between bodies and objects through sound. Due to their physical attributes, sound as a dynamic element of space creates continuous affection between objects and living creatures, allowing them to act upon space as its subjects and objects.

Soundscape as a concept refers to the totality of the sounds present in a physical environment. It examines the relationship between the space constructed out of sound and its perception by the individual or society/community (soundscapes studies are not limited to anthropocentric research) (Panye, Davies and Adams, 2009).

In his work *Acoustic Communication* (1984), Barry Truax elucidates the continuously evolving relationship between environment, sound, and individual by considering the individual simultaneously as a sound source and a listener. In this sphere, the movement of sound blurs the border between society and the individual, thus turning physical space into a social one reproduced continuously in the urban context via the daily movement of all things, living and inanimate alike. Also, sound produces different human experiences without becoming independent of its context as it emanates from its source and reaches its target. LaBelle in his book, *Acoustic Territories: Sound Culture and Everyday Life* (2010), analyses sound as a deep and widespread expression of culture, and asserts that an entire culture and history can be found within a single piece of sound. Sound, existing as energy and continuously transforming itself as such, spreads to the void, which allows it to operate as an area of sharing, thus enabling plurality. The intensity and grace with which sound may create a relational space, a meeting point, diffuse and yet pointed; a private space that requires something between, an outside; a geography of intimacy that also incorporates the dynamics of

1. Ph.D.Student, Urban Planning, Mimar Sinan Fine Arts University, sena.karahan@gmail.com

interference, noise, transgression (xvi-xvii). Due to its versatile nature, sound constitutes the inclusive component of spatiality; it is heard, it contacts, it interacts, transforms itself and then disappears. In this context, it allows the recurrent and inevitable restructuring of the invisible bonds between the individual/body and the society, each time in a different way than the previous one (Karahan, 2019).

Lefebvre asks: How can everyday life be defined? It surrounds us, it besieges us, on all sides and from all directions. We are inside it and outside it (2002, 41). According to Lefebvre, social space in the occurrence of the rhythm of everyday life is not a thing among things or any product among products. It contains their coexistence and their relationship within their simultaneity, therefore containing relative order and/or disorder (Lefebvre, 2014, 99). Social space does not occur as a product of a set of rules, it is generated by life itself. Sound as an energy within the relationship between the individual and the society, blurs the distinction between interior-exterior and helps us (Stavrides, 2016) discovering the relationship between “inside” and “outside,” and not simply the beyond of the body or the periphery. Soundscapes, which are being generated as a threshold space and defeating potential fictions of social space at the moment, offer proximity, distinction and rhythm to the bodies meeting within the invisible (Lefebvre, 2014, 180). The sound that does not discriminate and the social space it affects, offers a cultural soundscape. The geographical structure, the fauna, flora, built environment, economic dynamics, technology, population, belief and orientation systems of a city are sources constituting the cultural soundscapes of a city.

In this context, urban soundscapes offer a wide and diverse field of study. The concept gained increased popularity in the 21st century, and soundscapes have demonstrated themselves to be a significant field of discourse in the studies on urban space and the evaluation of sound in everyday life (Augoyard and Torgue, 2005; LaBelle, 2010; Lacey, 2014; Raddichi, 2013, 2017, 2018; Thibaud, 2011, 2015; Wunderlich, 2013).

In this work, soundscapes are evaluated as a field of encountering and struggle, as threshold spaces (Stavrides, 2016). In relation to that, the field research took place along the coastline of Galata, Karaköy, a cultural and physical threshold space. This old gate was the key point where the industrial and electrical revolution met with Istanbul. On the other hand, in the short history of the republic, the political economy of Turkey has left deep scars on the urban morphology and in the demographic structure of Galata City.

Today, whilst the rhythms of everyday life of this area are facing major restructuring or eradication through gentrification, mega ‘renewal’ projects, it also enhances the importance of a discourse about sound and social space built through sound, problematization of change in public space and the experience of spatiality in public space.

This project, which has been realized with the help of the research grants given by Mekanda Adalet Derneği (Center for Spatial Justice), is the continuation of the master thesis; “Social Reproduction of Space and Soundscapes.” The sound mapped field re-studied and converted to an online platform. In the research, soundscape samples of everyday life of the area have been recorded with a Zoom H6 Handy Recorder (X/Y 120°) and analyzed by applying widely accepted methods in this domain such as soundwalks (thesis March 2017 - December 2018, MAD Research October 2019 - December 2019) and soundscape analysis.

This work, which examines the discourse of public space in urban environments through the notion of “sound” which allows for physical and social bonds to be built, has been conceived to include different agents to the research and thus transferring

the sonic maps to the virtual environment.

In order to emphasise the relationship of the participation with the online platforms - www.soundinbetweenness.org - we have worked on the motive of “postcard,” which can easily be articulated within the framework of everyday life practices, and one of the soundwalks has been designed as a flipbook.



Figure 1. Flip-soundmap-book

The origin of the soundwalks has been selected with reference to the ferries; indispensable objects of everyday life, which also are cultural and industrial heritages of the neighborhood and the city. The term ‘soundmark’ often used in soundscape analysis refers to a sound having unique qualities and importance for a community. For the case of Istanbul, these sounds can be church bells or the azan, which have dominated the sonic landscape in that area for centuries. For the specific case of Galata, this would be the ferry whistle. Therefore, the ferry port of Karaköy has been determined as the origin of walks and mapping.



Karaköy Ses Yürüyüşü 14:34-15:11 2019/12/20

Figure 2. A display of the route of the stroll that can be seen in the flipbook

The stroll that took place between the Karaköy ferry port and the speedboat port of Galata between 14:34 and 15:11 at 2019/12/20 has been transcoded to the manual animation consisting of sonic postcards.

Figure 3. Front and backside of the sonic postcards



The detachable cards in the book have been instrumentalized to emphasize the relationality of the user, to expand the field of interaction and exchange, and to facilitate the access to digital interfaces. The QR codes that can be found on the backside of the cards are able to transmit the sound of the specific location represented at the given moment, thus enabling a temporal layering in the experience of space.

The yellow colored area coded in the map represents the range of motion for sound and the social/common space built with sound². In this two-dimensional representation (see Figure 2, the present urban texture of the city has been layered with the topographic and archaeological map of Galata (SALT archive), different eras and rhythms of the city have been compared³. The Google Street View images that were used have been selected due to the fact that they comprehend different temporalities, allow for randomness and are instantly accessible.

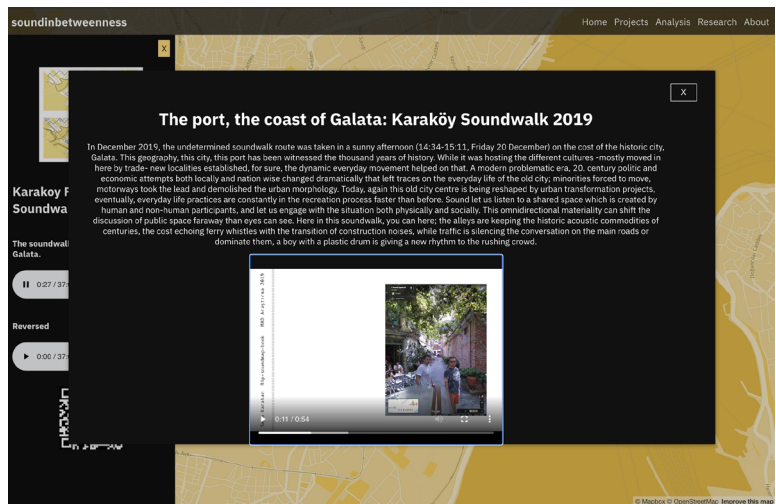

Figure 4. Excerpt from a soundwalk map from the book

2. The map of Italian architect and surveyor Giambattista Nolli (1748). Nolli defines shaded areas as positive masses while unshaded areas as void of mass. In addition to that he expands the relationship of public and private. While the shaded areas define private spaces, the unshaded/white areas define the use of public (street, churches, chatetrels).

3. The morphology of Galata experienced the most radical change in the interventions in the second half of the 1950s. The streets and built surroundings of the city were torn into wide streets opened on the planned motor vehicle traffic axes (Gül, 2009; Kafescioğlu, 2016).

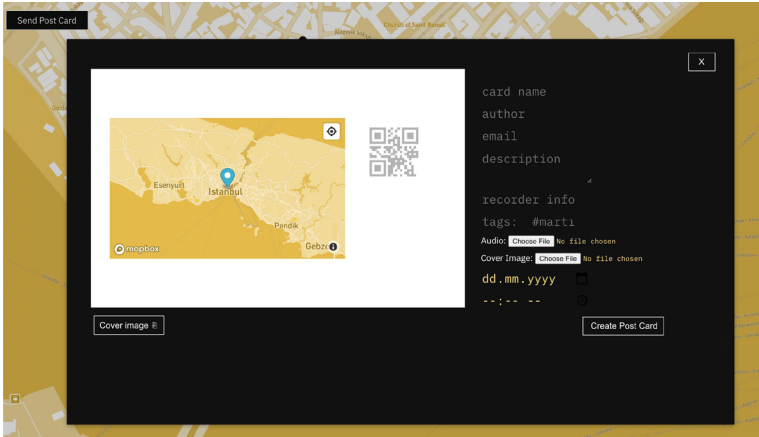

Figure 5. Sonic postcard loading screen

The screenshots Figure 4 and Figure 5 are from soundinbetweenness.org, which at the same time also is the main platform for the research to deepen and diversify. Developed by Ahmet Liva Cengiz, the role of the user in this website is key. The website, which can be accessed via sonic cards, allows the users to not only listen to the existing recordings, but also lets them map and upload the recordings of their own (mapping can take place globally). Via a survey interface targeting the contributors of the sound maps, the generation of an experience map is intended. As the archive gets richer and more diverse over time, a process that allows urban space analysis and processing of data on various concepts is conceived. Also, another longer-term goal is to generate soundscape compositions by applying AI on the recorded data.

Furthermore, as declared before, the website and studies aim to discuss the critical role of sound in everyday life and tries to multiply the actors who participate in the public space. As sound which blurs the borders of public space and the bodies, this website could be an interdisciplinary tool. Therefore, another component that is intended is the consolidation of the collective structure and to provide a platform for multi-faceted discourses for projects/works focussing on space and urbanism in order to design, more inclusive public spaces, and deeply analyze the notion of public space.

For more info and sonic data please visit: www.soundinbetweenness.org

References

Aletta, Francesco, and Jieling Xiao. "What are the current priorities and challenges for (urban) soundscape research?." *Challenges* 9, no. 1 (2018): 16. <https://doi.org/10.3390/challe9010016>

Augoyard, Jean-François, and Henry Torgue, ed. *Sonic experience: A Guide to Everyday Sounds*. Translated by Andra McCartney and David Paquette. Montreal: McGill-Queen's Press. 2014.

"Galata'nın Topografik ve Arkeolojik Planı - Galata Topographisch-Archaologischer plan mit erläuterndem text von A.M. Schneider und M. Is. Nomidis [Istanbul] - Topographical and Archaeological Plan of Galata", SALT Research, Accessed May 20, 2020. <https://archives.saltresearch.org/handle/123456789/102336>

Gül, Murat. *Emergence of modern Istanbul: Transformation and modernisation of a city*. IB Tauris, 2009.

Kang, Jian, and Francesco Aletta. "The impact and outreach of soundscape research." *Environments* 5, no. 5 (2018): 58.

Karahan, Sena. "Social Reproduction of Space and Soundscapes." Master Diss. Istanbul Bilgi University 2019.

LaBelle, Brandon. *Acoustic Territories: Sound culture and everyday life*. USA: Bloomsbury Publishing. 2010.

Lacey, Jordan. "Rupturing urban sound (scape) s: spatial sound design for the diversification of affective sonic ecologies." Ph.D.Diss. RMIT University 2014. <https://researchbank.rmit.edu.au/view/rmit:161186/Lacey.pdf>

Lefebvre, Henri. *Mekânın üretimi*. Translated by Işık Erguden. Istanbul: Sel Yayıncılık. 2014.

Lefebvre, Henri. *Critique of everyday life: Foundations for a sociology of the everyday* Vol. 2. Translated by John Moore London & New York: Verso.2002.

Orçun Kafesçioğlu, Figen. "19. Yüzyılın İkinci Yarısından Günümüze Galata/Karaköy'de Kent Morfolojisi ve Yapı Türlerinin İncelenmesi." *IDEALKENT* 7, no. 18 (2016): 174-203 <https://dergipark.org.tr/en/pub/idealkent/issue/36793/419092>

Payne, Sarah R., William Davies, and Mags Adams. "Research into the practical and policy applications of soundscape concepts and techniques in urban areas (NANR 200)." (2009). <http://usir.salford.ac.uk/id/eprint/27343>

Radicchi, Antonella. "The sonic niche-A new design tool to enhance and create atmospheres with sounds in the contemporary city." *Ambiances in action / Ambiances en acte(s) - International Congress on Ambiances, Montreal 2012*, Sep 2012, Montreal, Canada. pp.253-258. ([halshs-00745534](https://halshs.archives-ouvertes.fr/halshs-00745534))

Radicchi, Antonella. "Emotional geography & soundscape studies: beyond the cognitive approach in (sound) mapping urban spaces." In Conference: the EAEA11 Envisioning Architecture: Design, Evaluation, Communication. 2013.

Radicchi, Antonella. "The Notion of Soundscape in the Realm of Sensuous Urbanism: an Historical Perspective." In Wilson, A., (ed.), *Listen! Sounds Worlds from Body to Cities*, Cambridge Scholars Publ. 2019

Stavrides, Stavros. *Kentsel Heterotopya, Özgürleşme mekânı Olarak Eşikler Kentine Doğru*. Translated by Ali Karatay. Istanbul:Sel Yayıncılık. 2016.

Thibaud, Jean-Paul. "A sonic paradigm of urban ambiances." *Journal of Sonic Studies*, 1 (April 2011): 1-11. ([hal-00980746](https://hal.archives-ouvertes.fr/hal-00980746))

Thibaud, Jean-Paul. "The backstage of urban ambiances: When atmospheres pervade everyday experience." *Emotion, Space and Society*, Volume 15 (May 2015): 39-46. <https://doi.org/10.1016/j.emospa.2014.07.001>

Truax, Barry. *Acoustic Communication*. New Jersey: Ablex Publishing. 1984.

Wunderlich, Filipa Matos. "Place-temporality and urban place-rhythms in urban analysis and design: An æsthetic akin to music." *Journal of Urban Design* 18, no. 3 (2013): 383-408. <https://doi.org/10.1080/13574809.2013.772882>

The Ambience of Tension

Socio-Spatial Negotiation as Urban Cultural Heritage

Rachel IAMPOLSKI¹

Abstract. Inherent in urbanity is tension, where the “weak tactics of the strong,” which lead the formal shaping of our cities are negotiated by the “strong tactics of the weak” (de Certeau, 1984), a reactive performance by its citizenry. An example is the citizen-led repurposing of urban form, where new meaning and function is assigned to a site, and in doing so, a distinct atmosphere produced. This paper explores how the socio-spatial response to this tension contributes a distinct element of a city atmosphere, while challenging the dichotomization of tangible and intangible cultural heritage. By drawing on ethnographic observation of the use of the steps in front of Flinders Street Station in Melbourne, this paper aims to conceptualize urban atmosphere as the result of this reactive process.

Keywords. *Cultural Heritage, Spatial Practice, Tension, Embodiment, Urban Culture*

Introduction

An inherent part of urban life is tension - tension between the tangible and intangible, and the formal and informal city. Resultingly, a prominent part of urban atmosphere is the socio-spatial negotiation of this tension - a significant “spatial practice” (Lefebvre, 1991) that is often performed in banal, everyday ways in cities. An example of this negotiation, which will be the focus of this paper, can be seen in the citizen-led reclaiming and repurposing of built urban form. Particularly, built form and structures with a different (possibly conflicting) primary function, such as people using stairs, stoops or ledges as somewhere to sit, rest and gather. This spatial practice, which can be seen regularly occurring across cities and the public realm - from hospitality workers using milkcrates as somewhere to sit while on a smoke break, to nightclub goers using the footpath in front of a venue to socialise or the street curb to sit and wait for a cab - contributes to the public culture of a city and ambience of the ‘urban’. As Sumartojo and Pink (2018) suggest, “urban environments are experientially constituted by many very mundane elements that shape what it feels like to be in a city, and in the specific localities from which they are comprised.” These mundane spatial practices constitute a significant part of a city’s (or site’s) atmosphere and heritage. This embodied spatial practice often emerges as a negotiation of tension between the physical, or sanctioned city apparatus (such as urban planning, zoning of activities, spatial regulation, etc.) and the more informal, socialised elements of existing in a city. This paper will explore how this negotiation contributes to a unique, urban atmosphere, and how (re)focusing on the affective experience and reaction to this tension can assist in nuancing existing heritage frameworks.

¹. RMIT University - Centre for Urban Research, Melbourne, rachel.iampolski@rmit.edu.a

Socio-Spatial Tension in Cities

Lefebvre (1991) proposed that space is socially produced within tension, and concrete forms or the ‘texture’ of the city is given meaning through its use and reuse: “The subject experiences space as an obstacle, as a resistant ‘objectivity’ at times as implacably hard as a concrete wall, being not only extremely difficult to modify in any way but also hedged about by Draconian rules prohibiting any attempt at such modification” (1991, 57). The defining of space through barriers of access and sanctioned activity creates tension and, and often an othering process. However, the way that inhabitants subvert and negotiate these tensions, frequently in an embodied manner, is similarly constitutive of urban life and space. To reference Lefebvre conception of the power of bodies in space; “each living body is space and has its space: it produces itself in space and it also produces that space” (1991, 170).

The power of bodies in creating, disrupting and recreating boundaries can be seen in an example from Stevens (2007) research into ‘loose space’, where skateboarders use cement form and rails as somewhere to skate (despite what is otherwise a bounded form with a perceived orderly function). Highlighting the ways that “through their actions, people can loosen the physical conditions of space as well as the social and representational conditions” (ibid., 63). Similarly, Massey (1999) points out how young people respond to a lack of suitable, sanctioned spaces within which they can exist (as they are often not able to access certain venues due to age restrictions), by loitering in public. Which in turn, creates another bounded, representational space, not least a form of public culture (i.e. ‘urban youth culture’).

In this way, the response to the boundaries and defining of urban space become just as significant as the physical and social parameters that create these boundaries and tensions in the first space. This process of reconstituting spatial parameters and negotiating spatial tensions, leads to the recreation of social relations and as such, the ‘production of space’ and our urban experience (Lefebvre, 1991). What’s more, in adopting an agonistic theory stance, as the conflict that it negotiated within this production is likely inevitable (Hillier, 2003; Mouffe, 1999), then so too is this form of cultural production.

This negotiation can be seen in how physical form (a tangible, often formal element of a city) is repurposed by citizens (an intangible, often informal process). Or as de Certeau (1984) proposes, the ‘weak tactics of the strong’, which lead to the formal shaping of our cities (i.e. urban planning/design, development, commercialisation) often become negotiated and subverted by the ‘strong tactics of the weak’ (an intentional, or unintentional reactive process led by citizens, such as the skateboarders referenced in Stevens (2007) research).

Embodied Negotiation of Tension

Though often a relatively passive, or banal act, sitting on steps or ledges - which are designed for movement - is arguably a way in which tension is represented in the city. There is tension between how the physical form regulates our movements, and dictates a certain type of socio-spatial behavior (or a ‘resistant objectivity’ (Lefebvre, 1991, 57)), and the desire to exist in the city in a different way. This “thrown togetherness of bodies, mass and matter, and of many uses and needs in a shared physical space,” contends Amin (2008, 8), is inherent in urban public culture, and arguably by extension, atmosphere, as our bodies are “regulated by the rhythms of invention, order and control generated by multiplicity” (ibid., 8). The embodied negotiation of such tension creates a distinct, urban ambience - both for the individual repurposing the built

form, and for any spectators. This embodied negotiation creates for an affective experience of atmosphere, and of the ‘urban’. Or of being “citized,” as Grosz (1999) suggests - “the city is made and made over into a simulacrum of the body, and the body, in its turn, is transformed, ‘citized’, urbanised as a distinctly metropolitan body” (242).

Embodiment as a way of defining space, and creating and experiencing ambience, can also be thought of in terms of the embodiment of socio-spatial rights. In embodying tension, we embody our capacity to assemble and perform politics (Butler, 2005) and embody our rights to the city. Harvey (2008) contends that “the right to the city is far more than the individual liberty to access urban resources: it is a right to change ourselves by changing the city” (23). In ‘changing the city’ through our bodies, in ‘assembling’ and negotiating space - even (or especially) through relatively banal interventions in the urban landscape such as sitting on steps - we, arguably, contribute to a city ambience.

Flinders Street Station Steps



Figure 1. Flinders Street Station Steps, Authors image, August 2019

Fieldwork and observational analysis conducted in Melbourne, Australia at Flinders Street Station steps revealed how ‘strong tactics of the weak’, contribute to a city’s identity and ambience. Flinders Street Station is a busy central station in Melbourne city. A grand, building, with a large dome and clocks, Flinders Street Station can easily be considered an ‘iconic’ site in the Melbourne imaginary, and plays an important role in the city’s tourism and branded identity. Often known for its architectural significance, the actual steps to the buildings main-entrance however, also hold a cultural and civic significance.

The steps to the station, and footpath immediately in front of the steps, are often very busy - be it from people entering/exiting the station, waiting to cross or coming off the busy intersection directly opposite, or waiting, often to meet someone else

(and not always necessarily someone coming off a train commute). Which has given birth to the common phrase “meet me under the clocks.” In the late evening, the steps are also often still busy, due in part to the nearby bars/pubs and fast food venues. The station steps often have people sitting on them, despite being a busy thoroughfare, and designated seating available nearby (including the Federation Square, the city’s main public square, being just across the road). People use the steps as somewhere to sit, wait and/or loiter, sometimes tucked to the side of the steps and other times sitting right in the middle of foot traffic, almost as though to intentionally take up space (see figure 1). The function of the form, as a set of stairs, becomes repurposed as a site to also gather and engage in public culture, and the idea of ‘meet me under the clocks’ becomes a part of the urban imagination and produces a distinct atmosphere.

Interestingly, the atmosphere created in the embodied response to tension, can contribute to a new layer of tension. Arguably, atmosphere can take a ‘disciplinary role’ (Buser, 2017), and impact on what is deemed the appropriate use of a space. Hence, when a site is repurposed, and with it the ambience altered, it impacts on how the site is used after the fact. For example, when observing Flinders Street Station steps, often one could see people sitting in the middle of the stairs, usually in groups, and disturbing quite explicitly the flow of foot traffic. As such it was observed that some pedestrians existing/entering the station would respond to the ‘convivial’ or dominating atmosphere on the steps with a displeased or annoyed expression. Other times you could observe pedestrians feeling uncomfortable as they tried to circumnavigate the seated people, wincing somewhat, and trying to get around the group(s) without getting in their way, as if that was their responsibility as a pedestrian. As the steps function was reassigned by those who took up space to sit, there appeared to be an ambience of ‘dominance’, or territorialisation, which pedestrians would react differently to.

In the case of Flinders Street Station steps, the form (including its spatial characteristics and broader geographic context) is assigned new meaning through this distinct socio-spatial use (of repurposing the steps to sit and loiter), and as such facilitates a reactive public culture and atmosphere. The form gives meaning to this cultural performativity, and cultural performativity (and engagement in spatial justice more broadly) gives meaning to this form, and hence the delineation between the two becomes very complicated, if at all possible. The way that it is repurposed, and the tension that exists within it, contributes towards the distinct atmosphere that makes it an ‘iconic Melbourne site.’

Towards an Affective Understanding of Heritage

Switching focus to the heritage paradigm, since the adoption of the 2003 UNESCO convention for the *Safeguarding of Intangible Cultural Heritage*, the distinction between tangible and intangible cultural heritage has become commonplace in heritage discourse and policy (Smith, 2014). Tangible cultural heritage often refers to “material, non-renewable and fragile” forms (Smith, 2014, 135), and intangible cultural heritage, as defined by the UNESCO convention, refers to “practice, representations, expressions, knowledge, skills” (UNESCO, 2003, Article 2). This dichotomisation has received increasing scholarly criticism, based on the idea that tangible and intangible elements of heritage cannot be appropriately distinguished (Kaufman, 2013; Smith, 2014).

The significant public culture and atmosphere that exists at Flinders Street Station steps for example, does not fit neatly into this binary framework of heritage. It in fact exists, exclusively, at the nexus of the tangible (the steps) and the intangible (the act

of repurposing them). Moreover, it is the tension *between* these two that creates the distinct atmosphere, and culture, of the steps. If tension emerges however, at the nexus of the tangible and intangible city, how can the significant, even 'iconic', atmosphere of Flinders Street Station step be preserved within a heritage framework?

Perhaps the existing heritage paradigm needs to be expanded to include an *affective* consideration of heritage and site. Let us consider the urban atmosphere that is produced as a result of the negotiation of socio-spatial tension. As Anderson (2014) suggest "we can understand both affective atmospheres and structures of feeling as processes of *mediation* that mix the formed and formless, emergent and finished, *structural and ephemeral*" (161, emphasis added). As discussed, much of a city's implicit, but significant, urban atmosphere and public culture occurs as a reactive process to socio-spatial tension, emerging as a *by-product of the nexus between the tangible and intangible city*. An *affective* and embodied understanding, and valuation, of living heritage may as such offer a bridge between the tangible/structural and intangible/ephemeral conceptions of heritage (helping to collapse this binary), and in doing so allow for greater consideration (and preservation) of atmosphere within the heritage paradigm.

References

- Amin, Ash. "Collective Culture and Urban Public Space." *City* 12 (2008): 5-24.
- Anderson, Ben. *Encountering Affect: Capacities, Apparatuses, Condition*: Taylor & Francis Group, 2014.
- Buser, Michael. "Atmospheres of Stillness in Bristol's Bearpit." *Environment and Planning D: Society and Space* 35, no. 1 (February 2017): 126-45.
- Butler, Judith. *Notes Toward a Performative Theory of Assembly*. Cambridge, Massachusetts; London, England: Harvard University Press, 2015.
- Certeau, Michel de. *The practice of everyday life*. Berkeley: University of California Press, 1988.
- Grosz, Elizabeth. "Bodies-Cities," in *Feminist theory and the body: A reader*, edited by Price, Janet & Shildrick, Margrit, 381-387. Edinburgh: University Press. 1999.
- Harvey, David. "The right to the city." *New Left Review* 53 (September 2008): 23-40.
- Hillier, Jean. "Agonizing over Consensus: Why Habermasian Ideals Cannot Be 'Real.'" *Planning Theory* 2 no. 1 (2003): 37-59.
- Kaufman, Ned. "Putting Intangible Heritage in its Place(s): Proposals for Policy and Practice." *International Journal of Intangible Heritage* 8, 2013: 20-36.
- Lefebvre, Henri. *The production of space*, Malden MA: Blackwell Publishing (1991).
- Massey, Doreen. "The Spatial Construction of Youth Culture," in *Cool Places: Geographies of Youth Culture*, edited by Skelton, Tracey and Valentine, Gill, 121-130. London: Routledge. 1998.
- Mouffe, Chantal. "Deliberative Democracy or Agonistic Pluralism?" *Social Research* 66 no. 3 (1999): 745-58.
- Smith, Laurajane & Akagawa, Natsuko. *Intangible Heritage*, London: Routledge, 2009.
- Smith, Laurajane. "Intangible Heritage : A challenge to the authorised heritage discourse." *Revista d'Etnologia de Catalunya* 39 (2014): 133-142.

Stevens, Quentin. "Betwixt and between: Building thresholds, liminality and public space," in *Loose space: Possibility and diversity in urban life*, edited by Franck, Karen & Stevens Quentin, London: Routledge. 2007.

Sumartojo, Shanti, and Pink, Sarah. *Atmospheres and the Experiential World : Theory and Methods*. Milton: Taylor & Francis Group, 2018.

UNESCO. *Convention for the Safeguarding of the Intangible Cultural Heritage*. New York: UN Publishing, 2003.

Women's Action of Urban Guerrilla

Methodological Path for an Urban Analysis from a Gender Perspective

Cândida ZIGONI¹

Abstract. The perception of women in the city as a strategy for acknowledging the urban space enabled the development of design practices and experiences such as the Women's urban Guerrilla in Rio de Janeiro, an ephemeral action to broaden the spectrum of experiences and connect the ambiances felt during a path into physical interventions in the city. In order to develop a methodological path that understands subjectivity as an instrument to bring the collective closer, concepts such as tactical urbanism and its guidelines contributed to the apprehension of space by a body scale and its experiences, as well as to the re-sensitization of design practices and normative urban analysis.

Keywords. *Ambiances, Gender, Re-Sensitization, Subjectivity, Urban Guerrilla*

Introduction

This work aims to subvert the structural invisibility of women in public life, which is naturalized and to think about collaborative ways to go into the field and contribute to the development of an urban analysis from a gender perspective. The research focused on the relationship of women in the city and their dynamics, and for this reason it is necessary to understand that the homogeneous vision of men and women, without cuttings of class and race, allows nuances and specificities to be implicit, and as a consequence there is a superficiality of making public policies.

The commitment is to unite theory, analysis and design practices that are concerned with elucidating gender issues in the city and understanding women in their displacements. According to Merleau Ponty (1999) the perception is to experience the body in space, where movement and feeling are key elements of perception. Therefore, the research cross concepts to understand the different experiences of women in the city and to apprehend the dynamics of their daily paths.

Working with different spectrums through a collective activity makes possible to perceive the power of this approach once the perceptions of women can be extracted. It's also necessary to assume here that this path recognizes the incompleteness of the researcher in his individual point of view and for that reason the views of others are explored. Therefore, the Women's action of urban Guerrilla emerges as a strategical intervention in the city that aims to contribute to the processes of re-sensitization and experimentation of the body in space, an urban analysis instrument that points to a collaborative/participative methodological path.

¹. *Architect and Urbanist - Faculty of Architecture and Urbanism - FAU / UFRJ - Rio de Janeiro, Brazil, candida.zigoni@gmail.com*

Subjectivity in the Gender Issue

According to Butler (1998), the bodies follow a performative dynamic where they are engaged by collective situations, although these acts are inherent to their own repertoire. Thus, the issue of subjectivity from a gender perspective causes a discussion in this research, which indicates performative acts as a clue to subvert the naturalized concept of “becoming a woman.” Simone de Beauvoir (1949) in “The second sex” says: one is not born, but rather becomes, a woman.

This reflection leads us to the understanding that woman’s body is historical, engaged by memories from a collective sense and is in constantly construction. Therefore, it becomes possible to develop a work that encourages interventions in the city made by women’s bodies, which would allow to expand the spectrum of the observer and to apprehend the different “cities” experienced by women.

Acknowledging space from a gender perspective is a strategy that brings concerns about the intersectionality of the different subjectivities. However, it’s possible to go through the research and find the common into the collective. The author Heleith Saffioti (2004) during the article “Gender violence: the place of praxis in the construction of subjectivity” says that the identity construction is connected to the subjectivity of the subject, which is considered as a gap. The gap is understood here as a transversal vector that recognizes the cuttings in the Brazil’s context and contributes to a feminist research that intends to apprehend diversity without losing itself in fragmentation or in a universalist discourse.

The contributions of the researchers Elisabeth Souza-Lobo and Mary Garcia Castro (1991), allowed us to understand the term woman as a generic one, although not universal, and presents the possibility of incorporating the singular, in praxis, to defend the interests of its category. This line of reasoning allows to understand that women’s actions will indicate a collective sense of movement.

In addition to the concerns of women in the city, gender violence is a rising issue in the public and private context, and it’s necessary to emphasize that although women assume a role of victim, they cannot be considered passive (Saffioti, 2004).

This research is committed to investigate strategies to subvert the normative and hegemonic praxis of constructing the identity of women in the city and also to performs acts of resistance in public spaces.

Re-Sensitize Paths

Is necessary to discuss the role of women into the constructions of the cities and also review the hegemonic standards of urban planning, since the women’s experience in the city enable to adapt the environment and make visible the needs of those who are not considered by the dominant thought.

The inclusion of an invisible perspective points to sensitive processes, which enhance the city’s experience as an instrument for urban analysis. The closer relation of the body scale in the processes of design cities may suggest a collaborative/participative methodology in the development of this work.

The crosscutting issue at the gender perspective in urban analyzes in order to detect the functioning and efficiency of a space, make it possible to systematize real demands and think about an application in this review of urban planning and political concepts.

Therefore, the resilience of women's urban mobility searches for inputs to analyze the subject and its sensations. Resilient displacements could be a clue to the application of perception and improvisation. The adaptability of women according to the situation exemplifies how the body makes the ambiances and that in order to the perception the action is performed.

The ambiances treated here has the power to unite the sensations experienced by women during an activity, which points to a concept that recognizes the collectivity, despite representing itself in individuality² (Duarte, 2013). The great challenge dealing with the gender issue is the apprehension of singularities. The ambiances in this study is an instrument that adds to the connections between the subject, his historical body and his memory.

Strategies of Interventions in the City

The debate about the invisibility of women in different contexts arouses interest to elucidate these issues, and activism became naturally a reference of interventions. Subversively, we take as examples the *Slam das Minas*, which is a battle of poetry that discuss about the body and space during an event and brings with it experiences of cities. Other example is The *Feminicidade*³, which is a feminist collective that materializes posters with narratives of women on the urban walls.

These are some examples that guided the research to broaden the view of the city. Thus, given the urgency to understand this sensitive dimension of the women's body in movement, the tactical urbanism concept is a part of this methodological path, where the body scale is part of the production of space in occasional events.

The concept consists of quick, low-cost actions that demonstrate the possibility of changes. In this present work, tactical urbanism defined some guidelines about the time scale of interventions in the city. According to Lydon and Garcia (2015), the strategy aims to integrate knowledge about the city from their own users, so that the approximation of the body scale can instigate changes and offer local ideas for the challenges of urban planning.

In order to recognize the resilient walk of women, the urban guerrilla is related to the studies of tactical urbanism and the idea of instigating women in guerrilla actions arises as an experimental strategy that seeks to re-sensitize women's daily paths.

Here it's necessary to define the chronological guidelines of this strategy: the ephemeral (hours/days) as a manifest intervention, the temporary as a prototype project developed with the support of the public authorities and the participation of civil society and at last the permanent phase as the implementation of the previous layers.

Women's Action of Urban Guerrilla⁴

The autonomy of women in their displacements is connected to the feelings of insecurity in public spaces. The guerrilla action, as a manifesto, seeks to bring to light the demands of women in the city during a re-sensitized path by interventions and the bodies in movement performing spaces.

2. In the present work, the concept from Duarte is used in a more specific gender cutting.

3. *Feminicidade* is a juxtaposition of two words in portuguese. *Femini* stands for feminine and *Cidade* for city, and together means *Feminine City*.

4. Video online about the action of urban guerrilla: <https://youtu.be/jw6o1nuQo7k>

The Women's action of urban Guerrilla took place on August 31, 2019, in Rio de Janeiro, and it was part of a Final Undergraduate Studio at the Faculty of Architecture and Urbanism - UFRJ about the construction of a methodological path for an urban analysis from a gender perspective. The event had 21 participants and it lasted about 4 hours.

As a minimally instructed action, each participant received a device common to the women's body, a bag, equipped with materials that could leave marks in the public spaces, so as to bring their perspective to the design process. Despite being ephemeral in its physical character, the guerrilla reverberated in the memory of the participants and in the people, who were interested about the activity and even wanted to contribute locally.

The device also represents the autonomy of walking and enhances it when the woman has the power to register her feelings through marks in the city. It is necessary to remember that the ambiances allow the transition from the sensitive dimension to the cognitive dimension (Amphoux, 2004). Nevertheless, the guerrilla action potentialize this movement when it allows the transposition of the ambiances felt by women into a physical intervention.

Therefore, after the activity, the records (photos and videos) were an important instrument for analyze the path, as well as the conversations with the guerrilla's participants, who had the chance to remember the path and to comprehend their movements around the city. The exchange of perceptions and experiences while intervening on the path made it possible a sensitive analysis about the public spaces, such as to extract ideas for design actions, for example: extending sidewalks, visualizing and enlarging corners, subverting barriers, crossing safely, prioritizing and informing paths, connecting spaces, limiting parking areas and integrating empty spaces.

Clearly its understood that any environment would be inert if it didn't interact with the physical, sensory, sensitive and psychological dimensions of those who use it. (Duarte, 2013)

Partial Considerations

Subjectivity as a device to bring together the collective sense with the design research processes, enables the development of solutions to the real demands of the city. In addition, it also expands the spectrum of the observer and contribute to a re-sensitization of design practices.

Figure 1. Intervention at the Women's action of urban Guerrilla with a poster asking: "How many times did you changed your path today?," Keila AUREA, 2019





Figure 2. Illustration of the bag and the materials uses in the action of urban guerrilla, Cândida Zigoni, 2019

Tactical urbanism is a strategical concept not only to acknowledging space through a body scale and its experiments, but also to indicate chronological guidelines in studies on urban analysis and design proposals. The action of guerrilla apprehends subjectivity in a collective sense. It is performed as a meeting-point of body and space that brings the opportunities for women to experience themselves in the public spaces.

There is a power in the autonomy represented with the proposed bag in its urban mobility, which enables the development of a network study in the city, where the individual recognizes himself in the collective sense and acts in a more active way. This can result in a construction of a network of actions around the city and contribute to a new approach for urban analysis and design practices.

The research is qualitative, experimental and the fact of being in a constant state of construction, indicates a certain urgency in thinking about new manners of exploring spaces of ambiances and developing methodological paths that could connect the sensitive and dynamics aspects of spaces and their users.

References

- Amphoux, Pascal, Thibaud, Jean-Paul, Chekkoff, Grégoire. *Ambiances en Débats*. Bernin: Editions A la Croisée, 2004.
- Beauvoir, Simone. *O segundo sexo*. Rio de Janeiro: Difusão Europeia do Livro, 1970.
- Butler, Judith. “Atos performáticos e a formação dos gêneros: um ensaio sobre a fenomenologia e teoria feminista.” In the *Pensamento Feminista: conceitos fundamentais*, edited by Heloisa Buarque de Hollanda, 213-230. Bazar do Tempo: Rio de Janeiro, 2019.
- Castro, Mary Garcia. “Alquimia das categorias sociais - gênero, raça, geração - na produção de sujeitos políticos: o caso de líderes do Sindicato de Trabalhadores Domésticos em Salvador.” *XV Encontro Anual da Anpocs* (outubro, 1991).
- Duarte, Cristiane Rose. “Ambiance: pour une approche sensible de l’espace.” In the *Ambiances Urbaines en partage*, edited by Thibaud, Jean Paul e Duarte, Cristiane Rose, 30-21. Genebra: Metis-Presses, 2013.
- Lydon, M., Garcia, A. *Tactical Urbanism: Short-term Action for Long-term Change*. New York: Island Press, 2015.
- Merleau-Ponty, Maurice. *Fenomenologia da percepção*. São Paulo: Martins Fontes, 1999.
- Montaner, Josep Maria, Muxi, Zaida. *Arquitetura e Política: Ensaios para mundos alternativos*. São Paulo: GG, 2014.

Saffioti, Heleith. “Violência de gênero: o lugar da práxis na construção da subjetividade.” In the *Pensamento Feminista Brasileiro: formação e contexto*, edited by Heleith Buarque de Hollanda, 139-161. Rio de Janeiro: Bazar do Tempo, 2019.

Souza-Lobo, Elisabeth. “Trabalhadoras e trabalhadores: o dia-a-dia das representações.” In the *A classe operária tem dois sexos: trabalho, dominação e resistência*. By Elisabeth Souza-Lobo. São Paulo: Brasiliense, 1991.

11

SENSE AND SENSIBILITY OF AFFECTIVE ATMOSPHERES

12

SENSITIVE SPACES AND URBAN PRACTICES

13

SENSORY EXPERIENCE, ENVIRONMENTAL
EXPERIENCE, POLITICAL ENGAGEMENT

14

SOUND STAKES OF THE ATMOSPHERE

15

THE WAY OF AMBIANCES: SCIENTIFIC
PRACTICES, ARTISTIC PRACTICES

Sensory Experience, Environmental Experience and Political Engagement

Session 13 – Introduction

Théa MANOLA¹,
Edith CHEZEL²

Considering on one hand, the increase in power of an aesthetic capitalism (Assouly, 2008; Böhme, 2016), resulting from neoliberal logics of production of inhabited spaces, often adorned with ‘green aesthetics’ (Fel, 2009; Blanc, 2012) ; and considering on the other hand, climate emergency and the injunction to transition, mobilizing various technical objects (Labussière and Nadaï 2018); we are witnessing multiple processes of “smoothing” spaces and experiences (standardization - Manola, 2012; Faburel and Manola, 2016; Thomas, 2018; asepticization - Thomas, 2009; fluidization and pacification - Masson, 2009; Adey et al., 2013) often ignoring our relationships to the “weather- world” (Ingold 2011, 120).¹²

Nevertheless, in a contemporary world enduring various crisis (namely environmental), sensitive experiences can also help understanding spaces in other ways (Thibaud, 2018). Physical engagement(s) in, with and by this world, using the body comprehension of space, might lead both to awareness and to forms of collective action, struggles and resistance (cf. Blanc and Lolive, 2007 ; Chezel, 2018). In this session we propose to discuss these political engagements/involvements generated by the body (Céfaï, 2009) and to question ourselves through the sensitive, on the very meaning of the produced space.

How do we relate to others through sensitive experiences? To what extent do sensitive experiences allow consideration or even awareness of environmental issues (both locally and more globally - climate change, biodiversity loss, etc.)?

Lilia Khelifi questions how surfing includes an intellectual and physical work on oneself, leading to the development of alloaesthesia which allows to learn how to feel movements produced by oneself but also by all kinds of surroundings. Thalia Marou discusses how in the practice of urban home gardening, habits and cultural deposits meet with contemporary environmental concerns and ethics and explores the symbiotic atmospheres of human and non-human entities, ideas, values and perspectives.

The session questions also how sensitive experiences are included in space making, or resulting from a specific space production and their political implications? In this

1. CRESSON / UMR AAU.

2. UMR Pacte.

sense, Simone Ranocchiari answers by questioning the relationship between ambiances and political engagement through the material atmospheres of “self-managed political-sociocultural spaces” while Eric Crevels questions the presence of labor, skills and techniques in the built environment and their contribution to the creation of particular atmospheres. In the same direction, but approaching the question from a more distant point of view, Olivier Ocquidant discusses the relations of urbanity and atmosphere, based on an ongoing survey on the post-industrial city and Victor Fraigneau addresses the notion of “sensory patrimoine” (by sound and smell), by questioning our control on the natural elements in order to characterize the sound or olfactory identity of a place.

The central preoccupation of these sessions is how experience becomes (political and/or environmental) engagement and how might sensitive experience be considered as an element of environmental engagement or even of claiming by “citizen” involvement? As a direct response to this question Claire Pelgrims discusses the “infra-politics” of the experience of mobility and the potential of mobility infrastructure to nourish the political engagement of mobile actors toward a sustainable future. In the same sense, Fabian Leveque and Karl Berthelot present elements concerning the singular experience of living with climate change in cities through the sensitive experience of the inhabitants and the relation of this experience with the political and ecological relation to the inhabited milieu of life.

Through those motley contributions, the session tends to understand tensions between the space production processes in times of environmental crisis and the sensitive experiences of our contemporary world, in order to understand the sensitive experiences as potential engagements/involvements (environmental or other). To do so, methodological challenges are discussed as much as theoretical issues.

Bibliographie

Adey P., Brayer L., Masson D., Murphy P., Simpson P., et al., 2013, “ “Pour votre tranquillité”: ambiance, atmosphere, and surveillance ”, *Geoforum, Elsevier*, 49, pp.299-309 [En ligne]

Assouly O., 2008, *Le capitalisme esthétique*, Éditions du Cerf, 192 p.

Blanc N., 2012, *Les Nouvelles esthétiques urbaines*, Armand Colin, 219 p.

Blanc N. et Lolive J., “Les subjectivités cosmopolitiques et la question esthétique”, in Lolive J. et Soubeyran O. (dir.), *Émergence des cosmopolitiques et mutation de la pensée aménagiste*, Paris, La Découverte, 2007.

Böhme G., 2016, *Critique of Aesthetic Capitalism*, Mimesis International, 108 p.

Cefaï D., 2009, “ Comment se mobilise-t-on ? Apport d’une approche pragmatiste à la sociologie de l’action collective ”, *Sociologie et sociétés*, vol. 41, n°2, pp. 245-269

Chezel E., 2018, *La fabrique collective des paysages climatiques, une enquête avec les parcs éoliens citoyens en Frise du Nord*, Thèse de doctorat, Université Grenoble Alpes, Grenoble.

Faburel G. et Manola T., 2016, “ Entre aïsthésis quotidienne, bien-être urbain et habitabilité de la ville durable : en quoi les paysages des éco-quartiers sont-ils différents ? ”, in. Barles S. et Blanc N. (dir.), *Ecologies urbaines 2*, Economica-Anthropos, pp. 149-173

Fel L., 2009, *L’Esthétique verte : de la représentation à la présentation de la nature*, Champ Vallon, 352 p.

Ingold T., 2011, *Being Alive: Essays on Movement, Knowledge and Description*, Routledge, London.

Labussière O. et Nadaï A., 2018, *Energy Transitions, A Socio-technical Inquiry*, Palgrave Macmillan, Cham, Switzerland,

Manola T., 2012, “ *Conditions et apports du paysage multisensoriel pour une approche sensible de l’urbain*”, Thèse en urbanisme, aménagement et politiques urbaines, Lab’Urba et UMR CNRS LAVUE, Université Paris-Est, 646 p. [En ligne]

Manola T., 2013, “ La sensorialité, dimension cachée de la ville durable ”, *Métropolitiques* [en ligne]

Thibaud J.-P., 2018, “Vers une écologie ambiante de l’urbain”, *Environnement Urbain / Urban Environment* [En ligne], Volume 13 | 2018, mis en ligne le 04 juillet 2018, consulté le 13 septembre 2018. URL : <http://journals.openedition.org/eue/2135>

Thomas R. (dir.), Balez S., Bérubé G., Bonnet A., 2010, *L’aseptisation des ambiances piétonnes au XXIe siècle. Entre passivité et plasticité des corps en marche*, Rapport de recherche n° 78 CRESSON, Programme PIRVE CNRS MEEDDM, 124 p. [En ligne]

Thomas R., 2018, *Une critique sensible de l’urbain*, Mémoire de HDR en Sciences Humaines - Aménagement, Communauté Université Grenoble Alpes, École doctorale 454 “Sciences de l’homme, du politique et du territoire”, CRESSON, 261 p. [En ligne]

Symbiotic Atmospheres

Following the Actors in the More than Human Network of an Urban Home Garden

Thalia MAROU¹

Abstract. The practice of urban home gardening has become popular in recent years in the city of Volos. In this practice, habits and cultural deposits meet with contemporary environmental concerns and ethics. But how actors and their agencies are networked in an urban home garden of a medium-scaled Greek city today? How is this nature-culture mapped? With theoretical pillar the work of Bruno Latour and the Actor Network Theory, this research explores the symbiotic atmospheres of human and nonhuman entities, ideas, values and perspectives, as they form pockets of biodiversity, interdependence, care, cultural expression, and present a different face of the city in the Anthropocene era.

Keywords. Urban Home Garden, ANT, Nature-culture, Human, No Human, Care

Urban Home Gardening and ANT

In Volos (Greece), especially during the last years, urban home gardening has become a widespread practice. By this practice, the habits and cultural deposits of the population merge with modern environmental concerns and ethics (Marou, Kotionis, 2019). Taking as a starting point the notion of the “social” as it emerges through the work of Bruno Latour (1993, 2005), the potential of Actor Network Theory (ANT) is applied in order to examine the urban home garden, approaching it as a “quasi object” (Latour, 1993) a “nature-culture” (Latour, 1993; Haraway 2003). Additionally, it is also applied in order to trace its “social” characteristics beyond any existing dualisms such as society/nature, subject/object, and rather to focus on characteristics that describe the interaction among human and non-human. Applying the ANT terminology, we will study how actors, intermediaries and mediators (Latour, 2005) may affect, contribute to shaping the complexity of the urban garden and ultimately its atmosphere.

This research is based on seven semi-structured interviews and walks/conversations in the garden. Interlocutors were chosen while an on-site research was conducted in order to map home vegetable gardens in the urban area of Volos. They were 3 men and 4 women - one of the men and one of the women are a couple - living in detached houses in different areas of the city. In this qualitative research, through the sample's spatial distribution across the city areas, an attempt was made to represent the existing diversity in terms of gender, age, ethnic origin and culture.

As Hinchings (2003) suggests, ANT reminds us that the way we approach the world, is always influenced by our non-human environments.

¹ Ph.D.candidate, Department of Architecture, University of Thessaly, Greece, thmarou@uth.gr

By adopting this approach and through our interlocutors' discourses, we drew upon the interconnections among the human and the non-human as they shape and give substance to the gardens, who in their turn become central within the city network, affecting both its ecology and resilience. This work focuses on some of these interconnections regarding the cohabitation of humans and non-humans, living and non-living, material and immaterial.

Space, Soil, Water, Microclimate

Space is an essential factor for the creation, scale and typology of domestic urban gardens (Cameron et al., 2012). Four of our interlocutors cultivate within the private space of their own house, while the other two use a conceded space at the opposite or next to their houses.

The garden area, when private, includes additional functions, such as entertainment, eating, resting, children's playing, as well as parking.

According to the interlocutors, space scale affects plant diversity, soil and its management. Its urban character renders watering practices dependent upon the urban watering system or in some cases, or avoiding the cost, requires the transportation of water from peri-urban ravines with the car. In terms of the city's microclimate, all interlocutors refer to a difficulty in dealing with the high temperatures occurring in the city during summer.

Plants

One of the basic characteristics of urban home gardens is the big variety of plants (Mitchel & Hanstad, 2004). The origin, diversity, production and needs of plants, as well as the methods used in order to deal and satisfy plant needs are factors contributing to the arrangement of domestic urban garden morphology, its ecological resilience, but also its contribution to the environmental, spatial and social characteristics of the urban space. All our interlocutors referred to the diversity of vegetables being cultivated, of tree fruits too, while in the garden of one interlocutor there were also flowers. They recognized an interrelationship between plant diversity and space availability.

They use with great pride words such as "everything" in order to describe the plant diversity of their gardens. Plants bring abundance, joy, self-respect. The diversity, development and fecundity of the garden plants became a material manifestation of the gardener's abilities and identity, enriching the garden atmosphere with satisfaction and pride.

Symbiosis

The gardener's actions in the urban home garden aim at preventing the acts of other entities/ organisms thriving in the same garden. Plants and animals, as they perform their lives' functions and their role in nature, may oppose the gardener's plans. Gardening practices aim at 'ensuring' the garden development along with its cultivated plants according to human wishes, but also at 'protecting' domestic animals from the competitive relationships among them, but also between them and other animals of the urban ecosystem.

Most of the interlocutors talk of a "good weeding" being the necessary prerequisite for the garden's success. The belief that one has to kill weeds as they hinder the development of cultivated plants is emerging in most of their discourses.

Correspondingly, for the protection of the henhouse from ‘intruder’s’ invasions, a puppy has been adopted and has been growing up in the garden in order to become its future guardian. With the help of special constructions/relevant housing the interactions among cats and dogs hosted in the garden have been regulated. Ultimately, the gardener/human uses, but also intervenes in the relationships of animals in the food network in order to adjust garden ecology.

The symbiosis of humans and non-humans within the urban home garden includes relationships of competition, depredation, reciprocity. Humans, plants and animals cohabitate and despite the fact that humans are proved to be in many occasions the orchestrators behind such cohabitation, still they cannot force other entities into ‘discipline’ or how they will relate with each other. Nevertheless, human actions, which according to Myers (2017) correspond to biopolitical regimes, attempt to control life within garden limits. At the same time, non-living materials and constructions also intervene in the act of cohabitation and its preconditions through the implementation of certain practices. Some examples include the synthetic geotextile covering the soil in order to discourage the growth of weeds, the fence (either metal or wooden) protecting the animals and the chicken, the wooden house for the cats.

Sustainable Growing Practices

Our interlocutors describe environmentally friendly, ‘ecological’ practices, as well as innovative solutions they come to implement, in order to save natural resources and money. Manos, refers to garden pest control practices by saying: “I am trying not to use chemical pest control preparations, and as a result the only thing I spray is thio-calcin and sometimes my own preparations, such as soap diluted in water and alcohol.”

Roula, respectively, uses a liquid feed made of nettle, ashes and manure. Vera, who raises hens in her garden, tells us: “Because we have the hens, we use manure and chicken droppings. It’s very good, strengthens the plants a lot. We do not add any fertilizers.”

Relevant practices were described by all the interlocutors who refused to use pesticides and chemical fertilizers.

Environmental consciousness within the garden space is being embodied through the gardening practices. The latter are actions playing a crucial role in the shaping of the urban home garden, its production, composition, form and finally its influence upon the urban ecosystem. Culturally constructed and originating from family habits and paradigms, carried by urban gardeners along with their rural descent and the memories of their families into the city, they bridge the city with the rural areas. Through them, interlocutors express their environmental concerns and care, as they strive to provide healthy, quality products for the family table (Marou, Kotionis, 2019), while co-producing scenes of rural urbanity.

Material Objects

The material objects we find in the urban home garden, are contributing to its spatial, ecological and anthropological shaping. They are the mediators of the actions, through which the overall character of the urban home gardening practice is generated.

These tools, constructions, utensils, technologies, in some cases vehicles too, have been recorded through personal observation during the visits to particular urban home gardens, and through the interviews. With their own words, our interlocutors make apparent the mediation of the actions, as it is performed by “things” (Latour, 2005).

The soil preparation, as a practice of urban home gardening, is mediated by tools as the rake, the manure fork, the hoe, the tiller. The watering respectively, is mediated by things as the water hose, the water tap, the automatic watering system and the city water supply network. In some cases where water is transported from distant places, portable tanks, plastic bottles, barrels and the private car are mediating the transportation and simultaneously the watering. The seedling production is mediated by plant pots, little cooking pots, small fruit containers, nylon films and generally household objects which are reused in urban home gardening. The action of fastening and protection of plants is connected by our interlocutors with objects such as the rope, but also with natural materials such as reeds and fern leaves. Reused materials and objects such as old closets, mediate the storage in the garden, while pallets and old wooden surfaces help to enclose and protect domestic animals. Some objects are mediators for more than one action. As the grill for roasting meat for meals in the garden, but also the production of ashes for the fertilization of plants. We should also mention some things that we encounter in the urban home garden or are described by our interlocutors, which mediate rest, companionship, recreation, dinner in the garden, along with other actions of urban home gardening. These things are old tables, old chairs sometimes been moved from the interior of the house, and installed outside in the garden, or they are light garden furniture.

The presence of all these objects and materials in the garden, we have mentioned above, and their role as mediators of the actions of urban gardening, as it is presented in the words of the interlocutors, renders visible the importance of “things” for the performance of urban gardening practices and the management the urban home garden space.

Ethics of Care

Tronto (1993) defines care as “a species activity that includes everything that we do to maintain, continue, and repair our ‘world’ so that we can live in it as well as possible.” According to the author, our ‘world’ refers to our bodies, ourselves and our environment. Everything that seeks to coexist as a whole, a network of “co-woven” life. According to Laugier (2015), the interrelationship between care and the environment can take place when we re-orientate ourselves towards everyday ecological activities, behaviors and practices - either private or public - which will be inspired by a respect to the environment. She emphasizes how environmental care addresses the immediate, familiar space - the garden - as well as the distant, unfamiliar space or even the planetary macrocosm.

While describing practices applied in the context of urban domestic gardening, our interlocutors often refer to notions of looking after, giving attention, taking responsibility, expressing affection - thus they describe practices of care.

Vivi cares for, attends to her plants: “I spent my days here, I spend my nights here. And if I have no time to go the garden, days when I am busy, I make a round to see who is thirsty, I will make a round to water a little bit at least. [...] My soul, I will go water them and then I will leave. To protect them from the heatwave.” Caring for the plants in the garden is the first thing to do for Roula: “First I must come here, to see my garden, how it’s doing, how things are and then get into it. First, I must make a round. To see how the peppers over there are doing, if flower has turned to fruit, I will go there, I will look around...”

Zina describes how “you wake up in the morning and tell yourself, I have something more to take care of, you see it grow, you enjoy it, you see others enjoying it for what you have. You see your children being happy.” According to her, the plants need her maternal care as much as her children.

The ethics of care is revealed to be a substantial element of the domestic urban gardening. Our gardeners talk about practices aiming at the conservation of traditional varieties of seeds, about ecological practices, about health as mediated through the family table. They talk of caring for the all the living beings cohabiting the domestic garden - plants and animals alike. They talk about their families and how the garden ensures a healthy and qualitative nutrition. They talk of the soil, the water, biodiversity. They care for the human and the non-human, they care for the web of life.

Discussion

The ethnographic material of this research renders visible the 'social' nature connecting humans, non-human organisms, environmental factors and natural phenomena, material objects and artefacts, but also immaterial elements, cultural aspects, habits, beliefs, practices, thoughts, emotions - what in three words could be described as an urban home garden. Thus, emerge the atmospheres of an urban home garden. Atmospheres composing the 'rural' as a way of life, not as space. These are atmospheres of care and environmental ethics, cooperation, satisfaction and abundance, of symbiosis, but simultaneously of biopolitical control of the non-human lives by humans.

By emphasizing on this networking, the interactions between the urban home gardening as a practice and the environmental, cultural and social characteristics of the urban everyday life are understood. Similarly understood are the possibilities offered to confront the separateness from the earth and its practices, characterizing the urbanized human, and also the everyday life in the anthropocenic city.

References

- Cameron, R. Blanus, T. Taylor, J. Salisbury, A. Halstead A. Henricot, B. Thompson, K. The domestic garden - Its contribution to urban green infrastructure, *Urban Forestry & Urban Greening*, Volume 11:2 (2012): 129-137. <https://doi.org/10.1016/j.ufug.2012.01.002>
- Hitchings, R. People, plants and performance: on actor network theory and the material pleasures of the private garden, *Social & Cultural Geography* 4 (2003): 99-113. <https://doi.org/10.1080/1464936032000049333>
- Haraway, D. *The Companion Species Manifesto: Dogs, People, and Significant Otherness*, Chicago, Prickly Paradigm Press: 2003.
- Latour, B. *We Have Never Been Modern*, Harlow, Pearson: 1993.
- Latour, B. *Reassembling the Social: An introduction to Actor-Network-Theory*, Oxford, Oxford University Press: 2005.
- Laugier, S. (2015) Care, Environnement et Ethique Globale, *Cahiers du Genre*, 2015:2 n° 59, p. 127-152. <https://doi.org/10.3917/cdge.059.0127>
- Marou, T. Kotionis, Z. "Praktikes tis astikis kipourikis stin poli tou Volou. Politismikes enapotheseis kai viomata sti synchroni astiki kathimerinotita (Urban gardening practices in the city of Volos. Cultural deposits and experiences in the urban everyday life)," in *Synchronoi Provlitismoi gia tin Poleodomia Chorotaxia kai tin Anaptixi. Mia syllogi keimenon apo to 5o Panellinio Synedrio Poleodomias, Chorotaxias kai Periferiakis Anaptixis (Contemporary Considerations for Urban Planning, Spatial Planning and Development. A collection of texts of the 5th Panhellenic Planning and Regional Development Conference)*, edited by Defner, A. M. Skayannis, P. Rodakinias, P. Psatha, A. 313-325. Department of Planning and Regional Development, University of Thessaly, 2019.

Mitchell R, Hanstad T. *Small homegarden plots and sustainable livelihoods for the poor*. LSP Working paper No.11. Rome, Food and Agriculture Organization of the United Nations: 2004.

Myers, N. From the anthropocene to the planthroposcene: Designing gardens for plant/people involution, *History and Anthropology*, 28:3, (2017): 297-301.
<https://doi.org/10.1080/02757206.2017.1289934>

Tronto, J. C. *Moral boundaries: A political argument for an ethic of care*. London, Routledge: 1993.

How Surfing Creates an Ecosystem?

An Investigation about Surfers in Madagascar

Lilia KHELIFI¹

Abstract. As a part of my research, I am investigating what surfing means to individuals who define themselves as surfers. The qualitative survey I led a month in Madagascar allowed to grasp the complexity of a surfer's identity construction and the ways individuals appropriate a globalised practice. Cultural geography and maritime anthropology are the research fields I focused on to apprehend the interactions between the respondents and their environments, and also with themselves. Indeed, surfing does not only consist in a physical practice in waves using a board. It is rather a complex whole including an intellectual and physical work on oneself, leading to the development of alloæsthesia, which allows to learn how to feel movements produced by oneself but also by all kinds of surroundings.

Keywords. *Surfing, Madagascar, Individual, Ocean, Identity, Movement, Feel, Experience, Body*

Why is a Qualitative Survey Required?

On September 2017, I began my field research in Madagascar to study how surfing is spreading and appropriating by inhabitants. I was convinced that the few results on the Internet about that in the Big Island, especially by local inhabitants, did not reflect reality. That is why I led a qualitative survey for a month in some localities: Tananarive (the capital city), Mahambo (a village on the east coast, where the first surfing school was created in 2003), Ambatomalama (a fishermen hamlet close to the preceding one), and Fort-Dauphin (a city in the south-east where there are the most surfers, according to several respondents across the country).

I was inspired by the method used by sociologist Wacquant (2004), who integrated a gym in a Black ghetto in Chicago for three years to understand what boxing represents to the men. Indeed, the share of daily trainings, the sensations and feelings - like sweating, hurting oneself, winning or losing a sparring match, etc. - expressed and felt by the researcher and his respondents were necessary to seize what does boxing mean to them. It is how I worked during my field, that is why I tried hard to spend as much time as possible with my respondents, by sharing meals, journeys to their place of work, evenings at their home, which had resulted in more and more conversations and improved my field data. Besides, I endeavoured to fill out my field notebook everyday.

I wanted to grasp what does surfing mean through my questions to persons who practice. I preferred an emic method, that I consider better to catch the conceptual frameworks and words used by my interlocutors without influencing them (Becker, 1970). I must acknowledge that there is necessarily a bias introduced by research since I have

¹ Ph.D. student, Sorbonne University - Laboratory Médiations, sciences des lieux, sciences des liens, Paris, France, lilia.khelifi@gmail.com

constructed the interview grid and I asked at times some precise questions. My only presence and my status - I introduced myself each time as a French student in University - were enough to emphasise potential biases in their behaviours and answers. But I strived to adapt to each respondent and interrupt him/her as little as possible, even if I had to skip some questions from my grid (Olivier De Sardan, 2008). The habit of seeing me everyday for a while also contributed to gain confidence and to cross-check information from one day to another. Observations and conversations were finally in most cases richer in data than formal interviews.

Regarding observations, I walked on beaches several times a day to note who - in terms of sex and age essentially - and what persons observed were doing: walking, playing with water, sitting, etc. These observations have provided undeniable evidence that most inhabitants consider beaches as paths to circulate. These are also points of sale for fishermen. But nobody sits on the beach, whether alone or in a group, to take advantage of the place - apart from surfers. I observed only in Fort-Dauphin the youngest playing with the backwash. The ocean is strongly feared by most Malagasy, that explains partly why beaches are rarely perceived as recreational areas.

Practicing surfing or being a surfer is not easy to define. I will try to analyse this category through the following plan.

Enter a Sensory World

Take Heed to Oneself

When I asked the question in my interview grid "what does surfing mean to you?," it was difficult for people met to answer. Sometimes, it was because they were lacking words in French to express themselves, but it was also because their practice is based on a complex combination of elements. I realised that by joining them on their surfing sessions. Indeed, an important part of my methodology consisted in spending as much time as possible with my respondents. Besides, since they knew that I was investigating about surfing, they systematically offered me to join them. The arrival at the beach was always a moving moment for the surfers I observed. They took a deep breath with a smile and bright eyes. They were hurry to plunge into the water with their board but they took time to enquire about the state of the ocean. Several minutes of observation and discussions with fishermen returning from the sea were necessary to avoid any accident. Even if surfing means to deal with a risk, which is accepted and pursued by surfers (Barthe-Deloizy, 2010), those moments were strictly respected as a ritual. And it is not proper to Madagascar, it concerns surfers all around the world (Booth, 2001; Augustin, 1995). Once in the water, sight tends to be less and less important while it was essential for the observation from the beach. All body senses are used together to feel movements provoked by the ocean. Some respondents insisted on the fact that surfing is about dealing with what the ocean gives. According to them, no one should influence the functioning of the ocean, otherwise it would cause damage. So, the best behaviour to adopt, as a true surfer, is to accept movements induced by the ocean and accommodate them with your own ones. This brings us to kinæsthesia notion. I realised what means to feel the wave during my own surfing initiation by one of the respondents in Mahambo. Experience through the body will never be able to replace intellectual perception. That is why my methodology includes physical commitment in addition to personal involvement. Besides, this is a way to overcome my foreigner status to the country and to the social group I study (Fassin, 2009). When a surfer comes into water, all his sensory sensors are on alert. He has to row in order to move away from the shoreline and then he turns to face it. Since waves take shape behind his back, it is his entire body who feel the right moment

to soar and evaluate the wave power he chose, and not his sight.

Individuality is often emphasised in this practice, while it is rather a collective moment shared with friends in water and also with those left seated on the beach. It is rare to meet a surfer alone in the sea. Although hazardousness is a factor that explains how not to be alone is important, surfers interviewed argued that surfing deals mostly with moral values, such as sharing and humility.

What About Coexistence With Marine Species?

The sharing value does not seem to apply to everyone. On the one hand, interactions between marine species and humans are still uncommon in some parts of the world, even regarding coastal inhabitants. Yet the majority of world's population live nearby coasts and water covers about 70% of the planet's surface. I noted during interviews and conversations how the ocean repulses most Malagasy in localities surveyed. Indeed, strong beliefs surround the ocean, qualifying it as dangerous and deadly. Most Malagasy have never learned how to swim, even amongst fishermen. This reminds how coastlines have become slowly attractive to people in the Western world during the 18th century, while it was strongly feared formerly (Corbin, 1988; Urbain, 2002). This huge body of water contains unknown, which participates to its apprehension. That explains partly why surfing is developing slowly in the Big Island.

On the other hand, as I demonstrated before, surfing means to deal with the body of water, according to its own mood. But the latest 'shark crisis' in Reunion Island - close to Madagascar - raised issues about human presence legitimacy in the ocean. Several Malagasy met and those I interviewed mentioned spontaneously their thoughts about marine species and even the "shark crisis" faced by their neighbours. I did not anticipate those questions in my interview grid, which points out how it matters to them. A few researchers conducted studies in Reunion Island to analyse the interactions between sharks and humans in regard to social sciences (Thiann-Bo Morel & Duret, 2013; Taglioni & Guiltat, 2015). It questions 'waterman' concept, which can qualify both surfers and fishermen due to their strong connection with the ocean. Public authorities finally decided to forbid access to the sea in the beaches where shark attacks were the highest (prefectoral decree adopted in 2013). This sparked heated debates on social networks in particular and surfers through the whole world feel concerned. Malagasy queried explained the absence of shark attacks on humans despite their passage close to their coasts by the fishing authorisation of this species and the absence of industrial overfishing, unlike their neighbours. Sharks have become enemies to surfers, whereas other fishes are appreciated, according to the interviewees. One of the respondents in Mahambo claimed that he enjoys surfing with dolphins, turtles and other fishes. Whales are also welcome, even if they disturb the practice by smashing waves. That is why each time a sea lion or a dolphin grounds on a beach in Madagascar, people put him back into water, while it would not be the same treatment for a shark, according to the interviewees. Furthermore, advice is given to avoid an encounter with a shark, such as not to swim in the following days when a whale or any other living body is stranded on a beach. Discussions with fishermen are also essential to enquire about potential presence of sharks.

Yet, surfers enjoy to be qualified as 'waterman' and do not imagine living far from the ocean. Their observation of their surroundings and their Internet research to improve their surfing skills lead them to mimic animal practices. A classic example lies in their ability to plunge beneath waves like a duck.

Are Surfers Geographer-Physicists?

A few researchers have provided compelling evidence of knowledge about meteorology held by rural people in different countries (Katz & al., 2002; Pinton, 2009; Peyrusaubes, 2013). To date no work has been published on the role of surfers in their capacity of analysis of meteorology over their lifetime. However their practice is conditional on weather. Surfers must learn to observe the ocean and climate parameters, such as wind, swell and current direction and strength, wave height and direction. The seabed is also important to be identified. Their knowledge about marine topography is essential for anticipating water movements. It pinpoints where to enter, circulate and exit. Otherwise, they would jeopardise themselves. All respondents have at least scratch marks on their legs and/or their arms, when these are not more serious injuries (loss of use of one eye for example).

An anecdote from the field illustrates this point clearly. On a day with a group of surfers on a beach in Fort-Dauphin, we were all seated on the sand, when a man walked up to us. Laughter broke out and I heard the assigned nickname "Meteoman" while he was approaching. I then asked why this reaction. They told me it was because this man - also a surfer, who came from France about two years ago - used to spend a lot of time on the Internet to enquire about climate parameters before surfing. He shared with the group the results of his investigation, but they did not show much interest. Indeed, they could also consult specialised websites since they all have smartphones with an Internet connection. But it is not how they want to proceed, even when they have to drive to a more distant beach, as was the case on that day.

The Materials Issue

On another note, identifying a surfer involves appearance issue. This aspect matters a lot in human societies. In her article of 2006, Jolivet examines through the example of dresses within the court of Burgundy between 1430 and 1442 how fashion is established and influences on silhouette. Moreover, it reminds the role of garments and appearance in general to place individuals in social groups. The social group of surfers is no exception to the rule. Since ruling classes dictate in large part collective tastes (Bourdieu, 1979), one should not overlook the role of dominated classes in this establishment.

First, remind that surfing dates back to 1500 B.C. and was strictly located in the Pacific Islands (Lemarié, 2016). The discovery by the Western world of these islands around 1778, and especially Hawaiï - which became a State of the United States in 1959 after its annexation in 1898 - has transformed the essence of this practice (ibid.). Today's surfing is promoted mostly by Californian and Australian companies, which impose a surfer figure featuring a precise equipment. Surfboard symbolises the evolution of surfing in contemporary times. Indeed, material changeover from the 1950s onwards contributed to limit the practice to wealthy social classes (Sayeux, 2006). The surfboards used to be carved from wood until technological developments in materials employed and shape given led by Western companies for last century. This upheaval in the globalised organisation and spread of surfing is being overturned. From now on, people in developing countries appropriate surfing in their own way. The lack of access to the surfer contemporary equipment turns out to be a new way of claiming an ancestral practice. The first Malagasy surfers began on pieces of wood from used fishermen's pirogues. Some respondents in Madagascar reminded that they share a common ancestor with the Polynesians, known as surfing creators - the Austronesians. This attempt to reconnect to presumed roots reveals how it matters to some individuals to forge an identity apart from the proposed model by the Western world.

Besides, the contemporary environment perception conveyed influences the role of individuals in the workings of the world. The emergence of alloæsthesia notion concerns surfers since some interviewees insisted on their responsibility in respecting the natural functioning of the world. This also involves their attention about the materials used. Local ecological knowledge seems to conflict with western science (Artaud, 2013) in the way of observing and interacting with the environment. All the elements described throughout this paper shape the making of ambiance by surfers: the different senses are summoned to produce a landscape both real and perceptual.

References

- Artaud, Hélène. "La mer à fleur de sens. De la mètis maritime à quelques invariants sur le leurre," *Cahiers d'anthropologie sociale* 9 (1, 2013): 142-155. <https://www.cairn.info/revue-cahiers-d-anthropologie-sociale-2013-1-page-142.htm>
- Augustin, Jean-Pierre. *Surf Atlantique: Les Territoires de l'Ephémère*. Bordeaux: MSHA, 1995.
- Barthe-Deloizy, Francine. *Les spatialités du corps: des pratiques ordinaires aux expériences extrêmes*. Geography, HDR. Bordeaux III: Michel de Montaigne University, 2010.
- Becker, Howard S. *Sociological Work: Method and Substance*. Chicago: Adline, 1970.
- Booth, Douglas. *Australian Beach Cultures: The History of Sun, Sand and Surf*. New York: Routledge, 2001.
- Bourdieu, Pierre. *La distinction: Critique sociale du jugement*. Paris: Les Editions de Minuit, 1979.
- Corbin, Alain. *Le territoire du vide. L'Occident et le désir du rivage (1750-1840)*. Paris: Aubier, 1988.
- Fassin, Didier. "Une science sociale critique peut-elle être utile?" *Tracés. Revue de Sciences humaines* 9 (2009): 199-211. <https://doi.org/10.4000/traces.4465>
- Jolivet, Sophie. "Le phénomène de mode à la cour de Bourgogne sous Philippe le Bon: l'exemple des robes de 1430 à 1442," *Revue du Nord* 365 (2, 2006): 331-345. <https://www.cairn.info/revue-du-nord-2006-2-page-331.htm>
- Katz, Esther et al.. *Entre ciel et terre, climat et sociétés*. Paris: Ibis Press, 2002.
- Lemarié, Jérémy. *Genèse d'un système global surf. Regards comparés des Hawai'i à la Californie: traditions, villes, tourisms et subcultures (1778-2016)*. Sociology, Ph.D.thesis. Paris Ouest Nanterre La Défense University, 2016.
- Olivier De Sardan, Jean-Pierre. *La rigueur du qualitatif. Les contraintes empiriques de l'interprétation socio-anthropologique*. Louvain-La-Neuve: Academia-Bruylant, 2008.
- Peyrusaubes, Daniel. "Quand le paysan malgache parle de nuages," *Géographie et cultures* 85 (April 1, 2013): 35-47. <http://journals.openedition.org/gc/2735>.
- Pinton, Solange. "Les humeurs du temps. Journal d'un paysan de la Creuse," *Ethnologie française* 4 (39, 2009): 587-596. <https://doi.org/10.3917/ethn.094.0587>.
- Sayeux, Anne-Sophie. *Surfeurs, l'être au monde. Analyse socio-anthropologique de la culture de surfeurs, entre accord et déviance*. Social anthropology and ethnology, Ph.D.thesis. Rennes 2 University, 2006.
- Taglioni, François & Guiltat, Sébastien. "Le risque d'attaques de requins à La Réunion.

Éléments d'analyse des attaques et contextualisation d'une gestion contestée," *Echo-Géo* (April 29, 2015): 1-27. <http://journals.openedition.org/echogeo/14205>

Thiann-Bo Morel, Marie & Duret, Pascal. "Le risque requin, mise en risque de la pratique du surf à la Réunion," *Staps* 1 (99, 2013): 23-36. <https://www.cairn.info/revue-staps-2013-1-page-23.htm>

Urbain, Jean-Didier. *Sur la plage: mœurs et coutumes balnéaires (XIXe-XXe siècle)*. Paris: Payot, 2002.

Wacquant, Loïc. *Body and Soul: Ethnographic Notebooks of an Apprentice-Boxer*. New York: Oxford University Press, 2004.

The Tangible Presence of Human Labor in Architecture

Abstract. This essay aims to show that in many of the theories that fundament material culture and architectural experience, labor is implied in the constitution of material and, although seldom directly addressed, it is a determining dimension of materiality. From the Vitruvian and Renaissance treatises and Gottfried Semper to John Ruskin and the Art and Crafts Movement, the underlying presence of labor can be seen intertwined with materials whenever they are called into architectural discussion as sensorial arguments. Just like the physical qualities of materials, labor, skills and techniques are imprinted in the built environment and contribute to the creation of particular atmospheres.

Eric CREVELS¹

Keywords. *Architectural Experience, Sensuous Perception, Material Culture, Labor*

The Tangible Presence of Human Labor in Architecture

The importance of materials in the experience of architectural spaces is hardly questioned, however, most of the discussions stop short of addressing how it relates to its production dimension. Based on the semiology of Peirce, Brazilian architect, painter and theorist Sérgio Ferro argues that it is possible to follow the *index* character of materials to find traces of labor (Ferro, 2006). Understanding the history of the built environment as a collective history, he states that materials can be seen as *signs* and, as such, vestiges of productive operations in their making and employment in construction allow the examination of the proximal production relations on the built environment. In other words, they are signatures of labor in the objective manifestation of materials, as part of their semiological constitution. As symbolically charged elements, they reverberate in perception, reflecting the sociocultural heritage of architectural production: tracing the movements, skills, techniques and the cultural background of their production, and so, acting as representations of their makers. A similar argument can be found in Alfred Gell, reflecting on the distinction between art and artifact (Gell, 1996): artifacts, by their own material form and function, serve as ways in which the world of its maker can be read. Being “models” ingrained with the relationships encompassed in its production and its use, artifacts carry in themselves cultural, material and social relationships that trace back its emergence in a particular world-view. In his words: “there cannot be a hammer by itself; a hammer implies nails to be hammered, wood to hammer them into, saws to shape the wood, and so forth” (Gell, 1996).

Therefore, labor is imprinted in materials, as part of their productive environment, and gains a tangible presence in the built environment, indissociable from the physical qualities of architectural elements. As Ingold argues, it becomes part of “the forces

1. Ph.D.Candidate of the Methods and Analysis Chair at Delft University of Technology.

and flows of material that bring the form of the work into being” (Ingold, 2009). However, identifying these flows is a process of abduction, that deals with the alignment of possibilities, rather than precise associations (Ferro, 2006; Gell, 1996). The level of recognition of the signified material relations depends on the knowledge and experience of the interlocutor: one can only “see in the beams traces of the movements of the axe that cut them” if one is familiar with axes and how they are used (Ingold, 2009). It is expected that the attributes of labor are also perceived and incorporated in theoretical works, especially those with focus on material; but important insights can be drawn from the examination on how the question is presented in these works. The goal of this essay is to show occasions where it may have taken place, as an argument for the validity of these statements, and to give an initial outline of how this perspective can affect architectural theory.

Treatises

Starting from earlier works, interesting examples can be found in two of the most long-lasting and influential treatises on architecture. Vitruvius’ *Ten Books on Architecture* correlation to labor seems timid, but the distinction of “practice” and “theory”² and their co-dependent relation shows that Vitruvius was well aware of the contributions of labor to the resulting environments. The author notes that the observation of the “mode of execution, or of the mere operation of the hands” is essential for the transformation of matter “in best and readiest way” (Vitruvius, 1955a)³, to the extent that architects who lack practical knowledge - the “frequent and continuous contemplation” of practice - fail to understand architecture properly, “grasping the shadow instead of the substance” (Vitruvius, 1955b). In addition, his chapters on materials go into a great degree of detail into their making, exploring which raw materials to use, in which conditions to prepare them and so on.

While Vitruvius balance the needs for craftsmanship and theory, the question of labor in Alberti can be seen from its negation or, in other words, in Alberti’s efforts to separate the role of the architect from that of builder (Carpo, 2018). Standing at the twilight of the guild system, Alberti’s defense for the division between intellectual and productive labors can be seen as a historical stance, aiming a rupture with medieval standards (Rykwert, 1982). If, for Alberti, “architecture that can exist as an image in the mind that is perfect, uncorrupted by matter and mistakes” (Williamson, 2019), it implies that, despite the foundation for beauty being primarily the mathematical order, it is still dependent of proper realization - the fact that labor can poorly translate architecture into the built environment, *corrupting* its ideal form, is, nonetheless, a proof of its contributions: his attempt to orient the labor of artists, dedicating entire chapters of his *De re Aedificatoria* to matter, building techniques and restauration, can be seen as ways to remedy the lack of ability of artisans to properly realize the ideal mathematical models. It can also be seen as an attempt to control their labor, transforming them in “no more than an instrument” in their architect’s hand (Alberti, 1988). Following the abduction approach, Alberti’s words indicate a dissatisfaction with medieval modes of production that follow a structure in which theory and practice are undivided and, thus, more propense to corruption.

2. Appearing in the 8th century Harleian Manuscript as “*fabrica*” and “*ratiocination*” and translated by Frank Granger as “*craftsmanship*” and “*technology*” (Vitruvius, 1955a). The translations “*practice*” and “*theory*” are present in the version by Morgan (Vitruvius, 1955b).

3. Interesting to note that, in Frank Granger’s translation, he states on a footnote that “*Vitruvius recognizes the genius of the craftsman*” (Vitruvius, 1955a).

Semper

While assuming art's derivation from nature, as in the Greek temple's abstraction of the tree, Gottfried Semper doesn't seek a simple return to nature as a way to further develop art but, on the contrary, states that "[t]he most primitive tribes we know present us with an image not of the primeval human condition but of its impoverishment and stultification" (Semper, 2004). Art, in his perspective, appears to be closely related to the progressive change of nature's forms into human or artificial ones. Remarkably, this formulation requires human activity; in other words, labor. The logic can be traced in Semper's categories: it is easy to perceive how closely they are related to production processes by associating their terms with the corresponding verbs: for "textiles" we would have *weaving*; "ceramics" could be linked to *molding*, 'tectonics', *joining*; and 'stereotomy', *stacking*⁴. It is true, however, that Semper's focus on *shape* inverts the logic underlying his own classification, pushing the *processes* to the background, and leading him into a strange position that seemingly contradicts his own premises and anthropological approach:

Conversely, there are objects that certainly belong to ceramics from the point of view of materials, inasmuch as they are formed from a soft mass that was hardened and fixed. *But they should be seen as relating to ceramics only secondarily, because formally they are in a different sphere.* (Semper, 2004, 110, our highlights)

This sort of contortionism is abundant, and it derives from a conscious decision to position style over materiality (Cache, 2002). However, this view stresses the important point that materials are products of human labor as well. When looking on how bricks are made, they are indeed ceramic, but considering "how they are used in production," they constitute masonry or, in the Semperian stylistic view, even textile (Semper, 2004). Regardless of which he prefers, it is possible to argue that in his theory labor is embedded in materials in a two-fold way: in how they are made and in how they are employed in construction. More importantly, they appear as directly related to how architectural objects are perceived, as "every technical product is a result of purpose and material" (Semper, 2004), and thus labor processes can be identified as defining features of in the composition of style. Even recognizing his distinction between art and technology, as "art has a language of its own, consisting of formal types and symbols" while technology categories are the ones referring to the way things are made, in their link labor becomes ingrained in the symbols and types as their primeval archetypes (Semper, 2004).

Art and Crafts

The acknowledgement of the influence of labor in the experience of architecture reaches a peak on the *Arts and Crafts Movement*, owning much of its philosophy to John Ruskin and his sublimation of the imperfect (Carpo, 2018). Ruskin argues that it is possible to apprehend in materials whether there was "a care about them" (Ruskin, 1849), suggesting that the traces of craftspeople's labor "which has visibly been employed upon them" express a "vital energy" in the built environment that is "no inconsiderable part of the essential characters of Beauty" (Ruskin, 1849) - in fact, they relate to his Lamp of Life (Carpo, 2018). This leads him to advocate for the "truth to materials and honest display of actual construction" (Baljon, 1997), as in his defense that "the masonry of a building is to be shown" (Ruskin, 1849). In Ruskin,

4. This approach is loosely based on the lectures of Prof. Tom Avermaete, developing his initial thoughts on architectural epistemes, which can be found at "Architecture and its Epistemes" (Avermaete 2016).

labor is related to the attendance of beauty by associating architecture with nature - the “source and paradigm of all authentic beauty” - as the “efforts, physical or organizational, invested in the construction by its builders” that become expressions of the mind “accepted” by nature as its representation (Baljon, 1997).

In connection to Ruskin, Willian Morris’ calls for beauty in everyday artifacts might seem like a pure reference to aesthetics, but are in reality deeply involved in questions of labor (Kapp, 2016). Morris claims involve the defense of *handicraft* over machinery production, implying a particular beauty contained in the products of human labor that cannot be replicated in industrial production (*Bradley, His Book*, 1896). Ultimately, it follows his understanding of art as the expression of pleasure in the process of work (Ferro, 2006) - in other words, as “emancipated labor” (Kapp, 2016) - perceptible in his utopian piece *News from Nowhere*, from 1890, where “intellectual knowledge is one among other kinds of knowledge” and “people do not appreciate art ... but instead produce it every day”; a society where “people discovered that the material exchange with nature can be fun, and that making things with one’s own hands and mind can be a great pleasure” (Kapp, 2016), resulting in the derationalization of many productions, under the realization that “machines could not produce works of art” (Morris, 1908). Morris concept of art is fundamental to understand his contributions and shows how dramatically can the perception of labor influence practice and ideology. It shows that, for trained eyes, the built environment can appear directly as a witness of the traditions, skills and social conditions of labor. In close relation to Ruskin, Morris is able to see beyond the objective shell of materials, through the marks of labor, into the hands and the experience of the craftspeople, and associate this perception to the emergence of beauty.

Concluding Remarks

While ideals of beauty, style, art and aesthetics in these authors differ in form and content, they show a tendency of relating the product of human labor to a particular perceptual fruition of architectural objects - be it its corruption or otherwise. Underlying their theoretical developments, it is possible to recognize a missing connection, often underexplored, that suggests how labor is inscribed in the material manifestation of architectural objects, making its way in perception and shaping how the experience of the built environment is constructed subjectively. In that sense, our perception of the environment includes recognition of architecture as a collective endeavor, encompassing the ways of making performed in our social and historical contexts - in other words, as “part of a *zeugganzes* - a system of tools, a technical system forming a whole” (Gell, 1996).

On a darker note, what also surfaces is a tension between the acknowledgement of labor’s sensorial manifestation and an overruling force keeping it peripheric in architectural discourse. When architectural discourse foster an idealist notion that materials are primarily means of reference, materiality becomes diminished to an *image* (Ferro, 2016). The immediate physical qualities of materials appear as the most important constituents of the architectural atmosphere, and their composition by the architect’s careful curation becomes the primary concern, feeding arguments of authorship, personal interest, inspiration and innovation - a particular lexicon that doesn’t include productive labor. This skewed notion of materiality opposes the actual recognition of labor in architectural objects, as can be seen in Ferro’s account of the construction of Le Corbusier’s La Tourette (Ferro, 2006). From archival research, the author shows that, in contradiction to the discourse of rationality of brutalism, the building process of the monastery was anything but rational, marked by all sorts of mistakes, improvisation, inadequacy, etc. Far from the constructive honesty it represents, the example shows that materiality can be manipulated to *simulate* a mode of production, stimulating

a false interpretation of the actual material trajectories of a building. Returning to the process of abduction, it poses the question of which possible associations architecture discourse fosters, and brings to mind the necessity to remember the duality of architecture as *fiction*, a *signifier*; a representation of society. Confronting this contradiction requires the inclusion of such questions in both theory and practice. As in the above-mentioned research, historiographical reviews on architecture by the perspective of labor are particularly important. It is a first step to incorporating other epistemologies on architectural production, which may offer new ways to understand how materiality affects spatial experience and to take advantage of its potentialities, while clarifying the political and symbolic hierarchies underneath its surface. In the very least, it may open the discourse to other voices outside the traditional circles of architecture and help pave a way for a production that better reflects its social, material and historical environment and, thus, carries greater potential as a phenomenological construction.

References

- Alberti, Leon Battista. 1988. *On the Art of Building in Ten Books*. Cambridge: MIT Press.
- Avermaete, Tom. 2016. "Architecture and Its Epistemes." In *Theories and Methods in Landscape Architecture*, edited by Ellen Braae, Savava Riesto, and Tom Avermaete, 8-14.
- Baljon, Cornelis J. 1997. "Interpreting Ruskin: The Argument of the Seven Lamps of Architecture and the Stones of Venice." *The Journal of Aesthetics and Art Criticism* 55 (4): 401. <https://doi.org/10.2307/430927>
- Bradley, His Book. 1896. "William Morris, Artist, Poet, Craftsman," 1896.
- Cache, Bernard. 2002. "Gottfried Semper: Stereotomy, Biology, and Geometry." *Perspecta* 33 (2002): 80. <https://doi.org/10.2307/1567300>
- Carpo, Mario. 2018. "The Craftsman and the Curator" 44 (May): 86-91.
- Ferro, Sergio. 2006. *Arquitetura e Trabalho Livre*. São Paulo: Cosac Naify.
- Gell, Alfred. 1996. "Vogel's Net: Traps as Artworks and Artworks as Traps." *Journal of Material Culture* 1 (1): 15-38.
- Ingold, Tim. 2009. "The Textility of Making." *Cambridge Journal of Economics* 34 (1): 91-102.
- Kapp, Silke. 2016. "Construction Sites of Utopia." In *Industries of Architecture*, edited by Katie Lloyd Thomas, Tilo Amhoff, and Nick Beech, 125-34. Abingdon: Routledge.
- Morris, Thomas. 1908. *News from Nowhere*. Longmans, Green, and Co.
- Ruskin, John. 1849. *The Seven Lamps of Architecture*. London: Smith, Elder, and Co.
- Rykwert, Joseph. 1982. "On the Oral Transmission of Architectural Theory." *Res: Anthropology and Aesthetics* 3 (3): 68-81. <https://doi.org/10.1086/resv3n1ms41625300>
- Semper, Gottfried. 2004. *Style in the Technical and Tectonic Arts; or, Practical Aesthetics*. Los Angeles: Getty Research Institute.
- Vitruvius. 1955a. *On Architecture*. 3rd ed. London: Harvard University Press. <https://doi.org/10.1109/MS.2006.52>
- . 1955b. *The Ten Books on Architecture*. Cambridge: Harvard University Press. <https://doi.org/10.1130/SPE63-p36>

Williamson, Rebecca. 2019. "Thinking Through Building." *Montreal Architectural Review* 6: 11-27.

The Ambiance of Rome Self-Managed Spaces as Dispositif de Sensibilisation

How Space Sensory Experience Can Lead to Approaching a Political Cause?

Simone RANOCCHIARI¹

Abstract. As occupied and ‘self-managed political-sociocultural spaces’ in Rome are material urban spaces, we consider the aesthetic experience of their ‘ambiance’ as a central factor of engagement, helping to build attachment to the place and to develop the desire to ‘make community’. Therefore, we analyse ambiances as spatialized dispositifs de sensibilisation, with a special interest in the degree of influence of the synesthetic process of ambiance - e.g. architecture, nature, smells, symbols, lighting, humidity, temperature, arrangement, attendance, etc. - on the choice to commit. We are also interested in existing feedback loops, understood as resulting from the fact that the perception of an ‘ambiance’ can lead activists to want to change it over time if it induces topophobia.

Keywords. Social Movements, Commons

Introduction

The research focuses on what we call “self-managed (political-)sociocultural spaces (SSCS)” of Rome. It is a denomination established in order to put together different militant experiences that, despite their different denominations, are characterized by some common points: they are political, social and cultural experiences operating on a material urban space, self-managed by an assembly.

These ‘spaces’-activists prefer the use of the term ‘space’ rather than ‘place’ (Mudu, 2004) - may have a more or less explicitly militant character, be illegally occupied or granted for social purposes by local administrations; they may (1) arise as ‘spatialization’ of a previous political collective (2) or appear from local battles for the preservation of urban spaces or (3) for the (re)conquest of spaces of sociality in deprived areas. Some are “occupied and self-managed social centres (CSOA),” a movement born more than 40 years ago, within the radical left (Mudu, 2004) and highly stigmatized by the political right and the media (Pecorelli, 2015); others, mainly the more recent ones, are inspired - more or less openly - by that movement but without using its name (Mudu, 2012).

The common point among these different types of SSCS is that in all cases, activism is put in practice through a material space. In this type of configuration, material space, and its *ambiance*, become a determining factor, in the sense that it is the experience of the space itself that determine who you are able to attract or not, and not only the activities offered by the places. We could argue that this applies to many different cases (e.g. a restaurant manager tries to create an ambiance according to its target consumers).

¹. Institute of Geography and Sustainability - University of Lausanne, Switzerland, simone.ranocchiari@unil.ch

As far as political causes are concerned, however, we are less often confronted with this issue, at least in its purely spatial anchoring. In fact, in order to attract support for one's cause, literature usually highlights how one organization opts for various 'devices' - advertising campaigns, posters, public events, etc. - that aim to stimulate a certain emotional reaction in people, able to 'sensitize' them to their cause; what Traini (2009) calls "*dispositifs de sensibilisation*."

In the case of SSCS, we consider that in addition to the use of the already mentioned 'classical' devices of political activism, the material space itself works as a complex and spatialized *dispositif de sensibilisation*.

Exemplifying the Role of the Ambiances

Before exemplifying how the *ambiances* play the role of *dispositifs de sensibilisation* in the case of four Roman SSCS, we briefly present the case studies:

CSOA Forte Prenestino (FP): the most emblematic social centre in Rome. Occupied in 1985, it is located in a 19th century fortress. Outside the big events that can attract thousands of people, every day FP offers sports, theatre and music courses as well as a pub, a wine bar, a tea room, a restaurant and cultural or musical events.

Villaggio Globale (VG): occupied in 1990, it is located inside the former slaughterhouse of Rome. Initially oriented towards intercultural activities, after internal divisions, VG has gone through a techno-music-oriented phase. The unwished consequences of this phase conducted the activists to another change, with activities oriented to artists and craftsmen.

Casetta Rossa (CR): is a small house located in a park, which was occupied in 2000 by some of the older activists of another CSOA, in order to create a space that corresponded more to their age. It hosts many political, social and cultural activities, as well as a restaurant open every day.

Casale Alba Due (C2): is a farmhouse located in a park, which was occupied in 2013 in order to fight against the extension of the nearby prison on the park. It offers various courses and different events (film forums, concerts, meetings and cultural presentations).

As a preamble to their analysis, it should be remembered that even if *ambiances* are by definition "synesthetic" (Thibaud, 2015), we will *break* them *down* into different components, in order to facilitate their understanding. This analysis was carried out from interviews conducted with several activists (named by their initials in the text) in 2019 and early 2020.

Visual Language

By visual language of spaces, we mean mainly tags, graffiti as well as the different posters and flags (mainly political) that often cover the walls and facades of these spaces. SCSS's walls emerged, in our interviews, as a conflictual element.

For some, as L., a former FP activist currently in CR, the 'talkative' character of SCSS walls is one of the things that impressed her more positively when she first visited one of these spaces. The presence of these 'messages' transformed the experience of attending a concert, from an act of pure entertainment to an act of perceiving, even

if ‘passively’, ‘a content, something to transmit to the person who was using that space’.

While these messages conveyed by the walls are perceived in a positive way by some people - and can contribute, as for L., to commitment - according to some of the activists they can also repel others, especially in the case of strong, radical messages.

The case of C2 is particularly interesting in this respect: since its occupation, C2 was supposed to be ‘a non-social centre’, i.e. less oriented youth and underground culture, in order to be attractive for a wider public, especially from the neighbourhood. That was put in place through a different event programming but also through some spatial strategies: the walls seem to be much ‘cleaner’ here than in other spaces. Effectively, according to M., an activist recently arrived at C2, “if your goal is to catch as many people as possible (...) and then promulgate your ideals, let’s say that some writing may not allow you to do so because then you can only catch certain types of people’. If instead, as in the case of C2, you want ‘to get a little more people together [...] you have to understand the dynamics of the neighbourhood, of who is frequenting the place.” Despite the fact that he defines himself as an anarchist, M. thinks that some radical messages (e.g. against the police) can be really divisive: the solution is not to give up one’s ideals, but to promulgate them in a more ‘discreet’ way, since “some people need to approach reality a little more quietly.”

Cleanliness

Another issue that appeared to be central is that of the cleanliness of the space, and more specifically of an apparently trivial but actually fundamental architectural space: the toilets. This space appeared effectively several times in the interviews as a key component of militants’ and users’ spatial experiences of our case studies.

P., a long-time C2 militant and committed for years to various struggles, emphasizes that the toilets of FP (essentially an uncomfortable squat toilet and a series of equally uncomfortable chemical toilets) are never clean, which makes her think - with a vein of sarcasm - that it is a ‘gutter punk connoted’ space: in short, not very welcoming for people like her who are not keen on that kind of aesthetic and practices.

For VG, a space that has undergone many changes, the question of toilets also appears as central. As we said, VG has experienced three distinct phases. According to A., who has been an activist there for more than 10 years and lived all its phases, during the techno period, the VG had reached social and material conditions that were repellent for many people. In fact, during the techno phase, “there were no toilets anymore. That is, there were toilets but they were unliveable, in the sense that a child, a parent, a sane person would not have entered! And that makes you realize the level you reached. If you want to be open to everyone as before, you have to go back at least to a level where people have the courage to enter [this place].” We can see how the toilets - the symbolization of the general *ambiance* of the VG at that period - became the input that made the activists realize that they needed a radical restructuring of their material space and their practices in order to continuing the idea of having a positive social impact.

The resolutely underground *ambiance* of VG during the techno phase (A. cites both the writing on the walls and the WC) could effectively work to attract young people looking for fun or to make graffiti, but who were rarely interested in actually commit to the cause.

Odours

Another issue is the one of odours, not only of toilets but also, for example, of smoking (both cannabis and cigarettes). Most of the spaces in question claim to be anti-prohibitionist and most of the interviewed activists did not seem upset by the fact that in many spaces a strong smell of cannabis can often be perceived. However, C2's activist P., argues that another reason why she does not feel so much at ease in FP, especially at night, is the fact that she perceives a 'toxic air', which reminds her of the era of the heroin crisis she experienced in her youth.

In general, however, within many of these spaces you can smoke both pot and cigarettes without problems, with a few exceptions. At C2 you can never smoke inside. On this, P. recognizes the exception they are among the other spaces; she also points out the fact that this attitude might give the idea that they are more 'prude' than the other spaces, implying the (negative) consequence of being less attractive for young people. D., a young C2's activist, also recognizes this risk, but he has no doubt that this is the right way to proceed, since "you can [easily] find other spaces where you can do drugs or have a rave, but it is much more difficult to find spaces where instead create a dialogue between middle school and retired people."

Light and Temperature

When asked how her first assembly at FP was, L. replies that she found the ambiance rather 'threatening', stressing her so much that before she spoke for the first time, she said to herself, "oh God, I'm going to die." This *ambiance* is not only imputable to the other militants (despite as we will see, it counted as well) but also for what she calls a "somewhat frozen atmosphere [...] [in] this not really enlightened place" which made the assembly look as "a very complicated organism to interact with or [just] to take the floor." Although this start had frightened her, she still managed to integrate FP's activist community, although this aspect of a cold, dark ambiance returns several times in L.'s account of her 8-year-long experience at FP.

The question of temperature also returns several times in the interviews, since, often, these spaces were not built in order to host socio-cultural activities. This can create real difficulties in carrying out political activity when the long meetings are made even harder to stand by winter temperatures.

Attendance

Attendance to space - i.e. which people are there at the moment of the experience - is actually both a consequence of the ambiance and a component of it, since we are facing "a movement of mutual constitution of the built environment and social practices" (Thibaud, 2015, 195). As we have seen in the previous subsection, the presence of people in the space at the moment one experiences it - for example at one's first visit or assembly - also contribute to the experience of the space we live, to its ambiance. In addition to the 'frozen atmosphere' and the 'dimly lit space', what made L.'s first experience at FP 'threatening', is the fact that she was surrounded by long-time militants, with "some historical dynamics, quite outlined among them." This reminds us that this procedure of decomposition of the ambiances is artificial - even if necessary to emphasize the single aspects that emerged from the research - since it is the set of these components that gives the dominant '*emotional tone*' of the place (Thibaud, 2015, 200).

The question of the 'diversity' of the people attending these spaces appears strongly in the interviews: the already mentioned intergenerationality of C2 is in fact one of

the aspects that impressed most of the people I interviewed. For CR the discourse is similar: the participation of people from the neighbourhood, including many elderly people, is one of the aspects that most amazed and attracted S. and L. For the latter, this is particularly true especially if compared to FP that she calls-ironically- "a threat to biodiversity." In fact, she thinks that compared to CR, people attending FP are much more 'aesthetically homogenized': "the clothes [...], the hair [...], the piercings, the tattoos" seemed to be the same for everybody. She perceived it now as a 'somehow repulsive' factor that can have an impact on the "type of audience it attracts." The fact that CR is particularly 'biodiverse' is therefore for her something attractive-contributing to her new commitment-and which sends "a different message to the outside also in terms of usability" of the space.

Conclusion

The components into which we have broken down the ambiances of these spaces are just some of the many that we could have chosen. However, this operation of decomposition-necessary for the intelligibility of my argument-is a narrative expedient rather than a coherent description of the phenomenon, given that ambiance, by definition, "gathers all the senses simultaneously" (Thibaud, 2015, 57).

The analysis brings us to the fact that the concerned SCSS-regardless of their name-are obliged to confront the fact that they "are often demonized by mass-media representations" (Pecorelli, 2015, 283). It appeared that activists are conscious of this stereotype, that they alternatively seem to claim or to reject. In fact, activists' discourses around the question of the ambiance seem to describe two opposite and only at first sight contradictory poles:

- On one hand, the stereotyped social centre (young, underground, libertarian if not clearly 'gutter punk');
- On the other hand, the idea of a politicized space that can be attended by many different of people, especially by those who we would not expect to find inside the first pole.

The two poles that we have mentioned are obviously extreme representations, or 'ideal types' that therefore do not correspond to an objective reality. As we have seen, the same space can actually tend towards both, depending on three different factors of variation:

- On the person who experience them (e.g. its age, but also the environment in which one is used to evolve or its political positions). We can point out that even if ambiance is a 'sharable experience', this "does not necessarily mean that it is inevitably perceived in the same way by everyone" (Thibaud, 2015, 280);On the temporality (night/day; week/weekend, etc.). In fact, "sensitive phenomena (...) vary according to the type of attendance at the place and the actions in progress. In this sense they reintroduce the temporal character of situations" (Thibaud, 2015, 195);On the epoch (different phases of the spaces that can make it tend towards one or the other of the ideal types, as for VG).

The last two parameters show us that the same person can associate the same space to different ideal types, depending on when one experiences it.

As we have seen, activists can make choices in order to make their space tend towards one or the other ideal type. In this sense, we can therefore understand ambiances as spatialized *dispositifs de sensibilisation*. This leads us, however, to ask ourselves

whether this way of acting could not be thought as a kind of ‘*sensorial marketing* (retail atmospherics)’ contributing - paradoxically - to keep away from SCSS “certain social categories considered undesirable” (Thibaud, 2015, 299-301). Is this attention, could ambiances be a way to repel more marginal people in order to attract people considered more socially acceptable (e.g. for the media)? Or is it just, as some activists say, a matter of creating the right compromise to make these spaces accessible to everyone?

References

Mudu, Pierpaolo. “Resisting and Challenging Neoliberalism: The Development of Italian Social Centers.” *Antipode* 36 (5) (2004): 917-41.

———. “I Centri Sociali Italiani: Verso Tre Decadi Di Occupazioni e Di Spazi Autogestiti.” *Partecipazione e Conflitto* 1 (2012): 69-92.

Pecorelli, Valeria. “Spazi Liberati in Città: I Centri Sociali. Una Storia Di Resistenza Costruttiva Tra Autonomia e Solidarietà.” *ACME: An International E-Journal for Critical Geographies* 14(1) (2015) : 283-97.

Thibaud, Jean-Paul. *En quête d’ambiances : éprouver la ville en passant*. 1st ed. Genève: MétisPresses, 2015.

Traïni, Christophe. *Emotions...mobilisation! Sociétés en mouvement*. Paris: Presses de Sciences Po, 2009.

Participate in the Atmosphere

Distribution of Involvements and Attachments as Urban Construction

Olivier OCQUIDANT¹

Abstract. This article reports on an ongoing ethnographic survey of the post-industrial city of Saint-Étienne (France). Through a sensitive approach and a methodological use of walking, attachments and relationships to places are questioned. Urbanity and atmosphere appear to be the result of three types of daily actions of city dwellers: the production of ordinary civilities, the evaluation of amenities and the memory recognition. This approach aims to consider the city through its resources of attachment and to take care of them.

Keywords. Urbanity, Involvement, Attachment, Atmosphere, Interaction

Atmosphere is not only something present in the place, in its material form or architecture. It is essentially made by the activities of the living and by their traces (Ingold, 1993). Understanding the atmosphere of a city through an ethnography of its public spaces requires investigating what is done there. We are dealing first with interactions between people, most of them “unfocused” (Goffman, 2013), diffuse, by the way. These interactions make up a type of “public order” (Cefaï, 2013), particular forms of cooperation, coordination, opposition, tension and indifference depending on the places, times and social worlds involved. Moreover, city dwellers constantly evaluate the accessibility of spaces by looking for signs of trust, regularity and predictability (Joseph, 1998). They identify obstacles, alarms, changes in atmosphere (Gibson, 2014; Goffman, 1973; Thibaud, 2015). The flatness and regularity of the ground, the width of the sidewalks, the absence of obstacles and the predictability of the spatial form, allow movements to be made without calculations or corrections.

Our thesis research develops an ethnography of public spaces through the prism of the sensitive, in a post-industrial city (Saint-Étienne). The survey tools are observations, photography and filming, interviews and “commented walks” (Thibaud, 2015). This medium-sized popular city has an urbanity that differs from the dominant metropolitan model. As a city in decline, it has a relatively low interactional density and urban animation. Its downtown area is small. It resembles a “mosaic of neighbourhoods” corresponding to a type of “suburban city” (Merriman, 1994). It also has a high level of mobility as a city of migration and work. Overall, we can see various reasons why urbanity could be weakened: the recurrence of “mixed contacts” (Goffman, 1975) that complicate ordinary civilities, post-industrial spaces that are not very welcoming, and attachments weakened by high mobility. These characteristics are fairly typical

1. Centre Max Weber, University Jean Monnet of Saint-Étienne, France, olivier.ocquidant@st-etienne.archi.fr

of a working-class city. In this field, our survey revealed three types of ordinary actions that build urbanity: the reduction of stigmatization, the multiplication of attachments, and the mobilization of memory through places.

The walkers surveyed say little about their relationship with other people in the public space. The qualities attributed to the places and ambiances themselves bear witness to possible tensions in the civil bond (Pharo, 1985). The work of the ordinary civil bond, as “civil inattention” (Goffman, 2013) and as the management of “vehicular units” (Goffman, 1973), was highlighted by our ethnographic observation. We observed the importance of the phenomenon of stigmatization, which is an interactional and co-produced process (Goffman, 1975). Usually, passers-by carry out a “cognitive recognition” aimed at dodging other passers-by, without paying attention to their specific identities. A “social recognition,” on the contrary, consists in identifying a person according to a particular category (depending on the context, a woman, a black person, a handicapped person, a beggar, a young Arab in a tracksuit, a rich person, etc.). According to our observations, the stigmatized quite often carry out a visual check at a distance (between 30 and 15 metres) by which they gauge the type of recognition produced by the person arriving opposite (Goffman, 2013). If this person also looks from a distance, it is a sign of identification that is not simply cognitive (which is done at close range), but social.

In these scenes of ordinary public life, a work of social identification and situational definition is carried out, between civility, distinctive claim, and indifference. Forms of offense also occur, for example through disrespectful vehicular behaviour (forcing the other to change lanes), or ‘uncivil attention’ (staring at passers-by). Suspicion and the demand for reparation are common for the stigmatized persons, while caution and avoidance (of eye contact and vehicular unity) are common for the “normal persons” (Goffman, 1975). ‘Stigma reduction’ (or destigmatization) is a way of calming the atmosphere by attempting to transform social recognition into more cognitive recognition. The difficulty is to achieve felicity’s condition of an easy engagement in the public space without ratifying the roles of suspicion and avoidance. The stakes are high because recurring tensions can lead to a segregation of spaces of sociability and produce a “vulnerabilization of the civil bond” (Garcia Sanchez, 2007).

By investigating the experiences of public spaces through “commented walks” (Thibaud, 2015), we identified different types of situations ranging from tension to ease (through snagging, neutrality, and moments of felicity). In these walks, several types of actions are carried out: aesthetic and sensitive judgements about places (Thibaud, 2015), “valuations” of their convenience and safety (Bidet et al., 2011; Joseph, 1998), and production of their “existential content” by evoking memories (Ledrut, 1973). These different actions constantly engage with each other in urban travel. Making people “be in the city” is carried out in a plural, labile and exploratory way. The plurality of objects and registers of valuations (Bidet et al., 2011) seems to give public experience a multiplication of its motives, producing sufficient “reserve” (Simmel, 2013), “social innocuity” (Gayet-Viaud, 2006) and “ordinariness” (Schutz, 2013; Garfinkel, 2007). The question is then to know which “affordances” (Gibson, 2014) and attachments are capable of maintaining this type of commitment.

The elements valued or surveyed by the walkers (aesthetics of the place, atmosphere, hospitality, temporal links) do not only refer to the urban materiality. They constitute affordances that allow the construction of attachments (Hennion, 2009), that foster sociability, commitments and relationships between people in the city. For example,

the scenic configuration of a place (horizon, width, spacing) configures the interactional and social “work” (Schutz, 2008) in a more or less frontal, near, lateral, or distant manner. Also, the presence of movement, background noise or visual backgrounds are supports for our attention and expectations of the urban experience (Hillier, 2007). Their absence can bring social interaction to the forefront and cause disturbances. Certain “details” of urban space (trees, fountains, facades, light, viewpoints) are anchors in a phenomenological dimension of “being-there” that frame attention and interaction (Seamon, 1979). For example, the recurrence of “snags” in the way that “racially” different men look at each other, clearly diminishes in the context of metropolitan animation or festive unrest (e.g. the football Euro). In these contexts, commitments and participation are multiplied, accelerated and densified. This type of sensitive mobilization (Cefai, 2007) is not outside the scope of social work. They constitute resources that promote the work of co-presence and urbanity. These resources lateralise, produce spacing, and densify social experience, and configure at last relations. They take a particular importance in a “suburban city,” which inhabitants deal with complex belonging, many of whom are foreign or even “disaffiliated” (Castel, 1995).

Surveyed marchers often looked for traces of their past. Through the search for precise clues, erased or changed by the passage of time (buildings, graffiti, shops, friends’ apartments), they have mentioned past experiences in places. Remembrance can enhance the experience of places and open up depth and horizons (Heurtin, Trom, 1997). On the contrary, if its evocation is unfortunate, the past can lead people to avoid certain places and prefer others. Through these remembrance activities, urban spaces acquire an existential or “vital” quality (Ledrut, 1973). They are grounds for ordinary exploration and investigation that produce urbanity. These memories, more or less invested and maintained, can give rise to pleasure, disappointment, and even “disgust.” The conservation of historical depth is therefore not only a heritage issue. It is an essential support for memory, “authenticity” and the experiential intensity of living (Roncayolo, 1996; Heurtin, Trom, 1997).

Investigating the urbanity and atmosphere of a city aims to improve knowledge of the ordinary attachments of city dwellers. Urbanity is produced by many daily actions, the defect of which tends to “exhaust public space” (Joseph, 2004). Understanding the ordinary ways of “making the city” make possible to identify the functioning of an effective urbanity, its problems, and possibly to intervene on problematic aspects. Our survey could thus, in a pragmatic way, offer some avenues for thinking about urban transformation. As noted above, the continuity and regularity of the “affordances” (Gibson, 2014), as well as the presence of life and movement, reinforce the ease of pedestrian movement. Historic and memorial elements, including traces and “details,” provide a dimension of authenticity to the experience. And urban “spacing” (Goetz, 2001) provides backgrounds of experience that facilitate co-presence. It is therefore important to develop and take care of these urban objects that support daily exercises of attachment and “taste” (Hennion, 2003). Because urbanity is made through them.

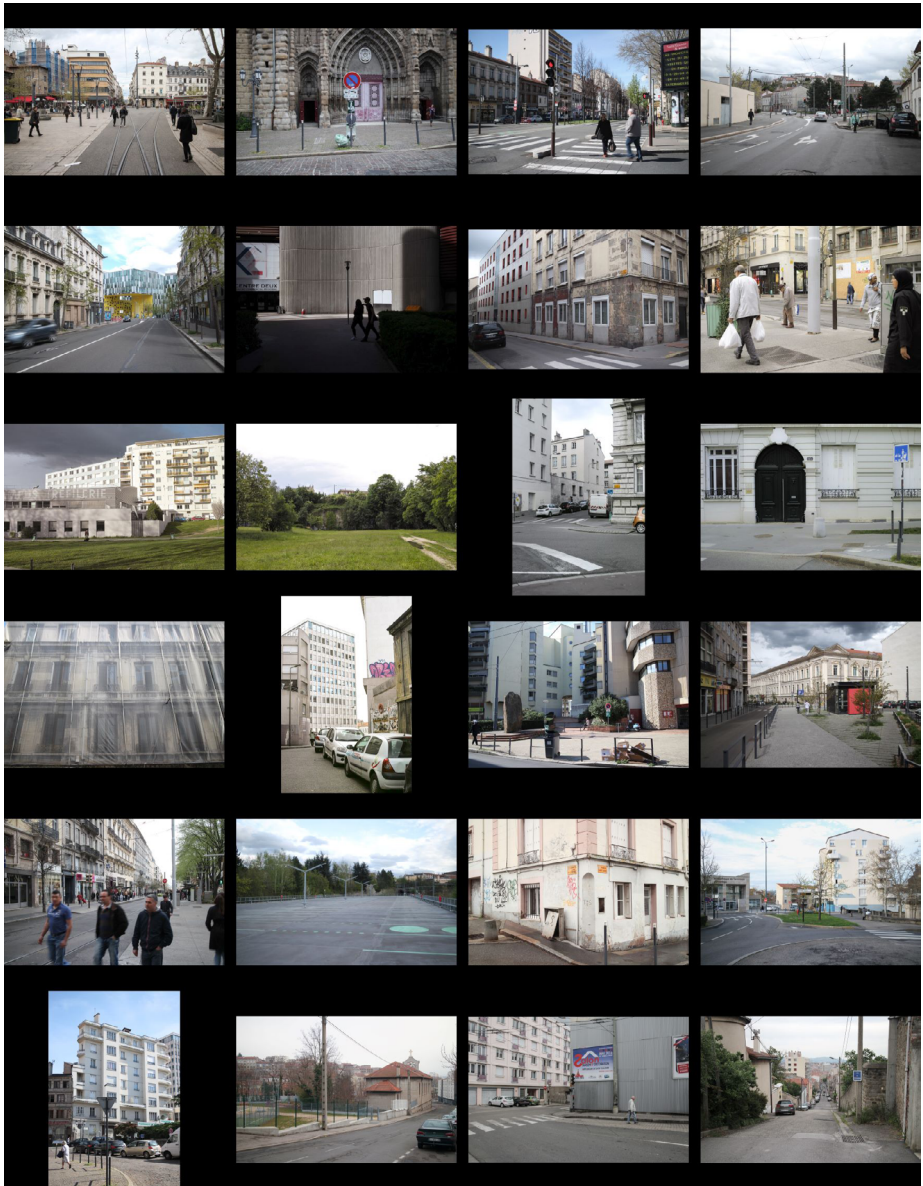

Figure 1. Extract from photographic drifts by the author.

References

- Bidet, Alexandra & Quéré, Louis & Truc, Gérôme. "Ce à quoi nous tenons. Dewey et la formation des valeurs." In *La formation des valeurs*, edited by John Dewey, 564. Paris: La Découverte, 2011.
- Castel, Robert. *Les métamorphoses de la question sociale: une chronique du salariat*. Paris: Gallimard, 1995.
- Cefaï, Daniel. "L'ordre public. Micropolitique de Goffman". In *Comment se conduire dans les lieux publics. Notes sur l'organisation sociale des rassemblements*, edited by Erving Goffman. Paris: Economica, 2013.
- . *Pourquoi se mobilise-t-on: les théories de l'action collective*. Paris: Découverte : M.A.U.S.S., 2007.
- Garcia Sanchez, Pedro Jose. "L'engagement à l'épreuve de " l'animal borné des villes """. In *Isaac Joseph : itinéraire d'un pragmatiste*, edited by Daniel Cefaï, and Carole Saturno, 26175. Paris: Economica, 2007.
- Garfinkel, Harold. *Recherches en ethnométhodologie*. Paris: PUF, 2007.
- Gayet-Viaud, Carole. "De l'innocuité sociale aux degrés d'humanité. Les types du petit vieux et du bébé." *Les Annales de la recherche urbaine* 100 (2006): 5967.
- Gibson, James Jerome. *Approche écologique de la perception visuelle*. Bellevaux: Dehors, 2014.
- Goetz, Benoît. *La dislocation: architecture et philosophie*. Paris: Passion, 2001.
- Goffman, Erving. *Comment se conduire dans les lieux publics: notes sur l'organisation sociale des rassemblements*. Paris: Économica, 2013.
- . *Stigmate: les usages sociaux des handicaps*. Paris: Minuit, 1975.
- . *La mise en scène de la vie quotidienne. Les relations en public*. Vol. 2. Paris: Minuit, 1973.
- Hennion, Antoine. "Ce que ne disent pas les chiffres... Vers une pragmatique du goût." In *Le(s) public(s) de la culture. Politiques publiques et équipements culturels*, edited by Olivier Donnat, and Paul Tolila, 287304. Paris: Presses de Sciences Po, 2003.
- . "Réflexivités. L'activité de l'amateur". *Réseaux* 153/1 (2009): 5578. <https://doi.org/10.3917/res.153.0055>
- Heurtin, Jean-Philippe & Trom, Danny. "L'expérience du passé". *Politix* 10/39 (1997): 7-16.
- Hillier, Bill. *Space Is the Machine : A Configurational Theory of Architecture*. London: Spacesyntax, 2007.
- Ingold, Tim. "The temporality of the landscape." *World Archaeology* 25/2 (1993): 15274.
- Joseph, Isaac. *La ville sans qualités*. La Tour d'Aigues: L'Aube, 1998.
- . *Météor: les métamorphoses du métro*. Paris: Économica, 2004.
- Ledrut, Raymond. *Les images de la ville*. Paris: Anthropos, 1973.
- Merriman, John. *Aux marges de la ville: faubourgs et banlieues en France 1815 - 1870*. Paris: Seuil, 1994.
- Pharo, Patrick. *Le civisme ordinaire*. Librairies des méridiens. Paris: 1985.

Roncayolo, Marcel. *Les grammaires d'une ville: essai sur la genèse des structures urbaines à Marseille*. Paris: École des hautes études en sciences sociales, 1996.

Schütz, Alfred. *Le chercheur et le quotidien: Phénoménologie des sciences sociales*. Paris: Klincksieck, 2008.

Seamon, David. *A Geography of the Lifeworld. Movement, Rest and Encounter*. London: Routledge, 1979.

Simmel, Georg. *Les grandes villes et la vie de l'esprit: suivi de Sociologie des sens*. Paris: Payot & Rivages, 2013.

Thibaud, Jean-Paul. *En quête d'ambiances: éprouver la ville en passant*. Genève: MetisPresses, 2015.

Towards a Sensory Patrimoine?

Atmospheric, Psychological and Ecopolitical Issues on Smell and Sound Identity

Victor FRAIGNEAU¹

Abstract. This paper addresses the notion of “sensory patrimoine,” by questioning our control of the natural elements, and the processes of patrimonialization. It considers this notion according to the sound or smell sensorialities. These thoughts are illustrated by several examples, in Switzerland, France, and Japan. We define under what conditions we can characterize the sound or olfactory identity of a place or an environment. Helped by the works on environmental identity, we thus investigate the modalities for sharing these sensorialities to create a common identity. We then define a key to understand our responsibility toward the environment, and we call for a balance to be found in future works on the inventory of smell and sound characters.

Keywords. *Smells, Sound, Patrimoine, Environmental Identity*

On Ambient ‘Patrimoine’

The notion of a sensory heritage and identity, which we will first address as “sensory patrimoine,” is not foreign to the field of ambiances. In 2012 for the 2nd International Congress on Ambiances, Nathalie Simonnot already put forward some guidelines to understand this rather new field. Her thoughts followed the milestones that she herself set up in 2011 with Daniel Siret, written in a later paper (Simonnot and Siret, 2014). Their observation is as follows: while many mediums are emerging and innovating for the promotion of a certain “sensory patrimoine” in the built environment, whether in the cultural, tourist or educational fields, these attempts are revealing the elusive and highly subjective status of ambiances, which can easily escape or dissolve with each attempt to fix them. Nevertheless, such efforts often prove to be highly instructive, and the means used to present a past sensory situation prove that to a certain extent the knowledge that we can draw from an experience of ambiance can be shared. We then suggest, keeping in mind their conclusions, updating the notion of “sensory patrimoine” extended to natural environments. We are going to test this notion regarding invisible and short-term temporality sensorialities, such as sound or smell.

Considering the natural environment in its sound dimension, recent research (Sueur and Farina, 2015) tends to prove that determining a sensorial identity in a given territory allows us to observe the evolution of acoustic qualities in particular, and biodiversity in general. We have here an alternative measurement tool to evaluate the impoverishment of the sound diversity coming from non-human actors (such as birds or insects), which informs us about certain characteristics of biodiversity and can subsequently lead us to take caring actions. With this example, we are witnessing a

1. ENSA Paris-la-Villette & Université Paris 8, GERPHAU laboratory, France, victor.fraigneau@gmail.com

shift from identity characterization to means of “patrimoine” characterization. Jérôme Sueur’s work, which focuses on the inventory of animal sounds diversity, calls for a similar approach for other characters of the soundscape, and, by analogy, we can foresee that similar results could be achieved by looking at the olfactory dimension. There, many experiments have identified characteristics that help to define the olfactory identity of a place or even a territory. Assuming the ephemeral and subjective nature of this sensibility, cartographic works such as those by Kate McLean (2019) thus overcome the issues of fixing modalities that are in essence dynamic.

By reading Simonnot’s work and her thoughts about the means to “patrimonialize,” we understand the relationship established, by analogy, between the history of the construction of the material heritage and the consideration of monuments. What about immaterial heritage, and now sensory “patrimoine”? For the first point, the answer is brought by the actions already carried out, for example, at the national and international levels in specific lists. But how can we define what would be a monument for the sensory field? We would like to point out that this attitude would seem like ranking the sensory qualities of a situation.

The Patrimonialization of Elusive Characters

A first answer, for instance, can be indicated by the museification of sensory characters, where they then acquire a cultural status. One of the first remarkable attempts in this matter was the exhibition held in 2003 at the Forum of Swiss History in Schwyz, which had for topic “Alpendüfte”: the characteristic smells of the Swiss Alpine landscape². This exhibition presented a historical-cultural approach to the sensual phenomena in the Swiss environment and an exhibition experience with more than 80 different smells. On one part, the public could feel smells typically pleasant, such as certain typical species of flowers, wood, hay and musk. On the other part, it was possible to experience less consensual smells: the strong smells of alpine livestock farming, traffic, and goods that today also characterize this environment. In both cases, the exhibition value creates for the smell inventory a phenomenon of patrimonialization. A similar approach leads designers to imagine ways of diffusing the olfactory identity of an entire country, as it was the case for the French pavilions at the 2010 World Expo in Shanghai, or the 2015 World Expo in Milan (Busschaert, 2016). In these examples, for the first one, the goal was to experience luxury and perfume through scents, and for the second, certain gastronomic and agricultural specialties, with disputable results in terms of intentions and means.

In 2001 in Japan, the Ministry of the Environment listed places that exhibit sensory situations and phenomena worthy of preservation (100 sites for their olfactory qualities, 100 sites for their sound quality)³. The selected sites fall into two categories: those expressing sensory qualities directly or indirectly related to human activities (including craftwork, cleaning, plantations, cultural or historical practices), and those whose sensory qualities are preserved from human influence. We could link the first category, by analogy, to the definition of a material or immaterial heritage, and the second to what could be called a natural heritage (the term in Japanese is literally “natural monument”: Ten’nenkinenbutsu 天然記念物). In all cases, we have there a choice of situations because of their exceptional - and therefore monumental - character, and thus a sensorial patrimonialization.

2. “Wie riecht die Schweiz” <https://www.swissinfo.ch/ger/wie-riecht-die-schweiz-/3510058>

3. “かおり風景・音風景・星空” <https://www.env.go.jp/air/life/index.html>

The notion of “sensory patrimoine” appeared notably in political debates in France at the end of 2019 when the proposal for a law “aimed at defining and protecting the sensory patrimoine of the French countryside” was presented⁴. This initiative was aimed in particular at making an inventory of agricultural sounds and smells and including them in the “patrimoine code.” The goal was not only to guarantee characters of French “rural identity” - as such worthy of being recognized - but above all to limit the possibilities of legal complaints about neighborhood disturbances, precisely because of the recognition of these heritage characteristics. This law intended to include sounds and smells produced by domestic and wild animals. This motion was rejected by the French senate, arguing that “it is not about human action, whereas the purpose of the patrimoine code is to ‘protect the worthiest works of man’”⁵.

From ‘Patrimoine’ to Environmental Identity

From these different examples, we sense that such a field of research could be worthy of interest in the future. First of all, let us return to the term “patrimoine”: in it as in heritage, there is at least an idea of mastery, if not domination. The processes of domesticity of the environment are linked to a need for trust and a system of control. This can be read from the very etymology of the terms. To come back to the notion of monumentality, with the notion of “sensory patrimoine,” and to a certain extent with the examples we have cited, we can observe each time a call for authenticity. This is defined by an anthropocentric viewpoint, which risks strongly affecting environments that are already very constrained by human influence. On the other hand, we may be confronted with an authoritative argument as to which sensory quality should be representative of a given territory. We see it with the political stakes involved in the issue of sensory identities, and to another extent, in the cultural field. Another balance can be shaken: by setting these characters in history, is there not a risk, as Nathalie Simonnot foreshadowed, of disembodiment of the ambiances that we intend to control? Such conclusions call for prudence and responsibility: this is also what the notion of patrimoine contains. Indeed, we owe architectural and urban historian Lucie K. Morisset, the enlightening distinction between the two notions: “patrimoine - patrimony - is something that you are responsible for developing. You may have inherited it, but beyond that, it has to be actively constituted in order to be handed on to future generations. Heritage thus comes from the past, while patrimony looks to the future” (Morisset, 2010, 54).

Once again, such thoughts raise more questions than they provide answers: if an inventory of sound and smell situations and phenomena can be promising and could guarantee an indirect recognition of human and non-human processes, with what criteria should they be collected, and how should places be chosen, in their locality, their scale, their relationship to humans and nature? Before thinking about “patrimoine,” we should first take an interest in the precise identity of the environments in question. Of course an important step in this field was made by Lynch (1960, 1976) when he advocated for the sensory qualities in environment, but in environmental psychology this very notion of environmental identity was particularly brought to us with the work of Susan Clayton, who established firstly a plurality of identities, as well as an obvious broadness in the appreciation of environments. A major character of the identity of individuals and collectives lies in the links they build in interrelation with the natural world: non-human actors, domestic or wild, inert elements or physical

4. “Patrimoine sensoriel des campagnes françaises (PPL)”

<http://www.senat.fr/tableau-historique/pp19-286.html> [our translation]

5. “Définir et protéger le patrimoine sensoriel des campagnes françaises - (n° 2211)” [our translation]

phenomena linked to a particular place, or more broadly territories of various scales. “An environmental identity is one part of the way in which people form their self-concept: a sense of connection to some part of the nonhuman natural environment, based on history, emotional attachment, and/or similarity, that affects the way in which we perceive and act toward the world; a belief that the environment is important to us and an important part of who we are.” (Clayton et Opatow 2003, 45-46).

Environmental psychology uses the notion of identity as a sentiment, which expresses a relationship, a collective belonging. This definition then constitutes a tool to understand the aesthetic and political involvement in environmental issues, at both the individual and collective levels. It is not a fixed state, but a complex structure that also involves processes, values, attitudes, and behaviors. Clayton argues that this identity is both a personal projection on the environment, as a matrix of ourselves, and a reflection of our actions on it. In this sense, there is a reciprocal synergy between the environment and the individual or collective. Attachment to the environmental identity then incites a feeling of conservation, but also an aura specific to the entities that constitute it. The notion of identity shares similar qualities with sensoriality: our sensory experiences participate in the constitution of our own and group identity, a quality that serves to define us, describe us, and position us. Particularly for the sense of smell, these are also Truong’s conclusions when he states that “olfaction directly impacts human emotion and memories; by virtue of its connection to environmental identity, it also draws emotional, memory, and personal factors into physiological processes” (Truong, Bonnefoy, and Prévot, 2020, 10).

In other words, it is precisely its ambivalent character that constitutes for sensory identity a relevant understanding tool for evaluating our relationship to the environment. It can be defined intrinsically, influenced by the social context, can be enforced, can evolve in intensity or quality depending on individuals and over time: “Identity matters in considering environmental problems because it is contested: Who counts? Who is considered?” (Clayton 2012, 173). In 1995, Mitchell Thomashow already put forward the notion of “ecological identity” to describe how individuals conceive the environment and how they relate to it. He was interested in the notion of ecological identity as manifested in their personality, values, actions, and sense of self. “Ecological identity describes how we extend our sense of self in relationship to nature, and that the degree of and objects of identification must be resolved individually. To be more specific, each person’s path to ecological identity reflects his or her cognitive, intuitive, and affective perceptions of ecological relationships” (Thomashow, 1995, 3). Arguing that personal experience of environments is relevant to evaluate our ecological worldview, he also suggested that the reciprocal is also valid, and wondered how this interpretation leads to new ways of understanding personal identity. Subsequently, this reflection, in a pragmatic application, led him to link up with bioregionalism thinking, to focus, as an educator, on ways of becoming aware of the relationship between man and nature for personal fulfillment and community health (Thomashow, 1998, 129).

To sum up, environmental identity can be understood as a plural notion with several uses: it refers to an identity of territories, to that of individuals themselves about environments, and to that which they attribute to the environments they know. We understand from the work of Clayton and Thomashow that the identity in question is created regardless of the temporal magnitude of the situations or phenomena we experience, even if they only partially address their reflection to the direct sensory contribution in the part of identity. The notions involved may be ephemeral, dynamic, metaphorical, or projected, they nonetheless build our relationship to the environment.

If in this way there is no doubt that environments, even if they are intangible and invisible as for smells or sounds, shape our identity, we have here a fertile field of investigation for the definition of ambiances helped by psychology and ecology. By better understanding the processes at work within urban and natural territories, we can promote recognition of the sensory qualities for the expression of ambient tones.

References

- Busschaert, Adeline. 2016. "La France en représentation à l'exposition universelle de Milan 2015." *Mémoire de Master Médias, Langages et Sociétés*. Université Panthéon-Assas.
- Clayton, Susan D. 2012. "Environment and Identity". In *The Oxford Handbook of Environmental and Conservation Psychology*, New York: OUP USA.
- Clayton, Susan, and Susan Opatow. 2003. "Environmental Identity : A Conceptual and Operational Definition". In *Identity and the Natural Environment: The Psychological Significance of Nature*. Cambridge, Mass: MIT Press.
- "Définir et protéger le patrimoine sensoriel des campagnes françaises - (n° 2211)" Accessed June 3, 2020.
- Lynch, Kevin. 1960. *Image of the City*. Cambridge, Mass.: MIT Press.
- . 1976. *Managing the Sense of a Region*. Cambridge: MIT Press.
- McLean, Katherine Jane. 2019. "Nose-First: Practices of Smellwalking and Smellscape Mapping". Thesis, Royal College of Art. <https://researchonline.rca.ac.uk/3945>
- Morisset, Lucie K. 2010. "Patrimony, the Concept, the Object, the Memory, and the Palimpsest: A View from the History of Architecture". *Journal of the Society for the Study of Architecture in Canada* 35 (2): 53-62.
- "Patrimoine sensoriel des campagnes françaises (PPL)" Accessed June 3, 2020. <http://www.senat.fr/tableau-historique/ppl19-286.html>
- Simonnot, Nathalie. 2012. "Le paradoxe de la patrimonialisation des ambiances". In *Ambiances in action / Ambiances en acte(s) - International Congress on Ambiances, Montreal 2012*, edited by Thibaud, Jean-Paul, and Siret, Daniel, 33-38. Montreal, Canada: International Ambiances Network. <https://halshs.archives-ouvertes.fr/halshs-00745523>
- Simonnot, Nathalie, and Daniel Siret. 2014. "Héritage industriel et mémoire sensible : observations sur la constitution d'un 'patrimoine sensoriel'". *L'Homme la Société* n° 192 (2): 127-42.
- Sueur, Jérôme, and Almo Farina. 2015. "Ecoacoustics: the Ecological Investigation and Interpretation of Environmental Sound". *Biosemiotics* 8 (3): 493-502. <https://doi.org/10.1007/s12304-015-9248-x>
- Thomashow, Mitchell. 1995. *Ecological Identity: Becoming a Reflective Environmentalist*. MIT Press.
- . 1998. "Toward a cosmopolitan bioregionalism". In *Bioregionalism*, edited by Michael Vincent McGinnis. London ; New York: Routledge.
- Truong, Minh-Xuan, Barbara Bonnefoy, and Anne-Caroline Prévot. 2020. "About smells and nature: an exploratory study on the links between environmental identity, smell sensitivity, and sensory uses of natural spaces". *PsyEcology* 11 (1): 7-20. <https://doi.org/10.1080/21711976.2019.1643987>

“Wie riecht die Schweiz” Accessed June 3, 2020.

<https://www.swissinfo.ch/ger/wie-riecht-die-schweiz-/3510058>

“かおり風景・音風景・星空” Accessed June 3, 2020.

<https://www.env.go.jp/air/life/index.html>

Normativity and Aesthetics

The Political Dimensions of Mobility Infrastructure

Claire PELGRIMS¹

Abstract. This article is a reflection on two levels of the ‘political’ in which the *æsthetical* dimensions of mobility infrastructure play a key role. Informed by the empirical analysis of mobility infrastructure recent evolution in Brussels-Capital Region, it highlights on one hand how, at the level of the ‘infra-politics’ of mobility, the sensory accelerating and decelerating dispositifs constrain the potential sensory-motor ways of being as much as regulatory and material ones. On the other hand, it reveals the potential of mobility infrastructure as sensitive environment to sustain, through the resonance between infrastructure, environment, vehicles and bodies, an increasing ambient sensibility that nourishes the political engagement of mobile actors toward a sustainable future.

Keywords. *Mobility, Infrastructure, Brussels, Aesthetics*

Introduction

This paper is an attempt to cross two thoughts about the political dimension of mobility infrastructure raised by the empirical analysis of its recent evolution in Brussels-Capital Region. With a background in the history and theory of urbanism, I draw on sociology, philosophy, and history of transport and mobility to better understand the dialectic of speed and slowness. In my research (Pelgrims, 2020c), I explore the spatial and material frictions and articulations between slow and fast mobilities in a transmodal and diachronic approach, from the metropolitan scale of transport and urban planning to the street construction details.

To analyze (1) material infrastructure that accommodates, through material, sensory, and regulatory *dispositifs*; (2) the fast and slow (*æsthetical*) practices, I consider the first as “sensitive environment” (Thibaud, 2015; Augoyard, 1995). This paper therefore contributes to the recent “sensory and affective turn” in research on mobility infrastructure. Moving away from the binary of mobility and mooring (Sheller and Urry, 2006), scholars have built on atmospheres and ambiances theories to better consider in their methodology the mobility infrastructure changing phenomenological and *æsthetical* dimensions (Lefebvre, 1992; Bennett, 2001; Sheller, 2004; Rosa, 2019; Pelgrims, 2020a). Infrastructure is indeed involved in constant social and material processes that P. Merriman (2016) defines as continuous “mobile infrastructuring.” I conducted a content analysis of non-discursive documents from the municipal archives of Brussels and Ixelles on the meaning-loaded designs and practices of mobility infrastructure referred to in terms of fast and slow movements. I have been searching for these instantiations in original plans and master plans, *vade mecum*, architect’s drawings, and in gray literature gathering discourses, narratives in newspapers, magazine articles, and photographs (Pelgrims, 2020c).

1. *Université libre de Bruxelles - LoUIsE, Belgium, claire.pelgrims@ulb.be*

In this article, I reflect on two levels of the “political” in which the aesthetic dimensions of mobility infrastructure play a key role. First, the dialectic between fast and slow mobilities provides new insight on, as S. Tonnelat puts it, the “infra-politics” of mobility (2016). I’ll describe how the traffic calming dispositifs and the accelerating sensory dispositif on the sidewalks constrain the potential sensory-motor ways of being. The second section deals therefore with inclusivity and openness to the plurality of the world. Secondly, I’ll consider politics in terms of civic engagement and democratic practices toward the sustainability transition. I’ll discuss in the third section how the sensory dispositifs of mobility infrastructure can also enhance this political dimension of mobility.

Normativity Through Aesthetics

Through the lens of ambiance and atmosphere theories, infrastructure is not simply static contextual settings for action but rather immersive environments that are central to mobility experiences. Speed (one of the aspects of mobility flows) partly depends on the sensory “locomotor efficiency” of mobility infrastructure as space of movement. Indeed, urban planners build the city to be traveled at a certain (normalized) speed. They try to “guide, fluidify, synchronize, harmonize the rhythms of the city” (Pelgrims and Hausser, 2019, 1). This attempt manifests through programmatic, regulatory and discursive *dispositifs*. It appears in the materiality and ambient quality as well: in an articulation of sensitive acceleration and deceleration *dispositifs*, and of “ambiance factors.” The interactions between build form and luminous, sound, and other physical signals - as “active potentiality” - give rise to perceptive orientations and specific motor behaviors: specific sensory-motor ways of being. They engage and disengage motor activity of passersby, invite deceleration or acceleration (Gibson, 1979; Thibaud, 1996; Chelkoff and Thibaud, 1992; Pelgrims, 2019). If the ambiance factors have mostly been examined in relation to pedestrian mobility, then a similar analysis can be made with other modes of mobility. The rhythm of the plot, of the facades, the height of the towers, and so on, are built to match specific metrics of mobility. They provoke specific fast or slow aesthetic experiences in the city (Pelgrims, 2020b): speeding in the urban roadscape, wandering in the commercial galleries from one display window to the other side...

In Brussels ‘semi-pedestrian’ roads as rue de l’Etuve (developed in the late 1970s and 1980s and that, since then, stand as references for the refurbishment of most central areas in Brussels) the sidewalks and the passable part of the road are at the same level or slightly raised by about five centimeters, separated only by a line made of blue stones that recalls the former pavement edge. In central areas of Brussels, the slowdown of fast mobility articulates legal instruments of speed limitations with these kinds of material ‘devices’. Through an aesthetic treatment, they blur the legibility of the modal segregation defined in the traditional street profile and, then, make drivers intuitively decelerate. At the same time, the slowdown makes slow mobility more efficient, secured, comfortable, visible... and therefore faster (Pelgrims, 2018).

From Utopia to Ideology

In that sense, urban designs impose a rhythm, set the pace of mobility experience; they can also give rise to alternative experiences - depending on their adaptability and ‘hospitality’ to other practices. The political role of mobility infrastructure is better understood while referring to the concept of “social imaginaries” (Castoriadis, 1975; Berdoulay, Castro, and Gomès, 2001; Pelgrims, 2018). These visions of the world are subject to a double process of instantiation and actualization. While an imaginary becomes dominant-moving from “utopia” to “ideology” (Ricoeur, 1990), imaginary

‘embodiments’ are progressively normalized through the institution of logic and rules: a grammar. These grammars transpose and practically inscribe the imaginary in congruent sensory-motor ways of being and in the material world (Sénécal, 1992; Pelgrims, 2018 and 2019). In that sense, mobility infrastructure materializes and stabilizes mobility imaginaries. Yet, the “poetics” (Sansot, 1971; Gamba, 2011) of these accelerated or decelerated urban experiences in turn updates imaginaries. Moreover, they are strengthened or weakened in a pluralist context of competition with other ones - residual, emerging, critical - and constrained by existing materialities. They therefore evolve, creating, reinforcing and transforming the different articulation logic of imaginary embodiments in the city materiality.

Mobility infrastructure balances the needs to accommodate diversity (of movement, of sensory-motor ways of being) and to establish norms and rules (*polis*) aimed at enabling people to live together (Pattaroni, 2007). The issue is not therefore the existence of an order (norms) but its regimes of justification (Boltanski and Thévenot, 1991) - that is to say its political scope. The description of further material, regulatory and sensitive *dispositifs* making an acceleration or deceleration of mobility flows possible reveals forms of normativity that make certain practices, some attentional regimes, some ways of being... acceptable or not. For instance, the traffic calming *dispositifs* aim at minimizing or rendering invisible non-congruent objects (limitation of on-road parking...) and improper behaviors (Pelgrims, 2018). The deceleration of car mobility and the acceleration of active mobilities decrease the frictions between the relative mobility modes. They therefore meet an imperative of movement ‘fluidization’ that guarantees a slow but cessationless, frictionless, undisputed urban realm, opposing and excluding as much problematic immobility (beggar, youth group...) as speeding practices (pointed at as ‘cowboy’, uncivil...) (Pelgrims, 2018). Accelerating and decelerating *dispositifs* then reduce the plurality of ways of being, and the richness of public space.

Moreover, in the western automobilized time-space, the synchronization of urban rhythms to the automobile speed and metrics may also oppress and constrain individuals to movement mechanization which implies a decrease of what A. Bonnet calls the “presence variation” (2013, 3). This is defined as the variation rhythm of the “ambient sensibility” (Thibaud, 2020) deployed in aesthetic mobility experience in the environment.

The second section discusses how the sensory *dispositifs* of infrastructure can on the contrary enhance this ‘ambient sensibility’ which, I argue, is of great importance to propel mobile actors’ political engagement.

Aesthetics Beyond Normativity

Considering the continuous social and material processes through which both mobility infrastructure and practices get caught up in changing affective, corporeal and aesthetic relations and atmospheres helps to consider another political dimension of mobility infrastructure.

Let’s consider cycling infrastructure, for instance. According to the work of Dave Horton on green activists, “cycling is a conflictual practice of resistance to a predominantly and excessively motorized non-green culture” (2006, 52) as much as it demonstrates to others the viability of alternatives to the current society. Indeed, emerging cycling practices, objects and infrastructured spaces underlie a new social order, specific identities and new ways of living in an emerging citizenship (Aldred, 2010;

Horton, 2006). The latter sustains relations based on self-esteem, conviviality, ecology, liability (Van der Kloof, Bastiaanssen, and Martens, 2014; Bahrami and Rigal, 2017; Illich, 1973; Héran, 2014). The cycling citizenship also triggers specific pleasure and displeasure which have “moral” fruitage (Scott, 2020).

Pleasure remains one of the principal motivations across time and space for cycling (Rosen, Cox, and Horton, 2007). The æsthetical experience of cycling (pleasure, pre-reflexive experience of freedom) is now desirable. People now operate a transition to slow mobility because it offers individual, sportive, hedonistic and playful experience (Kaufmann et al., 2019). It articulates the hedonistic slow mobility favored in the context of cultural capitalism and the updated “poetic of speed” - first associated with modernist masculine automobilism (Mom, 2014; Flonneau, 2008) - to create new affective relation to motion and the urban environment. First, as the early and mid-20th century highways (Pelgrims, 2020a), cycling infrastructure renews the assimilation, on a pre-reflexive level, of individual mobility with personal freedom. This clearly appears in the 2017 Velo-city Conference theme on “the freedom of cycling.” This assimilation feeds the narrative of cycling infrastructure as an essential element for a sustainable future. Second, the movement’s “different qualities, temporalities, rhythms, materialities and affective resonances [...] cut across and resonate through [...] infrastructures, environments, vehicles and bodies.” (Merriman, 2016, 86) This resonance may be increased by qualitative, landscaped infrastructure design. The infrastructure can intensify and value the sensitive, liberating experience of the environment (Bendiks et al., 2013) and draw attention to its specific æsthetic dimension, to the diversity of the crossed species, the quality of the atmosphere and weather... It helps people to develop, as J.-P. Thibaud puts it, an “ambient sensibility” - as “a power of intensification and transformation of our relationship to the world” (2020) - that addresses the crisis of resonance diagnosed by H. Rosa. Mobility infrastructure, that way, helps the cyclist’s physical engagements (effortful motion) in the city. It turns progressively into both increasing environmental awareness (capacity to be affected by non-human) and sensitivity to ecological issues. Therefore, through the joyful attachment to the experienced world, it propels ‘ethical’ generosity to the others and to the environment and strengthen sustainable mobility.

References

- Aldred, Rachel. 2010. “‘On the Outside’: Constructing Cycling Citizenship.” *Social & Cultural Geography* 11, 1 (2010): 35-52.
- Augoyard, Jean-François. “L’environnement Sensible et Les Ambiances Architecturales.” *L’Espace Géographique* 24, 4 (1995): 302-18.
- Bahrami, Farzaneh, and Alexandre Rigal. “Spaces of Effort, Exploration of an Experience of Mobility.” *Applied Mobilities* 2, 1 (2017): 85-99.
- Bennett, Jane. *The Enchantment of Modern Life: Attachments, Crossings, and Ethics*. Princeton, N.J: Princeton University Press, 2001.
- Berdoulay, Vincent, Iná Castro, and Paulo C. Da Costa Gomès. “L’espace public entre mythe, imaginaire et culture.” *Cahiers de géographie du Québec* 45, 126 (2001): 413.
- Boltanski, Luc, and Laurent Thévenot. *De la justification: les économies de la grandeur*. Paris: Gallimard, 2008 [1991].
- Bonnet, Aurore. *Qualification des espaces publics urbains par les rythmes de marche : approche à travers la danse contemporaine*. Ph.D.thesis, Université de Grenoble, 2013.

- Castoriadis, Cornelius. *L'institution imaginaire de la société*. Paris : Seuil, 1975.
- Chelkoff, Grégoire, and Jean-Paul Thibaud. "L'espace public, modes sensibles : Le regard sur la ville." *Les Annales de la Recherche Urbaine* 57, 1 (1992): 7-16.
- Flonneau, Mathieu. *Les cultures du volant: essai sur les mondes de l'automobilisme : XXe-XXIe siècles*. Paris: Autrement, 2008.
- Gamba, Fiorenza. "Lire La Ville Quotidienne Entre Technique et Poétique." *Sociétés* 114 (April 2011): 119-27.
- Gibson, James. *The Ecological Approach To Visual Perception*. Boston: Houghton Mifflin, 1979.
- Héran, Frédéric. *Le retour de la bicyclette: une histoire des déplacements urbains en Europe, de 1817 à 2050*. Paris: La Découverte, 2014.
- Horton, Dave. "Environmentalism and the Bicycle." *Environmental Politics* 15, 1 (2006): 41-58.
- Illich, Ivan. *La Convivialité*. Paris: Points, 1973.
- Kloof, Angela van der, Jeroen Bastiaanssen, and Karel Martens. "Bicycle Lessons, Activity Participation and Empowerment." *Case Studies on Transport Policy* 2, 2 (2014): 89-95.
- Lefebvre, Henri. *Eléments de rythmanalyse: introduction à la connaissance des rythmes*. Paris: Syllepse, 1992.
- Merriman, Peter. "Mobility Infrastructures: Modern Visions, Affective Environments and the Problem of Car Parking." *Mobilities* 11, 1 (2016): 83-98.
- Mom, Gijs. *Atlantic Automobilmism: The Emergence and Persistence of the Car, 1895-1940*. New York: Berghahn, 2014.
- Pattaroni, Luca. "La Ville Plurielle : Quand Les Squatters Ébranlent l'ordre Urbain." In *Enjeux de La Sociologie Urbaine*, edited by Michel Bassand, Vincent Kaufmann, and D. Joye, 283-314. Lausanne: PPUR, 2007.
- Pelgrims, Claire. "Aménager la lenteur. La dimension imaginaire de la piétonnisation du centre-ville bruxellois." *Espaces et sociétés* 175, 4 (2018): 143-62.
- . "Ambiance of Slowness. Brussels Commercial Gallery of the Latter Half of the 20th Century." *SHS Web of Conferences* 64 (2019): 03001. <https://doi.org/10.1051/shsconf/20196403001>
- . "Fetishising the Brussels Roadscape." *Journal of Transport History* 41, 1 (2020a): 89-115.
- . "Tension between Fast and Slow Mobilities. Examining the Infrastructuring Processes in Brussels (1950-2019) through the Lens of Social Imaginaries." *Transfers* 9, 3 (2020b): 1-21 (to be published).
- . *Entre vitesse et lenteur. Imaginaires en tension dans l'évolution des infrastructures de mobilité*. Ph.D.thesis, Université libre de Bruxelles, 2020c.
- Pelgrims, Claire, and Armelle Hausser. "Les rythmes indisciplinés." *EspacesTemps.net [En ligne]* (May 2019). <https://doi.org/10.26151/espacestemp.net-7kvk-yr76>
- Ricoeur, Paul. *Time and Narrative, Volume 3*. Translated by Kathleen Blamey and David Pellauer. Chicago: University of Chicago Press, 1990.

Rosa, Hartmut. *Resonance: A Sociology of the Relationship to the World*. Medford, MA: Polity Press, 2019.

Sansot, Pierre. *Poétique de la ville*. Paris: Klincksieck, 1971.

Scott, Nicholas A. *Assembling Moral Mobilities: Cycling, Cities, and the Common Good*. Lincoln: University of Nebraska Press, 2020.

Sénécal, Gilles. "Aspects de l'imaginaire spatial : identité ou fin des territoires?" *Annales de Géographie* 101, 563 (1992): 28-42.

Sheller, Mimi. "Automotive Emotions: Feeling the Car." *Theory, Culture & Society* 21, 4-5 (2004): 221-42.

Sheller, Mimi, and John Urry. "The New Mobilities Paradigm." *Environment and Planning A: Economy and Space* 38, 2 (2006): 207-26.

Thibaud, Jean-Paul. "Mouvement et perception des ambiances souterraines." *Les Annales de la Recherche Urbaine* 71, 1 (1996): 145-52.

—. "The Backstage of Urban Ambiances: When Atmospheres Pervade Everyday Experience." *Emotion, Space and Society* 15 (May 2015): 39-46.

—. "The Hypothesis of Ambient Sensibility." Urban-related Sensoria Conference, June 11 2020.

Tonnelat, Stéphane. "Une infra-politique de la marche." In *Le génie de la marche : poétique, savoirs et politique des corps mobiles*, edited by Georges Amar, Mireille Apel-Muller, and Sabine Chardonnet-Darmaillacq, 120-31. Paris: Hermann, 2016.

Investigating the “Climate Subjectivation” in Urban Furnaces

Sensitive Experiences of Climate Change in French Cities and Reconsidered Ecological Commitment

Fabian LEVEQUE¹, Karl BERTHELOT²

Abstract. Since they concentrate a growing majority of the world population, cities largely contribute to climate change... as they suffer from it. The singular experience of living with climate change in cities is barely considered in urban environmental policies. They are usually in favour of expertise solutions. The survey *Living in the urban furnaces* investigates the sensitive experience of the inhabitants in five cities in the South of France. By using the term “climate subjectivation,” the authors seek to refer to the process describing how climate change, by affecting sensitive, ordinary life may induce reconsidered political and ecological relation to the inhabited milieu of life. Simultaneously, other ways of being ecologically committed emerge in this process.

Keywords. *Metropolises, Climate Change, Subjectivation, Ecological Commitment*

Introduction

As a response to climate change, metropolitan policies opt for technological, engineering, architectural solutions to accelerate the resilience of cities and the transition of sustainable lifestyles (Terrin and Marie, 2015). A series of article recently published in the *Guardian* emphasised the limits of such actions and the inequalities they often reinforce.

According to Faburel (2013), the dominance of expertise in urban environmental policies immediately disqualifies entire parts of the inhabited experience of the individual subject. Roux (2004) argued this experience helps to consider the mutual, affective relation we maintain with the territories and demonstrate that individual is inseparable of inhabited place. Yet, this way of considering otherwise the urban experience echoes the numerous works on aesthetic and sensitive experiences which deeper examine this mutual relation (Manola, 2012). Blanc (2012) has demonstrated other relational and sensitive conceptions of ecology are possible by exploring the notion of “milieu de vie” [living environment]. It helps to overcome the instrumental approaches of nature. Thibaud (2018) has recently highlighted the concept of ambiance to inform the conditions that make possible the multiple, sensitive experiences of the individuals with their urban *milieu de vie*. This concept helps to understand how the transformations of the world take shape in our ordinary, situated experiences. It mainly shows the strong attachments to the inhabited milieu, particularly when this latter is suddenly in peril. The recent works of the research centre Pacte has pointed out the sensitive experience informs differently contemporary climate crisis by giving rise to other situated knowledges (Durand, 2014).

1. Ph.D. student, Université Lumière Lyon 2 - UMR Triangle, France, f.leveque-carlet@univ-lyon2.fr

2. Ph.D. student, EHESS - Géographie-Cités, France, karl.berthelot@ehess.fr

The term of “climatic subjectivation” helped to encapsulate this process in the survey *Living in the urban furnaces*. The authors hypothesise climate change is now part of the ambiance of the sensitive experiences of urban environments. By unequally affecting the sensitive life of social groups (Theys, 2007), climate change is on the verge to act as a *medium for reflexivity*. The sociologist Martuccelli (2017, 86) has referred to the “ordinary implicative affectivity” to argue that individuals would be more and more affected, consciously, or not, by the upheavals occurring in the world. This affectivity would give rise to feelings of indignation, humiliation, or injustice. These transformations of the lived world would lead to a new ecological, social and political “concern” (Brunet, 2008). As a matter of fact, it would give rise to multiple and ordinary resistances (Dobré, 2002), differing from traditional militancy. Tarragoni (2016) argued such a process would pave the way to reconsidered political subjectivations: given that the ratio of power responsible for the destruction of the inhabited milieu, other political conceptions of individual would thus be at stake in these multiple resistances. The meaning of “climate subjectivation” will continue to be detailed in the body of the paper through the findings of the survey.

The survey took place in summer 2019 in two medium-sized cities (Narbonne, Nîmes) and metropolises (Marseilles, Montpellier, Toulouse) in the South of France. It questioned the affective and sensitive experiences to the milieu of life through (1) the perception of climate change in cities, (2) the political means to act and (3) the ecological commitments to re-examine. 130 semi-open interviews were conducted following a representative sample of the population in these cities. It was organized by the UMR Triangle on behalf of the non-governmental organization “Notre affaire à tous.”

A Widely Shared Impression of Inhabiting “Urban Furnaces”

When Climate Change Affects Urban Daily Life

Seventy percent of the respondents say to observe climate evolutions in the cities they live. The usual rhythm of season is said to be altered. Abrupt changes and sudden extreme heat waves are the noteworthy evolutions of climate change. They are often reported by referring to personal stories from childhood. Climate change is already experienced in everyday life with tangible effects in cities.

Heat waves are particularly extreme in (major) cities since they concentrate people, activities and buildings. About 56% of the respondents assert the increase of summer temperature has noticeably influenced on their lifestyles. They say slowing down their pace of daily life, by reducing their daily activities. They say to feel more tired for not being able to recover at night. In short, rhythms of life are adjusted to vital needs. In densifying metropolitan areas, the parks and green spaces become scarce. It is less easy to relax and avoid the bustle of cities in summer. Consequently, it would be more tough to experience heat waves episodes in cities. The air is said to be stifling. The lexical field of *asphyxia* and *suffocation* is pervading in habitants’ words, not only in major cities but also in the medium-sized cities of the survey:

“Here, it is hot, you take a risk on falling to the ground. It is an urban canyon. The wind isn’t blowing. These changes are unhealthy” (resident in Nîmes, Male, between 30 and 44 years old, unemployed).

Climate change has serious effects on bodies and health conditions. The increasing temperatures concentrate polluting particles in the air. Inhabitants assure they contracted asthma during heat waves since they moved in town. Others assert how

harsh urban life is during summer, including in medium-sized cities:

"I'm asthmatic too and climate change is wearing me out. I've been taking pills for two days, but I don't feel well. Sometimes, I've asthma attacks"
(resident of Saint-Jean Saint-Pierre district, Narbonne, between 30 and 44 years old, unemployed).

These feelings clearly depend on the age, social background and physiological conditions. They can also vary according to the residential trajectory of the inhabitants. The sunny and warm weather is evocative of the typical lifestyle of the South of France. The easy access to cooling areas, such as sea, rivers and inland regions, clearly help to moderate the impression of urban furnaces. But for how long?

Anxiety and Anger are the Underlying Effects of Climate Change

More than two third of the respondents assert they are emotionally affected by the effects of climate change. They fear the lack of water, the repeated droughts, and the rise of heat. They also say to be in anger to be unable to do something. A young resident of the Cabucelle district in Marseilles, desperately shares: "It moves me a lot, I'm sad, it makes me angry sometimes. When you tell yourself that there is nothing you can do, that it will be hard... Sometimes we say that we almost reach an impasse."

These feelings do not always address personal situations. They also feel compassion for the less advantaged person and climate migrants. They feel sorry for future generations' living conditions.

The Sensitive Experience of Climate Change Reveals a Reflexive Concern for the Urban Living Condition

An Unbearable Degradation of Inhabited Environments

According to inhabitants, these affects are related to the morphological characteristics of cities and their recent processes of densification of open spaces. Among the respondents, 76% assert having noticed changes in their living environments - 43% of them notice their surroundings densifying with new buildings erected on vacant lot. Densification is indirectly blamed for the degradation of urban living conditions. It also affects climate perceptions, more particularly during heat waves in the mineralised areas of disadvantaged areas. "It feels like being in a heat tank. The concrete reflects the heat" said a resident of La Bagatelle, a disadvantaged district in Toulouse.

Vacant lots are increasingly densified and green spaces are noticeably disappearing:

"Montpellier changes very, very quickly and build too much. All the open spaces are densified. I think we're going too fast and too far. A lot of people feel it right now" (resident of Ecusson district, Montpellier, Female, between 45 and 59 years old, craftsperson).

Even Nîmes and Narbonne are not spared from urban projects of artificialisation in their close fringes. A growing feeling of discontent is pervading about urban living environments. One third of the respondents argue they would move to inland regions of France if the degradation of their lived environments were persisting.

Climate Change Reinforces Socio-Ecological Injustices in Metropolitan Cities

The inhabitants criticize metropolitan attraction projects such as the innovation pole Cambaceres in Montpellier or the shopping centre project called Val Tolosa in Toulouse. Other projects are said to gentrify central districts of Marseilles. Inhabitants also point at policies promoting mass tourism instead of upgrading the inhabitants living conditions.

About 88% of the respondents acknowledge feeling injustice. These urban decisions refer to a hierarchy of political choices and, as a result, of public and territories concerned. Some people directly allude to spatial disparities about green spaces or public transportation that would be more concentrated in well-off districts. The unequal exposure to climate change effects is obvious for people living in highly mineralised districts. Furthermore, a dilapidated building stock and inhabitants experiencing difficulties are obstacles for the ecological conversion of lifestyles. Inhabitants obviously feel concerned about the urban degradation of places they live and say to feel powerless about it.

The Attachments for the Inhabited Milieu Urge on Alternative Ecological Commitments

A Critical Distancing From Political Institutions to Deal With Ecological Issues

Adopting eco-friendly practices were often stated as ecological commitments, such as recycling, changing eating habits, travelling differently and even changing career. Yet, this eco-citizenship discourse, which is repeatedly encouraged by the public authorities, is the subject of fierce criticism. A resident of Montpellier argues: "I try to do my best to adopt eco-friendly habits, but at the same time, it's an issue that I don't completely understand. I actually feel like we're overwhelmed by the problem."

About 36% of the respondents state not being involved in ecological issues. Changing individual practices is said to be pointless, compared to unwilling political actions and economic policies which would not envision any convincing alternative. Standards of eco-friendly behaviours also prevail working-class groups without considering their living conditions.

Furthermore, some inhabitants assert they distrust political institutions to deal with ecological issues. Ecology would be diverted from its social and political essence to promote 'green capitalism' projects. As a result, political organisations and methods of production and consumption are not called into question. This diversion reinforces a feeling of mistrust regarding political institutions. An inhabitant of Marseilles points at the passivity of the public authorities: "Politicians only take part to a movement that goes beyond them. They are totally powerless today. They are incapable of thinking differently about economy, about value creation, about the measure of wealth. It's discouraging..."

Desires to Reclaim the Milieu With Other Political Forms-of-Life

Most inhabitants of this survey confess to feel powerless confronted to the degradation of their lived environments by metropolitan policies. They also regret the absence of serious political commitments to slow the effects of climate change. These stands clearly testify a reflexive concern about the global ecological situation. This concern is undoubtedly related to tangible, sensitive experiences of this situation.

By taking a closer look, we witnessed desires to act and commit otherwise, outside of conventional political frameworks, which are said to be restrictive. Some collective

of inhabitants ecologically reclaim their milieu of life, by gardening, cleaning beaches or implementing solidarity initiatives. They take care of places and people they live with. Thus, mutual assistance and solidarity are values they want to share, rather than competition or predation.

In Marseilles, several residents rallied around to implement the “Conservatoire Marseillais de la Menthe” in the middle of the street. It is a self-organised project which encourages passers-by to take mint. There is no financial compensation, only the possibility of taking some leaves or even a cutting. This plant favours proliferation, donation or sharing values. Other inhabitants located in the northern districts of Marseilles have created a collective called “Hôtel du Nord.” They promote an alternative model to mass seaside tourism of the city, by encouraging people to share the sensitive experiences of working-class inhabitants of the district and counting on popular hospitality by a system of accommodation with locals.

These initiatives underpin a wind of change. One third of the respondents request more radical changes of our societies against dictated lifestyles, fossilised institutions and economic organisation. Some inhabitants are committed to deconsumption practices. Others say to limit themselves for instance by no longer travelling abroad. A young inhabitant of Nîmes concedes: “I would love to travel around the world, but I prefer to imagine it as beautiful and diverse as it is and give it a chance to recover.”

Conclusion

Ultimately, investigating the climate subjectivation helps to examine how climate change is already experienced in everyday life. By affecting the milieu de vie, our sensitive, ordinary experience is embedded in the world. Contrary to what is often widespread, climate change is far from being a depoliticised issue. The 130 inhabitants we met were deeply concerned about the degradation of the lived world and about the political and metropolitan responsibilities. By examining what ecology meant for them, we noted that most of them distanced themselves from institutional ways of (not) dealing with these issues. Reviving the relation with the milieu de vie would help to arouse other sensitive ways of considering ecology, enough to nourish new understandings of justice³. By taking care of places and people, whatever their living conditions are, it gives rise to the popular essence of what ecology mean. It is based on autonomous commitments, sobriety practises and solidarity relationships. They are a catalyst of empowerment for the inhabitants of these cities⁴.

Acknowledgement

The authors acknowledge Kimberley Jannot for her invaluable help in translating this article and Guillaume Faburel for his proofreading.

References

- Blanc, Nathalie. 2012. *Les nouvelles esthétiques urbaines*. Emergences. Armand Colin, 219.
- Brunet, Philippe. 2008. “De l’usage raisonné de la notion de “concernement” : mobilisations locales à propos de l’industrie nucléaire”. *Natures Sciences Societes* Vol. 16 (4) : 317-325.

3. Cf. Fabian Leveque’s Ph.D. thesis in progress.

4. Cf. Karl Berthelot’s Ph.D. thesis in progress.

Dobré, Michelle. 2002. *L'écologie au quotidien : Éléments pour une théorie sociologique de la résistance ordinaire*. L'Harmattan, 352.

Durand, Séverine. 2014. " Vivre avec la possibilité d'une inondation ? Ethnographie de l'habiter en milieu exposé et prisé. " Sciences de l'Homme et Société : Aix Marseille Université.

Faburel, Guillaume. 2013. " L'habitant et les savoirs de l'habiter comme impensés de la démocratie participative ". *Cahiers RAMAU*, no 6: 31-53.

Manola, Théa. "Conditions et apports du paysage multisensoriel pour une approche sensible de l'urbain" Thèse en urbanisme, aménagement et politiques urbaines, Lab'Urba et UMR CNRS LAVUE, Université Paris-Est et Territoires, 2012.

Martuccelli, Danilo. 2017. *La condition sociale moderne : l'avenir d'une inquiétude*. Paris, France : Gallimard, 763.

Roux, Michel. 2004. *Inventer un nouvel art d'habiter : le ré-enchantement de l'espace*. Paris : L'Harmattan, 208.

Tarragoni, Federico. 2018. *Sociologies de l'individu*. Paris, France : la Découverte, 127.

Terrin, Jean-Jacques, et Marie, Jean-Baptiste. 2015. *Villes et changement climatique : îlots de chaleur urbains*. La ville en train de se faire. Marseille, France : Parenthèses, 288.

Theys, Jacques. 2007. " Pourquoi les préoccupations sociales et environnementales s'ignorent-elles mutuellement ? Un essai d'interprétation à partir du thème des inégalités écologiques ". In *Environnement et inégalités sociales*. 23-35. Université de Bruxelles.

Thibaud, Jean-Paul. 2018. " Vers une écologie ambiante de l'urbain ". *Environnement Urbain / Urban Environment [online]* Volume 13 (février).
<http://journals.openedition.org/eue/2135>

12

SENSITIVE SPACES AND URBAN PRACTICES

13

SENSORY EXPERIENCE, ENVIRONMENTAL
EXPERIENCE, POLITICAL ENGAGEMENT

14

SOUND STAKES OF THE ATMOSPHERE

15

THE WAY OF AMBIANCES: SCIENTIFIC
PRACTICES, ARTISTIC PRACTICES

16

WHAT PLACE FOR AMBIANCE IN THE
URBAN RENATURING PROCESS?

Sound Stakes of the Atmosphere

Session 14 – Introduction

Grégoire CHELKOFF¹,
Théo MARCHAL²

For many years, sound has been a vector of analysis and prospective on the environment around us. Because of its dual capacity to summon different dimensions of the sensitive through both qualitative and quantitative perspectives, it allows this singular hybridization of disciplines and approaches. Sound can be used as a medium of analysis and “design” at all scales. It then provides a perspective on issues of various kinds, from the most obvious to the most confidential, and a specific granularity that contributes to its vast field of application.

Sound as a Fundamental Component

Considering sound as a fundamental dimension of the perception issues associated to ambiances and atmospheres also means thinking of it as a vector for questioning and making spaces and lifestyles of today and tomorrow. As a component and fundamental contribution to ambiances and atmospheres, we can affirm that sound is a main “vector” of these due to its invasive and almost unconscious dimension that inhabits the body and society in the everyday ambiances.

By unifying space³ and structuring time, it is both a sensitive and social dimension of everyday relationships and social life whether urban or domestic, and from architectural scale to territorial scale. Sound has spread both in space and time in the inhabited world, and the technologies of production / reproduction have made it a special way of raising awareness as well as a particular “marker”⁴ for investigating this theme. It is well admitted now that sounds contribute to forming our sense of space and places, but it is also essential to consider the temporal dimension that sound can mobilize in its very essence, since it exists only through time and at all scales of temporality. Looking at the publishing activity around sound in a broad variety of topics in the last few years, it seems necessary to constantly update the evolutions and perspectives in a field that has developed relatively well since the time when hearing was known as the great “forgotten” of our ordinary sensitive universe and of the built and inhabited places.

1. AAU Laboratory, CRESSON Team.

2. AAU Laboratory, CRESSON Team.

3. Erwin Strauss attributes this space homogenizing capacity to sound.

4. It should be remembered that Jean François Augoyard was one of the very first sociologists to invest this dimension of inhabiting it from a qualitative point of view.

This evolution has notably allowed sound to take its place as a “material” ; whether around the issues of manufacturing and creation or around the issues of discussion and mediation. Nevertheless, its place is still very minor and contemporary issues that pay attention to our environment in its broadest meaning are still struggling to mobilize it as a real vector of transformation and/or information.

Sound as an Interrogation Tool

By focusing on this leverage or instrumental quality of sound and listening, we are thus questioning the sensitive phenomenon for its very nature : the phonic qualities and textures of places, objects and time. We also investigate modalities of appearance and modes of production of those sounds asking how they are capable of modifying and generating regarding our relations with objects, things and situations, as well as their conception in the spaces and time of our everyday lives and habits. In this way, it is also as a vector of “unframing” in comparison or in relation to the dominant senses -such as sight- and major preoccupations - like today’s environmental issues - that the hearing can provide constructive and reframed elements. Taking sound as the a priori starting point for dealing with inhabited ambiances and atmospheres interferes with other issues and other sensitive dimensions. This does not therefore mean closing in on itself. Instead, it leads us to seize the questioning and creative power that sound can contain as a specific sensitive phenomenon, listening as an attitude of attention and phonic production as a particular mode of presence. Indeed, it is also this active, dynamic dimension that we must approach beyond the purely receptive aspects that are often assigned to the auditory dimension.

It is in this perspective that we wish to continue and privilege this particular way of entering the world of ambiances. It is then a tool for their knowledge and their transformability at all steps of realization or comprehension.

Pluridisciplinarity of Approaches, Transmission and Experiences, Alternatives and Resistance

Scientific and technical approaches, artistic, urban and architectural practices, philosophical thought and social sciences are all summoned here to construct these insights as well as to specify what sound and listening tell us but also what they make us do. Thus the question of what can be transmitted or shared through listening and auditory exploration - such as the creation of tools, forms of experimentation and study protocols - takes on meaning within a pedagogy of environments and ambiances guided by listening. This sharing and exchange could increase curiosity and attention towards a weakened environment and allow to renew the interest towards elements considered irrelevant or tiny, when they could play a significant role in our relationship with the world.

The question is all the more emerging in a time when various “crises” are increasingly urgent and serious in the contemporary world and affect its ambiances. The covid pandemic experienced this year has shown many consequences, particularly in terms of the sound experience during containment. The experience of a participative process through simultaneous sound recordings “4’33” from our windows and balconies” that we launched⁵ through the ambiance network in March and April 2020 has allowed us to gather original investigation material on this exceptional moment. The coordination of the action in different parts of the world is contributing to an international observatory while creating a database on living conditions.

5. The text of this call for recordings of 4’33” can be found at <https://lambiophil.hypotheses.org>.

Listening and phonic practices can make sound a leverage in bringing or inducing other perspectives of analysis, allowing us to question different situations in new ways, but also inviting us to propose new possibilities and new procedures or methods of research and creation. This project needs to be kept in motion and invites renewals and innovations of various kinds while participating in a certain resistance to the forces of a strictly utilitarian and resource-consuming thinking (space being one of them) as well as human relations.

How Does Our World Sound and How to Make Our World Sounds ?

With the advent of analog and then digital recording, the ability to collect and preserve sounds has indeed allowed the sedimentation of elements that make up an auditory memory. The appearance of numerous sound maps or collection sites attests to this. The sound dimension has become a vector of reading of the territory and built spaces or a simple testimony. For many of us, listening to a place and recording certain facets of it becomes a way of understanding them and revealing some sensitive, territorial and social specificities.

In a perspective of systematization, using research recordings, we created in 2008 the website *Cartophonies.fr*. It has become a compilation of approximately 1000 recordings made during research on cities by our team CRESSON at the Grenoble School of Architecture and now incorporating contributions from different people around the world. The website is not intended to be a sound map that simply exhibits raw recordings. Instead, the files are provided with metadata (documents, visuals, photographs, testimonials) detailing the recording at hand. The recordings are meant to be “noteworthy,” telling us something about the ways cities change. The site also includes precise information about the context in which the sounds were recorded, their built environments and the sound effects that characterise each fragment.

These aspects could be of interest to residents who are curious about their city and their world, but also to specialists who consider sound important in building the environments of the future. These fragmentary recordings are often short. They speak to ordinary history transcribed through tangible material means, fragments of experiences that disappear over time, traces of which are preserved here to highlight some of the circumstances in which they were created.

The future of sounds

This session seeks to present and discuss this particular thread by taking stock of advances and new perspectives:

- What does sound tell us about current and future developments in the world ?
- What perspectives emerge when listening is taken as a privileged and relevant posture for analysis as well as for the design of inhabited environments ?

In other words : what does sound make us do ? While “sound design” seems to be developing and becoming more professional, touching on everyday objects such as trade, commerce and communication, should we believe that this form of development is fully satisfactory ? Can we not hope for other perspectives opening up a finer aesthetic and involving both uses and a less alienated imagination ?

This question concerns all the dimensions of ambiances, and the world of sound does not escape it, it is on the contrary in the front line by its importance in the background of everyday life and by its driving power.

The purpose is, in particular, to question how different “listening” or “hearings” could

invite us to understand, to design and to produce atmospheres ; especially when they intersect with societal and environmental matters and are confronted with other sensitive modalities.

Contributions were expected to be about prospective postures, specific or various studies as well as fundamental and/or methodological questions. The field of action thus extends from experimentation to situation analysis, through the proposal of tools, methodologies or case studies, or artistic practices, all of which in their own way make us more aware of the way our world sounds and how to make it sound as a window on current sound practices and prospectives.

References

- A. Wilson (Ed.) (2019), *Sound Worlds from the body to the City*, Cambridge Scholars Publishing.
- Augoyard, J.-F., (1978) *Les pratiques d'habiter à travers les phénomènes sonores*, rapport de recherche cresson.
- Augoyard, J.-F & Torgue, H. (Eds.). (Ouvrage Collectif, 1995). *A l'écoute de l'environnement*, Editions Parenthèses.
- Casati, R., & Dokic, J. (1994). *La philosophie du son*. Editions J. Chambon.
- Chelkoff, G. (2003). *Prototypes sonores architecturaux—Articulation, limite et inclusion*. CRESSON.
- Holl, S. (2006). *Questions of perception. Phenomenology of architecture*. Tokyo : A USan Francisco : W. Stout.
- Kang, J., & Schulte-Fortkamp, B. (Eds.). (2016). *Soundscape and the built environment*. CRC Press.
- Lupton, E., & Lipps, A. (Ed.). (2018). *The senses: Design beyond vision (First edition)*. Princeton Architectural Press.
- Strauss E. (1930) Trad. Française : Les formes du spatial. Leur signification pour la motricité et la perception, in *Figures de la subjectivité*, Ed. du CNRS, Paris, 1992
- Thibaud, J.P. Listening to urban sounds. *Urbanistica*, Istituto nazionale di urbanistica, 2014, pp. 122-126. (hal-01560163)
- Torgue, H. (2012). *Le sonore, l'imaginaire et la ville*. l'Harmattan.
- Voegelin, S. (2019). *The political possibility of sound: Fragments of listening*. Bloomsbury Academic, Bloomsbury Publishing Inc.

Field Recording, Technology and Creative Listening

Abstract. While more and more used in music and sound art, field recording remains under theorised. This paper aims to study this practice in relation to the technology and to modes of listening. I argue that field recording cannot be thought without its technological tools: microphones, headphones, recorders and speakers. I discuss that this set of audio technologies acts as a way of ‘translating’ the environment by allowing for a detachment toward what is listened to. I also conceptualise listening as a creative stance. To support my claim, I deploy historical examples from the sound hunting movement alongside recent scholarly works that investigate the role of imagination and empathy in music extending this method to ambient sounds. Finally, I argue that field recording can be used as a method to engage creatively with the environment.

Jean-Baptiste MASSON¹

Keywords. *Field Recording, Listening, Sound Environment, Technology, Link*

Definition and a Very Brief History of Field Recording

Arguably originating in bird song recordings made by the young Ludwig Koch in 1889, field recordings were mainly used by ornithologists, ethnomusicologists and radio during the first half of the twentieth century. During the second part of the twentieth century, facilitated by battery-powered recorders, making recording became a hobby known in Western Europe under the name of ‘sound hunting’, with tape recording clubs, national and international contests and federations emerging to define the practice². Field recording was also used to showcase the performances of high-fidelity systems - with Emory Cook using his recordings of trains, the ocean and the Queen Mary’s horn to demonstrate the quality of his speakers and turntables³. During the 1970s field recording further developed, notably around recording of nature and everyday life, and involved people like Luc Ferrari, Irv Teibel and Syntonic Research Inc., the World Soundscape Project, Dan Gibson, among others⁴. From here, field recording started to develop as a distinct musical genre.

But what are we listening to in field recordings? And how are we listening to it?

1. University of York, White Rose College of the Arts and Humanities, United Kingdom, jm2441@york.ac.uk

2. For the development of a sound hobby in Britain, see Jean-Baptiste Masson, “Hunting Sounds: The Development of a Sound Recording Hobbyist Culture in Britain in the 1950s and 1960s,” *Unlikely, Journal of Creative Arts* 7, in press.

3. John M. Conly, “Brahms, Thunderheads and Cachalot Courtship,” *High Fidelity*, October 1954, 49-51, 128, 130, 132.

4. Luc Ferrari composed *Presque Rien n°1* between 1967 and 1970, Syntonic Research Inc. released the first volume of its *Environments* series in 1969, the World Soundscape Project was initiated that same year, Dan Gibson’s *Solitudes* series started in 1981.

Technology as a Translator

As a mediated contact with the world, field recording is only thinkable through microphones, recorders, amplifiers, cables, speakers, headphones, and now, most of the time, computer. Field recording present a form of technology mediated contact with a sonic ambiance, mediated modes of listening of the world. This opens several questions: on the technical side, *how* is it recorded and then listened to; and on the philosophical one, *what* is recorded and listened to.

One does not hear the same thing with naked ears as through a microphone and speakers or headphones. These last ones follow technical characteristics elaborated beforehand while the human ear evolve though time, both physiologically (as illustrated by the impact of ageing) and psychologically (that is, its dependencing on training, increase of resolution, discrimination and development of specific listening modes). The presence of the microphone or speaker as an interface creates and allows a detachment toward the sound source, which allows a renewed perception, something of which field recordists observe⁵. Audio technologies help to work one's ear by allowing specific focus and detachment from sound sources. They thus act as a translator to break into the listening habits that render the real "so boring" (Jullien, 2019, 66) - because one has stopped taking interest in it - to access the unheard of the mundane, unheard because of "the very fact that it continuously lies before my eyes and as such, is no longer perceive" (Jullien, 2019, 24). Both for the recordist and for the listener, microphone, headphones, speakers and records allow to become aware of what is silenced by our experience, to renew the perception of the sound environment, to finally find the beauty in the banal. The microphone is a tool that raises awareness of sound. Moreover, specific microphones can render audible sounds that are not accessible to the human ear (like accelerometers to detect vibrations or sounds in the ultrasonic range), and through the means of amplification, even the most discreet sounds become hearable. Audio technologies and field recording have participated, and still participate, in the establishment of a new listening habitus. Judith Becker coined this concept to say that "we listen in a particular way without thinking about, and without realizing that it even is a particular way of listening" (Becker, 2010, 130). Field recording is consequently a way in which people become aware of how they listen to the sound environment and of how to listen to the sound environment. Through practice, ordinary sounds are translated into objects worth listening to and recording. Coupled with the repeated listenings allowed by the record, audio technologies help to decontextualize what is heard, and help to achieve the 'reduced listening' called for by Pierre Schaeffer, when one focus on the sonic qualities of sound rather than on its cause or meaning⁶. In that sense, the translation operated by audio technologies is an education of the ear, the development of a peculiar mode of listening.

Creative Listening

Field recordists, both professional and amateur, developed new encultured techniques of listening to the sound environment, from a detachment brought by the microphone, to a detachment directly enacted by the listener. "[Sound hunting] was not just a matter of simply waving the microphone around willy-nilly. On the contrary, a fully trained sound scout will be a professional listener" (Harris, 1967, 13). That is to say, as a listener opened to the sound environment, they were able to distinguish

5. See the interviews in Cathy Lane and Angus Carlyle, *In the Field: The Art of Field Recording* (Axminster: Uniform Books, 2014).

6. Pierre Schaeffer, *Treatise on Musical Objects. An Essay Across Disciplines* (Oakland, CA: University of California Press, 2017 [1966]), 212-4.

specific qualities in the heard sounds - such as texture, rhythm, harmony, movement or timbre to name a few - qualities that lie beyond, or more probably below, their significations. This listener is also able to jump between contemplation of the details within a sound scene, to an appraisal of its global quality. By which even the mundane sounds and environments become interesting to listen to, blurring the limits between noise, sound and music.

The sounds of a train climbing through the countryside, for instance, can be likened to a symphony in three movements, played without a break: first, pianissimo, the birdsong and a distant whistle emphasise the silence out of which the train is heard approaching, perhaps with a brief and abrupt change of tempo when the wheels slip; the train comes closer at a steady and now slower tempo, reaches a crescendo as it passes by, then climbs away into the distance, now pianissimo again, with maybe a long, lonely whistle as a coda. Sounds such as these are surely as evocative as a musical composition and can be equally emotive (Handford, 1980, 9).

This “fully trained sound scout” has acquired the ability to establish an aesthetic relation with ambient sounds, to give them musical qualities, to listen to them as one listens to music. Such an experience was also described by Brian Eno, when he recorded random sounds around Hyde Park and Bayswater Road for some minutes, listened to them and tried to memorise them. “I found that you can learn it. Something that is as completely arbitrary and disconnected as that, with sufficient listenings, become highly connected. You can really imagine that this thing was constructed somehow” (Toop, 1995, 130). This highlights the role of the listener in the appreciation of the proposition offered by a field recording piece, and the role of one’s imagination. As put by Marcel Cobussen, “imagination is a necessary quality when listening” (Cobussen, 2019, 116). I want to extend this notion by proposing that the same requirement to deploy the imagination occurs when one listens to the sound environment. Despite Cobussen taking instrumental sounds as his point of departure, I claim that ambient sounds also stimulate the imagination, as the two above examples of Peter Handford and Brian Eno show. A narrative, in real time or reconstructed, can be drawn from the ambient sounds.

“As a creative act, listening is always already somehow attached to the imaginary. However, this *imagining-through-listening* is to a certain extent determined - and perhaps restricted - by the sonic input and, sometimes, by the sound sources” (Cobussen, 2019, 116). Or maybe it is the education that restricts the imagination that one is able to project within her listening? Those restrictions are largely cultural and dependent on what is accepted as noise, sound and music and on the level of interest that is projected into each of these categories. I have shown elsewhere how such an interest toward ambient sounds appeared among amateur recordists practicing field recording in Western Europe in the 1950s and 1960s⁷. Field recording works on the blurring of noise, sound and music, to make clear that their definitions are circumstantial. It is one’s curiosity and personal opinion at a particular moment that makes a sound noticeable and interesting to listen to. But this one is neutral. It is the position heralded by John Cage as early as 1937: “Wherever we are, what we hear is mostly noise. When we ignore it, it disturbs us. When we listen to it, we find it fascinating” (Cage, 1961, 3). Adapting the work of Eric Clarke on empathy and music, I want to

7. J.-B. Masson, “Hunting Sounds.”

suggest that ambient sound too act as medium for extended consciousness⁸. Curiosity and empathy allow a connection with what is listened to. Curiosity as the first step of focus, where one gives interest and creates a link, allowing then an empathic relation to emerge and to sustain that link by projecting one's personality or identifying oneself with the object of contemplation. Through the use of empathy, I want to stress the importance of the establishment of a link between the listener and something or someone external to him. This approach allows the highlighting of the agency of sound, and the inter-related agencies of sound and of the listener. I propose that it is through these inter-related agencies that listening is creative. This creative aspect happening on several levels: the creation of a link with something that is external to oneself, the creation of emotions and ideas through imagination, the creation of a narrative through time.

Field Recording as a Method

I want to propose that field recording is a discipline. A discipline that teaches a peculiar kind of listening, that is not only active, but creative: listening as an interior and silent act in relationship with the surroundings, sound recordings and sound activities as a way to engage positively with the world. Positively because to listen is to remain silent while being focus on an object of listening: to listen is to create a link and to sustain it, this link creating a relation with something or someone external to oneself with which one empathises. I argue that field recording offers ways to renew how we approach our environment and how we think of ourselves within it, that field recording offers ways to approach Steven Feld's questions: "What it means to be a listening agent, and what it means to be a listening subject?" (2013, 212). I have already show avenues to consider why listening is a creative stance and a relational posture with what is around. The relational quality of listening - and through it the field recording practice - is a connection with the Other. Field recording helps to become conscious about what we hear, and therefore to experience the environment more intensively. A curiosity toward sound is also a curiosity toward the world, and because of this relational quality, field recording can be a method to engage with what lies around, sound being a medium within which we are constantly immersed. The environment is a milieu in which we are constantly "ensounded" (Ingold, 2007, 12). The purpose of field recording, and what one can learn through it, is to make sense of this constant 'ensounding'. Thus, the adaptation of what Clarke writes about music to ambient sounds, to consider them as "both a *medium* for emphatic (or antagonistic) engagement [...], and an *environment* in which to explore and experiment with a range of more or less projected, fantasized, and genuinely discovered subject positions or social formations" (Clarke, 2019, 79)⁹. Such an approach opens up to the social and political influences of one's culture of listening, through the acceptance or denial of certain sounds and their emitters. Listening is a reflexive activity that equally informs on the what is listened to and on the listener. Also highlighted is the strong relation between listening, field recording and acoustic ecology, and how this particular musical genre can serve to a better awareness of what lies and lives around us.

Conclusion

Field recording offers rich avenues to renew our perception of the sound environment, through recordings, and through direct practice. Audio technologies, because they act

8. Eric Clarke, "Empathy and the Ecology of Musical Consciousness," in *Music and Consciousness 2*, ed. Ruth Herbert, David Clarke, Eric Clarke (Oxford: Oxford University Press, 2019), 71-92.

9. *Emphases in original text.*

as a translator of the sound environment, can facilitate this transformation, that can be sustained without it afterwards. I have developed the idea that listening is a creative stance and that ambient sounds can trigger imagination. Listening is a link with something external. As such, its reason is relational, and these relations can be emphasized or antagonized. A key component that I have introduced is curiosity, and this short article is the first step to propose an exploration of curiosity as an essential movement to positively react to our constant *ensounding*. A curiosity toward ambient sound is a curiosity toward the world. Listening cannot be separated from the other senses and, therefore, by analysing how field recording create new modes of listening, its study and practice can serve as an entry point for a rehabilitated contact with the world.

References

- Becker, Judith. "Exploring the Habitus of Listening. Anthropological Perspectives." In *Handbook of Music an Emotion: Theory, Research, Applications*, edited by Patrick N. Juslin and John Sloboda, 127-57. Oxford: Oxford University Press, 2010.
- Cage, John. *Silence: Lectures and Writing*. Middleton, CN: Wesleyan University Press, 1961.
- Clarke, Eric. "Empathy and the Ecology of Musical Consciousness." In *Music and Consciousness 2*, edited by Ruth Herbert, David Clarke, Eric Clarke, 71-92. Oxford: Oxford University Press, 2019.
- Cobussen, Marcel. "Listening And/As Imagination." In *The Oxford Handbook of Sound and Imagination*, vol.2, edited by Mark Grimshaw-Aagaard, Mads Walther-Hansen, Martin Knakkegaard, 115-30. New York: Oxford University Press, 2019.
- Conly, John M. "Brahms, Thunderheads and Cachalot Courtship." *High Fidelity*, October 1954, 49-51, 128, 130, 132.
- Feld, Steven, interviewed by Angus Carlyle. In *In the Field, the Art of Field-Recording*, edited by Cathy Lane and Angus Carlyle, 201-12. Axminster: Uniformbooks, 2013.
- Feld, Steven. "Acoustemology." In *Keywords in Sound*, edited by David Novak and Matt Sakakeeny, 12-21. Durham, NC: Duke University Press, 2015.
- Handford, Peter. *Sounds of Railways and Their Recordings*. Newton Abbot: David & Charles, 1980.
- Harris, Graham. "A Touch of Old Safari." *Amateur Tape Recording*, vol.9 n°1, August 1967, 12-13 & 23.
- Ingold, Tim. "Against Soundscape." In *Autumn Leaves: Sound and the Environment in Artistic Practice*, edited by Angus Carlyle, 10-3. Paris: Double Entendre, 2007.
- Jullien, François. *L'inouï*. Paris: Grasset, 2019.
- Lane, Cathy, and Carlyle, Angus. *In the Field, the Art of Field-Recording*. Axminster: Uniformbooks, 2013.
- Masson, Jean-Baptiste. "Hunting Sounds: The Development of a Sound Recording Hobbyist Culture in Britain in the 1950s and 1960s." *Unlikely, Journal of Creative Arts* 7 (2020), in press.
- Toop, David. *Ocean of Sound*. London: Serpent's Tail, 1995.

Second-Order Ambiances

Background Music Transforming Public Spaces

Heikki UIMONEN¹

Abstract. Background music is affected by social, legal, economic and technological factors. It is intended to be listened to inattentively and is predominantly selected by someone other than those who encounter it. The ACMESOCS (2019-2022) research project examines urban auditory cultures, particularly how they are articulated, experienced and reclaimed within the acoustic environments of different-sized cities, thus contributing to policy-makers' awareness of the aesthetic design of acoustic spaces and the defining of urban sonic identity. This paper presents the preliminary results of a case study carried out in selected enterprises located in an individual shopping mall. It concentrates on the preferences of the end-users of background music and on their possibilities for alternative individual acoustic design.

Keywords. Ubiquitous Music, Ambiances, Acoustic Design, Sonic Environment, Identity, Media

Introduction

When urbanites stroll through a mid-sized Nordic shopping mall, they encounter approximately one hundred shops with diverse ambiances composed of background music. Although characterised as “second-order economy” (Sterne, 2013), background music is affected not only by economic but also social, legal, technological and cultural factors. Also, this ubiquitous music is intended to be listened to inattentively and is predominantly selected by someone other than those who encounter it, which makes it a special sonic and musical phenomenon to be researched only by conventional analysis of place.

Sonic environments perceived and understood by individuals or societies are defined as soundscapes. The term, invented in the early 1970s, was recently given an ISO-standardised definition in Europe (COST 2016). The concept parallels the idea of ambiance, which also emphasises how people experience everyday sonic phenomena. Various public places have essentially acoustic dimensions: restaurants, markets, sports arenas and shopping malls consist of sounds, whether musical or environmental. These phenomena have interested sociologists, ethnomusicologists and urban planners in their research of mobile and sedentary music in various urban spaces and soundscapes in historical, contemporary, personal, architectural and commercial contexts (Sterne, 1997, DeNora, 2000, Bull, 2002 & 2013, Thibaud, 2003, Thompson, 2002, Blesser and Salter, 2006). Furthermore, the interest in music in everyday soundscapes is exemplified by *Auditory Culture Reader* (Bull and Back, 2000) and *Hearing Cultures* (Erlman, 2005), anthologies presenting academic viewpoints on the matter.

Technologies and their social uses construct people's relationship to their environments.

1. University of Eastern Finland, Philosophical Faculty - ACMESOCS, Finland, heikki.uimonen@uef.fi

When music technology and its economic applications affect our conceptions of the nature of music, it can be approached as an ontological question: how, when, where and under what circumstances does music exist, in other words, “what music is remains open to question at all times and in all places” (Bohman, 1999). The question can be expanded further by asking what meanings an identical piece of music can have while listened to in different situations and environments open to the general public.

Project ACMESOCS

ACMESOCS: Auditory Cultures, Mediated Sounds and Constructed Spaces (2020) is a research project examining urban auditory cultures, particularly how they are articulated, experienced and reclaimed within the acoustic environments of three different-sized cities. ACMESOCS is based on cultural and social meanings attached to musical sounds when experienced in indoor urban environments, with special attention to the concepts of place, music and the listener. Three parameters are co- and re-produced continuously in their transforming and triangular relationship.

Based on prior academic research and previous studies of soundscapes, music consumption and the social uses of music, ACMESOCS divides the empirical research into three strands: the historical development of the background music industry, the construction of the contemporary sonic environment and the use of individual meaning-making in the context of commercial environments. On a methodological level, the research uses social science methods including participatory observation and interviews combined with soundscape studies methods. The strands are as follows: *the Making of the Listener-Consumer* aiming to understand strategic thinking within the background/foreground music business that underwent several shifts in the latter half of the 20th century. The listener-consumer is the implied central figure in the strategies, generating useful conceptions of the music listener and the all-important patron, the consumer. The strand *Constructed Urban Soundscapes* researches ubiquitous music (Kassabian, 2013) in urban spaces, which are sonically constructed mostly by the private and public service terrestrial radio stations and the content of the online background music services. Digital music streaming companies are expanding their business strategies into background music industry, thus increasing the competition for, and transformation of, shared soundscapes. The strand *Experienced and Reclaimed Soundscapes* concentrates on people’s experiences, perceptions and actions due to ubiquitous music in diverse urban spaces. The spaces are sometimes reclaimed by grassroots-level personal and collective acoustic design enabled by visual and auditory media content.

Methodology and Data Collection

This paper concentrates on the strand *Constructed Urban Soundscapes* and presents a case study of mediated music in a shopping mall environment. Due to the COVID-19 pandemic of spring 2020, the entire research was reorganised and the documentation of the fieldwork sites postponed. As a result, the research data collected prior to the pandemic and its preliminary analysis will be presented.

The article sheds light on and presents preliminary results concerning preferences of background music end-users, background music selection processes and alternatives to individual acoustic design in diverse shops and diverse lines of business. This research pays specific attention to a qualitative inquiry of how end-users are or are not capable of changing their sonic environment if they desire to do so. This intriguing scholarly question in the context of controlling one’s working environment and its acoustic dimensions will be underlined in the research.

During the fieldwork, the data on the musical preferences of end-users while working and ways to have an impact on their daily music environment was collected. The fieldwork methodology was composed of questionnaires, music recognition and interviews with open-ended questions in *Koskikeskus* shopping mall in the city of Tampere, Finland on 17-19 February (online-questionnaire) and 2-4, 13, 18, 23-24 May 2020 (interviews and music recognition) by ACMESOCS project researchers. During the fieldwork, the background music disseminated in individual shops was documented and archived with the Shazam phone app and made available to Spotify (2020) for anyone who desires to get acquainted with it, thus following the principles of open availability of research data. At this point, the shopping mall's hallways' sonic environment composed of generative music (music generated on-site by a programme in accordance with given parameters), announcements and advertisements were excluded from the research due to their different nature compared to the individual and identifiable songs documented in the shops.

Data and Preliminary Results

A total of 66 premises were investigated, their lines of business ranging from offices and cleaning and security enterprises to cafés and restaurants, bookstores, sporting goods, fashion and accessories, beauty, health and well-being, decorating and gifts, entertainment, groceries, household goods and speciality shops.

According to end-users' comments, the music sources of the individual shops consisted of a terrestrial radio receiver (7), other platforms such as iPod (2), self-made playlists (10) and online-disseminated company-specific playlists (subcontracted, 30). A total of 7 premises were without music, and in 10 of the shops the end-users were not able - or perhaps willing - to divulge the source of their music. Most of the shops investigated were fashion and accessories shops (25) with music predominantly composed of self-made playlists and company-specific playlists.

According to end-users' responses, the multinational and domestic retail chains' music selection processes were predominantly centralised. Especially in clothing and accessory stores, the music design and music selection processes were subcontracted to international background music companies. The documented music of the individual shops consisted of a total of 45 songs, 40 of which were performed by popular Anglo-American music artists such as Adele, Lisa Stansfield, Supertramp, Danielle Knoll and Robert Gordon (Spotify 2020).

When asked to describe freely the background music of their shops, the end-users characterised it as "rock," "pop," "English," "light," "relaxed," "schlager," "youthful," "suitable for all age groups," "trendy," "neutral," "classic popular music," "hiphop," "house," "soul" and music that "suits the brand" (Acme 2020), which gives the impression that the shopping mall's everyday background music is quite diverse when evaluated as a whole. When asked, what do you think of your workplace's background music, it was described somewhat nonchalantly as "OK," "nice," "neutral," "I don't care," "background noise, I don't even hear it," "lounge music is good since it does not stick in your head" and "would be bored without it" (Acme 2020). At first glance, the answers seem to reflect the general idea of background music, that it should go unnoticed. However, it also turned out, that reacting to background music was not restricted to occasional comments, since it was also sung along and sometimes danced to. The functional aspects of background music were also raised by one interviewee stating that it covered the hallway's generative music. Characterising background music as "earworm songs" refers to a catchy tune, which tends to play recurrently in a person's memory whether they like or not.

In general, during the ordinary working day, the background music was commented sparsely in the shops apart from occasional remarks such as “oh, it’s the same song again.” The notable exception to this rule was Christmas-time. Videogame and entertainment software retailer GameStop’s female interviewee stated that, according to the shop personnel’s count, the song “Last Christmas” by Wham was heard eleven times during a 7½-hour work shift. In addition to that, shop’s male workers’ outspoken liking of “alternative music” and their inclinations to give somewhat “harsh” comments on music were mentioned (Acme 2020). Another clearly identity-related statement was heard from a male interviewee pointing out that “we’re playing music for the girls now,” and pondered if this was suitable background music for a male clothes store and “men don’t bother to listen to this kind of music.”

Almost half the end-users (30) said that they had no control over the selection of background music. A practice prominent in chain stores with centralised music selection was that, in order to have the song removed from the playlist, headquarters or the background music provider had to be contacted by email (Acme 2020). In some cases, the shop personnel did not necessarily like the background music, but were reluctant to take any action or could not be bothered to change the playlist. The unspoken rule was to keep the volume of unpopular music down although it was recognised that “the boss” had to pay for it anyway. Cultural aspects were also raised, and the amount of non-Finnish music played in comparison with Finnish-language releases was questioned.

Conclusions

Theoretically and methodologically, ACME SOCS draws from the premise that environmental and especially musical sounds are the result of human actions in different spaces. This is approached by understanding places of music from an ethnomusicological point of view as music cultures consisting of ideas, actions, institutions and material objects. By doing this, in the future the project aims to contribute to environmental planning and the administration of urban areas, the aesthetic design of acoustic spaces and defining urban sonic identity.

This case study in a shopping mall particularly focused on digitalisation, the centralised background music industry and media convergence transforming commercial premises sonically, and on how this transformation is experienced and represented by the end-users. The qualitative research method applied elucidated on the individual and collective meanings attached to centralised music selection and possible alternatives for individual acoustic design.

In terms of urban sonic identity, uniquely personal areas are hard to find in a shopping mall environment. However, functional issues of acoustic design were raised when background music was commented on as a way to cover the hallway music. It also turned out that the design of acoustic spaces and defining urban sonic identity are not merely physical but related to issues of personal musical taste, identity and meaning-making constructed in social encounters (see DeNora, 2000). These encounters were clearly represented when individual and collective music tastes were characterised by comments relating to “alternative music” or “girls’ music.”

Background music is part of the daily environment and existence and has an effect on the everyday existence of the end-user of music. Preliminary results showed that hand-picked playlists are one route to individual and personalized acoustic design and that removing a song from a playlist could be done by contacting the music-providing enterprise. For chain stores, this seems to make music selection more hierarchical,

slower and perhaps somewhat cumbersome compared to enterprises that allow local music selection. At the same time, a hypothesis can be formulated that chain store background music practices are at least to some extent identical, with only minor exceptions.

In future research, the concept of agency requires closer examination in the context of music selection. The acoustic design of the chain stores is first and foremost in the hands of the music provider, and the end-users are seldom responsible for their daily sonic environment. This requires further inquiries into music selection processes and overall acoustic design carried out by the background music companies, including their customers' preferences and how they are taken into account in both the material and the infrastructural framework.

Acknowledgements

This article is written as part of the ACMESOCS - Auditory Cultures, Mediated Sounds and Constructed Spaces project, which is financed by the Academy of Finland (15071).

References

- Acme. Acmesocs fieldwork carried out in *Koskikeskus* shopping mall in city of Tampere, Finland in 17-19 February and 2-4, 13,18, 23-24 May 2020 by author & Dr. Meri Kytö.
- "Acmesocs. Auditory Cultures, Mediated Sounds & Constructed Spaces." Accessed June 18, 2020. <https://www3.uef.fi/en/web/acmesocs/home>.
- Blessner, Barry & Salter, Linda-Ruth. *Spaces Speak, Are You Listening. Experiencing Aural Architecture*. Cambridge: MIT Press, 2006.
- Bohlman, Philip. V."Ontologies of Music." In *Rethinking Music*, edited by Nicholas Cook & Mark Everist, 17-34. Oxford & New York: Oxford University Press, 1999.
- Bull, Michael. "The Seduction of Sound in Consumer Culture. Investigating Walkman Desires." *Journal of Consumer Culture* (March 1, 2002): 81-101.
- Bull, Michael (ed.) *Sound Studies*. Routledge, 2013.
- Bull, Michael & Back, Les (eds.) *Auditory Culture Reader*. Oxford: Berg, 2003.
- "Cost. Soundscape of European Cities and Landscapes." Accessed June 18, 2020. <http://soundscape-cost.org/index.php/public-resource/publications/62-final-e-book-published>
- DeNora, Tia. *Music and Everyday Life*. Cambridge: Cambridge University Press, 2000.
- Erlmann, Veit (ed). *Hearing Cultures. Essays on Sound, Listening and Modernity*. New York: Berg, 2005.
- Kassabian, Anahid. *Ubiquitous Listening. Affect, Attention, and Distributed Subjectivity*. Berkeley and Los Angeles: University of California Press, 2013.
- "Spotify." Accessed June 18, 2020. <https://open.spotify.com/playlist/1aGeG1nxe3X-5CmMwEnteSo?si=sb8-bhEzQyWZGEVAsXbVrQ>
- Sterne Jonathan. "Sounds like the Mall of America. Programmed Music and the Architectonics of Commercial Space." *Ethnomusicology*. Vol. 41, nr.1 (Winter, 1997): 22-50.
- Sterne, Jonathan."The Non-aggressive Music Deterrent." In *Ubiquitous Musics: The*

Everyday Sounds That We Don't Always Notice, edited by Marta García Quiñones, Anahid Kassabian & Elena Boschi, 121-137. Ashgate: Farnham, 2013.

Thibaud, Jean-Paul. "The sonic composition of the city." In *Auditory Culture Reader*, edited by Michael Bull & Les Back, 329-341. Oxford: Berg, 2003.

Thompson, Emily. *The Soundscape of Modernity: Architectural Acoustics and the Culture of Listening in America, 1900 -1933*. Cambridge, MA: MIT Press, 2002.

The Kite Choir

Abstract. This paper reports on the development of an ongoing artistic project, the Kite Choir, as an aesthetic practice of attunement with the atmosphere. The Kite Choir is a practice that builds on traditions of singing kites. In these traditions, the sound-making device is carried aloft by the kite, giving voice to an assemblage brought to life by the wind. The Kite Choir instead extends the site of instrumentation along the entire kite line and reel, to promote a collaborative chain of agency between atmosphere and performer/pilot. The paper describes the unique sound instruments and score created for this project and their relation to time and place of performance, and concludes with a set of speculative questions on how this practice might develop in the future.

Firat ERDIM¹

Keywords. *Sound, Atmosphere, Attunement, Kites*

Introduction

The Kite Choir² is a practice that builds on traditions of singing kites, such as those in China, Japan, Bermuda, and Vietnam. In these traditions, the sound-making device is carried aloft by the kite, giving voice to an assemblage brought to life by the wind. The Kite Choir instead extends the site of instrumentation along the entire kite line and reel, to promote a collaborative chain of agency between atmosphere and performer/pilot. This is a practice for “cultivating an ability to discern the vitality of matter,” which Jane Bennett argues, in *Vibrant Matter: A Political Ecology of Things* (2010), is needed to draw us out of our “attachments to ideas that matter is inanimate and that real agency belongs only to humans or to God.” Bennett points to a need to “devise new procedures, technologies, and regimes of perception that enable us to consult nonhumans more closely, or to listen and respond more carefully to their outbreaks, objections, and propositions” (Bennett, 2010, 108). The Kite Choir is such a regime of perception, an aesthetic practice of attunement with the atmosphere.

One aspect of this practice is the making of the experimental instruments in anticipation of performance. Another is the building of skill in playing them, and the development of choreographies and scores that enable the use of this practice to engage the atmospheres of places and their weather. Electroacoustic composer Paula Matthusen has been a collaborator on the project, and has written a score that provides instructions based on varying aeolian, climatic, temporal, and psychological conditions.

1. Iowa State University - College of Design, USA, firat@iastate.edu

2. Image and video documentation of Kite Choir instruments and performances can be found at: <https://firaterdim.net/Kite-Choir>

The Instruments

The sound instruments of the Kite Choir are between two poles, neither allowing the human a sense of autonomous expression nor letting them off the hook with a passive ‘listening device.’ These instruments include *ribbon reels*, polyester ribbon kite-lines attached to contact mics and portable mini-amps, that make a sound similar to a giant, angry hornet; and *resonator reels* that work on the same principles as the tin-can telephone and sound like a kettle coming to a boil.

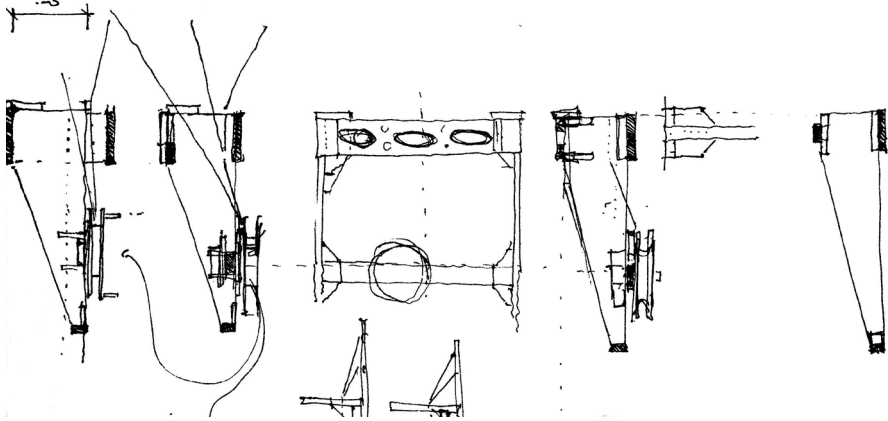

Figure 1. Sketches for an electric hurdy-gurdy reel. Firat Erdim, 2019

The Kite Choir instruments with the most complexity so far are the *hurdy-gurdy reels*. In this set of instruments, the kite’s tow line is nylon monofilament coated with rosin, which makes it slightly sticky. As it is reeled in and out, this tow line functions as a bow on a set of four to six musical strings, arranged low to high from reel to kite. The strings are played open - without fingering - in alternating pull and release across a single chord. The lowest string can be played alone, or one can incrementally contact more of the strings by varying the angle of the instrument in relation to the kite. As the bridges on most of these instruments have been flat, the lowest and highest strings usually have the most emphasis.



Figure 2. A series of acoustic hurdy-gurdy reels. Firat Erdim, 2018-19

Things get more interesting as the line extends further into the sky. As with an aeolian harp, the kite’s tow line and all of the strings on the instrument also vibrate in the wind independently of the bowing, due to vortex shedding. This sound is always the overtones of whatever each string is tuned to. The tow line of the kite, however, is changing in length and varying in tension as it is reeled in and out, so its vortex shedding sound can range from a soft cooing to a high, fiendish wail. As the tow line is vibrating

in this way, both from bowing and from vortex shedding, it acquires a thickness that can be used to engage the middle strings that otherwise don't sound out as much as the low and high ends. The sound that develops in each performance involves all of these factors, and others involving place and time, in an invariably improvisational entanglement.

The Score

Although these instruments are not made to play a piece of music in the conventional sense, at the start of the project in 2018, electroacoustic composer and musician Paula Matthusen wrote a score for them.



Figure 3. Paula Matthusen's score for the Kite Choir, printed as a set of playing cards. Design of the cards is by Kaitlin McCoy, 2018

The score, printed as a set of 'playing cards,' has four sets of variable instructions, contingent on aeolian, climatic (non-aeolian), temporal, and 'fuzzy' qualities. The aeolian category of instructions controls type of instrument and kite, and some flight instructions. For example, "high wind: single cell kite with hurdy-gurdy reel. Lean back into the wind, feel the kite as a buoy." The non-aeolian climatic category directs movement, such as: "fog: extremely slow, minimize all unnecessary actions," or "thunder/lightning: imagine movements but do not carry them out. Realize imagined

movements by vocalizing or breathing.” The temporal category determines triggers for playing and listening, such as “winter: pick two to three sonic cues from your body, and tie your actions to them,” or “night: look for lights moving in the sky, assign actions to planes, satellites, etc.” The fuzzy qualities category determines meditations, such as “pleasant: what does the air feel like on your skin? What surrounds you? How far can you transmit your skin, your breath, your thought?”

Matthusen wrote this score just as the first instruments were being made. Some of the flight instructions, triggers, and cues could use revision as the techniques and instruments have been further developed and refined since then. The instructions that are more meditative, playful, tie inside and outside, body and environment, and sharpen the practice as one of attunement have kept their relevance and continue to be incorporated. The instructions that forego kites and the instruments altogether - often because of inclement weather - have proven to be the most insightful because they question the boundaries between æsthetic practice and daily life.

Lessons of Place, Time, and Play

One way this practice impacts daily life is through its effects on time, or schedule. As just stated, the score does provide a number of instructions for inclement weather, even one in case of a tornado. One cannot choose the how of performance independently of the where and when. As a fisherman, farmer, or surfer would know, one is subject to the weather and must be on the lookout for the right conditions. The phrase, “weather permitting,” indicates a limitation but can also function as license, to break from chronological time into a kairological time, one based on the atmosphere.



Figure 4. Video still from Kite Choir Sounding: 9 June, 2019, Seyðisfjörður. Firat Erdim.

The practice of the Kite Choir transforms the perception of place as much as the qualities of place impact the sound of a performance. One learns to see the ground and its features - buildings, hills, trees, bodies of water - in terms of the wind. The place is the actual body of the instrument. Over the course of this practice so far, a light, smooth breeze in Venice, Italy, allowed the first overtones to emerge; in Seyðisfjörður,

Iceland, an attempted collaboration with an existing sound sculpture³ precipitated the possibilities of various tunings, and the joy of flying in fog; while in the textured, gusty winds of Iowa, USA, the static charge of approaching summer storms became audible.

The anthropologist Tim Ingold points out that while the atmosphere of meteorologists is devoid of affect and that of aestheticians lacks weather, sound “born of the fusion of the affective and the cosmic, where what is heard turns out to be our own hearing, also divides us such that - much as in a dream - we are simultaneously at home in our bodies and at large in the cosmos” (Ingold, 2015, 108).

At the start of the project, it was enough of a success to just to get the kite flying and have instruments sound out, as loudly as possible, even if they sounded frightfully awful. Even that took a lot of running around, many crashes, and it only seemed to work in the stiffest winds. After almost three years of doing ‘soundings’ in a handful of different places, below are a few insights that have emerged from that experience, and that parallel Ingold’s thoughts.

The kite should have just enough lift to fly, whether that is due to the lightest possible breeze or the use of very long tails. No running is necessary. The sound is not about action - of flying or falling or pulling or bowing - but about finding durations of suspension in the air. When the line is in a tensioned curve, reeling in and out becomes a breathing. Without the kite pulling up or the pilot pulling down, the two become momentary counterweights, appearing to be suspended from each other. The sound of that rare state of suspension is when nothing seems to be happening at all, even though all of the strings are vibrating together. The sense is not that of broadcasting sound out into an environment, but of diving into an atmosphere of sound.

Questions

As experiments in the instrumentation and choreographies of the Kite Choir continue, the primary question that is emerging is whether it could have a collective dimension as an aesthetic practice. Performing as an ensemble, what would it sound like to have multiple lines ‘sampling’ the air simultaneously? Might it be possible to map the flows and movements of the atmosphere in a field of sound? If the single line is a line of attunement between performer and kite and atmosphere, then what would happen as one performer starts also to align their actions with another, given the movements of the shared medium in which they are working? Or, does this collective dimension involve collaborations across a larger range of roles and agencies altogether, including but not limited to non-aeolian aspects of the weather, at a regional or even global scale?

References

Bennett, Jane. *Vibrant Matter: A Political Ecology of Things*. Durham: Duke University Press, 2010.

Ingold, Tim. *The Life of Lines*. New York: Routledge, 2015.

3. *Tvisongur*, made in 2012 by Lukas Kühne.

Ascolto il tuo cuore, città

Listening to My City at the Time of COVID-19

Giuseppe GAVAZZA¹

Abstract. During the COVID-19 lockdown, I suddenly decided to record the sounds of my apartment and my quarter, a lively community in the center of Turin: shops, outdoor markets, bars and restaurants in the day; cinemas, theaters, pubs in the night; the Valentino park, a big green area in the center of Turin on the Po river and the Porta Nuova train station. The soundwalks and the soundscapes I realized daily through the months of lockdown will continue as an online work in progress that allows for a sound exploration of this environment in this period and context. Many things have visibly changed: but is the change even audible? The same unpredictable changes imposed by the emergency have stimulated me to remodel the project that is proposed here in a renewed participatory approach.

Keywords. Soundwalk, Soundscape, COVID-19 Lockdown, Participatory Art Project

The Title

I have decided to borrow from Alberto Savinio the title *Ascolto il tuo cuore, città*² (1984) for this cycle of urban recordings in the COVID-19 confinement period.

Painter, composer, musicologist, writer, brother of the much better-known Giorgio De Chirico but not less genial than him, in this book, Savinio *flâneur* narrates his Milan. Published in 1944, the text presents itself as a testimony of Milan after the bombings of the Second World War: an anthology of reportages of walks around the city, chapters characterized by explanatory titles somewhat as intriguing and eccentric as their author was. Milan, like a phoenix, rose from the rubble of the city.

I have chosen this wonderful title for my *flânerie sonores* around my city, Turin, in the confined space of the San Salvario neighborhood, where I have lived for 30 years, in a period certainly not as tragic as a war, but still difficult and strange in the almost curfew imposed by the restrictions and lockdown due to the pandemic emergency. These reports were made by boosting my listening skills with my portable digital audio recorder in my pocket and binaural microphones in my ears.

On the web page³ of the French version, you can read a quote from the book: “In the ambition to make ‘an *oeuvre*’, there is still childishness. Once this childishness is

1. *Composer, Professor of Elementi di Composizione per Didattica della Musica and member of board of Dipartimento METS, Conservatorio Superiore di Musica G.F.Ghedini di Cuneo. Permanent Researcher AAU CRESSON, Grenoble. Composer in residence ACROE-ICA Grenoble, gavazza.g@grenoble.archi.fr*

2. “I listen to your heart, city.”

3. See at: <http://www.gallimard.fr/Catalogue/GALLIMARD/Le-sentiment-geographique/Ville-j-ecoute-ton-coeur> Accessed on June 21, 2020.

understood and overcome, you only write books if you still feel like writing, in the form of a long, quiet conversation⁴.”

In this spirit, I intended my soundwalks and my soundscapes as a long, quiet and intimate conversation with the spaces. Listening to the voices of the environment, adding the discreet voice of my footsteps, and my breath (atmos) in a rediscovery of the well-known, with an attitude, as well as possible, near to that of a forced newfound *naïveté* (naivety).

My Work

Since Tuesday, March 10th (the first day of confinement Phase I: *La flânerie aux temps du COVID-19: Soundwalk, Chapter I*) until Monday, June 15th (*Posting postcards, day 1 of phase 3, at the time of COVID-19: Soundwalk, Chapter CVIII*) first day of phase III, I have made at least one recordings per day of my soundwalks - around my quarter, in the legal radius of about 200 meters (the self-certification sheet in my pocket: it is an exit due to my work!) - and of my soundscapes taken from my terrace. 108 day-by-day recordings over 97 days.

Recording n°108 marks the end of my phase A and the beginning of my phase B, in which I interrupted the daily cadence of the recordings to start a different, slower pace marked by reinterpretations of previous chapters looking for similar situations (days, times, spaces, ambiances, occurrences, ...): this happens in the days I am writing this text.

Phase III means return to normal: I hope so, we warmly hope so. And from this newfound normality, I will continue to document recordings (soundwalks and soundscapes, explanatory titles, geotagged paths, related photos, short descriptive texts), hopefully useful to infer something of this strange time that was the confinement and the emergency.

On the page of each of my files on the Aporee website (see below about the full list) you can find links to GPS geotrack files in .kmz, .kml, .gpx formats: these files can be viewed with Google Earth or other programs and web pages. You can listen and follow the relative walks made to date to the links below. All these audios and geotrack files are available on my account www.aporee.org as part of my personal program “Ascolto il tuo cuore, città. I listen to your heart, city” itself part of the larger shared project “Soundscapes in the Pandemic/Corona”⁵ a large archive dedicated to sounds recorded worldwide in the COVID-19 pandemic emergency.

The sounds appear labeled on a terrestrial map. By following the links, you can open the map: clicking on the flashing red dot opens a drop-down window with information about the recording. In some cases, there are several sounds, loaded at different times, corresponding to the same recording point. In this case, by clicking on the blinking red dot and opening the drop-down window, you can read titles and information of different sounds and choose which of the list to listen to.

On a dedicated page of a personal blog, you can get the complete list of my finished phase A and in progress phase B recordings⁶.

4. “ Dans l’ambition de faire “une œuvre”, il y a encore de la puérilité. Une fois cette puérilité comprise et dépassée, on n’écrit de livres, si on a encore envie d’écrire, qu’en forme de longue et tranquille conversation. ” personal translation.

5. See at: <https://aporee.org/maps/work/projects.php?project=corona>

6. See at: <https://terpress.blogspot.com/2020/03/audio-testimonianze-al-tempo-del-covid19.html>

Technical Equipment

For the larger part of recordings, I used a Zoom H2n (in a few cases a Tascam DR-100MKIII); audio file format is stereo (rare four channels), wav 24 bits, 48 kHz, converted to stereo MP3 320 kbit/s for the Aporee website where I have downloaded sound files of about 30' at about 1-hour duration. I often made a selection of longer original recordings; obviously, I archived all the complete original files.

I made soundwalks mainly with binaural microphones Soundman OKM II classic; in very few cases I used binaural microphones Roland CS-10EM.

I made the soundscapes recordings with Zoom or Tascam internal microphones, from five positions on my terrace, placing the recorders on a stand at a height of about 230 cm.

Location

Quartiere San Salvario, Torino

Circoscrizione 8

Surface: 2,46 km²

Inhabitants: 38 110 ab.

Population density: 15 491,87 ab./km²

Coordinates: 45° 03'20"N 7° 40'47"E

Geo coordinates: 45,058022, 7,685715

<https://binged.it/39EFY5Q>

<https://her.is/3aGuLmE>

<https://goo.gl/maps/8Qj6FUZDow7Y71iQA>

The Soundwalks: the San Salvario District

San Salvario is a historic district of the Circoscrizione 8 of Turin, located south-east of the historic center. The district is also known for its widespread multi-ethnic population, present especially near the Porta Nuova train station.

It is one of the greenest central districts of Turin: in its part close to the left bank of the Po river, there is the Valentino Park, conceived as the summer residence park of the Savoy family (the royal family of the Kingdom of Italy from 1861 to 1947), now used as a public park, full of pedestrian paths, clubs and bars, it hosts the homonymous castle, from 1997 UNESCO World Heritage Site, today the headquarters of the Faculty of Architecture of the Polytechnic of Turin, and the picturesque Medieval Village. The western part is made up of narrow streets and old houses, close to Via Madama Cristina, Via Nizza and the railway section of Porta Nuova.

The district hosts a variety of cultural, craft, and tertiary activities in general. At the end of the 20th century, a lively nightlife developed. In addition to multi-ethnic venues, pubs, bistros, restaurants, and delicatessens of all kinds and ethnic groups, the neighborhood is home to two local outdoor markets. The Turin daily newspaper *La Stampa*, one of the largest nationwide, has its headquarters here. In addition to the cultural venues already mentioned, the district also houses the *Museum of criminal anthropology Cesare Lombroso* and the *Museum of human anatomy Luigi Rolando*, plus the *Fruit Museum Francesco Garnier Valletti*, the *Teatro Nuovo*, the *Cinetatro Baretti*, and the *Teatro Colosseo*.

In the nineties, the neighborhood saw the birth of dozens of multiethnic socio-cultural associations. In 2010, the agency opened its headquarters at the *Casa del Quartiere* as a recreational, cultural, and multiethnic headquarters.

Since 2013, San Salvario is the subject of redevelopment works for a new university campus, on the project Clinical Industrial Research Park in collaboration with the University Centre Department of Molecular Biotechnology.

The Soundscapes: My Terrace

The audio recording position is in the center of a large terrace located in the inner courtyard of the San Salvario district (45.05796, 7.68577). The terrace is facing south, on the first floor of a six-story building, surrounded by recent and older buildings from 4 to 10 floors high. The taller and newer buildings are located in the east, the older and lower buildings are to the south.

The west side is almost entirely occupied by the five-story building of *Collegio Universitario Renato Einaudi*, sede *Valentino* (built as *Casa dello Studente* in 1936 on a project by Ferruccio Grassi and Nello Renacco and enlarged after the war); to the north is the six-story building (1953) where I live.

The skyline decreases from east to west quite regularly: the sun on the terrace rises late but sets not as early.

The terrace is above the garages and around it are other garages or low-rise houses and small gardens or courtyards. This is why the terrace, although on the first floor, is not suffocated by the tall buildings surrounding it but several tens of meters away. Actually, the terrace looks like a square in the middle of houses with many balconies (*Case di ringhiera*) that are visited a lot in this period of confinement: adults, students, children, dogs; but it is not a square at all because it is mainly an enclosing, internal and private system and not a public passage nor a space with public access.

The terrace is L-shaped (the larger part to the south the smaller part to the west) and the north-west side approaches (about 30 meters distance) north to Via Bernardino Galliani, main entrance, and access to the underground garages of the building. Sounds of urban traffic come mainly from this side from a section of the one-way street with slow and not intense traffic, also because a few dozen meters away the street ends, with a stop, on Corso Massimo d'Azeglio, an avenue of great traffic.

The traffic sounds of Corso Massimo d'Azeglio, which is to the east, reach the terrace very muffled by the 10-story building. The buildings to the south and those to the west are something like 50 meters away and absorb a lot of sounds coming from two streets (Via Ormea and Via Berthollet) similar to Via Galliani: one way and not much car traffic, rather pedestrian transit.

My First Project

In my first proposition, thinking about the normal congress situation as planned, I wrote:

“The sound walks and soundscapes recorded so far are a work in progress already available on the web on sites that allow a geotag connection with Google Maps. This will allow an acoustic exploration in space and time of this environment in this period and in this context. [...] Since this is a work in progress that has just begun in an exceptional situation, it is difficult for me to give the details of the intervention. I would imagine that I will propose to you to listen to a reasoned selection of sound samples, suggesting personal interpretations and, above all, trying to provoke a dialogue involving the personal skills and experiences matured at that moment.”

Finale: a Sort of Composition

Given the new rescheduling of *Ambiance 2020 Congress*, I decided to work in a renewed action calling for your collaboration. As of August 16, 2020, there are 75 hours of audio in 125 recordings: 68 soundwalks and 57 soundscapes. The 108 daily recordings in 97 days of phase A (*A tempo rigoroso*) lockdown are followed by two months of phase B (*Rallentando*), in which I added 17 recordings; each is a *variation* of previous recordings.

The soundwalks begin and end in my apartment and are punctuated by recognizable and repeated thematic elements: the radio tuned on RAI-RadioTre, the opening and closing of my door, the building portal, the walk down the stairs to the exit in urban traffic. On the way back, as the *Final cadence*, the washing of the hands: necessary and almost ritual. When you listen, these sound elements present themselves as *Leitmotifs* or, better, as signature tunes for the start and the end of the episode. The radio acts as an index or chronometric witness: all these broadcasts are present in podcasts and allow to check dates and times. Apart from this investigative aspect (of little interest), at the first listening I found the re-listening emotionally remarkable, in particular of the news.

What characterizes this corpus of recordings is the spatial steadiness. The lockdown applied limitations of movement: in the soundwalks, I repeatedly retraced my steps within a small perimeter around my house and the soundscapes from the terrace offer close listening positions. What changes is time, a sonic time-lapse where I intend to search for a constant that I define as *formant*: a spectrum of invariant elements that could identify the voice of this area, through the contingency of extraordinary and ordinary events.

Listening takes a long time; at this phase the partial re-listening does not allow to suggest significant deductions. For this reason, I propose a collaborative project from which, I hope, will spring the details of a compositional creation that I imagine in two directions of intermittent rhythmic linearity (chapters or rooms):

- spatial: an installation in independent acoustic spaces: separate listening rooms⁷ or path with infrared headphones.
- temporal: a series of radio broadcasts that will re-trace the recordings after a period of time (one or more years?). As written above, all recordings are available on the Aporee page.

Everyone may go to the page, explore, read, listen with the aim of select one or more fragments of 4'33." Each fragment is a brick that represents your personal contribution. For each of these fragments I ask you, please, to send me:

- The link to the page;
- The original title of the audio file;
- In case of multiple files at the same URL its location in the file list;
- Your personal, intriguing and eccentric title chosen for the brick;
- The start and end time of the selected fragment;
- A brief listening description;
- The reason for your choice.

For example:

- Page: <https://aporee.org/maps/work/?loc=47786>
- Title: "La flânerie III après trois mois aux temps du COVID-19": Soundwalk
- File n. 3 of the list
- My title: My intriguing New Title
- Selected audio: from 03'10" to 07'43"
- This is what I listen in this fragment;
- This is why I choose this fragment.

⁷ In addition to the geo-track GPS, I documented each recording with pictures that allow to visually contextualize the setting.

My intent is to launch the process for a participative project. I shall use these fragments for:

- An in-person moment of collective brainstorming: workshop, open lesson, workgroup;
- A collaborative project on <https://www.cartophonies.fr>;
- An electroacoustic composition;
- A sound installation.

These chapters should be presented sometimes, somewhere, if possible, in the frame of the Ambiance Network activities.

Please send this material to my email address: gavazza.g@grenoble.archi.fr

Many thanks for your contribution!

Is to be sought a thought that ignores exclusion, so malleable as to receive, according to needs, practical initiatives, vital situations, abstract theories, our being in the world, desires, emotions, cultures...

The result is a sort of collage whose inlay assembles rather than analyzes ... builds more than criticizes. A sort of composition (Serres, Michel)⁸.

References

Savinio, Alberto. *Ascolto il tuo cuore, città*. Biblioteca Adelphi, 137. Milano 1984.

Savinio, Alberto. *Ville, j'écoute ton cœur*. Collection Le sentiment géographique. Gallimard, Paris, 2012. Accessed June 21, 2020. <http://www.gallimard.fr/Catalogue/GALLIMARD/Le-sentiment-geographique/Ville-j-ecoute-ton-coeur>

Serres, Michel, marcos y marcos, Riga n. 35, Milano 2019.

Aporee web shared project 'Soundscapes in the Pandemic/Corona'. Accessed June 21, 2020. <https://aporee.org/maps/work/projects.php?project=corona>

The page of my personal blog with full upgraded list of my recordings published on Aporee. Accessed June 21, 2020. <https://terpress.blogspot.com/2020/03/audio-testimonianze-al-tempo-del-covid19.html>

8. 'Sia da cercare un pensiero che ignora l'esclusione, tanto malleabile da accogliere, a seconda dei bisogni, iniziative pratiche, situazioni vitali, teorie astratte, il nostro essere-al-mondo, desideri, emozioni, culture... Ne risulta una sorta di collage il cui intarsio assembla più che analizzare costruisce più che criticare. Una sorta di composizione.' p.348. Personal translation

A Workshop on Sonic Ambiances at the School of Architecture of the University of Talca, Chile

Instrumental Condition of Space

Susana MORENO SORIANO¹,
Andrés MARAGAÑO LEVEQUE²,
Edgard TORRES TORRES³

Abstract. This teaching-and-learning event was held at the University of Talca which has a twenty-year-old educational programme in Chile's Central Valley. Today, this region is involved in a fast process of transformation, due to new economic activities that are having a strong impact on the way of life. However, a rich collective imaginary still persists. Throughout this workshop on the sonic dimension, the resources used were based on the soundscape approach, the paradigm of citizen science and the use of mobile phones. Other tools used were light beams and paper models to further develop the sensory experience. An assessment of the process added new data on how the learning process has been enriched.

Keywords. *Sonic Environment, Sensitive Learning, Pedagogy of Architecture*

Introduction

Atmosphere and Experience in the Architect Workshop

Architecture's capacity to move people is what interests architect Peter Zumthor most. The "Magic of the Real" reveals itself through atmosphere which is the joining of materials, phenomena of sound, light and temperature and other aspects such as material consonance, coherence, etc. (Zumthor, 2006). Danish architect, Eiler Rasmussen's *Experiencing Architecture* (Rasmussen, 1974) considers architecture a sensory art form that must be experienced.

"The perception of space is a complex intersensory phenomenon in which the visual, soundscapes, smell and climatic senses constitute fundamental channels that are mutually determining. Light, sound, climatic environments, aspects regarding movement, paths and synesthesia are elements that qualify the perception of space" (Palmese and Carles, 2018, 31). It is through perception that we access the world but in a partial way depending on the domain and quality of our sensory apparatus (Gálvez, 2019). Juhani Pallasmaa, in his essay *The Eyes of the Skin* further examines the interconnected role of the senses in architecture with particular emphasis on the sense of touch and the role of peripheral vision (Pallasmaa, 2010).

The Architecture Workshop is an ideal place to put some of these approaches into practice due to its unique status as a space for experimentation and creation in the teaching of this profession.

1. *Universidad Europea de Madrid, España, susana.moreno@universidadeuropea.es*

2. *Universidad de Talca, Chile, amaragaño@utalca.cl*

3. *Universidad de Talca, Chile, edgard.torres.t@gmail.com*

The School of Architecture of the University of Talca practices a very enriching and interesting pedagogy. With regards to the subject in hand, it is worth mentioning two workshops that are part of the first-year studies: the Material Workshop and the Body Workshop. Working with materials and later movement during the first year, allows students to become familiar with the complicated relationships that make up the discipline of architecture which through practice bring out subtle and profound connections. The students' hands on experiences with materials and space through work on the body in movement, immerse them in the implicit knowledge necessary for the project and create a very distinctive learning environment (Zúñiga, Gajardo and Ojeda, 2014).

Sonic Architecture - Sonic Urbanism

Originally, 'soundscape' was used to aesthetically describe acoustic settings and was restricted to natural and inherited environments (sonic memories). The fact that the instrument of the *soundscape* has not been adapted to the urban context leads to the need for a new conceptualisation to describe and intervene in this medium. The *Sonic Effects* proposed by Jean-Francois Augoyard add other dimensions to the soundscape and examine the perceptual and qualitative features of sonic ambiances (Augoyard and Torge, 2006). In subsequent evolutions, this study of sound is continuously evolving to include other new tools and perspectives aimed at improving their use in certain domains and with new practical objectives, i.e. teaching-and-learning in architecture schools.

Walking

According to the studies of the anthropologist Edward T. Hall (Hall, 1989) cited in (Gehl, 2010), sensory development can be broadly speaking classified into the 'close' senses: feeling and tasting; and the "distance" senses: seeing, hearing and smelling. Gehl believes that urban design should adapt to the speed of human movement and capacity of humans to perceive at these speeds.

Walking is essential for the recognition and appropriation of a place in the practice of architecture. It is also key in education. Walking has also been a fundamental practice in sonic exploration and its close counterpart, acoustic ecology. As a shared practice, this experience, and the way it is carried on is firmly established.

Permanence

In living spaces there is room for play, rest or reading as they are quintessentially, places for social interaction. For Gehl, in the context of urban planning, where the relationship between the senses is an important issue. This is based on the thresholds of perception of the 'distance senses' mentioned above. The information received depends on the lighting conditions on the subject and of the surrounding environment, for example with backlighting, and also on the visual sharpness of the viewer (Gehl, 2010). Depending on the situation, this distance can also be a reference for the intelligibility of speech in a normal open-air situation, once again with a wide combination of situations which may affect communication such as wind, background noise or the influence of surfaces which demarcate the space. These living spaces such as plazas are especially fragile in cities. The *Hush City* project which identifies quiet areas in urban spaces, is a research project which maps the position of quiet enclaves in cities worldwide and empowers people to identify and evaluate these locations. In this case, the tools used include descriptive methods, subjective and motivational effects on the users together with audio recordings, quantitative evaluations and images obtained on mobile phones. The questions are designed to explore the correlation

between the soundscape and issues such as emotional responses and social potential. (Radicchi, Henckel and Memmel, 2018)

Sound Identity

'Sound identity' is concerned with the sound material itself. This sound material allows those that live in it to identify with the location and feel a part of it. In some environments, the characteristic sound material is interrupted, accentuated or fractured. Characteristic sound objects can be heard and identified. The location of the sound material is immediately identifiable. These surroundings are characteristic in the rural environment, for example, where sound becomes inherited identity. In the current primarily urban context, these characteristic sounds tend to become standardised. another modality of identity emerges, characterised by continuity, soft transitions and detachment. Listening tends to be different, distracted. According to Ricardo Atienza, it is an everyday sonic identity (Atienza, 2008).

Sonic Creation in Architecture

The success of architectural design resides in the fusion between the known and the imaginary. According to Galvez "a perception that is both imaginary and real at the same time" could be a perception that is known and recreated over which an imaginary perception is superimposed" (with a sonic ambiance which overlaps a real environment, the inner ear imagines a future sonic scenario) (Gálvez, 2019).

Introducing a dynamic understanding of urban complexity, several authors propose in-situ artistic processes (Sand and Atienza, 2012). For other authors the *dramatic form* has a place as there is scope to connect architecture with theatre. Cities and buildings like theater have dramatic principles of representation. Residents walk, interact, play but also *perform* in urban life (Morales, 1984).

Presentation of the Case

Contextualisation: Human Settlements

The workshop took place in a series of eleven medium-sized towns in the area around the city of Talca which is one of the main cities in the region of Maule. It is situated within Central Valley, a geological depression in central Chile extending between the Cordillera of the Andes and the Pacific coast that offers great contrasts in orography, topography and natural environments. The aim of the course was for students to put forward proposals to provide these towns with high quality public spaces and with facilities for performance art. The project had to cater for both the recreational and living requirements of the inhabitants and their variety of everyday activities as well as provide a space to be able to occasionally accommodate performances by small theatre companies from a network of local artists.

The idea we had at the start of the workshop, was to propose a network of public spaces in the Maule region. We had the support of the Regional Maule Theatre. Students visited the theatre and received a great deal of information about what was required. The teachers were very interested in the students integrating the work of the whole group and for them to get a greater awareness of the territory.

Objectives

Above all, the main aim was for the sonic ambiance to play a central role in the recognition of a location, in the initial decision making and also in the creative process which would develop afterwards.

The specific objectives of the workshop were:

- To explore the possibilities generated by the sonic ambiance of the space and the architectural forms;
- To experiment with intersections between tactile-sonic-visual sensory fields integrated into a creative process;
- To incorporate the tools and skills relating to the sonic ambiance into the practice or creative process in the Project Workshop.

Structure of the Process

The process was divided into three stages. We are going to refer to the activities of most relevance to the subject of this article:

Exploration and analysis - weeks 1 and 2

Visits: Soundwalks and audiovisual ground recordings. Appearance of sonic and material textures of the place. The students must choose two locations with a relevant sound identity and a potential for living spaces.

The student is expected to listen and select two-minute fragments of sound to present in the workshop from the chosen locations.

Presentation of ideas: the group listens to and views the audiovisual recordings on the students laptops which are placed on the tables. The computers are arranged in the room according to the geographic location of the towns where they were recorded. Various reproduction and listening methods are trialled: successive, simultaneous, with the students in movement.

Activated space vs the architectural object - weeks 3-5

Building of models: this experience interconnects the manual work with the sound of paper creasing as it is being created. The work of Fátima Miranda, *perVERSIONES*⁴, is shown to the students.

Presentation of ideas: activating the space on the paper model using beams of light. The configuration of the empty space is explored assimilating sonic sources and lighting to create guidelines to understand space through the movement of small adjustable spotlights.

Project - weeks 5-10

The Project takes a new direction. The architectural object (vertical) is *per se* a *dramatic entity*, with the capacity to activate the empty space, available to be occupied and 'sounded' by the population.

The assignment on ground textures (horizontal) appears to have been intuitively internalised by the students. The material nature of the assignment observed seems to incorporate definite sonic qualities that are produced through contact and movement. The students are asked to make a final reflection on the existing sonic ambiance and its significance on the project. Students are asked to write a review of their chosen location and share their data of 12 locations with the *Hush City Community*⁵.

4. Miranda, Fátima. *perVERSIONES Après un rêve-Gabriel Fauré*, see: <https://youtu.be/f85vD301L6E>

5. See: <https://map.opensourcesoundscapes.org/view-area>

Final Presentation: Exhibition

The overall group assignment comes together. The students assemble an installation, creating an atmosphere in semi-darkness. The murmur of the recordings, that are once more arranged in the room according to the geographic location of the places where they were recorded, can be heard. This time the sounds come from the ground. Illuminated paper models emerge from the darkness in the centre of the room and the rest of the graphic documents and models hang around them. Sounds predominate and the visual is out of focus⁶.



Figure 1. Final exhibition, Students and teachers, 2019

Discussion and Conclusions

The *practice of listening* was particularly important in the first stages. It became a form of appraising the first point of contact with the place and also facilitated the collection of a valuable compilation of audiovisual recordings.

No previous preparation was necessary for an auditory immersion in a sonic ambiance. None of the twenty students that attended the workshop were left indifferent to these activities.

The type of recordings and the attention to the variations in the sonic ambiances over the different visits, helped to make sense of the social use of the space.

The job of selecting the fragments of audiovisual material was important as was repeating this task in various stages of the workshop. A more attentive review of the sonic material also provided a new perspective of the ground that acquired new prominence through video, connecting sight and touch.

The creative process was supported by the use of the *dramatic* as a resource and of

6. See: https://youtu.be/eC_NexUd9qE

other materials such as paper and light that were intertwined with each other, as with the other aspects of perception that were addressed in the workshop.

The main achievement of the workshop was the result of the integration of all the assignments. A significant level of synergy was achieved with an emphasis on the sonic information provided by the final installation piece.

References

- Atienza, R. *Identidad Sonora Urbana: tiempo, sonido y proyecto urbano*. 2008.
- Augoyard, J. F., & Torge, H. (Eds.). *Sonic Experience. A Guide to everyday Sounds*. Montreal: McGill-Queem's University Press. 2006.
- Gálvez, A. *Espacio somático. Cuerpos múltiples*. Madrid: Ediciones Asimétricas. 2019.
- Gehl, J. *Cities for people*. Washinton D.C.: Island Press. 2010.
- Hall, E. T. *El lenguaje silencioso*. Madrid: Alianza. 1989.
- Morales, J. R. *Arquitectónica. Sobre la idea y el sentido de la arquitectura*. Sanitago de Chile: Santiago Universitaria. 1984.
- Pallasmaa, J. *Los ojos de la piel. La arquitectura y los sentidos*. Barcelona: Gustavo Gili. 2010.
- Palmese, C., & Carles, J. L. Paisaje en movimiento, paisaje en escucha y otras temáticas del paisaje. In *Una Mirada al Paisaje. XII simposio sobre Patrimonio Inmaterial* (pp. 27-32). 2018.
- Radicchi, A., Henckel, D., & Memmel, M. Citizens as smart, active sensors for a quiet and just city. The case of the "open source soundscapes" approach to identify, assess and plan "everyday quiet areas" in cities. *Noise Mapping*(5). 2018.
DOI: <https://doi.org/10.1515/noise-2018-0001>
- Rasmussen, S. E. *La experiencia de la arquitectura*. Barcelona: Labor. 1974.
- Sand, M., & Atienza, R. Playing the space - Resonance, improvisation, variations of urban ambiances. *Ambiances in action / Ambiances en acte(s) International Congress on Ambiances*, (pp. 153-158). Montreal. 2012.
- Zúñiga, B., Gajardo, J., & Ojeda, M. *Cuerpo y Materia*. Talca: Spreaad Editores. 2014.
- Zumthor, P. *Atmospheres. Aarchitectural Environments. Surrounding Objects*. Basel: Birkhäuser. 2006.

Spatial Design Praxis Using the Sound Sketching Environment Tool “Esquis’Sons”

Petros FLAMPOURIS¹,
Théo MARCHAL²

Abstract. Open-air amphitheaters are one of the most characteristic manifestations of Ancient Greek architecture. From an architectural renovation perspective, the legal framework results in minimal re-constructions of archaeological sites emphasizing on minimum interventions and low footprint impact. Contrary to the established treaty, this document addresses the rehabilitation of the selected site based on the use of the sound sketch software Esquis’Sons (Marchal, 2015) that allows you to sketch and hear sound scenes generated from a 3D digital model. By making a study based on in-situ recordings and using them in the sound sketch tool, one virtually builds a sound environment “in the making.” Multiple sound scenarios are then tested and used as feedback for spatial decision making.

Keywords. *Sound Sketch, Esquis’Sons, Ambiance, Soundscape, In-Situ, Virtual, 3D Model*

Introduction

Since the formation of the first charters where conservation and restoration techniques were presented, the approaching ethos to similar archaeological and historical sites was mainly restoration of the ‘least interference’. Meanwhile, a vast amount of research has been carried out on the ancient theatre (CORDIS | European Commission, 2020, The Acoustics Of Ancient Theatres 2011) regarding the historic and revival aspects of the architectural and acoustical theatre heritage. The methodological approach of this research is to approach the site based on sound attributes and media, adopting the sketching tool Esquis’Sons in this treaty in order to try to express and predict the sound ambiance of the site before and after the rehabilitation. An attempt is made to apply Esquis’Sons in a semi-Urban environment with heavy historical character. This method will help emphasize and predict sound ambiances to control and produce spatial.

Theater’s Architectural Description and Environmental Context

The study was carried out in an Ancient Greek theatre of Ancient Dimitriada (294-292 BCE) at the city of Volos in the region of Thessaly, Greece. The largest part of the diazoma and kilon’s marbles are missing. From the scene and the proscenium structures, only a stone footprint exists. From the ruins, we make the assumption that the size of the theatre was 9 klimakes and 8 kerkides, and the orchestra was shaped like a horseshoe with a radius of 12.10m, built from rigid soil. The kilon is 18m height. A few pieces of the kerkides remain, made of marble and Limestone.

1. Architect, student of post-master in “Re-use buildings” program, University of Thessaly, Department of Architecture, Post master degree “re-use of buildings and complexes,” Greece, petrosflampouris@gmail.com

2. AAU-CRESSON, School of Architecture, Grenoble Alpes University, France, marchal.t@grenoble.archi.fr

In relation to the urban fabric the archaeological site is situated 4km from the city of Volos, next to a road with medium traffic which is busy during rush hours. The Greek theatre is related to the geography of the site, built on the natural slope of a hill. The general site is surrounded mainly by fields. There are construction sites around the area and no residential buildings (fig. 1a).

Sound Sketching for Design

Acoustic study (reverberation durations, speech intelligibility criteria) has been performed by in-situ measuring and by room acoustic software. The results show that the amphitheater might regain its properties if the structure is reconstructed with marble or stone (seats, stage, orchestra). Even though the theater is built on a small hill, the existing site does not offer the same potential: the acoustic space is open and it cannot be considered as an enclosed space “isolated” from “outside” sounds. Contrary, the theater is “filled” with sounds of the shows that create “sound effects” (mask, mixing, metamorphosis) (Augoyard et al., 2011)³ with the sounds of the environment (sounds of nature, bells from neighboring villages, animals, noise of vehicles)⁴. The sound environment, the articulations and effects lead us to use Esquis’Sons to sketch out modifications in order to propose an architectural intervention implying the addition of small spatial objects which will not effect in terms of reduction of traffic noise but which can significantly modify the ordinary “listening” of these.

Esquis’Sons App Principles

The Esquis’Sons application is a tool for space designers that allows us to simulate sound ambiances. It thus offers the possibility to mobilize sound as a design material during the sketching of spaces. It is an immersion tool that uses sound tracks to be listened to in relation to geometrical parameters extracted from a CAD software. The idea is to introduce “sound” into the spatial project by allowing the user to “bypass” the complexity of acoustic modeling. Thus it is able to account for the propagation of sounds and the effects resulting from the constructed shapes (distance, elevation, mask, etc.).

Positioning sound as a sketching tool means taking the gamble of considering sound as a material of the architectural project. The inclusion of sound in the formulation of spatial interrogations makes it possible to question the morphological, material and functional stakes of a spatial project, all of which are likely to affect the propagation and composition of sound in space and time. Esquis’Sons asks questions about the organization and distribution of activities and uses that produce a sound environment. It is a way of questioning the general orientations (density, functions, locations) of a project beyond its visual representations.

We decided which scale to test for each scene, chose the focus of scenes and the degree of the architectural intervention. Then, we integrated and tested the interventions with the tool: we declared the 3D environment in Grasshopper and constructed the sound scene in Esquis’Sons (distance of listening points from sources and spatial objects, source(s) distance from ground and spatial objects, amount of each source, reflection and shadows from spatial objects and background noise). Once the space-sound model is built, we adjust the parameters based on the sound feedback obtained

3. See definition of mask, metamorphosis, mixing sound effects in Augoyard, J.F. and Torgue H. (Eds), *Sonic Experience : a guide to everyday sounds*, p.67-71, pp71-77, p.78.

4. See at: <https://soundcloud.com/petros-flab/90sec-scape>

from Esquis’Sons: adjusting materials (absorbance and reverberation) and adjusting geometries. Finally, a degree of qualitative realism is sought in the sound-spatial scene by working on new elements by the appearance and disappearance of behavioral - sound phenomena by introducing signals and sound markers, rhythmologies, and sound effects and by relocation of sound sources and listening points, uses around the scene.

Assigning Spatial Environment

We created the landscape by undressing the contour lines and the road on the south of the site. The theater area was modeled based on the ruins studied during the site survey. All the geometry elements created in Rhinoceros have been assigned to the applications Esquis’Sons through grasshopper. Dedicated opacity and absorbance in Esquis’Sons were adjusted individually.

Assigning Sound Samples

Related to background sources, all simulations share the background sounds common in sample and position. Four sound sources, oriented on the site emulate the expected sound qualities of the area. We declare on NW and SW an urban sample, on NW a construction site sample, on SE a church bell, on N a leaf rustle, breeze, cicadas and birds sample was used and we introduce a sample of noise traffic on E. Relating to the localized sources depending the modeled scene there was a variation regarding the assigned sounds. A concoction of samples of rustle of leaves, birds, theatrical play, chat, café ambiance, footsteps, kids, cycle path ambiance and busking were used.

Scale and Scene Focus

The interventions were studied on two levels regarding the scale focus. The first, which we call the “Global” level, is the relation between the site and its surrounding environment. It focuses on background sounds, spatial volumes, distances of the projected sound and the surrounding uses of the suburbia. The second level can be related to the scale of “the body in movement” (Chelkoff, 2003) and concerns the relation between smaller geometries and the user perception and actions, reflecting on the ambiance relation within the architectural space and the individual user.

Scenarios, Sound Sketches and Spatial Form Generation

Seven different scenarios of spatial interventions were developed. Each intervention had its own spatial approach for fulfilling the site rehabilitation brief. As a proof of the case studies, one rehabilitation scheme is presented and assessed below. At the following presented scenario 6⁵ (fig. 1b) the introduced spatial objects were: entrance, theater, kylon, stage, sound barrier, museum, workshop, audiovisual pavilions, café, small theater, Pop-up pavilions, cycling path and supporting uses structures.

5. Scenario 6 was selected due to the interesting sound results emerged from the sound sketches. The interventions adopted in this scheme were more profound interventions, such as, leisure uses, parking slots, supporting theaters and bike routes, and supporting structures, but also treatment-related such as the sound barrier and side wall reflectors for the theater area;

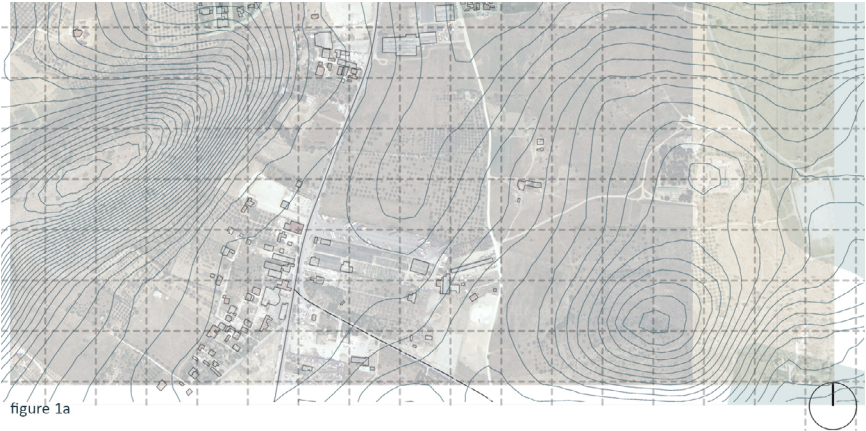

figure 1a

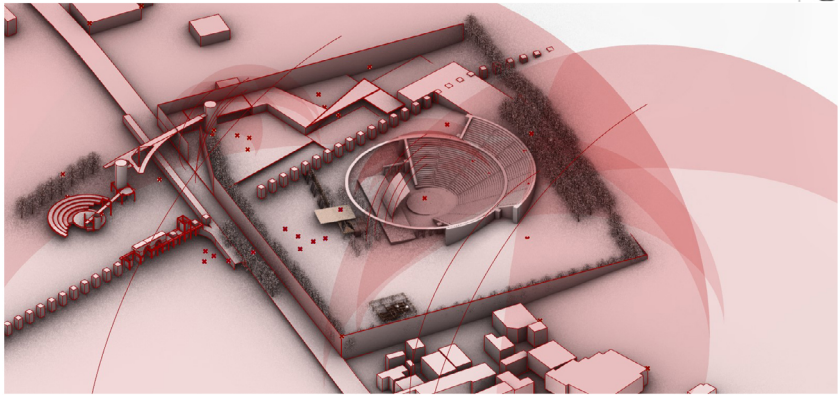

figure 1b

Figure 1. a) The theatre is related to the geography of the site, built on the natural slope of a hill. The general site is surrounded mainly by fields. There are construction sites around the area and no residential buildings. b) One of the selected interventional scheme, approached in a global and individual scale. Includes background and localized sound and can be studied in both level at the same time. The sketch includes 10 sound scenes on individual scale.

Evaluation Criteria of the Sound

Esquis'Sons is creating live and virtual a sound environment based on the spatial models edited with the 3D software (Rhinceros). It's built on sound loop mixing system that takes into account the position of the sources, the position of the listeners and the dimension and materiality of the built space in between. It helped by assigning different positions as listening points to hear 'live' the same sound scene from 2 different positions chosen by the designer in order to check, by sound, the results of its design. The comparison between the 2 sound tracks of the same sound scene is qualitative because it is based on comparative listening. The interventions evaluated below are validated using the following criteria for their produced qualities:

- **Clarity of sources:** capacities of the sound tracks to understand the sounds their source and their meanings;
- **Distance in between sources:** capacities of the sound track to reveal relative positions of the sources heard;
- **Materiality of space:** capacities of the sound track to reveal materiality of the space;

- **Narrativity of the sound track, sound effects:** potential to produce sound effects;
- **Ambiances (back plan/indices):** sound game in between sound that feeds the back plan and sounds witnesses of emerging events(ambiance description as a whole).

Evaluation of Scenario 6

Scene 1, Entrance

Audio

Clarity: A Large site, exposed to multiple sound incidents, bad clarity on foreground sounds

Distance: Multiple sound indices, a mixture of source distance on foreground and background

Materiality: road asphalt, soil, paving, trees, built structures

Narrativity: An open space, for public uses, of a warm dry environment

Ambiances: Background: Open space exposed to traffic with natural components.

Indices: People’s chatter, kids playing implying a space of public use

Effect: Mixing Effect, Masking effect, Reverberation

Scene 2, Theater

Audio

Clarity: A Large site, exposed to multiple sound incidents, lack of clarity

Distance: Multiple sound indices, a mixture of source distance on foreground and background.

Materiality: soil, paving, trees, stone

Narrativity: warm summer weather

Ambiances: Background: Open space exposed to traffic with natural components.

Indices: People’s chatter, kids playing implying a space of public use

Effect: Mixing Effect, Masking effect, Emergence effect, Reverberation

Scene 3, Sound Barrier

Audio

Clarity: multiple sound incidents, bad clarity on foreground and background sounds

Distance: Multiple sound indices, a mixture of source distance on foreground and background

Materiality: soil, paving, trees, building structures

Narrativity: warm weather, social, leisure

Ambiances: Background: Open space with natural components and people chatter.

Indices: kids playing, bell, traffic

Effect: Mixing Effect, Masking effect, Emergence effect, Reverberation

Scene 4, Theater/Bridge area

Audio

Clarity: multiple sound incidents, good clarity on the foreground and bad on the background sounds

Distance: Multiple sound indices, a mixture of source distance on foreground and background

Materiality: road asphalt, soil, paving, trees,

Narrativity: An open space, for public uses, of a warm dry environment, relaxation, coziness

Ambiances: Background: Open space exposed to traffic with natural components.

Indices: People’s chatter, music

Effect: Mixing Effect, Masking effect, Emergence effect, Reverberation

Discussion

The exploratory and iterative dimension of the tool has allowed us to make an interactive study to test design hypotheses. Our choice to focus on two main scales gave us the advantage of predicting different sound idiosyncrasies. By working on a global scale that included several scenes, we were able to show that one can influence the other on a larger scale. Our work also shows that different spatial typologies can be developed and studied through sound feedback by adding and removing, directly

mixing and modifying the modeled scene.

In every sketch:

- Geometries were investigated by altering their width, height, length positions and orientation.
- Characteristics were investigated by altering the absorbance coefficient of the environment and the opacity.
- Sources were investigated with their position, volume, size, amount and with a random factor integrated inside the Esquis’Sons tool.
- Listening points were investigated with their positions, directions and height.
- Loops were investigated with their context, length, neutrality, sound mark information.
- We also used the visualization components from Esquis’Sons in order to understand the diffusion and the propagation of sound.

The manipulation of components and the direct sound feedback provided a layer of sound, constituting spatial composition multifactorial, reinforcing the decision making and the appropriation of the introduced geometries by testing them through the listening positions and the modeled spaces.

Although we tested treatment-related interventions, it is interesting to note that we focused on the sounds of social interaction and not only at the quantitative aspects of acoustics. We may not be able to prejudge the ambiance of the space because of its multifunctionality, the unexpected cues that occur there and the complex arrangements that weave its constitution (Thibaud, 2018). However, it is possible to envisage a project composed of spatial schemes whose expected uses include some of its expected ambiances and qualities.

References

Augoyard, Jean François, Henry Skoff Torgue, Andra McCartney, and David Paquette. *Sonic Experience*. Quebec: McGill-Queen’s University Press, 2011.

Grégoire Chelkoff, Philippe Liveneau, Jean-Luc Bardyn, Rachel Thomas, Nicolas Rémy. *Prototypes sonores architecturaux : méthodologie pour un catalogue raisonné et des expérimentations constructives*. [Rapport de recherche] 60, CRESSON. 2003, pp.187. (hal-01364549f)

“CORDIS | European Commission.” Accessed May 15 2020.
<https://cordis.europa.eu/project/id/ICA3-CT-2002-10031>

Flampouris, Petros. “*Rehabilitation of ancient Dimitriada amphitheater*,” Department of Architecture, MArch reuse of buildings and complexes, Volos, 2020 (to be defended)

Marchal, Théo. “*Esquis’Sons ! : Outil d’esquisse de l’environnement sonore : software*” 2015, <http://www.esquissons.fr/outils/presentation-desquissons.html> (hal-01274975)

“The Acoustics Of Ancient Theatres 2011.” Accessed May 12, 2020. 2020.
<http://www.ancientacoustics2011.upatras.gr/extra.html>

Thibaud, J.-P. “Vers une écologie ambiante de l’urbain.” *Environnement Urbain / Urban Environment* (Volume 13)(April 19, 2019)
<http://journals.openedition.org/eue/2135>

13

SENSORY EXPERIENCE, ENVIRONMENTAL
EXPERIENCE, POLITICAL ENGAGEMENT

14

SOUND STAKES OF THE ATMOSPHERE

15

THE WAY OF AMBIANCES: SCIENTIFIC
PRACTICES, ARTISTIC PRACTICES

16

WHAT PLACE FOR AMBIANCE IN THE
URBAN RENATURING PROCESS?

The Way of Ambiances: Scientific Practices, Artistic Practices

Session 15 – Introduction

Didier TALLAGRANT¹,
Nicolas TIXIER²

Design practices and research practices on ambiances inform one another in order to grasp and understand a situation and to plan for the future. Two mutual concerns of this use of ambiances are outlined both in the research field and in the broadened practices of art and design:

- The specificity of each situation, the focus on what exists, its capture, its formatting and its delivery into the public space call for the hybridisation of knowledge and practices between research on ambiances and art and design production through renewed forms and formats implemented by each individual. This perpetually renewed use of the concept of ambiance thus involves a pragmatic dimension through field work.
- Actions both in art, design and research work in a joint way about the sensitive. To this end, they make use of the open field of ecology (perception ecology, attention ecology, social ecology, environmental ecology, etc.) for scientific production and for the development of situations and/or of artistic forms. The question of urban and territorial conditions implies a commitment to a theoretical and critical dimension.

Sensitive ambiances and atmospheres can be used very differently, whether it is in the field of the arts, the urban or social sciences. How can ambiances contribute to test ordinary situations against the sensitive? How do they open up new ways in terms of artistic practice, methodological experiments or theoretical exploration? What about a situated socio-aesthetics focusing on percepts and affects that would permeate our living environments and infuse the contemporary sensitivities?

This session, open to researchers, designers and artists, aims to discuss these questions and the forms and experiences that allow to report on them.

References

Derek McCormack, *Atmospheric Things: On the Allure of Elemental Envelopment*, Duke University Press, 2018.

Tim Ingold, *Making, Anthropology, archaeology, art and architecture*, Routledge, 2013.

Didier Tallagrand, Jean-Paul Thibaud, Nicolas Tixier (dir.), *L'usage des ambiances. Une épreuve sensible des situations*, Éd. Hermann, Paris, collection Colloque de Cerisy, 2020 (forthcoming).

Jean-Paul Thibaud, *En quête d'ambiances. Éprouver la ville en passant*, Genève, MétisPresses, 2015.

1. ESAAA - Superior School of Arts of Annecy Agglomeration.

2. AAU Laboratory, Cresson, France.

Making the Most of Parisian Quarries' Air

Experimental Climatic Furniture Using Parisian Quarries' Air to Cool Public Spaces

Guillaume DURANEL¹,
Frédéric BLAISE²

Abstract. As many large cities are confronted with global warming, Paris is looking for ways to be more resilient when facing urban heat island. The article describes a design experimentation aiming at tapping into naturally fresh air resources located in underground quarries underneath the streets of Paris. Working as urban sized earth-to-air-heat-exchangers, underground galleries will fuel a climatic bench that will cool down public spaces in summer.

Keywords. Urban Heat Island, Paris, Underground Quarry, Urban Furniture, Public Space

Short Term Actions for More Livable Public Spaces During Heat Waves

After the deadly heat wave of 2003 that caused 15,000 excess deaths in France³, protecting citizens from extreme climatic phenomena became a health matter that had led to implementing a “heat wave emergency plan” on a national scale. On a local level, cities are looking for ways to become more resilient when facing more intense and longer heat waves in summer. In this regard, the historical, highly mineral urban fabric of Paris makes the city more prone to suffer from urban heat island that causes denser neighborhoods to be up to 4°C hotter than less dense parts of the city⁴, thus worsening living conditions when such events occur. While long term solutions at the urban level are being implemented by Paris officials to reduce urban heat island, short term actions are also needed to address the yearly recurring phenomenon of hotter summers. In attempting such things, looking for naturally renewable sources of freshness within the denser parts of the city becomes necessary.

Under most of Paris's left bank lies a large network of underground quarries. At a depth of between 15 and 25m underground, the intricate galleries add up to over 225km in length. In this underground environment, temperatures remain around 14°C

1. LAVUE-LET, ENSA Paris La Villette, ALT, France, g.duranel@alt-au.com

2. ALT, France, f.blaise@alt-au.com

3. Official number given by the French authorities, “Canicules : effets sur la mortalité en France métropolitaine de 1970 à 2013, et focus sur les étés 2006 et 2015.” Accessed 20 June 2020.

<https://www.santepubliquefrance.fr>

4. According to studies lead by Parisian authorities and compiled in Agence Parisienne du Climat. L'îlot de chaleur urbain à Paris, un micro climat au cœur de la ville. Agence Parisienne du Climat, Météo France, Paris: Agence Parisienne du Climat, 2018.

all year and constitute a large reservoir of unused fresh air. Parisian underground quarries are usually seen as a hazard because they weaken building grounds. A special quarries inspection bureau (Inspection Générale des Carrières, or IGC) manages the risk they pose. Looking at them as a potential resource of freshness therefore constitutes a way to benefit from a historically significant feature to address a contemporary issue, but also contributes to making Parisians more conscious of what lies beneath Paris' streets.

The Effects of Climatic Furniture on the Surrounding Atmosphere

Conscious of this untapped resource, the Paris based architecture design studio ALT and designers Emma Lelong and Remi Nguyen proposed a climatic furniture to cool down Parisian public spaces. The design won a call for projects launched by the city of Paris and the Pavillon de l'Arsenal⁵. The proposal attracted the attention of Clime-space⁶ that offered its technical support by funding a study by Elioth⁷.

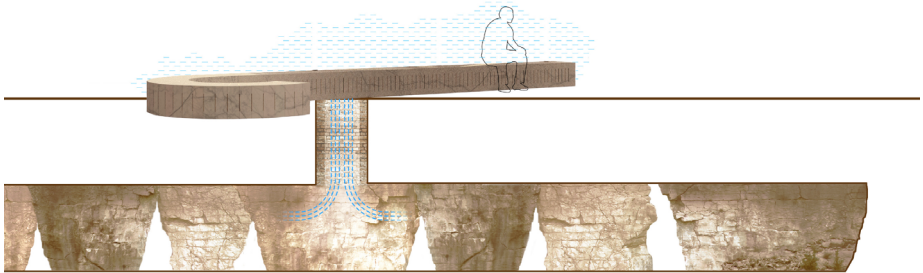

Figure 1. Cross section of the proposed climatic furniture, ALT, Emma Lelong, Rémi Nguyen, 2018

The design needed to take two aspects into account. On one hand, the shape and the location of the furniture needs to enable users to take long pauses on it in order to cool their body down and alleviate the stress induced by prolonged periods of overheating. The furniture was therefore designed as a large bench where many people could rest and it was decided that it should be located in a public space that is comfortable enough to welcome long stays. On the other hand, the furniture cools the atmosphere around it down by design. The bench will then behave in accordance with the outside climatic condition to create a more welcoming atmosphere around it. In summer, when the temperature exceeds 28°C, the bench will start blowing a cool breeze. Designing this new atmosphere required taking into consideration every aspect of the user's experience and four ways for the bench to interact with people nearby have been clearly identified.

Firstly, a cooling effect will result from the fact that air around 14°C and 17°C will be blown by the bench. This temperature may vary according to the depth of the gallery and the air flow through the underground network. Secondly, the air movement itself will accelerate evaporation of perspiration on the skin, providing a cooling sensation. However, a strong breeze may cause discomfort. An optimum airflow of 500m³/h has been calibrated from the amount of fresh air available in quarries and the pace at which it naturally renews. Thirdly, because the underground air is water saturated with a hygrometry reaching 100%, the pulsed air will contain droplets that will act as

5. A Parisian Museum dedicated to architecture.

6. The urban cooling network managing company in Paris.

7. A Paris based engineering studio.

a humidifier, a cooling system largely sought after during Paris summers that also coincides with dryer episodes. Finally, the bench will be made of marble stone from the Seine valley. Its thermal effusivity is around $2500 \text{ J.K}^{-1}.\text{m}^{-2}.\text{s}^{0.5}$, making it more efficient to exchange thermal energy with its surroundings, thus making it naturally cool to the touch.

The impact of the bench on the surrounding atmosphere was modeled using Physiological Equivalent Temperature index (PET) which describes the heat exchange between the body and the environment (Hoeppel, 1999). The PET index has, for instance, been used to create a bioclimatic map of urban heat islands (Matzarakis, Mayer, Iziomon, 1999). Taking into consideration the aforementioned effect of the bench on the nearby atmosphere, the model showed that the PET index could be improved by 10°C compared to the referential temperature when the bench is functioning in optimal conditions.

From Modelling to Empirical Testing

Although the model approach was necessary to design some key elements of the bench such as the air flow, the maximum length of the bench and the impact on the nearby atmosphere, many aspects of its efficiency can only be explored and tested with an empirical approach. Through the design process the first step was to work in collaboration with the quarries inspection bureau (IGC) in order to quantify and qualify the air resource in galleries. Very little was known about underground air quality, its temperature and its movement throughout the network. Data was collected by exploring the network and made the modelling more precise.

Today, the high hygrometry creates a fungi rich environment which can decay limestone walls and aggravates risks of collapse. It appeared that inducing air flow bringing heat and reducing humidity might have a positive impact on the health of the underground structures. However, as these aspects are hardly studied in this environment, there is also the risk of disturbing the equilibrium. Installing a prototype becomes necessary to measure the impact of air flow on a small portion of galleries before a larger deployment is engaged. Prototyping the bench will also be an opportunity to better understand how air moves in galleries and how long it needs to remain underground to reach 14°C .



Figure 2. Underground data collection, Rémi Nguyen, 2019

Connecting underground galleries to the public space is possible with little work by using one of the 264 maintenance wells that are scattered around the city. They are around 1.5m wide and are recognizable by the IGC inscription on the manhole cover.

To identify the test sites, maintenance wells location was crossed with the Parisian urban heat island map made by the city. 20 usable wells were located in the parts of the city that are the hardest hit during heat wave. The design team working alongside the Paris street management bureau (*direction de la voirie et des déplacements*), the location of each of the wells was studied to determine if implementing a climatic bench there could benefit local population through five criteria: who manages the public space, how much space is available to not disturb other urban uses, who uses those public spaces, how busy it is, how visible it is.

Site n°8 Jardin d'Isoré

01/07

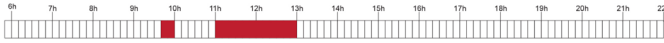

01/08

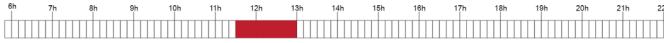

01/09

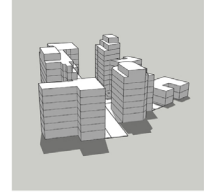
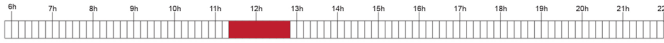

Figure 3. Implementation site study, ALT, 2019

Four sites were selected and then further studied to model their behavior during summer more precisely, mainly through sunlight exposure. More data would be needed to further understand the relation between the bench and the air flow at the scale of the neighborhood, mainly regarding thermic winds that appear during summer evening when hot air ascends creating depression at ground level. However, data on thermic wind is still scarce and could not be taken into consideration in this study⁸.

Prototyping and Evaluation

While location sites were investigated, the design of the bench was also developed so it could be adapted to more than one location. Even though it is a technically complex furniture, the main purpose was to create the entirety of the bench out of a single material, marble stone, to serve as a reminder of the underground origin of the air flowing from it. Furthermore, the design needed to be adaptable to fit many urban situations. Therefore, the bench is conceived out of trapezoidal modules that can be aligned along staggered rows to create a straight line or along the same direction to create a curve. The air flows without any metal sheath through a cavity hollowed in the module. The air flows out through slot created by spacers that are included in the

8. The city of Paris has some public data on thermic wind in summer. APUR. *Les îlots de chaleur urbain du cœur de l'agglomération parisienne. Cahier#3 : brises thermiques*. APUR, Paris: APUR, 2017.

design of the modules. This intricate design could only be numerically carved out to make them from one stone block. Working with a Parisian stone carver, Heres, who was equipped with numerical carving tools, made it possible to test the design and the comfort it will provide.

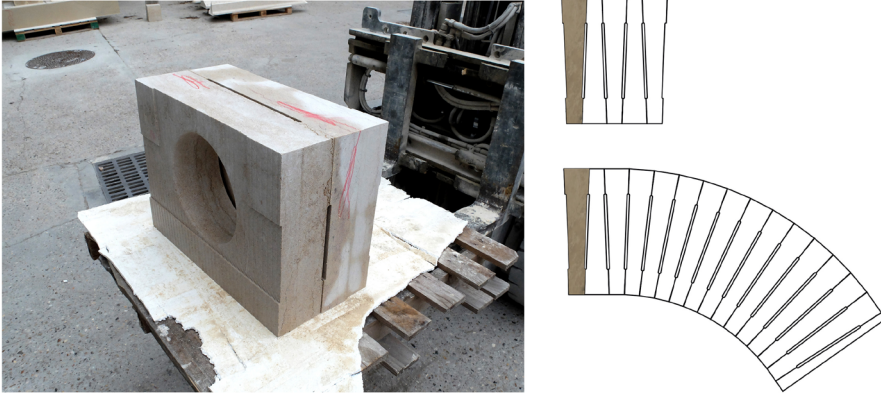

Figure 4. Prototype made by Heres, ALT, Ema Lelong, Rémi Nguyen, 2019

Prototypes of a few modules have been built, and today the first scale one test is ready to start. However, the Covid-19 epidemic has made it impossible to undergo the test in Paris streets this year, for it is still unsafe to gather in public spaces. Moreover, creating air flow could increase the risk of person-to-person transmission of airborne diseases. Testing has therefore been put on hold for the 2020 summer but should resume in 2021. The scale one prototype aims to measure the actual impact on refreshing the space around the bench regarding the PET index that was used to model the behavior of the bench. The office ALT will also document new uses that could be induced in the public space around the bench. Those ground level observations lean on similar experiences led by the city of Paris with their program of “oasis courtyard” in elementary schools⁹ that combine climatic measure with socio anthropological observations. Underground level evaluation will also be necessary, firstly to measure how fast the fresh air resource naturally renews itself and then to better understand how hot air flows impact underground fungal environments. Air quality measurements will also be taken in order to ensure that no pollution is pulsed in the streets. The evaluation aims to verify if such furniture should be deployed at a larger scale in the streets of Paris, since other sites could be used for similar interventions. Yet, identical actions are only possible in places where underground quarries are present making it necessary to explore other types of underground cavities that could fuel comparable apparatus in parts of the city with no underground quarries. Many do exist, but the quality and quantity of their resource in fresh air need to be thoroughly investigated case by case. Such actions are useful to help fight the effects of warmer summers until the city’s urban fabric undergoes more structural changes to fight urban heat islands.

9. Oasis courtyard is a test program aimed at creating cooler spaces inside school courtyard. CAUE 75. “Retour sur une année de projet cours oasis.” Online event, CAUE75, Paris, Accessed June 02 2020. <https://www.caue75.fr>

References

Agence Parisienne du Climat. *L'îlot de chaleur urbain à Paris, un micro climat au cœur de la ville*. Agence Parisienne du Climat, Météo France, Paris: Agence Parisienne du Climat, 2018.

APUR. *Les îlots de chaleur urbain du cœur de l'agglomération parisienne. Cahier#3 : brises thermiques*. APUR, Paris: APUR, 2017.

“Canicules : effets sur la mortalité en France métropolitaine de 1970 à 2013, et focus sur les étés 2006 et 2015.” Accessed 20 juin 2020. <https://www.santepubliquefrance.fr>

CAUE 75. “Retour sur une année de projet cours oasis.” Online event, CAUE75, Paris, Accessed June 02 2020. <https://www.caue75.fr>

Hoeppe, Peter. “The physiological equivalent temperature: a universal index for the biometeorological assessment of the thermal environment.” *International Journal of Biometeorology* 43 (October 1999): 71-75. <https://doi.org/10.1007/s004840050119>

Matzarakis, Andrea, Mayer, Helmut, Iziomon, Moses Godwin. “Applications of a universal thermal index: physiological equivalent temperature.” *International Journal of Biometeorology* 43 (October 1999): 76-84. <https://doi.org/10.1007/s004840050119>

Raw Materials and Emphasis on Tactile Perceptions to Create Atmospheres

A Tactile Experiment to Explore Bodily Sensations

Nuria ALVAREZ COLL¹

Abstract. Vernacular architectures mirror the territory where they are inscribed; contemporary architecture seems to be uprooted. As a counterpoint to a trend towards abstraction, can the use of the bio-based materials and the promotion of a tactile and more direct relationship to the world be allies to create architectural spaces that reaffirm a sensitive link to the body and reanimate a genius of the place (Berque, 2016)? “Dressing as a second skin” is the beginning of a series of tactile experiments who will explore the architectural potential of bio-sourced materials in relation to bodily sensations in a space.

Keywords. Atmosphere, Touch, Raw Matter, Bio-Based Materials, Haptic, Materiality, Texture

Raw Matter to Create Rooted Spaces

Heir to a culture marked by modern dualism, man seems to find himself, since the development of industrialization and the exploitation of resources, abstract from the environment. By extension, many of today’s human creations are considered by some authors to be uprooted (Pallasmaa, 2015). Vernacular architectures mirror the territory where they are inscribed. Built with available and local materials, these constructions appear as an extension of nature, its colors, its material, its forms, its textures... Today, the proponents of architecture claimed as more contextual are partly renewing this idea. For Peter Zumthor (2006) or Wang Shu (2013), this research for a certain “harmony” or concordance between the landscape and their architecture is rooted in the material by relaunching a more tactile apprehension of its surfaces.

This research will contribute to the debate and to the development perspectives of the use of bio-sourced matter (materials that keep the state as close as possible to its original state: earth, sand, straw, stone, wood, etc.) also called “raw matter” hereon to designate its absence of elaboration. Considered more sustainable in the ecological debate, the impact of these “raw materials” on the perception and construction of the atmosphere must be better known. This work aims to bring these elements of knowledge and explore methods to bring them about. In this perspective, we ask ourselves the question: how can we explore the architectural potential of bio-sourced materials in relation to bodily sensations in a space?

1. Univ. Grenoble Alpes, CNRS, ENSAG, AAU_CRESSION, France. alvarezcoll.n@grenoble.archi.fr

The Study of Atmospheres and Touch as a Focus

The human sensations created in an architectural space turn out to be a complex knot of impressions and emotions that need more research by getting through different approaches. Therefore, this research is located in the intersection of different disciplines: philosophy, psychology, phenomenology and architecture.

Interest in the study of atmospheres in architecture has grown since the end of the last century, and the consideration of the affect and sensations related to ordinary experience in the design of spaces is subject to multiple investigations. Recently, the finish architect Juanhi Pallasmaa emphasizes the sense of touch in contrast to the hierarchy of view in the design of spaces (Pallasmaa, 2015). Tactile function allows us to explore a body experience in space and it is immediately in the field of affectivity. This parameter is at the main core of the research.

“Perhaps the tactually unengaging nature of much of the modern material world is a product of our arms-length relationship to the environment.”
(Howes,2005).

We start from the hypothesis that architectural spaces designed using “raw” materials have the ability to create specific atmospheres and processes of apprehension, design and manufacturing involving the body directly.



Figure 1. Relational objects,
Lygia Clark, 1980

This tactile experiment is titled “Dressing as a second skin” and seeks to approach the types of “body feelings” awakened by materials of different nature when a subject comes into contact with them.

This experiment was inspired by the work of the Brazilian artist Lygia Clark. During his last stage, his work detaches itself from the sense of sight and highlights physical contact. Through the “Relational Objects”² placed on different parts of the participant’s

2. These objects do not have specific characteristics, they are defined in the relationship they establish with the fantasy of the subject during the sessions.

body, she claimed that he could reach a preverbal stage, what she called the memory of the body. Thus, a relationship is established between the objects and the body of the participant through his sensory image and physical contact.

Tactile Experiment: “Dressing as a Second Skin”

Spatial and Material Setting of the Experiment

The experiment was set up in Grenoble in a room of 15m² in an apartment that was transformed into a workshop for 3 days during the month of June 2020. It was experienced by 10 participants (6 men and 4 women) between the ages of 20 and 60. The search for subjects of a wide range of ages and with various professional activities seemed to us important for a heterogeneity of answers.

We have chosen materials that are contacted daily with our skin. More concretely, these 20 elements to dress the participant were divided into 2 categories: bio-based and processed materials.

Matière	Composition	Position	Matière	Composition
1 Coussin	Balles de riz	sous tête	1 Coussin	Microbilles polystyrène
2 Couverture	Peau de mouton	genoux et jambes	2 Peau de mouton	70% polyester - 30 % polyacrylique
3 Tapis tréssé	Jonc de mer	sous bras	3 Tapis tréssé	Fibres en plastique
4 Tissu léger et transparent	100 % cotton alimentaire	en couvrant bras et main	4 Tissu léger et transparent	1000% polyester
5 Cuir	cuir de vachette	sous bras	5 Cuir	Tissu enduit en plastique
6 Fil à tricoter	100 % laine merinos	pied	6 Fil à tricoter	100% acrylique
7 Foulard	100 % soie	cou et entourer tête	7 Foulard	100% polyester
8 Matière en brut	100 % cotton brut	main	8 Matière en brut	Polyester
9 Corde	100% chanvre	avant bras	9 Corde	Plastique
10 Sac	100 % jute	pied	10 Sac	Plastique

Figure 2. Matter guide with 10 bio-based materials (left) and 10 processed materials (right). In the middle body parts were these matters were placed. Nuria Alvarez Coll, June 2020

These materials were categorized on the opposite sides of the carpet. When the participant lay down, the researcher placed the different materials in the order indicated on the table.

Procedure of the Experiment

The duration of the experiment was between 60 and 80 minutes for each participant at a time. When the instructions of the experience were presented, the participants closed their eyes and were guided by the researcher to the experience room. “Dressing as a second skin” takes up the research on tactile perception undertaken by psychologist J. James Gibson, based on the notions of passive touch (“being touched”) and active touch (“touching”) (Gibson, 1962).

Passive touch. The participant remains lying, motionless while the different materials are placed around his body. It is an experience in two phases: one for “dressing” with bio-based materials and the other with those transformed. The participant first expresses the immediate emotion by saying “yes” or “no” to the material, if his body accepts or rejects it³. Then he expresses his body sensations.

Active touch. The participant is seated and develops by himself exploratory movements towards the same materials presented in the first phase. Confronted with both matters at the same time, he must choice the one he prefers and express the reasons.

3. In reference to Peter Zumthor words in his book “Atmospheres”: “There is something in us that instantly tells us a lot. Immediate understanding, immediate emotion, immediate rejection.”

Proposing pairs of materials very close to the touch but different compositions (transformed or bio-sourced) the experiment analyzes different body sensations related to the nature of the materials and the processes involved.

As data to be analysed, the experiment counts with the transcription of 10 participants on two experiments. These data were divided into two analysis categories:

- Analysis of closed responses (yes, no and material preference) that is presented in the form of percentages;
- Detailed analysis of open-ended responses collected by direct note taken during experiment.



Figure 3. Passive touch experience.
Nuria Alvarez Coll, June 2020



Figure 4 and 5. Active touch experience.
Nuria Alvarez Coll, June 2020

Findings

Being Touched vs Touching

Passive touch does not reveal, in most cases, a real difference between materials of very close textures; the nature of the two types of materials is confused. For example, the body sensations described by the participants in contact with natural leather refer to the processed material: “plastic,” “neoprene combination to go into the water.” And conversely, for processed leather: “it reminds me of leather,” or “seal skin.” Placing the head on the polystyrene ball pillow or on one filled with rice balls was in both cases linked with the grains of sand.

In terms of active touch, participants’ responses highlight a general preference for bio-based materials. There are 5 materials for which there is an obvious answer: leather, raw material and rope.

The Language of Materiality

The free answers of the participants allowed us to analyze the vocabulary that appears when we evoke materiality. The emerging categories are:

1. Judgement: “pleasant,” “comfortable,” “like or dislike”...
2. Material description or material identification: “it is like leather,” “heavy cotton,” “rough”...
3. Metaphors: “like a cloud,” “spider’s web,” “lightness of butterfly wings.”⁴⁾ Memories: “My teenage room with coconut on the ground... I remember I chose it, but it’s not pleasant to walk on it.”⁵⁾ Body feelings and interaction with other senses: “reassuring,” “soothing”...

The category that we thought was more relevant to analyze is the last one, “Body feelings and interaction with other senses” to be the closest to the notion of ambiance at the phenomenal level.

Link Between Sensory Modalities

Using a mask on eyes by removing vision allows other senses to sharpen. In the responses of the participants, the link with the other senses was very present.

All references in the sense of smell are related to raw materials. For the transparent cotton fabric, one participant commented as “The smell of hemp or linen is quite pleasant.” A participant expresses body feeling at touch, in contrast to the smell of matter when his arm comes into contact with the sea rush carpet: “It’s rough, it stings. At the same time, it smells of straw, of fields.”

Sound is also an important factor for the participants and justifies affirmative or negative responses to the material. One of the subjects explains his perception process when he comes into contact with the pillow filled with rice balls: “The sound and the cracking evoked me from the fibers of dry herbs like lavender, a very dry plant that cracks or sand. I like the idea of natural material.”

There was also a call in the sense of sight, referring to the color of the matter (concretely 2 subjects out of 10). From these two participants, only 2 comments referred to the color of the material for those bio-sourced versus 14 comments on processed materials.

The passages between senses thus characterize the overall experience, guiding the responses of the participants.

Limitations of the Experiment

The analysis of the answers shows us that the bodily sensations depend in part on the place of the body where materials are placed and the duration of contact.

The comments that highlight this first observation are mainly in relation to the transformed silk scarf, placed on the neck of the participants: “oppressed for the place where it is but pleasant material,” “Pleasant but can be related to the part of the body... I like being covered on the neck.”

The duration of contact with the material also causes moments of doubt among the participants. Being touched by the cotton transparent fabric, one of the participants commented: “We can believe that it is pleasant but ultimately not. We can be fooled...” Another subject, when his body comes into contact with the silky polyester: “As it’s hot, it’s fresh and pleasant. But it’s a synthetic material and it won’t be pleasant for long.”

Conclusions

The objective of this experiment was to understand and measure the different body feelings of our surface -skin- in contact with transformed or raw material surfaces. This first exploratory experiment allowed us to analyze the language used to evoke materiality and define the emerging categories. The results point already the importance of further knowledge gathering and the integration of materiality as an essential element in the design of ambiances.

“Dressing as a second skin” gives us the impetus to continue the explorations through an active touch that is not limited to the hands, if not all our body-skin. These are the bases of a search around touch with a multisensory spirit.

References

Berque, A. (2016). “*Milieu, art et génie du lieu - une interprétation mésologique. Conférence action sur les nouvelles dynamiques de la fabrique urbaine : ce que l’art peut faire à la ville ?*” Angers, 13 octobre 2016.

Gibson, J. (1962). *Observations on active touch*. Psychological Review.

Howes, David. “Skincapes.” In *The book of touch*, de Constance Classen. Berg, 2005.

Louring Nielsen, Stine. Friberg, Carsten et Hansen, Ellen Kathrine. “The Ambiance Potential of Coloured Illuminations in Architecture” *Ambiances*, n°4 (2018) <https://doi.org/10.4000/ambiances.1578>

Muñoz Recarte, Marta. “Imagen, acción y corporalidad en el trabajo de Lygia Clark.” *Continuumlivearts*, 2004. <http://www.continuumlivearts.com/wp/?p=1198>

Pallasmaa, Juhani. *Le regard des sens*. Linteau, 2015.

Shu, Wang. *Wang Shu, Construire un monde différent conforme aux principes de la nature*. Cité de l’architecture et du patrimoine. École Chaillot, 2013.

Zumthor, Peter. *Atmosphères*. Birkhauser, 2006.

In-Between Art, Architecture and Landscape

Experiments on Poetic Ways of Research-Creation in Rio de Janeiro

Fabiola ZONNO¹,
Lis PAMPLONA²,
Daniel MILAGRES³,
Claudia NÓBREGA⁴

Abstract. The research “In Between Art, Architecture and Landscape” investigates contemporary practices in the expanded field, especially those of a site-specific character. Our group has practiced some gestures of research-creation, inspired by situationist and contemporary artistic tactics in flux - “dérives,” “événements,” poetic images, montages and play-elements - in the suburban neighborhood of Encantado, in Rio de Janeiro, with the aim of investigating its sense of history and atmosphere and raising questions about its possible reinvention. The article presents our artistic actions as the collective “Re-Encantado,” with the engagement of local residents: “Atlas of Encantado,” a ‘montage’ of past and present images, and “Where is Encantado River?” - événements and videos.

Keywords. *Memory, Play-Elements, Suburb*

Re-Encantado, Artistic Gestures in a Suburban Atmosphere

In the research “In-Between Art, Architecture and Landscape,” architecture is understood as a process of thinking enriched by complex relations to other disciplines, including other forms of art. ‘In between’ is the possibility of a rhizomatic creative thinking, experimental and enriched by crossed fields, that we interpret as a mode of complex knowledge (Zonno, 2014). The term ‘in between’ is also understood as a way of refusing dichotomic oppositions and a way of creating complexity, for instance, subject and object in phenomenological thought. The concept of chiasm, between the visible and the invisible, in Merleau-Ponty’s words, inspired many contemporary artists and architects, affirming the importance of the ‘body’ as central to lived experience.

Talking about an atmosphere, it is a prototypical ‘in between’ phenomenon. As Gernot Böhme (2017, 2-7) puts, it affects us and mediates objective factors of the environment with æsthetics human being feelings, involving intersubjective and social aspects. Urban æsthetics can be understood as atmospheric, concerning what is ordinary, what constitutes daily life and needs to be sensed to be understood. So, it is the presence of time, that can be felt in simple things. City historical depth is manifested not only by its signs, but by the inhabitants’ feelings of time, the impressions caused by qualities of “being old” or “having grown over time” (Böhme, 2014, 51-53).

In this deep feeling of the temporality of places, the power of involuntary memory would be implicit, when the actual opens up to the virtual, in Deleuze’s interpretation

1. Ph.D. Professor at Federal University of Rio de Janeiro - PROARQ-FAU, Brazil, fabiolazonno@fau.ufrj.br

2. Doctoral Student at Federal University of Rio de Janeiro - PROARQ-FAU, Brazil, lispamplona@ufrj.br

3. Doctoral Student at Federal University of Rio de Janeiro - PROARQ-FAU, Brazil, danielmilagres@gmail.com

4. Ph.D. Professor at Federal University of Rio de Janeiro - PROARQ-FAU, Brazil, claudiacnobrega@fau.ufrj.br

of Bergson, as an event capable of producing affects. Paul Ricoeur (2007, 68) explains, also from Bergson, that in the “memory’s movement that works” memory-image, a true evocation of the past in the form of images presents itself in an area similar to perception, mobilizing the imagination visualization function. The exercise that moves voluntary and involuntary memory takes us to subjectivity’s field and to the possibility of talking about shared experiences. The dialectic between identity (the self) and alterity (the other) can be mediated by images and fragments of the real-imaginary that we experience. For Walter Benjamin (2014), the remembrance also belongs to an involuntary nature, as in Proust, since that past significant impressions are extracted from the unconsciousness. Thus, in his view of history, he proposes a deep dive into fragments and reminiscences, in any point of reality, to open it, causing flashes or ‘shocks’ in-between the then and the now.

Gathering phenomenology, imaginary and processes of becoming, our research group’s artistic experiments are tactics of approaching, sensitizing and criticizing places. This paper presents the experiences, developed in 2018 and 2019, having the suburban area of ‘Encantado’, in Rio de Janeiro, as a laboratory. The neighborhood is part of the large area of the suburb, which was developed from the expansion of the city’s railway network in the 19th century and currently undergoes a process of densification and verticalization. Encantado, a name that means enchanted, resists and distinguishes itself by its unique ambiance, the result not only of the historic character of its architecture, but of daily and collective practices.

We created a team’s collective - RE-ENCANTADO⁵ -, proposing actions to enchant the place, between past and future, to re-turn and re-invent it. By engaging in tactics in flux, the condition of becoming, in which the nomads are launched, we allowed ourselves to become other(s) in the condition of openness to events. We created situations, images and poetic writings about time’s presence. Our research “gestures,” “vital” and simultaneously æsthetical, ethical and of knowledge (Flusser, 2014, 53), assumes the condition of being in flux and being collective. ‘In between’ artistic mediums is the way to reach the ‘in between’ dimension of ambiances. The idea of play-elements is also present, as a difference and repetition play: we repeat the will, the gesture of seeking enchantment or poetry through the city experience, and we always discover the difference, which enriches and complexifies the gesture of knowing, making it an openness, which demands us to play again. Creating is this process: playing to perceive, playing to remember, playing to imagine.

Dérive, “Atlas of Encantado” and “Where is Encantado River”?

The situationist group defined *dérive* as the “affirmation of a playful-constructive behavior” in the production of cities where the spectacularization processes intensified the impoverishment or destruction of corporal experience. The play-element for the situationists, taken from Huizinga, is a way of transforming subjectivities, a ludic but serious play, with political contours. Capable of bringing a poetic character to daily experience, *dérive* is understood as an æsthetical practice (Careri, 2017).

We wandered for several months, starting from different points in the neighborhood,

5. The Re-Encantado collective, under the coordination of Professor Fabiola Zonno and collaboration with Professor Cláudia Nóbrega, has the participation of doctoral students Lis Pamplona and Daniel Milagres (resident of Encantado) and of graduate students Gabriel Martucci and Gabriel Nigri, among other students in distinct times: Priscilla de Mello, Laura Gomes, Mariana Castro, Marcela Dorea and Igor Dias. The work had a partnership with Rio de Janeiro’s City Hall, under the coordination of Juliana Oachin.

walking in groups and registering our perceptions and encounters, through photographs, drawings and cartographies. We explored the tactic of cards, randomly drawn by the participants, each one containing a verb, suggesting a bodily and relational action: “to cross,” “to peek,” “to decal,” “to smell,” “to listen,” “to collect.”...

Our first *dérive* was in the Saint Peter’s Church, between the walls of the ruined building. On this and other drifts, we have discovered villages and modest houses. A frontispiece, a railing, a tile - many tiles with images of religious saints -, and we started to make collections as part of the game. Repetition and difference. Pixos and graffiti on the walls sometimes invade old houses frames. There are signs “for sale” (anything) attached to the posts and colored kites attached to the wires. A window, a small balcony, a terrace - spaces for exchange and socialization -, fluid boundaries between public and private. People inside the house asked who we were, what we were doing there. We are playing... Where is Encantado River? There were people on every corner. Meeting in a specific corner we discovered the place we have seen in an old photo. In the bakery on the corner, we ate “*pé-de-moleque*,” a sweet we remembered from our childhood. A small flower bed on the street became a community garden. We were told that the singer Aracy de Almeida lived there, that there were samba parades on the streets in the past. Today there is soup on the street, Saint Peter’s soup. Eating this soup is sharing the common, the community. We had the soup. Enchantment.

The experiences in the neighborhood were configured as a set of paradoxes between the lived space of perception and the lived time of memory. We recognize our photographs, as fragments of our passages, poetic images and “site writings” (Rendell, 2016). Then, we were already provoking ourselves to construct in more collective ways, including others, as locals, an action we performed through the *atlas*.

Combined with our testimonies-fragments of the neighborhood, the collective Re-Encantado began to gather diverse materials, varying between poetic and documentary texts and images of the past and the present. Our testimonies were added to a larger file, where songs, maps, poetry, newspaper reports, photographs and paintings of the neighborhood consolidated themselves as an open collection, available to manipulation and constant reorganization. From this living archive, our group was confronted with the possibility of researching and producing with the residents. Different from archiving the memory, which removes it from its lived flux, we rather guarantee its movement and vital force by being close to its agents.



Figure 1. *Atlas of Encantado's* montage, Re-Encantado, 2019.

Therefore, the event “Atlas of Encantado,” performed in a week of activities with residents in a municipal’s sports center, was configured as this opportunity to face the

problem of living memory. Starting from Georges Didi-Huberman's studies on the atlas as a form of knowledge through imagination (Didi-Huberman, 2017), we were guided by the manipulation of graphic and textual images to cross the contemporary material and immaterial reality of Encantado. In this event, we jointly manipulate fragments in the montage table, producing relationships between characters, myths, places, and events that traced Encantado from an expanded field of perception.

Verses of the samba "Caco Velho," the legend of Encantado River, the afro-american artists and their sonorous balconies, the ceremony of Saint Peter's Soup, football fields, pixos, the train, the poetry of Cruz e Sousa, the insane, the church, the carnival, Mrs. Maria's backyard, the children, the kites, the streets. All alive, all present at our table. Thus, we have lived the atlas as a field of simultaneities, as a slow cuisine where smells, textures, flavors, and colors have come together under Encantado's name. Our atlas, as action and force of possible realities, of possible atmospheres, restored an imaginary sense of place.



Figure 2. Montage of "Where is Encantado River?," Re-Encantado, 2019.

"Where is Encantado River?" is provoked by the presence-absence question about the river that crosses and names this neighborhood. As an urban legend says, the river was "enchanted," because things were mysteriously dragged by it. Moved by this enchanted dimension of the river and its poetics, we constructed three actions that unfolded many situations, performed by two members of the collective - Gabriel Martucci and Gabriel Nigri - as play-elements of pursuing Encantado River.

The first action is called "Re-taste" and its program concerns preparing a soup, taking the necessary material to settle down and eat it at the riverside. The river was vegetation, breath, sewer, pipes, fishing, rubbish and freedom. The soup was pray, coconut sweet, lit candle, procession, beer, Saint Peter, people standing in the street, priest, fireworks and samba. An important sensation in this created situation was the smell of the river shocking with the soup's taste. These waters - soup and river - affected us as paradoxical mnemonic forces: the food that is the origin of common life happening in a river almost dead. In-Between indifferent, uncomfortable and laughter faces of others and positive waving to our presence in this riverside, Encantado River came to life.

The second action, called "Re-bed," is performed by releasing a mirror in the river. We stalked some parts of the river to enhance the construction of an imaginative play between the presence of that element and its (majority) absent parts. Soon the mirror turned down with the water's movement and, poetically scanning the river's bed, continued in flux until it finally stopped. Gabriel Martucci jumped over the margins wall and managed to catch it. Intercrossing the situation to images from "Atlas do Encantado," the action of getting into the river to catch the mirror convokes the memory of fishing, of bathing in once clean waters. The now and the then critically shocked.

The third action, “Re-orientation,” is a sequence of *dérive* that shows historical images of the neighborhood and asking residents “Where is Encantado River?.” The purpose of the play was to expose residents’ perception, assuming an errant posture, in the search of a strange-familiar condition. Wandering structured the whole action. The *dérive* and encounters produced an intense process of orientation, dis-orientation and re-orientation, which was manifested through spoken words and gestures. Each encounter has constructed situations, envisioning a relation of proximity with the river, as possible atmospheres.

Poetic Ways to Atmospheres

The research gesture, as proposed by Flusser, is above all a gesture of human life (Flusser, 2014). The poetic experiments that took place in Encantado neighborhood were gestures of research-creation, recognizing testimonies, being witnesses, collecting traces of floors and windows, belonging to life forms and their mutations, and creating possible new forms of life. Our gestures unfolded in making art, history, politics and education.

We started as nomads, willing to play to perceive, to play to engage others, and then we realized that we were playing to imagine. Through événements, possible atmospheres have emerged from the here and now, enhancing imaginable ways to transform the space - return to reinvent. In the movement of memory, past rises in the present and, via imagination, in the future, as constructed meanings expand the possibilities of these places. In this process, we realized that our work steps were folded in each other, allowing apprehension and enchantment, meanings’ insurgencies, images of memory and desire, intertwining different threads of time and space, making the understanding of this researched-created place more complex.

Our practices investigated a sense of past present, encouraging time meaning and production of affects. We recognized that our perception was enriched by crossed time imaginary - the images produced by us and the images of the past - producing new senses. Drawings, photographs, videos, created poetic images or site writings, also sites of critic. *Dérives*, événements and montages are artistic tactics that can lead architects and planners to develop a relation of proximity in experiencing places and being with “others”; these are ways to feel atmospheres and create atmospheres. Artistic practices not only may transgress conventional ways of perception and representation, but enrich architecture creative thinking, influencing the production of places in æsthetical, ethical and social terms.

References

- Benjamin, W. *Walter Benjamin Obras escolhidas I. Magia e técnica, arte e política*; São Paulo: Editora Brasiliense, 2014.
- Böhme, G. Thibaud, J. (Ed.). *The æsthetics of atmospheres*; New York: Routledge, 2017.
- Böhme, G. Thibaud, J. (Ed.). “Urban atmospheres: charting new directions for architecture and urban planning” In *Architectural Atmospheres - on the experience and politics of architecture*, edited by C. Borch, 42-59. Basel: Birkhauser, 2014.
- Careri, F. *Caminhar e Parar*; São Paulo: Gustavo Gili, 2017.
- Deleuze, G.; Guattari, F. *Mil platôs: capitalismo e esquizofrenia*. V.1. Rio de Janeiro: Ed.34, 1995.

Didi-Huberman, G. *Atlas ou o Gai Saber Inquieto*. Belo Horizonte: Editora UFMG, 2017.

Flusser, V. *Gestos*. São Paulo: Annablume, 2014.

Huizinga, J. *Homo ludens*. O jogo como elemento da cultura. São Paulo: Perspectiva, 2007.

Rendell, J.; Keramida, A.; Marozas, P; Rammohan, M. "Site-writing". In *Engaged Urbanism - Cities and Methodologies* edited by B. Campkin and G. Duijzings. 1ed. London and New York: I. B. Tauris & Co. Ltd, 2016.

Ricoeur, P. *A memória, a história, o esquecimento*. Campinas, SP: Editora da Unicamp, 2007.

Zonno, F.V. *Lugares complexos, poéticas da complexidade*. Entre arquitetura, arte e paisagem. Rio de Janeiro: FGV, 2014

Realities aren't Real!

A (Really) Brief Cinematic Chronicle of the Constant Resistance of the Real against Urban Planning Realities

Neoklis MANTAS¹,
Alex DEFFNER²

Abstract. Planners are asked to deal with an aphoristically constructed urban reality, while being practically reluctant towards the 'un-programmable' real life of each citizen. However, the conceptions and perceptions of the Real (realities) have changed during the timespan. What follows is an anthology of the three pivotal mutations, which are linked to certain 'structures of feeling' (a term used by Raymond Williams): modern, postmodern and metamodern, and aspires to detect their inexhaustible mark on urban planning (conception of urban reality) and urban living (experience of the urban Real), as featured in three representative films: Lang's *Metropolis* (1927), Burton's *Batman Returns* (1991) and Nolan's *Inception* (2010).

Keywords. Cinematic City, Real, Urban Planning Realities, Metamodernism, Phenomenology

Prelude: Reality is the Ambiance of Real

Baudrillard had expressed a Lacanian warning about the intrinsic difference between Real and reality (1981/1994). According to the French post-structuralists, Real is noumenal and can only be lived without being predicted, whereas realities are formed according to conceptions and perceptions, as an attempt of dealing with the infinite and primordial Real. On the same wavelength, one could say that planners are asked to deal with an aphoristically constructed urban reality, while being practically impotent towards the 'un-programmable' real lives of the citizens. Likewise, citizens are forming their own perspectives towards urban life by defying or being indifferent to the imposed planning simplifications. However, those conceptions and perceptions of the Real (realities) have changed during the timespan, as they are highly sensitive to the ever-changing contemporaneity.

Within that framework, the first part of the paper detects three pivotal mutations in the historico-geographical experience of the Real, which inevitably left their inexhaustible mark on the conception of urban reality (urban planning) and the perception of the Real (urban living). But how the lived experience of the Real can be approached conceptually? Here, the theorizing concerning the experience of the Real is about to be attempted through the association of Raymond Williams' term (1961/2001) "structure of feeling" with the Lefebvrian Spatial Triad (Lefebvre, 1974/1991). Thus, those mutations are linked to certain 'feelings' of the Real: the modern feeling of Real, the postmodern feeling of Real and the metamodern feeling of Real. Each of those 'feelings' is the common ground for the emergence of different urban planning and urban living realities at each historical-geographical juncture. According to the authors, those

1. Ph.D.Candidate, University of Thessaly, Greece, neoklis.mantas@gmail.com

2. Professor of Urban & Leisure Planning, University of Thessaly, Greece, adefner@uth.gr

'feelings' are the *élan vital* that drives any cinematic attempt for representing the urban, whilst the films themselves can be regarded as documents of the dramatic negotiation between the synchronic planning and living realities. In more depth, the second part of the paper turns to DeCerteau's (1989/2011) concepts of urban "strategies" and urban "tactics," as presented in his book *The Practice of Everyday Life*, and attempts to link them with the notions of 'filmed space/filmic place' and 'narrated space' correspondingly. Within that theoretical spectrum, urban planners are powerfully "producing" places through institutional "strategies" that crystalize dynamic space, a similar attempt to author's artistic choices. In parallel, citizens are creatively 'consuming' the given places through every-day appropriational "tactics" of resistance, likewise a film character's narrated emotional climax. Lastly, that peculiar *bras-de-fer* is detected in the three representative films of the third part: Lang's *Metropolis* (1927), Burton's *Batman Returns* (1991) and Nolan's *Inception* (2010).

Act I: Structures for Feeling the Urban

Real, even if it is noumenal or infinite, is lived - conceived and perceived - through shared 'structures of feeling' and it ends up producing a certain historico-geographical reality. Those structures that help us feeling the Real are not clearly expressed or officially articulated, like ideologies (Williams, 1961/2001). In contrast, they can be easily detected in artworks and indicate the *Zeitgeist* of their epoch. In other words, they are ways of feeling the ongoing present and may range from formal consent to total dispute with the dominant culture.

During the timespan and over that spectrum of consent and dispute, the simultaneous extension of that 'structure' syllogism to urban reality points out two diametrically opposed modes of feeling the urban Real: a) **planners' utopian ideas** (the conceptualized space without life that tends to align with the dominant vision for achieving the ideal urban condition) and b) **citizens' actual experiences** (the lived space that denounces the dominant conception of the urban Real). Inevitably, planners' utopian ideas are developed within conceived space (Lefebvre, 1974/1991) and are characterized by simplifications about urban life, whereas citizens' actual experiences are constantly rising against those simplifications by reminding the profound - and often omitted - emotional dimension of being alive within the city. The formers are thinking of and dealing with the city in the abstract way of symbols and indicators, while the latter are trying to compose their idiosyncratically anarchistic manifestos, which are usually disputing planners' *ceteris paribus* condition.

Consequently, the three structures for feeling the urban can be outlined as an inextinguishable confrontation between the historico-geographical conception of the desired reality that guides urban planning and the asymptotic experience of everyday life with these planning realities.

The Modern Structure for Feeling the Urban

The modern conceptualization of urban space was obsessed with the scientific prediction of the Real and it was accompanied with a deep faith in the validity of universal truths, the typology of things and pure Reason. The ideal urban condition could be achieved through facing the city as a clock-worked machine and treating its dwellers as robots. For the modern urbanists, urban planning had to be used in order to program the mechanical progress in large scales, while promoting the functionality of the city (Harvey, 1990). However, the dominant conception of the urban Real, which was founded on the austere techno-scientific reason, was challenged by the lived experience of the modern condition and the socio-political yearning for the restoration of sentiment. Citizens were not robots.

The Postmodern Structure for Feeling the Urban

The postmodern conceptualization of urban space that succeeded modernism was mainly concerned about the artistic direction of the Real. In postmodern times of de-industrialization, when the deep faith in Grand Narratives was replaced by a fundamental nihilistic doubt, artistic intertextuality - which was based on cynical criticism, melancholic irony and deconstructive playfulness - changed the utopian vision towards the city. During that historico-geographical juncture, the ideal urban condition could be achieved through facing the city as a terrain for setting phantasmagoric spectacles and treating its dwellers as greedy audience. Cities had to be sold (city marketing). For the postmodern urbanists, the city was regarded as a deeply nostalgic palimpsest of pasts and commercial potential at present (Harvey, 1990). Urban planning was adapted to the retro-aesthetic dogma of an atavistic design. However, the dominant conception of the urban Real, which was founded on the intertextuality of the architectural decorations, was challenged by the lived experience of the postmodern condition and the socio-cultural yearning for organic integration within the city spectacle. Citizens were no longer hypnotized spectators.

The Metamodern Structure for Feeling the Urban

The metamodern conceptualization of urban space brought the branding of the Real to the fore. In the new millennium, it is time for city branders to poetically re-define the socio-cultural beta version of postmodern city marketing (Mommaas, 2002). Of course, that redefinition is taking place amid a severe digitalization, which does not leave cities unaffected. The ambivalent cultural contemporaneity is named as metamodern by the cultural theorists Vermeulen and Akker (2018), and produces new - open and global - systems about urban identities/images, which are based on metamodern mythopoeias that are attempting to re-construct the de-constructed by fusing modern naiveté and postmodern knowingness (Dempsey, 2015). Consequently, after the modern functional and postmodern phantasmagoric emphasis on urban planning, the new emerging urban planning reality approaches the city as a concept-land, where dwellers' dreams may be fulfilled: you can be creative in a creative city, you can be up-to-date in an intelligent city, you can be famous in a celebrity city (Knox, 2014). For metamodern urbanists, urban planning is mainly a matter of copywriting, as it has to increase city brand awareness and predispose particular (thematic) attitudes towards the urban. However, that new-age conception of the urban Real is often incompatible with the lived experience of the metamodern condition. Citizens are not avatars: they cannot be manipulated as in a video-game.

Act II: Orthodoxy of Filmic Places vs. 'Heretical' Filmic Spaces

If planners' utopian conceptions of ideal cities may be distinguished behind the lines of blueprints or technical reports, the psychic trauma that triggers the constant desire for a better place to live in may be traced in Arts. According to the authors, the dramatic negotiation between the synchronic planning and living realities has been relatively obvious in films. We turn to films because they stand as kind reminders of our practical impotence towards the materialization of the ideal city. The film is carefully planned; its story-plot is pre-given, exactly like the dominant conception of the city. However, it can be perceived in alternate ways by the audience. That fact brings in mind DeCerteau's theory about space/place. Through that linguistic prism, urban planners are used to think with places and the only freedom citizens have is to formulate alternative sentences (Vermeulen, 2015). Hence, a worth mentioning instant cinematic encounter of the seemingly contradictory DeCerteau and Lefebvrian thought takes place.

More specifically, filmic space, defined as the constructed space through all techniques that form the material object that is called film (Buckland referring to Souriau, in Koeck, 2013), can be considered as a suspension of synchronic urban dynamics, whereas diegetic space, namely the fictive space that is created between the visible on-screen and invisible off-screen space, can be activated only through the dialectic exchange with the spectator. In the same wavelength, films may stand as documents of crystallized Lefebvrian places (i.e. anchors in space) or as open terrains that enable the subversion of those places in a DeCerteau way (i.e. spatialization). Moreover, the paper is inspired by DeCerteau's (1989/2011) concepts of urban planning 'strategies' and urban living 'tactics', as presented in his book *The Practice of Everyday Life*, and attempts to link them with the notions of 'filmic (static) space', or '**filmic place**' and 'trialectically practiced place', or '**emotional spaces**', correspondingly.

Filmic Place

Filmic places are aesthetic crystallizations of the dynamic urban space and most of the times are harmonious to the prevailing historico-geographic conceptions of the ideal city. The orthodoxy of the production of those places is connected with the Lefebvrian conceived space, i.e. the dominant space within a society, which is designed to manipulate those who exist within it. Just like urban planners are powerfully "producing" suspensions of the dynamic urban space through institutional and structural "strategies," filmmakers make specific artistic choices (e.g. direction of photography, mise-en-scène, and montage), where the conception of an ideal urban reality usually lurks.

Emotional Spaces

Being confined within the filmic place of a movie, spectators can exercise their 'heretical' anagnosis to form an emotional space, as a result of the trialectic relation between the constructed filmic place, the dramatic mythos of the hero(in)es and the synchronic perception of the urban real. In a DeCerteau way, each spectator could creatively consume the given filmic place by reflecting on a plot climax that has been already programmed by the auteur. Within that framework, the last film sequence can be seen as the narthex, where the perceived filmic reality is about to meet real life.

Act III: the (brief) Cinematic Chronicle

Eventually, through references to the filmic places and the emotional spaces of three representative science fiction films, the three structures for feeling the urban can be verified. Besides, sci-fi films are ideal for detecting the encounter of imagined Realities with the lived Real, as they are synchronic documents of the historical-geographical conception of a desired reality and the non-coincidence of everyday experience with these (filmic) realities.

Metropolis (1927) by Fritz Lang

The filmic place of Lang's silent film is expressionistic. Through film's chiaroscuro photography and the epic linear montage towards its didactic happy-ending, Lang's vision can be seen as an emotional alignment with planners' ideas about urban utopias during functional modernity. However, the emotional space, which is opened beyond the artistically formal conception of *Metropolis* and real-life modern experience, reaches its optimistic apex at the last scene, where the heart becomes the mediator of head (capital) and hands (labor). The horizons of modern empathy had to be broader than the heartless, robotic logic of modernity.

Batman Returns (1991) by Tim Burton

The filmic place of Burton's oeuvre is intertextually operatic. Film's 'technicolorish' glossy photography, along with references to various cultural texts, such as comicbook/noir aesthetics or architectural gothic, constitutes Burton's vision a melodramatic duplicate of planners' ideas about the imagineered urban condition during a spectacularly melancholic postmodernity. Unlike modern optimism, postmodern emotional space is pessimistic. That is obvious in Batman's last Christmas scene, where the 'freaks' of the society - genuine (Penguin) or masked (Batman) - stay at the backstage of the phantasmagoric city spectacle.

Inception (2010) by Christopher Nolan

The filmic place of Nolan's creation is constructed through an oscillation between modern and postmodern polarities. On one hand, film's matte and neat photography, along with plot's naiveté before the scientific approaches of ideal (e.g. dreams are plain chemical processes), remind the positivistic mentality of modernism. On the other, the dream cities of the film, where all the scientific laws (e.g. gravity, time) are defied, are raising a postmodern awareness about the protection of inner felt experiences. Thus, Nolan's focus on the mental ideal cities can be paralleled with planners' metamodern obsession with concept-cities. Above all, metamodern emotional horizon remains vaguely optimistic. This is more than obvious at Inception's spinning top enigmatic scene, where the spectators have to decide whether to believe or not in the dream quality of the ideal (informed naiveté).

Epilogue: Cities Through the Looking Glass

Cinema offers a great opportunity for looking at our cities through a magnifying glass. In films, the dominant conception of the ideal city that seems to guide urban planning is blended with every day and real-life disputes. In other words, films may communicate effectively the urban feeling at a given historico-geographic juncture. The three aforementioned films are typical examples, considering that they depict modern, postmodern and metamodern urban feeling:

- Modern Mechanical Plans for heartless Robots
Modern reality made urban planning seem rigid and mechanic, while treating citizens like heartless Robots in the middle of a universal city,
- Postmodern Pop Designs for bionic Cartoons
Postmodern reality promoted a spectacular and nostalgic version of urban planning, in the name of which citizens seem to be cartoons in a graphic city,
- Metamodern Conceptual Guide addressed to Avatars
Metamodern reality is obsessed with the conceptual aspect of urban planning, with its directives predisposing particular (thematic) attitudes towards the city.

References

- Akker, van der Robin & Vermeulen, Timotheus. "Periodising the 2000's." In *Metamodernism: Historicity, Affect, and Depth After Postmodernism*, edited by Robin van der Akker, Alisson Gibbons & Timotheus Vermeulen. London; Rowman & Littlefield, 2018.
- Baudrillard, Jean. *Simulacra & Simulation*. Michigan; University of Michigan Press, 1981/1994.
- DeCerteau, Michel. *The Practice of Everyday Life*. Oakland; University of California Press, 1989/2011.
- Dempsey, Brendan. [Re]construction: Metamodern 'Transcendence' & the Return of Myth, (2015).
- Harvey, David. *The Condition of Post-Modernity*. Oxford; Blackwell Publishing, 1990.
- Knox, Paul. "Introduction." In *Atlas of Cities*, edited by Paul Knox. Oxford; Princeton University Press, 2014.
- Koeck, Richard. *Cine|Scapes: Cinematic Spaces in Architecture & Cities*. London; Routledge, 2013.
- Lefebvre, Henri. *The Production of Space*, Oxford; Blackwell, 1974/1991.
- Mommaas, Hans. "City Branding: the Necessity of Socio-Cultural Goals." In *City Branding: Image Building & Building Images*," edited by Marco Vermeulen & Veronique Patteeuw. Rotterdam: NAI, 2002.
- Vermeulen, Timotheus. *Space is the Place*. *Frieze Magazine* (2015). Accessed June 6, 2020. <https://frieze.com/article/space-place>
- Williams, Raymond. *The Long Revolution*. London; Broadview Press Ltd, 1961/2001.

Heritage / Fiction

For a Retro-Prospective of Dwelling-in-Ambiances

Nicolas TIXIER¹

Abstract. The sense of dwelling in a place is founded on multiple sources. Seeing and recounting the resultant constructions remain one of the major challenges we face in attempting to understand usages and the capacity of a place to renew itself while maintaining what makes it specific and whose ambiance is both a catalyst and a revelatory agent. Based on Etienne Souriau's works on modes of existence, reviewed by David Lapoujade, we will study the ways in which it is possible to see in a projectual framework a retro-prospective approaches of dwelling-in-ambiances. To illustrate these propositions, we will rely on an urban project that we developed: "L'Affaire de l'aqueduc de la Reine Pédauque" (Toulouse, France).

Keywords. Ambiance, Heritage, Fiction, Modes of Existence, the Becomings of a Place

Daily Life in Project and Modes of Existence

The sense of dwelling in a place is founded on multiple sources. *Seeing* and *recounting* the resultant constructions remain one of the major challenges we face in attempting to understand usages and the capacity of a place to renew itself² while maintaining what makes it specific and whose ambiance is both a catalyst and a revelatory agent.

The acts of *seeing* and *recounting* refer in part to the figure of witness and advocate, in which, according to David Lapoujade, Philosopher of pragmatism, "perceiving is not simply about understanding what is perceived, but also witnessing and attesting its value. The witness is never neutral or impartial. He has the responsibility to *make see* what he was privileged to see, feel or think. He becomes a creator. From a perceiving (see) subject, he becomes a creating one (make see). That is because, behind the witness, the advocate appears. He is the one who makes something appear, who ensures that every creation becomes advocacy in favour of the existence it makes appear." (Lapoujade, 2017, 19). Beyond reporting, it potentially implies advocating for the *modes of existence* that David Lapoujade considers minor, as they do not always have a legitimate place within our contemporary societies. *Seeing* can sometimes be *glimpsing*, which requires us to be attentive to what happens discreetly. *Recounting* can sometimes mean what is difficult to tell, if not the unspeakable, with a speech that would become public, or even with the simple use of words. We must be attentive, present and find other ways to recount this sensitive part or find ways to share the experience.

1. Univ. Grenoble Alpes, CNRS, ENSAG, AAU_CRESSON & ESAAA, France, nicolas.tixier@grenoble.archi.fr
Project in collaboration with Didier TALLAGRAND, ESAAA, France

2. Architect and researcher Pascal Amphoux, in an unpublished paper, proposes three values to make heritage: a historical, a use and a renewal value.

While reviewing Philosopher Etienne Souriau's works (1943), David Lapoujade proposes to examine these modes of existence according to four spheres: the world of phenomena (whose perfection of their way of being is to appear, art of appearing), the cosmos of things (art of remaining), the kingdom of fictions (art of nourishing) and the cloud of virtualities (art of being incomplete). This is relatively original for exploring what *makes* heritage, and how it is embodied in ambiances, but also for imagining *future developments* of dwelling places through narratives, uses, gestures and spatial configurations... We can imagine here a very stimulating perspective to articulate *seeing*, *recounting* and *doing*, for researchers interested in the evolutions of a place, in order to give these minor existences the right to exist, as well as their possible futures. In each minor existence, we can thus question: "with which founding *movements* do the existences successfully *settle*?" However, while we must identify these modes of existence, we also must not expose them unduly, at the risk of seeing them vanish³ (Zaoui, 2013).

Building the times and spaces for the utterance of these modes of existence often gives rise to questions of "translation" for researchers of ambiances. The conditions for reading and understanding between the "languages" and the modes of representation of the different actors and fields must be created. To that end, we can try to set up installations that are, as Paul Ricoeur stated (2004), welcoming to the other's language, to offer a "language hospitality" and organize the material in order to disseminate it, make it talk to other materials. The role of third party must be a desire and not an obligation, as Ricoeur states again, as to work for the "broadening of one's own language." We often refer to narrative, and sometimes to fiction, in multiple forms and formats that have full power of utterance and sharing: text, film, picture, sound, performance, installation, etc., but also of renewal of the experience (Tixier, 2017, 273-283).

In each place, dwelling weaves a heritage of uses that is perceived in the forms of presences, movements, stories, continuities, evolutions, as well as disappearances. Heritage also appears in the daily life through recursive and cyclical times, in embedded temporalities. It can also appear through traces, signs and stigmas, both physical and memory-based. Like strata, they compose our perception of every situation, draw different heritages and open up to fictions. Taking care of these and opening them to possible sequels means stepping away from solely programmatic stakes to work on the dialogue relations between the three modes, *seeing*, *recounting* and *doing*. They all fall within public matters as much as they act on it with their own performative dimensions. "Public matters" is to be understood here not as a thing defined once and for all, "but as a composition, a theatre of action, and as a society" (Joseph, 1998, 6). At all dwelling levels, it is about accepting and creating a dialogue between the materials of the public matter, which is naturally fitted with a plethora of points of view, as many committed perspectives, fictions about reality, opening up to public and collective stories. Such stories, whose forms are also plural, are both individual ones and collective ones that time has turned public and partly fictionalized. On that part, we agree with Camille de Toledo's propositions (2016) who argues, with others, for the collective elaboration of a reflection on open times, potential times to fight against the reality of finiteness and melancholy. It relies on a principle of expansion to all things and all scales by looking for modes of existence already at play, potentially, in our present, to create fictions in their own right. "In the 21st century, fictions

3. See Pierre Zaoui's works on discretion, in which "the experience of a modest time that is enough," in which "we surreptitiously drag beings and things towards the relationships that they produce" and in which "beneath its quiet, withdrawn, apolitical appearance, a new relation to politics appears."

are no longer additions to reality. The multiple strata of fiction are, as surely as the geological strata create a cliff, what makes “reality.” There is no *reality* before or beside *fiction*. We switch between the fictions that settle us down and turn us into aggregates of histories, beliefs, stories, in which we are born and we die.”

For each architectural, urban or territorial situation studied, we unavoidably extract certain *materials* and *histories* to the detriment of others in order to create stories and projects. Heritage is thus to be seen here firstly as a loan to build a filiation, a continuation, a fiction where the latter is not so much built on what we *passively* inherit as on what we choose to *willingly* inherit. It is about patiently and methodically building the narrative threads of a given situation. The threads that weave a specific and popular reading, as it deals with everyone’s daily life. Retro-prospective threads that, like the strata, compose our perception, draw heritages and open fictions in their own right⁴. Threads that weave a palimpsest of ambiances for all inhabited place (Marot, 2010; Gamal Saïd, 2014).

The point is to bear witness to the minor things. To advocate for their modes of existence. To write their possible becomings. These three actions, or missions, can change our points of view, initiate practices and build upon a use value as well as a renewal for all discreet forms of heritage, for anyone interested in its ambiances.

“L’Affaire de l’aqueduc de la Reine Pédauque”

To exemplify and engage a discussion about these propositions, we will rely on an urban project that we developed with Artist Didier Tallagrand: “L’affaire de l’aqueduc de la Reine Pédauque.” This project is located at Mirail in Toulouse (France).

Mirail is a large urban area composed of three neighbourhoods going from South to North: Bellefontaine, Reynerie and Mirail Université. It was fully built at the beginning of the 1970s by Architects Georges Candilis, Alexis Josic and Shadrach Woods. This neighbourhood, of over 20,000 inhabitants, is nowadays controversial, as is the case with many districts of the 1960s-70s modernity. Its renewal and evolution go through a rehabilitation of its history. Firstly, it deals with its recent history, a concrete utopia of its architectural and urban modernity. It also deals with its social history with the invention, partly disappointed, of a new life supporting the urbanity open to all. However, and it is often forgotten, it also deals with a history that is older and more deeply rooted in its geography (slope and water) and in its natural chrematistics (fauna and flora), i.e. a history of the ground.

It all started in 2013, when the renewal project of a park called *Le Petit Bois* in Bellefontaine brought back to attention the underground presence of a Roman aqueduct: the Reine Pédauque aqueduct. Michel Boulcourt, landscapist in charge of giving his opinion of the *Petit Bois* project, presented it as such: “We cannot forget the Roman aqueduct, whose origins date back to late-first and early-second century AD: some (last) traces are present on the site. About eight kilometres long, it was the last and most important of the two aqueducts that were built to provide the Gallo-Roman city with water. It contained deux sections. The first, from Monlong to Cépière,

4. Scottish biologist and urban planner Patrick Geddes (1854-1932) is undoubtedly one of the first people who thought a territory like that. He read the past times, like the one to come, in the traces of the physical, sensitive and social organisations of the present. For Geddes, whether they are urban, natural, social, etc., the delineations represent as much the history of a place and its mode of description as its future and its mode of projection (Torres, Chaudier, Tixier, 2016).

collected the sources and brought water to the castle (*castellum*) through an underground canal (*specus*). The second, from Cépière to the city, went over arches to cross the lower grounds of Saint-Cyprien. The aqueduct supplied around 12,500m² every day, i.e. around 500 to 600 litres every day per person... (a volume highly superior to current needs).” The aqueduct was relatively forgotten at this time. The first reason is that the aqueduct is... invisible: it is either buried in the south, or has been destroyed in the north, where it was overground with 517 arches and ended up passing over the Garonne. However, looking more closely and after more research and exploration, we discovered that the layout of its outline continues, and that it is available at more than 90%. All the way, we can find traces and clues that show its existence through different modes.

How can we make this line exist today, both in collective imagination and in unprecedented practices? How can we work on the modes of existence of this line to guarantee a secure outline tomorrow and give it possible futures with renewed uses? How can we nourish the original fictional imagination and how can we restore a sensitive potential of ordinary and extraordinary discovery? To create a narrative and a project, we organised a set of contributory workshops and a collection of archives⁵: a collective commented walk with experts in the different areas crossed (archaeologists, urban planners, sociologists, specialists in soft mobilities, etc.), a bike ride in search of the possible itinerary, organised on a Sunday morning with more than 80 participants from the whole city of Toulouse, a contributory roundtable to collect stories, perceptions and elements for the projects after the bike itinerary. Lastly, we organised a workshop gathering the institutional actors involved to discuss a first synthesis and deploy the project’s possibilities at different levels and according to different modalities. Ultimately, the itinerary is available nowadays on a website that tells graphically the story in five episodes, mentioning the elements from the previous workshops.

It allowed us to develop four narrative and projectual potentialities, as many cases to clarify and expand:

A mythological affair: or how the legend of a Visigoth queen with webbed feet gave her name to a Roman hydraulic installation elaborated in the early 3rd century. The queen, in her palace, owned a room for the “baths of the queen,” directly supplied in water by an aqueduct. How can this story of a queen and water continue to exist tomorrow?

A hydraulic affair: or how water, the vital and multisensory element, still appears today along the outline of the aqueduct. Fountains, lakes, ditches, canals and sources... originated from sources that are still active. They reveal an underground presence, which, overground, appears at times in a green vegetal flow. The revelation of this aqueduct, like a fine but real thread, offers Mirail the opportunity to reconnect with its ancient history, with its rural locality and vegetable lowlands, anterior to its construction as a new neighbourhood.

A metropolitan affair: or how the bicycle can here be assimilated to the liquid element of tomorrow. More than a stroll, the point is to propose an efficient crossing,

5. This project was developed in 2014 and 2015 as part of the *BazarUrbain* collective (www.bazarurbain.com) under the supervision of Toulouse Métropole and the City of Toulouse, thanks to the involvement of Pierre Pisani, Archaeologist, and David Coirier, mission head on the social stakes of urban renewal. A website was developed by Jérémie Bancillon in order to report interactively and graphically on the transect and the collected data: <http://aqueduc.jeb-project.net>

that no outline today allows to go from Mirail to the city centre by bike, based on the original outline of the aqueduct. The bicycle path could play with what already exists, compose with portions that are already usable. It could propose a unique point of view on the city, a section of it, a transect (Tixier, 2017). To whoever will use it, the straight and direct line of the aqueduct will offer a new reading perspective of Toulouse, almost literal, through the crossing of its successive crowns and a path through its urbanities.

A landscape affair with everyday practices: or how the three parks of Mirail (Bellefontaine, Reynerie, Mirail Université), which make the inhabitants proud, are clearly connected to each other and offer ways for daily commutes and strolls along this part of the Garonne where the aqueduct took roots. An active line where a thousand and one propositions can be connected and deployed: in the promotion of what exists as much as in the introduction of innovations, in the everyday ordinary as much as in the short-lived extraordinary.

According to Didier Tallagrand, the artist with whom we collaborated, “here, the landscape dissolves, the eye pulls away like an access to the wonderful, beyond the melody that meets expectations. Towards a place beyond the missing forms. It is not the construction of a violin case behind the back of the world, but the stream of water now. Maybe we should think like the underground, by gathering points of reality between the beginning and the end. From the source to the fountain: two toggling situations and then shooting straight. Crossing in startlement, in time, like steps that separate and make the vanished aqueduct resound from below. A rhythm, a distraction as an addition to architecture: “is the small tunnel that we cross the duct of the aqueduct?” asks a local. Producing a spark in the process, making a hole in space and time, a hole for nothing. A spark of light and building the place of the water that streams within the story and space, perhaps like a fiction.”

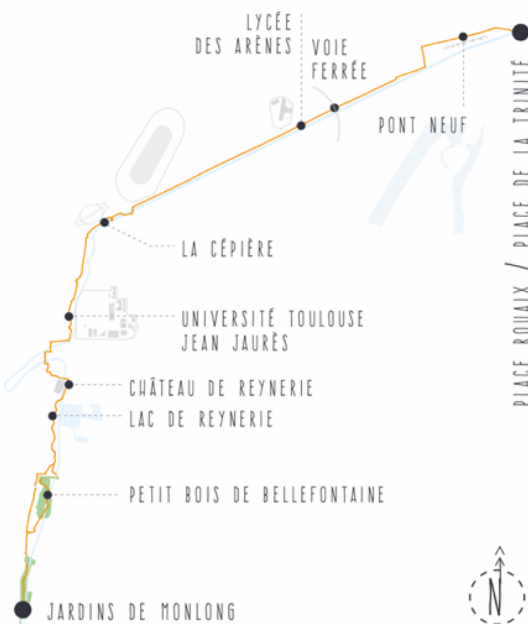

Figure 1. Outline of the aqueduct (light blue) and the possible path (orange)

References

De Toledo, Camille, Imhoff, Aliocha, Quirós, Kantuta. *Les potentiels du temps. Art et politique*. Paris : Manuella Ed., 2016.

Gamal Saïd, Noha. *Vers une écologie sensible des rues du Caire : le palimpseste des ambiances d'une ville en transition*. Thèse sous la direction de Jean-Paul Thibaud, Grenoble : UGA, ENSAG, AAU_Cresson, 2014. (tel-01124262)

Lapoujade, David. *Les existences moindres*. Paris : Les Éditions de Minuit, 2017.

Marot, Sébastien. *L'art de la mémoire, le territoire et l'architecture*. Paris : Ed. de La Villette, 2010.

Ricœur, Paul. *Sur la traduction*. Paris : Ed. Bayard, 2004.

Souriau, Étienne. *Les différents modes d'existence*. Paris : Puf, 1943.

Tixier, Nicolas. *Le quotidien en projets : Parcours, coupes, travellings et autres transects*. Habilitation à diriger des recherches, Grenoble : UGA, ENSAG, AAU_Cresson, 2017. (tel-01672065).

Torres Astaburuaga, Adrián, Chaudier, Éva, Tixier, Nicolas. "Mémoire du futur, from old roots to new shoots. *Patrick Geddes in India (1914-1924)*". In *Espaces et sociétés*, Dossier "Revisiter Patrick Geddes", n° 167, 2016, pp. 99-120.

Zaoui, Pierre. *La discrétion. Ou l'art de disparaître*. Paris : Ed. Autrement, 2013.

Fragile entities at work in ambiances

Understanding ambiances from the cultures and practices of the invisible

Sandra LORENZI¹

Abstract. Through her investigation of fragile entities, philosopher of science Vinciane Despret sheds new light on our relationship to the deceased. Through a relation of obligations, the dead put the living to work. The living take care of their deceased by choosing to respond to the call. Practices of memory modify, densify and colour our understanding of our living environment and create specific ambiances. Focused on the singular link of a Georgian family with their deceased, Nino Kirtadze's film, *Tell my friends that I'm dead*, enlightens the full scope of these fragile entities at work on the existing. Through this documentary, we identify the invisible chains that generate ambiances above ground and outside time. Furthermore, transgenerational psychoanalyst Christine Ulivucci conducted critical analysis showing that ambiance memories, sensitive impressions are rooted in our personal history. The encounter with familiar places or objects activates reminiscence and produces what we call: fragile ambiances.

Keywords. *Fragile Entities, Memory, Dead, House, Cult of the Dead, Transgenerational Psychoanalysis, Fragile Ambiances*

In Nino Kirtadze's film *Tell my friends that I'm dead*, (2004), a Georgian family is busy preparing the funeral of Tsotné, the clan father. In this particular region of Georgia, the living does not separate from the dead. They continue to take part in daily life: they are consulted for advice as the living dialogue with them. It is just as well known that after someone dies, the living will continue to take care of the dead. Before receiving his homage, Tsotné has to leave his hospital room to return home. His soul must find its way home too. The manoeuvre is perilous, she could get lost along the way. To guide her through the city, the family ties a thread to the hospital bed, and carefully unwinds the reel: "Come Tsotné. Sit with us in the car, don't be afraid." The car starts off, really slowly, so that the wire doesn't break. His wife and daughters are waiting for him at home. "There, you're home now."

Long relegated to the rank of folklore and superstition, the practices and cultures of the invisible return in force in the customs we know today as freed from the influences of the philosophical and progressive categories of right and wrong. To the question "does it really exist?" and to the dual perspective of "either it exists or it doesn't," philosopher Vinciane Despret favours the average path taken by the Greeks allowing correlation. According to her investigation of *fragile entities*², Despret highlight the fact that the dead continue to make the living do things. They put them to work. By answering their call, the living continues to make things through them. They hold themselves together by the milieu and by the circles in which they live. From one end to the other, the thread is held together as is the assurance that the life of the deceased will live on. An ecological relationship between the dead and the living is at work.

1. ESAAA Fine art School, Annecy Alpes, France, artist-professor, sandra.lorenzi@esaaa.fr

2. Vinciane Despret, about "Entités fragiles", public intervention at Beaux-Arts de Marseille, 15/01/2020.

From our relationships to *fragile entities* and the resulting practices and cultures of the invisible, we are witnessing a lasting transformation in our understanding of reality. These uses modify, densify and colour our living environments in an unprecedented way. In the midst of environments, ambiances are re-generated through obligations, developed outside of our “reasonable reasons.” The dead man summons me, I answer his invitation. A subtle conversation is woven between the visible and the invisible, the known and the unknown. The point here is to question in what way these practices participate in the ambiances that are being created. How can we distinguish and understand an ambiance shaped by our relationship to the invisible?

Sometimes muffled, emphatic or silent, these ambiances are held together by a thread, stretched not only between specific places, but between beings in search of the existing. We experience them long after the moments dedicated to the cults of the dead and even outside the physical or psychic spaces in which we thought they were contained. Their presence is diffused through the most protean vector of nature and human culture: memory.

If there is a culture where the memory of the dead is conjugated in the present tense, we will find it among the people of the journey, especially in the Manouche community. In his book *Nous, on en parle pas. Les vivants et les morts chez les Manouches*, ethnologist Patrick Williams studies the relationship between the Manouches and their deceased: “In the months (but it can be years - the closer you are to the deceased, the longer it lasts) following the death, the “relatives” stop mentioning the name of the deceased and do not evoke his memory, “we don’t talk about our deceased” [...] Addressing a dead person as we do a living person would be like using a mullo object without precaution. All these prescriptions are always presented and explained in terms of respect.”³

In contrast to the Georgian family, which exhorts in chorus the name of the deceased, here silence is required and silence is transmitted as a mark of respect. From then on, a different practice is at work that will take the same form as that of travelers on byroads: commemoration by subtraction.

“Whether they remain in use or are taken out of circulation, all objects that have belonged to a dead person and that have been preserved become ‘mulle’, ‘mullo’ (dead objects, objects of a dead person, dead is dead). [...] However, outside this final destination, nothing in the course of daily life distinguishes mulle objects from ordinary objects. They are, without any distinctive sign, mixed with others. [...] The silence surrounding mulle objects is only one aspect of the silence surrounding the dead.”⁴

3. Williams Patrick, *Nous, on en parle pas. Les vivants et les morts chez les Manouches*, in *Ethnologie de la France*, n°13, Éd. de la maison des sciences de l’homme, 1993, pp. 8-9: “Dans les mois (mais ça peut-être des années - plus on est “proche”, plus ça dure longtemps) qui suivent le décès, “les proches” cessent de prononcer le nom du défunt et n’évoquent pas son souvenir, “nos défunts, on n’en parle pas”[...] S’adresser à un mort comme on s’adresse à un vivant, ce serait se servir sans précaution d’un objet mullo. Toutes ces prescriptions sont toujours présentées et expliquées en termes de respect.” (translation SL)

4. *ibid.* pages 6 and 7: “Qu’ils restent en usage ou qu’ils soient retirés de la circulation, tous les objets ayant appartenu à un mort et conservés deviennent “mulle”, “mullo”(des objets morts, objets d’un mort, des morts, c’est mort).[...] Cependant, hors de cette destination finale, rien ne vient distinguer, dans le cours de la vie quotidienne, les objets mulle des objets ordinaires. Ils sont, sans signe distinctif, mêlés aux autres. [...] Ce silence qui entoure les objets mulle n’est qu’un aspect du silence qui entoure les morts.” (translation SL)

To remove a deceased person's possessions, from his name to his objects and places of life is to ensure that no one can disrespect him and take the risk of disturbing him in death. Presence through absence, silent remembrance over permanent prayer, are favoured : "There is indeed a Gypsy memory, but it is a memory that does not make speeches, a memory that does not aim at exploring the past and accumulating knowledge."⁵

Mullo incarnation takes place in the daily life environment. The couch in the living room on which no one sits - because the deceased cousin had a similar couch⁶ - the dog who sleeps under the caravan mixed in with the other dogs...The *mullo* dog, the *mullo* couch stand off-camera to cast a different light on reality. They no longer belong to the conventional time that punctuates the unfolding of a day. In this particular space-time, subordinate to the attention of those who know and remember, their use and presence is cancelled. There is a correlation between living beings, objects, places and things. We understand them as other types of *fragile entities*, fragile because they are dependent on a lively and careful memory that, while avoiding names, grants an inextinguishable respect to its dead. Sown in houses, caravans, gravel yards, they connect to our capacities of reminiscence which become, both through conscious (in the case of the *mullo*) and unconscious work, a trigger of ambiances. In this sense, could we speak of *fragile ambiances*, or of memories of ambiances? How do these ambiances found our relationship to reality?

Like the needle of a compass oscillating with the movement of our body, our feelings and imagination are directed by the emergence of reminiscences at the discovery or rediscovery of familiar context. A subjective and singular path is also in motion, oscillating between the reality of the impression and the vagueness of its attachment.

"Sometimes it is not real place that reappears, it is rather a memory of atmosphere and spatial configuration that is transmitted. We find ourselves in the same style of house, village, country as a distant ancestor."⁷

The analysis of the transgenerational psychoanalyst Christine Ulivucci on the psychogenealogy of living places enlightens us on this point : we must not neglect "*les transmissions inconscientes d'ambiance et de configuration sur plusieurs générations*."⁸ [...] *Certains lieux dégagent une mémoire de vécu qui nous rend familiers et nous relie à un épisode de l'histoire de nos ancêtres*."⁹ Les lieux nous font signe, tout comme les meubles et les objets. "The unconscious transmission of ambiance and configuration over several generations. [...] Certain places give off a memory of life that makes them familiar to us and connects us to an episode in the history of our ancestors." Places beckon to us, just like furniture and objects. "Like threads running through the generations, furniture and objects act as witnesses and passers. [...]"

5. *ibid.* page 14: "Il existe bien une mémoire manouche mais c'est une mémoire qui ne fait pas de discours, une mémoire qui ne vise pas à l'exploration du passé et à l'accumulation de connaissances." (translation SL)

6. Here a "mullo" transfer takes place from one object to another. I notice that this story concerns another community of travellers.

7. Ulivucci Christine, "Psychogénéalogie des lieux de vie, ces lieux qui nous habitent", éditions Payot & Rivages, Paris 2008, page 22

"Parfois ce n'est pas le lieu réel qui réapparaît, c'est plutôt une mémoire d'ambiance et de configuration spatiale qui se transmet. On se retrouve ainsi dans les mêmes styles de maison, de village, le même pays qu'un ancêtre éloigné." (translation SL)

8. *ibid.* page 22.

9. *ibid.* page 23.

Objects live, pass from hand to hand, disappear, reappear, remain in our memories and remind us of people and places. [...] Sometimes an object, or even the memory of an object, is enough to remind us of a person, a house.”¹⁰

These memories of ambiances are spread through our living places and our habits and customs. They become sensitive ambiances expressing themselves through the strata of our present. We sometimes experience them as a vague impression when the memory is not yet conscious. We also welcome them with joy when they arouse the memory of a happy moment. Whether they are linked to the cult of the dead, or to a lighter episode in the life of an ancestor, they put us to work on memory. And it is because we are beings of memory that they exist for us. Just as correlation underpins the relationship between *fragile entities* and the living, so correlation underpins the relationship between *fragile ambiances* and memory.

In the light of these studies, we can name *fragile ambiances*, ambiances that put us to work on the existing through the vector of memory. The recognition of this fragility is not a weakness. It is up to us to feel it as a living and active force within ourselves. It is up to us to fan it in consciousness like an ancestral and comforting fire: the hearth of our home, where these ghosts and *mullo* are also the multiple expressions of our being.



Figure 1. Nino Kirtadze, “Tell my friends that I’m dead,” 2004

10. *ibid.* page 222: “Comme des fils conducteurs à travers les générations, les meubles et les objets font office de témoins et de passeurs. [...] Les objets vivent, passent de main en main, disparaissent, réapparaissent, restent dans les mémoires et nous rappellent des personnes et des lieux de vie. [...] Parfois il suffit d’un objet, voire du souvenir d’un objet, pour se remémorer une personne, une maison.” (translation SL)



Figure 2. Elodie Fradet, “Repérage pour La ptit’ fradette”, 2020

References

Ulivucci, Christine. *Psychogénéalogie des lieux de vie, ces lieux qui nous habitent*. Paris : Éd. Payot & Rivages, 2008.

Williams, Patrick. “Nous, on en parle pas. Les vivants et les morts chez les Ma-nouches”. In *Ethnologie de la France*, n° 13, Paris : Éditions de la maison des sciences de l’homme, 1993.

Movies

Élodie, Fradet. *Repérage pour La ptit’ fradette*. 2020.

Nino, Kirtadze. *Tell my friends that I’m dead*. 2004.

Three Avant-Garde Masterpieces: Atmosphères, Aura, Stimmung

Can Music Suggest an Original Interpretation of These Themes?

Giuseppe GAVAZZA¹

Abstract. Thinking about the predictable in-presence 4th International Congress on Ambiances 2020 I wrote: "I will propose to the listener some significant fragments of these three compositions to trigger a discussion that will focus on the core of my intervention: single-word titles that have implications that reach far beyond mere musical fact. My question will be: 'Can music offer an original interpretation of these themes suggesting new research perspectives?'" An unpredictable situation forces to rearrange the sequence: the proceedings will precede the other actions. My question remains and, since I am a composer, I feel comfortable purposing this text as the draft of a score. A score is an imagined memory of a musical event to come. I propose here a two steps participative process: a de-composition and a re-composition.

Keywords. *Atmosphères, Aura, Stimmung, Participatory Music Project*

Introduction

"In the beginning there were only sounds which, little by little, transformed themselves into matter"² (Schneider, Marius).

Analysis comes from the ancient Greek ἀνάλυσις, *analuō* (unlink) and ἀνά of *ana* (top) and λυσις *luein* (release).

Etymology: term derived from two Greek verbs meaning solve, untie, break, de-compose. *Synthesis*, from the Greek σύνθεσις *synthesis* (join, compose), is an operation of the rational mind inverse of the analysis, by which it gathers in a homogeneous whole, various elements from a field of knowledge.

The *analysis* is a method that is opposite to *synthesis*: it aims at understanding an object by decomposing it into its components. So, it must first establish criteria to identify the components.

Several disciplines and techniques use the word *synthesis* to refer to an artificial product, deemed synthetic or synthesized, or even a manufacturing process.

Analysis and synthesis are the two poles of various processes. Music analysis has, as the object of its research, musical compositions: composition comes from the Latin *cum ponere* (put together). To compose therefore means collect, combine, synthesize sounds. The word synthesis is generally associated with electronic music; a frontier between

1. *Composer, Professor of Elementi di Composizione per Didattica della Musica and member of board of Dipartimento METS, Conservatorio Superiore di Musica G.F.Ghedini di Cuneo. Permanent Researcher AAU CRESSON, Grenoble. Composer in residence ACROE-ICA Grenoble. gavazza.g@grenoble.archi.fr*

2. 'All'origine vi erano soltanto dei suoni che, a poco a poco, si trasformarono in materia.' p.85. Personal translation.

the fertile lands of art, science and technology where analytical theory and analysis techniques are closely interconnected. An acoustic analysis is, to a certain extent, the micro-formal analysis of a sound. Finally, each musical composition is nothing but a sound: a long, complex, articulated and organic acoustic event organized for artistic/communicative purposes.

Analysis as De-Composition

I will not enter into analytical details: these three masterpieces have been extensively analyzed. Seminal works, I analyzed them during the course of my studies, and I interiorized the analysis through listening memory: sound and form are one. Luciano Berio said: “The best way to analyze a score is to compose a new piece”³. “The reasons for the *oeuvre* are already in the *oeuvre*, including all possible ways to show the need, to analyze the technique and the sign”⁴ (Debray, 2014).

Let me go to the limit: the only possible analysis of a work is the work itself.

I will start with my listening, trying to narrate, in an analogical and synthetic way, my perceptions and inviting you to an open listening, in the spirit of what Terence McKenna calls: “The felt presence of direct experience”⁵.

Synthesis as Re-Composition

I listen to these three compositions as the perfect exemplification of how it is possible to intend music composition not so much as composition with sounds but as the composition of a sound. “One of my early desires as a musician was to sculpt and organize the sound material directly, so as to extend compositional control to the sonic level, to compose the sound itself, instead of merely composing with sounds”⁶ (Risset, 1990).

The three compositions are:

- *Atmosphères*, for large symphonic orchestra, György Ligeti, 1961;
- *Aura*, for large symphonic orchestra, Bruno Maderna, 1967;
- *Stimmung*, for six voices and six microphones, Karlheinz Stockhausen, 1968.

The exploration of electronic music began in the second half of the 1950's: Stockhausen founded the *Studio für elektronische Musik des Westdeutschen Rundfunks* in Cologne, where Ligeti worked during the years of composition of *Atmosphères*. In Milan, Maderna and Berio founded the *Studio di fonologia musicale Rai*. These three compositions show how the electronic experience influenced instrumental and vocal writing. *Atmosphères* and *Aura* were composed for large orchestras in which the traditional subdivision into sections is transfigured: each instrument becomes a sound generator in a dense and varied texture, functional to the construction of a composite and composed sound. *Stimmung* uses voices that employ unusual vocal techniques: the amplification of single voices allows the spatial diffusion over several speakers. The microphone-speaker chain is conceived as a musical instrument in itself, adding space to the other compositional dimensions.

3. A personal memento of a dialogue.

4. ‘Le ragioni dell’opera sono già nell’opera, compresi tutti i modi possibili di mostrarne la necessità, di analizzarne la fattura e il tratto.’ Personal translation.

5. McKenna, Terence. *Reclaim your mind*. Accessed June 21, 2020.

<https://www.youtube.com/watch?v=-eu9GfHCpVo>

6. Risset, Jean-Claude. *Computer music: why?* Accessed June 25, 2020.

https://www.utexas.edu/cola/insts/france-ut/_files/pdf/resources/risset_2.pdf

In the newborn forges of electronic music, the new instruments offered unheard sounds but they were scarce and of limited capabilities. The authors applied the principle of 'to compose the sound itself, instead of merely composing with sounds' to the most versatile and well-known accessible instruments: the orchestra and the human voices.

Atmosphères

In 1956, György Ligeti escaped from Hungary and reached Austria: interested in the new musical perspectives of electronic instruments, he collaborated with the *Studio für elektronische Musik des Westdeutschen Rundfunks* in Cologne. This studio experience, more than the experience of the few electronic pieces he composed, had a fertile impact in the instrumental writing of which *Atmosphères* is the first dazzling example. Composed and performed in 1961 the piece calls for a large orchestra, fragmented according to a technique he called *micropolyphonic texture*. The orchestra, split in almost a hundred real parts, becomes a system of sound generators. Each instrument has its own part written in counterpoint with the other instruments: a reticle of rapid notes, rhythmically and melodically complex, which build a dense and whirling sound texture evolving in time following a compositional shape.

Under a compact sonic surface, thousands of frantic micro-sounds built the material density of the music, generating an aural texture. They are atoms of matter, insects of a swarm, fish of a shoal, a flock of birds changing shape, becoming a single expressive body. Droplets of a spring that grows, continues as a placid river, becomes tumultuous in a tight gorge of smooth rocks, throws itself into a waterfall, slows down in hourly and anti-hourly whirlwinds which slide, blend, intersect in a seemingly placid lake sliding towards the sea. Listen to the breath of nature, to the elusive voices of precision machinery. Clocks and clouds. The molecules penetrate the earth, soaking grass and moss, enter the veins of the trees, quench the thirst of the animals, rest for centuries in dark underground caverns. Cycles are repeated, with a geological rhythm. They evaporate and come back upwards to draw clouds floating in the sky: fluffy cumulus, cirrus blades in the stratosphere, dark of waterfalls of a thunderstorm, of light and hazy rain that cloud the view, flake in snow crystals, frozen in opalescent blocks that tell us thousand-year-old stories. Endless energy is exchanged between the molecules that collide and find common flows.

The motion delays, calms down, a quasi-silence falls, a night of subtle voices and murmurs, which prepares the rebirth.

Aura

In *Aura*, we have a large orchestra that does not hold back an unspeakable desire for singing. A poignant communicative tension vibrates: melody⁷ becomes a meta-melody, a melody of melodies; web of expressive lines, which cancel each other out, intertwine, emerge in fragments. They are a thousand voices of the forest in which each voice launches its own message which becomes inextricable. The tension of this crowd of voices is more lyrical than any single voice: it is a powerful and new expressive lyricism. A new consonance of voices, a renewed counterpoint that tends to infinity,

7. I give to the word melody a larger sense we can find in Arnold Schönberg's definition of *Klangfarbenmelodie* and the one we can read in Messiaen: "The melody is the point of departure. May it remain sovereign! And whatever may be the complexities of our rhythms and our harmonies, they shall not draw it along in their wake, but, on the contrary, shall obey it as faithful servants; the harmony especially shall always remain the 'true' which exists in a latent state in the melody, has always been the outcome of it." (Messiaen, 1956, p. 13).

rise towards high-pitched sounds, to the sky, the stars. Sounds of bowed or plucked string instruments. The percussion is soft, woody, metallic, dry, resonant sounds. They are voices of nature with their echoes, shadows, reverberations. Sounds of wind, wood and metal instruments that accumulate, thin out, add up again in a tumult of signals. Sudden sounds, rings, flashes of distant thunderstorms, branches that break and slide to the ground. Noises of human work: a workshop of a hundred craftsmen with their instruments. Rings, sirens, voices of fighting animals come back: we shall start again. Aerial islands of high-pitched, medium, aquatic, low, deep, telluric sounds: everything calms down.

Several cycles are repeated: different answers give an ever-new sense dialogues. The voices of trees are moved by more forces than just the wind: terrestrial animals, large, small, microscopic: squirrels, insects, fungi, lichens, underground micro-organisms, cells. Other invisible but audible living creatures. And then the mineral world and the inanimate elements, animated by sound. Now we hear the voice of the lagoon with its reflections. We listen to the city and the city listens to us: comments, whispers, unpredictable stratifications, fragments, which come and go at different distances and depths.

The musical writing of the score is extremely structured, divided into several short sections that return, repeat in mirror, come back not identical but identifiable. There are phrases, breaths, cycles, voices, interruptions, repetitions, returns...

Alea: at the end, a page of fragments without key or instrument indication. Reminiscences of melodies, fragments, remain to grow, to develop, to reflect. A flute stands alone to sing, to launch its unanswered question.

Stimmung

The open notation score is a role-playing game based on a *Formschema* founded on the harmonics of B flat note. On infinite articulations of this spectrum an atmosphere is created: a single sound lasting over one hour. The *Formschema* defines 51 sections that specify which of the harmonics of the specter is to be sung. Four elements, six pages of syllabic patterns, six pages of magic names and a page of poetry. Magic names are deities from all over the world and days of the week. In the beginning, from the silence, the harmonics of the fundamental arise: each singer warms up the voice. The vocal techniques are explorations that include phonetic articulations of languages and overtone singing mediated by ancient traditions. Stockhausen wrote: "After a singer has 'called' a Magic Name, it is cyclically repeated [...] until it is finally incorporated into the currently dominant model inducing a reaction in which there is a perceptible change of atmosphere"⁸. *Stimmung* is a radical work that mixes sacred, profane and intimate experiences. In that period the composer was in Mexico walking through ancient ruins, sitting on stones to observe the proportions of architecture and landscape, becoming "a Maya, a Toltec, a Zatopec, an Aztec, or a Spaniard. I became the people" (Cott, 1974).

While playing with his children, muttering phonemes, words and phrases, he realized that the voice is an instrument and the body is a sounding board. "A good magician must be a good singer. [...] capable of reproducing all the sounds of nature. All it needs is for him to leave his mouth wide open and behave like the god evoked, for these to penetrate into him, to embody the movements of his dance and sing to him through his mouth. [...] musical instrument of the god who has invaded him" (Schneider, 1992, p.72).

8. Cott, Jonathan, accessed June 25, 2020. <http://homepage.eircom.net/~braddellr/stock/index.htm>

Whispers (*atmos*), voices, words, phonemes, morphemes, magic words: *Grogoragalli, Vishnu, Enion, Usiafo, Alleluja, Budda, Tangarao, Uranos, Isis, Piperipipi... Mary* (which is also the name of Stockhausen's second wife).

The first cognitive act is a sonorous imitation: by appropriating sound we can access the meaning. The name of God is invoked to evoke him: the child evokes things by pronouncing them. Fixity and movement: the harmonic stillness requires a huge phonetic mobility of timbre. The fundamental B flat opens like a prism opens a white light in a range of colors: each note is a color which generates its own spectrum, dissonant with the basic harmony.

Ritual music tunes performers with listeners and requires a long time: gradually the performers warm up their voice and the listeners warm up their ears. It is necessary to dig and be dug by sounds. Immerse ourselves in sounds as if they were an endless acoustic landscape. Each voice is amplified and diffused in space⁹: the listener enters the body of sound, becomes part of it.

Everyone reaches the D note and "that" *Stimmung* ends.

Listening

Listen to these three unique sonic events, as you would listen to a square, a desert, a forest on which the wind blows, a sunny street on market day, an empty stadium, a crowded theater, a rainy alleyway at night, the voices of animals, people, cars, water and air, a radio noise, our footsteps and our body that resounds with all. Listen to a sandy beach or a rocky coast with stormy water, to a calm shore, to a clod of grass that slowly dips into the deep waters of a gloomy lake. Imagine how you would hear the world hanging from a cloud or soaring like a seagull, an eagle, a glider. How does a whale listen to the depths of the ocean? Or an amphibian a black cave in the heart of the Earth?

Listen as you would listen to a soundscape: listeners/interpreters, moving, open new perspectives: we turn at the corner of a street, we cross a bush, a bus, an animal, a passerby passing by; the wind blows. We slow down to the echo of a well and stop at the ticking of a pendulum; here is a passage where an indecipherable mechanical sound comes from a little open window: or maybe it's an animal? We are near a spring, an underground waterfall, a gorge of rocks where the wind sings: but maybe it is not the wind!

Glittering sounds, like birdsong or metallic tinkling: gloomy and telluric voices; punctual sounds: a woodpecker, a carpenter's hammer, a child playing, the buzzing of a dying neon.

Re-Composing

Now I propose two collaborative actions to put together words and sounds.

Words: after listening, write down your personal interpretation of the words *Atmosphères, Aura, Stimmung*. I am curious to read your comments and will use these suggestions as sparks for future dialogues.

Sounds: I invite you to select fragments, lasting between 30 and 100 seconds, extracted from some of the numerous recordings available of the compositions. I will use these fragments for a collective 'granular' re-composition for a concert or an installation.

9. At the Osaka World's Fair, in 1970, *Stimmung* was performed 72 times in a 550 seats spherical hall, with 50 speakers that allowed a spatial movement of the sounds.

Record the selected audio files or send the references for online audio/video files.

For example:

Aura: <https://www.youtube.com/watch?v=Y9fwwDnTW6c> from 3'44" to 4'33"

Please send this material to my email address: gavazza.g@grenoble.archi.fr

Many thanks for your contribution!

“The things I’ve done don’t interest me anymore. Only what I haven’t done yet interests me”¹⁰ (Savinio, p.393)

References

Cott, Jonathan (edited). *Stockhausen-Conversations with the composer. 64-67*

Robson, London. 1974. Accessed June 25, 2020.

<http://homepage.eircom.net/~braddellr/stock/index.htm>

Debray, Regis. *L'ardore del fuoco*, in *Michel Serres*, 118-121. marcos y marcos, Riga 35. Milano, 2014.

Messiaen, Olivier. *The technique of my musical language*. Translated by John Satterfield. Alphonse Leduc, Paris, 1956.

Risset, Jean-Claude. *Composer le son: expériences avec l'ordinateur. 1964-1989*. Contrechamps XI, 107-126. Editions l'Age d' homme. Genève, 1990.

Risset, Jean-Claude. *Computer music: why?* Accessed June 25, 2020.

https://www.utexas.edu/cola/insts/france-ut/_files/pdf/resources/risset_2.pdf

Savinio, Alberto. *Ascolto il tuo cuore, città*, 393. Adelphi, Milano, 1984.

Schneider, Marius. *La musica primitiva*, Adelphi, Milano, 1992.

10. ‘Le cose che ho fatto non m’interessano più: solo quello che ancora non ho fatto m’interessa’. Personal translation.

14

SOUND STAKES OF THE ATMOSPHERE

15

THE WAY OF AMBIANCES: SCIENTIFIC
PRACTICES, ARTISTIC PRACTICES

16

WHAT PLACE FOR AMBIANCE IN THE
URBAN RENATURING PROCESS?

What Place for Ambiance in the Urban Renaturing Process?

Session 16 – Introduction

Emeline BAILLY¹,
Sylvie LAROCHE²

The city and biodiversity are struggling to make an alliance. The city offers only a small diversity of environments and biodiversity by artificialising the soil, by controlling urban nature in dedicated spaces (parks, ornamental gardens, the surroundings of buildings and roadsides), by reducing it to recreational or decorative functions (landscaping, planting and flowering, etc.).¹²

With the environmental and climatic issues, the services provided by nature are being rediscovered (CO₂ absorption, island of freshness, rainwater recovery...). Newly developed neighbourhoods, particularly eco-neighbourhoods, are deploying nature for its ecosystem services. They are adorned with gullies, permeable soils, green roofs and facades, etc. However, this view of nature reduces it to a function. Biodiversity in the city calls, in our view, for a broader alliance between the city and nature to improve ecological quality and urban life. Our hypothesis is that natural environments are part of the basis of human pleasure in places, i.e. their sensitive relationship with the environments inhabited by humans and the fauna and flora.

In cities, nature is increasingly perceived, appropriated and desired as a medium for strolls, recreational practices and the sensorial, emotional enjoyment that comes with imagining being in such locations. It encourages the creation of milieus and habitats for non-humans. It thus can contribute to improve the urban, ecological and sensory qualities of urban spaces for humans and non-humans.

We inhabit the city with our senses, and they charge the places with the multiple meanings and affects that we confer on it. This is what we call the sensitive city (Bailly, 2018). This sensitive city is, in our opinion, a key to the ecological city and, more broadly, “biodiverse,” to use Philippe Clergeau’s expression. (2015). Thinking about the sensitive city therefore implies placing the individual at the heart of the urban fabric and questioning the basis of his or her positive or negative perception of inhabited, natural and built places.

This session aims to question the ways in which the concept of architectural and urban ambiances allows us to develop sustainable life conditions for living beings and to encourage different forms of coexistence between humans and non-humans. It also aims to question the ways in which it encourages urban quality by creating environments that foster the pleasure of being in a place.

1. C.S.T.B.

2. C.S.T.B.

Nature, the Key to Urban Feelings?

Nature offers a filiation with the sensitive world, through the sensations and feelings it promotes, the imaginations it arouses. It appeals to our five senses (the smells of the earth, the sounds of rustling water or leaves in trees, the touch of foamy, earthy materials on the ground, views of the sky, the taste of sandy, marine or other dust...). It inspires both positive and negative affects such as water which can inspire calm, appeasement but also the fear of drowning. Gaston Bachelard (1942) speaks of material imagination, that is, this perception in the articulation of reality, symbolic representations and images. Natural elements (water, earth, air, etc.) evoke, for example, various groups of images, which are themselves sources of sensations and affects. For example, the image of the earth can evoke the roots (and its anchoring in this place), the nourishing earth, death and the cycle of life (birth of seeds, decomposition of dead leaves...).

Nature also reveals an emotion of the world that is beyond us. It is nature as a force that engenders, that creates the living, as the Latin origin of the term *natura* (Littre Dictionary) reminds us. It introduces the link to the living, to the cosmos, to our earthly home as Thierry Paquot would say (2005). It is imbued with cosmogony (relationship to the earth, to the living, to the universe...) and poetics (dreaming of one's presence on earth, one's collective life to better project oneself towards death). Natural environments, like built environments, thus inspire meanings and, more broadly, sensations, affects and imaginations. They then raise the question of the links between nature and the spaces developed to reconnect with the sensitive dimension of cities.

Rather, the construction of urban spaces was built by opposing the city, a place of civilization, and the countryside, a place of nourishing nature or immersion in the landscape. With urban sprawl and the height of the urban perimeter, this distinction has lost its meaning. The challenge of a new alliance between the city and nature arises to promote biodiversity, ecological environments and reconnect with human sensibilities.

In fact, with this split city / countryside, civilization / wilderness, the experience of nature in the cities has faded away, reserved for excursions outside the city, or for indirect sensations (Bailly et al., 2019). While cities, especially since industrialization, tend to deny the relationship to the existing site and natural environment, nature recalls this indirectly through the play of topography, the presence of water, the play of light and shadow, the variations in climate... It thus experiences nature indirectly even if the experience of nature has become distorted (Fleury and Prévot, 2017). In fact, today, there is a growing demand for nature among city dwellers.

Restoring a relationship between humans and their living environment seems key to us. If urbanised space has taken the place of the city (and its capacity to make a city, a community) and if it has become the dominant living environment for people, city-dwellers aspire to the pleasure of being, strolling, experiencing, meeting and acting in the spaces where they live. We therefore believe it is necessary to give back a sense and possibilities of nature experiences to metropolitan territories and the multiple places that make them up by playing on the urban and natural alliance. Ecological urban planning can then be a lever for biodiversity, for urban adaptation to climate change, and even more so for the desire of city dwellers to feel, feel, imagine and experience their place of life.

Urban Nature Ambiances: Nature Experiences and Possible Co-Existence Between Humans and Non-Humans

Among these links between nature, planning and urban sensitivities, The stakes involved in climate change call for the development of new renaturing policies to adapt urban spaces to hazards. Indeed, nature (or a natural solution) and the redevelopment of ecosystems offer perspectives regarding a more lasting territorial resilience than many grey infrastructures. Renaturing metropolises, i.e. humans' main environment, can also foster the urban quality of developed spaces. In this context, focus will be specifically placed on renaturing projects that aim to reconcile urban and natural potentials in metropolitan areas.

We can observe two types of renaturation projects. According to Pierre Pech (2015), this could be “*In the first instance, renaturalisation is an ecological process following on from a phase of anthropisation or artificialisation, as for instance in the case of abandoned brownfield sites. In the second, there is a development project, particularly in urban settings, aiming to provide for a participation of natural elements in the overall effect, or indeed for a contribution to the functioning of the urbanised system*”. These projects can be developed on a micro scale, such as the actions carried out by the Depave association in Oregon, which aim to remove asphalt surfaces in schoolyards, alleyways or car parks in order to reduce the pollution of run-off water and increase the amount of land available for the restoration of habitats for fauna and flora. Renaturation projects are also carried out on the scale of large territories, with projects to clean up abandoned land and its possible conversion into landscaped parks, such as the Kodak wasteland (13 hectares), located on the banks of the Ourcq canal in Greater Paris. Finally, they can also be applied on a metropolitan scale with projects to enhance the value of urban nature, such as the green corridor of the capital Beijing, or Copenhagen, which since its Finger Plan has continued to link the city to nature until today with its climate plan and its major natural renewal project, which wants all the inhabitants of the Danish capital to be able to walk to a large green space (parks, nature reserves, etc.) and aquatic space (inlets penetrating the city). If these various renaturation projects are often cited as references in terms of the creation and enhancement of natural spaces with high ecological value, the experience by humans and non-humans of this urban nature is little questioned. Thus, how does the development of ecological rehabilitation projects integrate and encourage the development of more qualitative sensitive experiences? How can the consideration of architectural and urban ambiances enable an influence on ecosystems?

Currently, the consideration of ambiances in renaturation projects is mainly aimed at limiting artificial light pollution (Longcore, Rich, 2014) and acoustic pollution (Watts, 1999). Different approaches, such as those carried out for the development of green, blue and black frames, aim to preserve biodiversity in land-use planning policies. More specifically, renaturation projects also seek to take into account climatic ecological effects in order to disperse air pollution and limit urban heat islands. (Melaas E. et alii, 2016). These approaches make it possible to assess the impact of environmental nuisances on ecosystems, but they do not take into account sensory phenomena and the dynamics of environmental production by living organisms (both humans and animals practise, speak, partially mask the environment and ultimately modify it). The approach proposed by architectural and urban ambiances invites us to consider the sensitive configurations perceptible and produced by the living as a set of sensations

participating in the specific creation of an atmosphere, or even its quality³. Thus, the spaces built or managed by renaturation projects can be the object of temporary investments through spontaneous commitments such as squatting or artistic installations (Bailly, 2016), becoming anxiety-provoking and repulsive universes, especially at night and in winter. However, it should also be noted that in these places, the energy and vitality of nature can also be considered essential and as a need for people, who attribute to them a well-being and a possible fullness. Breathing spaces are created in the city and near their homes or workplaces. A network of open spaces (Fleury, 2014) is formed, where the sensory synthesis of the different stimuli, the intensity and diversity of uses that can vary considerably in space and time reveals the attachment and anchoring of the inhabitants to this type of territory. These multiple experiences are thus revealing the specific atmosphere and landscape in the city, which brings a new way of looking at nature, especially for its sensitive essence.

Towards an Ecological and Sensitive Urban Design

In our opinion, this ecological and sensitive urban design is key to approaching another, more ecosophical society (i.e. a “wisdom of inhabiting,” from the Greek *mokos*, (house, natural environment) and *Sophia*) that puts Human back in the ecosphere and no longer at its peak (Naess, 2017). Felix Guattari (1989) stressed the importance of linking three ecologies (environmental, social and mental) to reinvent individual and collective existential territories, linking humanity and the biosphere.

This ecosophy could also, in our opinion, be linked to a form of ecology of the sensible. It will make it possible to meet the unprecedented challenges of biodiversity and the adaptation of cities to climate change and to lay the foundations of a new model of society combining the city and the living, the individual with his sensibilities, and man with his living environment.

This alliance could take shape thanks to urban renaturation projects promoting natural spaces accessible to humans and non-humans, sources of sensitive experiences and singular atmospheres. Linking these different spaces together could create a network of living spaces for the living that irrigate the metropolis and penetrate the built environment and networks of places with multiple unique ambiances, enriching the urban environment. This posture is based on the notion of “reliance” defined by Edgar Morin and taken up again in the “urban metaphor” proposed by Chris Younes (Younes, 2015): “reliance is “the work of links,” “*the act of connecting and relating and its result.*” This approach calls for urban places to be managed in symbiosis with the living in order to “*resist the exhaustion of environments and people, through creative urban planning based on links rather than fracture, activating the capacity of an environment to open up possibilities between nature and culture, between local, translocal and global*” (Younes, p.58, 2015).

This urban, ecological and sensitive conception is presented in the two papers

3. *Within the framework of research on edges and urban landscapes (Bailly et al., 2020), a C.S.T.B. team (E. Bailly, S. Carré, J. Defrance, S. Laroche, C. Martinsons and M. Sabre) identified specific atmospheres between natural and developed environments in the metropolis of Greater Geneva. It was noted that climatic ambiances have a “mitigating role” in the extreme effects produced by climatic hazards by creating islands of coolness that irrigate the metropolitan fabric. Daytime lighting ambiances have a regulating effect on sunshine in the sense that places are sunny in winter and shaded in summer. Sound ambiances produce softer, calmer territories, with a sound identity mixing natural and urban sound. Finally, the perceived ambiances of urban edges can provide people with a resourceful ambiance and a metaphorical potential that allows them to project themselves into other real or sometimes even imaginary places.*

attached to the session, which highlight the multiple spatial singularities and variations in ambiances formed in renaturation projects. The first article, by Frederic Bell and Gwenaëlle de Kerret, focuses on urban linear parks projects in Paris, New York and Seoul. The analysis of mobility and seating spaces reveals the physical, sensitive and metaphorical links between these high-rise parks and the surrounding built environment. The second article, by Maroua En-Nejjari, focuses more specifically on spontaneous urban beach situations. This body scale approach allows us to question the qualities of this urban nature located at the interface between the water and the dense neighbourhoods of Nantes and Toulouse.

References

- Bachelard G., 1942, *L'eau et les rêves, essai sur l'imagination de la matière*, Paris, Librairie José Corti
- Bailly E., Laroche S., Finger A., 2020, *Lisières et paysages urbains*, rapport de recherche Interreg, CSTB, Hepia, Asters (2017-2020), Genève.
- Bailly E., Marchand D., Maugard A., 2019, *Biodiversité urbaine, pour une ville vivante*, Paris, Ed PC.
- Bailly, E., 2016, Franges intra-urbaines à l'épreuve des projets de paysage, *Projets de Paysage*, n°13, Paysages des franges urbaines en projet, janvier, [en ligne]
- Clergeau P., 2015, *Manifeste pour une ville biodiversitaire*, Paris, éditions Apogée.
- Fleury C. Prévot A.C. (dir), 2017, *Le souci de la nature*, Apprendre, inventer, gouverner, Paris, CNRS Editions
- Fleury A., 2014, Les périurbains et leurs espaces publics : enquête sur les franges nord de la métropole parisienne, *Cybergeog : European Journal of Geography* [En ligne], Espace, Société, Territoire, n° 841.
- Guattari Felix, 1989, *Les trois écologies*, Paris, éditions Galilée.
- Longcore T., Rich C., (2004), Ecological light pollution, *Frontiers in Ecology and Environment*, pp 191- 198
- Melaas E. K., Wang A. J., Miller D. L. and Friedl M. A., (2016), Interactions between urban vegetation and surface urban heat islands: a case study in the Boston metropolitan region, *Environmental Research Letters*, 11, 5
- Naess A., 2017, *Une écologie pour la vie, Introduction à l'écologie profonde*, Paris Seuil.
- Paquot T., 2005, *Demeure terrestre, enquête vagabonde sur l'habiter*, Paris, European.
- Pech P., 2015, Renaturation, *Hypergeo*, [en ligne]
- Watts G, Chinn L, Godfrey N. (1999), The effects of vegetation on the perception of traffic noise. *Appl Acoust.* 56, pp 39-56
- Younes, C., 2015, Métamorphes in Morphogène et dynamiques urbaines. Les ateliers de morphologie, EHESS -EnsAD, coord. par Franceschelli, S., Gribaudi, M., Le Bras H., pp. 54-62

Ambulatory Ambiance

A Comparative Analysis of Three Elevated Linear Parks

Fredric BELL¹,
Gwenaëlle DE KERRET²

Abstract. This paper analyzes the atmospheres of ambulatory pathways. Differences between promenade and seating, hardscape and nature, and new public art juxtaposed with residual industrial legacy, create opportunities for choice. A privileged view outward to the city can conflict with a protected simulation of a walk through a forested allée. What are the common features of design and the concerted resulting ambiance that distinguish the Promenade Plantée in Paris, Seoulo 7017 in Seoul and the High Line in New York How does renaturation and design by nature create urban islands of calm for people? The answers are in the complexity of interaction of the different design elements.

Keywords. Linear Parks, Renaturation, Design, Experience, Semiotics

Introduction

Along with other examples of elevated parks across the world, the High Line in New York, the Promenade Plantée in Paris, and Seoulo 7017 build unique ambiances that enhance how varied the experiences of an urban park can be. Each share attributes of community connectivity and adaptive reuse in a post-industrial environment.

Our hypothesis is that coordinated urban design can elicit specific attitudes and emotions. Linear parks in New York, Paris and Seoul balance active design principles that encourage physical activity with the shaping of urban oases of calm and renaturation. Cities use these elevated parks to redefine civic pride and foster cultural identity through narratives that incorporate strands of history, entrepreneurship, art, and amenity.

The delight visible in the three linear parks here analyzed is in the complexity of interaction of the different design elements and even with each other across time and distance. The design of the Promenade Plantée influenced the subsequent planning of the High Line. The High Line gave a model to Seoulo 7017. At all three, several aspects of the design need to be taken into account to analyze the ambiance of the park. These include the renaturation program, the industrial vestiges, the views to the surrounding city blocks, the seating, and, most importantly, the flow of movement of the people using the parks. As Nathalie Sarraute wrote in *Le Planétarium* (1959): “Tout dépend de l’ambiance, tant de choses entrent en jeu” (“It all depends on ambiance, so many things come into play”).

1. Columbia University - Center for Buildings, Infrastructure and Public Space, New York City, US, fmb12@columbia.edu

2. SemioTiPS and Paris V University, Paris, gdekerret@semiotips.com

Comparing the specific ambiance of each ambulatory park suggests consideration of three viewpoints. First, that of governance: what were the intentions of decision-makers (politics, neighborhood associations, urban designers), what experience and ambiance did they intend to convey? Second, that of the users: how do people coming to discover and enjoy these parks, perceive, and use the place?

Thirdly, that of the signs themselves: how do all the visual, spatial and sensorial elements contribute to build a specific atmosphere and a unique experience?

Our research method on the three parks, conducted starting in 2017, relied on the method of Eliseo Veron about museum visitors (1983). It combined analysis of program, looking at traditional sources (press releases and websites), along with ethnographic observation of users (how people behave); with a specific focus on rhythms, attitudes and collective flows. Finally, a semiotic analysis was conducted to understand how the relationship of prior industrial signs with renaturation design participates to build an emotional and sequential experience. This expertise referring both to a Barthesian conception of collective imaginaries (1957) and to the approach of A. J. Greimas to narration and ambiance (1979, 1987).



Figure 1. Photos of Promenade Plantée, Seoulo 7017 and the High Line, G. de Kerret and R. Bell, 2017

Mobility

Shortly after the June 2009 opening of the High Line Park, the Active Design Guidelines were published by the City of New York to encourage more physical activity in everyday life. The document contains a description of the project, designed by James Corner Field Operations and Diller Scofidio + Renfro, noting that “the 1.5-mile long park is one of only two urban railroad viaducts converted to park space in the world.” In fact, all three parks have common features pertaining to mobility for pedestrians, children and those with disabilities. These create significant opportunities for more physical activity in a dynamic, engaging environment. As linear pathways, the High Line, The Promenade Plantée, and Seoulo 7017 all build their ‘reading contract’, defined by E. Veron (1985) as a tacit and intuitive agreement between the designer-sender and the user-receiver, as a prompt to active experience.

Ambient experience in all three parks is dynamic, based on walking and a constantly changing view. They feature mobility and connection, but in significantly different ways. New Yorkers walk fast and will use the elevated pathway to avoid time lost at street crossings getting to work before the tourists come and clog the artery. In Paris, the pace is relaxed, a stroll rather than a trot. And in Seoul, the path meanders, allowing for leisure while going from place to place.

The intention of the High Line was to recall the antecedent railroad use, leaving tracks in place, but featuring “a mixture of landscape elements, including plantings, decks, innovative ‘peel-up’ benches, water fountains, and recreational pathways” (*Active Design Guidelines*).

The Coulée verte René-Dumont (Promenade Plantée) stretches 4.7 kilometers in the 12th arrondissement in Paris. It is most crowded in springtime when the flowering trees create a verdant pathway that seems far from the busy streetscape below. Created in 1988, it re-used an abandoned rail line that had connected the Bastille to the Varenne-Saint-Maur³. It allows users to walk through nature while an uninterrupted flow of cars circulates a few meters below. This is accentuated by the tunnel-like enclosure created in many places by the tree canopy. Another part of the Promenade Plantée is the active experience offered by the use of the space beneath the walkway. The massive stone arched vaults now house craft workshops, boutiques, restaurants and even a garden center. A vestigial eyesore becomes a hub of activity, commerce and social engagement.

Seoullo 7017 opened in May of 2017, and is approximately one kilometer in length. It is especially busy on weekends when the shops, quiet zones, playgrounds and lookout features invite people to walk from one place to the next. The paths of movement at Seoullo 7017 are as diverse as its plantings. Nodes of activity are created by boutiques such as Hydrangea Bread and small-scale play space, such as a trampoline in a netted open cage that delights kids. Thus, the episodic nature of the program opportunities encourages movement from point to point.

Stasis

All three parks combine urban and natural signs, and in addition, use plantings to repurpose hardscape infrastructure engendering stasis and contemplation. What park users contemplate is a function of context and differential urban identity. But the industrial heritage is differentially visible and emphasized among the three parks.

Because of structural constraints, the former highway overpass of Seoullo 7017 could not be covered with soil, so the plantings are in large concrete pots that serve multiple purposes, including seating. Winy Maas, the project's architect, said that the basic pot is one where you can sit on its wide edge⁴. Being elevated above the bustle of downtown Seoul, the calmness created by seating that engages contained nature is perhaps the most noticeable feature of Seoullo 7017, which uses a great variety of Korean native plants. Calmness is engendered by making the seating quite comfortable with wooden slats inserted into the concrete forms. Most seating is oriented obliquely to the primary path of movement, so that those using the benches are typically not directly engaged with passersby. Many benches are oriented towards the city view. Our observations were that most seating was used by individuals - people sitting by themselves in contemplation or reading. Small family groups, often young couples with children, use the seating elements as places to catch their breath. The rooftops of the circular shops and cafes become vantage points, turret-like, at which people engage with the city. Circular cut-outs in the pavement give views to the street below, and of the structure of the deck.

The High Line stresses continuity between nature and the city, with native plants evoking wilderness. Contemplation is organized around a dynamic perspective, separate and distinct from the Manhattan grid. High Line seating has great diversity of form from chaises longues, to backless benches to stadium bleachers. Most typically

3. *Promenade Plantée website*: <http://www.promenade-plantee.org>. Accessed June 22nd, 2020.

4. "Winy Maas on Designing Seoullo 7017," *interview of 8 Nov 2019, Singapore Government Agency website*. Accessed June 22th, 2020.

<https://www.leekuaneyeworldcityprize.com.sg/resources/interviews/designing-seoullo-7017/>

we see backed wooden benches parallel to the path of movement enabling intense interaction with both those passing by, and with the city itself. Distinct from the two other parks, the Promenade Plantée is a green tunnel, offering only glimpses of the surrounding city. Sitting on the Promenade Plantée is a challenge, and serendipitous. Seating is oriented to the interior, but users often flip seating direction in attempts to engage with the city. The word “promenade” almost dictates walking, although at a slower pace. Seating appears almost an afterthought, with many young people sitting on the walking surface itself, often using planters as back support. Nonetheless the intense plantings on this most verdant urban tunnel create an amazing sense of calm and stillness. The pace of walking is slow enough to prompt users to appreciate the fragrances. While privileged views of adjacent residential structures exist, the sense of the Promenade Plantée is of a place internally focused, an oasis of repose whose urban identity is contemplative.

Narrative

Ambulatory parks have something more than regular parks: narration. Of course, this can be found in the renaturation process: merging together a former urban device and a natural landscape tells about the city’s history, its transformations and its possible relationships with a more savage world.

But these three parks offer more. As they are built as an itinerary, they imply an iterative experience in space and time. Their design induces a narrative in which the user is offered the role of the hero, as the overall experience is characterized by two dimensions: suspense and transformation. They offer a sensitive experiment built on various sequences, each of them bringing something new. Meanwhile, they orchestrate an emotional transformation of the user. When leaving the park, he or she will be a bit different - and will emerge in another era of the city. To a certain extent, the narrative scheme of Vladimir Propp (1965) could be applied to the sequential experience offered by the three linear parks: the “initial situation” (where the linear park starts) and the “final situation” (where the park leaves the user) frame the process. In-between, a “complication” (or narrative issue) occurs, followed by various episodes and a climactic moment which emphasizes the whole experience.

But despite this common structure, the narrative of each park is specific - and the role offered to the user is different each time. The Promenade Plantée could be compared with an initiation story. It starts with a trial: finding the hidden access stairway; then the tunnel garden appears. Contrary to many other linear parks, the Promenade Plantée stands in discontinuity with the surrounding city. It builds a protected world similar to French formal gardens, with symmetrical lines imposing order on nature - making of this archetypal landscape a progressive experience. As in a French formal garden (and as in an initiation story), drama and surprising views and perspectives are intertwined, with topiary moments, rose gardens and terraces with water features. Intimacy, mystery and secrecy prevail. The climactic moment is the arrival at the Jardin de Reuilly: unexpectedly the perspective opens, both horizontally and vertically. The elevated walkway becomes a bridge overhanging a large, curved and protective lawn, while the surrounding city vanishes. The “promenade” finds its acme in a comfortable and regressive feeling.

As opposed to the Promenade Plantée, the High Line and Seoulo 7017 build a narrative in direct relation with the city. Continuity prevails: the design underlines the site as a platform offering a visual and sensorial experience of the urban surroundings. Thanks to panoramic vantage points and the confluence of images and signs, the High

Line links city and nature, history and present time, culture and commerce. The park develops a narrative from immersion in the city to contemplation, and then back to immersion. The climactic moment of the walk probably occurs in the amphitheater overlooking 10th Avenue: the city is staged as a spectacle and the parks become an embedded metaphor of the urban Rambler, suddenly stopping to enjoy the busy scene. The High Line was a set for contemporary dance in the film, *A Taxi Driver, An Architect and the High Line* by Emmanuelle Huyhn and Jocelyn Cottencin⁵. Lines from their book about the film, *Drunken Horses*: “Les enfants jouent le carré/ de verdure de cet endroit/de la High Line/Impassibles/Les passants passent” (“The children play on the green square of this place, of the High Line, impassable, the passersby pass by”). As in modern dancing, the High Line is an experience where movement and life devolve into stillness and contemplation - and then back to movement.

Seoullo 7017 also develops a narrative from continuity and connection. First, it stands as a branching network with the environment thanks to multiple stairs, ramps, and elevators - a metaphor of arteries, irrigating the city. But while the High Line's narrative lies in the present moment of the city with some clues of the past (as the old train rails, still visible), Seoullo 7017 suggests a projection in fiction. Its very name, made from the year of its construction (1970) and its rebirth (2017), enables a leap in the field of future and fantasy, while *Seoullo*, the Korean name for Skygarden translates to “towards Seoul”⁶. Unlike the High Line and the Promenade Plantée which both close at dusk, at night Seoullo 7017 turns into a blue, fantastic sight evoking the Milky Way - as if the park was suddenly a bridge between the city and the sky. The narrative is thus rooted in time and metamorphosis. While Promenade Plantée suggests an experience of space disconnection (*u-topia*), Seoullo 7017 offers at the same time connection with the city and discontinuity with time (*u-chronia*). Users can then experience possible futures, staged as stopping points all along the walk.

Conclusion: Ambiance and Identity

Looking at the elevated pathways of New York, Paris and Seoul, we observe obvious similarities as well as strong differences. All three use renaturation as an urban design tool to create a new urban atmosphere. Details, materials, signs abound and build idiosyncratic ambiance, either connected or trying to disconnect with the city. Meanwhile, each park emphasizes a specific part of the identity of the city itself - which, apart from design, is relayed by branding, from the park name to logo and graphics. The Promenade Plantée builds a utopian story conveying the atmosphere of a timeless haven, either disconnected from the city or offering itself as one of Paris' most closely kept secrets. On the contrary, the High Line stands as a means to decipher the city - it *highlights* and *underlines* Manhattan's spirit, which connects remains of the city's past with nature and modernity. Finally, Seoullo 7017 tries at the same time to emphasize Korean identity and to imagine Seoul's upcoming transformations.

Each in their own way, the three parks suggest that renaturation is more than a means to improve the city. While inducing new ambiances and experiences, it is also the opportunity to question its identity, and to embrace its future.

5. See: <https://vimeo.com/267694285?ref=em-share>. Accessed June 22nd, 2020.

6. See: <https://www.mvrdr.nl/projects/208/seoullo-7017-skygarden>. Accessed June 22nd, 2020.

References

- Barthes, Roland, *Mythologies*, Seuil, collection Points, 1957
- City of New York, *Active Design Guidelines*, 2010
- Cottencin, Jocelyn, Huyhn Emmanuelle, *Drunken Horses*, Impressions Martin, 2017
- Greimas, Algirdas Julien, *De l'Imperfection*, Fanlac, Périgueux, 1987.
- Greimas, Algirdas Julien, *Sémiotique de l'espace - architecture, urbanisme, sortir de l'impasse*, éditions Denoël-Gonthier, 1979
- Propp, Vladimir, *Morphologie du Conte*, Seuil, collection Point, Paris, 1965
- Sarraute, Nathalie, *Le Planétarium*, Paris, éditions Gallimard, 1959
- Veron, Eliseo, Levasseur, Martine, *Ethnographie de l'exposition - L'espace, le corps et le sens*, Bibliothèque Publique d'information, Centre Georges Pompidou, Service des Études et de la Recherche, 1983
- Veron, Eliseo, "L'analyse du 'contrat de lecture' ; une nouvelle méthode pour les études de positionnement des supports presse", in *Les Médias - Expériences, Recherches actuelles, Applications*, IREP, Paris, 1985

The Urban Spontaneous Beach, an Idle Ambiance in the Urban Space

Maroua EN-NEJJARI¹

Abstract. Often located on the water's edge, "spontaneous urban beaches" are urban spaces where urbanites adopt beach behaviors without the space having been designed for that purpose. Such public spaces redefine the ordinary urban life and allows new sensitive experiences and new forms of body presence in the public urban space. They highlight the emergence of a new urbanity made of idleness, immobility and exposure. The aim of our research is to identify the spatio-temporal, climatic, sensitive, cultural, social and political conditions for the appearance of a beach situation that modifies the ambiance and the experience of the contemporary urban environment.

Keywords. *Urban Beach, Ambiance, Idleness, Public Space, Beach Situation*

Introduction

We call "spontaneous urban beaches" public urban spaces, often at the water's edge, similar to the natural beach in the way city dwellers appropriate it. Those spaces seem to allow city dwellers to relax and expose their bodies to the sun, to the water, to the wind and to others, in the urban area like they would have done on a beach.

In contrast to "staged urban beaches" where a temporary spatial transformation allows the emergence of beach behaviors (Pradel and Simon, 2012), the improvised dimension of the spontaneous urban beach highlights a new relationship to public space and its appropriation by the urbanites who reinvent the conditions of their well-being.

In a context where solicitations and mobilities are multiplying in the city, spontaneous urban beaches seem similar to shoreline beaches in the ambiance that is installed there, and in the attitudes that they generate among the "beachgoers"².

We hypothesize that specific spatial and ambient conditions can foster the emergence of a "beach situation"³ in different urban areas that were not developed for this purpose.

1. CRENAU Lab. AAU-UMR CNRS 1563, Graduate School of Architecture of Nantes, France, maroua.en-nejjari@crenau.archi.fr

2. *Beachgoers*: English translation proposed for the term "plageur," first used by Jean Didier Urbain (1994) to designate beach users, rather than the term "plagist" (Pradel & Simon, 2012) that also means the person in charge of managing a beach.

3. Through literature (Coëffé, 2010; Lageiste, 2008; Urbain, 1994), we can define a "beach situation," as a sunny space-time where beachgoers adopt "beach behaviors," namely cohabiting, relaxed, in a common orientation, exposing their bodies to sun, air, water and to other people, often using accessories specific to the seaside world.

Based on an on-going Ph.D. research, the aim of this paper is to identify, through a brief review of literature and a discussion of the results of our field survey⁴ in Nantes and Toulouse (France), the spatio-temporal, socio-cultural and political conditions of the emergence of spontaneous beach situations in the urban environment. What are the conditions of space and ambiance that allow the existence of the spontaneous urban beach? How do they contribute to redefine the sensory experience of the public space? How does this phenomenon affect the way of managing the public space for leisure?

A Need for Idleness and Nature in the Contemporary Public Space

As mentioned above, beach behaviors seem to be bursting into urban public spaces. For several years now, we have been observing that relaxation and body exposure have gradually become part of the urban landscape, at least on the French scale. Lawns and riverbanks are emerging as new places for idleness, modifying city dwellers modes of presence in the public space (Jolé, 2006). The desire for the outdoors seems to grow in the urban space and the desire to relate to sun and nature, at least in its western cultural dimension, becomes a haunting preoccupation that accentuates the bodily presence of the city dwellers (Di Méo and Foussette, 2015). The latter do not hesitate, on a sunny day, to reappropriate lawns, steps or public benches, to relax and bask in the sun (Whyte, 1980).

Through their potential for distancing traditional urban codes, spontaneous urban beaches seem to respond to a desire for exposure and relaxation of body and mind, which the city dwellers find in their relationship to the ground, water, air, sun and other people.

Our field survey among the beachgoers highlights the idea of the spontaneous urban beach as a place of pause and immobility in a constantly moving city. The need for an elsewhere and a break from everyday life seems to animate urbanites as the good weather arrives, transferring stopping and leisure places from indoor to outdoor waterfront public urban spaces.

The Urban Beach as Reconfiguration of Social Relations

Like the shoreline beach mentioned by several respondents through our field survey, the spontaneous urban beach, as we defined it, appears to city dwellers as a place of sociability, where meeting people is simpler and proximity is less disturbing than in everyday public spaces. As in any public space of co-presence, wherever the beach situation takes place, distances between individuals or groups play an important role in the configuration of beach practices and the way of managing proximity.

We have observed that beachgoers intuitively organize the distances on the urban beach to ensure their comfort and assert their territory. In this type of place, where people may be crowded together, the beachgoers set up territorial logics, instinctively or not, to protect their space and share it peacefully with other people. Using markers,

4. The field survey, during the summer 2018 and 2019, combines two complementary approaches on the waterfront public spaces selected for our study: a first immersion phase including observation sessions and interviews with beachgoers, and a second phase of investigation outside the spontaneous beach situation, consisting of four focus groups with beachgoers outside the situation on the one hand, and semi-directive interviews with officials of the cities of Nantes and Toulouse on the other hand. The in-situ field survey concerns six public spaces in Nantes and five public spaces in Toulouse, including parks and riverbanks, selected based on the presence of beach behaviors in it.

each unit asserts itself and its territory in a situation of co-presence. Personal objects, such as towels, sunscreen bottles or sunglasses, act as “central markers” and “border markers” (Goffman, 1973) on the beach, claiming possession of a part of the space.

The issue of anonymity also seems to influence the slackening of beachgoers. Being in a place that is part of everyday life and whose users are likely to recognize the beachgoers, seems to deactivate their beach experience. On the contrary, a space conducive to relaxation appears to be physically and symbolically far from the daily users’ areas and judgment.

A New Relationship to Body and Exposure in the City

New forms of immobile appropriation of public space can be observed in specific public spaces such as parks, public lawns and riverbanks. Indeed, those places witness the appropriation of public space by the idle, relaxed, immobile body, and sometimes more or less naked and exposed to the gaze of the other. They become parentheses in everyday urban life, instant holidays from urban control and solicitations (Worpole, 2000). Beyond the slackening of postures, a whole new relationship to the body, usually related to the beach sphere, seems to take place in our cities, made of relaxation, immobility and exposure to the sun and to the sight of everyone. These places highlight a new relationship to the body in cities that are “balnearizing” by making semi-nudity, usually visible at the beach, gradually part of urban life (Barthes-Deloizy, 2003).

The spontaneous urban beach, as we have defined it, seems to be a situation that changes the urban expression of the body, as much in terms of its posture and comfort as in terms of its exposure and visibility. Indeed, on our urban survey sites, city dwellers are relaxed, often lying down, sunbathing and sometimes wearing a swimsuit just like on the natural beach. Different spatial, sensitive, social and cultural signals seem to allow the city dweller to feel legitimate to expose his body to the sun and to others, without a surrounding legal framework, in particular for the practice of semi-nudity. However, the spontaneous urban beach situation is pervious to social control and restraint usually related to the urban environment.

Legitimacy to adopt beach behaviors in the city appears to be found first in the attitudes of others. An implicit consensus, established by beachgoers with the same recreational project, seems to legitimize their collective body loosening and unveiling. This tendency to affirm the body in the city highlights the hypothesis of the spontaneous urban beach as a place of “anthropological redefinition of intimacy” (Jolé, 2013). It invites us to rethink the ways in which the body is welcomed in the city.

Space as Ambiance Creator

Urban space offers the body multiple possibilities and “behavioral opportunities” (Di Méo, 2007). It shapes the urbanites behavior and it influences their well-being. Through our fieldwork, several spatial elements appear to activate the spontaneous beach experience in the urban space. The distribution of practices in these places seems to follow a specific spatial configuration that guides uses, dividing the space into different zones more or less suitable to relaxation. Users seem to choose their installation area carefully, according to the experience they are looking for, especially for the beachgoers who adopt the most representative beach behaviors such as body exposure (illustration 1).



Illustration 1. Beachgoers organization on an urban spontaneous beach. Port Viguerie, Toulouse, France. Credit: M. En-nejjari

First of all, the relationship of the urban beach with the surrounding urban environment seems to play a role in stimulating beach behavior in the city. The different materializations of the limit between the spontaneous urban beach and the surrounding urban environment modifies the way of behaving. In this sense, the surveyed beachgoers evoked several boundary elements, such as dense vegetation, fences, ramparts, difference in levels between the space and the outdoors, that can affect their practices, through the physical or symbolic distance they allow with the daily city life.

Furthermore, proximity to nature seems to play a role, according to our respondents, in the feeling of well-being and freedom that allows city dwellers to relax in the middle of the city. The presence of water appears to encourage slackening and to modify the urbanites sensitivity on the spontaneous urban beach. Despite the forbidden access to it, water seems to ensure a physical as well as symbolic distance from the urban space in front of it. Looking towards a common distant horizon seems to preserve intimacy and to allow beachgoers to feel far from urban nuisances and from the other users of the space.

In addition to that, the proximity of water also makes spontaneous urban beaches places of refreshment for city dwellers. The heat wave episodes of the last few years push them to look for spaces that are connected to urban nature, offering them cooling interstices and a break with the dense city noise and solicitations.

The Spontaneous Urban Beach, a Break From Ordinary Urban Temporalities

By its distancing potential from everyday life, the spontaneous urban beach appears as an area that is outside of ordinary time. These spaces seem to be articulated around specific temporalities, distinguishing them from the rest of urban public spaces, at the scale of the day, week and season.

The different phases observed in the life of an urban beach and the transformation of the ambiance of these spaces through the seasons question the spontaneous urban

beach as a spring phenomenon rather than a summer one. It raises the question of its possible status as a substitute for the shoreline beach when access to it is impossible. Interviews with beachgoers also highlighted an aesthetic relationship between the shoreline beach and the urban one, several beachgoers consider sun exposure on the latter as a phase of preparation of the body for the summer and the shoreline beach. This raises the possibility of a link between those two spaces as two phases of the same beach experience, one replacing the other according to the season.

These different temporalities of use can also be found at the scale of the week and the day. The ambiance of the urban beach changes through the day and through the week and seems to be intimately linked to the weather and the density of occupation, which hinders the adoption of beach behaviors when it is very high.

Urban Planning in Response to a Need for Nature, Leisure and Change of Scenery

Our investigative work, in various public entities⁵ in charge of public space in Nantes and Toulouse, highlighted a growing interest for leisure and relaxation in urban space managing. According to them, idleness and leisure become main elements of the attractiveness of the contemporary city and are integrated into its development in order to modify the urban experience and ambiance to one that is more conducive to the well-being and relaxation of city dwellers, notably in connection with the cultural idea of nature. Public authorities therefore tend to design spaces suitable for slackening, as a guarantee of the “acceptance” of life in the dense city.

Our survey highlights a tendency to take the beach sphere as a model of an exemplary multidisciplinary leisure space, allowing city-dwellers to relax, to expose their bodies, to socialize and to reconnect with nature, in the development of certain public spaces. This trend occurs in the context of the reconquest of rivers to turn them into spaces for idleness.

In this sense, attempts to integrate ambiances linked to a simulated nature in the city, such as scenic urban beaches, are multiplying. However, a need for transgression is observed by the public authorities of the city of Nantes regarding the appropriation of public space, and it is particularly shared by the youngest beachgoers. Today’s city dwellers need informal spaces where they can express themselves freely and choose their way of appropriating, or at least have the impression of doing so. This need to free themselves from norms seems to underlie the practice of the spontaneous urban beach.

According to the city’s public officials, a relationship exists between the spatial and ambient qualities of public space, deliberately planned by designers, and the appearance of beach behaviors that are tolerated when they take place in areas designed for leisure. This new form of spontaneous appropriation of public space seems to fit into a vision of the city oriented on uses and ambiance of leisure, idleness and relaxation.

Conclusion and Opening

The emergence of beach atmospheres in specific urban places and conditions, whose disappearance can deactivate the change of scenery, has highlighted the question of

5. *Semi-directive interviews conducted with city officials in the Public Space and the Green Spaces Departments in Nantes Métropole, and various city officials in the Urban Planning and Development Department in Toulouse Métropole.*

the spontaneous urban beach as a situation rather than as a static space-time. In this sense, we could say that under specific spatial, ambient, temporal, climatic, sensitive, social and political conditions, a situation of spontaneous urban beach can take place in a perennial public space of the city. It can also disappear from it if the conditions of the emergence of the beach ambiance are not verified.

These situations bear witness to a need for city dwellers to renew their modes of presence and attention in urban public space. They seem to be sensitive to places that they can freely appropriate and in which they redefine their experience of urban space, an experience of leisure, relaxation, immobility and exposure. Idleness seems to integrate the contemporary urban experience and ensure a necessary break with urban daily life, within the contemporary city itself.

Spontaneous urban beaches highlight a desire and a quest for nature and for a change of scenery that city dwellers are looking for in this type of ambiances that allows them to reinvent the conditions of their well-being in the city, in connection with the elements.

Acknowledgments

Thanks to Ignacio Requena Ruiz, Daniel Siret and Sophie Provost

References

- Barthes-Deloizy, Francine. *Géographie de la nudité : être nu quelque part*, Paris : Bréal Editions, 2003.
- Coëffé, Vincent. “ La plage, fabrique d’une touristi(cité) idéale ”. In *L’Information géographique* (74), 51-68, 2010.
- Di Méo, Guy & Foussette, Karen. “ Ville durable et nouveaux territoires du corps ”. In *Développement durable et territoires* (2), 2015.
- Goffman, Erwin. *La mise en scène de la vie quotidienne. 2. Les relations en public*. Paris : Éditions de minuit, 1973.
- Jolé, Michèle. “ Le destin festif du canal Saint-Martin ”. In *Pouvoirs* (116), 117-130, 2006.
- Jolé, Michèle. “ Que sont devenus les espaces publics parisiens ? ”. In *Métropolitiques*, 20 October 2013, [online]. <https://www.metropolitiques.eu/Que-sont-devenus-les-espaces.html>, consulted on 10 January 2019.
- Lageiste, Jérôme. “ La plage, un objet géographique de désir ”. In *Géographie et cultures* (67), 7-26, 2008.
- Pradel, Benjamin & Simon, Gwendal. “ Quand le citoyen joue au plagiste. Paris Plage, des référents touristiques dans le quotidien urbain ”. In *Espaces et sociétés* (151), 69-84, 2012.
- Urbain, Jean-Didier. *Sur la plage : mœurs et coutumes balnéaires*. Paris : Payot & Rivages, 1994.
- Worpole, Ken. *Here Comes the Sun: Architecture and Public Space in Twentieth-Century European Culture*. London: Reaktion Editions, 2000.
- Whyte, William. *The Social Life of Small Urban Spaces*. Washington D.C.: The Conservation Foundation, 1980.

PANELS

Toward the Possibilities of Urban Sound Parks

Abstract. This paper, written in an interview format, collects the thoughts of three international curators of outdoor, public sound installation art parks. Questions were posed by Jordan Lacey to Paul Craenen (Klankenbos, Belgium), Raquel Castro (Lisboa Soa festival, Portugal), and Stephan Moore (Caramoor Center for Music and the Arts, New York State). The questions aim to decipher commonalities across the experiences of the three curators, which are summarised into seven key themes at the end of the document. The key themes can be read as a series of propositions for the possible creation of sound parks in urban spaces.

Jordan LACEY¹, Raquel CASTRO²,
Paul CRAENEN³, Stephan MOORE⁴

Keywords. Sound art installations, listening, curation, public space

Introduction

During 2016, I (Jordan Lacey) completed an international research journey investigating public sound art installations that had attained the status of permanency. My trip included audio-visual documentation and interviews with the creators of most of the works, which is discussed at length in the paper *Sonic Placemaking* (2017). During my trip, I visited two 'sound parks' containing multiple curated sound installations: the Caramoor Center for Music and the Art's *In the Garden for Sonic Delights*⁵ in New York State curated by Stephan Moore, and the Musica, Impulse Centre for Music's *Klankenbos*⁶ in North Belgium curated by Paul Craenen. More recently, I made contact with the curator of a third sound park, *Lisboa Soa*⁷, a yearly sound-art festival located in Lisbon, Portugal curated by Raquel Castro.

I sent eight questions to the curators asking them to reflect on the ambiances experienced within the sound parks they created, and the specific role of sound installations in the creation of these ambiances. The questions culminate in a consideration of how similar ambiances might be situated in cities, and the challenges of creating urban sound parks. The paper can be read in two ways: each curators' answers can be read sequentially, or the three answers from each curator can be read in relation to

1. RMIT University, School of Design, Australia, jordan.lacey@rmit.edu.au

2. CICANT, Universidade Lusófona, Lisboa, Portugal, fonorak@gmail.com

3. University of the Arts, Royal Conservatoire The Hague, The Netherlands, p.craenen@koncon.nl

4. Northwestern University, Department of Radio, Television and Film, United States, stephan@northwestern.edu

5. For further information, see:

www.caramoor.org/music/sonic-innovations/past-exhibitions/in-the-garden-of-sonic-delights/

6. For further information, see: www.klankenbos.be/en/projects?f%5B0%5D=field_interesses%3A258

7. For further information, see: www.lisboasoa.com

each question. I have edited the responses to meet the word count, however, I have tried to keep the text in each curator's original voice. The paper concludes with key themes that act as propositions for the possible creation of urban sound parks.

Can you provide details about the sound park you curated?

Paul Craenen: Klankenbos is a collection of 17 permanent open-air sound installations, next to some virtual and temporary sound art works, located at Neerpelt, Belgium, in a public, semi-natural domain. Klankenbos was founded in 2005 and is an initiative of Musica, Impulse Centre for Music, a Flemish organisation for music education and participation.

Raquel Castro: Lisboa Soa was founded in 2016 as an initiative that aims to enhance artistic creativity by connecting it to social and ecological contexts, as well as promoting direct interventions in public space. The festival is positioned at the interface of science and sound art. Each iteration of the festival shares similar environmental concerns, spatial understandings and artistic exploration.

Stephan Moore: Caramoor Center for Music and the Arts is a 90-acre estate in Westchester County, NY. In 2014, I curated an exhibition called "In the Garden of Sonic Delights", which included ten outdoor sound art installations exhibited at Caramoor, and another five pieces distributed throughout Westchester County. Annual programming continues to this day, under the moniker "Sonic Innovations"⁸.

How would you describe the ambiance that the sound park created?

P. Craenen: The Klankenbos ambiance was typical for a small-scale, semi-natural park with its diversity of trees, charming small river and public character. The sound art works were an integral part of that environment, adding a unique character to its identity. Since most of the art works were objects that don't make much sound unless you approached or entered them, the ambiance created was mainly visual and imaginative, with strange objects in the landscape raising visitor curiosity.

R. Castro: We access special park locations for the festival, with their own specific ambiance. Sites include: an empty greenhouse built with forged iron, with an audible central 'sweet spot' that allows non-amplified performances, and a dirt floor that produces a mysterious scent; a water reservoir with a cold, dark ambiance; and a 'water cathedral' that is extremely reverberant. All the proposals had to consider the existing ambiances.

S. Moore: I would say that each piece generated a different ambiance, in a manner that was specific to the materials used, the environment chosen, and the intention of the work. Further, each work's ambiance was not completely consistent, but relied upon the changing environmental factors. Some of the pieces had a strong physical/sculptural presence that lent a visual focus to the sonic experience, while others were completely ephemeral with no visible speakers or apparatus of any kind.

When commissioning artists, what sorts of experiences were you hoping to generate?

P. Craenen: I expected artists to be in dialogue with their surroundings, with an awareness of the possibilities and limitations of a specific location. The fact that Musica did

8. See: <https://www.caramoor.org/music/sonic-innovations/>

not own the domain/park, and that the domain/park was also used for other purposes, was always something to take into consideration. A (sonically) too invasive work of art was never an option.

R. Castro: I have an environmental theme every year, that is informed by the location. Examples include: geophonic sounds, biodiversity, water, plant/animal migration. Sound installations are core to the festival, because our intention is to create a sonic experience that visitors can discover when walking and exploring the sites on foot.

S. Moore: I select artists who are interested in site-specific response, are capable of meeting the various challenges posed by outdoor sound works and have an exploratory approach to their art. My role as curator is to clear any obstacles between them and the realization of their vision.

Is the sound park you curated in a rural area? Why?

P. Craenen: Klankenbos is located on the domain where Musica has its offices, so there is a pragmatic reason. There is also the tranquillity that makes room for more subtle sounds or works of art (although there always was a background of traffic noise). It is also a relatively safe environment - I can't imagine the same collection being maintained under the same conditions in a large city.

R. Castro: Lisboa Soa happens in an urban context. Nevertheless, most of our locations are in parks. You cannot fully understand a sound installation in a short amount of time, the same way you can with a visual work. If you want the audience to have enough time to experience a sound art piece, then it should organically integrate into a surrounding space that is pleasant for the audience to be in.

S. Moore: An urban space is, from the outset, more restricted. Rural space is frequently a blanker canvas; it is less full of noise, light, motion, and generally distracting activities that an artwork would need to compete with. Also, in rural spaces, there are more large sites with a single owner. Urban sites usually come loaded with constituents making it invariably more complicated than sites with a single constituent.

Can you discuss issues around maintenance and vandalism?

P. Craenen: Vandalism happened, though rarely. But when it happened, it had serious consequences, not just financial. You can't just 'repair' a work of art, it often needs the cooperation and expertise of the artist, which was sometimes problematic. A major problem is that insurance companies refuse to insure vulnerable art works in public spaces, or at a high cost.

R. Castro: Most of the places we used are closed during the night so the issue of maintenance is not a huge problem for us. We had other constraints such as having to disconnect an automatic irrigation system for the duration of the festival. The only time we used a non-secure location we had to arrange a budget to support 24-hour security, which was costly.

S. Moore: As Caramoor is only open during certain hours, and has only two entrances guarded by locked gates, we have managed to avoid any significant vandalism. Regarding maintenance, when a piece is new, we must go through a period of learning during which the piece is periodically retuned, calibrated, and/or replaced.

How do visitors respond to the ambiances of the sound park?

P. Craenen: We have to make a distinction between people who came for the collection or local people who were there for other purposes. People who visited the collection, often with children or their families, made an effort to get to the place bringing curiosity and expectation. Others were there for sports or other (sometimes noisy) activities. I do think the collection contributed to the general atmosphere and identity of the place.

R. Castro: I think we generate a collective mood, with visitors often mentioning a sonic oasis within the city. Our intention is to create an awareness of sound as a resource to better understand ourselves and the environment we live in. I remember an old lady was listening to the plants and branches amplified by an artist (Juan Sorrentino) by putting her ear close to them, each time the artist moved to another place. I think this idea of a sonic playground is very effective in creating an awareness of ambiances.

S. Moore: In art galleries, I observe visitors slowly walking down a row of paintings, never quite pausing or stopping. A sound-based artwork either slows us down to its speed, or forces us to reject it if we don't have the attention to listen. The artists who have created or adapted work for Caramoor have made use of this quality of sound art. I witnessed people slowing down, processing their perceptions, and later energized and eager to speak about their experiences.

Can you speculate about what it would mean to curate a sound park in an urban space?

P. Craenen: If considered in relation to an acoustic awareness in urban design, we could think of rather implicit elements of sonic design that contribute to an 'ambiance' that isn't necessarily noticed consciously. I would rather think of spread-out 'listening spots' which offer interesting listening angles to urban life and make people aware of the surrounding sounds. Unless you would like to create a completely autonomous area, a dialogue and interaction with the immediate environment is a requirement. A challenge would be to defend a place devoted to sound (art) in the city's cultural fabric.

R. Castro: Lisboa Soa's location in a city poses ongoing challenges that require us to silence the surrounding soundscape. For instance, once, I wasn't advised there would be an outdoor festival 100 meters away from our site. Such uncontrolled and undesirable loud events can compete with the magical atmosphere we try to create. We have to think about the way we communicate artworks in relation to the competing sounds of the city. I have to say meeting this challenge is one of my biggest satisfactions as a curator.

S. Moore: In my mind, there is no reason that this could not be done successfully. It would be very difficult to do with the level of resources I have access to at Caramoor, given the budgetary and logistical burden of obtaining permissions and permits, vandal-proofing artworks, and dealing with bureaucracies. A larger team with more dedicated resources would no doubt be required.

Thinking through your experiences as a sound park curator, how might an ambiance approach change the way we think about designing our cities?

P. Craenen: Firstly, I believe any approach of sonic ambiance in urban design will need to take into account changing expectations of sound interactions on a personal, media-enhanced level. A more hybrid answer to these developments and expectations would be to integrate environmental sound experience with virtual sound events or enhancements. Secondly, I have learned by observing people of all ages and different backgrounds in Klankenbos that the sonic atmosphere of an environment hardly ever works in a purely auditory way. It is in connecting sound with other dimensions including the visual, architectural, conceptual and imaginary that sound design can become very powerful, and I think this can also be the case at the level of city design. This awareness of complex dependence and multilayered interaction is something that the curator can bring to the table.

R. Castro: Sound permeates the experience we have in a city. It attributes a tone and brings an emotional value to the place. Sound art practices are valuable tools for the development of this consciousness, by encouraging auditory awareness and provoking the audience about their own attitude as listeners. I believe the listening education experiences offered by festivals like Lisboa Soa can help making people more aware of the ambiance they experience around them. This reveals how cities could sound, and provides moments for reflecting about the ways in which we can listen. This shift may contribute to the development of stronger concepts and conversations about the possibilities of future city spaces.

S. Moore: Our cities currently suffer from a clash of competing imperatives, as driven by our industrial-consumer societies. Approaches to sound design are typically limited to achieving silence. One reason for this lack of imagination is that there is no approach that unifies the varying aesthetics of a city's competing imperatives. If a consideration of ambiance (and its design) were added to the discussion, this presents the possibility of a co-ordinated approach. What would this look like? I hope it would be varied and nuanced; that the identity of selected sites within cities - their history, citizens and constituents, material and spiritual entanglements - would find expression through the existing workings of the city, while at the same time, making these functional aspects of the city indistinguishable from "art".

Key themes

After reading through the responses above I have identified the following seven key themes, which I have connected to relevant theory. It should be noted that the curators raised many more interesting points than could be included. The following themes are surmised from the edited text only. These shouldn't be considered conclusive; but rather, as propositions that contribute to thinking about how sound parks might be integrated into urban spaces.

1. **Site-specific** approaches are crucial if works are to successfully integrate with the complex and competing imperatives of urban environments.
2. An awareness of the **temporality** of sound art is crucial. Embedding sound works in spaces where people want to linger, may encourage listening appreciation. This is consistent with Jean-Paul Thibaud's (2012) position of sonic experience being a uniquely temporal expression of ambiances.
3. Ambiance is **multisensorial**. Sound should be created in relation to other perceptual criteria, including the possibilities afforded by virtual environments.

Sarah Pink (2011) has written extensively on the role of multisensoriality when considering relationships between the senses and the environment.

4. Urban sound parks could provide sonic **oases** allowing visitors to access positive listening experiences. See Lacey et al. (2019) for an example of a sound design intervention creating a sonic oasis along a motorway environment.
5. The **curator acts as mediator** by assisting the artist to respond effectively to the challenges of public space. The urban designer should embody the role of curator, when considering the introduction of sounds into cities. See Anderson (2016) for a similar discussion.
6. Every site already has a **pre-existing ambiance**. Artworks should simultaneously integrate with, and transform, existing conditions. This is consistent with Thibaud's (2012) position that ambiance is particular to its situation, and Sumartojo and Pink's (2018) claim that an atmosphere cannot be staged given an atmosphere always already exists.
7. Provisions for **security and maintenance** are costly, and would need to be integrated into the design and financial considerations of the establishment of an urban sound park.

References

Anderson, Sven. "The incidental person: reviewing the identity of the urban acoustic planner." *Journal of Sonic Studies* 11 (2016).

<https://www.researchcatalogue.net/view/243093/243094>

Lacey, Jordan. "Sonic Placemaking: Three approaches and ten attributes for the creation of urban sound art installations." *Organised Sound* 21(2) (August 2016): 147-159.

<https://doi.org/10.1017/S1355771816000078>

Lacey, Jordan, Sarah Pink, Lawrence Harvey and Stephan Moore. "Noise transformation: A critical listening-based methodology for the design of motorway soundscapes." *Qualitative Research Journal* 19(1) (February 4, 2019): 49-64.

<https://doi.org/10.1108/QRJ-D-17-00018>

Pink, Sarah. "Multimodality, multisensoriality and ethnographic knowing: social semiotics and the phenomenology of perception." *Qualitative Research* 11(3) (June 6 2011): 261-276. <https://doi.org/10.1177/1468794111399835>

Sumartojo, Shanti and Sarah Pink. *Atmospheres and the experiential world: Theory and Methods*. Abingdon: Routledge, 2018.

Thibaud, Jean-Paul. "A sonic paradigm of urban ambiances?" *Journal of Sonic Studies* 1(1) (2011). <https://www.researchcatalogue.net/view/220589/220590>

The Architecture of the Virtual

An Encounter between Cognitive Neurosciences and Architecture

Karan AUGUST¹, Zakaria DJEBBARA²,
Stavros KOUSOULAS³, Andrej RADMAN⁴

Abstract. The philosophies of substance presuppose a subject which then encounters a datum. This subject then reacts to the datum. The process ontology presupposes a datum (firstness) which is met with feelings (secondness), and progressively attains the unity of a subject (thirdness). It is in this sense that our bodily experience is primarily an experience of the dependence of the actual presentational immediacy upon the virtual causal efficacy, and not the other way round. To put it bluntly, the world does not emerge from the subject, but processes of subjectification emerge from the interactions between the body and world. The chapter is meant to provide the basis for the panel that will stage an encounter between cognitive neurosciences and architecture.

Keywords. Architecture, Virtuality, Neurosciences, Atmospheres, Brain, Fold, Sense

Introduction: Between Senses, Inventions and Worlds¹²³⁴

Deleuze famously considered Phenomenology to be within the ancient tradition which placed light on the side of spirit and made consciousness a beam of light drawing things out of their native darkness, as it were (“all consciousness is consciousness of something...”). By contrast, he follows Bergson for whom things are luminous by themselves without anything illuminating them: “all consciousness is something, it is indistinguishable from the thing, that is from the image of light” (Deleuze, 1986, 60-61).

The philosophies of substance presuppose a subject which then encounters a datum, as Whitehead explains in his *Process and Reality* (Whitehead, 1978, 234). This subject then reacts to the datum. The process ontology presupposes a datum firstness - which is met with feelings - secondness - and progressively attains the unity of a subject - thirdness (Peirce, 1905). It is in this sense that our bodily experience is primarily an experience of the dependence of presentational immediacy upon causal efficacy, and not the other way round (Whitehead, 1978, 267). To put it bluntly, the world does not emerge from the subject (as in Kant) but processes of subjectification emerge from the interactions between the body and world. This is what makes subjectification an ethico-aesthetic condition that is always temporal, intensive and individuating.

Perception is thus clearly an act of subtraction (sieve) and not of enrichment (Read

1. Independent scholar and City Planner in the San Francisco Bay Area, augustkaran@gmail.com

2. Independent researcher, Aalborg, Denmark, zadj@create.aau.dk

3. Assistant Professor of Architecture Theory, Delft University of Technology, the Netherlands, s.kousoulas@tudelft.nl

4. Assistant Professor of Architecture Theory, Delft University of Technology, the Netherlands, a.radman@tudelft.nl

and Jones, 1982, 297). It entails a selection of a flow of immediate experience out of the potential ground that is pure experience. Interestingly, this is also the current view in cognitive neurosciences: perception is the informational act of delimiting potentials (Friston, 2010 Cf. Gallagher, 2017). This means that there is less in perception than in matter. In the words of François Zourabichvili: “Mind is the membrane of the external world, rather than an autonomous gaze directed towards it” (Zourabichvili, 1996, 195). Quentin Meillassoux explains the underlying principles of such a subtractive theory of perception:

[I]f, to pass from matter to perception, we must add something, this adjunction would be properly unthinkable, and the mystery of representation would remain entirely intact. But this is not at all the case if we pass from the first to the second term by way of a diminution, and if the representation of an image were held to be less than its simple presence. Now, if living beings constitute ‘centres of indetermination’ in the universe, then their simple presence must be understood to presuppose the suppression of all the parts of the object that are without interest for their functions [...] Perception does not, as in Kant, submit sensible matter to a subjective form, because the link, the connection, the form, belongs wholly to matter. Perception does not connect, it disconnects. It does not inform a content but incises an order. It does not enrich matter, but on the contrary impoverishes it (Meillassoux, 2007, 72-73).

The poet William Blake wrote: “If the doors of perception were cleansed every thing would appear to man as it is, infinite.” According to the neuroscientist Walter Freeman such cleansing would not be desirable at all. Without the protection of the doors of perception we would be overwhelmed by eternity (Freeman, 1991). Besides, it is never necessary to distinguish all the features of an object and it would in fact be impossible to do so (Augé, 2002, 14). According to the founder of the Ecological School of Perception James Jerome Gibson, perception is economical: “Those features of a thing are noticed which distinguish it from other things that it is not - but not all the features that distinguish it from everything that it is not” (Gibson, 1966, 286). To address this, one needs to return to the (architectural) event itself. In the traditional view, the event is decomposed into a succession of moments, each described by its own stimulus. For the event to be perceived the succession of stimuli needs somehow to be strung back together. A *deus ex machina* is drafted for the mysterious task of reconstituting the dynamic. By contrast, in the ecological approach the perceiver’s task is merely to detect the event as specified by information or signs. The ‘information’ here is meant in Batesonian terms, not as a code, but as a difference that makes a difference, and it is for this reason that Gibson finds ‘tuning in’ a more appropriate metaphor than ‘computing’. Our bodily units must incorporate within themselves aspects of the world beyond themselves (*umwelt*).

There is an intimate connection between Senses, Inventions and Worlds. In contrast to phenomenology where the problem of construction of signs becomes a problem of ‘bestowal of meaning (Sinn)’, in Deleuze’s account it is sense that is productive of signs and their meanings (Deleuze, 2007; Deleuze and Guattari, 2004, 124). This distinction between sense and meaning is not purely academic nit-picking, as Colebrook cautions: “Sense is that orientation or potential that allows for the genesis of bodies but that always, if extended, would destroy the bordered organism” (Colebrook, 2010, 37). The life form itself becomes an image among other images. This special image - a Bergsonian ‘center of indetermination’ - acts as a filter creatively selecting images from the universal flux.

Our ability to distinguish the essential from the inessential is at the basis of this zeroing in. According to Antonio Damasio, the 'sterile' combinations do not even present themselves (Damasio, 1994, 180). However, on no account does this mean that we look on and grasp a specific aspect of the world or environment as detached and fully formed beings: "[A] being is what it is because it is already an expression of every aspect of the whole. [...] Organisms are possible because they concretely embody potentialities - the power to eat, to see, to move, to think - that could have been actualized differently, and that can even be counter-actualized" (Colebrook, 2010, 84, 110). According to Colebrook, a (fully) bounded organism is but an organicist fantasy. So is bounded architecture, and that is why it would make more sense to treat it as a (semi-permeable) membrane(s) (Teyssot, 2008, 166; Clark, 2017). In other words, architecture is cognition. The question then becomes how one knows what to subtract. Is it a matter of measurement (of the extensive) or an issue of intuiting (the intensive)? More so, what is the role of architecture in perceptual subtraction and what is the role of subtraction in the production of architecture?

The Four Pitches for the (Virtual) Panel on the Virtual

Karan August: Atmospheres

The desire to frame what is with a human vantage often pulls thinking to prioritise the importance of analytical minds to an hedonistic extent, rendering impossible the capacity to conceive systems of relating matter without a perceiver. Yet Atmosphere once grasped the virtual vitality of just that; not beyond the perceiver, but irrelevant to. The trick of good architecture is that an object can manifest relating parts within its systems; both those attending and those inherently able to join. Matter's mission is not to be formed by biped, biocular, unidextrous creatures hoping to profit off clever jesters. However matter's disadvantage resonates with those who's capacity to influence their formation, be it physical, psychological, political, or prudential, is limited by context existed through networks of reinforced relations of power. That which warrants manifestation regardless of observation persist, while meaning placers peripheral glances fail to grasp the acts own meaninglessness, until that which manifest shows what can not be unseen, that which may be tangential though not incidental, affording atmosphere to shift.

Akin to a thought experiment gone awry, herd hysteria calls on seemingly familiar situations to warrant new norms. Prior signifiers in our shared surroundings and behaviours shake their projected historic meanings, while material relations remain. Is the parting of habitual patterns with newly forced rhythms what calls those to see an unfamiliar Atmosphere that has always been possible? Or are unstable material relations unbinding forced formation, affording fresh ranking of which possibilities most easily actualise? Our time is both of our making and that which we find ourselves within. If we may grant the insignificance of our role as makers of space, perhaps we may more freely engage the persistent capacity of what is to actualise. The vibrancy may overwhelm, but perhaps it will welcome more to join in the care of our collective atmospheres.

Zakaria Djebbara: A Virtual brain?

Not much different from Bergsonian process philosophy, which resonates through Whitehead's and Deleuze's philosophy, recent advances in cognitive neuroscience suggests that the experience of the world, including sensing ambiances, rests on the interaction between an intuitive and practical knowledge in the body and its environment. The integrative use of sensorimotor patterns in cognitive functions has recently

provided a novel framework for cognition, breaking from the Cartesian non-physical interface conception of mind. The Bergsonian term ‘virtual’ refers to the qualitative multiplicity and continuity in the unfolding of time, which is strikingly similar to recent theories of cognition when applied to action. It reflects the creative process of enacted sensation, corresponding to a cascade of motor-related prediction errors in neuroscience. By casting action as motor-predictions, the negation, i.e. error detection, becomes the essential motivator for enacted sensation. Considering process philosophy, perception and action are inseparable as they converge in their functional unfolding in sensing. As the genesis of the virtual reside in negation and the sensed being entirely positive, the process of enacted perception flourish between object and subject. Once action is grasped in its complex context, it is clear that any action unfolds solely under the virtual, that is, a directed multiplicity. In turn, the virtual is never conceived without a complex range of affordances relative to the “type” of action and perception, e.g. how, by what means, and under what circumstances did she do it? Ambiances can thus be indirectly addressed by questioning these layers of action—however, the answers will only provide a peek into the complex trajectory *ex post facto*. Approaching sensibility via cognitive neuroscience and the virtual provides a view into the sensing of ambiances as reflected in the inhibitory cascade of motor-related prediction errors. The difficult question to this extent relates to the genesis of the directed multiplicity within the virtual during becoming.

Stavros Kousoulas: It Does not Fold Because You Say So

Inherited from Deleuze, the concept of the fold has a long history in architectural theories and practices. Unfortunately, this history does not approach the fold as a primarily architectural problem. The fold remains a purely philosophical concept that conventionally has had a merely metaphorical use in architecture. The value of the fold, of the membrane, when examined as a proper architectural problem and not merely as formalist gesture, is that it makes the architectural world, the architectural subject and all the binaries that they presuppose, collapse. In the membranic limit, the metastability of a folded architecture expresses the forces, the milieus and the territories that produce any architectural subject; in the thresholds of the fold, the vibratory affects of rhythms and their symphonic composition pulsate in order to produce surpluses of energy that can resolve the potentials of an architectural becoming. Space and time, what produces architecture and what is produced by it, no longer stand opposed but individuate along the architectural technicities that we need in order to individuate. As such, the membrane expresses the singularity of a given individual and its territory, as well as the universality of the forces that are in constant play on it. This duality, an impersonal personalisation and a singular universalization, as expressed in the membranic event, has two consequences. Firstly, one can examine an individual and its territory as a singular product - avoiding any form of essentialist, typological or hylomorphic thinking. Secondly, it can elevate the informational and affective agency of the event on a level that is independent of the singular assemblages that expressed it. In doing so, we can address affects and information as autonomous from their actualizations. In other words, we can approach the virtuality of the pre-individual refrain without the need of a method: we can intuit it.

Andrej Radman: Logic of Sense

The concept of the virtual opposes the logic of law with the logic of event: Nothing is; everything becomes. Sense is not given. It is the product of complex processes and it has to be conceived as sense-effect, or better as sense-event, that subsist as real yet incorporeal. In a nutshell, the material cause is tied to the (Stoic) incorporeal effect, which will in turn operate as a quasi-cause. The concept of quasi-cause (a.k.a.

dark precursor) prevents regression into simple reductionism. It designates the pure agency of transcendental causality, the difference that relates heterogeneities. The Stoics show that things themselves are bearers of ideal events which do not exactly coincide with their properties. Any (actual) incarnation may in fact be seen as a (provisional) 'solution' to the problem posed by the virtual the same way that the eye is the solution to the problem of light. This is what makes the virtual not ideal but problematic. Guattari's appropriation of Joyce's term Chaosmosis is quite fitting for teleodynamic processes where everything seems to fold upon itself. However, this logic (if sense) must not be reduced to the Manichean opposition between the quantitative actual and qualitative virtual. The difference between the difference in degree and the difference in kind is not reducible to either. In the words of Deleuze from *Difference and Repetition*: "Between the two are all the degrees of difference - beneath the two lies the entire nature of difference in other words, the intensive." And indeed, for Deleuze it is the intensive nature of difference - which binds the virtual and actual, the ideal and sensible - that supplies catalysis for individuation.

References

- Augé, M., *Oblivion*. Minneapolis: University of Minnesota Press, [1998] 2004).
- Clark, A., "How to Knit Your Own Markov Blanket: Resisting the Second Law with Metamorphic Minds." In *Philosophy and Predictive Processing*, edited by T. Metzinger T, W. Wiese, 41-59. Frankfurt am Main: MIND Group, 2017).
- Colebrook, C., *Deleuze and the Meaning of Life*. London: Continuum, 2010.
- Damasio, A., *Descartes' Error: Emotion, Reason, and the Human Brain*. New York: Putnam Publishing, 1994.
- Deleuze, G. and F. Guattari, *A Thousand Plateaus*. London, New York: Continuum [1980] 2004.
- Deleuze, G., *Cinema 1; The Movement-Image*. London: The Athlone Press, [1983] 1986.
- Deleuze, G., *Proust and Signs: the Complete Text*. London: Athlone, [1964] 2007.
- Freeman, W., "The Physiology of Perception." *Scientific American* 264(2) (1991): 78-85.
- Friston, K, , "The free-energy principle: a unified brain theory?" *Nat Rev Neurosci*. 11(2) (13 Feb 2010): 127-38.
- Gallagher, S., *Enactivist interventions: rethinking the mind*. Oxford: Oxford University Press, 2017.
- Gibson, J.J., *The Senses Considered as Perceptual Systems*. Boston: Houghton Mifflin, 1966.
- Meillassoux, Q., "Subtraction and Contraction: Deleuze, Immanence, and *Matter and Memory*." *Collapse: Unknown Deleuze* III (November 2007): 63-107.
- Peirce, C.S., "What Pragmatism Is." *The Monist* 15(2) (April 1905): 161-181.
- Reed, E.S. and R. Jones, *Reasons for Realism, Selected essays of James J. Gibson*. Hillsdale, NJ: L. Erlbaum, 1982.
- Teyssot, G., "Architecture as Membrane." In *Explorations in Architecture*, edited by R. Geiser, 166-75. Basel: Birkhäuser, 2008.
- Whitehead, A.N., *Process and Reality: an Essay in Cosmology*, edited by D.R. Griffin and D.W. Sherburne. New York: Free, [1929] 1978.
- Zourabichvili, F., "Six Notes on the Percept (On the Relation between the Critical and Clinical)." In *Deleuze: A Critical Reader*, edited by P. Patton, 188-216. Cambridge, MA: Blackwell, 1996).

Scaling Sensory Experiences

Across Dance, Occupational Therapy and Urban Design

Rennie TANG¹,
 Lisa SANDLOS²,
 Elisa SEIDNER³

Abstract. The disciplines of urban design, occupational therapy and dance share an interest in how sensory experience and human movement impact the way atmospheres are produced. The global pandemic has brought about radical shifts in our sensory experience of the world. Bodily gestures both big and small participate in the creation of unspoken yet acutely felt atmospheres that invoke new modes of attention. The notion of 'scaling sensory experiences' emphasizes that scale is a non-static continually shifting condition that connects bodies and environments. This research calls for a nuanced understanding of other disciplinary worlds in order to plant the seeds for renewed sensory modes of designing, living and dancing that are much needed as we contemplate our post-pandemic atmosphere.

Keywords. Occupational Therapy, Dance, Movement, Sensory, Scaling, Pandemic, Body

Introduction

During the Covid-19 pandemic new forms of sensory experience and patterns of movement in cities emerged as a result of drastic restrictions put on public life. This situation brought about radical shifts in scalar relations within domestic and urban environments. For example, bodily-scaled gestures such as clapping and singing resonated at the scale of the city. In this moment of heightened awareness, we began to consider the potential for re-examining sensory experience and movement through different disciplinary lenses in order to reflect more broadly upon how atmospheres are perceived and produced. As a result, a collaboration was formed between three researchers: Rennie Tang, urban designer and educator in landscape architecture; Elisa Seidner, pediatric occupational therapist (OT) certified in sensory integration, evaluation and interventions; Dr. Lisa Sandlos, dance educator certified in Laban Movement Analysis (LMA).

OT and dance offer in-depth knowledge about the sensing moving body that calls into question the way in which the human body is conceived within the urban design process. One of the most common terms used in design is 'human scale' which refers to the dimensions of the human body in relation to objects in the built environment which should be designed for optimal human use. This anthropometric approach to design denotes a preconceived notion of sociability (Kuchenbuch, 2016, 1045) that glosses over sensory aspects of the moving body. The reductive notion of human scale fails to acknowledge the body as a living being that is continually scaling and sensing space, and thereby shaping it, whether for the purposes of participation in daily life activities

1. California Polytechnic University Pomona, rktang@cpp.edu

2. York University, Toronto, ON, Canada, lisasandlos@gmail.com

3. KidAbilities, Los Angeles, elisa@kidabilitiesla.com

(OT) or expressivity and performance (dance), all of which are also critical considerations in the design of urban environments. The more active term ‘scaling’ suggests that the body could participate in a continuum of scalar relations that change over time as the body moves through space. Atmosphere is produced through the act of modulating across these scales, or put another way “atmospheres change as the body moves through space and is exposed to changing sensory stimuli, and so too does the biological composition of our bodies change as we are exposed to different atmospheres” (Bille, 2015, 36). Another important question we ask is how to design for the human body in a world where the multiplicity of bodies in terms of age, ability, culture and gender cannot be ignored. The pandemic amplifies these multiplicities because each person responds to these new patterns of daily life in unique ways.

The viewpoints of each discipline can offer critical insights into these issues, disrupting assumptions and opening up questions. An understanding of the conventional language or jargon within each discipline is a necessary starting point for moving towards a transdisciplinary mode of working. Using the well-established OT theoretical model Person-Environment-Occupation (PEO) as a template for considering equivalent groupings in urban design and dance, User-Form-Function and Body-Space-Dance are used respectively, as depicted in Figure 1. Each will be highlighted and elaborated upon in this paper. It is our belief that this initial way of entering into the worlds of the other marks the beginnings of a transdisciplinary process.

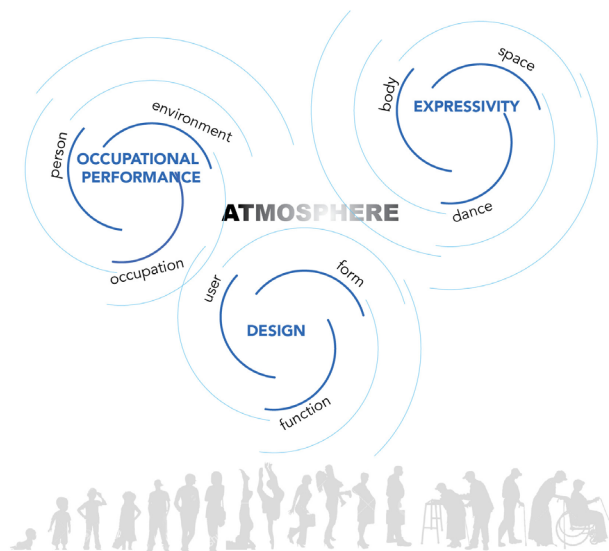

Figure 1. Atmosphere Across Disciplines, Rennie Tang, 29 June 2020.

USER - FORM - FUNCTION (Rennie Tang)

From my standpoint as an urban designer, the extreme scalar shifts experienced while living in the city of Paris during the confinement period reinforce my concerns about fundamental concepts in design while revealing opportunities for new ways of thinking. At the most fundamental level designers are tasked with the shaping of forms in order to fulfill certain functions that are based on the needs of users. For example, an architect might create a layout (form) for a kitchen (function) to serve a family (user). A landscape architect might design a pathway (form) as a means of moving across a park (function) to serve a park visitor (user). At a larger scale, buildings and landscapes

are designed to meet certain programmatic functions. The phrase ‘form follows function’ often associated with modern architecture is problematic because it does not consider site context, resulting in designed spaces that completely ignore their surrounding environment and atmosphere in the quest to fulfill certain programmatic functions. A reversal of this phrase to ‘function follows form’ prioritizes the existing condition (form) of a space, which includes its physical, social and cultural aspects, all of which influence atmosphere. These critical aspects serve as design drivers that must negotiate with or call into question a given function.

Underlying the term ‘user’ is the assumption that spaces for use and consumption must always exist. During the confinement, such spaces were drastically reduced, thus leaving the body on its own to confront space in its purest form which in fact brought sensory experience, movement and atmosphere to the foreground. However, designers typically lack the embodied knowledge required to understand these aspects of space, especially when design standards predicated on ‘human scale’ and ‘best practice’ solutions no longer apply. In fact embodied knowledge could help designers to avoid spaces that lack site specificity and are generic, consumption-centered, inequitable and ill-suited to the needs and potentialities of a wide range of people. With this in mind, the limits of the user-form-function model become quite apparent. Collaborating with OTs and dancers working across a wide range of sensory and movement scales - or scaling - enables designers to broaden and enrich their understanding of sensory experience and its role in producing atmosphere.

PERSON - ENVIRONMENT - OCCUPATION (Elisa Seidner)

As an occupational therapist (OT) specializing in sensory integration, movement, and human participation in everyday tasks, I am interested in assessing the impact of the global pandemic on human function and adaptation. How have sensory perception and ensuing actions been altered due to global restrictions on movement and social interaction? These restrictions have changed environments, routines, and sensorial experiences impacting the perceived atmosphere. The ability to adapt according to the changing environment is assessed through observed participation in everyday occupations (activities); a person’s ability to fulfill self-delineated occupational performance parameters (engagement in purposeful activities). My disciplinary lens considers the invisible neurobiological socio-emotional human components and the visible body movements occurring in direct response to interactions with the environment. Of the range of abilities existing along a continuum, OTs assist with remediating or adapting (scaling) the person’s capabilities or their environment to promote optimal participation in activities of daily living.

The Person-Environment-Occupation (PEO) model is a practice framework used by OTs to explore the relationship between individuals and their environments (Law, 1996). This model captures the essence of a person’s perception, functional ability, and motivation to engage in occupations within the sphere of the external world (see Figure 1 left side). An assumption of this model is that the person is a dynamic and malleable being that continually interacts with the environment. Occupational desires become the motivating factor for engagement with objects and the surrounding space. A person’s physical, emotional, cultural and perceptual qualities influence their motivation to interact with the environment and participate in occupations. The environment either facilitates or constrains occupational performance of the person, depending on abilities and perceptions. A dynamic interaction between the person and the environment is one of reciprocal influence. The environment and/or the atmosphere is also in constant flux depending on the type of perception and interaction it

receives from the person.

The person searches for meaningful engagement in self-prescribed roles and behaviors within varying contexts. These roles and behaviors are determined by a range of physical and mental health factors. The person's lived experience within surrounding environments creates perceived abilities producing action or inaction. Sensory Integration theory, introduced by A. Jean Ayres (1972), describes sensory perception not only occurring via visual, auditory, olfactory, and gustatory channels, but emphasizes central somatosensory and vestibular processes responsible for body awareness and movement. The ability of a person to sense their own body determines movement and interaction within the environment.

Atmosphere emerges from the dynamic exchange of sensory information between the person and the environment. The atmospheric perception may easily shift from optimal to suboptimal in the presence of person-environment discrepancies. The interpretation of each person's atmosphere and the ability to adapt under the pandemic climate, depends on personal, neurobiological and environmental factors, and their compatibility. For those individuals who are highly over-reactive to visual, auditory, and tactile sensory input, the restrictions provide a welcome respite.

Böhme's (1993) description of atmospheric theory as a space in between the subject and object emphasizes the person's subjective experience of the objective environment. OTs delve deeply into the personal perception of the atmosphere as a milieu for human function, yet as a discipline, we lack a more profound understanding of the environment's influence on human perception of atmosphere. The changing environments and atmospheric perceptions experienced during this pandemic will likely impact the quality of the lived experience and the occupational performance that ensues.

BODY - SPACE - DANCE (Lisa Sandlos)

From my perspective as a contemporary dance teacher, choreographer and former professional dancer, dance offers an ideal framework for thinking about bodies and the dynamic potential of spaces. Furthermore, principles of dance training, performance, and choreography can transform atmospheres in a post-pandemic world.

Dancing requires regular physical practice to develop specialized capabilities of the body including flexibility, strength, coordination and balance (functionality) along with esthetic qualities such as dynamic alignment, shape and stage presence (expressivity). These skills allow dancers to project movements into the space so that clear connections between their bodies and the environment can be made visible to audiences. Contemporary dancers train to be highly attuned to space which can inform their movement expression, enrich their performances or help generate original improvisations. Thus, dancers are highly responsive to atmospheres but the movements they do also enliven the space, thereby *contributing* to atmospheres.

Atmosphere is not a term that is generally utilized in dance, but many dancers are familiar with the related concepts 'kinesphere' and 'dynamosphere.' Kinesphere refers to the bubble of space outside the body where movement occurs and dynamosphere refers to dynamic movement qualities originating from an inner impulse to move expressively within one's kinesphere.

Peggy Hackney (1998) asserts that the kinesphere can be "defined physically by the distance that can be reached all around the body" and "psychologically by the space

the mover senses is hers or his, the space s/he effects” (223). Movements in the kinesphere may be minimal and near to the body-center or expansive, involving the entire body; thus, the scale of the body moving in its kinesphere can shrink or grow. Movements within the kinesphere may lead to locomotion in a shared general space. The term ‘dynamosphere’ was originally used by movement studies pioneer, Rudolf Laban, to account for expressive movement (called Effort) that emerges when the kinesphere becomes charged with dynamic modulations and combinations of time, weight, space and flow (Studd and Cox, 2013, 150).

Kinesphere can be revealed through spatial pathways of gestures, but dancers also recognize the interplay between outward expression in the kinesphere and the dynamic space within their bodies. Through sensory-based training, visualization and subtle movement exploration, dancers develop awareness of their internal somatic space, the structural geometry of their skeletons, the tensegrity of their musculature and fascia and their whole-body connectivity. Moreover, dance can be informative not only about the body *in* space but also about the body *as* space.

The methods by which contemporary dancers train and their skills of sensorial attunement, spatial awareness, and qualitative movement expression are valuable in the context of performing. These skills also help dancers cope with the stresses of their careers as performing artists, adapt to a variety of environmental conditions including studios, theaters, or site-specific performance spaces that are not always ideal, relate to other dancing bodies in the kinespheres they inhabit, and communicate their embodied experiences to audience members. Indeed, these skills are transferable; the embodied movement training that dancers do can enhance resilience, creativity and empathy for anyone affected by the Covid-19 pandemic and its aftermath.

From my dance lens, then, it follows that concepts from dance including body *in* space and body *as* space, the continually shifting scale of the kinesphere and expressive movement in the dynamosphere would assist urban designers in deepening their understanding of how human movement can enhance their work. Indeed, in the post-pandemic world I believe it will be particularly important for urban designers to be proactive in building environments and creating atmospheres that invite people to move with a deeper sense of embodiment, connection to space and expressivity.

Conclusion

Our coming together as three distinct, yet overlapping disciplines has the potential to enhance the design of urban spaces by developing a more nuanced understanding of how scaling sensory experiences and human movement contribute to the shaping of atmosphere. In urban design the terms ‘human scale’ and ‘user’ are imbued with assumptions that lack consideration of the sensing moving body. The OT’s focus on the reciprocal relationship between person and environment, offers a means for designers to be agents of atmosphere through the act of adapting - or scaling - an environment in support of human function. Dance highlights the dual consideration of the body *in* space and the body *as* space, along with ‘kinesphere’ and ‘dynamosphere’ as integral to the creation of atmosphere. Thus, the designer’s focus on physical and material conditions are positively disrupted in light of reflections on atmosphere offered by OT and dance. This supports the idea that “urban development no longer only concerns built forms and spaces, but also sensory environments” (Thibaud, 2014, 40). A cross-disciplinary perspective is needed at the best of times. This is especially true as our world transitions into a milieu of new spaces, new types of human activity and new modes of expression as required in adapting to the impacts of the global pandemic.

References

- Ayres, A. Jean. 1972. *Sensory Integration and Learning Disorders*. Los Angeles: Western Psychological Services.
- Bille, Mikkel. 2014. "Staging Atmospheres: Materiality, Culture, and the Texture of the in-Between." *Emotion, Space and Society* 15: 31-38.
- Böhme, Gernot. 1993. "Atmosphere as the Fundamental Concept of a New Aesthetics." *Thesis Eleven* 36, (1): 113-26. <https://doi.org/10.1177/072551369303600107>.
- Hackney, Peggy. 1998. *Making Connections: Total Body Integration through Bartenieff Fundamentals*. Amsterdam: Gordon and Breach Publishers.
- Kuchenbuch, David. 2016. "In Search of the Human Scale: Delimiting the Social in German and Swedish Urban Planning in the 1930s and 1940s." *Journal of Urban History* Vol. 42(6) 1044-1064.
- Law, Mary, Barbara Cooper, Susan Strong, Debra Stewart, Patricia Rigby, and Lori Letts. 1996. "The Person-Environment-Occupation Model: A Transactive Approach to Occupational Performance." *Canadian Journal of Occupational Therapy* 63 (1): 9-23. <https://doi.org/10.1177/000841749606300103>.
- Studd, Karen, and Laura L. Cox. 2019. *Everybody Is a Body*. Indianapolis: Dog Ear Publishing.
- Thibaud, Jean-Paul. 2015. The Backstage of Urban Ambiances: When Atmospheres Pervade Everyday Experience. *Emotion, Space and Society* 15 (C). p. 39-46.

To Conceive Shared Affective Atmospheres Based on Discomfort Experiences for Autistic Children

Sana LAYEB¹

Abstract. *Autism is one of the most common developmental disorders in the world. It is defined by inadequate interaction and communication. This disorder induces an altered perception. We started from the sources of stress and discomfort in order to create a comforting atmosphere that allows the autistic child to progress in his care center. We so followed a multidisciplinary approach between teams of architects, engineers and child psychiatrists. Our methodology was based on the latest technologies in cognitive science in the capture of the emotional state correlated with the behavioral model, called sensory profile. We aim to propose an architectural space adequate to the sensitive particularities of autistic children in order to guarantee their well-being and comfort.*

Keywords. *Autism, Comfort, Well-Being, Discomfort, Technology, Affective Atmospheres*

Introduction

The child is described as a sensory organ or sensory machine. Children with autism are characterized by their extreme sensitivity to various environmental factors due to their deficits in sensory information processing (Bevan, 2013). The diversity of scales and qualities of environments is therefore a main feature in the conception of spaces for children with autistic disorders. But the most important thing remains the control of these physical environments (lighting, acoustic, etc.) in order to increase the comfort and quality of life of the occupants. The primary challenge is to satisfy the diverse needs of children in order to promote their good development.

This chapter will be structured as follows: in the first part, we refer to some research that has dealt with the links of the child with autism with his external environment. In the second empirical part, we detail the experimental protocol used. In the third part, we present the main results collected. Then, we analyze and interpret the combined data. We will end with conclusions and perspectives.

The Autistic Child's Relationship to the Outdoor Space

Since the second half of the twentieth century, several researchers from different disciplines have tried to define this disorder and identify its specificities. However, the studies that have focused on the relationship of children with autistic disorders to their environment remain limited and very recent. This issue was only discussed by psychologists, pediatricians and designers at the beginning of the 21st century. The preoccupations of some of this research have been focused on the sensory needs of children with autism. A. Brand (2010) and I. Scott (2011) assert the importance of the

¹ *Research Team on Ambiances (ERA), National School of Architecture and Urbanism, University of Carthage, Tunisia, sana.layeb@yahoo.fr*

natural environment as a stimulating environment. It is the most conducive environment for stimulating children's senses, enriching their daily experiences and developing failing senses. In fact, outdoor spaces offer a variety of stimulants appropriate to each season. Earth, sand, stone, wood and water offer rich and varied textures. Some specialists talk about the importance of indoor courtyards that offer a safe outdoor environment. The layout of the courtyard gives the children the opportunity to play freely without feeling obsessively supervised (Bevan, 2013). The apertures around these courtyards provide excellent visibility that allows staff to manage activities from a distance (Whitehurst, 2007). Mullick (2009) describes the impact of 'regular' classroom windows overlooking natural spaces on the behavior of students with autism.

However, architectural guidelines for this spatial quality are limited to quantitative standards. The recommendations found in the state of the art rather evoke the quantity and control of lighting. So, high windows (Whitehurst, 2007), skylights (Henriksen, 2010), awnings or sunshades were strongly prescribed, as they provide a good quantity of natural light.

Methodology

This study examines the influence of different atmospheres on the perception and behavior of children with autism. We were interested in the child's sensitive experiences and more specifically in his perception of stress. From the beginning, this work has required a close collaboration with a multidisciplinary team of architects, engineers, statisticians, therapists and child psychiatrists, working on the observation of the physiological responses of children with autism to different stimuli in their environment. Our field of study was one of the pioneering centers of special education, affiliated to our associative partner, located in the city of Monastir. Our investigation involved 13 children, aged between 4 and 13 years old, including 2 girls and 11 boys.

We chose to follow the autistic child during his typical daily journey in the care center from his arrival in the morning until his departure in the early afternoon. We follow him during his different pedagogical courses, psychomotricity, speech therapy and in the different spaces he goes through. Simultaneously, we capture information on his perception of his environment, through the capture of his emotions. This approach has allowed us to apprehend a reality that is not usually expressible. It is based on a measurement of a physiological signal, corresponding to the child's electrodermal activity (EDA), which varies according to his emotional state and excitement (Boucsein, 2012). It is performed thanks to an innovative technology that supports the individualized nature of autism (Picard, 2009). This technology makes it possible, in real time through an application that can be downloaded via smartphone, to assist the respondent's awakened-state. It consists on an on-board biological sensor, worn on the wrist, from Empatica® and called E4 (Layeb, 2019). At the same time, the morphology of the premises, materials, proportions, colors, ambient effects and all the physical phenomena or environmental factors to which each autistic person was subjected during his or her journey are also identified. Beforehand, we drew up a sensory profile of each investigated child (Dunn, 1997). This is a questionnaire that allows us to understand the behavioral model of these children as well as their hyper or hypo-sensitivity.

The second part of our work consisted of a phase of dividing up the path studied, then analyzing and correlating the various data collected. This allowed us to identify the significant environmental and ambient situations that generate different emotional states. This correlation allowed to propose our spatial corrections and recommendations.

Only the crossing of the different data (physical, physiological), permits to reveal the different connections between the ambient factor, the environmental factor and the emotional state of the person (Layeb, 2016).

Results

We present an illustrative example of the application of this approach to a typical survey, of a 7-year-old boy. The behavior of the electrodermal curve in this case example was typical of all the children in his study profile. For ethical reasons, we have chosen to refer to him by the abbreviation (Di). He is a child with a multiple sensory profile and hypersensitivity. The segmentation and interpretation of his EDA signal reveals three significant electrodermal variations, indicated by (S) in Figure. 1, related to his passage near windows and his reaction to the outside.

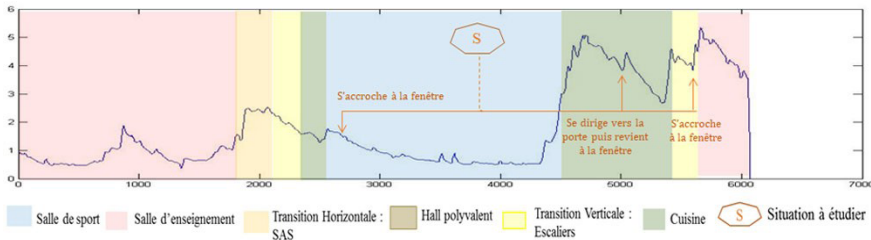

Figure 1. Segmentation and interpretation of the EDA signal of the typical profile (Di), Layeb, 2019

In situ observations have shown that these physiological variations correspond to the repetition of the same behaviour: clinging to a window and looking outwards. Indeed, we noticed that with each movement and in each space we occupy, the little boy (Di) was always attracted by the window. We noted this attitude in the sports hall, the multi-purpose hall and even in the stairwell. Only the sill of the unique window in the central hall corresponds to the child's height, otherwise the others are located at 1.4m. The child always manages (even in uncomfortable situations) to be able to stop and contemplate the outside. All the windows have a spatial and visual clearance. This contact transports the child to new visual atmosphere by contemplation, clear field of vision, new luminous atmosphere by his relationship with the sun's rays, lighting level, new sonic atmosphere by moving away from the interior sounding ambiances, tactile atmosphere on contacting the glass and the aluminium of the window and thermal atmosphere related the climate. We believe that the window represents an emotional and ambient escape for this child. It allows him to escape from all nuisances: noise, lighting and others, towards an alternative atmosphere that allows him to evacuate his emotional overload coming from his multi-sensoriality. The window then becomes, for him, a pretext to escape from disturbing stimuli and an opportunity for an emotional discharge.

Discussions and Recommendations

The relationship with the outside seems to influence the behaviour of some children. Indeed, in our field of investigation, the inside/outside relationship is ensured through doors and windows. The glass windows offer these users a visual escape to the outside landscape. They allow contact with weather conditions (climate), new thermal factors (air, temperature...), with natural light and new sound sources... This experience seems to confirm the importance of opening and inserting the outside into the inside. As we have already mentioned in paragraph III, some researchers recommend designing

spaces with high windows to prevent the disturbance of the child and his escape (Whitehurst, 2007)! Others propose spaces with little glazing, mono-oriented, under the pretext that the bay windows reduce the concentration of children and that the practice of some care's centers install opaque barriers in front of transparent opening to block views.

We have noticed during our bibliographical investigation and our observations in different fields, that the comfort and well-being of these users (suffering from a communication deficiency), are often sacrificed at the expense of the session's progress, thermal comfort, quantitative standards or safety and hygienic reasons. It seems to us that a qualitative reflection favouring the feelings of the child with autism is very desirable (hence the objective of this research) in future designs.

We invite future designers to give priority to spatial arrangements and devices that ensure both adequate natural lighting and openness to the outside. The architectural reflection-oriented atmosphere can also be inspired by introverted devices, such as patios, which ensure both openness to the outside, natural light but while filtering certain undesirable inputs (such as nuisances from neighbours...). This courtyard offers an outdoor space, contained with defined limits. It generates an outdoor space, enclosed inside: this configuration facilitates its understanding by children (Charras, 2012). In order to be able to be interested in the outside, the child with autism wishes to be enveloped by the sphere of the familiar. For them, what is outside the familiar is a source of anxiety and discomfort.

The architect's task in this case would be to widen the scope of the familiar by integrating it in a progressive way, to create atmospheres according to the child's preoccupations and anxiety. The aim is then to strengthen the autistic child's ability to live the changes in his or her living space, in order to prepare him or her for progressive social inclusion. For a better adaptation, we think that the architectural dispositions should inflect a controlled qualitative dimension that can be adapted and modulated, for and by the child. As it can resort to old scholar architectural paradigms, such as garden schools and outdoor or open-air schools (Roth, 1966), which ensure the compromise between teaching and enjoying the outdoors. Two conditions are necessary, which are the possibility to modulate the space and its relationship with the outside. The concept of improving the capacity and spatial readjustment of shared spaces should not be done intuitively, but rather through a therapeutic approach derived from environmental psychology (Charras, 2012). The role of the architect is then to propose a flexible and modular space able to meet the different sensorial needs of all.

Conclusions and Prospects

We believe that any spatial configuration that ensures a balance between the different ambient and functional constraints can provide the well-being and sensory requirements of children with sensory dysfunction. The contribution of the users (children or educators), in an inclusive design, can be solicited in the organization of school spaces in the choice of colors, textures, lights..., to provide transformable, modular and flexible spaces. The role of the architect is then to be able to manage the contribution of future users in order to propose the accommodate space which can appropriate the spatial and ambient transformations and readjustments to be adapt to the needs and sensorial capacities of all. We should note that these architectural guidelines, dedicated to children with cognitive and assimilated handicaps, contribute to the therapeutic recommendations of the educational environments. They respond also to the new concepts of 'ordinary' modern school architecture such as the 'articulated class', the 'open school', or the 'learning street', developed by Herman Hertzberger.

Acknowledgment

The author would like to thank Dr. Naoufel Gaddour, child psychiatrist, associate professor in child and adolescent psychiatry at the Vulnerability to Psychosis Research Laboratory, Monastir Faculty of Medicine, University of Monastir, Tunisia, for his collaboration. We are particularly grateful to the members of the Signal and Systems Unit (U2S) from the National School of Engineering of Tunis (ENIT), especially to Professor Meriem Jaidane and Ms. Raja Ghozi, Assistant Master, Signal Processing Specialists for their help and cooperation. We would also like to express our sincere thanks to Mr. Jean Pierre Péneau, honorary professor of the Schools of Architecture, for having supervised this work and Mrs. Faten Hussein, Assistant Master at the National School of Architecture and Urban Planning of Tunis (ENAU) for her co-supervision.

References

- Bevan, Mina. *Exploring the efficacy of design interventions in a day care center for autistic adults*, Floride: Mastère de design intérieur, université de Floride, 2013.
- Boucsein, Wolfman. *Electrodermal activity*. Allemagne: Université de Wupperta, 2ème édition, 2012.
- Charras, Kevin. "Architecture environnement et maladie d'Alzheimer," Undergraduate Research Journal for the Human Sciences, vol. 9, 2012.
- Henriksen, Kresten. *Supportive learning environments for children with autism spectrum disorders*. Kansas State University, 13 pages, 2010.
- Layeb, Sana. and al., "Q Sensor for the City on the Threshold of Stress: Degenerative Dimension of the Sound Atmosphere", In *Handbook of Research on Digital Research Methods and Architectural Tools in Urban Planning and Design*, H. Abusaada, C. Vellguth, & A. Elshater (Eds.), 121-137, Hershey, PA: IGI Global.
- Layeb Sana. and al. The Sonic Ambiance as a Transforms Operator of our Cities and our Architecture. The case of autistic children and elderly. Nicolas Réemy (dir.) ; Nicolas Tixier (dir.). *Ambiances, tomorrow*. Proceedings of 3rd International Congress on Ambiances, Sep 2016, Volos, Greece. International Network Ambiances ; University of Thessaly, vol. 1, p. 177 - 182, 2016, hal-01409725.
- Layeb, Sana. and al., Caractérisation ambiante des espaces d'accueil pour enfants autistes : vers une projectuelle des ambiances, , 7-9 Septembre 2016, Toulouse, France, pp.163-172.
- Mullick, Rachna. "Incorporating the behavioral dimension in designing inclusive learning environment for autism," Archnet-IJAR, International Journal of Architectural Research, Volume 3, Issue 3, pp. 45-64, 2009.
- Picard, Rosalind. "Future affective technology for autism and emotion communication," Philosophy Transactions of the Royal Society, Biological Sciences, vol. 364, no. 1535, 3575-3584, 12, 2009.
- Roth, Adolf. *La nouvelle école*. Zurich: Editions Girsberger, 1966.
- Whitehurst, Teresa. "Evaluation of features specific to an ASD designed living accommodation". Research and Development Officer Sunfield Research Institute, 12 pages, 2007.

Ambiance Narrative Design as an Innovation Tool

The Boundary Object Concept and Applied Case Study

Laurent LESCOP¹, Eric STEVENS²

Abstract. As *ambiance narratives* offers a unique way to combine representations concepts and perceptions of the multiple actors involved in the creation process, this paper assumes that their systematic use as a boundary spanning mechanism, may contribute to both creativity in the design and to the overall fit with the expectations of the actors of the ecosystem. The use of *ambiance narratives* remains to be explained in such a context as the way they are designed, the process by which they are shared, interpreted and used by the different stakeholders in order to span boundaries has not been explored by research. Based on the case study observations and on the theory of boundary objects and boundary discourse, a new development method is proposed where innovation involves heterogenic stakeholders.

Keywords. *Boundary Object, Narrative Design, Innovation, Ambiance, Hostellery*

Innovation and Architecture

Track 1 : New sensitizations

Architecture is seen as a creative activity, yet the question of innovation in the industrial sense of the term is less present in the literature. Architecture is being assimilated to the creation of prototypes (except perhaps for housing), the distinction between a circumstantial innovation and a global innovation becomes a real subject in itself. In the industrial world, there is an abundance of literature, some examples of which will be given below. In the world of architecture, the diversity in the size of firms makes a global approach difficult. However, the emergence of digital technology has had a strong impact, perhaps less in formal innovation (Picon, 2010) than in the organisational process of firms. In the world of architecture, the diversity in the size of offices makes a global approach difficult. However, the emergence of digital technology has had a strong impact, perhaps less in formal innovation (OECD/Eurostat, 2018) than in the organisational process of firms. Over the last ten years or so, we have seen how BIM, by establishing an organisational model, has turned the life of firms upside down. In the text that follows, we will describe what appears to us to be another type of innovation in the organisation process and which concerns the design of an innovative hotel experience. The innovation would lie not only in the creation of the project itself, but in the articulation of the different phases from the definition of the object to its valorization in social networks, through design, realization, marketing and promotion.

To describe this innovation, we rely on the concept of the *boundary object* and will try to show that it takes a form that we did not anticipate at the beginning of the experiment.

1. ENSA Nantes - CRENAU/ AAU UMR-CNRS1563, laurent.lescop@nantes.archi.fr

2. Corresponding author, ESSCA School of Management, eric.stevens@essca.fr

Notions and References

To manage a project, architects shall overcome barriers established in between each organization, and sometimes within the organization in between its different departments (Carlile, 2002). This issue may be particularly important when the ecosystem is made of heterogenic actors, having different and sometimes divergent concerns and issues. Notably in the case of Public and Private actors being associated in the new building project, long term decisions versus short term reactivity, general interests of citizens versus private profitability, collective decision making versus centralized decision making may lead to misunderstanding or to decisions that do not correspond to the objective of providing innovative design. Thus, **boundary spanning issues** should be considered as an efficient leverage in supporting the capacity to co-create innovative offerings. Four mechanisms may be considered as contributing significantly to boundary spanning: role of boundary spanners (Brown and Duguid, 1998), contribution of boundary objects (Star and Griesemer, 1989), use of boundary discourse and of boundary practices (Rezazade and Hawkins, 2012). Among the four mechanisms, the boundary objects and boundary discourse or narratives deserve more attention in the specific context of architectural innovation and our sensitive experiences are then addressed.

Narratives is a linguistic form used to share and to give sense to individual experience. It is constructed around a plot in which sub-narrative elements, such as events, actors and elements of context, are linked causally to each other (Elliott, 2005). This chain of interlinked events convey description as well as explanations and contributions of the main characters involved. By doing so, they support the sharing of knowledge, the potential role of each stakeholder, the sense of each contribution and result into boundary spanning effects. However, the process by which narratives may be turned into boundary objects and by so used as development tools deserves further investigation.

Research Question: Narrative Design as a Creative Development Process

As we have described, the main issue is to ensure consistency between the concepts, representations and perceptions of all the stakeholders involved in the development process. We believe that storytelling offers a unique and very effective way to both unite a team and release the creativity brakes (Elliot, 2005). The idea being advanced here is that the use of narrative as a systematic process of spanning the boundaries of shared creativity during the design phases and sustaining it over the life of the project concept. The overall adequacy between the initial request and the final proposition is held by all the actors of the eco-system: from the architect to his teams, from the architect's teams to the companies in charge of assisting in the design and realization, then to the managing client, then from the managing client to his own teams, from the teams to the final client and finally, from client to client via building a reputation. At each of these stages, the story becomes the common thread. The comparison between the initial narrative and the one the client appropriates determines the success of the process. However, the use of narratives remains to be explained in such a context, as the way in which they are conceived, the process by which they are shared, and the way in which they are interpreted and used by the various stakeholders to span boundaries have not been explored by research.

Methodology/Approach

The research design involves an action research based on a longitudinal and in-depth case study and which results into the design of two buildings used today to host tourists. The case study that accompanies our reflection is the design of unusual shelters as a light hostelry. For several years now, the hotel offer has been evolving, and rather

than the anonymity of standardised rooms, some customers will prefer the appeal of a unique, almost customised experience. The request, formulated by a semi-public institution, Terre d'estuaire (SPL Loirestua), addresses the following needs: to open up territories, to offer opportunities to discover an unknown environment, to live an exceptional experience, to be in connection with the socio-economic context and to benefit from local synergies for the reception of visitors.

Similar examples exist in many places in the world, but they are very often standard objects (caravans, yurts, recycled vehicles, etc.). The brief was to create original, aesthetic, astonishing and immediately identifiable objects.



Figure 1. Left: La Bienvenueuse, Camille Aubourg, Margaux Dervaux, Cécile Dumont ; Right : Le Caballon de M. Plocq, Aurélie Poirrier, Vincent O'connor, Igor-Vassili Pouchkarevitch-Dragoche

The action research consisted in creating 7 project teams in charge of generating 7 different projects. Each of the project team had to maintain a project diary in order to record the process by which final design was produced. Then, as a development methodology, it was asked the 7 groups start the project by creating a narrative (1 per project) which was due to be inspired by the territory and should express its main features and characteristics as perceived by the group. Then the ambiance narratives produced by groups were proposed to the stakeholders. Narratives proposed were made of both texts, drawings and pictures, with a specific obligation to tell a story. During presentation, stakeholders had to react to stories, giving their perception of the story, its relevance for the territory, the interest and emotions generated, what they do not understand and what seems to be out of their concerns.

Then students had to create first concepts, meaning a definition of the guiding principles which they intend to use in order to generate the detailed elements of the project. This was presented to stakeholders who reacted according to the perceived coherence with accepted narratives and with their own objectives described above. Comments and feedback were then discussed by each group and they had to use this feedback in order to move to the following stage. Then the group had to propose a first draft of the final proposition. The obligation then was to propose a design that included the initial ambiance narratives, the guiding principles and comments and reactions of the stakeholders. Following those presentations and feedbacks, the groups proposed a final project. In our case study, 2 of the 7 projects were selected and eventually realized and implemented.

The data collected for the case research analyzes consisted mainly of multiple sources:

1. First, we gathered all narratives for each of the stages
 - from architect to manager
 - from the manager to the sales and technical teams
 - from sales teams to the end customer
 - from the customer to the customer;
2. Second, semi-structured interviews of 90 to 120 minutes conducted with the project leader was analyzed. The interview was triangulated with the project diaries ;
3. Third, notes from the participation to decision meetings were used. Each project is accompanied by a logbook which describes in detail each of the stages, the maturation work and the intermediary presentations. Each presentation seeks to bring the proposed story to life, making it tangible to the stakeholders.

Given the excellent results (The narrative generates ambiances, practices and forms that anticipate the objects' design, and fit with stakeholders concerns), the development method and story was provided to future hosts as a "rule of the game," as a customer experience guideline. All participants to decision are considered as "boundary spanners" in that they had, to interact with the other actors for the needs of their respective decision. The analysis is based on an inductive logic involving coding (category description), open (comparison, conceptualization, and categorization) and axial (assembly of contents in a grouped manner according to and based on emerging trends) (Gehman et al., 2018).

Narrative Design and Boundary Object

Main Outcomes and Results

The effectiveness of narratives may depend on how successfully it can be used to decontextualize knowledge, on the one side of a boundary, and to recontextualize it, on the other side of a boundary (Hawkins and Rezazade 2012; Corsaro, 2018). This process provided by the narratives may allow parties involved in the process of transforming knowledge across boundaries (Carlile, 2004). Further, as narratives are used as boundary negotiating artifacts along established meetings between actors from different communities (Koskinen and Mäkinen, 2009), they allowed to introduce more creativity along the development process, while observing how constraints (norms, technical, expectations...) may be included in the projects. In the case, the narrative functions as an emergence of the territory and the territory was inspiring, which anchored the narrative in the context. Further, the design was done by impregnating the narrative that federates the project's stakeholders, holds the project's orientation and serves as a translation platform for the stakeholders. The client has been present throughout the process and the narrative supported a better understanding of the decisions and options chosen by the designers.

Based on the case study observations and on the theory of **boundary objects** and boundary discourse (narratives), a new development method is proposed for all contexts where innovation involves heterogenic stakeholders having diverging concerns and issues. The development method includes the interaction process, the characteristics of narratives and their use as boundary object.

Contribution, Results and Discussion

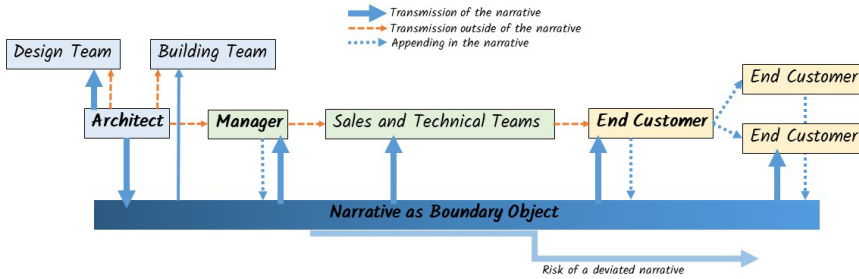

Figure 2. Narrative as Boundary object process

Storytelling as a boundary object structures all the interactions between stakeholders during the development of the project. The permanence of the narrative from conception to exploitation is proof of adhesion to this proposed narrative scheme. First, the architect designs a narrative that he shares with his design team. This narrative feeds and determines the boundary object. The construction teams also immerse themselves in this narrative to understand the general aim of their work. The manager, for his part, feeds into the story and helps to transmit it to the sales and technical teams. In the hotel industry, these are the people in charge of welcoming end customer, the people in charge of maintenance and animation. End customer themselves take ownership of the story, which then influences their experience of their stay. It is obvious here that if there is a disjunction between the narrative and the context of reception, the adhesion of the narrative (and therefore of the accommodation) will not take place. If the adhesion is successful, the host will contribute to the transmission of the narrative. It should be noted that transmissions outside the narrative also exist, they are of a financial, practical or technical kind, and these transmissions must not predominate the narrative. As each step may receive a contribution from the manager or end customer, the strength of the original story should be observed. If it drifts, it is that the story has not been endorsed (or has been poorly endorsed) because of either its weakness or the weakness of the transmission mechanism.

The use of narratives as boundary objects in the context of innovation represent an interesting theoretical development and supports the design of a specific development method. Given that very few researches were produced in context where a group of non-coordinated stakeholders are involved in the development process, such a development deserves further investigation.

References

- Carlile, P. R. (2002) 'A pragmatic view of knowledge and boundaries: Boundary objects in new product development', *Organization science*, 13(4), pp. 442-455.
- Carlile, P. R. (2004) 'Transferring, translating, and transforming: An integrative framework for managing knowledge across boundaries', *Organization science*, 15(5), pp. 555-568.
- Corsaro, D. (2018) 'Crossing the boundary between physical and digital: the role of boundary objects', *IMP Journal*, 12(2), pp. 216-236.
- Elliott, J. (2005). Using narrative in social research: qualitative and quantitative approaches. London: Sage.

Gehman, J., Glaser, V.L., Eisenhardt, K.M., Gioia, D., Langley, A, and Corley, K.G. (2018) 'Finding theory-method fit: A comparison of three qualitative approaches to theory building', *Journal of Management Inquiry*, 27(3), pp. 284-300.

Hawkins, M. A. and Rezazade M, M. H. (2012) 'Knowledge boundary spanning process: Synthesizing four spanning mechanisms', *Management Decision*, 50(10), pp. 1800-1815.

Koskinen, K. U. and Mäkinen, S. (2009) 'Role of boundary objects in negotiations of project contracts', *International Journal of Project Management*, 27(1), pp. 31-38.

Star, S. L. and Griesemer, J. R. (1989) 'Institutional ecology, translations' and boundary objects: Amateurs and professionals in Berkeley's Museum of Vertebrate Zoology, 1907-39', *Social studies of science*, 19(3), pp. 387-420.

OECD/Eurostat (2018), Oslo Manual 2018: Guidelines for Collecting, Reporting and Using Data on Innovation, 4th Edition, The Measurement of Scientific.

Temporary Altered Perception of Birth Space Ambiances

Case of Women in Labor

Ichraf AROUA¹, Faten HUSSEIN¹,
Raja GHOZI², Meriem JAIDANE²

Abstract. The “birth event” is considered as an altered ambiental situation since it affects woman sensibility and causes a temporary alteration of her birth space perception. The study focuses on a spatial characterization of ambiances and analysis of stress level of woman in labor in the Maternity and Neonatology Center of Tunis-Tunisia, captured through ElectroDermal Activity (EDA). This study highlights correlation between stressful ambiental situations, architectural aspects of the birth space and altered perception of women in labor. Capturing emotions and analyzing their impact on perceiving spaces is susceptible to renew the way of understanding ambiances.

Keywords. Altered Perception, Birth Space, Woman in Labor, Ambiental Situations

Introduction

Considering architectural space as a sensitive environment leads us to think about ‘ambiance’, as a key notion to explore deeply a built space. Ambiances contribute to enclose space and its practices. It implies an in-depth reflection on physical, sensitive and social dimensions of architecture. Ambiances depend on space; its features and the user profile.

Ambiental Situation-Perception

The study of ambiance cannot therefore be isolated; it remains an extraction from a social-cultural and spatial-temporal context. It is always situated. Ambiance refers to a defined situation. It is an immediate sensitive experience of a subject through his body in a concrete space and in a defined time. It is based on the situated perception of surrounding environment. It can be defined as the quality of a situation (Thibaud, 2011).

In fact, an ambiental situation is not limited to environment; it is a continuity of a being through his background, practice and emotion. In short it is always depending on the actor of this ambiental scene, how he is, how he perceives and how he acts. “In everyday life, when I perceive, I am always somewhere, exposed to my surroundings and in the process of doing something” (Thibaud, 2002). It’s worth noting here that the space perception is both a physical and sensorial experience. In the visible side, it is drawn as an affective process involving different senses, in the invisible one, as a brain and mental interpretation process. To sum up the balance between the

1. National School of Architecture and Urbanism of Tunis - Research Team on Ambiances ERA, Tunisia, ichraf.aroua@gmail.com, faten.hussein@gmail.com

2. National School of Engineering of Tunis - Research Unit on Systems and Signals U2S, Tunisia, raja.ghozi@enit.utm.tn, meriem.jaidane@enit.utm.tn

surrounding environment and the subject, we must consider his well-being, but it is contextual and depends on every situation (joy, fear, stress...) which transforms his perception of the environment into a modified or 'altered perception'. We qualify it as a distortion of the perception of reality. Among altered ambiental situations, the "birth event" is considered as a complex and ambiguous one since it affects woman sensibility. Then, this study aims to identify stressful situations created following an incompatibility between the physical and sensory capacities of the woman in labor and the physical and sensitive qualities of the space.

Birth Event

Indeed, "birth event" is very significant in a woman life, since it creates an intensive universe of emotions. It marks a physical and social transition (Van Gennep, 2004). A study of the event via ritual theory turns out to be interesting. Ritual theory offers significant insight of the power of this event.

In the case of a rite of passage, the woman in labor goes through three stages: separation, transition and reintegration (Van Gennep, 2004). The first stage corresponds to the "separation" of the ritual subject from society. Birth is an exceptional event that obliges woman in labor to temporarily withdraw socially and spatially from its environment. They leave her daily space to join "other spaces", breaking with traditional time (Foucault, 1986). Here, the hospital, as a birth space, can be described as a space of passage.

At the moment of active labor and of "birth time", woman in labor passes through the stage of "transition". She lives a physical and emotional experience that lead to sensations of pain, power, and stress... that brings up deep feelings of disconnection or isolation. This stage has a potential for change, or transformation and initiation to another level of consciousness (Reed et al., 2016). In this transition period, she is in deeply altered states. At the finally stage "aggregation", or "reintegration" the woman reintegrate society with a new role or state: of mother.

Birth event makes woman live a state of ambiguity. Woman in labor reaches a state of consciousness (Kelpin, 1984) can be qualified as "altered". These states in labor moment represent a time when woman attention is focused on a specific point limiting awareness of other elements present in the environment. Some scientific studies showed that "endorphin hormone" secreted by woman body as response to pain in labor moment participates to change her sensation of the environment. "Endorphin has properties that are similar to drugs of the opiate family" (INSPQ, 2014).

This modification of consciousness state will impact the perception of space and time. Woman creates her "bubble" where her consciousness is modified. The alteration of normal sensory boundaries can change perceptions, including time perception, so that a feeling of fullness can occur (Parratt, 2002).

Methodology

Our empirical study involves quantitative and qualitative methods. For a better understanding of this particular situation, various registers of analyses are adopted in this study as stress signals, spatial qualities, perceptual activity and user behavior.

In order to get closer to the 'reality' of the field, the methodology adopted in this study includes campaigns of ethnographic observations during birth event detailing the attitudes of woman in labor to underline, her perception of the space and its

ambiances. During these observations, a multidisciplinary experimental protocol is applied. It focuses on spatial characterization of ambiances and analysis of stress level of woman in labor in the Maternity and Neonatology Center of Tunis-Tunisia. The latter will be accomplished using ElectroDermal Activity (EDA) tracking that evaluates the arousal via skin conductance measurements and density measures of emotional states levels. Adding to that, there will be recourse to surveys to better simulate and analyze the sensitive experience of woman in labor.

To realize this experimental protocol, a wearable biosensor device called E4 was used. Its role is to measure emotional states (stress, excitement, happiness...). Its data can be visualized by a software “E4 manager”. Our target population was about twelve women in labor aged between 25 and 32 years. The E4 sensor was worn by each woman in the delivery room and the measures stopped when she is transferred to maternity room.

Results

Woman in labor faces a break of her sensitive boundaries during birth event and live a variation of stress levels. Along this work, three situations from “birth event path” are chosen to clearly show how and why a change in perception is witnessed during birth time. Each situation represents a unique emotional situation of the woman and expresses her relation with its environment.

A woman of 30 years old which has had a vaginal delivery without epidural is chosen as a representative study case to show it. The figure 1 below represents the curve of her Electrodermal Activity (EDA) for a recording period of 5 hours done in two different spaces: delivery and maternity rooms.

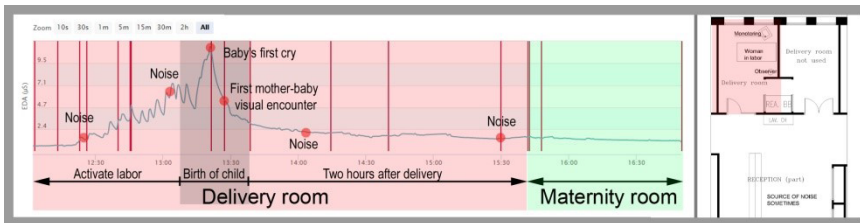

Figure 1. Woman in labor's EDA curve, Ichraf Aroua, 2018

For this study, the analysis concerns only the EDA of woman in delivery room during the child birth. This curve contains specific peaks which represent signals marks corresponding to moments of specific emotion, fear, anxiety or stress. Some are related to physical parameters of space (sound, light, temperature...). In this paper, the stress or emotional peaks analyzed are due to sounds of clinical staff, monitoring machines and baby cry. It's related to some specific sound sources that characterize hospital ambiances. Authors are aware of the importance of all sensory parameters in human perception but we choose to focus on the audio one for a preliminary analysis of EDA signal.

Situation 1: Noisy ambience

In this situation, two stress peaks are identified in different times. The first peak was at the beginning of the experience “activate labor time” while the second was at the end of “two hours after birth”, before her transfer to maternity room. Simultaneously to these peaks, woman in labor was complaining about noise. This was confirmed by woman comments in the activate labor “But what a noise! In addition to monitoring noise their bavaredes bothers me...”. The sound level in this moment is 82 dB(A) but

according to WHO the recommended threshold is not to exceed 45 dB(A). It informs us about the quality of the space. The delivery room is located just in the entrance of the reception which is a crowded space full of sounds (conversation, movement of medical staff, equipment ...) and equipped with a monitoring whose sound is high so that midwife supervises the woman from a far.

For the second peak, the woman complained about the noise coming from the reception; she said: “they picked up their noises, it causes me headaches”. The sound level in this moment is about 64 dB(A). The monitoring is closed after the birth. In both moments the door was open.

Situation 2: Woman in Labor “Birth Moment” Bubble

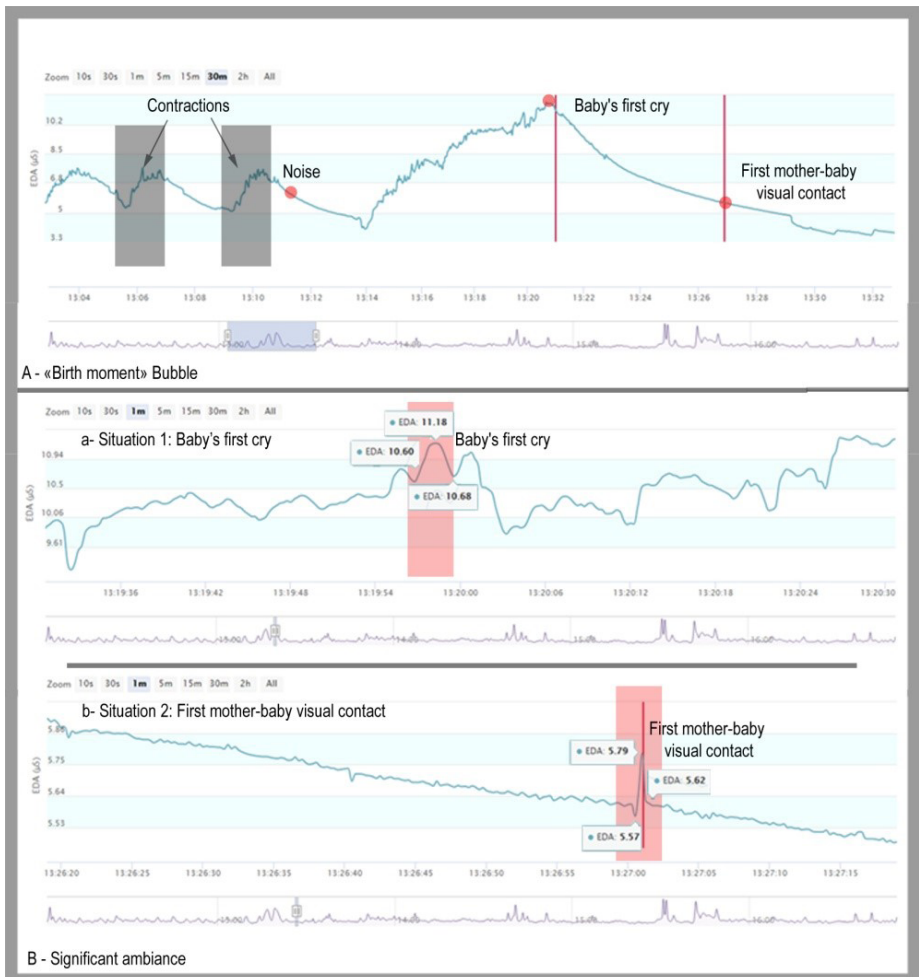

Figure 2. Birth moment bubble and significant ambiance, Ichraf Aroua, 2018

Preliminary observations of the EDA curve show that the amplitudes of the EDA, in the moment of birth, increase to a maximum of about 10 μ S (Figure 2-A) and even more in other cases. The maximum response can be increased up to around 8 μ S in the presence of intensive stimuli (SAAL, 2015) which is rare. This clearly distinguishes the power of the birth event for women in labor.

During childbirth, there are two crowded moments while the correspondent curves have monotonous shapes and show almost no stress peaks. The two moments representing a high level sound are:

- The first one 79 dB(A) just few minutes before the birth.
- The second 64 dB(A) in the beginning of the two hours after birth.

In the first time, there is noise of monitoring and one of the medical staff shouts at the reception and in the second time, there is noise of conversation. The ambiance was crowded while woman didn't reclaim about noise when asking her. Next day of her birth experience, when making survey with her she said: "I don't remember how is the ambiance in the moment of birth; I don't care about all the things that are going on around me. It's just a relief to know at least someone is behind to control and help. I was unable to speak, to see even to hear, I was in 'another world'. Everything is just not important any more than my sensation of pain."

What is important to notice is that the pain factor absorbs the woman and upsets her awareness of those around her and therefore her perception. Several women described this as being in her bubble, in the moment. They feel separated from others and space surrounding. They reach another level of space-time. They remain speechless in front of such situation "birth experience". Midwives described women in labor as disconnected from space and medical staff going right into their own depth of resources.

Situation 3: Significant Ambiance

This two EDA curved (Fig 2-B) show how some moments are very significant and can emotionally affect woman since they are charged with emotions, symbolism and unforgettable memories. These two peaks present emotional peaks; the first baby cry and the first visual contact with her baby. Really it is her discovery so dreamed of her half of the body and the heart long awaited in front of her. When asking a woman she said "in this moment I just remember the first cry and the face of my baby, the rest is flow blurry."

Conclusion

This study highlights the results of a characterization of emotional states of woman in labor linked to "birth event" and all stress and joy linked to such event. This approach revealed that the woman is in a state where her perception of the ambiance is modified or even altered. The approach revealed that various ambiantal situations induced different levels of stress. This is due to the importance of the event from a side, and of the physical ambiances like sound from another side. In several other cases, the peaks of stressful events detected are due to other physical ambiances as light, temperature and some typical sanitized odors of hospitals.

From an ambiantal point of view, we suppose that a well-designed birth space has enough visual and sonic complexity, invokes different levels of stress and arousal and may correct an altered perception. The results of this research are extremely useful to rationalize the choices in design of space birth and considering at the same time the well-being of future mums.

Acknowledgments

The authors would like to thank Professor Jean-Pierre Péneau for his insight and guidance during this study.

References

- Foucault, Michel. "Of Other Spaces". *Diacritics* 16, no. 1 (1986): 22-27.
- Gennep, Arnold van. *Les rites de passage : étude systématique des rites*. Reprint, Paris: Picard, 2004.
- INSPQ. *Le travail et l'accouchement : la préparation, l'accompagnement et les méthodes pour composer avec la douleur*. Rapport d'expertise, INSPQ-Centre d'expertise et de référence en santé publique. Canada : INSPQ, 2014.
- Kelpin, Vangie. "Birthing Pain". *Phenomenology + Pedagogy*, (1984): 178-187.
- Reed, Rachel, Margaret Barnes, and Jennifer Rowe. "Women'S Experience Of Birth: Childbirth As A Rite Of Passage". *International Journal Of Childbirth* 6, no. 1 (2016): 46-56.
- SAAL. *A Guide for Analysing Electrodermal Activity (EDA) & Skin Conductance Responses (SCRs) for Psychological Experiments*. Technical, SAAL- Selective Attention & Awareness Laboratory, *Behavioural Brain Sciences Centre*, University of Birmingham. UK : SAAL, 2015.
- Parratt, Jenny. "The Impact Of Childbirth Experiences On Women's Sense Of Self: A Review Of The Literature". *The Australian Journal Of Midwifery* 15, no. 4 (2002): 10-16.
- Thibaud, Jean-Paul. "The Sensory Fabric Of Urban Ambiances". *The Senses And Society* 6, no. 2 (2011): 203-215.

INDEX OF
AUTHORS,
VOLUME 2

Index of Authors, Volume 2

ALBERTSEN, Niels	34
ALVAREZ COLL, Nuria	272
ANDJELKOVIC, Katarina	96
AROUA, Ichraf	360
AUDAS, Nathalie	126
AUGUST, Karan	336
BAILLY, Emeline	310
BELL, Fredric	316
BERTHELOT, Karl	214
BLAISE, Frédéric	266
BOUBEZARI, Mohammed	136
CASTRO, Raquel	330
CHELKOFF, Grégoire	222
CHEZEL, Edith	168
CRAENEN, Paul	330
CREVELS, Eric	184
DE KERRET, Gwenaëlle	316
DE MATTEIS, Federico	78
DEFFNER, Alex	284
DEPEAU, Sandrine	126
DJEBBARA, Zakaria	336
DUARTE, Cristiane Rose	66, 134, 142
DURANEL, Guillaume	266
EN-NEJJARI, Maroua	322
ERDIM, Firat	238
FLAMPOURIS, Petros	256
FRAIGNEAU, Victor	202
GAVAZZA, Giuseppe	244, 302
GEORGANTZI, Marilena	42
GHOZI, Raja	360
HUSSEIN, Faten	360
IAMPOLSKI, Rachel	154
JAIDANE, Meriem	360

JELIĆ, Andrea	92
KAKALIS, Christos	108
KARAHAN, Sena	148
KHELIFI, Lilia	178
KOLDKJÆR HØJLUND, Marie	36
KOUSOULAS, Stavros	336
LACEY, Jordan	330
LAROCHE, Sylvie	310
LAYEB, Sana	348
LEDUC, Thomas	12
LEVEQUE, Fabian	214
LESCOP, Laurent	354
LOI, Martina	84
LORENZI, Sandra	296
MANOLA, Théa	168
MANTAS, Neoklis	284
MANTZOU, Polyxeni	42
MARAGAÑO LEVEQUE, Andrés	250
MARCHAL, Théo	222, 256
MAROU, Thalia	172
MASSON, Jean-Baptiste	226
MILAGRES, Daniel	278
MOORE, Stephan	330
MORENO SORIANO, Susana	250
MORSELLI, Elisa	78
MRAD, Fatma	60
NÓBREGA, Claudia	278
OCQUIDANT, Olivier	196
PAIS, Maria Rita	54
PALSTRØM, Anders	114
PAMPLONA, Lis	278
PELGRIMS, Claire	208
PIGA, Barbara	26
PINHEIRO, Ethel	134
QUEIROZ, Juliana	72
RADMAN, Andrej	336
RANOCCHIARI, Simone	190
RODRIGUES DE MELO, Natália	142

ROQUET, Paul	14
SALIMBENI, Alice	120
SANCOVSCI, Ilana	66
SANDLOS, Lisa	342
SANTIAGO BAPTISTA, Luís	54
SAULNIER-SINAN, Steven	26
SEIDNER, Elisa	342
SERVIÈRES, Myriam	12, 26
SIOLI, Angeliki	48
STANIČIĆ, Aleksandar	92
STEVENS, Eric	354
TALLAGRAND, Didier	264
TANG, Rennie	342
THEODORSON, Judy	102
THOMAZ, Bárbara	72
TIXIER, Nicolas	264, 290
TORRES TORRES, Edgard	250
TOURRE, Vincent	12
TREACY, Gillian	20
UDSEN, Anne-Sofie	36
UGLIONE, Paula	142
UIMONEN, Heikki	232
VAHDAT, Vahid	102
VUAILLAT, Fanny	126
ZIGONI, Cândida	160
ZONNO, Fabiola	278

Previous Congresses of the International Ambiances Network

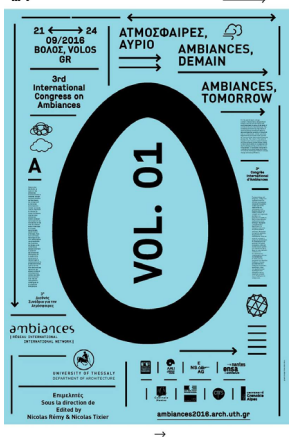

Ambiances, tomorrow
Print & Online Proceedings
<https://halshs.archives-ouvertes.fr/AMBIANCES2016/>
Edited by Nicolas Rémy & Nicolas Tixier
Volos (Greece), 2016

Ambiances in action
Print & Online Proceedings
<https://halshs.archives-ouvertes.fr/AMBIANCES2012/>
Edited by Jean-Paul Thibaud & Daniel Siret
Montreal (Canada), 2012

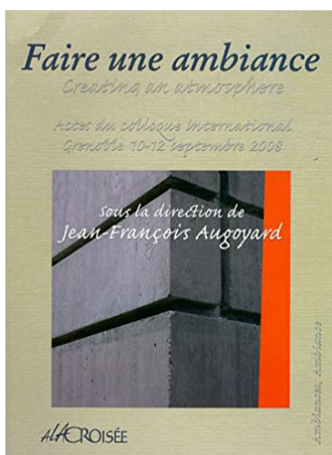

Creating an atmosphere
Edited by Jean-François Augoyard
Grenoble (France), 2008
Published by À la Croisée (Bernin)

4TH INTERNATIONAL CONGRESS ON AMBIANCES
E-CONFERENCE, 2-4 DECEMBER 2020

The topic of ambiances and atmospheres has been unfurling for more than four decades, and the questions associated with it are constantly being renewed. The vitality of ambiance and atmosphere as an object of study and as a field of research and practice is particularly sensitive through the continuous development of the International Ambiances Network.

After the Congresses of Grenoble (Creating an Atmosphere, 2008), Montreal (Ambiances in Action, 2012) and Volos (Ambiances, Tomorrow: The Future of Ambiances, 2016), this 4th International Ambiances Network Congress, entitled "Ambiances, Alloaesthesia: Senses, Inventions, Worlds" questions the renewal of the forms of feeling in a world that is undergoing major changes. It aims to consider how the contemporary environmental, social, technological, political and ethical changes are likely to affect the sensitive worlds, their ambiances, and the ways of experiencing them.

These conference proceedings bring together about a hundred contributions written by an international base of academics, practitioners, artists and PhD students working on ambiances and atmospheres. They offer an up-to-date account of the variety of themes and issues within this field, showcasing the latest research and methodological approaches. Organized in sixteen complementary topics, these chapters examine the ongoing preoccupations, debates, theories, politics and practices of this field, drawing on multidisciplinary expertise from areas as diverse as anthropology, architecture, computer science, cultural studies, design, engineering, geography, musicology, psychology, sociology, urban studies and so on.

30€

ISBN 978-2-9520948-7-0



9 782952 094870

