



**HAL**  
open science

## Towards an advanced mobility of wheeled robots on difficult terrain

Faiz Ben Amar, Guillermo Andrade, Christophe Grand, Frédéric Plumet

► **To cite this version:**

Faiz Ben Amar, Guillermo Andrade, Christophe Grand, Frédéric Plumet. Towards an advanced mobility of wheeled robots on difficult terrain. *International Journal of Factory Automation, Robotics and Soft Computing*, 2007, 3, pp.40-45. hal-03135894

**HAL Id: hal-03135894**

**<https://hal.science/hal-03135894>**

Submitted on 29 Mar 2021

**HAL** is a multi-disciplinary open access archive for the deposit and dissemination of scientific research documents, whether they are published or not. The documents may come from teaching and research institutions in France or abroad, or from public or private research centers.

L'archive ouverte pluridisciplinaire **HAL**, est destinée au dépôt et à la diffusion de documents scientifiques de niveau recherche, publiés ou non, émanant des établissements d'enseignement et de recherche français ou étrangers, des laboratoires publics ou privés.

# Towards an advanced mobility of wheeled robots evolving on difficult terrain

Faïz Ben-Amar, Guillermo Andrade, Christophe Grand, Frédéric Plumet  
Institut des Systèmes Intelligents et Robotique  
Université Pierre et Marie Curie Paris 6 - CNRS  
18, route du panorama, BP61  
92265 Fontenay aux Roses Cedex - France  
email : amar@robot.jussieu.fr <http://www.robot.jussieu.fr>

## Abstract

The paper addresses the problem of mobility of wheeled locomotion on loose and/or rough soils. We study many solutions for improving traction and clearing performances of wheeled systems. The paper focus on (1) traction control of the rolling mode based on a torque limitation (2) traction performance using the crawling mode (or peristalsis mode) and (3) the stability control based on suspension reconfiguration. These works are illustrated through experiments on articulated wheeled robot which are a Marsokhod robot and an hybrid wheeled-legged robot.

## 1 Introduction

Planetary exploration missions with ground vehicles are confronted with a problem of granular non-cohesive loose soil. Even if the gravity on Mars or on the Moon is low, their soils have low density and their compaction by the vehicle's wheels could be significant. In this case, conventional wheeled robots, as they are submitted to high rolling resistance due to wheel sinkage, will have low performance for slope clearing and for traction efficiency. Basically, wheeled robots compared to legged ones are still the best way to move fast with low energy cost and with high payload capacity. So, performance of these robots should be improved in order to increase their traction efficiency, particularly on soft ground. Another issue, is the augmentation of their obstacles clearing ability on rough terrain. This paper gives through an example of an articulated rover, solutions to increase traction efficiency, slopes clearing and stability performances on soft and/or irregular ground.

Wheeled robots traveling on natural rough terrain usually use passive internal mobilities. The main research activity in this area concerns the design of innovative steering and suspension systems. The Rocky rovers [1] and the Shrimp [2], developed respectively at the

JPL and EPFL, illustrate the use of passive suspension systems offering high terrain adaptability. To enhance motion capabilities of wheeled robots on difficult terrains, Wheeled and Actively Articulated Vehicles (WAAV) have been considered. These vehicles are referred as high mobility robots since they possess internal active mobilities, and are illustrated by the WAAV presented in [3] and the Marsokhod [4, 5] robot. Other actively articulated vehicles combine wheels with legs as Workpartner[6], Azimut[7], Hylos [8]), SRR [9].

Non-conventional locomotion modes must be integrated to wheeled platform in order to increase their performance and their accessibility. In addition to the rolling mode, the Marsokhod platform has a crawling mode which is also called peristalsis mode. Peristalsis is commonly known in biology by locomotion of worms and caterpillars. It is also known as the way of the intestinal mobility for physiologist. The used Marsokhod experimental platform, called Lama<sup>1</sup>, has 6 actuated wheels and two intermediate revolute joints between axles for the crawling mode locomotion (fig.1). Section (2) presents a method to reduce the slippage of the rolling mode on soft ground by using a torque control and a measuring preliminary test. Section (3) compares the crawling mode to the rolling mode through an analytical and a numerical models.

We extend the concept of locomotion modes of the marsokhod to another robot with higher mobility. Figure (2) shows the Hylos robot which is a hybrid wheeled-legged robot with 16 degrees of freedom. It can perform numerous locomotion modes as rolling, crawling, rolling with reconfiguration, etc. Section (4) details the rolling with reconfiguration mode while traversing an irregular ground surface and shows the efficiency of the concept in terms of stability and clearance capacity.

---

<sup>1</sup>LAMA is property of LAAS-CNRS



Figure 1: Lama Marsokhod robot

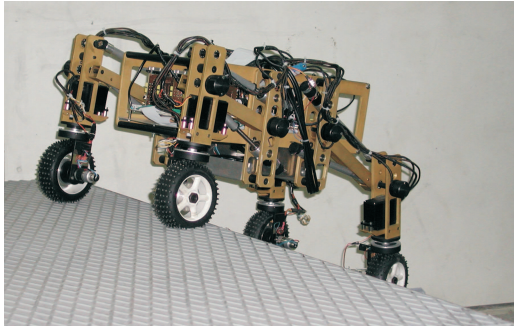

Figure 2: Hylos

## 2 Traction control on non-cohesive ground

This section deals with the control of the rolling mode and the optimization of its traction efficiency. This is especially important on loose soil because high slippage ratio creates an excavation phenomena which increases more the wheel sinkage and can lead to standstill the vehicle. However, a minimal slippage ratio is needed to create a traction force. Traction forces for off-road [10] as well as for on-road are theoretically null for a zero slippage ratio. Longitudinal slippage for a driven wheel is commonly defined by  $s = \frac{r\omega - v}{r\omega}$ , with  $v$  and  $r\omega$  are respectively the real and rolling (without slipping) velocities of the wheel center. This slippage ratio is less than 10% for hard terrain and can reach 40% for very loose terrain.

An optimal slippage exists for each wheel-ground condition [11]. However, this slippage ratio is depending on all ground properties (6) as defined by Bekker [10] (tangential behavior parameters as well as normal behavior ones). We propose here a simple method which guaranties an efficient and bounded slippage ratio. This method is based on a characterization of the maximum friction force that can be applied on the ground. The ground friction identification is processed

by an off-line in situ test. This method assumes that the ground mechanical properties are constant and do not change on the ground area on which the robot evolves. This assumption is generally quite right as the nature of the soil, for planetary exploration for example, can be considered homogeneous per area.

To get information on soil-wheel traction behavior, it is possible to use a special device, but in many cases, a simple and direct test may be performed with only two independent wheels. The robot can carry out a shear test by spinning a pair of wheel, those of the front axle for example, while maintaining the others fixed. By measuring both the current on the actuated axle actuators and its angular motion, we can obtain some features on the tangential wheel-ground interaction. As DC motor with low internal friction reducer are used, the actuator current is directly dependent of the produced torque. Figures (3.a) shows the placement of the force sensor between axles, whereas curve on figure (3.b) represents the measured torque by the force sensor as function of the actuator current during a cyclic wheel rotation. We can estimate that the necessary actuator current to overcome internal friction is about 1.5 A.

An example of shear response carried out on a granular ground is given by the curve of figure (4), where the measured actuator torque is plotted as function of the sliding displacement ( $d = \int r\omega dt$ ). This curve has two different zones : (1) in the left part, traction torque is basically proportional to the sliding displacement; (2) in the right part, traction torque remains stationary around a maximum for any sliding displacement.

On the basis of this plot, one can define a maximum safety torque that guarantees to remain in the left side area. The control strategy is based on a simple limitation of torque under the maximum safety torque which is determined by the traction curve. However, this torque value is proportional to the vertical load applied on the wheel. It is then necessary to compute load distribution on each wheel. This is done by solving a quasi-static model which represent force balance between gravity and contact forces and additional equations which raise what [12] call static-indeterminacy. Theses equations are based on the principle of "zero-interaction".

We have applied this method to control robot orientation on granular soil composed by pozzolana. Figures (5), respectively (6), show the real trajectories given by DGPS and the one computed from wheel's rates and pure rolling kinematic model, when the robot accomplishes an U-shaped trajectory obtained without torque control, respectively with bounded torque con-

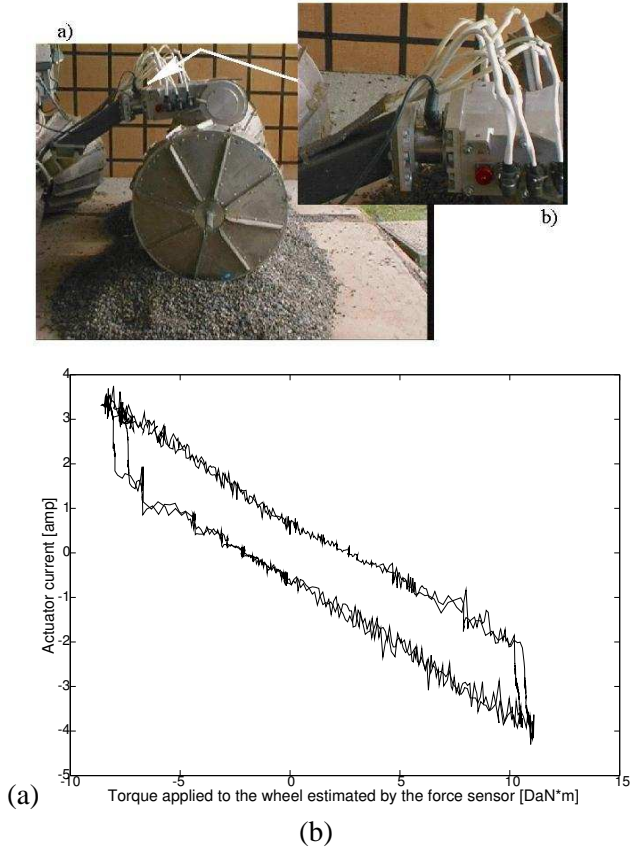

Figure 3: (a) Placement of the 6 axis force sensor between the front and the middle axle for soil shearing test, (b) Torque applied to the wheel as function of the actuator current while a shearing test.

trol. The first one exhibits a great distance between the two curves and thus high wheel-ground slippages. On the other hand, the second one shows that the real trajectory obtained by DGPS, is relatively close the one computed from pure rolling and wheel's rates. This shows that slippage in wheel-ground contact are minimized by using the proposed control method, without loss of velocity displacement.

### 3 Crawling mode vs rolling mode

The goal of these study is to evaluate slopes clearing by each locomotion mode of the Marsokhod robot. This section makes a comparative analysis between crawling and rolling mode for a wheeled-legged robot. We will first use Terramechanics quasi-static models in order to evaluate performance of each locomotion mode. Secondly, a dynamic ground model will be presented and applied to the simulation granular slopes clearance.

Terramechanics deals with performance evaluation of off-road vehicle with relation to soil properties [10].

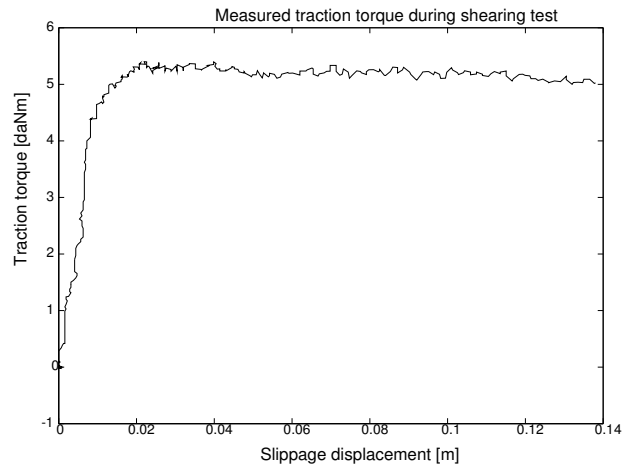

Figure 4: Measured actuator torque during a preliminary shearing test.

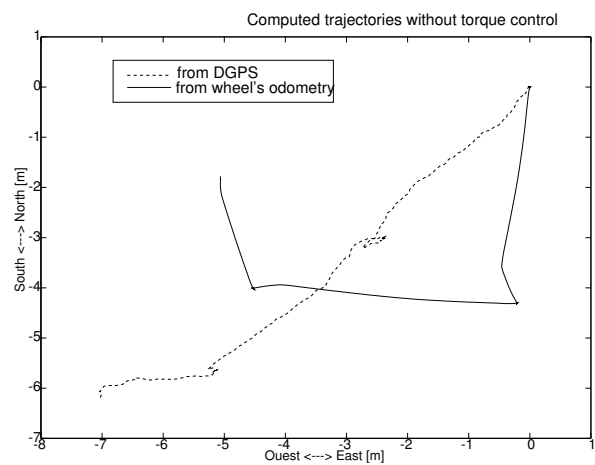

Figure 5: Trajectories computed from wheels odometry and from DGPS without a torque control

We use this theory to predict traction capacity of crawling mode and to compare it to that of rolling one. We assume here a quasi-static 2D motion on a slope of which material is defined by Bekker's parameters.

The total drawbar pull  $DP$  developed by a vehicle, is equal to traction force minus the rolling resistance. Traction force is mainly depending on normal load  $W$ , cohesion  $c$  and internal friction angle  $\phi$  of the terrain surface. However rolling resistance is mainly due to soil compaction and then is depending on normal load and an equivalent soil stiffness  $k_e$ . The force resistance due to soil bulldozing, air resistance, etc are neglected. Terramechanics theory explains quantitatively the difference performance in slope clearing between the rolling and the crawling mode. Crawling mode minimizes the rolling resistance and then maximizes the traction to the detriment of the velocity displacement. However the presented models are quasi-static analysis based.

We are interesting also to the distribution of normal

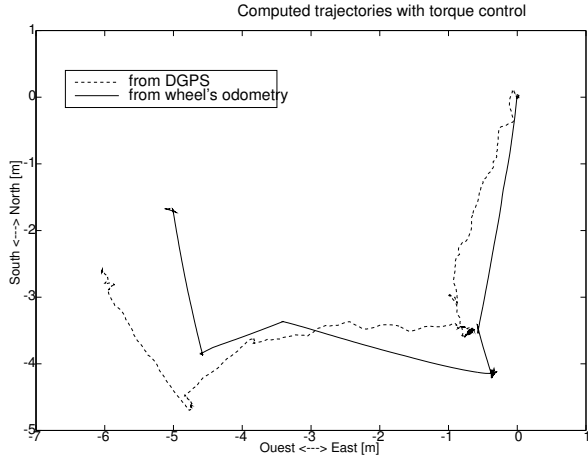

Figure 6: Trajectories computed from wheels odometry and from DGPS with a torque control

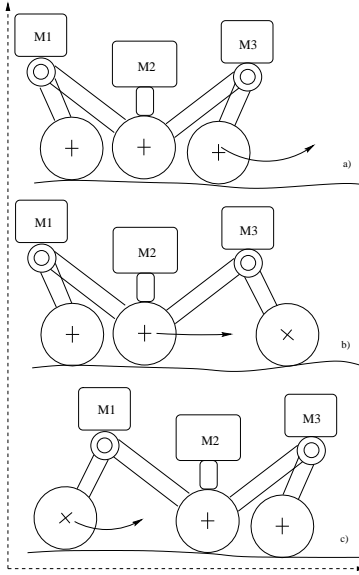

Figure 7: Crawling motion description of the Marshokhod robot

and tangential forces in the wheel-ground contact surface, for rolling mode and crawling modes. We consider the effect of matter flow of soil grains between contacts, ground sinkage due to wheel slippage, etc... Granular soils have complex behavior. One way to model interaction with granular ground is presented in [13]. The method consists in making a partition of the soil in column cells. In every cell, simplified mechanics equations of continuous soil are applied. This simplification allows to reduce computing time in relation to a finite element method. [13] defines a model of interaction between cells by transfer of mass and internal forces. They also defines a dynamic model of cell interaction between a bulldozer and soil. They integrates these cells in a hexagonal network. We use here a similar approach to modelize granular soils. Cell behavior

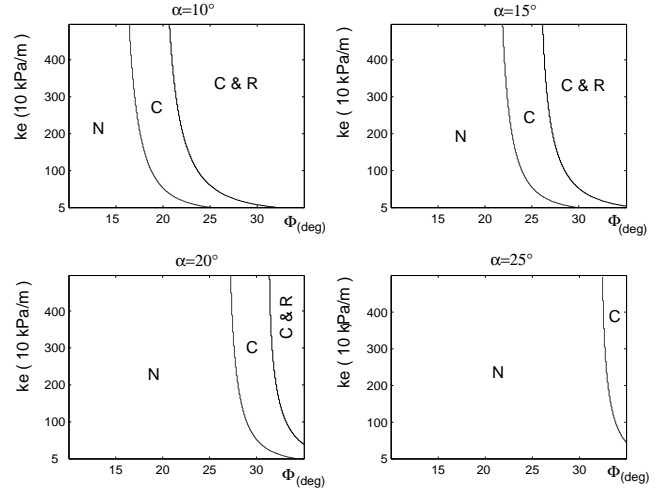

Figure 8: Go/noGo condition as function of internal friction angle  $\phi$  and the soil stiffness  $k_e$  for different slope angle  $\alpha$ . (N) depicts no-go area by neither crawling neither rolling, (C) is a go-area by only crawling and (C & R) is a go-area by both crawling and rolling mode (cohesion  $c = 0.5$  kPa, soil stiffness exponent  $n = 1$ ).

is defined by using experimental stress test carried out on soil column samples.

The soil is divided in column cells. In a planar model, every cell has two neighboring cells. The cell exchanges with its neighbors mass flow produced by internal forces, pressure and friction. The soil surface is stable when the inclination angle is smaller than a limit angle called talus angle. When the slope angle is higher than the talus angle or when the slope angle is close to the talus angle and a perturbation occurs, then an avalanche happens. This avalanche stops when the slope has an angle smaller than the angle of dynamic stability. This angle is smaller than the talus angle.

The interaction between the robot surface and the soil may be decomposed in two parts (1) a mainly vertical robot-soil interaction which is the result of gravity. Soil elements are compressed by the wheel surface (2) soil shearing by wheel paddles and by the friction between the wheel surface and the soil grains.

For vertical interaction, we use curves which provide the response of a soil sample to a triaxial test.

Figure (9) represents the robot in the longitudinal-vertical plane. The circles represent the wheels, linked by segments. Wheel angular position is provided by a radial segment. Figure (9) shows normal and tangential force distributions under a tractive rolling wheel in rolling mode.

Figure (10), shows force distributions under the locked front wheel in crawling mode. This phase corresponds to the last configuration (c) of the crawling cycle represented in figure (7).

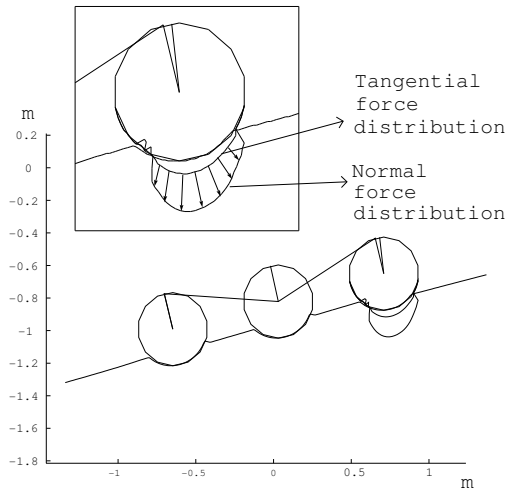

Figure 9: Rolling mode simulation and force distribution under a rolling active wheel.

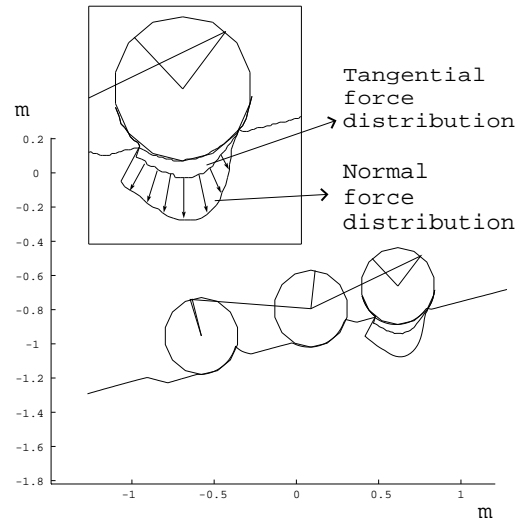

Figure 10: Crawling mode simulation and force distribution under a locked passive wheel.

We can remark that for the rolling wheel, the projection of normal forces along the longitudinal forward direction is negative, this component is the "rolling resistance due to soil compaction". However, for a locked wheel in crawling mode, this projection is slightly positive. Nevertheless, the tangential force distribution are equivalent for the two modes. One must notice that during the crawling mode, the wheel is supported by an accumulation of stable matter behind it, and this stability is possible only when this accumulated matter slope angle is less than the talus angle. Therefore, the crawling mode is limited to granular sloping ground whose angle is less than talus angle.

#### 4 Rolling with reconfiguration mode

Hylos (fig.2) is a wheel-legged robot with 16 degrees of freedom. It is approximately 70 cm long and weights 12 kg. It has four legs each combining a 2 degrees of freedom suspension mechanism with a steering and driven wheel. Each leg is composed of two 20 cm length link driven by two electrical linear actuators and the wheel radius is 6 cm. This mechanism can be seen as a large displacement active suspension.

Hylos can perform many locomotion modes. Mainly, rolling is efficient on flat firm ground, crawling for soft granular ground and rolling with reconfiguration for crossing uneven rough surface. In this later locomotion mode, the internal active mobilities are used to optimize the posture in order to enhance the locomotion performance. The used criteria are the tipover

stability margin and the wheel-ground contact force balance. A suboptimal posture of the robot that optimize the normal component of contact force is defined [8]. The normal forces balance is optimized by assuming the distribution of vertical component of contact forces. Because of the particular design of Hylos, this corresponds to maintain the roll angle to zero, and to configure each leg in such way that projected distances between contact points and the platform center of gravity are equal. The other posture parameters that are the ground clearance, the pitch angle and the nominal wheelbase are specified by a high level controller with respect to the platform task (vision, manipulation). This locomotion mode is adapted to irregular ground without high discontinuities like sloping ground or rough terrain. Figure (11) depicts Hylos evolving on an asymmetric irregular ground with maintaining constant its configuration (roll and pitch angles and platform height). Figure (12) represents the roll and pitch angles as function of time while crossing the irregular ground profile shown in fig.11. These attitude angles are maintained relatively close to zero and thus demonstrate the feasibility of the proposed control concept. This experiment shows a very good stability of the motion, however the rover does not success traversing the same ground profile with pure rolling motion, since a tipover instability was observed.



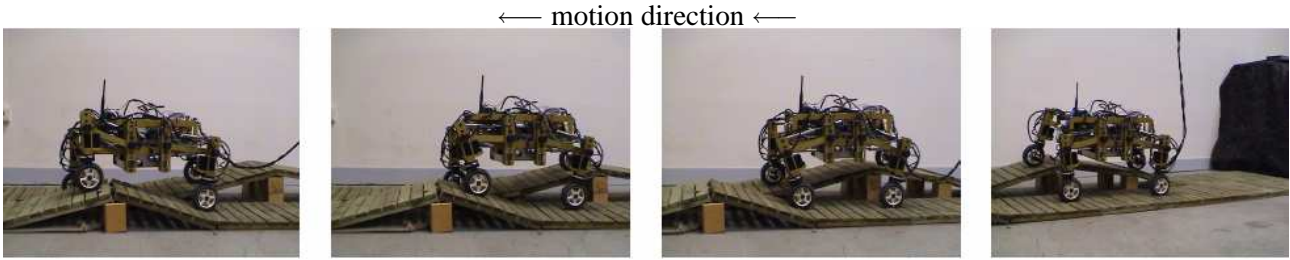

Figure 11: Hylos evolving on an irregular ground profile with a constant nominal configuration.

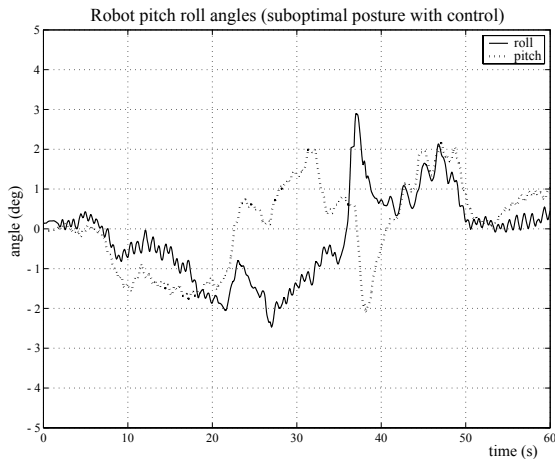

Figure 12: Pitch and roll angles while crossing the irregular ground profile of figure (11).

## 5 Conclusion

This paper shows how soil interactions study is important for performance optimization and control of off-road robot. A simple method which reduces slippage and increases the traction efficiency is presented and validated on a Marsokhod. This method should be extended to carry out on-line detection of soil properties change. A non-conventional locomotion mode, looking like crawling, is evaluated and compared to the rolling one through (1) a Terramechanics quasi-static based model, and (2) a numerical dynamic model. Finally, the paper presents the Hylos robot, which is a multi-mode locomotion platform, and focus on a new locomotion mode which is a hybrid rolling-walking mode. Results carried out demonstrate high stability and clearance capacity. A new and more powerful platform similar to Hylos is under construction. It will be equipped with stereo vision for measuring both geometric and physical properties. Those measures will be used to define the locomotion mode which would be well-adapted to the local terrain conditions.

## References

- [1] R. Volpe. Rocky 7: A next generation mars rover prototype. *Journal of Advanced Robotics*, 11(4):341–358, 1997.
- [2] T. Estier, Y. Crausaz, B. Merminod, M. Lauria, R. Piguat, and R. Siegwart. An innovative space rover with extended climbing abilities. In *International Conference on Robotics in Challenging Environments*, Albuquerque, USA, 2000.
- [3] S.V. Sreenivasan and K.J. Waldron. Displacement analysis of an actively articulated wheeled vehicle configuration with extensions to motion planning on uneven terrain. *Transactions of the ASME*, 118(6):312–317, 1996.
- [4] G. Andrade, F. BenAmar, Ph. Bidaud, and R. Chatila. Modeling wheel-sand interaction for optimization of a rolling-peristaltic motion of a marsokhod robot. In *International Conference on Intelligent Robots and Systems*, pages 576–581, 1998.
- [5] A.L. Kemurdjian. Planet rover as an object of the engineering design work. In *IEEE International Conference on Robotics and Automation*, pages 140–145, Belgium, 1998.
- [6] A. Halme, I. Leppänen, S. Salmi, and S. Ylönen. Hybrid locomotion of a wheel-legged machine. In *International Conference on Climbing and Walking Robots*, Madrid, Spain, 2000.
- [7] F. Michaud and al. Azimut, a leg-track-wheel robot. In *IEEE Int. Conference on Intelligent Robots and Systems*, pages 2553–2558, 2003.
- [8] Ch. Grand, F. BenAmar, F. Plumet, and Ph. Bidaud. Stability and traction optimisation of high mobility rover - application to hybrid wheel-leg rover. *The International Journal of Robotics Research*, 23(10-11):1041–1058, 2004.
- [9] K. Iagnemma, A. Rzepniewski, S. Dubowsky, and P. Schenker. Control of robotic vehicles with actively articulated suspensions in rough terrain. *Autonomous Robots*, 14(1):5–16, 2003.
- [10] M.G. Bekker. *Introduction to terrain-vehicle systems*. Ann arbor, Univerity of Michigan Press, 1969.
- [11] J.Y. Wong. *Terramechanics and off-road Vehicles*. Elsevier, 1989.
- [12] K. J. Waldron. Force and motion management in legged locomotion. *IEEE Journal of Robotics And Automation*, RA-2(4):214–220, December 1986.
- [13] Xin Li and J. Michael Moshell. Modeling soil: Realtime dynamic models for soil slippage and manipulation. In James T. Kajiya, editor, *Computer Graphics (SIGGRAPH '93 Proceedings)*, volume 27, pages 361–368, August 1993.