



HAL
open science

Simulation and control of high mobility rovers for rough terrains exploration

Christophe Grand, Faiz Ben Amar, Frédéric Plumet, Philippe Bidaud

► To cite this version:

Christophe Grand, Faiz Ben Amar, Frédéric Plumet, Philippe Bidaud. Simulation and control of high mobility rovers for rough terrains exploration. IARP/HUDEM'02: International Workshop on Robots for Humanitarian Demining, 2002, Vienne, Austria. pp.51-56. hal-03135890

HAL Id: hal-03135890

<https://hal.science/hal-03135890>

Submitted on 9 Feb 2021

HAL is a multi-disciplinary open access archive for the deposit and dissemination of scientific research documents, whether they are published or not. The documents may come from teaching and research institutions in France or abroad, or from public or private research centers.

L'archive ouverte pluridisciplinaire **HAL**, est destinée au dépôt et à la diffusion de documents scientifiques de niveau recherche, publiés ou non, émanant des établissements d'enseignement et de recherche français ou étrangers, des laboratoires publics ou privés.

SIMULATION AND CONTROL OF HIGH MOBILITY ROVERS FOR ROUGH TERRAINS EXPLORATION

Ch. Grand, F. Ben Amar, F. Plumet and Ph. Bidaud

*Laboratoire de Robotique de Paris, Université de Paris VI
18, route du Panorama, 92265 Fontenay-Aux-Roses, France
E-mail: christophe.grand@robot.jussieu.fr*

Abstract

This paper reviews works performed in our lab concerning the optimisation of locomotion performances for high mobility rovers evolving on rough terrains. Design and control of redundantly actuated locomotion systems are investigated in the aim to improve the field of accessible terrain for autonomous exploration. Main targets of such studies concern the off road locomotion in difficult environment like in volcanic or planetary exploration.

keyword: hybrid locomotion, reconfiguration, force balance, stability, wheel-ground interaction.

1 Introduction

Design and control of high mobility rovers is a possible way to enhance the field of accessible terrains for autonomous or teleoperated unmanned ground vehicle [1, 2]. Actually, this kind of vehicle is able to perform complex motion like hybrid locomotion, and offers re-configuration and terrain adaptation capabilities.



Figure 1: the mini-rover prototype

This paper presents our research activities that concern: the rover-soil interaction model used for traction control and its in-situ identification procedure, the simulator used for evaluation of the rover locomotion behaviour on soft soil, and control algorithms

that enhance the rover locomotion performances. For each topic, the preliminary results are presented.

Hybrid locomotion systems take both advantages of wheeled and legged vehicles that are first: the payload, the velocity and energy consumption, and secondly: the stability, the high adaptability and obstacles clearance capabilities. We have developed such kind of hybrid locomotion system that is the mini-rover prototype shown in figure 1.

It is a high mobility redundantly actuated vehicle and it is approximately 40 cm long and weights 10 kg. It has four legs each combining a 2 DOF suspension mechanism associated with a steering and driven wheel. Thus, this 16 DOF system inherits advantages of both legged and wheeled vehicle. The mini-rover is also equipped with: two inclinometers to get information on platform orientation and a 3 components force sensor on each leg to measure contact forces. The 16 actuated mobilities provide the system with the ability: to permanently maintain the four wheels on the ground during displacements on uneven surfaces, to increase ground clearance, to increase the stability and the traction by controlling force balancing through the reconfiguration of the mini-rover. Moreover, this kinematics structure allows the use of secondary locomotion modes like the peristalsis mode (crawling motion), and high obstacle-clearing mode based on a coordinated wheel-leg motion.

Peristalsis locomotion performed by the LAMA¹ rover shown in figure 2, have also been analysed. This system is a Marsokhod-type mobile robot [3] which has six actuated wheels connected on three axles. This axles are connected through two actuated rotational joints. All these mobilities provide the system with the ability to perform peristalsis motion that consist to move the inertial center by controlling the coordinated motion of wheels and axles. A previous experimental study [4] have shown that peristaltical motion is more adapted to climb slopes on granular soil than purely rolling motion. In the best case on granular soil, this

¹LAMA is property of ALCATEL-ESPACE

mobile robot is able to climb over a 25 degrees slopes by the use of rolling motion whereas it can climb over a 30 degrees slopes performing the persitaltical motion.



Figure 2: the LAMA rover.

2 Wheel-soil Interaction Model

Optimisation of the traction performances plays a fundamental role in locomotion of vehicles on natural outdoor terrains: sand, clay, mud, or snow ... The traction control deals with the optimisation of the wheel torque which is directly related to the tractive force. This control algorithm interests the analysis of the longitudinal wheel slippage ratio which is defined as the relative difference between the ideal rolling velocity and the real velocity of the wheel center. This slippage is necessary to develop a traction force and particularly on soft soils[5]. The traction force depends also on soil parameters, normal force, contact geometry, wheel stiffness, and crampon geometry... In the case of our mini-rover, the characterization of the interaction can be done in situ by locking 3 wheellegs and proceeding to a shearing (and/or a compression) test of the local soil by acting on the fourth wheelleg. These tests need to measure of the normal and tangential contact force, and the slippage ratio that can be computed from the joint velocities of the actuated wheelleg. This experiments is similarly done by using a Scara manipulator with driven wheel associated to a 6-axis force sensor[6].

Figure 4a represents experimentally measured tangential force coefficient commonly called the drawbar pull coefficient which is equal to the difference between the tractive force (thrust) and the rolling resistance divided by the vertical load. The rolling resistance is mainly due to soil compaction and wheel sinkage. The curve corresponding to zero slippage ($s = 0$) represents the rolling resistance since the tractive force is theoretically null when there is ideally rolling. The drawbar pull coefficient is given on figure 4b as a func-

tion of the slippage for different vertical loads. The obtained curves could be then represented by analytical relations (similarly to Bekker's relations for rigid wheels) characterising the global wheel-ground interaction. The gaps between the 3 curves represent the rolling resistance which increases more quickly than the tractive force when the normal load increases because the sinkage increases more quickly than the contact area. The knowledge of the wheel-ground interaction allows to define the most suitable torque for the tractive wheel which is controlled through the use of courant sensor on each motor.



Figure 3: Testbed of wheel-sand interaction with a Scara manipulator.

This method has the advantages to be simple to implement and to be based on few sensors and some preliminary in situ tests of wheel-soil interaction. This method assumes that the mechanical properties of the wheel-ground properties are constant per area and must be completed to integrate rules for detecting soil properties changes.

3 Simulation of the Locomotion on Uneven Terrain

Preliminary design and locomotion algorithms are evaluated through simulation of the dynamics behaviour of the vehicle evolving on uneven terrain. To achieve these simulations, we have developed a simulation tool that integrates the whole dynamics of multibody systems, the behaviour of soft soil and the interactions between the soil and the locomotion organs[7, 8]. The simulator is based on a model describing the deformation of the ground submitted to external forces. Figure 5 shows an illustration of this simulator.

Due to its highly generic modelling approach based on the Lagrangian Multipliers method[9], this simulator allows to evaluate the dynamic behaviour of various mobile robot evolving on rigid surface or soft soil

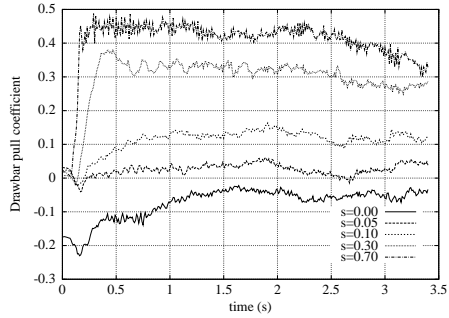

(a)

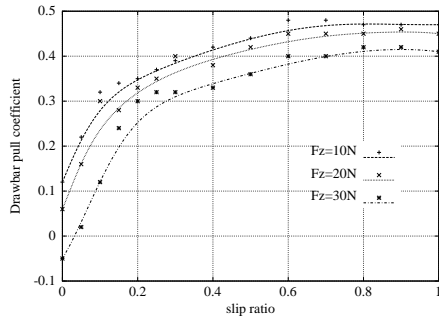

(b)

Figure 4: (a) Tangential force coefficient of wheel-ground contact for a constant force $Fz = 30N$ and for different slippage ratio, (b) drawbar pull as function of the slippage ratio for different values of vertical loads

like sand. The geophysical properties of the ground are experimentally defined by a triaxial test performed on a sample of soil. A semi-empirical model is used to introduce the reaction force between the multi-body system and the ground.

The definition of the ground geometry is based on frequency synthesis that allows to generate realistic artificial terrain [10]. By observing natural forms, it was established that landscape forms have an A/f^p frequency spectra where A defines the roughness and p relates to the fractal dimension. So, by using the spa-

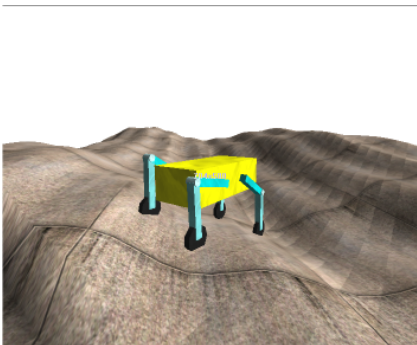

Figure 5: illustration of the simulator

tial inverse Fourier transform of this spectral signal, an altitudes map of considered terrain is computed.

4 Locomotion modes

The mini-rover previously presented in the introduction is able to perform different locomotion modes. This paper is focusing on the rolling motion mode with a reconfiguration of the platform attitude (i.e. pitch and roll angle). The reconfiguration capabilities are exploited in the aim to investigate control algorithms that enhance both the rover stability and the global traction performance [11].

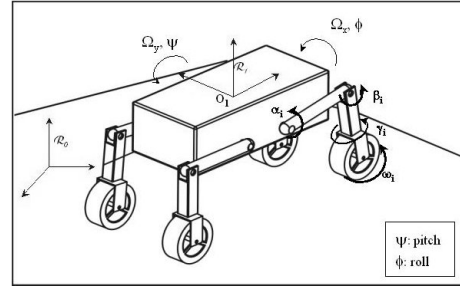

Figure 6: results on the stability control algorithms

The platform attitude control consider the orientation of the platform frame given by the three conventional roll-pitch-yaw angles (ϕ, ψ, θ) and it is based on the definition of a stability and force-balance criteria. Furthermore when the system is moving, the tangential plane of wheel-ground contact is difficult to determine from the force sensor measurements. So, we will assume that the contact planes stay horizontal, i.e., the ground is represented instantaneously by four discrete horizontal planes with different altitudes. Last as the mini-rover velocity is low enough, only quasi-static stability is considered.

The aim of the control algorithm is to reach the most stable configuration from the current rover state. In these conditions and by considering quasi-static analysis of forces distribution, we can assume that the rover stability is maximum when vertical component of contact-forces are equal on each leg. It is well known that vertical contact-forces balance can be reached by minimizing the projected distance, on horizontal plane, between the rover center of gravity (c.o.g) and the geometric center of wheel-ground contacts. Moreover, this criterion also optimizes the traction force distribution. Consequently, if the ground is locally homogeneous in terms of its physical properties, the global traction of the propulsion system is enhanced.

By taking these assumptions into account, constraint equations that are compatible with the stability criterion are defined. Due to the particular design

of the mini-rover, the sideways force balance, in the front view, is obtained by constraining the platform roll angle to zero. The second constraint concerns the forces balance in the sagittal plane, on right and left sides. It is reached when each side wheelbase are constrained in such ways that the projection of the c.o.g is in the middle of wheel-ground contacts. Then, two other free parameters need to be constrained: the ground clearance and the pitch angle. The ground clearance defined as the mean altitude of each wheel is constrained to reach a desired value. This value is computed from a global planning algorithm under geometrical constraints. The pitch angle is set to zero that is well adapted when sensors like laser telemeter or vision system are used.

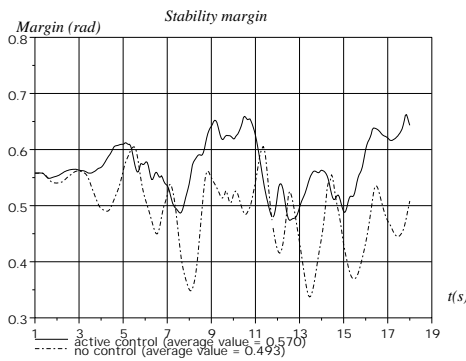

Figure 7: results of the stability control algorithms

Then, the control algorithm consist to compute the mini-rover configuration (i.e. the position of each 2 dof legs) that is compatible with the previously defined constraints. To perform the reconfiguration when the system is moving a velocity model based control have been developed. This consists to constraint the platform rotational velocity to reach the desired roll and pitch angle through a feedback control from inclinometer measures. And the vertical velocity of the platform is controlled to reach the desired ground clearance.

The control algorithm of the rover stability is described more accurately in [11]. This algorithm has been studied by using the simulator presented in section 3, for a rover evolving on a rough terrain with a velocity of 0.3 m/s. The results in figure 7 shown the stability margin of the rover during is motion when reconfiguration control is active or not. The stability margin is computed from geometrical criterion defined in [12] and is given in degrees. These curves show that the mean stability of the system performing stability control is 17% greater than with a fixed configuration. The minimum stability value is 27° in the case where stability control is used, and is 19° in the other case.

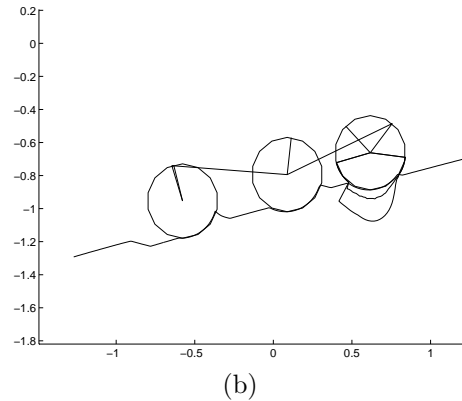
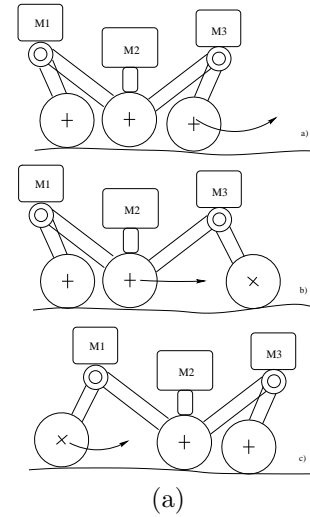

Figure 8: (a) peristaltical motion with LAMA rover[4]
(b) contact forces distribution during peristalsis locomotion.

This represents an enhancement of the minimum stability margin about 40%.

Peristalsis locomotion is also analysed through simulations and experiments. These analysis are performed on the LAMA rover: we use its dynamics model for simulation of peristalsis locomotion on sandy soil[8]. Peristaltical motion improve the global traction efficiency on granular soil like sand. The simulation shows that the tangential contact forces that provide the traction forces are more homogenously distributed in the case of the peristaltical motion than in the purely rolling motion. And all the simulations show that the maximum slope such rover can climb over is increased by 17% when using the peristaltical motion. Experiments are also performing on the mini-rover in the aim to analyse for such kind of rover kinematic this locomotion mode and how it can improve the locomotion performance on soil made in granular media.

5 Conclusion

A global view of the research activities developed at the LRP that concern the locomotion of high mobility rover have been presented. The main objective of such research is to provide systems that are able to adapt their behaviour by them self, according to the locomotion environment variations in terms of its geometrical and physical properties. A model of the wheel-ground interactions that allows to perform a traction control of the rover from few sensor measures and a in-situ characterisation test have been proposed. A simulation tools used to analyse more precisely the dynamics behaviour of such complex rover evolving on complex soil has been described. And last, algorithms for the control of the hybrid locomotion modes and their performances have been analysed. All these analysis are the necessary preliminary studies for a more challenging research on the global optimisation of the locomotion on uneven and complex natural terrain.

References

- [1] K.Iagnemma, A.Rzepniewskia, S.Dubowsky, P.Pirjaniab, T.Huntsbergerb, and P.Schenker, "Mobile robot kinematic reconfigurability for rough-terrain," in *Proceedings SPIE's International Symposium on Intelligent Systems and Advanced Manufacturing*, August 2000.
- [2] A.Halme, I.Leppänen, S.Salmi, and S.Ylönen, "Hybrid locomotion of a wheel-legged machine," in *Proceeding CLAWAR's of the International Conference on Climbing and Walking Machine*, (Madrid), 2000.
- [3] A. Kemurdjian, "Planet rover as an object of the engineering design work," in *Proceedings ICRA's of the International Conference on Robotics and Automation*, (Belgium), pp. 140–145, 1998.
- [4] G.Andrade, F.BenAmar, Ph.Bidaud, and R.Chatila, "Modeling wheel-sand interaction for optimization of a rolling-peristaltic motion of a marsokhod robot," in *Proceedings IROS's International Conference on Intelligent Robots and Systems*, pp. 576–581, 1998.
- [5] M. Bekker, *Introduction to terrain-vehicle systems*. The University of Michigan Press, 1969.
- [6] J. Wong, *Terramechanics and off-road Vehicles*. Elsevier, 1989.
- [7] C. Grand, F. B. Amar, P. Bidaud, and G. Andrade, "A simulation system for behaviour evaluation of off-rooad mobile robots," in *Proceedings CLAWAR's of the International Conference on Climbing and Walking Robots*, (Germany), pp. 307–314, 2001.
- [8] G. A. Barroso, *Modélisation et Adaptation du Mouvement de Robot Tout-Terrain*. PhD thesis, Université de Paris VI, 2000.
- [9] P. Nikravesh, *Computer-Aided Analysis of Mechanical Systems*. Prentice-Hall, 1988.
- [10] B.Mandelbrot, *The fractal geometry of nature*. W.H. Freeman, 1982.
- [11] Ch.Grand, F. Amar, F.Plumet, and Ph.Bidaud, "Stability control of a wheel-legged mini-rover," in *Proceedings CLAWAR's, 5th International Conference on Climbing and Walking Robots*, pp. 323–329, 2002.
- [12] E. Papadopoulos and D. Rey, "A new mesure of tipover stability for mobile manipulators," in *Proceedings ICRA's of the International Conference on Robotics and Automation*, pp. 3111–3116, 1996.