



HAL
open science

Multi-criteria decision aiding for the integration of photovoltaic systems in the urban environment: the case of the Greater Geneva agglomeration

Martin Thebault, Vincent Clivillé, Lamia Berrah, Leon Gaillard, Gilles Desthieux,
Christophe Ménézo

► To cite this version:

Martin Thebault, Vincent Clivillé, Lamia Berrah, Leon Gaillard, Gilles Desthieux, et al.. Multi-criteria decision aiding for the integration of photovoltaic systems in the urban environment: the case of the Greater Geneva agglomeration. *Territorio*, 2020, 1, pp.9-30. <10.14609/Ti_1_20_1e>. <hal-03134928>

HAL Id: hal-03134928

<https://hal.science/hal-03134928v1>

Submitted on 8 Feb 2021

HAL is a multi-disciplinary open access archive for the deposit and dissemination of scientific research documents, whether they are published or not. The documents may come from teaching and research institutions in France or abroad, or from public or private research centers.

L'archive ouverte pluridisciplinaire **HAL**, est destinée au dépôt et à la diffusion de documents scientifiques de niveau recherche, publiés ou non, émanant des établissements d'enseignement et de recherche français ou étrangers, des laboratoires publics ou privés.



HAL Authorization

- * Martin Thebault
- ** Vincent Clivillé
- ** Lamia-Amel Berrah
 - * Leon Gaillard
- *** Gilles Desthieux
- * Christophe Ménézo

Multi-criteria decision aiding for the integration of photovoltaic systems in the urban environment: the case of the Greater Geneva agglomeration

Territorio Italia 2020,1,1 doi: 10.14609/Ti_1_20_1e

Keywords: Building Integrated Photovoltaic, ELECTRE, Greater Geneva agglomeration, multi-criteria decision aiding.

Abstract The current climate and energy context is triggering the massive deployment of solar energy technologies in the short term. As a consequence, the number of Photovoltaic (PV) systems that will be set up in urban areas will drastically increase. Such large-scale integration must be guided by careful consideration of a diverse set of criteria, including energy resources and demand, as well as socio-economic and environmental factors. In this paper, a decision aiding approach is introduced to rank a set of buildings based on their suitability to host photovoltaic systems in the particular case of urban environments. The study takes place in the context of a Franco-Swiss project covering the Grand Genève (Greater Geneva) agglomeration. A list of decision criteria is defined and the ELECTRE III outranking method is used to solve the problem and provide efficient ranking of the different solutions.

* University Savoie Mont Blanc, LOCIE/FRESBE, F- 74944 Annecy-le-Vieux, France

** University Savoie Mont Blanc, LISTIC/FRESBE, F- 74944 Annecy-le-Vieux, France

*** Haute école du paysage d'ingénierie et d'architecture de Genève (hepia), Institute for Landscaping Architecture Construction and Territory (inPACT), University of Applied Sciences Western Switzerland, Geneva, Switzerland

1 | INTRODUCTION

Since the beginning of the 21st century, increasing concerns regarding the consequences of emerging climate change have led to a rethinking of the generation and consumption of energy as well as the management of local resources. During the COP 21 held in Paris in 2015, the nations of the world made commitments to reduce their Green-House Gas (GHG) emissions. These goals would for the most part be achieved through a decrease in overall energy consumption and the replacement of carbon-emitting fossil energy resources with renewable energy generation capacity (IPCC, 2019), such as solar, wind, hydro and geothermal energy. Among the numerous sources of renewable energy to have been exploited, solar energy is particularly interesting thanks to its abundance and relatively easy deployment, and for this reason the sector is expected to enjoy a tremendous acceleration in implementation (International Energy Agency, 2017).

The potential of solar energy is not exclusively related to the collection and use of solar radiation. Indeed, the energy produced by the sun is responsible for a great amount of the other energy resources available on earth. For example, the use of plant biomass and fossil fuels is an indirect use of solar energy after their being transformed through physical and biological processes, the latter requiring over millions of years. The sun also heats the earth's surface, generating natural convection currents that lead to the largescale atmospheric motions that cause winds to appear and thus, wind power (Garg, 2000). However, when considering solar energy as a resource, the reflection is generally limited to the direct collection and conversion of solar radiation. From now on, this renewable harnessing of solar radiation will be referred to more succinctly as solar energy.

Solar energy has the great advantage of being a widely distributed energy source, available throughout most of the world, with a variability depending first and foremost on latitude. Whereas at the equator variability is dominated by the daily cycle, the closer one gets to the North and South poles, the more seasonal variation becomes important. Nevertheless, most inhabited regions receive solar energy on a daily basis, which is modulated depending on the season. Two main strategies have been adopted to harness solar energy: solar energy is either collected to produce heat through solar thermal solar systems or through PhotoVoltaic (PV) systems (also called PV panels) to generate electric power (Garg, 2000). Concentrated Solar Power (CSP) also generates electricity through steam turbines. In this paper, the focus will be on PV electricity production.

Energy generation by means of PV technologies has undergone a sustained and accelerated expansion since its commercial development a few decades ago. In 2019, it has been estimated that it represented 2.6% of the worldwide production of electricity (PVPS, 2019). In 2018, for Switzerland and France, PV power generation (PVPS, 2019) respectively amounted to 3.6% and 2.2% of the share of the total electricity consumption of the country.

Different PV technologies exist (NREL, 2019), but the more common and mature technologies (crystalline silicon) have an energy conversion efficiency ranging from 15 to 22%. There are many characteristics inherent to PV systems, from the manufacturing of PV cells to the management of the electricity that is generated. The focus of the present work is the problem of the integration and deployment of the PV system.

There are two main ways to increase the PV inventory of a given region: either power capacity can be concentrated into utility scale solar farms installed in rural areas, or PV systems can be integrated into the built environment. Solar farm deployment requires considerable land utilization and can be in conflict with agriculture or efforts to preserve the biodiversity (Palmas *et al.*, 2015). In contrast,

urban PV systems are implemented onto building surfaces and offer the further advantage of providing energy in close proximity to where it is needed. In the context of the deployment of PV systems, both these strategies are adopted in parallel, but in the present work, the focus will be on the implementation of PV in urban environment.

An urban landscape is a complex environment for PV deployment. This is due to several factors:

- Cities are by definition densely populated areas in which the human factor is crucial. This implies that different layers of complexity relative to the social, the environmental or the well-being aspects of the population need to be considered.
- In cities, building ownership is relatively complex. Implementation of PV systems in the urban environment relies on the availability of building surfaces, and therefore their implementation is directly impacted by local ownership.
- Integration and installation of PV systems cannot be achieved without considering other buildings and their inhabitants (shadowing, aesthetics, right to natural light), energy grid managers, local policy frameworks, etc.
- PV systems have a certain cost, and this can be a limiting factor, so the choice of their location must be handled carefully.

Consequently, it appears that the Implementation of PV systems in an urban environment is a problem to be treated on a case-by-case basis, wherein a wide range of factors must be evaluated in order to select the most suitable roofs to be equipped with PV panels. In this paper, it will be shown how a Multi-Criteria Decision Aiding (MCDA) analysis can be used to address this problem, and in particular the ELECTRE III method (Roy, 1990, 1968).

The case of the Grand Genève agglomeration is considered. Indeed, the agglomeration is undergoing a large-scale deployment of PV in its urban areas and thus represents an opportunity to illustrate the developed methodology.

In this paper, an original decision aiding approach is introduced for the deployment of a PV system. The MCDA methodology is first described in a general context. Then, the case study of the Greater Geneva agglomeration is presented and the problem is exposed with particular attention paid to the decision criteria as well as the different actors involved in the decision process. The decision problem is then solved and the results of the multi-criteria problem is presented and discussed. Finally, the perspectives of the current work are illustrated.

2 | MCDA FOR URBAN PV DEPLOYMENT

2.1 The relevance of MCDA

As mentioned previously, the determination of solar energy potential at an urban territory scale is a complex problem. First of all, a precise geometric description of the city must be provided in order to calculate local solar resource distribution. In practice, the methods that are used in order to select the most adequate roofs to host PV systems are mainly governed by naive individual approaches, the goal being to minimize the environmental footprint for a limited financial cost.

Early uptake of urban PV was restrained to a narrow range of actors, who may be considered experienced early-adopters. However, given the massive deployment of solar energy in urban areas, motivated by the perceived environmental emergency and its inherent social and political pressures, the paradigm has changed to one entailing a vastly more widespread implementation. These actors can be for example start-ups, established businesses, civilians, civil associations, architects or cities themselves. Considering the complexity of the urban environment, the need for a massive deployment of PV systems and the multiplication of the different actors interested in this deployment, it would appear that the empirical approaches typically used at present will become insufficient at a larger scale of deployment.

In this new context, it becomes necessary to develop a new approach to help the decision process to solve this type of problem. A new methodology should address the following considerations:

- Accessibility of the tool to different levels of expertise, as well as to the different stakeholders,
- Transparency and traceability of the decisional process,
- Reproducibility of the approach for different inputs of the problems and later on, an opportunity to systematize the approach in order to implement it at large scale.

These points can be dealt with by considering the use of Multi-Criteria Decision Aiding (MCDA) methods.

In a MCDA context, the problem of the implementation of PV systems in the urban environment can be seen as a ranking problem which can be dealt with tools such as outranking methods (Bouyssou, 2009). These methods help decision-makers to rank the potential solutions.

There are many different methods which have been developed to assist with MCDA in urban energy related decision problem (Cajot *et al.*, 2017). Among them, the ELECTRE III outranking method was considered as adequate for the present study, as it is a robust and mature method which is commonly used for territory related MCDA problems (Govindan and Jepsen, 2016).

2.2 ELECTRE III method

The outranking methods allow the Decision Maker (DM) to rank a given set of actions (in our case the roofs of a given part of the Geneva agglomeration) by making pair-wise comparisons between the considered action. The ELECTRE family methods (Roy, 1990) are the most used in the MCDA application areas (big projects, human resources, industries and services...).

The ELECTRE methods are close to human reasoning. For a pair of actions a and b , the used comparison relations are:

- the outranking one noted aSb that means action a is at least as good as action b ,
- the strict preference one noted aPb *i.e.* aSb and not bSa ,
- the indifference one noted aIb that means, aSb and bSa ,
- the incomparability one noted aRb that means not aSb and not bSa .

The ELECTRE III method supplies a partial pre-order of all the potential actions where the pairs of actions can be indifferent or incomparable. Deducing the preference relation on every action pair knowing their description by numerical values facilitates the comparisons. In this sense, mathematical rules (Figueira *et al.*, 2012) allow the DM to establish a preference model on the set of actions. The mathematical rules involved in ELECTRE III concern:

- the definition of the thresholds for each criterion c_j ; the indifference threshold q_j , the strict preference threshold p_j and the veto threshold v_j ,
- the weights w_j representing the criterion's relative importance in the decision-aiding process,
- the definition of the preference relation by the computation of the concordance index noted $c(a,b)$ ranging from 0 to 1, which reflects the arguments to favor a instead of b and the discordance index noted $d(a,b)$ ranging from 0 to 1 which reflects the argument strongly against a instead of b ; moreover a credibility index, ranging from 0 to 1, informs on the confidence of the pair-wise comparison (a,b) . It is expressed by the reduction of the previous indexes and reinforces the outranking relation knowing a predetermined threshold (of credibility) noted λ ,
- a mechanism of distillation using these indexes to identify the correct preference relation for a given pair-wise of actions and consecutively the partial pre-order of the potential actions.

The outranking fuzzy relation is based on the previous indexes (Figueira *et al.*, 2013). So, the outranking can be considered with a degree of certainty, expressed by the index of credibility which reinforces the piece of information about the rank. The method requires DM's knowledge for both the model parameters identification (thresholds, weights) and the aggregation mechanism understanding. Finally, the results can be given thanks to the Hasse diagram graph (Skiena, 1991). Complementary analyses such as the weights, thresholds or descriptive vectors sensitivity can be made. Interested readers can find more information about the indexes computation in (Figueira *et al.*, 2005; Roy, 1990).

A recent open-source webservice, *diviz*, developed by the Decision Deck Consortium, allows users to implement the ELECTRE III methods under the form of a workflow. In Figure 1, the main steps of the process are presented (data recording, data conversion, concordance, discordance and credibility processing, order relation displaying). Finally, it provides the partial pre-order results.

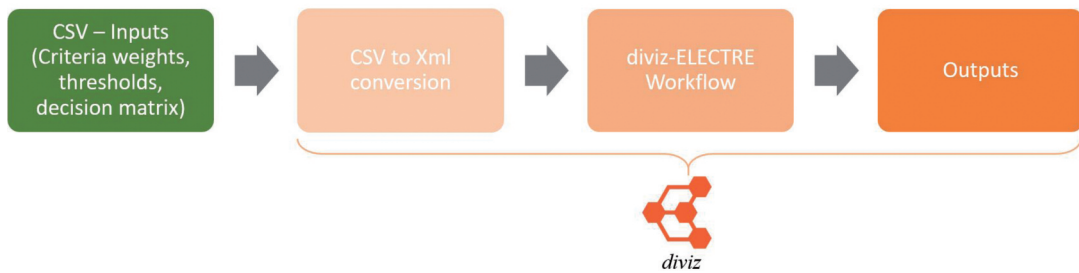

Figure 1 diviz implementation

Subsequently, the different steps of the ELECTRE III methodology are:

- To describe the decision problem
- To identify the decision maker(s)
- To define the set of considered alternatives
- To define the set of criteria
- To define the ELECTRE III preference model
- To rank the alternatives

These steps are addressed for the case of the Greater Geneva in the following section.

3 | CASE STUDY

3.1. Context of the study

Greater Geneva is a French-Switzerland cross-border region that has implemented a transition policy aimed at drastically increasing their share of PV energy production in their energy mix (Département fédéral de l'environnement, des transports, de l'énergie et de la communication, 2018; Ministère de la transition écologique et solidaire, 2018). This agglomeration includes two Swiss Cantons (the whole Canton of Geneva, and a part of the Canton of Vaud) and two French Departments (parts of Haute Savoie and Ain). Its main characteristics are the fact that it is comprised of an area of 2000 km² and it is home to 1 million inhabitants and 209 municipalities, the City of Geneva being its main urban center.

Greater Geneva plans to drastically increase its production of electricity through PV. To do so, the agglomeration both seeks to expand the capacity of installed PV and encourages the deployment of PV systems on their territory. It is in that context that the project G2Solaire “Grand Genève Solaire” (Greater Geneva Solar) was launched in 2019.

This project is supported by the Swiss-French INTERREG V program as well as the local French authorities and Swiss governments. It includes numerous partners such as the national/local electric power distributors, local collectivities, actors of PV deployment, academics and universities. The aim of this project is to increase the installation of solar energy in Greater Geneva through the development of an advanced solar cadastre of the agglomeration and the mobilization of actors in pilot areas.

The solar cadastre of a city is a geographical interface that provides crucial information as to how much solar energy is received by a roof, building, or home. It is often coupled with the local land register, which provides a segmentation according to the ownership of the house/building part. Such cadastre takes the form of a Geographic Information System (GIS) tool often managed by local collectivities.

Since 2011, the Canton of Geneva has developed its own solar cadastre as illustrated in Figure 2, which is being extended to the whole agglomeration through the project G2Solaire. The left picture represents an aerial view of a group of buildings. The picture, displayed on the Geneva Territory Information System (the acronym being SITG in French, <https://ge.ch/sitg/>) in the middle represents the raw irradiation calculated on the surfaces (taking into account the slope and aspect of the surfaces and the mutual shadowing effects). Finally, the figure on the right-hand side corresponds to a post-processed view of the middle picture in which the buildings and roofs are identified and the PV production potential per roof is displayed. Detailed methodological information about the production of the Geneva solar cadastre is given in Desthieux *et al.*, 2018.

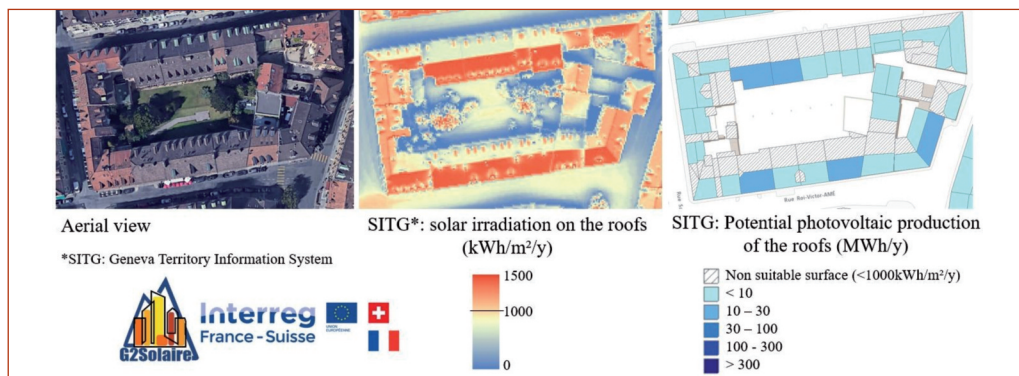

Figure 2 Illustration of the solar cadastre of the Geneva Agglomeration SITG

The current cadastre provides some energy and economic information that is crucial to decide where to implement PV systems. However, as was mentioned in the introduction, cities are complex environments in which more criteria must be considered to better help decision makers know how to deploy PV systems in an urban area.

3.2 Decision problem description

In the context of this work, field surveys and interviews were conducted with some of the project partners as well as experts from the private sector, civil society and academic institutions. All these actors had complementary expertise in the field of the urban implementation of PV systems.

Although the consultations revealed diverging motivations between some actors regarding the implementation of PV systems, most actors were confronted with the following problem: considering a set of buildings, which are the best suited to host PV systems? Such a problem is encountered for example when a municipality that owns several buildings is looking for the most interesting rooftops to deploy PV installations. A similar problem is encountered when a company or an investor considers several building roofs that they own or that they could rent for PV systems.

Instead of considering emerging technologies for the present case, only polycrystalline PV is considered, as it is amongst the most widely used technology, is essentially mature and has a conversion efficiency of around 17%. Therefore, the problem considered here is not about the technology of the PV system.

The final decision problem consists of ranking building roofs, which belong to a predefined set of buildings, for the installation of a solar PV systems considering a range of technical, economic, societal and environmental criteria.

Knowing that the number of buildings in the Greater Geneva is high (several tens of thousand) it has been decided to restrict the study to a set of buildings that were selected in the Carouge district, which is one of the better documented areas of the Greater Geneva.

The panels of experts that were consulted for the present work have revealed that different actors can be implied in decision making processes involving the deployment of PV systems, namely, the city council, architects, urban planners, private companies or/and environmentally aware citizens/groups of citizens. These various actors have different points of view and interests. As a consequence, the consideration of the criteria and their associated relative weights will be different. To that aim, in the present work, four different Decision Groups (DG) were defined, that is:

- DG-1 Economically-driven group; this group is mainly composed of businesses or citizens whose actions are centered around economic benefits.
- DG-2 Public/association/citizens; in this group the use of solar energy is more related to ideology, environmental and societal concern. However, they often cannot afford to lose money, therefore they aim at reaching small benefits or at least economic neutrality.
- DG-3 Early-adopters, ecologists or philanthropist, experimentalist; this group is composed of actors that are less concerned about economic viability than they are about environmental, social or society concerns.
- DG-4 Whereas all previous actors are rather centered on small scale investments, large scale deployments such as those at city or regional scale require other expectations to be matched especially regarding the electric stability grid issues. This group is therefore composed of actors such as the local grid manager, electricity providers or the city itself.

These different DGs may be considered as an oversimplification of the inherent complexity of the concerned actors. However, they were considered by the different consulted experts as a reasonably representative description of the Greater Geneva agglomeration stakeholders. For all DGs, it is supposed that the criteria and the alternatives remain the same; however, the preference model could change, especially the weights.

3.3 Considered alternatives

PV systems can be integrated on all types of building façades, including vertical façades. However, the integration of PV systems on the roofs of building remains the most current practice because of the lack of reliable energy and economic data regarding vertical facades. For that reason, only roof integration will be considered here.

In an urban environment, the concept of “roof” must be clarified. Indeed, a large building can be divided into different ownerships or co-ownerships, and therefore what would appear as an entire roof can be split into different parts, belonging to different owners or group of co-owners. In the present paper, a roof will be considered as the part of the entire building roof owned by a single owner or group of co-owners according to the land-register (also called cadastre) of the city. This is illustrated in Figure 3, in which a large building is divided into two “roofs”. It is not possible to obtain the details as to the ownership of each building, which is why the official segmentation proposed by the government is used here.

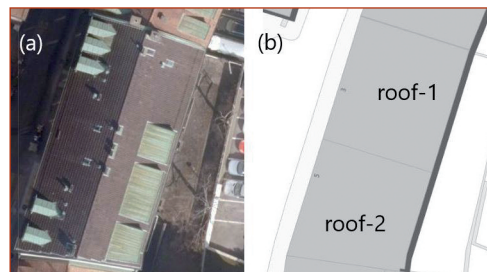

Figure 3 Illustration of the roof definition (a) aerial view of a roof of an entire building (b) division of this roof into two sub-roofs (roof-1 and roof-2) according to the ownership

In order to be as thorough as possible, a wide range of roofs in the Carouge district is considered, with heterogeneous physical characteristics including size, elevation, orientation, energy production, uses and different areas. From this first set of roofs, a pre-selection is then carried out. Indeed, not all the roofs are considered, and exclusion parameters are defined. Among them, the first one is the energy productivity of the roof. Indeed, totally or partially shaded roofs are not interesting for the installation of PV panels, as they would produce a low amount of energy, and would therefore be economically and energetically not viable. The minimum amount of solar radiation threshold considered here is 1000 kWh/year/m². It corresponds to a common value used in numerous solar cadastres, including the one referred to here, which makes the selection of the best oriented and irradiated roofs possible. Note that with the current decrease in the price of photovoltaic energy concomitant with the global increase in the price of energy (International Energy Agency, 2017), this threshold will probably be revised downward in the coming years. The second exclusion criteria considered is the case of heritage buildings. Indeed, this case is very often a source of conflict and highly depends on the local policy. Even if installing PV systems on heritage buildings is sometimes

authorized, it implies great efforts of aesthetic integration and discussion with the local authorities. Therefore, heritage buildings will not be taken into account in this study. The roofs selected for the present study as well as their characteristics are presented in Table 1.











Name	Illustration	Area (m ²)	Roof inclination (°) (0°=horizontal)	Orientation (0°=North, 180°=South)
B1		2500	0	170
B2		840	0	176
B3		134	23	198
B4		97	22	173
B5		160	30	172
B6		170	24	177
B7		380	27	90
B8		70	23	210
B9		27	25	120
B10		194	0	193

Table 1 Physical characteristics of the pre-selected roof

3.4 Set of criteria definition

The determination of the relevant criteria is a key aspect in MCDA. As far as we know, the consideration of the implementation of PV systems in urban environment through the use of MCDA method is new. Therefore, no generic methodology has been proposed in the literature. For that reason, the choice of the influential criteria will be determined on the basis of previous studies on decision making:

- the previously established criteria regarding the implementation of PV solar farms in rural areas (Charabi and Gastli, 2011), the consideration of different PV technologies for residential applications (Huaylla *et al.*, 2013);
- the environmental and societal impact of the integration of renewable energies in urban areas (Neves *et al.*, 2018; Pohekar and Ramachandran, 2004; Wu *et al.*, 2018);
- renewable energies for electricity generation implemented in a urban environment (Seddiki and Bennadji, 2019).

Because the present work involves a case study in Greater Geneva, the list of criteria was progressively refined thanks to discussions and workshops with the experts mentioned at the beginning of section 3.2.

Finally, nine criteria have been identified, organized in three categories: the Financial, the Technical-Energetic-Environmental and the Social. These criteria are detailed below.

3.4.1 c1 - PP

The Payback Period (PP) indicates the time, in years, necessary to amortize the initial investments and therefore start making benefits. It depends on the investment as well as on the PV production and the electricity buy-back proposed by the local energy retailer.

There are many factors that can affect the investment price. It depends on the technology of the PV system, the electrical equipment required (inverter, electric meter, etc.), the size of the installed surface, the mode of integration (integrated in the roof or superimposed on the roof), the robustness of roof structures (*i.e.* is reinforcement needed in order to host PV panels?) or the local electrical grid situation (modification or reinforcement of the local electrical grid capacity). Ideally, all these factors are needed in order to estimate the investment.

Whereas the prices of PV systems and electrical equipment as well as that of the installation are relatively standard and predictable, it is not the case of the price associated with the modification of the electrical grid since it can vary because of, for instance, the deployment of long cables from the network to the installation, the modification/reinforcement of the electrical facilities (size of the cables, maximum power of the converter etc.). Thus, for these parameters, on-site study remains the most reliable approach. However, in the present case, given the large amount of buildings that are taken into consideration, on-site studies cannot be done for each building. As a consequence, alternative approaches will be followed to evaluate the impact of these two factors on the MCDA (sections 3.4.4 and 3.4.5).

In order to evaluate the investment price, a market study was carried out and the average prices obtained for a French PV system in 2019 were plotted in a semi-log plot in Figure 4. Switzerland's prices are very similar. The red bars representing minimum and maximum values correspond to the minimum and maximum values reported in the market study. This price distribution almost follows a power law, plotted here by a dashed line, but for the rest of the study, piecewise-linear interpolation was preferred to evaluate the prices of an installation. These prices correspond to all-inclusive prices for an integrated PV system, for which only minor necessary electrical modifications of the grid were done and for which no reinforcement of the roof structure is required.

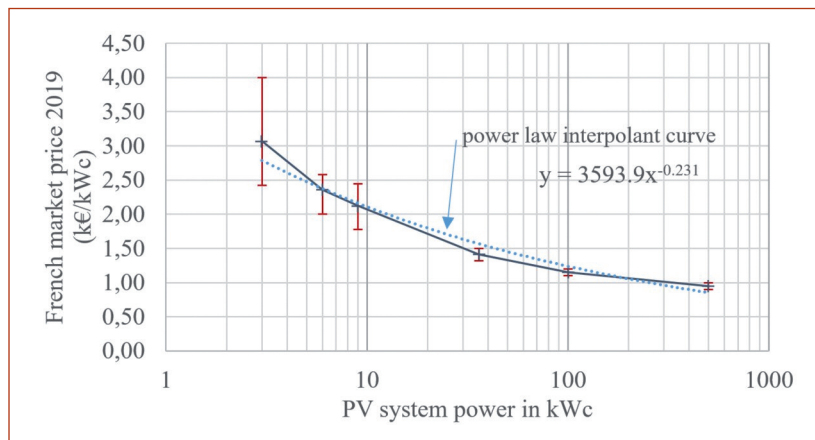

Figure 4 Estimated PV system price

Once the investment price is known, the PP can be calculated by use of a relatively advanced model based on the TEC methodology of (Chabot, 1998) implemented in the CALSOL+ tool developed at the Institute of Solar Energy (INES).

3.4.2 c2 - PV production rate

It corresponds to the amount of energy produced every year per square meter installed. The evaluation of the solar potential relies on the 3D-Geographical Information System (GIS) models developed at HEPIA Geneva and based on three-dimensional urban geometry data and solar radiation models (Desthieux *et al.*, 2018).

Note that, in this case, this criterion also quantifies the environmental benefits expected from PV system integration. Indeed, given that the rate of PV production is expressed per square meter, it is directly proportional to the energy efficiency of the system *i.e.* how much energy this system produces per square meter. Given that a unitary square meter of PV system has a fixed environmental cost that depends on the resources that are required for its manufacturing, transport, usage and recycling, a certain area of PV systems with a high rate of PV production will have a better environmental impact than the same area of PV systems with a lower PV production rate. As a matter of fact, environmental indicators such as CO₂ savings or the energetic return on investment are almost directly proportional with the PV production rate.

3.4.3 c3 - Accessibility

This criterion assesses the accessibility of PV systems, either for the installation or for the maintenance and cleaning that may be needed in some cases. This point was evaluated thanks to the information available in the actual SITG database on the elevation and tilt of roofs.

3.4.4 c4 - Local electrical grid modification

Regarding the local electrical network, energy distributors such as ENEDIS in France offer a tool that allows one to estimate the electrical connection cost. It appears that in dense areas such as Genève and its direct urban neighborhoods, the local electrical network is very well developed. Therefore, electrical connection costs are relatively low and almost the same for each building as long as the power installed behind the local power transformer does not exceed a certain limit. As mentioned in subsection 3.4.1, this cost is already included in the investment estimated in Figure 4.

However, when large installations are deployed, the local electrical network must be considered. Indeed, PV systems are connected to the local power transformer, the power of which can range between 100 and 1000kVA in urban areas. In the present study, mostly small or medium size installations for which no modification of the local grid is expected are considered. However, some bigger installations for which extra work and therefore extra costs are needed will also be considered.

3.4.5 c5 – Robustness of structures

The robustness of structures can be estimated by analyzing the actual roof and the building function. For example, for a building with a heavy roof covered with tiles, the PV system can be designed with integrated PV panels replacing the roof tiles rather than superimposing PV panels on the existing roof. The first solution is almost three times lighter than the second. The weight of PV systems can also be compensated in the case of flat roofs with gravels by simply removing the equivalent gravel weight. However, the problem of robustness may arise for large roofs that were not designed to support weight. This is the case of covered swimming pools, gymnasiums or large warehouses, for example. In this case, an additional study must be carried out to verify robustness, and sometimes the reinforcement of the structure is needed, which necessarily increases the overall cost. That criteria will therefore be evaluated based on the characteristics of the roof, which are observable from the aerial view of the SITG.

3.4.6 c6 - Potential of local consumption

There is a large trend in developing local consumption (self-consumption) of energy, both for the citizens as well as local and national authorities (Département fédéral de l'environnement, des transports, de l'énergie et de la communication, 2018). To assess the potential of local consumption, the electricity needs of the buildings as well as their production of electricity at a small time-step are required (Luthander *et al.*, 2015). In the present case, such temporally precise information cannot be obtained on a large scale yet. Indeed, it is not always recorded, and when it is, laws on the privacy of data make it very difficult to access. As a consequence, the potential of local consumption is evaluated thanks to the activity of the building. The building hosting tertiary activities and businesses are more likely to consume more electricity during working hours, and therefore sunny hours, than residential buildings for which the consumption is higher at the beginning of the morning, the late afternoon and evening.

3.4.7 c7 - Visual impact on the environment

The visibility of the solar systems is often mentioned as a potential obstacle to their installation. This aspect is also very political in nature and depends on national legislations as well as on the local urban context. Very often two main criteria are considered: the visibility of the PV system and the sensitivity of the area. In France, PV system installation on heritage buildings and within a certain radius from these buildings is subject to constraints and validation from national architects. These constraints are however less strict if the system is installed in less visible areas. However, the visual impact of a solar system remains subjective. Indeed, whereas some people find them disgraceful, others associate them to greener cities and may also find them quite pleasant to look at.

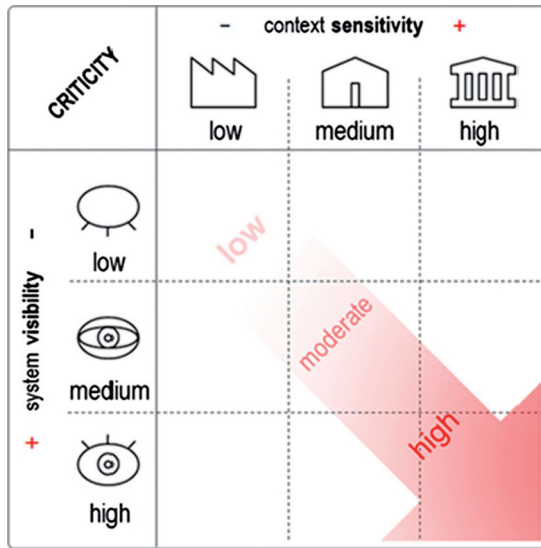

Figure 5 Visual impact in its environment “criticality” matrix as a function of visibility and sensitivity. Credit (Probst and Roecker, 2015)

A similar classification as the one proposed by (Florio *et al.*, 2018; Probst and Roecker, 2015) and illustrated in Figure 5 is used. Moreover, Florio *et al.* (2018) proposed a map of a district of Greater Geneva, the Carouge district, for which the sensitivity of the areas as well as the visibility of the PV system are described. These results are therefore used in the present study.

3.4.8 c8 - The positive impact of social acceptance

In a context of a rapid deployment of PV systems, social awareness, acceptance and adoption need to be considered. Indeed, different studies have shown that neighbor and peer effects improved PV deployment (Graziano and Gillingham, 2014; Kausika *et al.*, 2017; Noll *et al.*, 2014). Moreover, some of the consulted experts mentioned this criterion as a possibly influential one when deciding on the location of a PV new site.

Note that this criterion has mainly been used in low-density areas such as rural or semi-rural areas in which it is possible to find large areas in which no PV systems are installed. However, in an urban area such as Geneva, the density of PV systems is significantly higher. Therefore, instead of considering the presence or not of a PV system in a specific region, the density of PV systems relatively to the density of the population seems to be a more relevant indicator. Rated from ‘Low’ to ‘High’, ‘Low’ means that the implementation may not have a social impact, often because of a high density of PV panels in the area. On the contrary, ‘High’ means that the density of PV in an area is low and the implementation of a PV would be more likely subject to local approval. In the present study, the aerial images of the municipalities are inspected to determine the density of PV systems in the neighborhood of the considered building.

3.4.9 c9 - Competition/Interaction with other uses

This criterion evaluates the competition that may exist between the installation of a PV system and other actions that could be implemented instead of or in parallel to a PV system. For example, a flat roof with easy access could be used for urban gardens or roof-top restaurants and, consequently, the competition on these specific spaces is high.

A tilted roof is more likely to be used for PV or thermal solar production and, consequently, the competition is low. It is also possible for PV systems installed on low buildings to clash with the surrounding vegetation, which contributes to the mitigation of urban climate (limitation of heat island effects) but could impact PV systems power generation through shadow casting. This criterion is evaluated thanks to the height of a building and roof inclination.

3.4.10 Summary of the criteria and decision matrix

All the adopted criteria are summarized in Table 2. The sources from which the information is collected are also indicated. Particular attention was devoted to having an exhaustive list of criteria and avoid repetition.

Criterion		Source
Financial	c1 – PP (year)	Figure 4 / CALSOL+ /AUTOCALSOL (INES)
Technical Energetic Environmental	c2 - PV production (MWh/an/m ²)	SITG. (Desthieux <i>et al.</i> , 2018)
	c3 – Accessibility	Roof characteristics (SITG)
	c4 – Local electrical grid modification	ENEDIS/SIG
	c5 – Structure robustness	Building/Roof characteristic (SITG)
Social	c6 - Local consumption potential	Building activity (SITG)
	c7 - Visual impact in its environment	<i>Pietro et al.</i> (Florio <i>et al.</i> , 2018)
	c8 - Social Positive Impact	District characteristic (SITG)
	c9 - Competition with other usage	Roof characteristic (SITG)

Table 2 Adopted criteria

By knowing the different criteria and set of alternatives, it is possible to provide the decision matrix presented in Table 3. For instance, the cell B2, c1 corresponds to the evaluation of the second criteria, PP being expressed in years, for the alternative B2.

The ‘L’ in cell B8, c5 means that Low modifications of the local electrical grid are expected for the alternative B8. The colors from the lightest to the darkest are indexed with the value of the criteria in order to allow for better readability. Many criteria can only be evaluated qualitatively on a scale ranging from “Low” to “Very High”. ELECTRE III uses only numerical values, so these linguistic terms must be converted into numerical values. In this work, these values range from 2 to 8, as showed in Table 3 assuming that there is a meaningful difference between two consecutive levels for the DMs.

	c1	c2	c3	c4	c5	c6	c7	c8	c9
B1	10	0.12	H	VH	H	H	L	H	H
B2	13	0.1	VH	H	M	H	L	H	H
B3	16	0.15	M	M	H	H	H	H	M
B4	21	0.13	L	L	H	L	H	H	L
B5	14	0.18	M	M	H	M	L	H	L
B6	14	0.16	L	M	H	M	L	M	L
B7	15	0.13	M	M	M	M	L	M	M
B8	17	0.17	H	L	H	L	M	M	L
B9	18	0.15	M	L	L	M	L	M	M
B10	17	0.11	VH	M	M	L	L	L	L
VH: Very High - 8			VH: Very High - 6			M: Medium - 4		L: Low - 2	

Table 3 Decision Matrix

3.5 ELECTRE III preference model definition

As mentioned in section 2.2, the preference model definition consists in defining the weight, the thresholds for each of the considered criteria.

The weight of the different criteria has been evaluated for each of the DG (see section 3.2) based on the authors and the consulted actors' expertise and following a procedure inspired from the Simos methodology (Simos, 1990). The obtained values were then discussed with the stakeholders and adapted according to their comments, one set of weight corresponds to one DG. These values are reported in the first four lines of Table 4). A similar approach was followed to define the thresholds of indifference, preference and veto. In this case study, no veto threshold appeared to be relevant to any of the stakeholders, which is in great part due to the fact that the pre-selection of roofs already includes a sort of veto by disregarding the least energetically viable roofs as well as the heritage buildings. It was also considered that all the DGs agreed on the same values of thresholds which are presented in the three last lines of Table 4.

In Table 4, the term 'ind' refers to the indifference threshold below which two solutions are considered as similar according to the evaluated criteria, 'pref' refers to the preference threshold above which the difference allow to rank two alternative according to a criterion, and 'dir' indicates the ranking direction. The colors from the lightest to the darkest are indexed with the value of the criteria in order to allow a better readability.

	c1	c2	c3	c4	c5	c6	c7	c8	c9
DG-1	8	2	1	4	4	2	2	1	2
DG-2	4	4	2	3	4	4	3	3	3
DG-3	2	4	2	2	2	4	3	5	3
DG-4	3	4	2	5	2	4	4	4	3
ind	1	0.01	1	1	1	1	1	1	1
pref	2	0.02	2	2	2	2	2	2	2
dir	min	max	max	min	max	max	min	max	min

Table 4 Weights and thresholds for the different Group Decision

The cell DG-2, c9 corresponds to the weights that the group decision 2 gives to the criteria c9 *i.e.* the social impact.

4 | RESULTS AND DISCUSSIONS

4.1 Results of the ranking

The previous data (decision matrix and preference model) are processed by using the webservice called 'diviz' thanks to an adapted workflow.

The ranking of the alternatives for the different DGs are presented in Figure 6 by means of Hasse diagrams, which allow the decision maker to represent a partial pre-order from a set of alternatives. An arrow implies that an alternative is better than another one. Two alternatives at the same level but separated (ex: B2 and B6 in DG-1) could be considered neither as indifferent nor better. Finally, two alternatives in a same box such as B1 and B2 in DG-2 are considered as indifferent solutions. It appears here that the different DGs yield different rankings. However, the B1, B5 and B6 alternatives remain among the best alternatives in all cases, whereas B10 is considered as the worst alternative for all DGs.

One can note that the alternative with the best PP, B1, is ranked first only for DG-1, just like B5. This shows that the alternative that seems the most economically profitable may not be the best solution when considering the complexity introduced by an urban environment

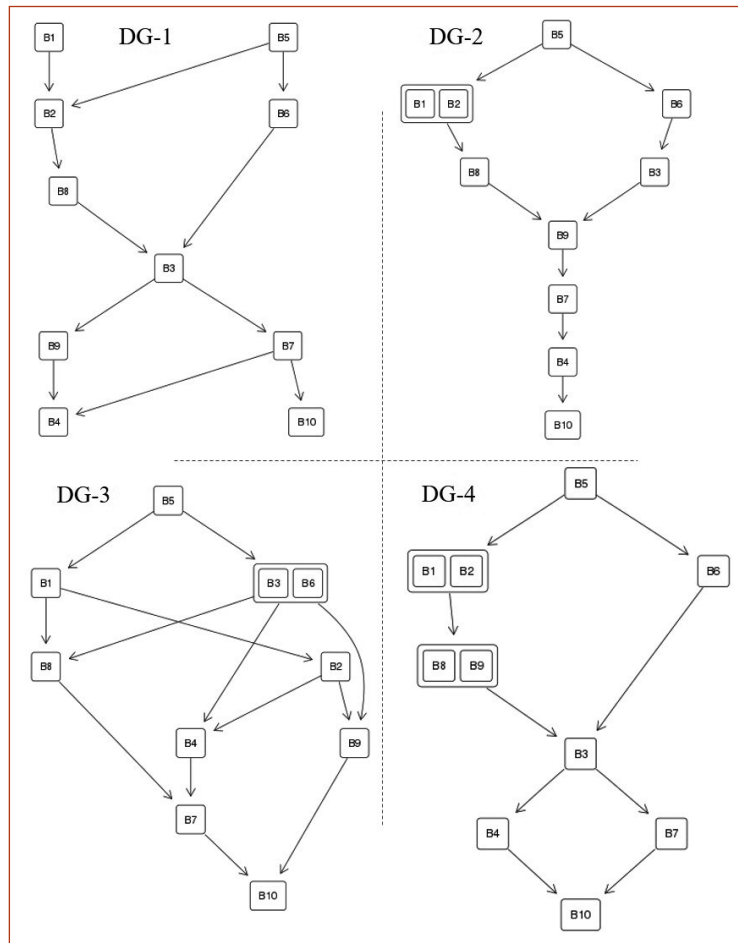

Figure 6 Hass diagram results according to the different DG

4.2 Decision aiding under investment constraint

It is possible to go further in the process of decision making aiding, particularly when the deployment of PV systems is limited by a frame which often corresponds to a given amount of money to invest in PV systems. The case of the DG-1, which corresponds to a mainly economically driven decision, is considered. The evaluation of the investment for the considered alternatives is obtained by using Figure 4 and is presented in Table 5. Moreover, in Table 5, the ranking of the alternatives is also reported.

Alternatives	B1	B2	B3	B4	B5	B6	B7	B8	B9	B10
Ranking for DG-1	1	3	6	9	1	3	7	5	7	9
Investment (k€)	350	140	35	30	45	45	80	20	10	20

Table 5 Investment price of the alternatives

Considering an investment of 100 k€ ±10% the B5+B6 (90 k€) or B5+B6+B8 (110 k€) alternatives are the best alternatives. For an investment of 150 k€, the B2 (140 k€) alternatives may be preferred to the combination of B5+B6+B8+B3 (145 k€). For a greater investment of 400 k€, the two better ranked alternatives B1 and B5 would be better. It is interesting to note that, with this type of constraint, the best alternatives (here B1) would not be selected, as they are too big an investment compared to smaller, less expensive and lesser ranked alternatives.

It can also be noted that, for similar financial constraints, different alternatives would be chosen because of the difference in ranking generated by the differences between the DGs. It appears that, for an investment around 140k€ (±5K€), the MCDA approach considers B2 as the best alternative for DG-1 2 and 4, whereas it would rather suggest DG-3 to choose the combination of the B5, B6, B3 and B8 alternatives.

4.3 Discussion about GIS implementation of the model

As was shown in this work, by including different relevant criteria and considering different categories of DMs, the ranking of the alternatives differs. However, in order for the present multi-criteria analysis to be used on larger scale projects, it is necessary to make it more systematic.

This could be achieved by using a Geographical Information System (GIS) implementation of the present model. A GIS model enables both the displaying of different layers of information based on a geographical representation and interacting with this information. As a consequence, each criterion mentioned in section 3.4 could be integrated as a layer of information.

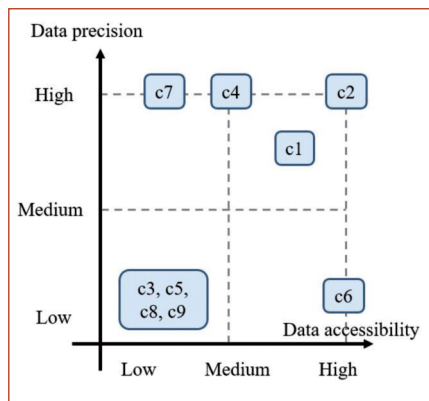

Figure 7 Layer of data accessibility and precision

The users would then select the buildings of interests through the GIS interface. Then, the MCDA model, such as ELECTRE III, needs to be implemented and finally a user-friendly interface would provide the results. As part of the project from which this work is issued, it is the perspective of the present MCDA model to be implemented in the GIS interface of the Greater Geneva solar cadastre.

However, the main problem to be addressed is related to the availability of data. Indeed, whereas some data is easily accessible, such as the PV production rate, other is more difficult to assess systematically (ex: structure robustness, local electricity grid).

An indicative representation of the quality and accessibility of data is presented in Figure 7. High data accessibility means that the information is already provided in the current cadastre with a high level of spatial resolution *i.e.* for each roof in the present case. It is the case of the PV production (c2), which is the core output of the current cadastre, as well as the local-consumption potential (c6),

which is evaluated on the basis of the building activity. The PP (c1) can be very easily calculated using the available data and economic models such as the one proposed in Figure 4 and/or open access tools such as CALSOL+ or AUTOCALSOL developed at INES. As to the local electrical grid modification criteria, c4, it is possible to obtain a relatively precise estimation of the costs for each building. However, this information is not available in open access and must be requested to the local grid manager for each building. Therefore, it can't be integrated as a layer of Information in a GIS model yet. For that reason, the access to this information is low and not practical and, therefore, its use remains very limited. The visibility data used in criteria (c7) is presently not available in open access for the entire Greater Geneva.

In a further work involving a large-scale deployment of the present MCDA model, the accessibility of the different layers of information must be assessed. However, some data may not be locally accessible. In that case, the MCDA would be of lesser importance and a robustness study would need to be carried out to assess the extent to which this lack of information impacts the present MCDA model.

Regarding data precision, a "High" level means that data is precisely and quantitatively known for a given building, whereas a "Low" level means that data is qualitatively estimated using strong assumptions. In the present model, the definition of the qualitative scale with discrete levels (L, M, H, VH) ensures that an alternative (for example VH) that is better evaluated than another alternative (for example H) is undoubtedly better according to the considered criteria. This therefore contributes to increase the concordance index. The establishment of thresholds is therefore subordinate here as the ordinal scale of the levels guarantees the preference relation between the different levels.

5 | CONCLUSION

In this work, an MCDA approach has been used in order to tackle the problem of PV implementation in an urban environment. This work is a case study conducted in the context of a Franco-Swiss project in the Greater Geneva agglomeration (G2Solaire), a project that aims at intensifying the development of the solar energy through the development of an improved solar cadastre of the region.

A literature review as well as a field study were first conducted in order to identify:

- The outranking method, here ELECTRE III, which is particularly suitable for MCDA analysis relative to the territory,
- 9 decisional criteria belonging to three main categories; economic, energetic, and society,
- 4 different decision groups (DG), which represent different profiles of decision makers and for whom the decisional criteria do not have the same weight in the ranking and therefore in the potential decision.

The results were then presented, and it appeared that, considering the same set of buildings, different rankings were obtained depending on the DG considered. It therefore appears that the MCDA approach developed here is a relevant tool for the aiding process of the different DGs.

Finally, the extension of this original decision approach to a systematic GIS based tool was discussed with the aim of being implemented in the final version of the solar cadastre of the Greater Geneva agglomeration.

Acknowledgement

The authors would like to thank the INTERREG V Suisse-France program for providing financial support to conduct this study.

Bibliography

- Bouyssou, D. (2009), Outranking methods. *Encycl. Optim.* 2887–2893.
- Cajot, S., Mirakyan, A., Koch, A., Maréchal, F. (2017), Multicriteria Decisions in Urban Energy System Planning: A Review. *Front. Energy Res.* 5. <https://doi.org/10.3389/fenrg.2017.00010>
- Chabot, B. (1998), From costs to prices: economic analysis of photovoltaic energy and services. *Prog. Photovolt. Res. Appl.* 55–68.
- Charabi, Y., Gastli, A. (2011), PV site suitability analysis using GIS-based spatial fuzzy multi-criteria evaluation. *Renew. Energy* 36, 2554–2561. <https://doi.org/10.1016/j.renene.2010.10.037>
- Département fédéral de l'environnement, des transports, de l'énergie et de la communication, 2018. *Stratégie énergétique 2050 - Rapport de monitoring 2018.*
- Desthieux, Gilles, Carneiro, C., Camponovo, R., Ineichen, P., Morello, E., Boulmier, A., Abdennadher, N., Dervev, S., Ellert, C. (2018), Solar Energy Potential Assessment on Rooftops and Facades in Large Built Environments Based on LiDAR Data, Image Processing, and Cloud Computing. *Methodological Background, Application, and Validation in Geneva (Solar Cadaster)*. *Front. Built Environ.* 4. <https://doi.org/10.3389/fbuil.2018.00014>
- Desthieux, G., Carneiro, C., Susini, A., Abdennadher, N., Boulmier, A., Dubois, A., Camponovo, R., Beni, D., Bach, M., Leverington, P., Morello, E. (2018), Solar Cadaster of Geneva: A Decision Support System for Sustainable Energy Management, in: Otjacques, B., Hitzelberger, P., Naumann, S., Wohlgemuth, V. (Eds.), *From Science to Society, Progress in IS*. Springer International Publishing, pp. 129–137.
- Figueira, J., Greco, S., Ehrgott, M. (2005), *Multiple criteria decision analysis: state of the art surveys*. Springer Science & Business Media.
- Figueira, J.R., Greco, S., Roy, B., Słowiński, R. (2013), An overview of ELECTRE methods and their recent extensions. *J. Multi-Criteria Decis. Anal.* 20, 61–85.
- Florio, P., Munari Probst, M.C., Schüller, A., Roecker, C., Scartezzini, J.-L. (2018), Assessing visibility in multi-scale urban planning: A contribution to a method enhancing social acceptability of solar energy in cities. *Sol. Energy* 173, 97–109. <https://doi.org/10.1016/j.solener.2018.07.059>
- Garg, H.P. (2000). *Solar energy: fundamentals and applications*. Tata McGraw-Hill Education.
- Govindan, K., Jepsen, M.B. (2016), ELECTRE: A comprehensive literature review on methodologies and applications. *Eur. J. Oper. Res.* 250, 1–29.
- Graziano, M., Gillingham, K., (2014), Spatial patterns of solar photovoltaic system adoption: the influence of neighbors and the built environment. *J. Econ. Geogr.* 15, 815–839.
- Huaylla, F., Berrah, L., Clivillé, V., (2013), A Decision-Aiding Approach for Residential PhotoVoltaic System Choice: An Application to the French Context, in: Emmanouilidis, C., Taisch, M., Kiritsis, D. (Eds.), *Advances in Production Management Systems. Competitive Manufacturing for Innovative Products and Services, IFIP Advances in Information and Communication Technology*. Springer Berlin Heidelberg, pp. 232–239.
- International Energy Agency (2017), *Market Report Series: Renewables 2017* [WWW Document]. IEA Webstore. URL <https://webstore.iea.org/market-report-series-renewables-2017> (accessed 2.11.19).
- IPCC (2019) *Global Warming of 1.5 oC*. URL <https://www.ipcc.ch/sr15/> (accessed 7.1.19).
- Kausika, B.B., Dolla, O., van Sark, W.G.J.H.M. (2017), Assessment of policy based residential solar PV potential using GIS-based multicriteria decision analysis: A case study of Apeldoorn, The Netherlands. *Energy Procedia, Sustainability in Energy and Buildings 2017: Proceedings of the Ninth KES International Conference, Chania, Greece, 5-7 July 2017* 134, 110–120. <https://doi.org/10.1016/j.egypro.2017.09.544>
- Luthander, R., Widén, J., Nilsson, D., Palm, J. (2015), Photovoltaic self-consumption in buildings: A review. *Appl. Energy* 142, 80–94. <https://doi.org/10.1016/j.apenergy.2014.12.028>
- Ministère de la transition écologique et solidaire, (2018), *Stratégie Française pour l'Énergie et le Climat, Programmation Pluriannuelle de l'Énergie*.
- Neves, D., Baptista, P., Simões, M., Silva, C.A., Figueira, J.R. (2018), Designing a municipal sustainable energy strategy using multi-criteria decision analysis. *J. Clean. Prod.* 176, 251–260. <https://doi.org/10.1016/j.jclepro.2017.12.114>
- Noll, D., Dawes, C., Rai, V. (2014), Solar community organizations and active peer effects in the adoption of residential PV. *Energy Policy* 67, 330–343.
- NREL (2019), *Best Research-Cell Efficiency Chart - Photovoltaic Research* [WWW Document]. URL <https://www.nrel.gov/pv/cell-efficiency.html> (accessed 7.22.19).
- Palmas, C., Siewert, A., von Haaren, C. (2015), Exploring the decision-space for renewable energy generation to enhance spatial efficiency. *Environ.*

- Impact Assess. Rev., Information technology and renewable energy - Modelling, simulation, decision support and environmental assessment 52, 9–17. <https://doi.org/10.1016/j.eiar.2014.06.005>
- Pohekar, S.D., Ramachandran, M. (2004), Application of multi-criteria decision making to sustainable energy planning—A review. *Renew. Sustain. Energy Rev.* 8, 365–381. <https://doi.org/10.1016/j.rser.2003.12.007>
- Probst, M.C.M., Roecker, C. (2015), Solar Energy Promotion & Urban Context Protection: Leso-qsv (quality-Site-visibility) Method, in: 31th International PLEA Conference.
- PVPS, (2019), Snapshot of Global PV Markets.
- Roy, B. (1990), The outranking approach and the foundations of ELECTRE methods, in: *Readings in Multiple Criteria Decision Aid*. Springer, pp. 155–183.
- Roy, B. (1968), Classement et choix en présence de points de vue multiples. *Rev. Fr. Inform. Rech. Opérationnelle* 2, 57–75.
- Seddiki, M., Bennadji, A. (2019), Multi-criteria evaluation of renewable energy alternatives for electricity generation in a residential building. *Renew. Sustain. Energy Rev.* 110, 101–117.
- Shukla, A.K., Sudhakar, K., Baredar, P. (2017), Recent advancement in BIPV product technologies: A review. *Energy Build.* 140, 188–195.
- Simos, J. (1990), Evaluer l'impact sur l'environnement: Une approche originale par l'analyse multicritère et la négociation, in: *Evaluer l'impact Sur l'environnement: Une Approche Originale Par l'analyse Multicritère et La Négociation*. Presses polytechniques et universitaires romandes.
- Skiena, S. (1991), *Implementing discrete mathematics: combinatorics and graph theory with Mathematica*. Addison-Wesley Longman Publishing Co., Inc.
- Wu, W., Guo, J., Li, J., Hou, H., Meng, Q., Wang, W. (2018), A multi-objective optimization design method in zero energy building study: A case study concerning small mass buildings in cold district of China. *Energy Build.* 158, 1613–1624. <https://doi.org/10.1016/j.enbuild.2017.10.102>

