

Turning Sun into Water

Present status and perspectives

J. Cherni¹, A. Darga², Ph. Dessante², M. Heinrich³, P. Kitanidis⁴, C. Marchand²,
D.T. Manning⁵, S. Meunier², B. Multon⁶, L. Quéval², T. Vezin³, L. Vido⁷
(in alphabetical order)

¹ Centre for Environmental Policy, Imperial College London, London, UK.

² GeePs, CNRS, CentraleSupélec, Univ. Paris-Sud, Univ. Paris-Saclay, Sorbonne Univ., Gif-sur-Yvette, France

³ DargaTech SARL, Ouagadougou, Burkina Faso

⁴ Department of Civil and Environmental Engineering, Stanford Univ., Stanford, USA

⁵ Department of Agricultural and Resource Economics, Colorado State Univ., Fort Collins, USA

⁶ SATIE, ENS Rennes, Univ. de Rennes, CNRS, Bruz, France

⁷ SATIE, Univ. de Cergy-Pontoise, Cergy-Pontoise, France

Content

- I. Motivation
- II. The photovoltaic water pumping system of Gogma
- III. Modeling & Optimal design
- IV. Contributions & Perspectives

I. Motivation

Why photovoltaic water pumping systems ?

Water collection in rural sub-Saharan Africa

- Rope + bucket in open well
- Hand pump in borehole



Impact ?

Problems

- Extraction arduousness
- Water quality
- Distance source-household
- Cost of water



A competitive motorized solution:

- Photovoltaic water pump



A technical **and socio-economic** problem !



Imperial College
London

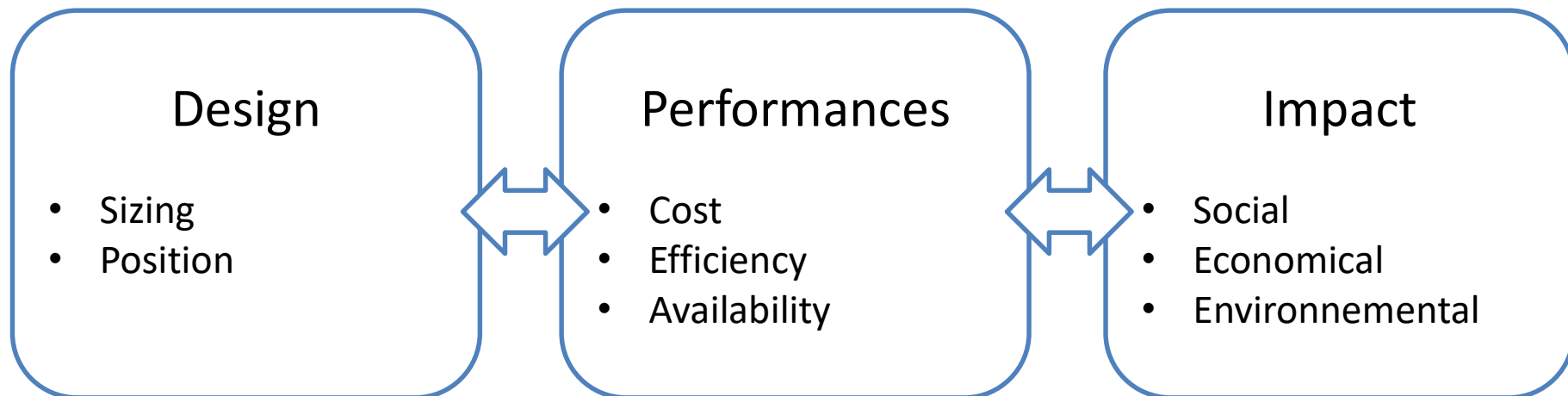

Minimize the lifecycle cost



Maximize the socio-economic impact

II. The Photovoltaic Water Pumping System of Gogma

Turning Sun into Water

thanks to 280 backers !



- Location: Gogma, Burkina Faso
- Water for domestic consumption, 280 inhabitants
- Construction: November-December 2017
- In operation since: January 2018

The rural village of Gogma, Burkina Faso



Photovoltaic water pumping system architecture

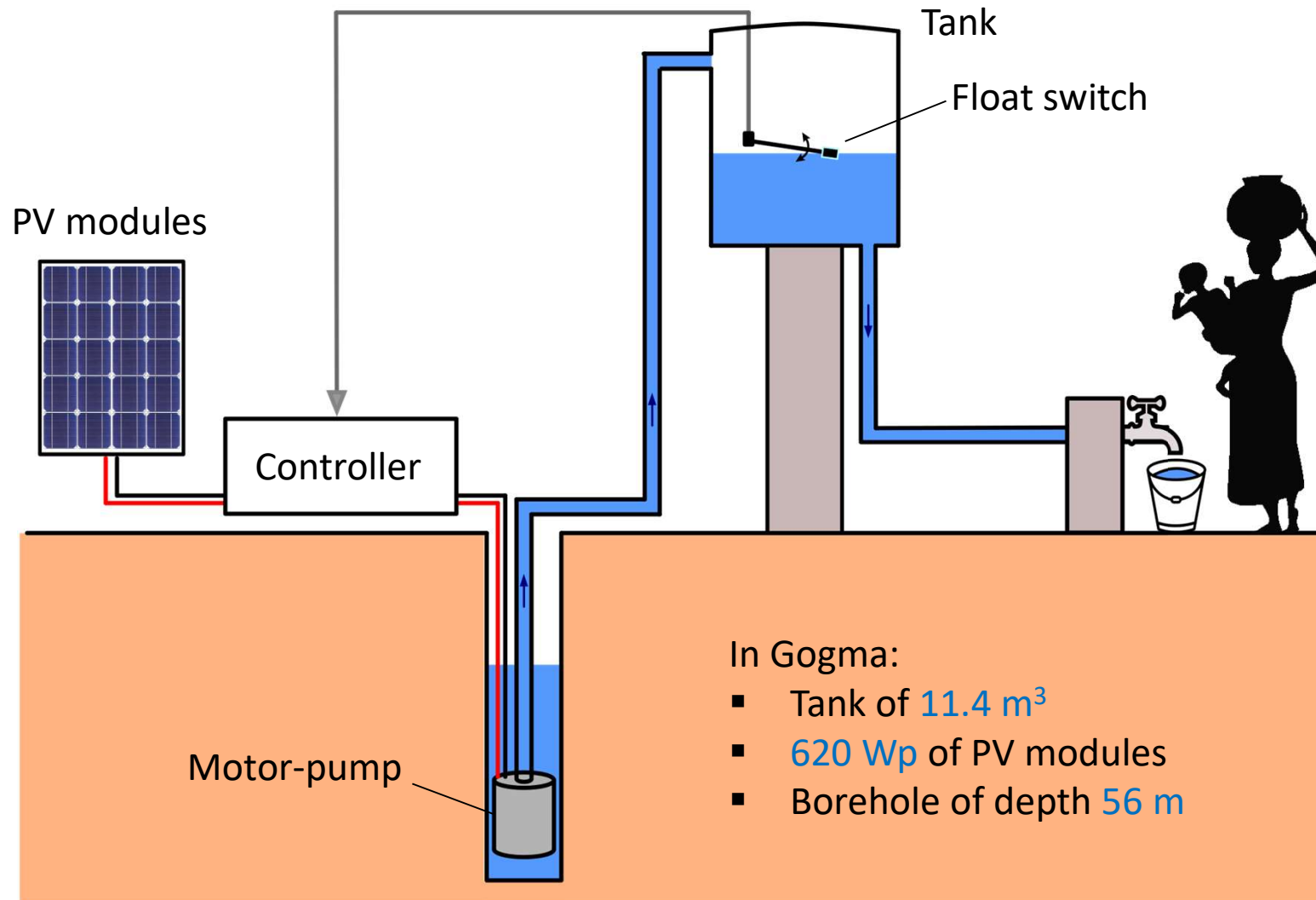

Data collection

- GIS data
- Geophysical measurements
- Water point account books
- Household surveys
- Pumping tests
- Water quality
- On-field observations
- PVWPS monitoring

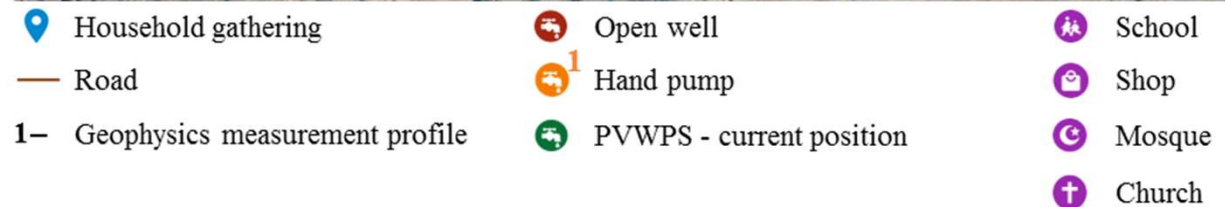
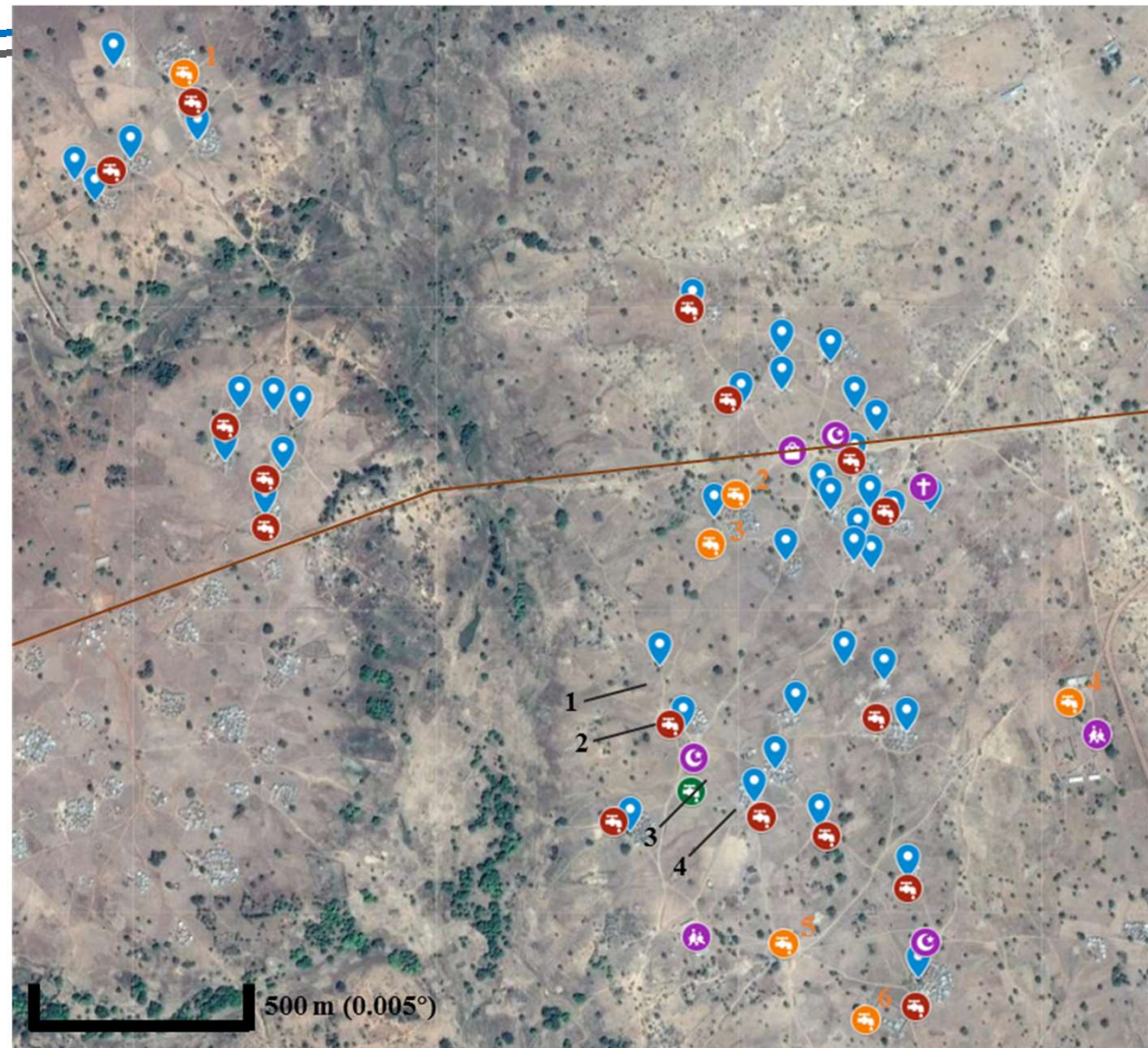

Our PVWPS datalogger

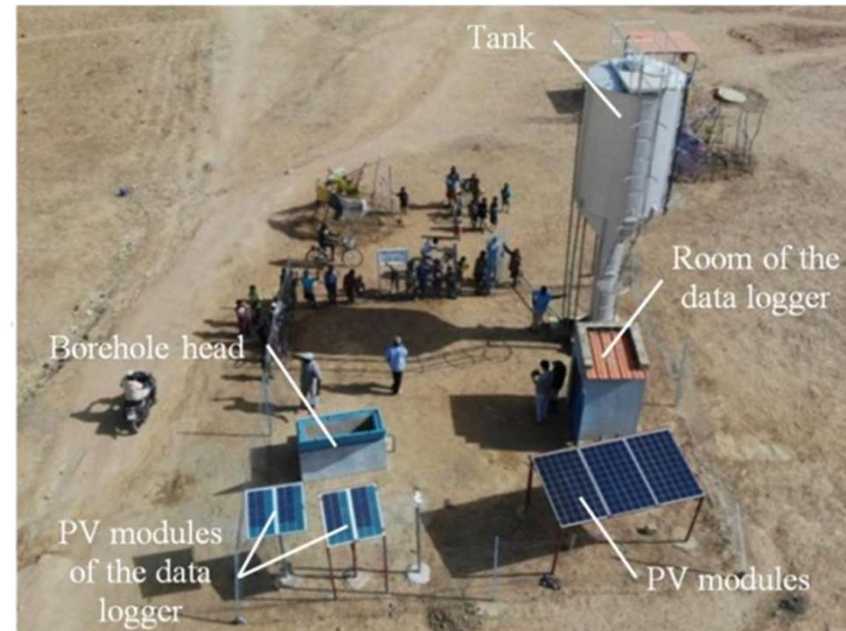
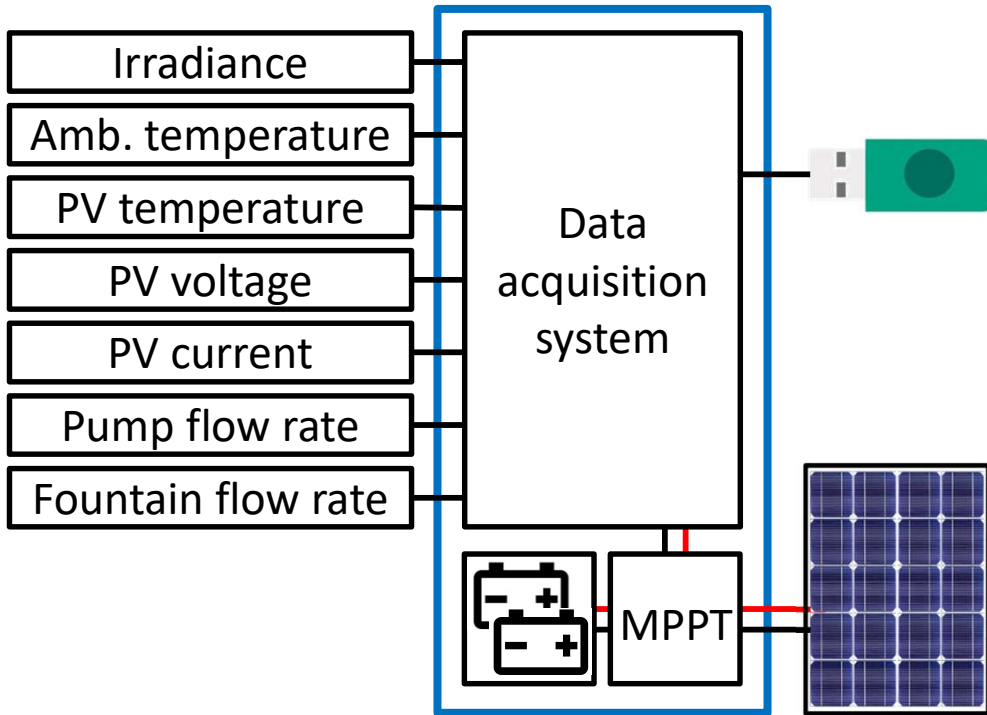

Example of dataset

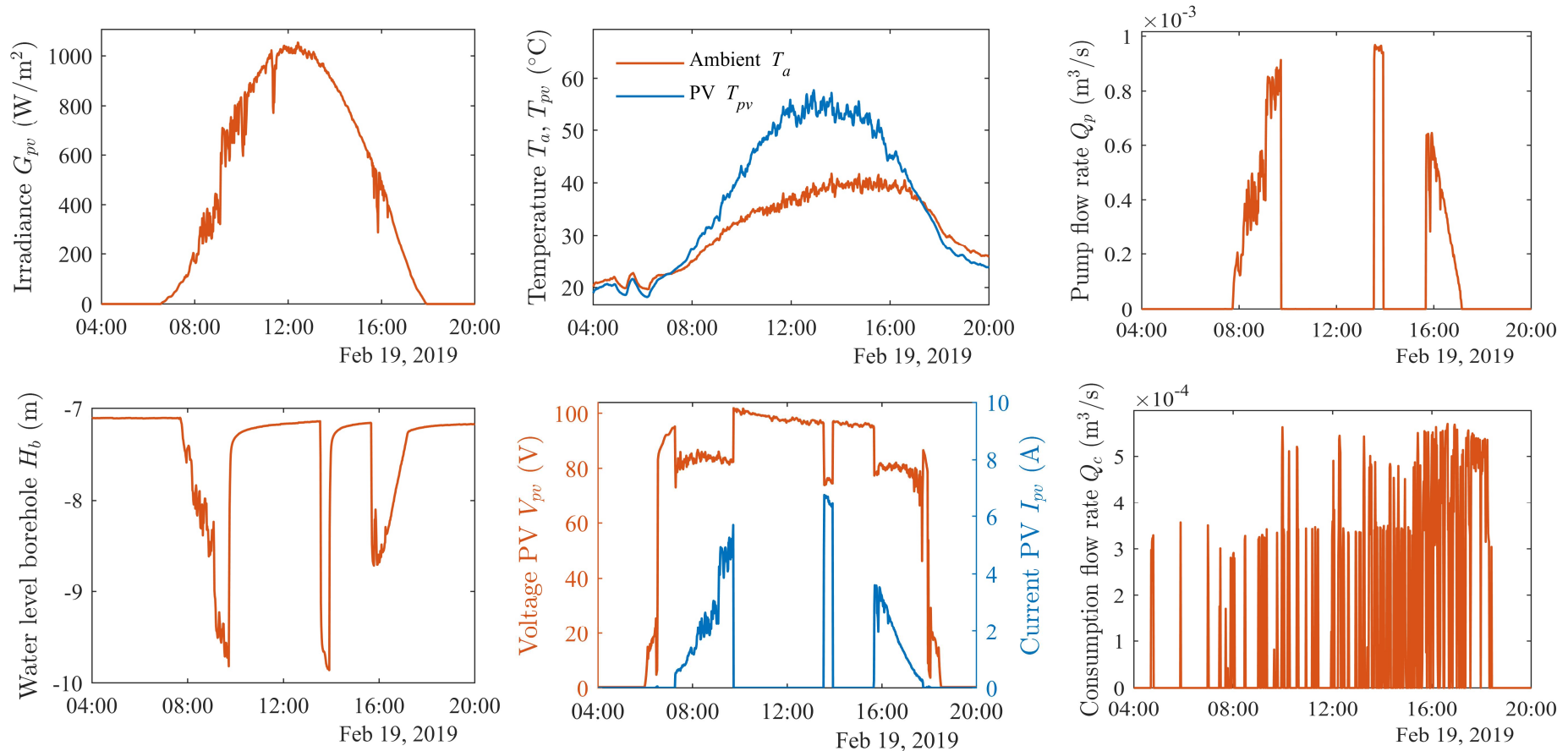

- Running since Jan 2018 (34 month)
- Time step 2 s (45 000 000 data points)

III. Modeling & Optimal design

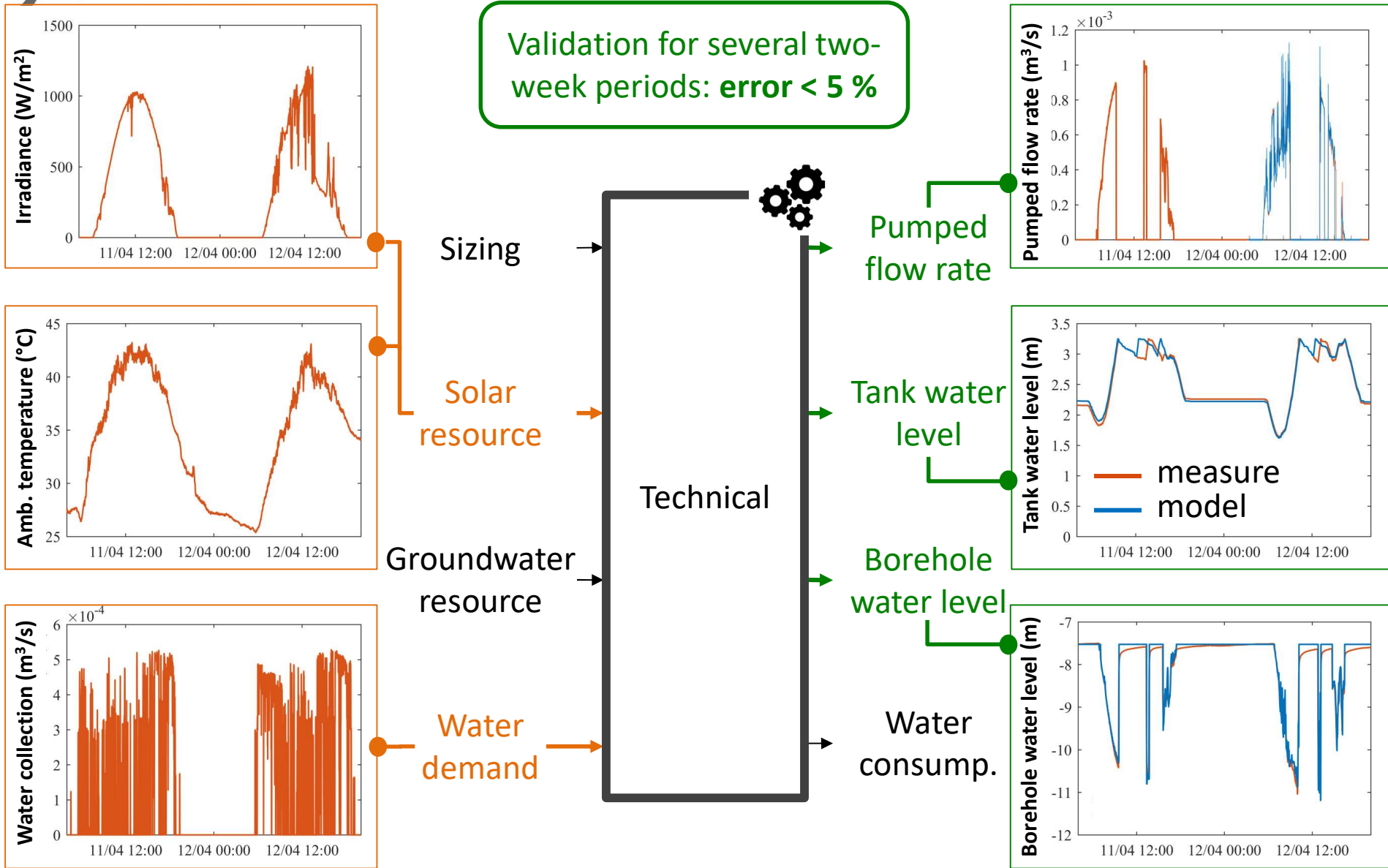

when using satellite data:
accuracy drop < 3 %

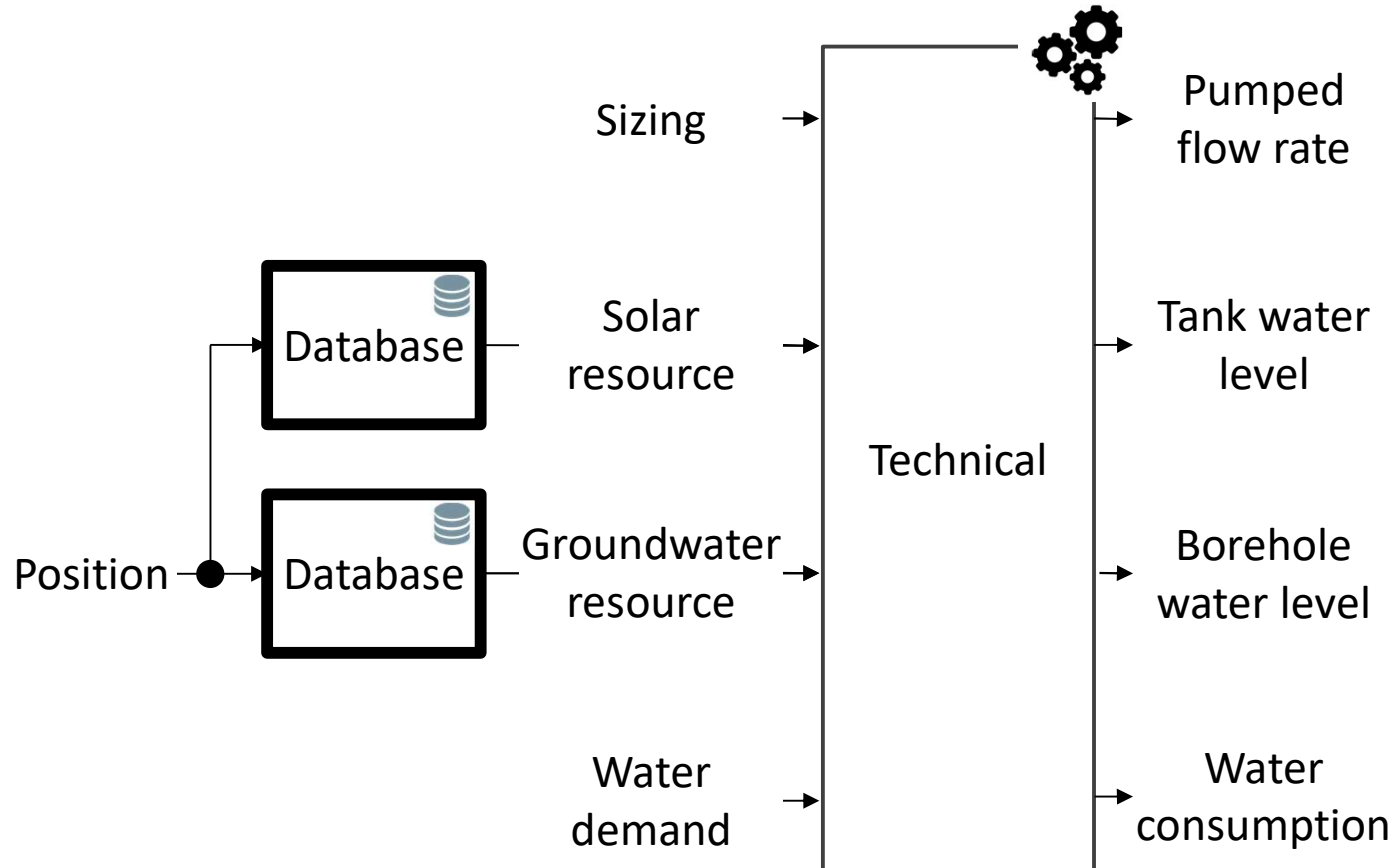

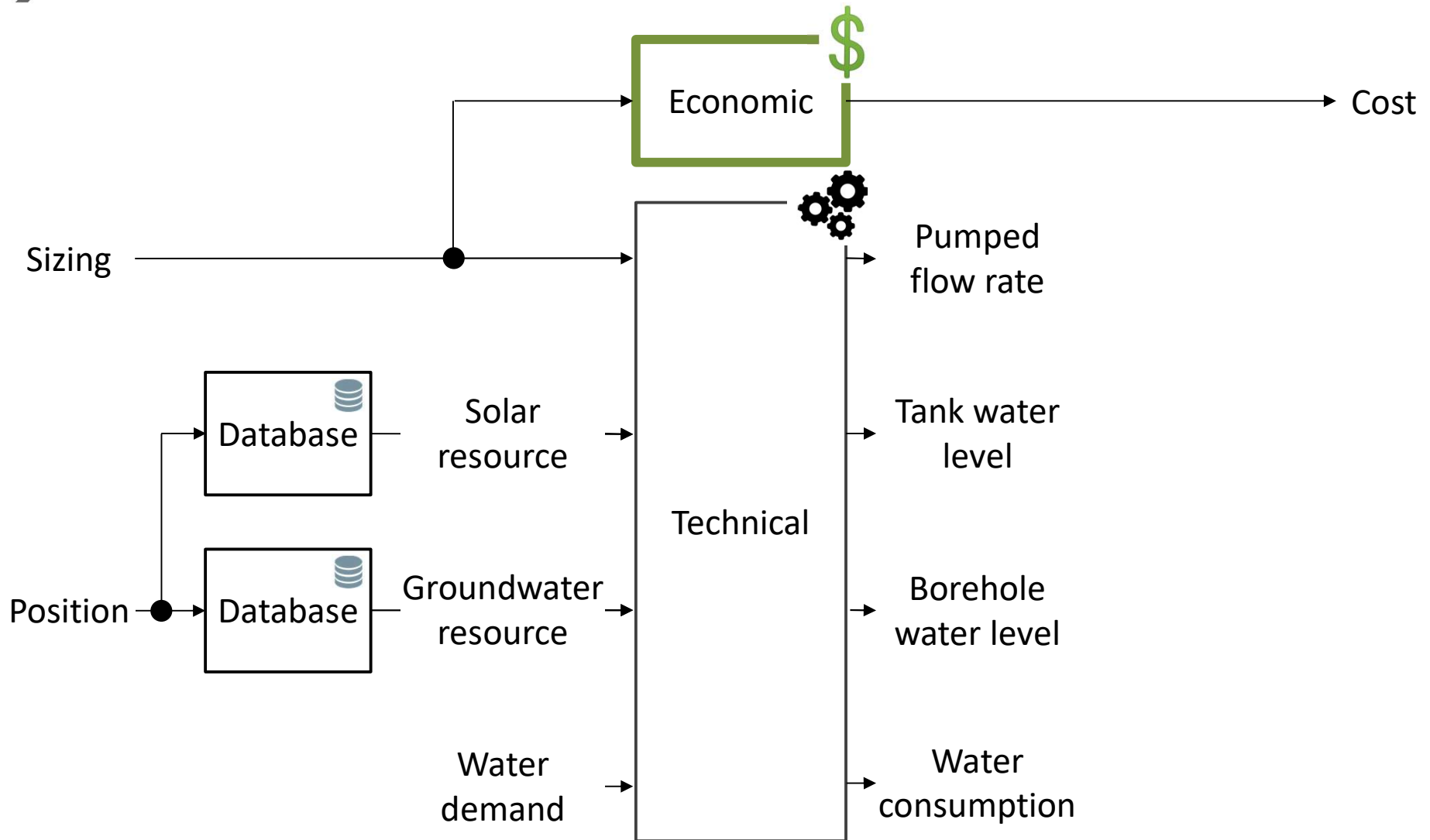

Master thesis Elvire A. de la Fresnaye

Economic model

$$\text{Cost} = CAPEX + OPEX$$

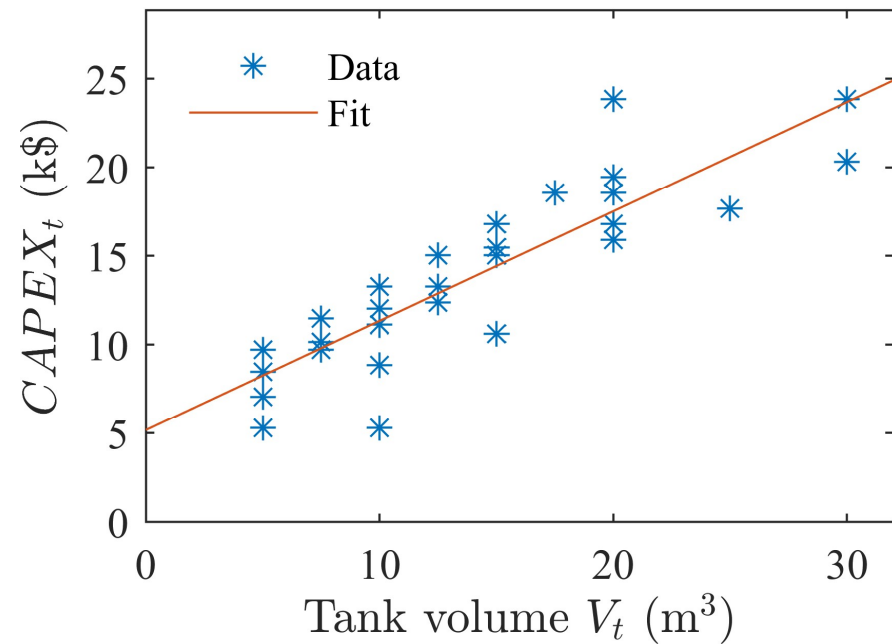
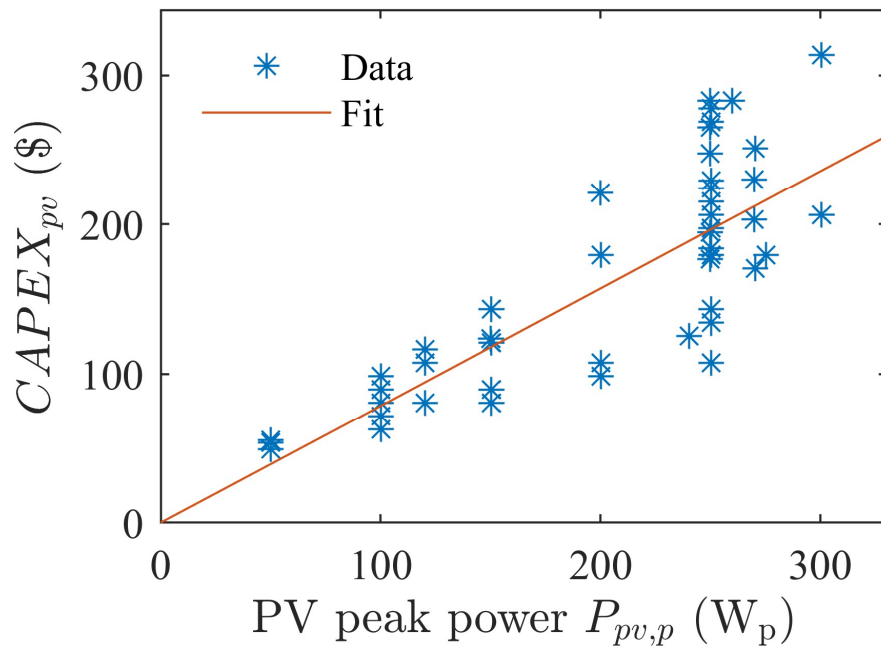

Master thesis Elvire A. de la Fresnaye

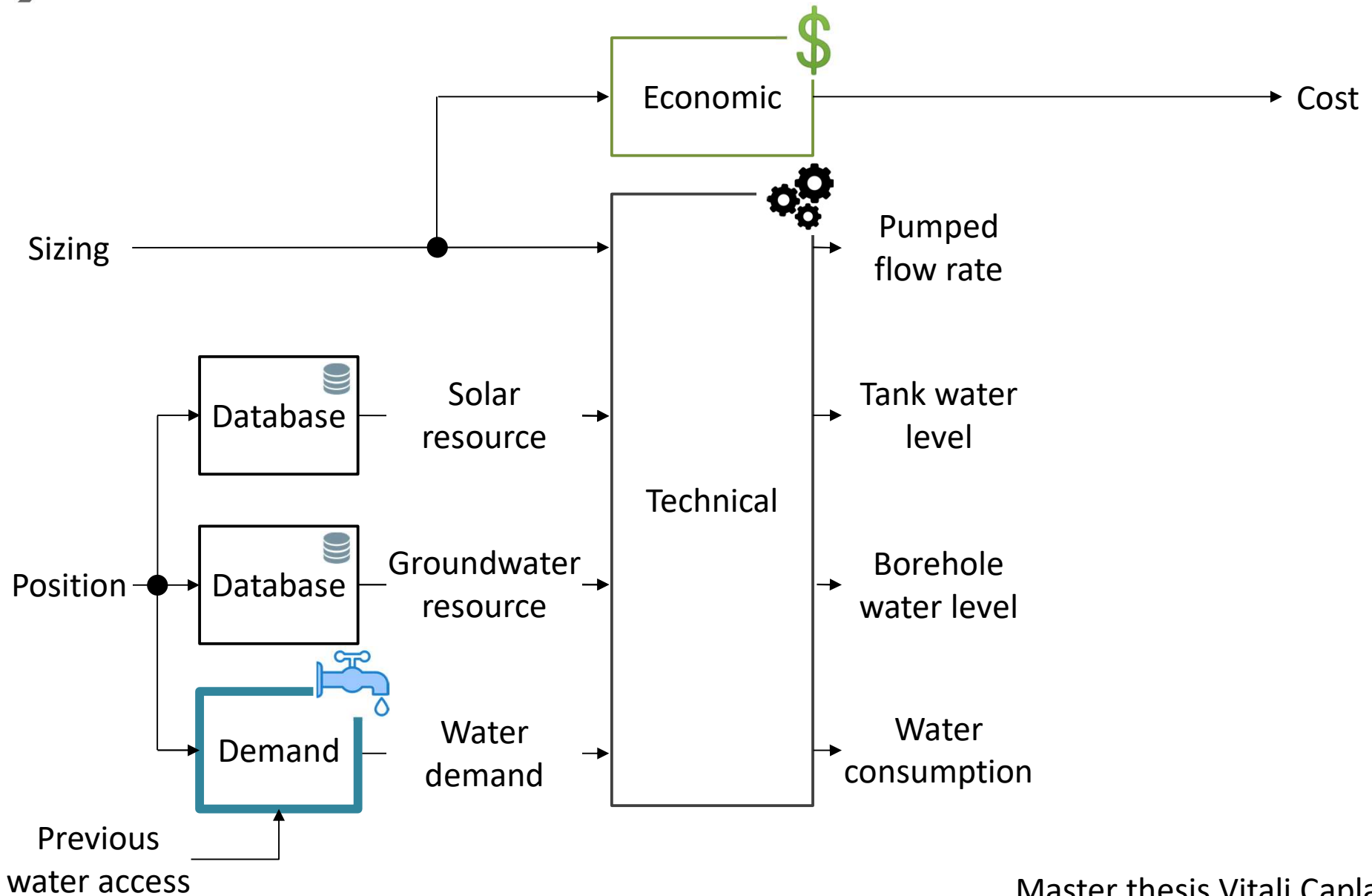

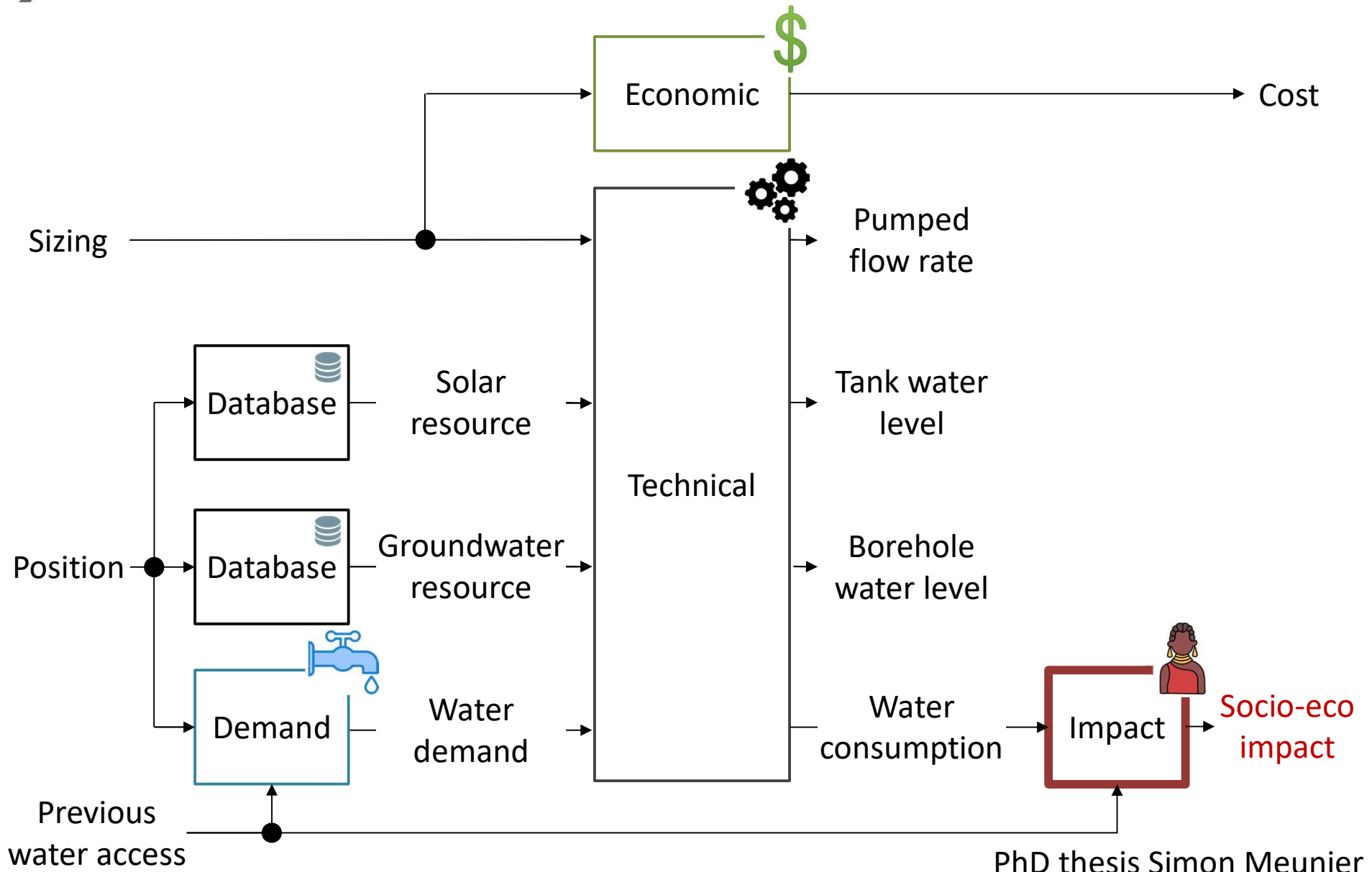

PhD thesis Simon Meunier

Impact model

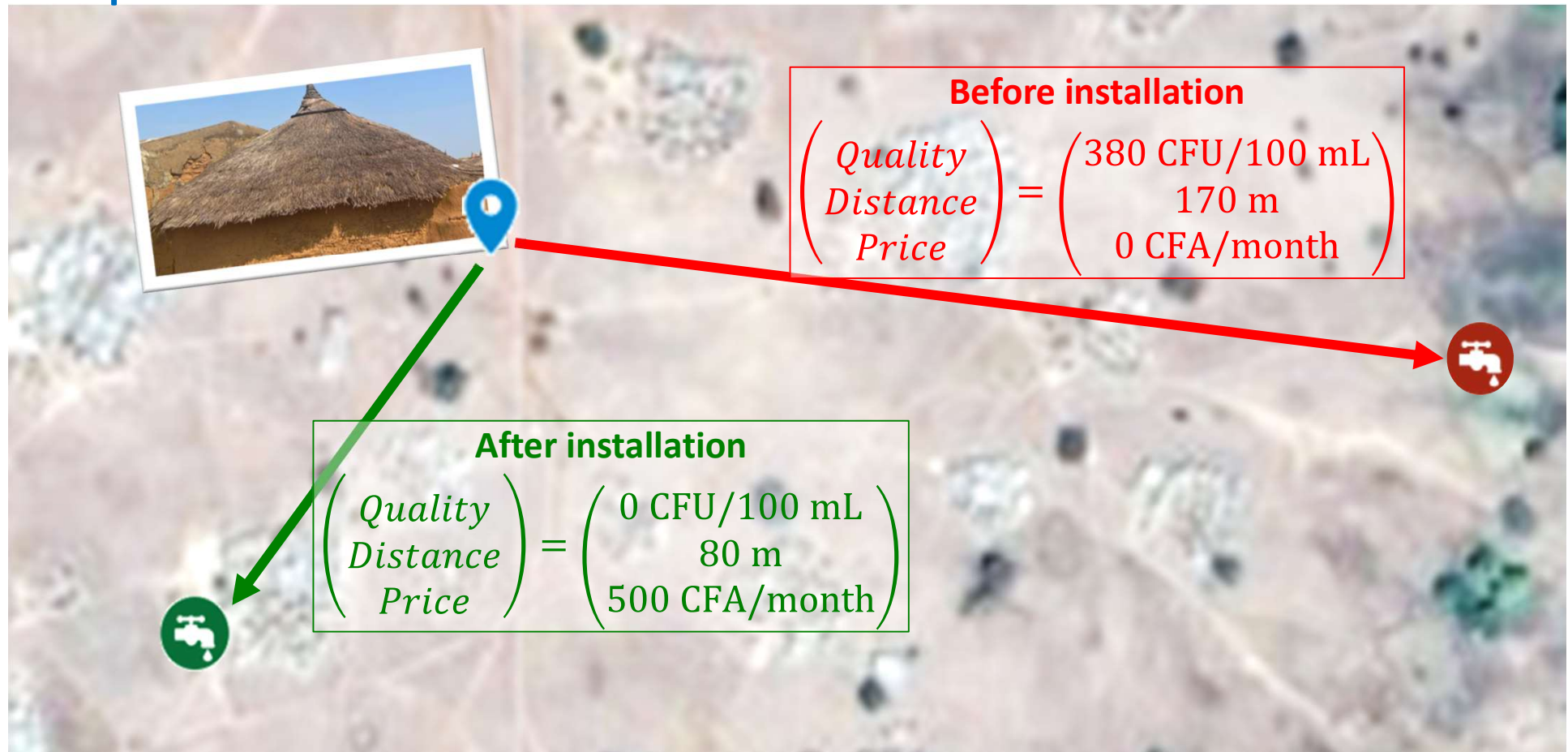

$$\text{Socio - eco impact} = \sum_{\text{village}} \{ \alpha \Delta \text{Quality} + \beta \Delta \text{Distance} + \gamma \Delta \text{Price} \}$$

A technical **and socio-economic** problem !



Imperial College
London

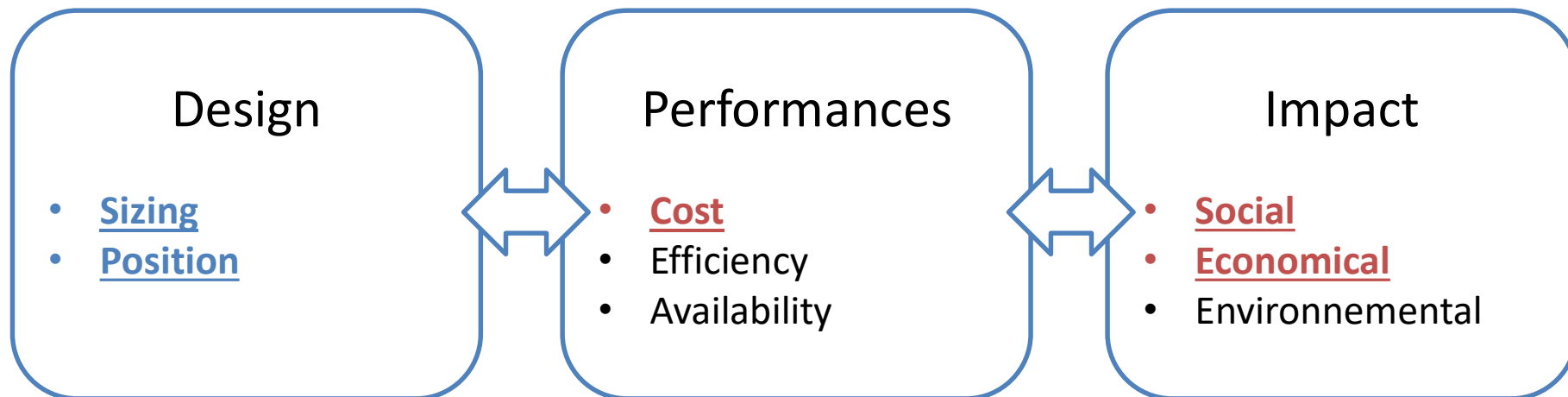

Minimize the lifecycle cost



Maximize the socio-economic impact

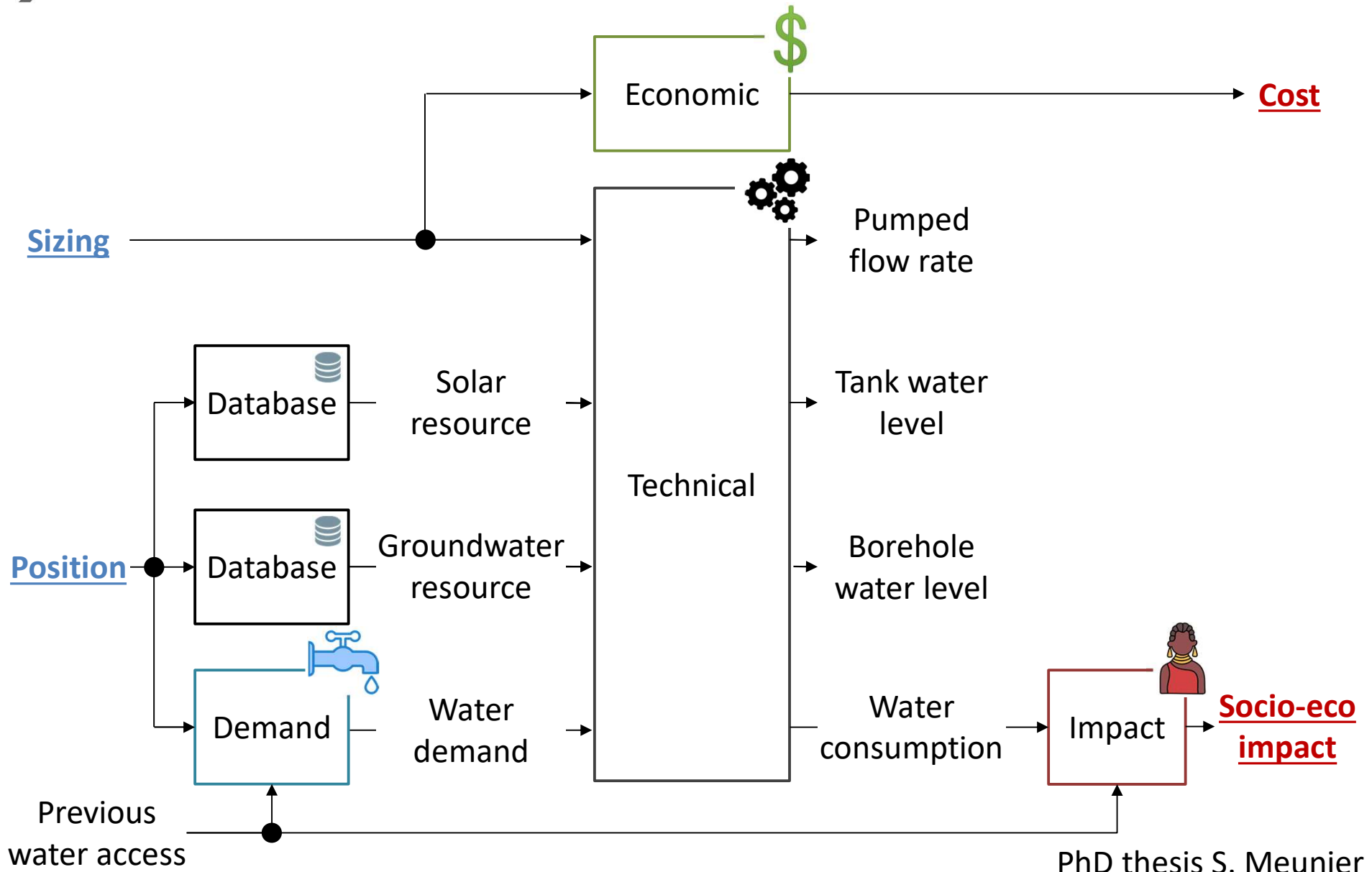

Optimization problem

Formulation

- Optimisation variables



Position
Lat, Lon

Sizing
 $P_{pv,p}, V_t, MP_i$

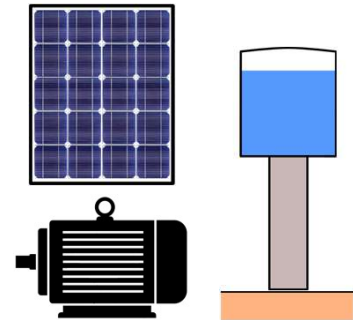

- Objective functions:



Minimize the lifecycle cost



Maximize the socio-economic impact

Solving

- **1 hour time step**, over **1 year**
- **Seasonality** considered (dry/wet)
- Differential evolution algorithm

Optimization results

Pareto front for 8 motor-pump references and deduced final Pareto front

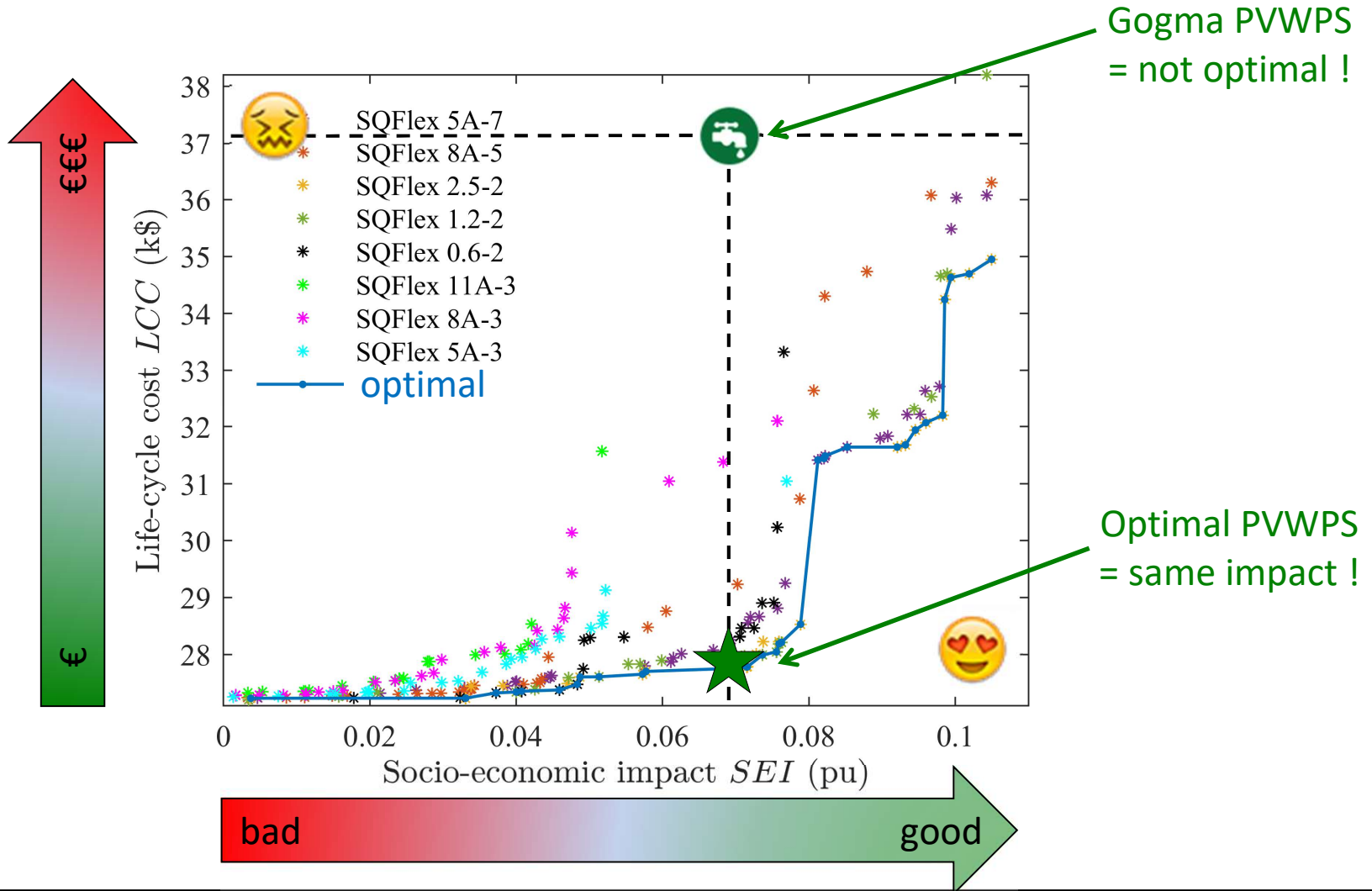

Optimal sizing

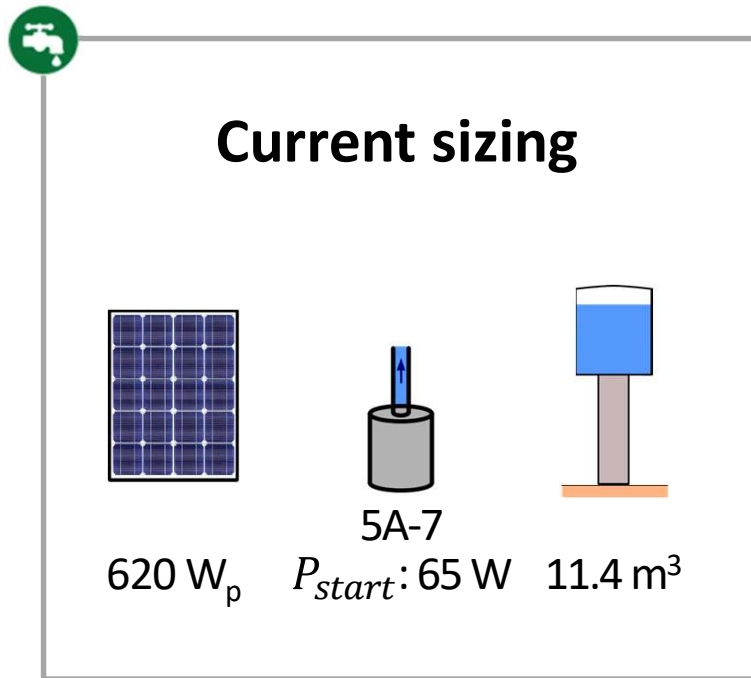

Cost: \$36k
Impact: 0.07

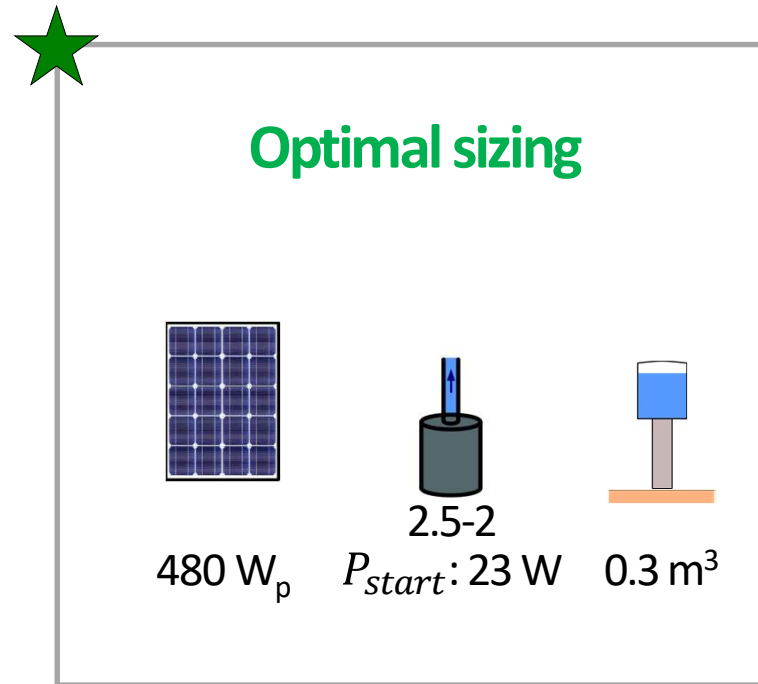



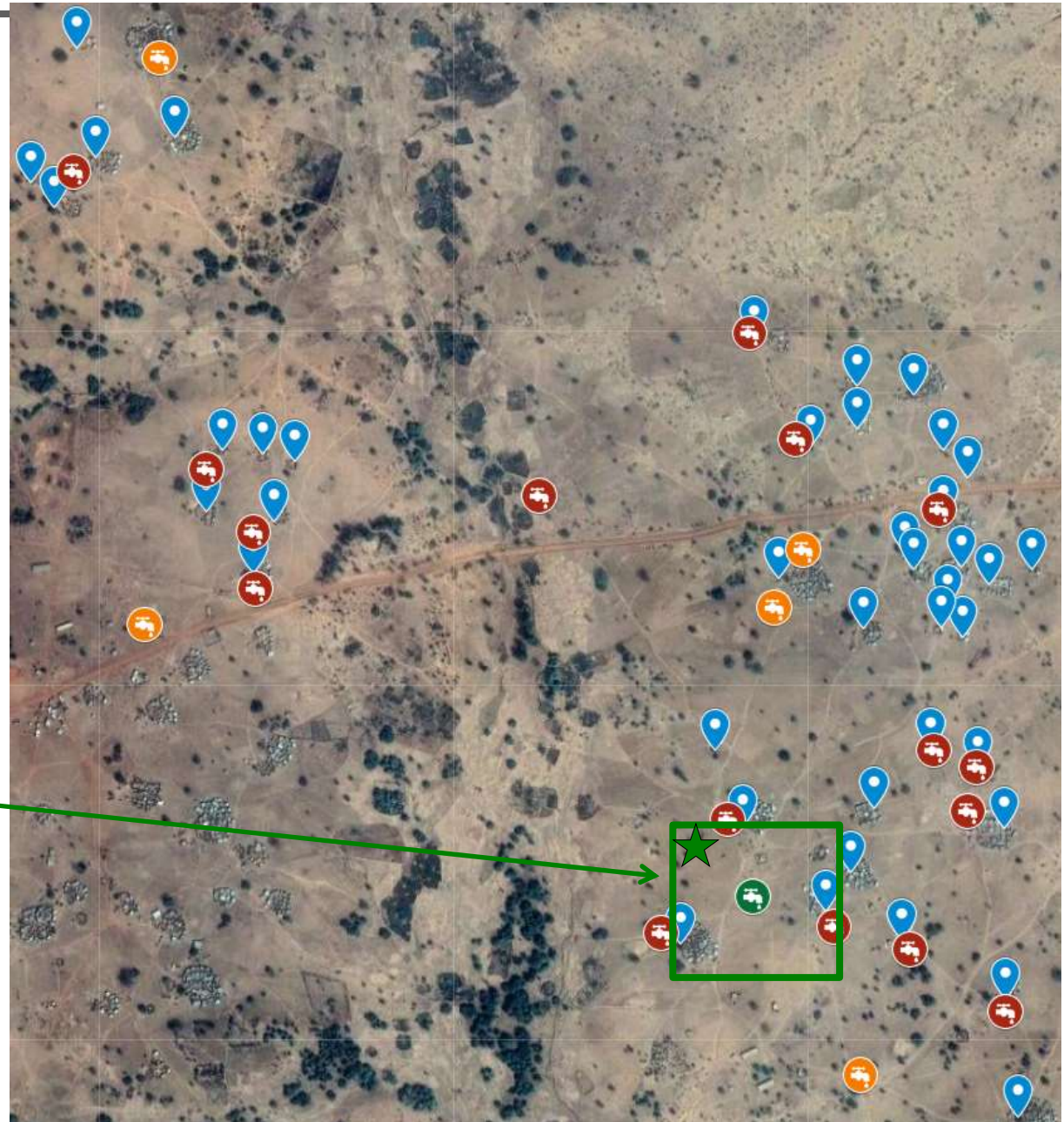

Cost: \$28k
Impact: 0.07

Optimal position



Optimal installation zone

-  Household gathering
-  Open well
-  Hand pump
-  Current PVWPS

IV. Contributions & Perspectives

Contributions

Photovoltaic water pumping systems

- Continuous monitoring of PVWPS for domestic water & in Africa: unique dataset
- Proposition and validation of a PVWPS technical model
- PVWPS modelling:
 - Climatic satellite data suitable
 - 1 hour time step suitable



Methodological

- New optimisation variable: Position
- New objective function: Impact socio-economic
- Coupling of a technical model with a socio-economic model

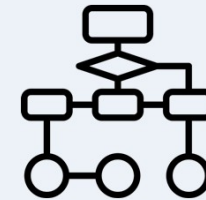

Water access

- Water demand model: predict households' source choice & load curves
- Theory of change: impact of water source choice



Perspectives: Long term impact of PVWPS

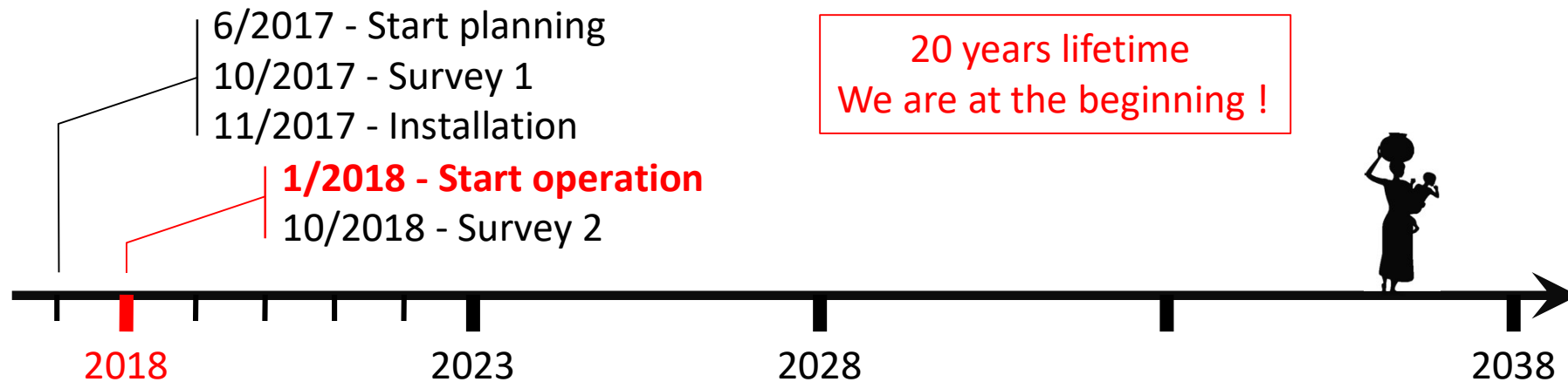

- Long term socio-economic impact (5-year impact)
- Long term environmental impact (hydraulic resources)
- Optimal sizing taking the long-term impact into account ?

SOLAR PUMPING WORKSHOP 2020

 ONLINE CONFERENCE

<https://cutt.ly/SPW2020>



SUBSCRIBE TO ACCESS VIDEOS AND DISCUSSIONS



FRANCAIS & ENGLISH



Merci !

Supporting publications

Journals

- S. Meunier, L. Quéval, A. Darga, P. Dessante, C. Marchand, M. Heinrich, J.A. Cherni, E.A. de la Fresnaye, L. Vido, B. Multon, P.K. Kitanidis, "Sensitivity analysis of photovoltaic pumping systems for domestic water supply," *IEEE Trans. on Industry Applications*, vol. 56, no. 6, pp. 6734-6743, Nov. 2020.
- M. Heinrich, S. Meunier, A. Samé, L. Quéval, A. Darga, L. Oukhellou, B. Multon, "Detection of cleaning interventions on photovoltaic modules with machine learning," *Applied Energy*, vol. 263, id. 114642, Apr. 2020.
- T. Vezin, S. Meunier, L. Quéval, J. A. Cherni, L. Vido, A. Darga, P. Dessante, P. K. Kitanidis, C. Marchand, "Borehole water level model for photovoltaic water pumping systems," *Applied Energy*, vol. 258, id. 114080, Jan. 2020.
- S. Meunier, D.T. Manning, L. Quéval, J.A. Cherni, P. Dessante, D. Zimmerle, "Determinants of the marginal willingness to pay for improved domestic water and irrigation in partially electrified Rwandan villages," *International Journal of Sustainable Development & World Ecology*, vol. 26, no. 6, pp. 547-559, June 2019.
- S. Meunier, M. Heinrich, L. Quéval, J.A. Cherni, L. Vido, A. Darga, P. Dessante, B. Multon, P.K. Kitanidis, C. Marchand, "A validated model of a photovoltaic water pumping system for off-grid rural communities," *Applied Energy*, vol. 241, pp. 580-591, May 2019.

International conferences

- S. Meunier, L. Quéval, M. Heinrich, E.A. de la Fresnaye, J.A. Cherni, L. Vido, A. Darga, P. Dessante, B. Multon, P.K. Kitanidis, C. Marchand, "Effect of irradiance data on the optimal sizing of photovoltaic water pumping systems," *IEEE Photovoltaic Specialists Conf. (PVSC)*, Chicago, USA, June 2019.
- S. Meunier, L. Quéval, A. Darga, P. Dessante, C. Marchand, M. Heinrich, J.A. Cherni, E.A. Fresnaye, L. Vido, B. Multon, P.K. Kitanidis, "Modelling and optimal sizing of photovoltaic water pumping systems - Sensitivity analysis," *14th Int. Conf. on Ecological Vehicles and Renewable Energies (EVER2019)*, Monaco, May 2019. - Award of the best paper on renewable energies
- S. Meunier, L. Quéval, M. Heinrich, J.A. Cherni, L. Vido, A. Darga, P. Dessante, B. Multon, C. Marchand, "Influence of the temporal resolution of the water consumption profile on photovoltaic water pumping systems modelling and sizing," *7th Int. Conf. on Renewable Energy Research and Applications (ICRERA 2018)*, Paris, France, Oct. 2018.
- L. Quéval, A. Coty, L. Vido, R. Gottkehaskamp, B. Multon, "Photovoltaic switched reluctance motor modeling and simulation," *15th IEEE Int. Conf. on Environment and Electrical Engineering (EEEIC2015)*, Rome, Italy, June 2015.
- L. Quéval, A. Coty, L. Vido, B. Multon, "Photovoltaic motors review, comparison and switched reluctance motor prototype," *10th Int. Conf. on Ecological Vehicles and Renewable Energies (EVER2015)*, Monaco, April 2015.