



HAL
open science

Molecular signatures of beef tenderness: Underlying mechanisms based on integromics of protein biomarkers from multi-platform proteomics studies

Mohammed Gagaoua, Claudia Terlouw, Anne Maria Mullen, Daniel Franco, Robyn Warner, José Lorenzo, Peter Purslow, David Gerrard, David Hopkins, Declan Troy, et al.

► To cite this version:

Mohammed Gagaoua, Claudia Terlouw, Anne Maria Mullen, Daniel Franco, Robyn Warner, et al.. Molecular signatures of beef tenderness: Underlying mechanisms based on integromics of protein biomarkers from multi-platform proteomics studies. *Meat Science*, 2021, 172, pp.108311. 10.1016/j.meatsci.2020.108311 . hal-03124816

HAL Id: hal-03124816

<https://hal.science/hal-03124816>

Submitted on 20 Sep 2023

HAL is a multi-disciplinary open access archive for the deposit and dissemination of scientific research documents, whether they are published or not. The documents may come from teaching and research institutions in France or abroad, or from public or private research centers.

L'archive ouverte pluridisciplinaire **HAL**, est destinée au dépôt et à la diffusion de documents scientifiques de niveau recherche, publiés ou non, émanant des établissements d'enseignement et de recherche français ou étrangers, des laboratoires publics ou privés.



Distributed under a Creative Commons Attribution - NonCommercial - NoDerivatives 4.0 International License

Journal Pre-proof

Molecular signatures of beef tenderness: Underlying mechanisms based on integromics of protein biomarkers from multi-platform proteomics studies

Mohammed Gagaoua, E.M. Claudia Terlouw, Anne Maria Mullen, Daniel Franco, Robyn D. Warner, José M. Lorenzo, Peter P. Purslow, David Gerrard, David L. Hopkins, Declan Troy, Brigitte Picard



PII: S0309-1740(20)30743-9

DOI: <https://doi.org/10.1016/j.meatsci.2020.108311>

Reference: MESC 108311

To appear in: *Meat Science*

Received date: 6 July 2020

Revised date: 9 September 2020

Accepted date: 14 September 2020

Please cite this article as: M. Gagaoua, E.M.C. Terlouw, A.M. Mullen, et al., Molecular signatures of beef tenderness: Underlying mechanisms based on integromics of protein biomarkers from multi-platform proteomics studies, *Meat Science* (2020), <https://doi.org/10.1016/j.meatsci.2020.108311>

This is a PDF file of an article that has undergone enhancements after acceptance, such as the addition of a cover page and metadata, and formatting for readability, but it is not yet the definitive version of record. This version will undergo additional copyediting, typesetting and review before it is published in its final form, but we are providing this version to give early visibility of the article. Please note that, during the production process, errors may be discovered which could affect the content, and all legal disclaimers that apply to the journal pertain.

© 2020 Published by Elsevier.

Molecular signatures of beef tenderness: underlying mechanisms based on integromics of protein biomarkers from multi-platform proteomics studies

Mohammed Gagaoua^{1*}, E.M. Claudia Terlouw², Anne Maria Mullen¹, Daniel Franco³, Robyn D. Warner⁴, José M. Lorenzo³, Peter P. Purslow⁵, David Gerrard⁶, David L. Hopkins⁷, Declan Troy¹, Brigitte Picard²

¹ Food Quality and Sensory Science Department, Teagasc Ashdown Food Research Centre, Ashdown, Dublin 15, Ireland

² INRAE, Université Clermont Auvergne, VetAgro Sup, UMR Herbivores, F-63122 Saint-Genès-Champanelle, France

³ Centro Tecnológico de la Carne de Galicia, rúa Galicia nº 4, Parque Tecnológico de Galicia, San Cibrao das Viñas, 32900 Ourense, Spain

⁴ School of Agriculture and Food, Faculty of Veterinary and Agricultural Sciences, University of Melbourne, Parkville, VIC 3010, Australia

⁵ Centro de Investigación Veterinaria de Tandil (CIVETAN), Universidad Nacional del Centro de la Provincia de Buenos Aires, Tandil B7001BBO, Argentina

⁶ Department of Animal and Poultry Sciences, Virginia Tech, Blacksburg, VA 24061, USA

⁷ NSW DPI, Centre for Red Meat and Sheep Development, Cowra, NSW 2794, Australia

*** To whom all correspondence should be addressed**

Dr. Mohammed GAGAOUA; Email: gmber2001@yahoo.fr; ORCID: 0000-0001-6913-3379

Abstract

Over the last two decades, proteomics have been employed to decipher the underlying factors contributing to variation in the quality of muscle foods, including beef tenderness. One such approach is the application of high-throughput protein analytical platforms in the identification of meat quality biomarkers. To broaden our understanding about the biological mechanisms underpinning meat tenderization across a large number of studies, an integromics study was performed to review the current status of protein biomarker discovery targeting beef tenderness. This meta-analysis is the first to gather and propose a comprehensive list of 124 putative protein biomarkers derived from 28 independent proteomics-based experiments, from which 33 robust candidates were identified worthy of evaluation using targeted or untargeted data-independent acquisition proteomic methods. We further provide an overview of the interconnectedness of the main biological pathways impacting tenderness determination after multistep analyses including Gene Ontology annotations, pathway and process enrichment and literature mining, and specifically discuss the major proteins and pathways most often reported in proteomics research.

Keywords: Meta-analysis; Meat tenderness; Data integration; Panel of biomarkers; *Longissimus thoracis*; Muscle; Proteomics; Enzymes; Z-disks; Biological pathways; Networks.

1. Introduction

The meat industry currently lacks a rapid objective method for estimating the eating quality of beef, either in the live animal or in the carcass. Addressing this gap in knowledge and technology would greatly increase the efficiency of the beef industry worldwide and promote the ability to generate higher quality product. In order to accomplish this, the underlying mechanisms responsible for creating the most important meat quality traits must be defined. To that end, there is a general consensus among those studying meat qualities that it may be useful to first reveal the gene and protein networks responsible for the development of the desired quality phenotype before attempting to develop technologies for predicting meat quality. However, such technology would readily allow us to manage the marketing of a meat quality trait, and develop genetic selection schemes for producers to optimize quality. A number of attempts have been made to achieve this lofty goal over the past couple of decades, specifically the study of meat quality variation using high-throughput protein analytical platforms also known as proteomics. One research area where proteomics has been of particular interest is in the discovery of meat quality biomarkers as proxies for predicting sensory, technological and physic-chemical quality traits of meat (Hollung *et al.* 2007; Ouali *et al.* 2013; Picard *et al.* 2017; Lopez-Pedrouso *et al.* 2019; Gagaoua *et al.* 2020b).

In an effort to better understand those mechanisms underlying beef tenderness, proteomics has emerged as a well-defined strategy which, through in-depth characterization of the whole bovine skeletal muscle proteome, has provided substantial data in terms of potential protein biomarkers associated with tenderness pathways and its prediction (Wu *et al.* 2015; Picard & Gagaoua 2017; Gagaoua *et al.* 2020a). These biomarkers, for which the abundance differs as a consequence of factors ranging from farm rearing practices to muscle characteristics and meat processing (Gagaoua *et al.* 2019a; Gagaoua *et al.* 2019b; Picard *et al.* 2019), can distinguish between extreme tenderness groups. These biomarkers belong to different but interconnected biological pathways that reflect stress and oxidative stress reactions, energy metabolism, myofibril and muscle structure, apoptosis, transport, signaling and proteolysis (Ouali *et al.* 2013; Gagaoua *et al.* 2020b; Picard & Gagaoua 2020a).

Tremendous progress in improved sample preparation, liquid chromatography and mass spectrometry technologies, coupled with the development of sophisticated algorithms for protein identification have led to the possibility of screening a myriad of muscle proteins from muscle tissue early *post-mortem*. These proteins have been correlated with meat texture/tenderness phenotypes, as evaluated by trained sensory panelists and/or by instrumental methods, *i.e.*,

Warner-Bratzler shear force (WBSF) on aged and cooked meat. The identification, mostly in the *Longissimus thoracis et lumborum*, of putative protein biomarkers of beef tenderness has enhanced our understanding of the mechanisms which influence the conversion of muscle into meat (Laville *et al.* 2009; Guillemain *et al.* 2011; Hollung *et al.* 2014; Zhao *et al.* 2014; Gagaoua *et al.* 2015b; Picard & Gagaoua 2017; Gagaoua *et al.* 2020a) and proposed the first prediction equations explaining tenderness variation due to changes in proteins (Zapata *et al.* 2009; Picard *et al.* 2014; Gagaoua *et al.* 2017a; Gagaoua *et al.* 2018b). Furthermore, during recent years, we have made significant progress in our quest to identify reliable biomarkers of beef tenderness (Picard & Gagaoua 2020a). This has been accomplished through evaluating and validating a short list of candidate biomarkers using a variety of techniques, namely immune-based techniques such as Dot-Blot (Guillemain *et al.* 2009; Gagaoua *et al.* 2015c; Gagaoua *et al.* 2017b; Gagaoua *et al.* 2019c) and Reverse Phase Protein Array (Gagaoua *et al.* 2018b; Picard *et al.* 2018).

Given the interest in predicting product quality worldwide, it is timely to comprehensively evaluate the published data to review what is known about the utility of proteomics in understanding beef tenderness development. Furthermore, it is important to know what has been identified during the past 10 years as putative protein biomarkers of tenderness and prudent to explore how we move forward in the discovery pipeline with a robust list of candidate protein biomarkers to validate their veracity in predicting beef tenderness using representative populations of cattle across the globe. Considering the vastness of the data collected thus far and the need to establish a biologically meaningful and comprehensive list of biomarkers for tenderness, our aim was to use an integrative “omics” (‘integromics’) approach to integrate proteomics datasets from independent proteomic-based studies. Using a meta-analysis approach with data collected from the *Longissimus* muscle we propose for the first time an updated, effective panel of 33 robust biomarkers of beef tenderness using a lower cut-off of proteins appearing in at least four independent studies.

2. Methodology and results

2.1. Literature search strategy

A systematic computerized search of the Google Scholar, Pubmed.gov (NCBI), Scopus and Web of Science (Clarivate Analytics) databases was performed as depicted in **Figure 1** using an existing search strategy (Gagaoua *et al.* 2020b). All the eligible proteomic-based studies that investigated beef tenderness from original papers published up to 1 April 2020 were thus

identified, and organized into a spreadsheet reference manager. The search keywords that were used were included in **Figure 1**. For all relevant articles, the records retrieved with the related article links in the databases were further screened, and the reference lists of each individual paper were also carefully checked for any other relevant studies.

2.2. Selection of publications: inclusion/exclusion criteria and quality assessment

The first search using the entire databases yielded a total of 4201 publications (**Figure 1**). We then detected and deleted the duplicates manually using Reference Manager and then one person screened the title and abstract of 2160 studies for relevancy based on exclusion of any studies not on bovine skeletal muscle proteome (**Figure 1**). From this, 178 full-text publications were deemed suitable and the relevant articles were retrieved, provided they were in English and published in peer-reviewed journals, to ensure the methodological quality of the studies.

The publications for inclusion in the integromics were selected and further examined, to determine whether they should be included based on the criteria shown in **Figure 1** which were: papers that investigated beef tenderness using proteomic-based techniques using solely the *Longissimus* muscle (including: *longissimus dorsi*, *longissimus lumborum* and *longissimus thoracis*) with measurements of protein biomarkers identification and/or evaluation. This process excluded studies on all other muscles and those using other “omics” techniques such as genomics, phosphoproteomics and metabolomics. Also, we excluded papers that investigated other species not clearly mentioned in the abstract and those that are in bovine and *Longissimus* muscle but not related to tenderness. Reviews were also excluded, but not integrative studies that contained a combination of proteomics experiments. Studies not indicating significant correlations with tenderness traits or differential abundant protein (DAP) among beef tenderness groups were also excluded. Finally, studies were excluded that reanalyzed the same dataset by applying different statistical methods and we kept only one study complying with our criteria.

The experimental design of each study was carefully screened including the identified proteins and the direction of change and/or associations with beef tenderness evaluated either by sensory trained panelists or WBSF. The quality assessment of the experimental designs (**Table S1**) and proteomics-based methodologies used to retrieve the putative protein biomarkers of beef tenderness were evaluated following the guidelines of the Newcastle-Ottawa scale. This quality check revealed that most (96%) of the eligible studies used good data by reporting the information needed in the context of the discovery of beef tenderness biomarkers. Our quality assessment check provides an overview of the quality of the publication and proteomic study

reporting but does not address the quality of the proteomic data itself. There are a certain variations in reporting proteomic analytical details independent of whether a journal provides guidelines. Aggregating data from multi-platform proteomics datasets from a qualitative point of view is the main objective of the present integromics study. Such variations are not a major hindrance, as the direction of changes in protein abundance in association with beef tenderness traits is the information needed.

2.3. Database preparation: data extraction and proteomic data aggregation

A total of 22 papers, which included 28 proteomics experiments (888 animals; **Table 1** and **Table S1**) fulfilled the above criteria and were included in this integromics to create the first repertoire of beef tenderness biomarkers (Kim *et al.* 2008; Morzel *et al.* 2008; Jia *et al.* 2009; Laville *et al.* 2009; Zapata *et al.* 2009; Guillemain *et al.* 2011; Bjarnadottir *et al.* 2012; D'Alessandro *et al.* 2012a; D'Alessandro *et al.* 2012b; Sierra *et al.* 2012; Carvalho *et al.* 2014; Picard *et al.* 2014; Zhao *et al.* 2014; Baldassini *et al.* 2015; Gagaoua *et al.* 2017a; Beldarrain *et al.* 2018; Gagaoua *et al.* 2018b; Malheiros *et al.* 2019; Silva *et al.* 2019; Boudon *et al.* 2020; Gagaoua *et al.* 2020a; Picard & Gagaoua 2020a). Supplementary files in these papers were examined for details on the experimental designs and all the relevant information were summarized in **Table S1**. Data from various other publications including reviews, which did not meet the selection criteria but are still of relevance (*e.g.*, putative proteins reported in other muscles or beef qualities) for the broader context, were taken into consideration in the discussion.

Data collection from the 22 publications was performed according to a protocol that allows for the creation of a full database using spreadsheets in Microsoft Excel with the following information extracted from each study in the order of the publication year (**Table S1**): experiment number (from the oldest Exp.1_ref 1 published in 2008 to the newest publication in 2020 as Exp.28_ref 22), first author's name, publication year, journal, hyperlink Digital Object Identifier (DOI) of the paper, breed, gender or animal category, age at slaughter, sampling position of the steaks and time, ageing time of the steaks, conditions of the evaluation of tenderness using sensory panelists or WBSF measurements, end-point cooking temperature (maximum internal temperature achieved when a sample is cooked), number of samples included in the experiment, type of the protein extracts (myofibrillar, sarcoplasmic or both), the proteomic-based platform used and associated details, the selection approach of the differential proteins and finally the number of putative biomarkers that were retrieved by our criteria.

Key information regarding the proteins of interest (unique gene names (GN)) and their relationships with beef tenderness were annotated by giving their UniprotID accession numbers, GN, full name of the proteins, direction of change or associations (positive (●) blue color, negative (■), red or both directions (◆) orange) with the tenderness scores or WBSF values collected (**Table 1**). Within each individual study, if a same protein was correlated ($P < 0.05$) with tenderness traits or showed differential abundance according to tenderness in the same direction more than once, due to either different isoforms or under different conditions, such as breed, tenderness measurement, or ageing time, it was listed only once.

2.4. Results: Database description

A computational workflow allowed aggregation of 124 proteins (unique GN) from the 28 proteomic-based experiments, several of which were common among the studies (**Table 1**) and across the animal categories (**Table S2**). Uncharacterized proteins ($n = 2$) were not included. The list of DAP provided by authors were based on fold-change and/or p -value and/or significant correlations/regression as determined for each study (**Table S1**). In fact, the selection criteria for proteins retrieved in the 28 experiments differed somewhat; two studies used a fold-change, 16 used differences in protein abundance between extreme groups of tenderness and 10 used regression analyses based on significant correlations ($P < 0.05$). Data collected from the 28 experiments ($n=888$ animals) were from different animal categories (genders): 15 experiments used bulls ($n=371$ animals), five used cows ($n=326$), four used steers ($n=46$), three used both bulls and steers ($n=135$, the authors mixed the animals, thus we coded this category as bulls+steers) and only one study used heifers (**Table S1**). The muscle proteome was mostly characterized on protein extracts from samples collected during the first hour of harvest for 16 studies or at 24 h *post-mortem* for 10 experiments. Two studies used muscle samples taken from carcasses at 36 and 48 h *post-mortem*. Samples originated from non-stimulated carcasses for 26 experiments and stimulated carcasses for two studies (90V at 30 min *post-mortem*) (Jia *et al.* 2009; Bjarnadottir *et al.* 2012).

The highest number of proteins from the 124 were retrieved for bulls ($n=90$, including 37 that were specific), explained by the high number of experiments conducted on bulls (**Table S2**). The steers followed with 46 proteins (5 specific), heifers with 40 proteins (17 specific), the cows with 36 proteins (4 specific) and the bulls+steers with 21 proteins including two specific for this category (**Table S2**). The number of proteins retrieved from the 28 experiments varied from 2 to 40 (**Table S1**), with an average of 13 ± 8 and a coefficient of variation of 63%. This is a well-known issue in proteomics especially in analyzing muscle tissues because they are dominated by

a few major protein groups related to the contractile and myofibrillar structure that obscure identification of many important proteins.

Beef tenderness was evaluated by two methods (**Table S1**), the first being sensory evaluation, which used trained panelists for 7 experiments, all conducted at an end-point cooking temperature of 55°C (“rare”, the usual temperature in France (Gagaoua *et al.* 2016)); and the second being WBSF for 27 experiments, of which 15 analyzed steaks cooked at 55°C and 12 analyzed steaks cooked at “well done” temperatures ranging from 70 to 75°C (3 at 70°C, 2 at 70.5°C, 6 at 71°C and 1 at 75°C). Six studies evaluated tenderness using both methods but at an end-point cooking temperature of 55°C. The specific WBSF instruments used, the method of the preparation, and settings were slightly variable or not fully described, consistent with the review by Holman *et al.* (2016). Similarly, ageing periods (time) varied with study and some were conducted at more than one ageing period. Overall, steaks were aged at 14 days for 17 experiments (60.71%), followed by 7 and 21 days (5 times each), then 3 days for 3 experiments and finally 4 experiments shared ageing periods of 2 and 30 days.

2.5. Database analysis: mining of the retrieved putative protein biomarkers

The 124 putative protein biomarkers of beef tenderness were mined using different service bioinformatics tools and online software.

2.5.1. ID conversion

Considering the limitation of the Gene Ontology (GO) annotation in bovine databases, the gene and protein identifiers were converted on Uniprot Retrieve/ID Mapping (<https://www.uniprot.org/role/dlists>) to satisfy the GO analysis input format. The Gene Symbol, Ensembl ID and UniProt KB AC/ID were then converted to the orthologous human EntrezGeneID. Both bovine and human UniprotIDs were therefore indexed in the database.

2.5.2. Categorization of the proteins into biological pathways

A functional annotation of the 124 proteins into the main biological pathways (**Table 1**) was performed first using the information provided by UniProtKB (<https://www.uniprot.org/>) for each protein and confirmed by PANTHER (Protein ANalysis THrough Evolutionary Relationships) classification system based on the human UniProtIDs of the proteins. PANTHER allows the browsing of a manually curated database by functions. The accuracy of protein function prediction was estimated using Hidden Markov Models that were constructed for each functional protein group. A manual annotation process was performed to allocate the 124

proteins to 6 main biological pathways (**Table 1** and **Figure 2**): (i) muscle contraction, structure and associated proteins (n=35); (ii) energy metabolism (n=29); (iii) heat shock proteins, HSPs (n=11); (iv) oxidative stress proteins (n=11); (v) proteolysis (n=2) and (vi) other proteins including regulation of cellular processes, binding, apoptosis and transport (n=36). These are the major pathways that characterize beef tenderization so far described (Ouali *et al.* 2013; Picard & Gagaoua 2017, 2020a) and they are similar to those involved in beef color (Gagaoua *et al.* 2020b). Their impacts differ; for example, the “energy metabolism” pathway largely dominates beef color determination, followed by “heat stress chaperones” and “muscle structure” proteins pathways, which have similar impacts.

2.5.3. Identification of top proteins common to beef tenderness

From the list of 124 putative protein biomarkers, a cut-off of two or more datasets (≥ 2) was applied to identify common proteins across studies regardless of the animal category, leading to a panel of 64 proteins that were reported in at least two independent proteomic experiments (**Figure 2**). These proteins were ranked by the number of times they were identified from the highest to the lowest (**Table 1**) in each of the five biological pathways to which they belong (**Figure 2C**). Sixty proteins were identified only once among the 28 experiments (**Table 1** and **Figure 2A**). Further cut-offs were applied to rank the protein biomarkers and the results of this analysis are shown in **Figure 2A**, illustrating the 33 robust protein biomarkers that were identified ≥ 4 times and their rank order distribution (graph in the insert of **Figure 2A**).

2.5.4. Protein–Protein Interactions (PPI)

Proteins are known to rarely act alone, thus the study of protein networks are essential for a wide range of cellular processes and form a network of great complexity. STRING database ver. 11 at <https://string-db.org/> was used to describe the Protein–Protein Interactions among the 64 proteins with cut-off ≥ 2 (**Figure 3**). The construction default settings required as a minimum interaction score confidence of 0.6 and 4 criteria for linkage (co-occurrence, experimental evidences, existing databases and text mining) were used. Due to the limitation of the GO annotation of genes in bovine, we used human UniprotIDs.

In line with our expectations, the network in **Figure 3** clearly confirms the interconnectedness of the biological pathways underlying beef tenderization, with the pivotal role of structural and contractile proteins, as a consequence of their breakdown during proteolysis (Lana & Zolla 2016). The next most dominant is the energy metabolism pathway, containing enzymes from the glycolytic pathway (11 proteins) and the aerobic pathway (7

proteins) including CKM (Creatine kinase M-type, identified 11 times). A major consequence of the intense early *post-mortem* increase in the enzymes associated with the glycolytic and Krebs cycles is the accumulation of several waste metabolites including ROS (Reactive Oxygen Species), explaining the high number of interactions (37 of the 47) with oxidative stress and HSP proteins (**Figure 3** and sub-network of **Figure S1**), which cope with the harmful effects of ROS. Accordingly and in agreement with the important role of apoptosis in *post-mortem* muscle (Ouali *et al.* 2006; Ouali *et al.* 2013), the other pathways included 5 interactions with apoptotic proteins (PARK7↔TP53, GSTP1↔TP53, SOD1↔TP53, SOD1↔LGALS1 and SOD1↔VDAC2) and 5 interactions shared by muscle structure (GSTP1↔MYL1 and GSTP1↔MYL6B) and transport proteins (GSTP1, PRDX6 and SOD1 with ALB).

2.5.5. Pathway and process enrichment analysis

The 64 proteins were further used to perform a pathway and process enrichment analysis (**Figure 4**) and identify significant hub modules created by these proteins using the intuitive web tool Metascape® (<https://metascape.org/>) based on Kyoto Encyclopedia of Genes and Genomes (KEGG) pathways, GO Biological Processes, and Reactome gene sets (**Table 2** and **Figure S2**). The tool uses the hypergeometric test and Benjamini–Hochberg *p*-value correction algorithm to display the first 20 statistically significant enriched ontology terms (Zhou *et al.* 2019). In this study, the terms with a *P*-value <0.05, a minimum count of 3, and an enrichment factor >1.5 (ratio between the observed counts and the counts expected by chance) were considered. Representative terms with a similarity score >0.3 were clustered together based on their membership similarities and visualized in network layouts (**Figure 4A,B**).

2.5.6. Gene Ontology pathway enrichment and clustering

The GO terms aiming to investigate the potential functions and molecular mechanisms were evaluated for 3 datasets; the entire 124 proteins (**Table S3**), the 64 proteins (cut-off ≥ 2 , **Table S4**) and the 33 robust list of protein biomarkers (cut-off ≥ 4 , **Table S5**) using the web-based ProteINSIDE tool (<http://www.proteinside.org/>). Using this tool, a list of the Top40 GO enrichment terms (*P*-value, Benjamini–Hochberg <0.05) were generated against human orthologs to take advantage of the most complete annotation available. The ProteINSIDE tool relies mainly on GO enrichment tests among the Biological Process (BP), Molecular Function (MF) and Cellular Component (CC) categories.

As an additional process, Metascape® was utilized to distribute the 64 proteins among the animal categories, based on Circos plots which display overlap and functional connections

between the genes, hence allowing the creation and linking of different modules based on the enriched ontology term (**Figure 5A**). The known and potential targets based on the Top20 enriched terms generated by the pathway and process enrichment analyses from **Figure 4** and across animal categories were compared and displayed by means of hierarchical heatmap clustering (**Figure 5B**). This GO analysis suggests that “muscle contraction”, “ATP metabolic process”, “muscle structure development”, “leucocyte activation involved in immune response” and “oxidative stress” are associated with beef tenderness determination, regardless of the animal category (**Figure 5B** and **Table 2**).

2.5.7. Quest for quantitative trait loci of beef tenderness

The volume of data available regarding the effect of specific genetic markers on beef quality traits of several breeds and animal types has grown significantly over the past couple decades (Allan & Smith 2008; Leal-Gutiérrez *et al.* 2020). For most production traits studied, including sensory and technological beef qualities, normal phenotypic variation is primarily a result of the overall effect of DNA sequence variation on chromosomal regions known as quantitative trait loci (QTL) and their interaction with environmental variables. To further our knowledge about the possible role of the shortlisted proteinic markers in this integromics as potential QTL, the ProteQTL tool included in ProteINSIDE (<http://www.proteinside.org/>) was used for fast search of beef tenderness QTL among the list of 64 putative biomarkers. ProteQTL interrogates a public library of published QTL in Animal QTL Database (<https://www.animalgenome.org/QTLdb>) that contains cattle QTL and association data curated from published scientific articles. As a result, 18 QTLs were identified for tenderness score (n=4: PYGM, VDAC2, TNNT3 and GSTP1) and shear force (n=15: PYGM, ALDH1A1, CA3, EEF1A2, TNNC1, ATP5F1B, HSPA9, PGM1, LDHA, HSPA8, MYL3, MYL6B, CSRP3, MYL2 and UQCRC1) at different chromosomes (Chr) (**Table 3**). PYGM on Chr.29 was common to the two beef tenderness traits (**Table 3**). Overall, eleven chromosomes grouped the 18 proteins (genes) with 10 in three chromosomes that are: Chr.29 contains 5 genes (GSTP1, TNNT3, PYGM, LDHA and CSRP3), Chr.22 contains 3 genes (TNNC1, MYL3 and UQCRC1) and Chr.5 contains ATP5F1B and MYL6B. Further, among the major QTL, 6 proteins were from “muscle contraction, structure” pathway, followed by 5 from “energy metabolism” and all with shear force and 2 “heat shock proteins” involved in the cellular response to unfolded proteins (**Table 3**). In **Table S6**, the QTLs identified for a further twenty meat and carcass quality traits of cattle are given using the shortlisted 64 proteins. Similar to tenderness traits, 16 proteins identified as QTL were from “muscle contraction, structure” pathway, followed by 14

proteins from “energy metabolism”, 8 were “heat shock proteins”, 5 were “oxidative stress proteins” and 6 proteins belong to the other pathways “regulation of cellular processes, binding, apoptosis and transport”.

2.5.8. Gender: Overlap and distribution of the proteins with cut-off ≥ 2

The comparison of the different protein lists from the 64 proteins with cut-off ≥ 2 among animal categories: bulls (n=57), steers (n=43), cows (n=33), heifers (n=23) and bulls + steers (n=19), was performed using Venn diagrams (<http://bioinformatics.psb.ugent.be/webtools/Venn/>); while the intersection was visualized by an Upset plot (**Figure 6**) generated by Intervene (<https://intervene.shinyapps.io/intervene/>). Upset plots are a more intuitive and superior to Venn diagrams for visualizing intersecting sets. Proteins were ordered and shown with their corresponding colors following their corresponding biological pathway. From this Upset, we can see that 3 proteins, ACTA1, MYH7 and CKM, were common across all datasets and animal categories (**Figure 6**). To these, we add HSPA1A and TNNC1 found common to the four commercially available animal categories. There was a degree of overlap in proteins between animal categories being 38, 30, 23 and 19 between steers and bulls, cows and bulls, cows and steers and heifers and bulls, respectively.

2.5.9. Theoretical proteome analysis of the proteins with cut-off ≥ 2

Knowledge of the behavior and physical properties of proteins is essential to understand fundamental cellular processes, and the corresponding biological functions. Certain proteomic studies involve the exploration of the intrinsic relationships between physical properties and biological functions of proteins. Examples are the relationship between isoelectric point (pI) and subcellular localization (Schwartz *et al.* 2001), between protein stability and biological processes (Doherty *et al.* 2009), the distribution of pI in PPI networks (Chasapis & Konstantinoudis 2020) or contribution of protein charge and mass to the spatio-temporal dynamics of PPI (Xu *et al.* 2013). To consider such aspects in the shortlisted protein biomarkers, the relationship between theoretical pI and molecular weights (Mw) (**Figure 7**) was computed using “Compute pI/Mw tool” at the ExPASy server (https://web.expasy.org/compute_pi/) for the entire proteins based on bovine UniprotIDs. Although the number of proteins is small, the distribution visually illustrates the overlap of the main biological pathways identified, especially for “energy metabolism” and “muscle contraction, structure” pathways. In addition, the plot illustrates the bimodality pattern of pI distribution (marked by two horizontal brackets in **Figure 7**), a common feature described in different proteomes (Wu *et al.* 2006), with low fractions of

proteins with pI s close to 7.4. This multimodal character of pI distribution is likely associated with the need for different pI values depending on subcellular localization (Schwartz *et al.* 2001). This tendency was also illustrated despite our small dataset where the proteins from the “energy metabolism” pathway have a pI in the range of 6.0 to 9.0, apart from the 3 proteins from the oxidative phosphorylation pathway (ATP5F1B, UQCRC1 and NDUFS1, **Figure 8**) which have a $pI < 5.5$. Similarly, most proteins belonging to the “muscle contraction, structure” pathway (82%) have a pI below 6.0 and only four proteins, with different functions, had a basic pI between 9.0 and 9.5. From the scatter plot, we can also see that proteins belonging to the “oxidative stress” pathway are all small with low Mw and also have a narrow range of pI [5.86; 7.30] (**Figure 7**).

3. Discussion

The current integromics meta-analysis aggregated data from proteomics-based experiments with the aim of identifying robust biomarkers of beef tenderness. To the best of our knowledge, this is the first meta-analysis that constitutes a list of 124 proteins from 28 proteomics datasets as DAP or correlated with tenderness traits of the *Tragassimus* muscle. As noted by Picard and Gagaoua (2017), the extraction medium used to solubilize proteins from the tissue often fails to solubilize extracellular matrix components, so it is not surprising that various types of collagen are not generally reported in these studies, although variations in collagen content are known to bear some relation to variations in meat toughness. Indeed, one of the studies used in this integromics (D'Alessandro *et al.* 2012b) shows a strong negative correlation between the amount of soluble collagen and the toughness of the cooked beef, but does not report any of the collagens as a marker of tenderness. Additionally, it is known that the covalent cross-linking of collagens has a relation to cooked beef toughness, mostly at end-point cooking temperatures below 60°C (Gagaoua *et al.* 2020c; Listrat *et al.* 2020), but the difficulty of solubilizing well cross-linked collagen for proteomic studies is immense. Finally, it should be noted that peak shear force values from WBSF tests on beef cooked to 70°C and above do not reflect the contribution of connective tissues to cooked meat toughness (Purslow 2018), and so again it is not surprising that it is myofibrillar and sarcoplasmic proteins that are primarily identified as markers of tenderness in studies using WBSF as the objective criterion of tenderness/toughness. The different analyses performed above evidenced that key pathways and proteins were identified very often based on the inclusion criteria of cut-off ≥ 4 from at least four different datasets. Such screening has allowed proposing a robust panel of the top 33 proteins (**Figure 2A**) that belong to 5 interconnected biological pathways. Of this panel, 12 proteins were

from muscle contraction and structure, 9 were from energy metabolism, 8 were HSPs, 3 were oxidative stress proteins and one protein belongs to the fifth pathway grouping proteins involved in the regulation of cellular processes, binding, apoptosis and transport. Worthy to note, several of these proteins are multifunctional and some are importantly involved in apoptosis.

Generally speaking, the difference in abundance of any given protein between tough and tender samples of *longissimus* muscle can result from one of two causes, and the interaction between them. The first cause is that a different amount of a protein is synthesized in one animal *versus* another, due to breed differences or environmental factors. The second cause is that variations in metabolism, especially *post-mortem* metabolism, result in a degradation or disappearance of that protein. Thus, proteolysis of intact proteins decreases their relative abundance (and increases the abundance of smaller protein fragments/peptides). These two causes interact; the relative abundance of a given (intact) protein is a balance between synthesis and degradation. The biochemical roles and the mechanisms by which this panel of 33 proteins are expected to underlie beef tenderness determination are discussed below.

3.1. Biomarkers from the muscle contraction and structure pathway

The prolonged lack of oxygen and nutrients in *post-mortem* muscle inevitably induces apoptosis and muscle cell death (Ouah *et al.* 2013), leading to a loss in integrity of the Z-disc and gradual breakdown of the muscle protein structures by certain proteolytic systems (Kemp *et al.* 2010) although this is under the regulation of several factors including endogenous muscle inhibitors (Hopkins & Thompson 2002b; Gagaoua *et al.* 2015a). The identification of a high number of muscle myofibrillar and structural proteins (**Table 1** and **Figure 2**) adds further weight to the body of evidence linking the degree of the alteration and weakening of myofibrillar and cytoskeletal proteins to the extent of proteolysis and development of ultimate meat tenderness (Hopkins & Geesink 2009; Lana & Zolla 2016). The GO process enrichment analyses (**Figure 4**) confirmed the paramount role of this pathway on beef tenderization, forming a separate but linked sub-network composed of “muscle contraction” and “muscle structure development” regardless of animal category (**Figure 5B** and **Table 2**).

The 35 proteins from which 12 were shortlisted as robust (**Figure 2A** and **Table 1**) belong to different regions of the sarcomere with a high number from the Z-disc (**Figure 9**). It is relevant to note that calpains tend to be located at Z-disc region (Kumamoto *et al.* 1992). In addition, earlier studies reported that Z-disc degradation is a major factor contributing to *post-mortem* tenderization (Taylor *et al.* 1995; Hopkins & Thompson 2002a), evidencing that three major

cytoskeletal structures are degraded when meat is considered tender: Z- to Z-disc attachments by intermediate filaments (principally desmin), Z- and M-line attachments to the sarcolemma by costameric proteins (of which only one protein, vinculin, was identified in this integromics) and the elastic filament protein titin, yet to be identified as a DAP for beef tenderness but already reported by proteomics to impact beef color (Gagaoua *et al.* 2018a; Hughes *et al.* 2019). Indeed, the structural changes in the muscle seem to influence not only meat tenderness, but also color traits (Gagaoua *et al.* 2020b). It should be emphasized that the rate of pH decline plays a role in tenderness development and the proteolysis of the Z-disc has been postulated to be related to the pH of the muscle. Overall, in terms of number of proteins identified in this study with cut-off of ≥ 4 , the majority of proteins were from thick (myosins and their regulators) and thin filaments (all components of the troponin complex (n=4) and actin) followed by Z-disc components that grouped ACTA1 (actin, identified 18 times) together with FALN and CAPZB.

3.1.1. Actin (ACTA1): the most frequently identified biomarker

Actin is the second most abundant myofibrillar protein of muscle. In our database, actin was found to be predominantly a positive biomarker of beef tenderness (**Table 1**). The role of cytoskeleton in apoptosis is well known and actin has been considered an important hallmark (Atencia *et al.* 2000). Actin has been described as the first protein targeted by executor caspases (Kemp *et al.* 2010; Ouali *et al.* 2013) leading to a progressive upward trend of the appearance of the major 30–32 kDa fragment, along with other lower molecular weight fragments, in *post-mortem* tissue (Morzel *et al.* 2003; Leville *et al.* 2009; Lana & Zolla 2016). The 30kDa fragment has long been described as a marker for meat tenderization and is generally considered to be a breakdown product of troponin-T, which is associated with the actin filament and is discussed in section 3.1.3. The observation of this 30kDa actin fragment is also in line with earlier *post-mortem* proteome analysis on pig (Lametsch *et al.* 2004) and other species including fish (Tulli *et al.* 2015). Breakdown of transverse cytoskeletal actin filaments may lead to the detachment of sarcolemma from the basal lamina and the extracellular matrix network. On another hand and in line with the harmful conditions accompanying the lack of oxygen in the *post-mortem* period, oxidative modifications on myofibrillar proteins can occur, hence increasing their degradation via calpains and caspase-3 (Smuder *et al.* 2010). We can therefore hypothesize that ACTA1 has a specific and sensitive response to the changes occurring in *post-mortem* muscle even under limited proteolysis, which according to Huff-Lonergan *et al.* (2010) influences beef tenderness. This would explain the large representation of myofibril biomarkers found in the present integromics, further supported by the high prevalence of myosin biomarkers (*Cf.* section 3.1.2).

3.1.2. Myosin proteins: *MYBPH* is negative across genders and *MYL1* positive for steers/cows and negative and positive for bulls

As stated above, the loosening of the myofibrillar structure occurring during ageing of beef is probably the main, and most critical, component of tenderness development. Therefore, it is interesting to observe that different amounts of the intact forms of all 9 myosin proteins have been shortlisted as biomarkers of beef tenderness with MYH1 (Myosin-1) and MYL1 (Myosin light chain 1/3) ranking in the Top10 (**Figure 2A** and **Table 1**). From fetus to slaughter, skeletal muscle fibers in cattle in relation to different beef qualities have been extensively investigated ((Warner *et al.* 2010; Picard & Gagaoua 2020b). One molecule of myosin contains 2 heavy and 4 light chains. These proteins are responsible for contraction velocity and power and they constitute the main proteins of the thick filaments (**Figure 9**). Myosin interacts with actin through the actin/myosin complex and the myosin light chain (MYL), and if myosin, or the acto-myosin bond, is weakened during the *post-mortem* period, meat texture is affected (Taylor *et al.* 1995; Huff-Lonergan *et al.* 2010). Identification of MYH1, as an important biomarker for tenderness, agrees with the theory stating that muscles with high proportions of fast fibers type-II are more susceptible to early *post-mortem* proteolytic degradation (Ouali 1990). Muscles that contain more proportions of type-II fibers are more susceptible to rapid *post-mortem* glycolysis (Ruusunen & Puolanne 2004), which contributes to more tender meat (Picard & Gagaoua 2020b), although these muscles can also be susceptible to heat-toughening (Kim *et al.* 2014).

This integrative analysis revealed MYL1 to be a robust positive biomarker for steers and cows and, with different directions depending on the breed, for bulls (**Table 1**). Myosin light chains are located near the heads of the MYH and the breakdown of the latter may be at the origin of the appearance of the former. Five of them were identified in at least two experiments: MYL1, MYL6B, MYL2, MYL3, and MYL6A, from which the genes of the last three are known QTLs for tenderness (**Table 3**). MYL1 was identified at Chr.2 as QTL for intermuscular fat percentage as well as for MYL6A at Chr.25 for fat thickness at the 12th rib (**Table S6**). We postulate that the identification of several MYL suggests that they are indicators of proteolysis, but also their release would be associated to other pathways, especially to apoptosis onset in *post-mortem* muscle. The onset and nearly all steps of apoptosis are controlled by phosphorylation, a ubiquitous post-translational modification process (Mills *et al.* 1998). Specifically, the execution phase of apoptosis, marked by changes in cell morphology including membrane blebbing resulting from caspase-mediated activation of Rho kinase 1 (ROCK1) (Coleman *et al.* 2001) is finely regulated by MYL phosphorylation (Mills *et al.* (1998). After phosphorylation of the

myosin regulatory light chain (Mato *et al.* 2019) by various protein kinases and phosphatases, the attachment between the thick filaments and myosin heads is weakened, facilitating the degradation of myosins and associated proteins. Hence, phosphorylation processes are likely to contribute to proteolytic processes in the degradation of large molecules, and thus to the meat tenderization process (Rodrigues *et al.* 2017). Finally, as MYL is also susceptible to proteolysis by μ -calpain (Lametsch *et al.* 2004), this reaction may have, in addition, a direct effect on the formation or integrity of the actin/myosin complex.

Among the other proteins composing the thick filaments, MYBPH was identified from 6 of the studies included in this meta-analysis as a robust and negative biomarker of beef tenderness, regardless of the gender (**Table 1**). MYBPH is approximately 53kDa in size (**Figure 7**), and well known for its significant effects on length, thickness, and lateral alignment of myosin filaments (Gilbert *et al.* 1999). It is a QTL at Chr.16 for lean meat yield (**Table S6**), in line with its relationship with conformation score, ribeye and carcass weights (Gagaoua *et al.* 2017a). MYBPH may be associated with tenderness in two complementary ways. Firstly, MYBPH regulates negatively the actin/myosin complex through the inhibition of phosphorylation of regulatory light chains through its interaction with the activator ROCK1 (Hosono *et al.* 2012). Secondly, MYBPH plays a pivotal role in muscularity development and hypertrophy (Mouton *et al.* 2016), explaining the negative association with tenderness, as muscle hypertrophy is known to be sometimes associated with tough meat although this can be muscle-dependent (Warner *et al.* 2010). In agreement with this, a proteomics analysis of *Semiteminosus* muscle from Belgian Blue breed showed higher abundance of proteins of the fast glycolytic type in homozygous double muscled cattle compared to their controls, and among the DAP, MYBPH was a marker of muscle hypertrophy (Boileau *et al.* 2005).

3.1.3. The troponin complex, especially the subunit TNNT3, as good biomarkers of tenderness

The subunits of troponin, TNN-T (tropomyosin-binding troponin T), -I (inhibitory troponin I, which inhibits actomyosin ATPase) and -C (Ca^{2+} -binding troponin C), were all identified as biomarkers of beef tenderness (**Table 1** and **Figure 2A**). Fast TNNT3 was identified 10 times, followed by slow TNNT1 (5 times) and by slow TNNC1 and fast TNNI1, both 4 times. TNNT3 and TNNC1 were further identified as QTLs of tenderness at Chr.29 and Chr.22, respectively (**Table 3**). TNNC1 was also a QTL on Chr.22 for abnormal odor intensity and on Chr.18, TNNT1 (found for bulls and steers only) was a QTL for meat color L^* (**Table S6**). Troponin-T plays a structural role in the myofibril by binding the two subunits C and I to tropomyosin and hence to the thin filaments. TPM3 (Tropomyosin alpha-3 chain) was found as a biomarker for

tenderness in 3 experiments (**Table 1**). The current integromics confirms that tenderization acts on all of the troponin subunits and it is conceivable to note troponin T as a major marker of variability in beef tenderness. It should be noted, that among the myofibrillar proteins TNNT was evidenced by several studies to be degraded by calpains (Huff-Lonergan *et al.* 1996; Lametsch *et al.* 2004) and as markers of ongoing proteolysis in meat samples (for review: (Hopkins & Thompson 2002b, a; Huff-Lonergan *et al.* 2010)). For example, in *post-mortem* muscle, a 30–32 kDa polypeptide degradation fragment appears even after 1 day of refrigeration in fast glycolysing muscles (O'Halloran *et al.* 1997) and has been attributed to TNNT (Ho *et al.* 1994) and was proposed to be associated with to beef tenderness development (Lonergan *et al.* 2001; Hopkins & Thompson 2002b). However, it is important to note that the content of the 30–32 kDa fragments was previously considered to originate from TNNT only, but other protein fragments, such as actin described above (*Cf.* sub-section 3.1.3 (Ouali *et al.* 2013)), and many other protein fragments, may migrate at the same position. For example, this is illustrated by the horizontal yellow line drawn in **Figure 7** showing that at least 8 proteins from this integromics (cut-off ≥ 2) reside in same position. Personal observations confirmed where multiple 30–32 kDa fragments were sequenced, and troponin and actin were identified as well as 10 other proteins with different gene names in this position (Gallaoua, unpublished data).

3.1.4. FHL1 and CAPZB are interesting proteins from the Z-disc

The Four and a half LIM domains 1 (FHL1) facilitates a complex association of signaling proteins with the actin cytoskeleton. F-actin-capping protein subunit- β (CAPZB) caps the growing end of F-actin and modulates the cytoskeleton actin filaments to the Z-disc. Variations in the abundance of both were identified as biomarkers in 5 and 4 experiments, respectively (**Table 1**). The proteolysis of FHL1 is related to the release of α -actinin (ACTN3: identified as a negative biomarker in two studies, **Table 1**) from myofibrils and contributes to the weakening of the Z-disc during meat tenderization (Morzel *et al.* 2004). Like FHL1, CAPZB also interacts with ACTN3 (Papa *et al.* 1999). In fact, the location of a μ -calpain binding site in the C-terminal region of ACTN3 locates the protease in the vicinity of titin (Ohtsuka *et al.* 1997), thus explaining the role they may play in beef tenderization. CAPZB is a structural protein that have important role in the control of actin polymerization and was also reported to play a role in muscle biochemistry. Therefore, changes in its abundance *post-mortem* could play important role on tenderness (Lametsch *et al.* 2003). FHL1 may also interact with other biological pathways such as apoptosis and energy metabolism, as a response to both hypoxia and oxidative stress (Shathasivam *et al.* 2010).

3.2. Biomarkers from the energy metabolism pathway

Energy metabolism has been identified in this meta-analysis as the second major pathway impacting beef tenderness (**Figure 1** and **Figure 4**). The anoxia situation caused by the sudden loss of blood flow results in an early *post-mortem* shift in the energy metabolism toward the glycolytic pathway (11 proteins: **Figure 8A**) and an increase in aerobic and oxidative pathways (**Figure 8B,C**). Recent reports suggest that this switch may be related to protein phosphorylation (Ouali *et al.* 2013; Mato *et al.* 2019), which would indirectly affect the extent and rate of pH decline and thus development of beef tenderization.

3.2.1. CKM is in the top 5 biomarkers for beef tenderness (whatever the gender, but robustly positive for bulls)

Creatine kinase M-type (CKM) was among the five major biomarkers identified 11 times, and consistently positively associated with tenderness in 5 studies on young bulls (**Table 1** and **Figure 2A**). CKM has also been found on Chr.18 as a QTL for *Longissimus* muscle area and meat color lightness L^* (**Table S6**). CKM, which is the enzyme involved in the initial pathway, under anoxic conditions, used by striated muscles for ATP regeneration by creatine phosphate (Robergs *et al.* 2004) and strives to maintain ATP homeostasis by the re-phosphorylation of ADP to ATP (**Figure 8C**) before the switch to ATP production via glycolysis (Wicks *et al.* 2019). Due to its anoxic state, the cell needs to increase its capacities to provide the energy needed for increased metabolic activities (Ouali *et al.* 2013), such as apoptosis and autophagy (Sierra & Oliván 2013). The role of CKM in tenderness development may be likely specific to mixed fast oxido-glycolytic muscles like *Longissimus*, characterized by high percentages of fast-twitch muscle fibers, which have higher amounts of CKM and phosphocreatine than the oxidative muscle fibers (Ukumura *et al.* 2005). It is further an indicator of stress reactivity and/or muscle damage (Daroit & Brandelli 2008), possibly explaining its frequent identification in bulls, which are more behaviourally reactive than cows (Bourguet *et al.* 2011), although breed is usually the main factor in stress responsiveness. During meat ageing, CKM is progressively degraded by calpains (Purintrapiban *et al.* 2001) and also by cathepsins (Delbarre-Ladrat *et al.* 2004) and becomes inactive. We expect that the rate of its fragmentation, and hence the rate of change of the relative abundance of the intact form, influences the rate of energy depletion and pH decline, explaining the association between CKM and several eating qualities including drip loss, water-holding capacity, pH decline and color (Picard *et al.* 2017; Yang *et al.* 2018; Gagaoua *et al.* 2020b). This role may be supported by the antioxidant properties of creatine, a substrate for CKM (Sestili *et al.* 2011).

3.2.2. Glycolytic enzymes are crucial for meat tenderizing with pivotal role of ENO3 and GAPDH

Among the 9 shortlisted metabolic enzymes identified in at least 4 experiments, seven are glycolytic enzymes (PGM1, ALDOA, TPI1, GAPDH, ENO1, ENO3 and PKM) that are shared between the preparatory (the first 3 proteins) and energy-yielding phases (**Table 1** and **Figure 8**), highlighting the crucial role glycolysis plays in beef tenderness. PGM1, GAPDH and PKM had much higher expression in fast-twitch fibers exhibiting high glycolytic activity (Okumura *et al.* 2005). TPI1, GAPDH and PKM are components and regulators of the function of the K_{ATP} channel macromolecular complex (Dhar-Chowdhury *et al.* 2005). K_{ATP} channels act as metabolic sensors by directly coupling their energy metabolism to cellular excitability in *post-mortem* muscle, serving as a crucial regulatory mechanism in response to the metabolic demand to maintain homeostasis.

Enzymes from the second energy-yielding phase of glycolysis ensure the conversion of triose-phosphate to pyruvate and form lactate to produce 2 ATP and one NADH. Of course, H^+ ion changes dramatically in *post-mortem* muscle as a result of anaerobic glycolysis, making it difficult to imagine that any of the metabolites are useful as tenderness biomarkers. However, ENO3 topped the list of enzymes that were identified 11 times (**Table 1** and **Figure 2A**). ENO1 was next, identified 6 times. ENO3 is predominantly found in striated skeletal muscles, whereas ENO1 is found in the embryonic form of all tissues (Adamus 2010). Both isoforms are cytosolic enzymes that convert 2-phosphoglycerate into phosphoenolpyruvate (**Figure 8A**). The consistent identification of ENO3 points to its central role in *post-mortem* cellular events, ascribed to being a key upregulating enzyme associated with hypoxic conditions and stress (Didiasova *et al.* 2019). For example, ENO3 induces glucose metabolism under hypoxic conditions and has protective functions during hypoxia (Wulff *et al.* 2012). As demonstrated by the PPI network (**Figure 3**), the activity of enolases is associated with other pathways such as HSPs and oxidative stress (Wulff *et al.* 2012; Gagaoua *et al.* 2015b).

Differences in the abundance of glyceraldehyde-3-phosphate dehydrogenase (GAPDH) as a marker of beef tenderness were identified in 8 studies, but only from bulls and steers (**Table 1** and **Figure 2A**). GAPDH catalyzes the reversible conversion of glyceraldehyde-3-phosphate and NAD^+ to 1,3-bisphosphoglycerate and NADH (**Figure 8A**). The specific identification of GAPDH for males' only needs to be verified in future investigations. Gender differences in the protein abundances of some tenderness biomarkers were reported between cows and steers, but GAPDH was not quantified (Picard *et al.* 2019). We can relate this specific identification of

GAPDH to differences in insulin sensitivity or sex hormones between the genders. For example, estrogens effect on skeletal muscle characteristics was described (Sauerwein & Meyer 1989). Estrogens and their receptors regulate energy metabolism pathways, including glucose transport, glycolysis, Krebs cycle, mitochondrial respiratory chain and fatty acid β -oxidation. As mentioned above, the levels of GAPDH are greater in muscle fibers with high glycolytic activity, enhancing the decrease of pH *post-mortem*, possibly influencing tenderness development. Interestingly, GAPDH was described to have a multifunctional role due to its presence in different compartments of the cell, hence playing diverse and adverse cellular functions being involved in pro-apoptotic changes (Tarze *et al.* 2007) or pro-survival changes (Colell *et al.* 2009).

PGM1 and TPI1 were each identified 6 times (**Table 1**). The former reversibly catalyzes the conversion of glucose-1-phosphate (G-1-P) to glucose-6-phosphate (G-6-P) and was a QTL on Chr.3 for tenderness (**Table 3**). PGM1 has been further shortlisted, irrespective of muscle, as a biomarker of beef color (Gagaoua *et al.* 2020b). Its implication in several meat quality traits may be ascribed to two mechanisms. First, the hypoxic status in *post-mortem* muscle increases the activity and abundance of PGM1 (Pelletier *et al.* 2012), which affects the balance between G-1-P and G-6-P, and consequently the rate and extent of pH decline. Second, PGM1 may undergo several posttranslational modifications such as phosphorylation (Anderson *et al.* 2014), which enhances its glycolytic activity during the first hours *post-mortem*. This may result in faster pH decline, which would likely prevent sarcomere shortening. The second enzyme, TPI1, catalyzes the reversible conversion of dihydroxyacetone phosphate to D-glyceraldehyde 3-phosphate (**Figure 8A**), thereby ending the splitting stage in the first preparatory phase of glycolysis (Albery & Knowles 1976). TPI ensures also the immediate equilibration of the triosephosphates produced by aldolase (ALDOA), which is interconnected with both lipid metabolism and pentose phosphate pathway (Orosz *et al.* 2009). Further, changes in the abundance of TPI1 and its phosphorylated isoforms were reported to be associated to the rate of pH decline (Huang *et al.* 2011; Gagaoua *et al.* 2018a), indicating its role in *post-mortem* period, which may explain its importance as a biomarker of tenderness in this meta-analysis for beef and also for pork (Lametsch *et al.* 2003).

The last two enzymes, from the first and second glycolysis phases respectively, were identified in 4 experiments: ALDOA and PKM (**Table 1** and **Figure 8A**). Both were QTLs for other meat and carcass qualities (**Table S6**). ALDOA catalyzes the conversion of fructose 1,6-diphosphate to glyceraldehyde 3-phosphate (**Figure 8A**). In the present meta-analysis, ALDOA

was positively associated with tenderness for bulls and steers in 3 studies and negative for heifers. The gender differences might partly be explained by differences in glycogen content and muscle fiber type composition (Picard & Gagaoua 2020b). Elevated abundance and activity of ALDOA is indicative of increased glycolytic activity at slaughter, or simply of greater proportions of fast-twitch muscle fibers; both are often associated with tenderness (Reiche *et al.* 2019). In co-operation with other metabolic enzymes, ALDOA assists in the creation of cross-links between adjacent actin filaments or in binding troponin to the thin filaments, to enhance energy provision where it is actively needed during contraction, and this binding or cross-linking can affect the distance between myofibrils (Hughes *et al.* 2019), likely partly explaining its association with tenderness. The last enzyme of glycolysis, PKM, was mostly positively associated with tenderness, but for bulls and steers only (**Table 1** and **Figure 6**). PKM catalyzes the dephosphorylation of phosphoenolpyruvate to pyruvate and a higher PKM abundance is likely to reflect a potentially higher production of pyruvate (**Figure 8A**). Accordingly, it was further shortlisted as a beef color biomarker (Gagaoua *et al.* 2020b).

3.2.3. MDH1 is the only enzyme from the Krebs cycle that is a robust biomarker of tenderness

Of the 11 enzymes of oxidative pathway, MDH1 is the only one that was identified 4 times (3 times positive and one time negative) as a biomarker of tenderness (**Table 1**). MDH1 operates in the cytosol and mitochondria, playing a key role in the malate–aspartate shuttle (Birktoft *et al.* 1982). In the last step of the Krebs cycle, it uses the reduction of NAD^+ to NADH to catalyze reversibly the oxidation of malate to oxaloacetate (**Figure 8B**). NADH is required in the electron transport chain to produce ATP. Thus, high abundances of MDH1 may be indicative of increased oxidative phosphorylation capacity of the muscle in response to cellular stress.

3.3. Biomarkers from the heat shock proteins (HSPs) pathway

After the slaughter of an animal, the muscle starts to be converted into meat. The unusual conditions of dwindling nutrients and oxygen, coupled with a drop in temperature, trigger a cell response which calls on several cellular protection mechanisms, including the contradictory tools for cell death or cell survival pathways (Ouali *et al.* 2013). HSPs are produced and many of these proteins operate as chaperones that stabilize and ensure correct folding of newly synthesized proteins or help refold proteins altered by cell stress (Lomiwes *et al.* 2014a; Picard & Gagaoua 2017). The current integromics meta-analysis revealed that 11 HSPs were biomarkers of beef tenderness, 8 of which were identified in at least 4 experiments; the 3 others only once (**Table 1**). Of the 5 HSPs members, we retrieved two subfamilies only: three small

HSPs (HSPB1, HSPB6 and CRYAB) and the large HSP70s sub-family with 4 proteins (HSPA1A, HSPA1B, HSPA8 and HSPA9). YWHAE, identified in 4 studies, is a mediator of signal transduction. It is noticeable to see that no member of the HSP60, HSP90, and HSP100 was identified to be related with beef tenderness, which contrasts to beef color (Gagaoua *et al.* 2020b). From the dataset of the 33 robust protein biomarkers, the GO term “protein folding chaperone” for the molecular function GO:0044183 ranked third, highlighting the importance of this pathway in meat determination (**Table S5**). In the following, we briefly describe the roles that this superfamily of proteins could play in *post-mortem* muscle, although several aspects yet to be understood.

3.3.1. Small HSPs, especially HSPB1, are good biomarkers of tenderness

The role of small HSPs in muscle to meat conversion and meat tenderness or other quality traits has been extensively studied (Lomiwes *et al.* 2014a; Picard & Gagaoua 2017; Gagaoua *et al.* 2020b; Ma & Kim 2020). They are regulators of apoptosis onset (Ouali *et al.* 2006) and affect proteolysis and *post-mortem* muscle structure (Gagaoua *et al.* 2015b; Ma & Kim 2020). Most of them are present at low levels in the muscle until an event, such as increased effort (before slaughter) or adverse physiological conditions (after death) triggers their expression (Sugiyama *et al.* 2000), explaining partly their intensive identification. Among the three sHSPs we identified here, HSPB1 (known as HSP27) was identified 17 times, followed by HSPB6 and CRYAB identified 11 and 8 times respectively (**Table 1** and **Figure 2A**). These proteins were further QTLs for several meat and carcass qualities (**Table S6**).

The consistent identification of this superfamily of proteins is linked to their role in maintaining cellular homeostasis. Their relationships with tenderness were positive and negative, possibly due to other factors such as differences in pre-slaughter stress levels, breed, gender and/or the type of isoform involved, due to posttranslational modifications (Morzel *et al.* 2008; Ouali *et al.* 2013; Mato *et al.* 2019; Picard & Gagaoua 2020a). In skeletal muscle, small HSPs can bind to myofibrils (Lomiwes *et al.* 2014b; Ma & Kim 2020), thereby protecting skeletal muscle through structural protein complexes. In line with this, CRYAB has been found to be associated with microfilaments, microtubules and intermediate filaments cytoskeletal networks (Wettstein *et al.* 2012). In addition, the rapid increase in energy metabolic enzymes that occurs *post-mortem* induces the production of waste metabolites including ROS, which we suggest are also targeted by this superfamily of proteins (**Figure 3** and sub-network of **Figure S1**). More specifically, HSPB1 and HSPB6 have the ability to collaborate to control the redox

status (Mymrikov *et al.* 2011). It is interesting to note that these proteins have been identified to be important for beef color development and stability (Gagaoua *et al.* 2020b).

3.3.2. Large 70 kDa HSPs, especially HSPA1A, are good biomarkers of tenderness

Of the large HSP70 kDa proteins, HSPA1A was identified in 9 studies and its homolog HSPA1B in 6 studies; the former was mostly positively and the latter mostly negatively associated with tenderness (**Table 1**). The two others, HSPA8 and HSPA9, were identified 6 and 5 times respectively, and both being QTLs of tenderness at Chr.15 and Chr.7, respectively (**Table 1** and **Table 3**). These 4 large HSPs were further QTL's for other meat and carcass quality traits (**Table S6**). HSPA1A, HSPA1B and HSPA8 are often suggested to have similar physiological functions as they are induced in response to ischemic and hypoxic conditions and as a response to increased cellular stress caused by ROS (Mayer 2013). Therefore, these HSPs may be involved in various mechanisms. First, they protect against *post-mortem* cellular stress and preserve, or lower its impact on muscle cells proteins. They may also intervene in the *post-mortem* muscle by binding to the structural proteins or by regulating cell signaling pathways (Daugaard *et al.* 2007). These large 70 kDa HSPs consist of two major functional domains, the N-terminal ATPase domain which also provides a phospholipid binding site, and the C-terminal peptide binding domain, which are two properties that allow them interact with several macromolecules. For example, they are able to interact with membrane lipids in a direct manner through the C-terminus end, therefore playing a role in the folding of membrane proteins, hence facilitating polypeptides translocation across membranes (Armijo *et al.* 2014). Further, marked changes occur in the mitochondrial proteome of the *post-mortem Longissimus* muscle compared to other muscles (Zhai *et al.* 2020), and large HSPs may help maintaining the mitochondrial membrane potential and ATP levels, thus participating in energy production machinery (Daugaard *et al.* (2007). Interestingly, the three HSPA1A, HSPA1B and HSPA8 are all grouped in the GO term "ATP metabolic process", GO: 0046034 for the 64 (**Table S4**) and 33 proteins datasets (**Table S5**). HSP70 proteins are further involved in apoptotic pathways by sequestering pro-apoptotic factors such as Bcl-2 (Jiang *et al.* 2011; Picard & Gagaoua 2017), hence impacting the cascade of meat tenderizing process (Ouali *et al.* 2013; Picard *et al.* 2017).

The other large HSP member, HSPA9, is different from the others as it is not heat-inducible. HSPA9 is predominantly localized in mitochondria but also in other cellular compartments such as plasma membrane, cytoplasm and sarcoplasmic reticulum (SR) (Liu *et al.* 2005). HSPA9 is the only large HSP regulated by glucose deprivation, perturbation of glycolysis or Ca²⁺ flux (Mayer 2013), and could be involved in the transfer of Ca²⁺ from SR to mitochondria (Gagaoua

et al. 2015b; Picard & Gagaoua 2017). We suppose that it plays a pivotal role by this mechanism (regulation of energy metabolism and proteolysis pathways) in meat tenderization. More specifically, HSPA9 links the inositol 1,4,5-trisphosphate receptor type 1 (ITPR1: identified one time as a negative biomarker, **Table 1**) of the SR to the mitochondrial voltage-dependent anion channels (VDAC: reported as a positive biomarker in two independent studies, **Table 1**), presumably enhancing Ca^{2+} transport from the SR to the mitochondria (Gagaoua *et al.* 2015b; Gagaoua *et al.* 2015c; Gagaoua *et al.* 2017b; Picard & Gagaoua 2017). Indeed, Ca^{2+} ions contribute to the regulation of the energy metabolic pathways (Carafoli 2002) as they affect the enzymatic speed of several crucial metabolic enzymes (Ouali *et al.* 2013; Picard & Gagaoua 2017). This is consistent with the results of this integromics meta-analysis showing high number of metabolic enzymes as good biomarkers, especially from glycolysis (**Figure 8A**). Calcium concentrations have also been implicated as initiators of apoptosis through some signalling pathways in skeletal muscle (Demaurex & Distelhorst 2003; Ouali *et al.* 2013). Apoptosis is known to affect the integrity of the skeletal muscle through the modification of Ca^{2+} flux during ageing and its consequences on protein proteolysis involving ultra-structural modifications (Pinton *et al.* 2008). This is supported by the important list of biomarkers from the muscle contraction, structure and associated proteins pathways.

3.3.2. *YWHAE a chaperone and mediator of signal transduction identified only in bulls and steers*

YWHAE, also known as 14-3-3 protein epsilon, belongs to a large, highly conserved family and functions as a dimer in diverse biological processes such as signal transduction, protein trafficking, apoptosis and metabolism (Jin *et al.* 1996). It was identified in this meta-analysis as a biomarker of tenderness for males only, and was mostly positive (**Table 1**). It is also a QTL for other quality traits (**Table S6**). Rodrigues *et al.* (2017) proposed that phosphorylation of YWHAE would play a role in the muscle structure integrity and apoptosis and it was reported to bind to phosphorylated myosin light chains, therefore influencing its attachment to myosin (Haydon *et al.* 2002). Again, the current meta-analysis did not include phosphorylation data, and further studies are needed to better understand the role of YWHAE in beef tenderization and its association with meat quality attributes.

3.4. *Biomarkers from the oxidative stress pathway*

The origin of oxidative damage in muscle are the mitochondria, which produce ROS through oxidative phosphorylation, involving different components of the muscle cells and leading to

lipid oxidation, DNA and cell damage, protein oxidation and turnover (Ouali *et al.* 2013; Sierra & Oliván 2013; Domínguez *et al.* 2019). A plethora of cellular antioxidant defense mechanisms, comprising both enzymatic and non-enzymatic scavenger agents, are involved to maintain ROS at harmless levels, hence protecting muscle proteins (Sierra & Oliván 2013; Picard & Gagaoua 2017) or interacting with them (Malheiros *et al.* 2019), thereby playing a role in meat tenderization. This meta-analysis identified 11 proteins from this pathway (**Table 1**), from which five were reported in at least 2 datasets (PARK7, PRDX6, SOD1, MSRA and GSTP1). They are all small proteins with Mw ranging from 15-25 kDa (**Figure 7**). These proteins are often reported and may play a major role in beef tenderness development, due to their ability to scavenge ROS and reduce oxidized proteins. Only 3 of these proteins were ranked in the panel of 33 robust biomarkers at a cut-off ≥ 4 (**Figure 2A**). The most prominent was PARK7 (Protein/nucleic acid deglycase DJ-1), identified in 8 experiments, followed by PRDX6 (Peroxiredoxin-6) and SOD1 (Superoxide dismutase [Cu,Zn]), both of which were identified 5 times (**Table 1**). PARK7 and PRDX6 were further identified as QTLs for other quality traits (**Table S6**).

PARK7, known also as DJ-1, is a secreted protein that is re-localized from the cytosol to mitochondria during oxidative stress (Jun *et al.* 2009), scavenging the mitochondrial H_2O_2 and limiting the fragmentation of the organelle (Thomas *et al.* 2011). PARK7 plays a role in meat tenderization, probably by interacting with proteins of other pathways, particularly energy metabolic enzymes and HSPs (Gagaoua *et al.* 2015b) as evidenced by the sub-network in **Figure S1**. Further, in accordance with the negative association with tenderness (5 negative vs. 3 positive), PARK7 decreases the expression of pro-apoptotic factors and inhibits caspases (Fan *et al.* 2008), thus delaying the apoptotic processes that allow tenderization of the meat. Further studies are needed to understand better the main roles that PARK7 may play during meat ageing.

PRDX6 belongs to the peroxiredoxins ubiquitous family that contains 6 members (Fisher 2017). Two other members, PRDX1 and PRDX2 were identified, each in one experiment in this integrative analysis (**Table 1**). PRDX6 is different from the other members of the PRDX family in that thioredoxin, the co-enzyme for most of the members, does not participate in the catalytic cycle of PRDX6, but rather, glutathione (Fisher 2017). This protein may be involved in meat tenderization following different scenarios. First, as PRDX6 is a bi-functional protein it may have anti-oxidative effects in *post-mortem* muscle through the activation of its PLA2 site (phospholipase A2) during ROS production (Gong *et al.* 2006). Second, this PLA2 group has

the capacity to hydrolyze phosphatidylcholine, a basic phospholipid present on the outer leaflet of the membrane (Manevich *et al.* 2009). One of the hallmarks of apoptosis onset is the inversion of the polarity of the membrane by the externalization of phosphatidylserine from the inner-to-outer part of the cell and the internalization of phosphatidylcholine to the inner part by a flip-flop process (Martin *et al.* 1995; Ouali *et al.* 2013). This process may modify the fluidity of the cell membrane making it more permeable to ions such as Ca^{2+} , thereby increasing the activity of calcium-dependent proteases such as μ -calpain (Gutiérrez & Ownby 2003; Gagaoua *et al.* 2015b). Third, this process may neutralize the protons generated by glycolysis, hence decelerating the rate of pH decline (Sorrell *et al.* 2016). This was supported by a study in which low $\text{pH}_{45\text{min}}$ was associated with high PRDX6 (Gagaoua *et al.* 2015c). PRDX6 might further play a role through its PLA_2 activity *via* the catalysis of the hydrolysis of the acyl group at the sn-2 position of glycerophospholipids, with specific link for phosphatidylcholine to release free fatty acids and a lysophospholipid (Fisher 2017). Further, earlier studies reported that PLA_2 catalyzes the hydrolysis of membrane phospholipids and their oxidation (Domínguez *et al.* 2019) leads to the loss of cell integrity, which is one of the main factors inducing drip loss in meat (Lambert *et al.* 2001). Finally, PRDX6 is correlated with several beef color traits (Gagaoua *et al.* 2020b) and marbling (Gagaoua *et al.* 2020a).

SOD1 is localized in the sarcoplasm and mitochondrial intermembrane space. It is an antioxidant enzyme from a ubiquitous family of metalloenzymes that has similar functions to its counterparts described above. For example, it allows a fast dismutation of $\text{O}_2^{\cdot-}$ to O_2 and H_2O_2 . Also, SOD1 eliminates excess ROS , thus preventing damage caused by free radicals in the cells (Vacek *et al.* 2010). Our integrative meta-analysis revealed that SOD1 is a biomarker for tenderness in bulls, steers and cows (**Figure 6**), and in a negative direction in three studies, which is in line with the findings of Grabez *et al.* (2015) in *Semitendinosus* muscle. However, the association was positive in two studies included in the meta-analysis. The potential reasons behind this inversion of direction are not yet fully understood and further data using accurate methods are needed. It should also be mentioned that SOD1 was observed as a biomarker of color in beef (Gagaoua *et al.* 2020b).

3.5. Biomarkers from other pathways

Thirty-six proteins belong to the regulation of cellular processes, involving binding, apoptosis and transport proteins, with only 10 of them identified in more than two studies (**Table 1** and **Figure 2**). Only one protein, carbonic anhydrase 3 (CA3), was identified 4 times and only for steers and bulls. The other proteins are of interest, but as they do not fulfill our

criteria, they will not be discussed further and the full details are available in the respective papers from which they were retrieved (**Table 1** and **Table S1**) as well as the supplementary data provided on the GO and QTL analyses (**Tables S3-S6**). CA3 was earlier described as a marker of cell detoxification (Ouali *et al.* 2013). The waste metabolites produced by the different pathways described above, especially energy metabolism, may be partly catalyzed by CA3. CA3 is involved in the regulation of the cellular pH in the living cell (Duda *et al.* 2005). For example, it can convert CO₂ to bicarbonate. In the *post-mortem* muscle this could explain, at least in part, the discontinuity of pH decline (Ouali *et al.* 2006; D'Alessandro *et al.* 2012a; Ouali *et al.* 2013; Gagaoua *et al.* 2015c).

4. Conclusions

In our quest for protein biomarkers of beef tenderness over the last fifteen years resulted in the identification of a number of proteins implicated in tenderization that belong to different, but interconnected pathways. This integromics meta-analysis highlighted the degree of their interconnectedness and the relevance (in the order of importance) of muscle contractile and structure proteins, energy metabolism proteins, heat stress proteins and oxidative stress proteins in the determination of beef tenderness. Interestingly most of these pathways and proteins directly or indirectly impinge on apoptosis onset in *post-mortem* muscle. The data gathered by this study demonstrated how protein dynamics across these different metabolic pathways are associated with the development of tenderness early *post-mortem* and during the ageing process. It seems that metabolism of ATP that is a key determinant of the rate and extent of pH decline *post-mortem*, contributes significantly to tenderness development *via* effects on enzyme activity, as well as through its influence on reducing myofilament lattice spacing and myofibril diameter. In this sense, a caveat on the results of the analysis is the potential for protein influence to be distorted by factors such as the chilling rate and the impact on sarcomere shortening. One aspect not explored in this meta-analysis concerns the polymorphisms and post-translational modifications of the proteins we retrieved. A more detailed investigation of the impact of different protein isoforms (proteoforms) is therefore warranted to further this understanding of the transformation of muscle into meat. In fact, in the future proteomics should further focus on the study of proteoforms to decipher further unknowns including the meat matrisome (extracellular matrix (ECM) proteome and ECM-associated proteins) and the meat degradome (global appraisal of the proteases and protease-substrate repertoires). This is easier said than done, owing to the number of operational and technical challenges that arise when investigating proteoforms. Finally, this integromics study revealed the power of data integration, and has led

to the identification of a robust panel of 33 proteins that warrant further exploration and validation as biomarkers of beef tenderness. For beef industry, the expectation is that the shortlisted protein biomarkers will help inform carcass management systems for delivering consistency in beef tenderness while at the same time leading to the development of prediction equations enabling rapid evaluation of beef tenderness potential.

Declaration of competing interest

The authors declared that there is no conflict of interest.

Acknowledgements

Dr. Mohammed Gagaoua is a Marie Skłodowska-Curie Career-Flit Fellow under the number MF20180029. He is grateful to the funding received from the Marie Skłodowska-Curie grant agreement No. 713654 and the support of Meat Technology Ireland (MTI) a co-funded industry/Enterprise Ireland project (TC 2016 002). He further conveys special thanks to Mr. Peter Mooney from Innovation@Dawn at Dawn Meats Group for his great support, and acknowledges Daniel Ekhlas, Teagasc Food Research Centre Ashtown, for his help in drawing the schematic views of the sarcomere and energy metabolic pathways.

References

- Adamus G. (2010) Chapter 76 - Paraneoplastic retinal degeneration. In: *Ocular Disease* (eds. by Levin LA & Albert DM), pp. 599-606. W.B. Saunders, Edinburgh.
- Albery W.J. & Knowles J.R. (1975) Free-energy profile for the reaction catalyzed by triosephosphate isomerase. *Biochemistry* **15**, 327-31.
- Allan M.F. & Smith T.P.L. (2008) Present and future applications of DNA technologies to improve beef production. *Meat Sci* **80**, 79-85.
- Anderson M.J., Lonergan S.M. & Huff-Lonergan E. (2014) Differences in phosphorylation of phosphoglucosylase 1 in beef steaks from the longissimus dorsi with high or low star probe values. *Meat Sci* **96**, 79-84.
- Armijo G., Okerblom J., Cauvi D.M., Lopez V., Schlamadinger D.E., Kim J., Arispe N. & De Maio A. (2014) Interaction of heat shock protein 70 with membranes depends on the lipid environment. *Cell Stress and Chaperones* **19**, 877-86.
- Atencia R., Asumendi A. & García-Sanz M. (2000) Role of cytoskeleton in apoptosis. In: *Vitamins & Hormones* (pp. 267-97. Academic Press.
- Baldassini W.A., Braga C.P., Chardulo L.A., Vasconcelos Silva J.A., 2nd, Malheiros J.M., de Albuquerque L.G., Fernandes T.T. & Padilha Pde M. (2015) Bioanalytical methods for the metalloproteomics study of bovine longissimus thoracis muscle tissue with different grades of meat tenderness in the Nellore breed (*Bos indicus*). *Food Chem* **169**, 65-72.
- Beldarrain L.R., Aldai N., Picard B., Sentandreu E., Navarro J.L. & Sentandreu M.A. (2018) Use of liquid isoelectric focusing (OFFGEL) on the discovery of meat tenderness biomarkers. *Journal of Proteomics* **183**, 25-33.
- Birktoft J.J., Fernley R.T., Bradshaw R.A. & Banaszak L.J. (1982) Amino acid sequence homology among the 2-hydroxy acid dehydrogenases: mitochondrial and cytoplasmic malate dehydrogenases form a homologous system with lactate dehydrogenase. *Proc Natl Acad Sci U S A* **79**, 6166-70.

- Bjarnadottir S.G., Hollung K., Hoy M., Bendixen E., Codrea M.C. & Veiseth-Kent E. (2012) Changes in protein abundance between tender and tough meat from bovine longissimus thoracis muscle assessed by isobaric Tag for Relative and Absolute Quantitation (iTRAQ) and 2-dimensional gel electrophoresis analysis. *J Anim Sci* **90**, 2035-43.
- Boudon S., Ounaissi D., Viala D., Monteils V., Picard B. & Cassar-Malek I. (2020) Label free shotgun proteomics for the identification of protein biomarkers for beef tenderness in muscle and plasma of heifers. *J Proteomics* **217**, 103685.
- Bouley J., Meunier B., Chambon C., De Smet S., Hocquette J.F. & Picard B. (2005) Proteomic analysis of bovine skeletal muscle hypertrophy. *PROTEOMICS* **5**, 490-500.
- Bourguet C., Deiss V., Tannugi C.C. & Terlouw E.M. (2011) Behavioural and physiological reactions of cattle in a commercial abattoir: relationships with organisational aspects of the abattoir and animal characteristics. *Meat Sci* **88**, 158-68.
- Carafoli E. (2002) Calcium signaling: A tale for all seasons. *Proceedings of the National Academy of Sciences* **99**, 1115-22.
- Carvalho M.E., Gasparin G., Poleti M.D., Rosa A.F., Balieiro J.C., Labate C.A., Nassu R.T., Tullio R.R., Regitano L.C., Mourao G.B. & Coutinho L.L. (2014) Heat shock and structural proteins associated with meat tenderness in Nellore beef cattle, a Bos indicus breed. *Meat Sci* **96**, 1318-24.
- Chasapis C.T. & Konstantinoudis G. (2020) Protein isoelectric point distribution in the interactomes across the domains of life. *Biophysical Chemistry* **256**, 106969.
- Colell A., Green D.R. & Ricci J.E. (2009) Novel roles for GAPDH in cell death and carcinogenesis. *Cell Death Differ* **16**, 1573-81.
- Coleman M.L., Sahai E.A., Yeo M., Bosch M., Dewar A. & Olson M.F. (2001) Membrane blebbing during apoptosis results from caspase-mediated activation of ROCK I. *Nat Cell Biol* **3**, 339-45.
- D'Alessandro A., Marrocco C., Rinalducci S., Mirasole C., Failla S. & Zolla L. (2012a) Chianina beef tenderness investigated through integrated Omics. *J Proteomics* **75**, 4381-98.
- D'Alessandro A., Rinalducci S., Marrocco C., Zolla V., Napolitano F. & Zolla L. (2012b) Love me tender: an Omics window on the bovine meat tenderness network. *J Proteomics* **75**, 4360-80.
- Daroit D.J. & Brandelli A. (2008) Implications of skeletal muscle creatine kinase to meat quality. *Journal of Animal and Feed Sciences* **17**, 285-94.
- Daugaard M., Rohde M. & Jaattela M. (2007) The heat shock protein 70 family: Highly homologous proteins with overlapping and distinct functions. *FEBS Lett* **581**, 3702-10.
- Delbarre-Ladrat C., Verrez-Bagnis V., Noël J. & Fleurence J. (2004) Relative contribution of calpain and cathepsins to protein degradation in muscle of sea bass (*Dicentrarchus labrax* L.). *Food Chemistry* **88**, 389-95.
- Demaurex N. & Distelhorst C. (2000) Cell biology. Apoptosis--the calcium connection. *Science* **300**, 65-7.
- Dhar-Chowdhury P., Harel M.J., Han S.Y., Jankowska D., Parachuru L., Morrissey A., Srivastava S., Liu W., Malester B., Yoshida H. & Coetzee W.A. (2005) The Glycolytic Enzymes, Glyceraldehyde-3-phosphate Dehydrogenase, Triose-phosphate Isomerase, and Pyruvate Kinase Are Components of the KATP Channel Macromolecular Complex and Regulate Its Function. *Journal of Biological Chemistry* **280**, 38464-70.
- Didiasova M., Schaefer L. & Wygrecka M. (2019) When Place Matters: Shuttling of Enolase-1 Across Cellular Compartments. *Front Cell Dev Biol* **7**, 61.
- Doherty M.K., Hammond D.E., Clague M.J., Gaskell S.J. & Beynon R.J. (2009) Turnover of the Human Proteome: Determination of Protein Intracellular Stability by Dynamic SILAC. *Journal of Proteome Research* **8**, 104-12.
- Domínguez R., Pateiro M., Gagaoua M., Barba F.J., Zhang W. & Lorenzo J.M. (2019) A Comprehensive Review on Lipid Oxidation in Meat and Meat Products. *Antioxidants* **8**, 429.
- Duda D.M., Tu C., Fisher S.Z., An H., Yoshioka C., Govindasamy L., Laipis P.J., Agbandje-McKenna M., Silverman D.N. & McKenna R. (2005) Human Carbonic Anhydrase III: Structural and Kinetic Study of Catalysis and Proton Transfer. *Biochemistry* **44**, 10046-53.
- Fan J., Ren H., Jia N., Fei E., Zhou T., Jiang P., Wu M. & Wang G. (2008) DJ-1 decreases Bax expression through repressing p53 transcriptional activity. *J Biol Chem* **283**, 4022-30.
- Fisher A.B. (2017) Peroxiredoxin 6 in the repair of peroxidized cell membranes and cell signaling. *Archives of Biochemistry and Biophysics* **617**, 68-83.

- Gagaoua M., Bonnet M., De Koning L. & Picard B. (2018a) Reverse Phase Protein array for the quantification and validation of protein biomarkers of beef qualities: The case of meat color from Charolais breed. *Meat Sci* **145**, 308-19.
- Gagaoua M., Bonnet M., Ellies-Oury M.P., De Koning L. & Picard B. (2018b) Reverse phase protein arrays for the identification/validation of biomarkers of beef texture and their use for early classification of carcasses. *Food Chemistry* **250**, 245-52.
- Gagaoua M., Bonnet M. & Picard B. (2020a) Protein Array-Based Approach to Evaluate Biomarkers of Beef Tenderness and Marbling in Cows: Understanding of the Underlying Mechanisms and Prediction. *Foods* **9**, 1180.
- Gagaoua M., Hafid K., Boudida Y., Becila S., Ouali A., Picard B., Boudjellal A. & Sentandreu M.A. (2015a) Caspases and Thrombin Activity Regulation by Specific Serpin Inhibitors in Bovine Skeletal Muscle. *Appl Biochem Biotechnol* **177**, 279-303.
- Gagaoua M., Hughes J., Terlouw E.M.C., Warner R.D., Purslow P.P., Lorenzo J.M. & Picard B. (2020b) Proteomic biomarkers of beef colour. *Trends in Food Science & Technology* **101**, 234-52.
- Gagaoua M., Listrat A., Andueza D., Gruffat D., Normand J., Mairesse G., Picard B. & Hocquette J.-F. (2020c) What are the drivers of beef sensory quality using meat data of intramuscular connective tissue, fatty acids and muscle fiber characteristics? *Livestock Science* **240**, 104209.
- Gagaoua M., Micol D., Picard B., Terlouw C.E., Moloney A.P., Jun H., Meteau K., Scollan N., Richardson I. & Hocquette J.F. (2016) Inter-laboratory assessment by trained panelists from France and the United Kingdom of beef cooked at two different end-point temperatures. *Meat Sci* **122**, 90-6.
- Gagaoua M., Monteils V., Couvreur S. & Picard B. (2017a) Identification of Biomarkers Associated with the Rearing Practices, Carcass Characteristics, and Beef Quality: An Integrative Approach. *Journal of Agricultural and Food Chemistry* **65**, 8264-78.
- Gagaoua M., Monteils V., Couvreur S. & Picard B. (2019a) Beef Tenderness Prediction by a Combination of Statistical Methods: Chemometrics and Supervised Learning to Manage Integrative Farm-To-Meat Continuum Data. *Foods* **8**, 274.
- Gagaoua M., Picard B. & Monteils V. (2019b) Assessment of cattle inter-individual cluster variability: the potential of continuum data from the farm-to-fork for ultimate beef tenderness management. *J Sci Food Agric* **99**, 4129-41.
- Gagaoua M., Terlouw C., Richardson I., Hocquette J.F. & Picard B. (2019c) The associations between proteomic biomarkers and beef tenderness depend on the end-point cooking temperature, the country origin of the panelists and breed. *Meat Sci* **157**, 107871.
- Gagaoua M., Terlouw E.M., Boudjellal A. & Picard B. (2015b) Coherent correlation networks among protein biomarkers of beef tenderness: What they reveal. *J Proteomics* **128**, 365-74.
- Gagaoua M., Terlouw E.M., Micol D., Boudjellal A., Hocquette J.F. & Picard B. (2015c) Understanding Early Post-Mortem Biochemical Processes Underlying Meat Color and pH Decline in the Longissimus thoracis Muscle of Young Blond d'Aquitaine Bulls Using Protein Biomarkers. *J Agric Food Chem* **63**, 6799-809.
- Gagaoua M., Terlouw E.M.C. & Picard B. (2017b) The study of protein biomarkers to understand the biochemical processes underlying beef color development in young bulls. *Meat Sci* **134**, 18-27.
- Gilbert R., Cohen J.A., Pardo S., Basu A. & Fischman D.A. (1999) Identification of the A-band localization domain of myosin binding proteins C and H (MyBP-C, MyBP-H) in skeletal muscle. *J Cell Sci* **112** (Pt 1), 69-79.
- Gong M.C., Arbogast S., Guo Z., Mathenia J., Su W. & Reid M.B. (2006) Calcium-independent phospholipase A2 modulates cytosolic oxidant activity and contractile function in murine skeletal muscle cells. *Journal of Applied Physiology* **100**, 399-405.
- Grabez V., Kathri M., Phung V., Moe K.M., Slinde E., Skaugen M., Saarem K. & Egelanddal B. (2015) Protein expression and oxygen consumption rate of early postmortem mitochondria relate to meat tenderness. *J Anim Sci* **93**, 1967-79.
- Guillemin N., Bonnet M., Jurie C. & Picard B. (2011) Functional analysis of beef tenderness. *J Proteomics* **75**, 352-65.
- Guillemin N., Meunier B., Jurie C., Cassar-Malek I., Hocquette J.F., Leveziel H. & Picard B. (2009) Validation of a Dot-Blot quantitative technique for large scale analysis of beef tenderness biomarkers. *J Physiol Pharmacol* **60 Suppl 3**, 91-7.

- Gutiérrez J.M.a. & Ownby C.L. (2003) Skeletal muscle degeneration induced by venom phospholipases A2: insights into the mechanisms of local and systemic myotoxicity. *Toxicon* **42**, 915-31.
- Haydon C.E., Watt P.W., Morrice N., Knebel A., Gaestel M. & Cohen P. (2002) Identification of a Phosphorylation Site on Skeletal Muscle Myosin Light Chain Kinase That Becomes Phosphorylated during Muscle Contraction. *Archives of Biochemistry and Biophysics* **397**, 224-31.
- Ho C.Y., Stromer M.H. & Robson R.M. (1994) Identification of the 30 kDa polypeptide in post mortem skeletal muscle as a degradation product of troponin-T. *Biochimie* **76**, 369-75.
- Hollung K., Timperio A.M., Oliván M., Kemp C., Coto-Montes A., Sierra V. & Zolla L. (2014) Systems biology: a new tool for farm animal science. *Curr Protein Pept Sci* **15**, 100-17.
- Hollung K., Veiseth E., Jia X., Faergestad E.M. & Hildrum K.I. (2007) Application of proteomics to understand the molecular mechanisms behind meat quality. *Meat Sci* **77**, 97-104.
- Holman B.W.B., Fowler S.M. & Hopkins D.L. (2016) Are shear force methods adequately reported? *Meat Sci* **119**, 1-6.
- Hopkins D. & Geesink G. (2009) Protein degradation post mortem and tenderisation. *Applied muscle biology and meat science*, 149-73.
- Hopkins D.L. & Thompson J.M. (2002a) The Degradation of Myofibrillar Proteins in Beef and Lamb Using Denaturing Electrophoresis - an Overview. *Journal of Muscle Foods* **13**, 81-102.
- Hopkins D.L. & Thompson J.M. (2002b) Factors contributing to proteolysis and disruption of myofibrillar proteins and the impact on tenderisation in beef and sheep meat. *Australian Journal of Agricultural Research* **53**, 149-66.
- Hosono Y., Usukura J., Yamaguchi T., Yanagisawa K., Suzuki M. & Takahashi T. (2012) MYBPH inhibits NM IIA assembly via direct interaction with NMHC IIA and reduces cell motility. *Biochemical and Biophysical Research Communications* **428**, 173-8.
- Huang H., Larsen M.R., Karlsson A.H., Pomponio L., Costa L.N. & Lametsch R. (2011) Gel-based phosphoproteomics analysis of sarcoplasmic proteins in postmortem porcine muscle with pH decline rate and time differences. *PROTEOMICS* **11**, 4063-76.
- Huff-Lonergan E., Mitsuhashi T., Beekman L.D., Parrish F.C., Jr., Olson D.G. & Robson R.M. (1996) Proteolysis of specific muscle structural proteins by μ -calpain at low pH and temperature is similar to degradation in postmortem bovine muscle. *Journal of Animal Science* **74**, 993-1008.
- Huff-Lonergan E., Zhang W. & Lonergan A.M. (2010) Biochemistry of postmortem muscle - lessons on mechanisms of meat tenderization. *Meat Sci* **86**, 184-95.
- Hughes J., Clarke F., Li Y., Purslow P. & Warner R. (2019) Differences in light scattering between pale and dark beef longissimus thoracis muscles are primarily caused by differences in the myofilament lattice, myofibril and muscle fibre transverse spacings. *Meat Sci* **149**, 96-106.
- Jia X., Veiseth-Kent E., Grove J., Kuziora P., Aass L., Hildrum K.I. & Hollung K. (2009) Peroxiredoxin-6--a potential protein marker for meat tenderness in bovine longissimus thoracis muscle. *J Anim Sci* **87**, 2091-9.
- Jiang B., Liang P., Deng G., Tu Z., Liu M. & Xiao X. (2011) Increased stability of Bcl-2 in HSP70-mediated protection against apoptosis induced by oxidative stress. *Cell Stress Chaperones* **16**, 143-52.
- Jin D.Y., Lyu M.S., Kozak C.A. & Jeang K.T. (1996) Function of 14-3-3 proteins. *Nature* **382**, 308.
- Junn E., Jang W.H., Zhao X., Jeong B.S. & Mouradian M.M. (2009) Mitochondrial localization of DJ-1 leads to enhanced neuroprotection. *J Neurosci Res* **87**, 123-9.
- Kemp C.M., Sensky P.L., Bardsley R.G., Buttery P.J. & Parr T. (2010) Tenderness--an enzymatic view. *Meat Sci* **84**, 248-56.
- Kim N.K., Cho S., Lee S.H., Park H.R., Lee C.S., Cho Y.M., Choy Y.H., Yoon D., Im S.K. & Park E.W. (2008) Proteins in longissimus muscle of Korean native cattle and their relationship to meat quality. *Meat Sci* **80**, 1068-73.
- Kim Y.H.B., Warner R.D. & Rosenfold K. (2014) Influence of high pre-rigor temperature and fast pH fall on muscle proteins and meat quality: a review. *Animal Production Science* **54**, 375-95.
- Kumamoto T., Kleese W.C., Cong J., Goll D.E., Pierce P.R. & Allen R.E. (1992) Localization of the Ca²⁺-dependent proteinases and their inhibitor in normal, fasted, and denervated rat skeletal muscle. *The Anatomical Record* **232**, 60-77.
- Lambert I.H., Nielsen J.H., Andersen H.J. & Ørtenblad N. (2001) Cellular Model for Induction of Drip Loss in Meat. *Journal of Agricultural and Food Chemistry* **49**, 4876-83.

- Lametsch R., Karlsson A., Rosenvold K., Andersen H.J., Roepstorff P. & Bendixen E. (2003) Postmortem proteome changes of porcine muscle related to tenderness. *J Agric Food Chem* **51**, 6992-7.
- Lametsch R., Roepstorff P., Møller H.S. & Bendixen E. (2004) Identification of myofibrillar substrates for μ -calpain. *Meat Sci* **68**, 515-21.
- Lana A. & Zolla L. (2016) Proteolysis in meat tenderization from the point of view of each single protein: A proteomic perspective. *Journal of Proteomics* **147**, 85-97.
- Laville E., Sayd T., Morzel M., Blinet S., Chambon C., Lepetit J., Renand G. & Hocquette J.F. (2009) Proteome changes during meat aging in tough and tender beef suggest the importance of apoptosis and protein solubility for beef aging and tenderization. *J Agric Food Chem* **57**, 10755-64.
- Leal-Gutiérrez J.D., Elzo M.A. & Mateescu R.G. (2020) Identification of eQTLs and sQTLs associated with meat quality in beef. *BMC Genomics* **21**, 104.
- Listrat A., Gagaoua M., Normand J., Gruffat D., Andueza D., Mairesse G., Mourot B.P., Chesneau G., Gobert C. & Picard B. (2020) Contribution of connective tissue components, muscle fibres and marbling to beef tenderness variability in longissimus thoracis, rectus abdominis, semimembranosus and semitendinosus muscles. *J Sci Food Agric* **100**, 2502-11.
- Liu Y., Liu W., Song X.D. & Zuo J. (2005) Effect of GRP75/mhsp70/BP74/mortalin overexpression on intracellular ATP level, mitochondrial membrane potential and ROS accumulation following glucose deprivation in PC12 cells. *Mol Cell Biochem* **278**, 45-51.
- Lomiwes D., Farouk M.M., Wiklund E. & Young O.A. (2014a) Small heat shock proteins and their role in meat tenderness: a review. *Meat Sci* **96**, 26-40.
- Lomiwes D., Hurst S.M., Dobbie P., Frost D.A., Hurst R.D., Young O.A. & Farouk M.M. (2014b) The protection of bovine skeletal myofibrils from proteolytic damage post mortem by small heat shock proteins. *Meat Sci* **97**, 548-57.
- Lonergan S.M., Huff-Lonergan E., Wiegand P.R. & Kriese-Anderson L.A. (2001) Postmortem Proteolysis and Tenderization of Top Loin Steaks from Brangus Cattle. *Journal of Muscle Foods* **12**, 121-36.
- Lopez-Pedrouso M., Franco D., Serrano M.P., Maggolino A., Landete-Castillejos T., De Palo P. & Lorenzo J.M. (2019) A proteomic-based approach for the search of biomarkers in Iberian wild deer (*Cervus elaphus*) as indicators of meat quality. *J Proteomics* **205**, 103422.
- Ma D. & Kim Y.H.B. (2020) Proteolytic changes of myofibrillar and small heat shock proteins in different bovine muscles during aging: Their relevance to tenderness and water-holding capacity. *Meat Sci* **163**, 108090.
- Malheiros J.M., Braga C.P., Grove F.A., Ribeiro F.A., Calkins C.R., Adamec J. & Chardulo L.A.L. (2019) Influence of oxidative damage to proteins on meat tenderness using a proteomics approach. *Meat Sci* **146**, 64-71.
- Manevich Y., Shuvaeva T., Dodia C., Kazi A., Feinstein S.I. & Fisher A.B. (2009) Binding of peroxiredoxin 6 to substrate determines differential phospholipid hydroperoxide peroxidase and phospholipase A(2) activities. *Arch Biochem Biophys* **485**, 139-49.
- Martin S.J., Reutelingsperger C.P., McGahon A.J., Rader J.A., van Schie R.C., LaFace D.M. & Green D.R. (1995) Early redistribution of plasma membrane phosphatidylserine is a general feature of apoptosis regardless of the initiating stimulus: inhibition by overexpression of Bcl-2 and Abl. *J Exp Med* **182**, 1545-56.
- Mato A., Rodríguez-Vázquez R., López-Pedrouso M., Bravo S., Franco D. & Zapata C. (2019) The first evidence of global meat phosphoproteome changes in response to pre-slaughter stress. *BMC Genomics* **20**, 590.
- Mayer M.P. (2013) Hsp70 chaperone dynamics and molecular mechanism. *Trends Biochem Sci* **38**, 507-14.
- Mills J.C., Stone N.L., Erhardt J. & Pittman R.N. (1998) Apoptotic membrane blebbing is regulated by myosin light chain phosphorylation. *J Cell Biol* **140**, 627-36.
- Morzell M., Chambon C., Hamelin M., Sante-Lhoutellier V., Sayd T. & Monin G. (2004) Proteome changes during pork meat ageing following use of two different pre-slaughter handling procedures. *Meat Sci* **67**, 689-96.

- Morzel M., Terlouw C., Chambon C., Micol D. & Picard B. (2008) Muscle proteome and meat eating qualities of Longissimus thoracis of "Blonde d'Aquitaine" young bulls: A central role of HSP27 isoforms. *Meat Sci* **78**, 297-304.
- Mouton J.M., van der Merwe L., Goosen A., Revera M., Brink P.A., Moolman-Smook J.C. & Kinnear C. (2016) MYBPH acts as modifier of cardiac hypertrophy in hypertrophic cardiomyopathy (HCM) patients. *Hum Genet* **135**, 477-83.
- Mymrikov E.V., Seit-Nebi A.S. & Gusev N.B. (2011) Large potentials of small heat shock proteins. *Physiol Rev* **91**, 1123-59.
- O'Halloran G.R., Troy D.J. & Buckley D.J. (1997) The relationship between early post-mortem pH and the tenderisation of beef muscles. *Meat Sci* **45**, 239-51.
- Ohtsuka H., Yajima H., Maruyama K. & Kimura S. (1997) Binding of the N-terminal 63 kDa portion of connectin/titin to α -actinin as revealed by the yeast two-hybrid system. *FEBS Letters* **401**, 65-7.
- Okumura N., Hashida-Okumura A., Kita K., Matsubae M., Matsubara T., Takao T. & Nagai K. (2005) Proteomic analysis of slow- and fast-twitch skeletal muscles. *PROTEOMICS* **5**, 2896-906.
- Orosz F., Oláh J. & Ovádi J. (2009) Triosephosphate isomerase deficiency: New insights into an enigmatic disease. *Biochimica et Biophysica Acta (BBA) - Molecular Basis of Disease* **1792**, 1168-74.
- Ouali A. (1990) Meat Tenderization: Possible Causes and Mechanisms - A Review. *Journal of Muscle Foods* **1**, 129-65.
- Ouali A., Gagaoua M., Boudida Y., Becila S., Boudjellal A., Herrera-Mendez C.H. & Sentandreu M.A. (2013) Biomarkers of meat tenderness: present knowledge and perspectives in regards to our current understanding of the mechanisms involved. *Meat Sci* **95**, 854-70.
- Ouali A., Herrera-Mendez C.H., Coulis G., Becila S., Boudjellal A., Aubry L. & Sentandreu M.A. (2006) Revisiting the conversion of muscle into meat and the underlying mechanisms. *Meat Sci* **74**, 44-58.
- Papa I., Astier C., Kwiatek O., Raynaud F., Bonnaud C., Lebart M.-C., Roustan C. & Benyamin Y. (1999) Alpha actinin-CapZ, an anchoring complex for thin filaments in Z-line. *Journal of Muscle Research & Cell Motility* **20**, 187-97.
- Pelletier J., Bellot G., Gounon P., Lacas-Gervais S., Pouyssegur J. & Mazure N.M. (2012) Glycogen Synthesis is Induced in Hypoxia by the Hypoxia-Inducible Factor and Promotes Cancer Cell Survival. *Front Oncol* **2**, 18.
- Picard B. & Gagaoua M. (2017) Chapter 11 - Proteomic Investigations of Beef Tenderness. In: *Proteomics in Food Science from farm to fork* (ed. by Colgrave ML), pp. 177-97. Academic Press, London.
- Picard B. & Gagaoua M. (2020) Meta-proteomics for the discovery of protein biomarkers of beef tenderness: An overview of integrated studies. *Food Res Int* **127**, 108739.
- Picard B. & Gagaoua M. (2020) Muscle Fiber Properties in Cattle and Their Relationships with Meat Qualities: An Overview. *J Agric Food Chem* **68**, 6021-39.
- Picard B., Gagaoua M., Al-Jammas M., De Koning L., Valais A. & Bonnet M. (2018) Beef tenderness and intramuscular fat proteomic biomarkers: muscle type effect. *PeerJ* **6**, e4891.
- Picard B., Gagaoua M., Al-Jammas M. & Bonnet M. (2019) Beef tenderness and intramuscular fat proteomic biomarkers: Effect of gender and rearing practices. *J Proteomics* **200**, 1-10.
- Picard B., Gagaoua M. & Hollung K. (2017) Chapter 12 - Gene and Protein Expression as a Tool to Explain/Predict Meat (and Fish) Quality In: *New Aspects of Meat Quality: From Genes to Ethics* (ed. by Purslow P), pp. 321-54. Woodhead Publishing, United Kingdom.
- Picard B., Gagaoua M., Micol D., Cassar-Malek I., Hocquette J.F. & Terlouw C.E. (2014) Inverse relationships between biomarkers and beef tenderness according to contractile and metabolic properties of the muscle. *J Agric Food Chem* **62**, 9808-18.
- Pinton P., Giorgi C., Siviero R., Zecchini E. & Rizzuto R. (2008) Calcium and apoptosis: ER-mitochondria Ca²⁺ transfer in the control of apoptosis. *Oncogene* **27**, 6407-18.
- Purintrapiban J., Wang M.-c. & Forsberg N.E. (2001) Identification of glycogen phosphorylase and creatine kinase as calpain substrates in skeletal muscle. *The International Journal of Biochemistry & Cell Biology* **33**, 531-40.
- Purslow P.P. (2018) Contribution of collagen and connective tissue to cooked meat toughness; some paradigms reviewed. *Meat Sci* **144**, 127-34.

- Reiche A.M., Oberson J.L., Silacci P., Messadène-Chelali J., Hess H.D., Dohme-Meier F., Dufey P.A. & Terlouw E.M.C. (2019) Pre-slaughter stress and horn status influence physiology and meat quality of young bulls. *Meat Sci* **158**, 107892.
- Robergs R.A., Ghiasvand F. & Parker D. (2004) Biochemistry of exercise-induced metabolic acidosis. *Am J Physiol Regul Integr Comp Physiol* **287**, R502-16.
- Rodrigues R.T.d.S., Chizzotti M.L., Vital C.E., Baracat-Pereira M.C., Barros E., Busato K.C., Gomes R.A., Ladeira M.M. & Martins T.d.S. (2017) Differences in Beef Quality between Angus (*Bos taurus taurus*) and Nellore (*Bos taurus indicus*) Cattle through a Proteomic and Phosphoproteomic Approach. *PLOS ONE* **12**, e0170294.
- Ruusunen M. & Puolanne E. (2004) Histochemical properties of fibre types in muscles of wild and domestic pigs and the effect of growth rate on muscle fibre properties. *Meat Sci* **67**, 533-9.
- Sauerwein H. & Meyer H.H.D. (1989) Androgen and Estrogen Receptors in Bovine Skeletal Muscle: Relation to Steroid-Induced Allometric Muscle Growth. *Journal of Animal Science* **67**, 206-12.
- Schwartz R., Ting C.S. & King J. (2001) Whole Proteome pI Values Correlate with Subcellular Localizations of Proteins for Organisms within the Three Domains of Life. *Genome Res* **11**, 703-9.
- Sestili P., Martinelli C., Colombo E., Barbieri E., Potenza L., Sartini S. & Fimognari C. (2011) Creatine as an antioxidant. *Amino Acids* **40**, 1385-96.
- Shathasivam T., Kislinger T. & Gramolini A.O. (2010) Genes, proteins and complexes: the multifaceted nature of FHL family proteins in diverse tissues. *J Cell Mol Med* **14**, 2702-20.
- Sierra V., Fernandez-Suarez V., Castro P., Osoro K., Vega-Moreno I., Garcia-Macia M., Rodriguez-Colunga P., Coto-Montes A. & Oliván M. (2012) Identification of biomarkers of meat tenderisation and its use for early classification of Asturian beef into fast and late tenderising meat. *J Sci Food Agric* **92**, 2727-40.
- Sierra V. & Oliván M. (2013) Role of mitochondria on muscle cell death and meat tenderization. *Recent Pat Endocr Metab Immune Drug Discov* **7**, 120-3.
- Silva L.H.P., Rodrigues R.T.S., Assis D.E.F., Benedicti P.D.B., Duarte M.S. & Chizzotti M.L. (2019) Explaining meat quality of bulls and steers by differential proteome and phosphoproteome analysis of skeletal muscle. *J Proteomics* **199**, 51-66.
- Smuder A.J., Kavazis A.N., Hudson M.B., Nelson W.B. & Powers S.K. (2010) Oxidation enhances myofibrillar protein degradation via calpain and caspase-3. *Free Radic Biol Med* **49**, 1152-60.
- Sorrell S.L., Golder Z.J., Johnstone D.B. & Karet Frankl F.E. (2016) Renal peroxiredoxin 6 interacts with anion exchanger 1 and plays a novel role in pH homeostasis. *Kidney International* **89**, 105-12.
- Sugiyama Y., Suzuki A., Kishikawa M., Akutsu R., Hirose T., Wayne M.M.Y., Tsui S.K.W., Yoshida S. & Ohno S. (2000) Muscle Develops a Specific Form of Small Heat Shock Protein Complex Composed of MK5F1, HSPB2 and HSPB3 during Myogenic Differentiation. *Journal of Biological Chemistry* **275**, 1095-104.
- Tarze A., Deniaud A., Le Bars M., Maillier E., Molle D., Larochette N., Zamzami N., Jan G., Kroemer G. & Brenner C. (2007) GAPDH, a novel regulator of the pro-apoptotic mitochondrial membrane permeabilization. *Oncogene* **26**, 2606-20.
- Taylor R.G., Geesink G.H., Thompson V.F., Koohmaraie M. & Goll D.E. (1995) Is Z-disk degradation responsible for postmortem tenderization? *Journal of Animal Science* **73**, 1351-67.
- Thomas K.J., McCoy M.K., Blackinton J., Beilina A., van der Brug M., Sandebring A., Miller D., Maric D., Cedazo-Minguez A. & Cookson M.R. (2011) DJ-1 acts in parallel to the PINK1/parkin pathway to control mitochondrial function and autophagy. *Hum Mol Genet* **20**, 40-50.
- Tulli F., Fabbro A., D'Agaro E., Messina M., Bongiorno T., Venir E., Lippe G., Tibaldi E. & Stecchini M.L. (2015) The effect of slaughtering methods on actin degradation and on muscle quality attributes of farmed European sea bass (*Dicentrarchus labrax*). *Journal of Food Science and Technology* **52**, 7182-90.
- Vacek T.P., Gillespie W., Tyagi N., Vacek J.C. & Tyagi S.C. (2010) Hydrogen sulfide protects against vascular remodeling from endothelial damage. *Amino Acids* **39**, 1161-9.
- Warner R.D., Greenwood P.L., Pethick D.W. & Ferguson D.M. (2010) Genetic and environmental effects on meat quality. *Meat Sci* **86**, 171-83.

- Wettstein G., Bellaye P.S., Micheau O. & Bonniaud P. (2012) Small heat shock proteins and the cytoskeleton: An essential interplay for cell integrity? *The International Journal of Biochemistry & Cell Biology* **44**, 1680-6.
- Wicks J., Beline M., Gomez J.F.M., Luzardo S., Silva S.L. & Gerrard D. (2019) Muscle Energy Metabolism, Growth, and Meat Quality in Beef Cattle. *Agriculture* **9**, 195.
- Wu S., Wan P., Li J., Li D., Zhu Y. & He F. (2006) Multi-modality of pI distribution in whole proteome. *PROTEOMICS* **6**, 449-55.
- Wu W., Fu Y., Therkildsen M., Li X.-M. & Dai R.-T. (2015) Molecular Understanding of Meat Quality Through Application of Proteomics. *Food Reviews International* **31**, 13-28.
- Wulff T., Jokumsen A., Højrup P. & Jessen F. (2012) Time-dependent changes in protein expression in rainbow trout muscle following hypoxia. *Journal of Proteomics* **75**, 2342-51.
- Xu Y., Wang H., Nussinov R. & Ma B. (2013) Protein charge and mass contribute to the spatio-temporal dynamics of protein-protein interactions in a minimal proteome. *PROTEOMICS* **13**, 1339-51.
- Yang X., Wu S., Hopkins D.L., Liang R., Zhu L., Zhang Y. & Luo X. (2018) Proteomic analysis to investigate color changes of chilled beef longissimus steaks held under carbon monoxide and high oxygen packaging. *Meat Sci* **142**, 23-31.
- Zapata I., Zerby H.N. & Wick M. (2009) Functional proteomic analysis predicts beef tenderness and the tenderness differential. *J Agric Food Chem* **57**, 4956-63.
- Zhai C., Djimsa B.A., Prenni J.E., Woerner D.R., Belk K.E. & Nair M.N. (2020) Tandem mass tag labeling to characterize muscle-specific proteome changes in beef during early postmortem period. *Journal of Proteomics* **222**, 103794.
- Zhao C., Zan L., Wang Y., Scott Updike M., Liu G., Bequette B.J., Baldwin Vi R.L. & Song J. (2014) Functional proteomic and interactome analysis of proteins associated with beef tenderness in Angus cattle. *Livestock Science* **161**, 201-9.
- Zhou Y., Zhou B., Pache L., Chang M., Khodabakhshi A.I., Tanaseichuk O., Benner C. & Chanda S.K. (2019) Metascape provides a biologist-oriented resource for the analysis of systems-level datasets. *Nature Communications* **10**, 1523.

Figure captions

Figure 1. PRISMA flow-chart showing the screening strategy used to identify eligible papers to build the dataset of putative protein biomarkers for beef tenderness. Number (n) in brackets refers to the number of articles.

Figure 2. Categorization of the 124 identified proteins. **A)** Ranking of the 124 putative protein biomarkers of beef tenderness, regardless of the animal category, by the number of identifications across the 28 proteomic-based studies. The proteins identified ≥ 4 times across all of the studies ($n = 33$) are in a white box and in bold font, those identified 3 ($n = 12$) or 2 times ($n = 19$) are in a grey box and those identified one time only ($n = 60$) are in a yellow box. The proteins are categorized and highlighted by different colors according to their biological pathways (see **Table 1**). Blue, Muscle contraction, structure and associated proteins; orange, Energy metabolism proteins; red, Heat Shock proteins; green, Oxidative stress proteins; purple, Proteolysis; and black/grey, Regulation of cellular processes, binding, apoptosis and transport proteins. The rank order distribution of the shortlisted robust biomarkers based on the number of their identification among the 28 proteomic-based studies (33 proteins, identified ≥ 4 times across all studies) are highlighted in the insert in the top right of the white box. In this graph, four rectangles with a gradient color from the top, enclose the proteins identified > 15 times (in red, ACTA1 and HSPB1) down to those identified < 6 times (palest clear yellow rectangle). The full protein names and the direction of their association with beef tenderness are given in **Table 1**. **B – C)** Pie charts highlighting the distribution of the protein biomarkers by biological pathway for **B)** all the proteins ($n = 124$) and **C)** the 64 shortlisted proteins that were identified > 2 times.

Figure 3. Interconnectedness of beef tenderness protein biomarkers. Protein-protein interaction (PPI) network linking the shortlisted 64 protein biomarkers (cut-off ≥ 2 times) from the 28 proteomic-based studies (see **Table 1**). The interaction map was generated from the web-based search STRING database (<https://string-db.org/>). Default settings of confidence of 0.6 and 4 criteria for linkage: Co-occurrence, experimental evidence, existing databases and text mining were used. The proteins identified > 10 times among the 28 proteomic-based experiments are shown by black asterisks. The glycolytic enzymes within the energy metabolism pathway are shown by small yellow circles on the nodes of the corresponding proteins. Network statistics are: number of nodes: 64; number of edges: 412; average node degree: 12.9; average local clustering coefficient: 0.633; expected number of edges: 71 and PPI enrichment p -value: $< 1.0e^{-16}$.

Figure 4. Networks of pathways and process enrichment cluster analysis based on the 64 shortlisted protein biomarkers using Metascape® (<https://metascape.org/>). **A)** The network diagram is constructed with each enrichment GO term as a node and the similarity of the node as the edge. The nodes are colored by cluster ID, where nodes that share the same cluster ID are usually close to each other. **B)** Functional enrichment network constructed by nodes representing terms with the best p -values from each of the Top20 clusters (**Table 2** and **Figure S1**), with the constraint that there are no more than 15 terms per cluster and no more than 250 terms in total and edges connecting terms with a similarity > 0.3 (the thickness of the edge

represents the similarity score). Each circle node represents one enriched term, where its size is proportional to the number of proteins (gene names) falling into that term and its color represents cluster identity. Kappa scores were used as the similarity metric when performing hierarchical clustering on the enriched terms. Cluster annotations are shown color-coded and the name of the four first terms (most significant; **Table 2**) are given on the network layout.

Figure 5. GO pathway enrichment and clustering. **A)** Protein overlap analysis. Circos plot illustrating the degree of overlap among the five animal categories (bulls, cows, steers, heifers and bulls+steers) based on the 64 shortlisted protein biomarkers of beef tenderness (cut-off ≥ 2 times) from the 28 proteomic-based studies (**Table 1**). Each outside arch represents each animal category with a different color. On the inside, the dark orange color represents the proteins that appear in multiple lists and the light orange color represents proteins that are unique to that protein list; and purple lines link the same protein (gene names) that are shared by the input. The number in parentheses near each animal category represents the total number of proteins in that category. **B)** Hierarchical Heatmap clustering indicating the first 20 enriched GO terms (further details **Table 2**). The enrichment of Gene Ontology (GO) and Kyoto Encyclopedia of Genes and Genomes (KEGG), were analyzed by Metascape® (<https://metascape.org/>). Shown by a black rectangle, the GO analysis suggests that “muscle contraction”, “ATP metabolic process”, “muscle structure development”, “leucocyte activation involved in immune response” and “oxidative stress” are associated with beef tenderness determination, across all animal categories. The heatmap is colored by the p -values are indicated by color, where grey cells indicate the lack of significant enrichment, palest brown indicates a low p -value and darkest brown indicates a high p -value.

Figure 6. Venn diagram and its expansion on an Upset plot showing the overlap and distribution of the 64 shortlisted proteins (identification with cut-off ≥ 2) among the five animal categories. Numbers of identified proteins shared among the different animal categories are indicated in the top bar chart and written with different colors according to their biological pathways (**Table 1**); blue, Muscle contraction, structure and associated proteins; orange, Energy metabolism proteins; red, Heat Shock Proteins; green: Oxidative stress Proteins; and black, Regulation of cellular processes, binding, apoptosis and transport proteins. The specific overlaps are indicated by the black solid dots below each bar chart. The proteins in bold font and underlined are those that were identified ≥ 10 times. All the proteins in bold font were identified ≥ 4 times and < 10 times. The proteins identified 2 and 3 times are in italic. Total identifications found for each animal category are indicated in the horizontal left bar graph as ‘set size’. The common proteins (ACTA1, MYH7 and CKM) and (TNNC1 and HSPA1A) framed with a rectangles were identified, across all animal categories and gender, respectively.

Figure 7. Scatter plot categorizing the 64 putative protein biomarkers (cut-off ≥ 2 times) by their theoretical molecular weight (Mw) *versus* isoelectric point (pI).

The two variables were computed with “Compute pI/Mw tool” at the ExPASy server (https://web.expasy.org/compute_pi/) using bovine Uniprot IDs (**Table 1**). The proteins identified less than 4 but ≥ 2 times identification are in italics. All the proteins are given in different colors according to their biological pathways (**Table 1**): blue, Muscle contraction,

structure and associated proteins; orange, Energy metabolism proteins; red, Heat Shock Proteins; green, Oxidative stress Proteins; and black, Regulation of cellular processes, binding, apoptosis and transport proteins. Rectangles with the same color for the biological pathways emphasized the proteins to highlight the distribution and overlap between the pathways based on pI and M_w . The horizontal brackets highlight the multimodality of pI distribution, and also show that there are very low fractions of proteins with pI close to 7.4. In addition, a horizontal yellow line indicates a molecular weight of 30 kDa, to illustrate the different proteins present at that position. The average $pI \pm SD$ (standard deviation) and coefficient of variation (CV), in percentage, of the group of proteins belonging to the same biological pathway were computed and are shown at the top right with color corresponding to biological pathway.

Figure 8. Simplified metabolic role and localization of the 29 proteins belonging to the “energy metabolism & ATP metabolic process” that is the second pathway of putative biomarkers identified in this integromics meta-analysis. The proteins (enzymes) surrounded with rectangles were categorized into three main sub-pathways that are **A)** Glycolysis and associated pathways ($n = 13$); **B)** Tricarboxylic acid (Krebs) cycle and associated pathways ($n = 11$); and **C)** Other catalytic and ATP metabolic pathways ($n = 5$). For the full names of the proteins and their UniprotIDs refer to **Table 1**. The proteins that were identified with cut-off ≥ 2 ($n = 19$, with 11 from glycolysis) are shown with solid rectangles and dark orange background and those identified only one time ($n = 10$) are with dashed rectangles and clear orange background.

Figure 9. Localization, in the sarcomere, of the 35 proteins belonging to “muscle contraction, structure and associated proteins” pathway retrieved from the 28 proteomics-based experiments in *Longissimus* muscle. The proteins in the 4 compartments (thick filament, thin filament, M-band, z-disc) of the sarcomere are given by their gene names (see **Table 1** for details of the full protein names and their Uniprot IDs). The proteins that were identified with cut-off ≥ 2 are in bold and the robust shortlisted proteins with cut-off ≥ 4 are indicated in blue.

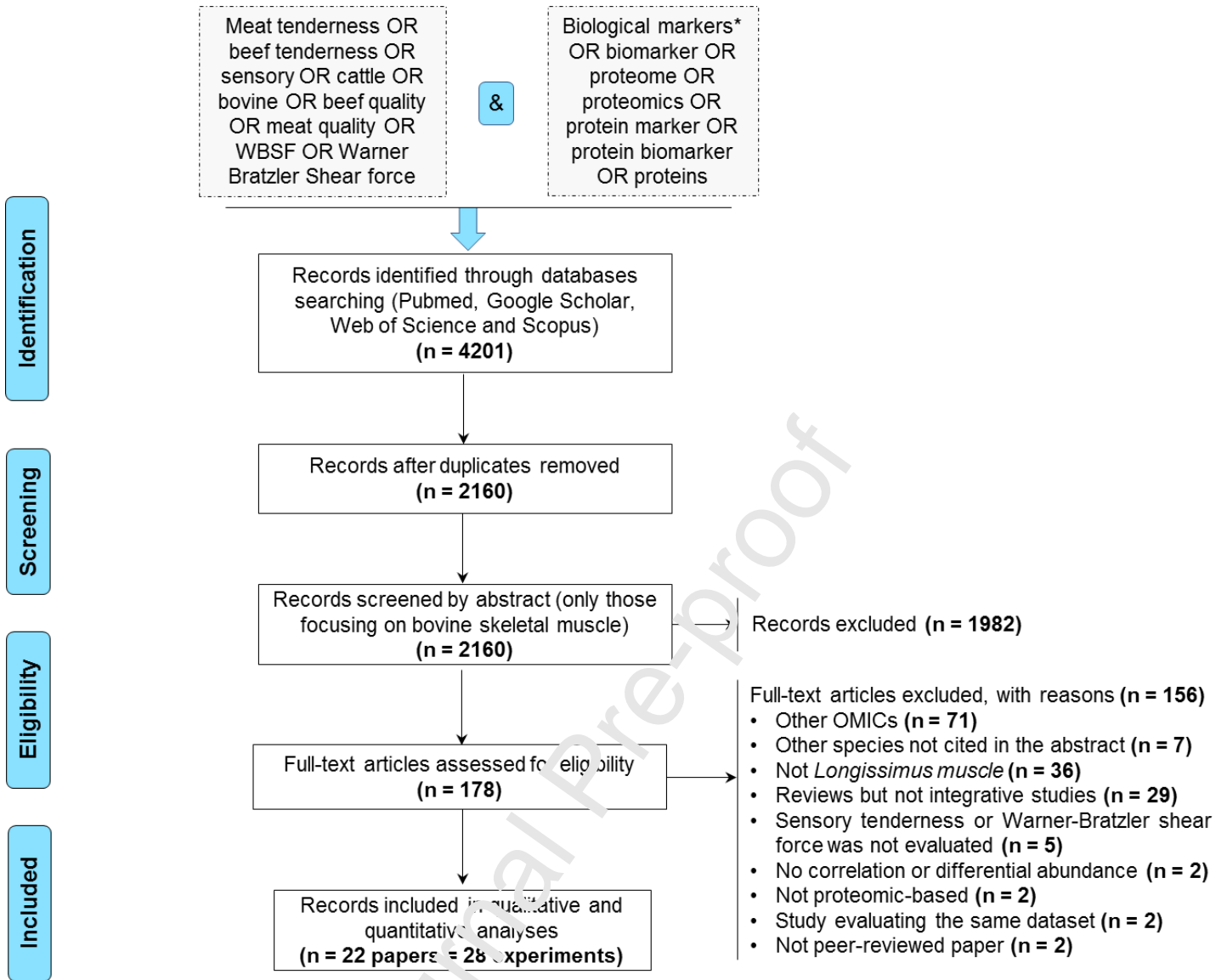

Figure 1.

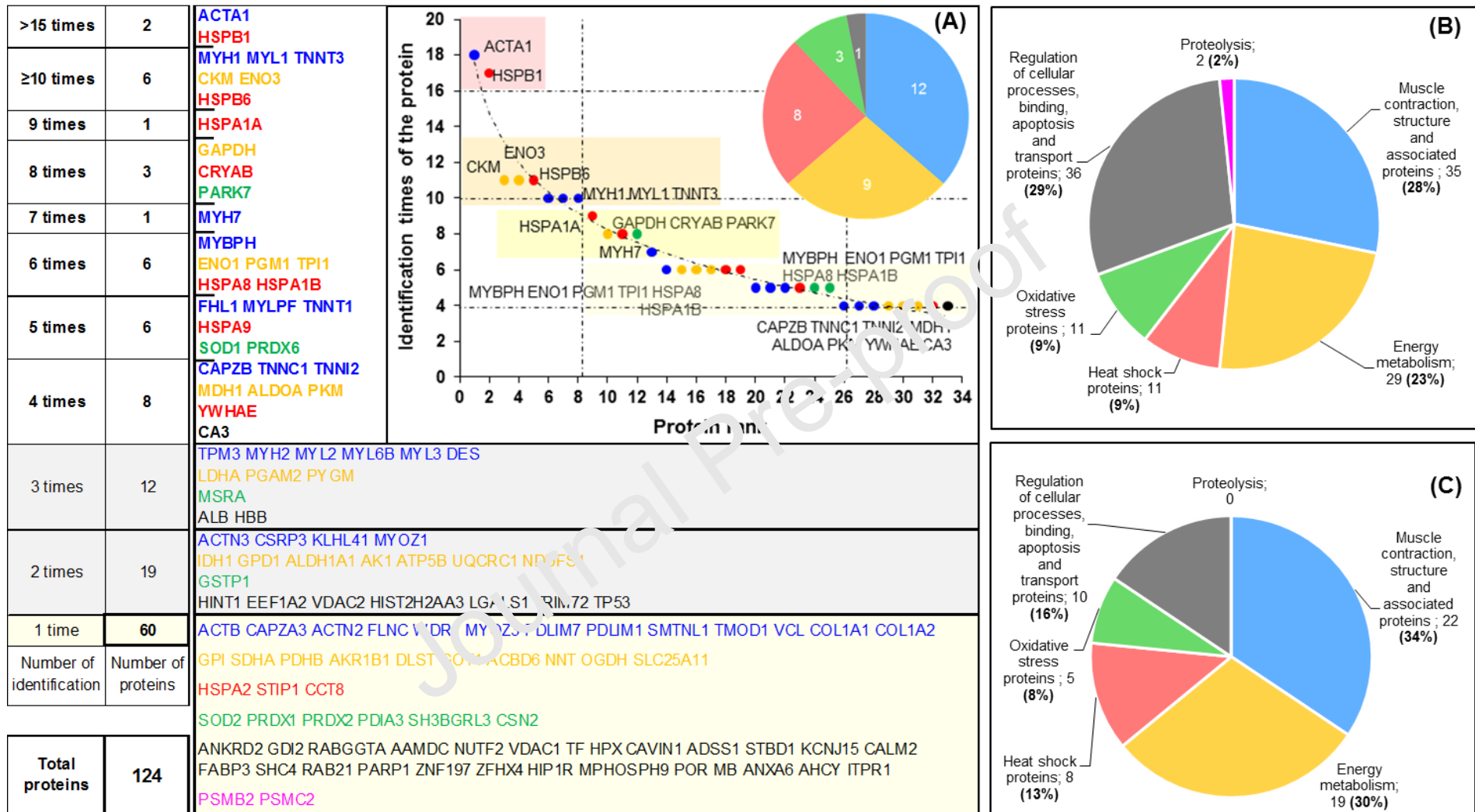

Figure 2.

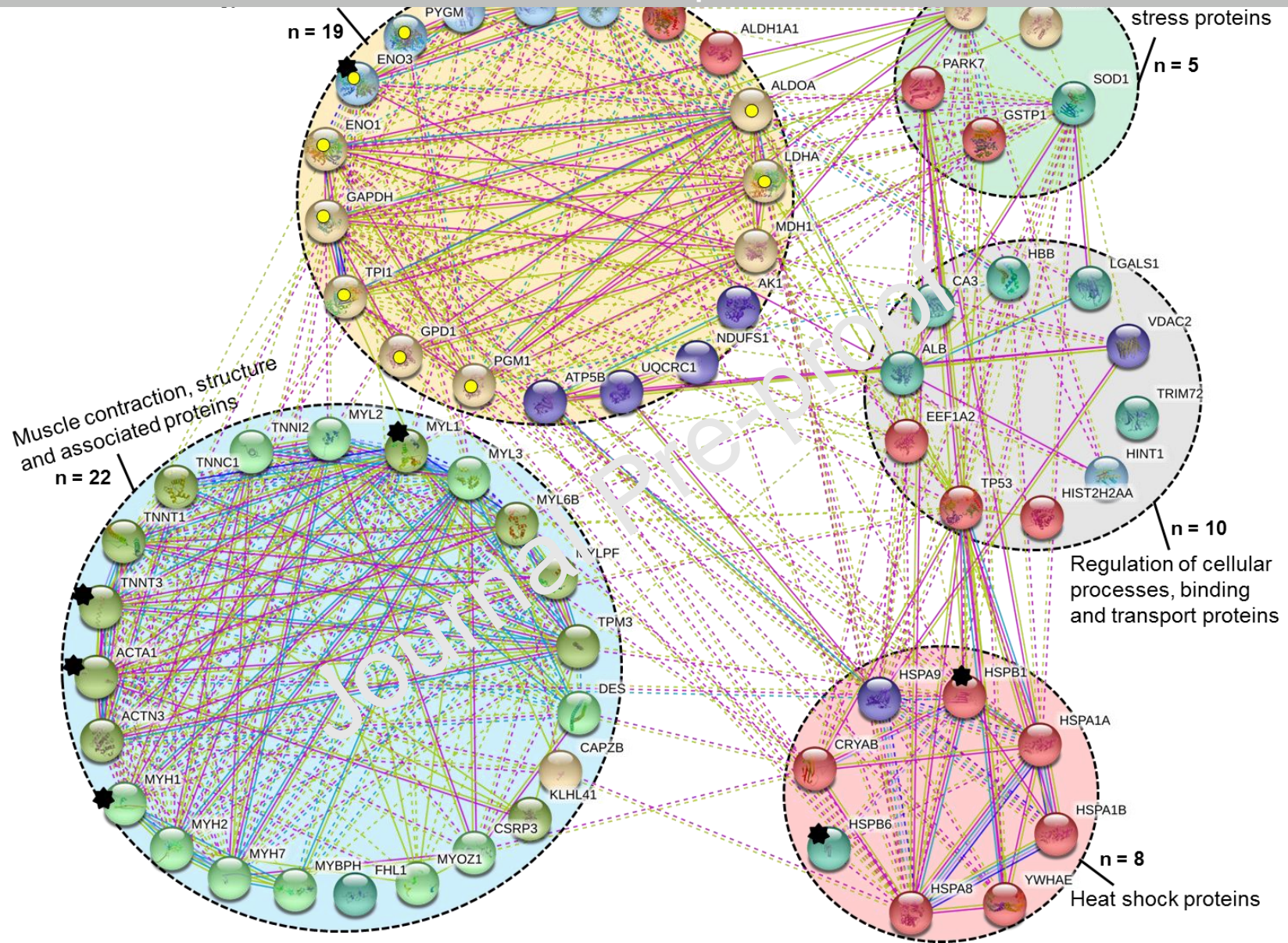

Figure 3.

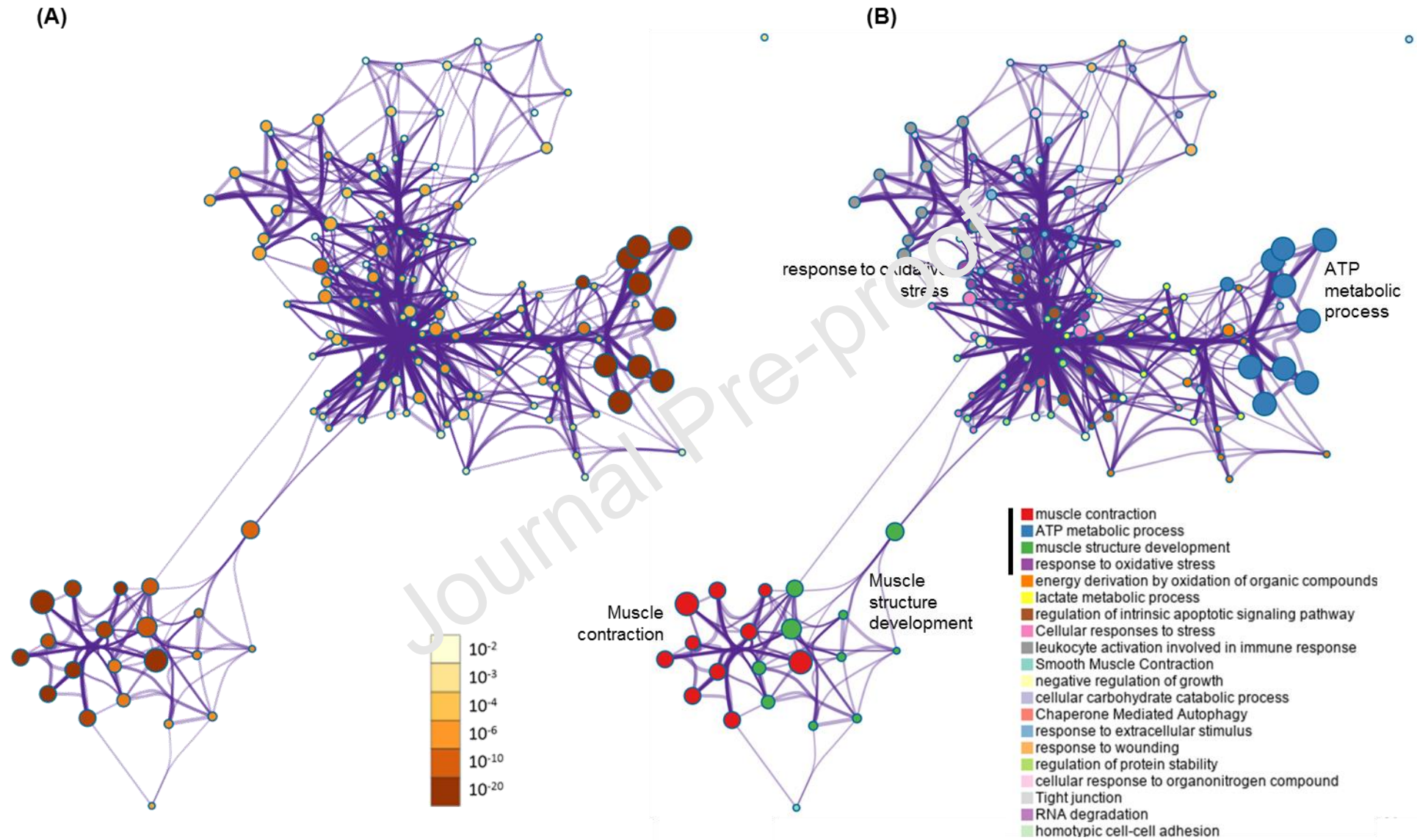

Figure 4.

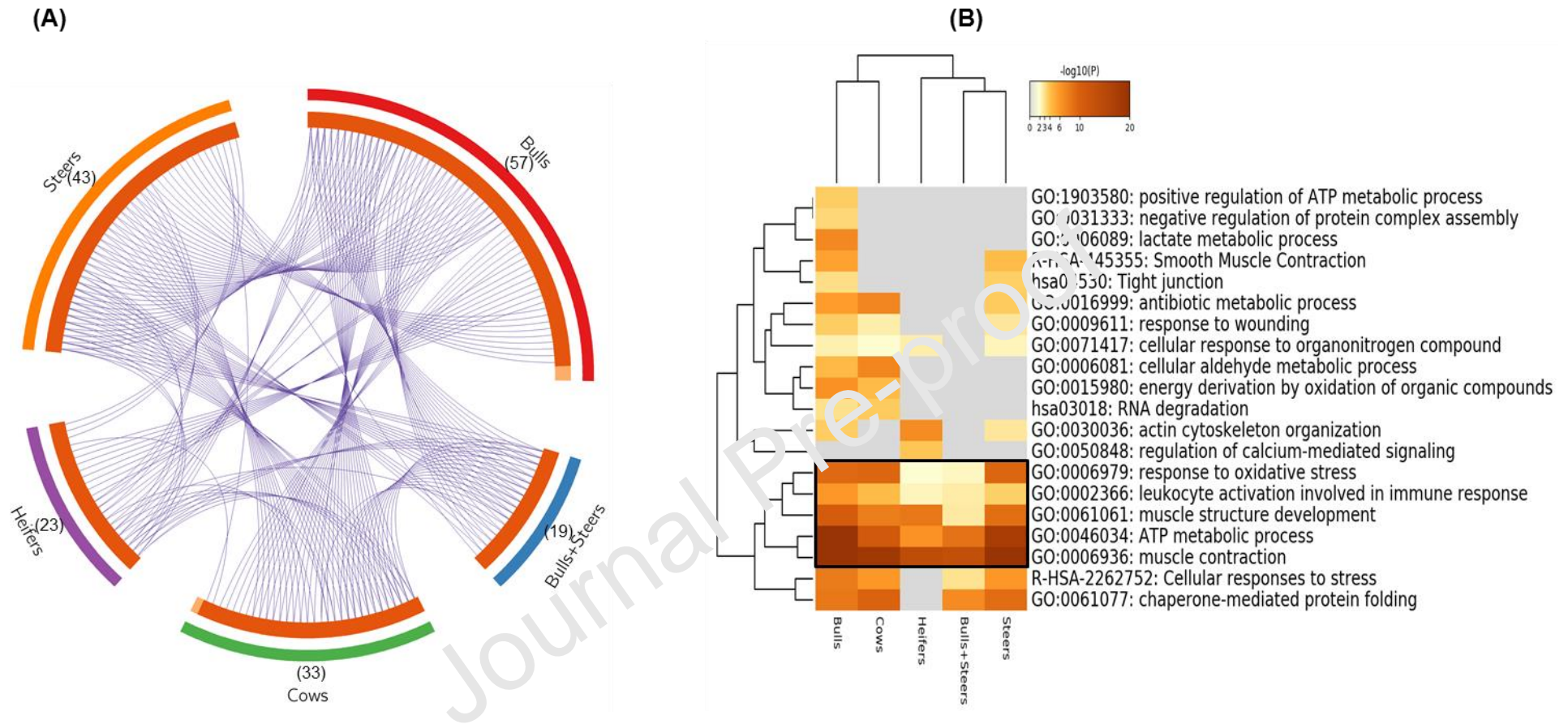

Figure 5.

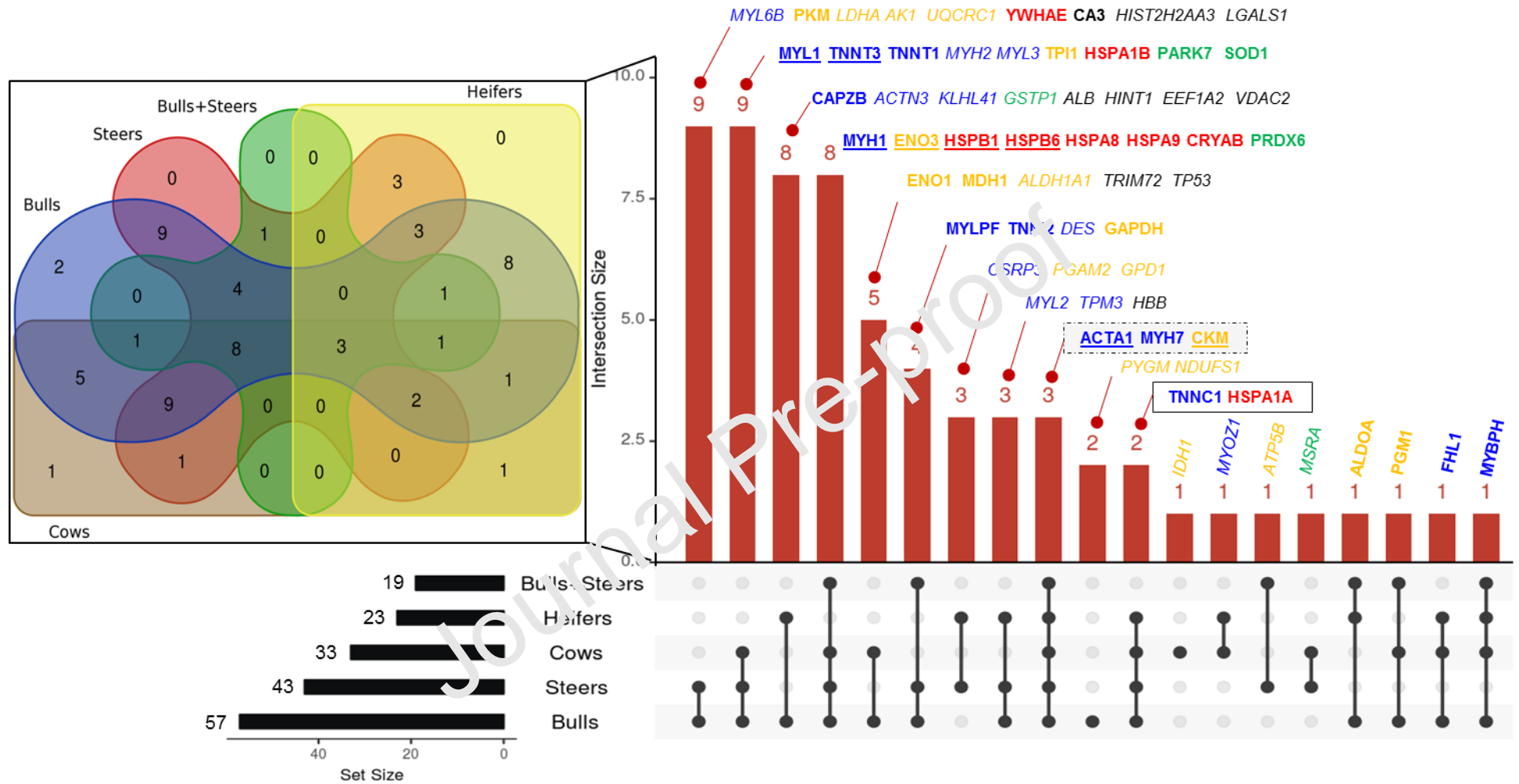

Figure 6.

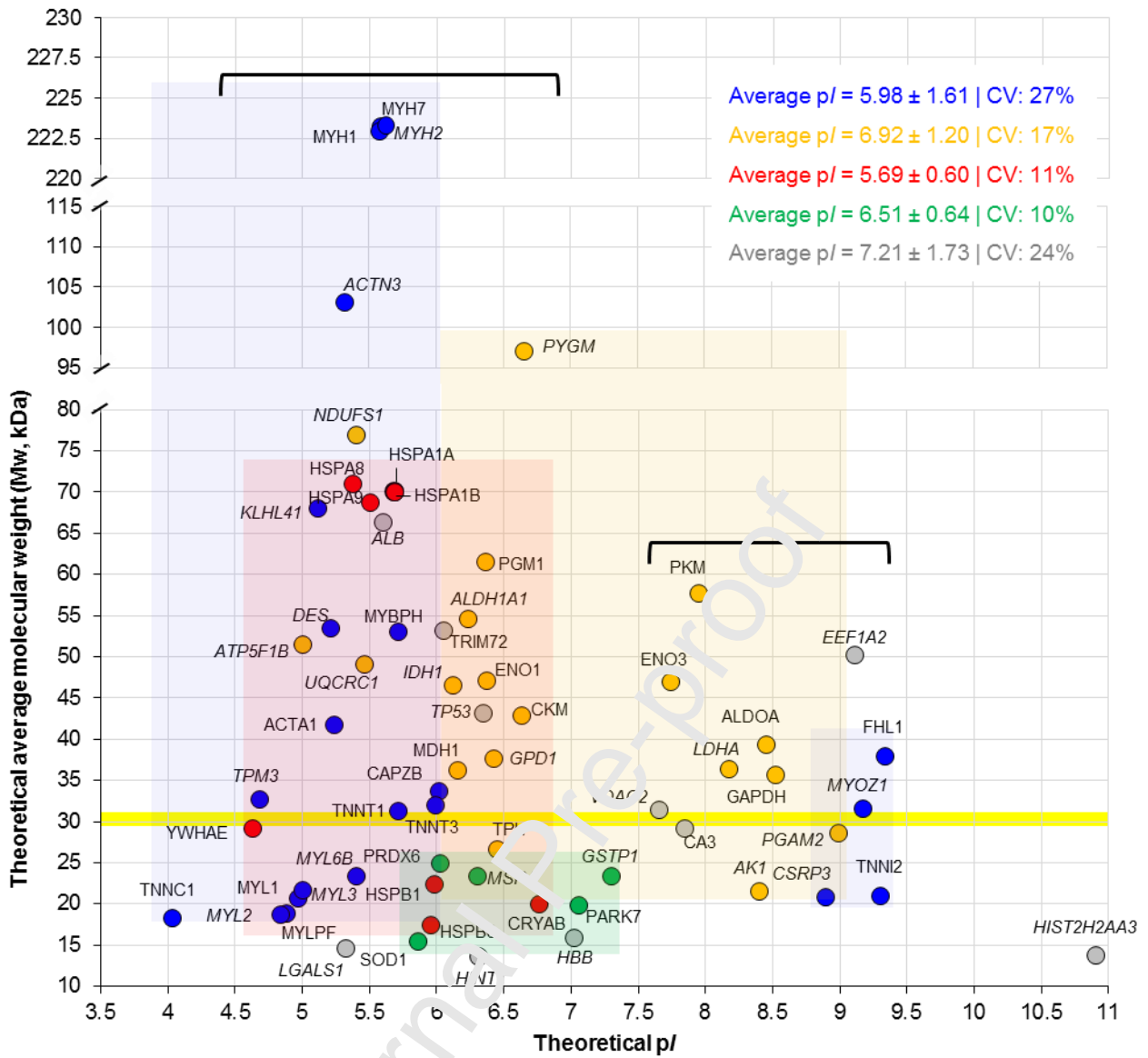

Figure 7.

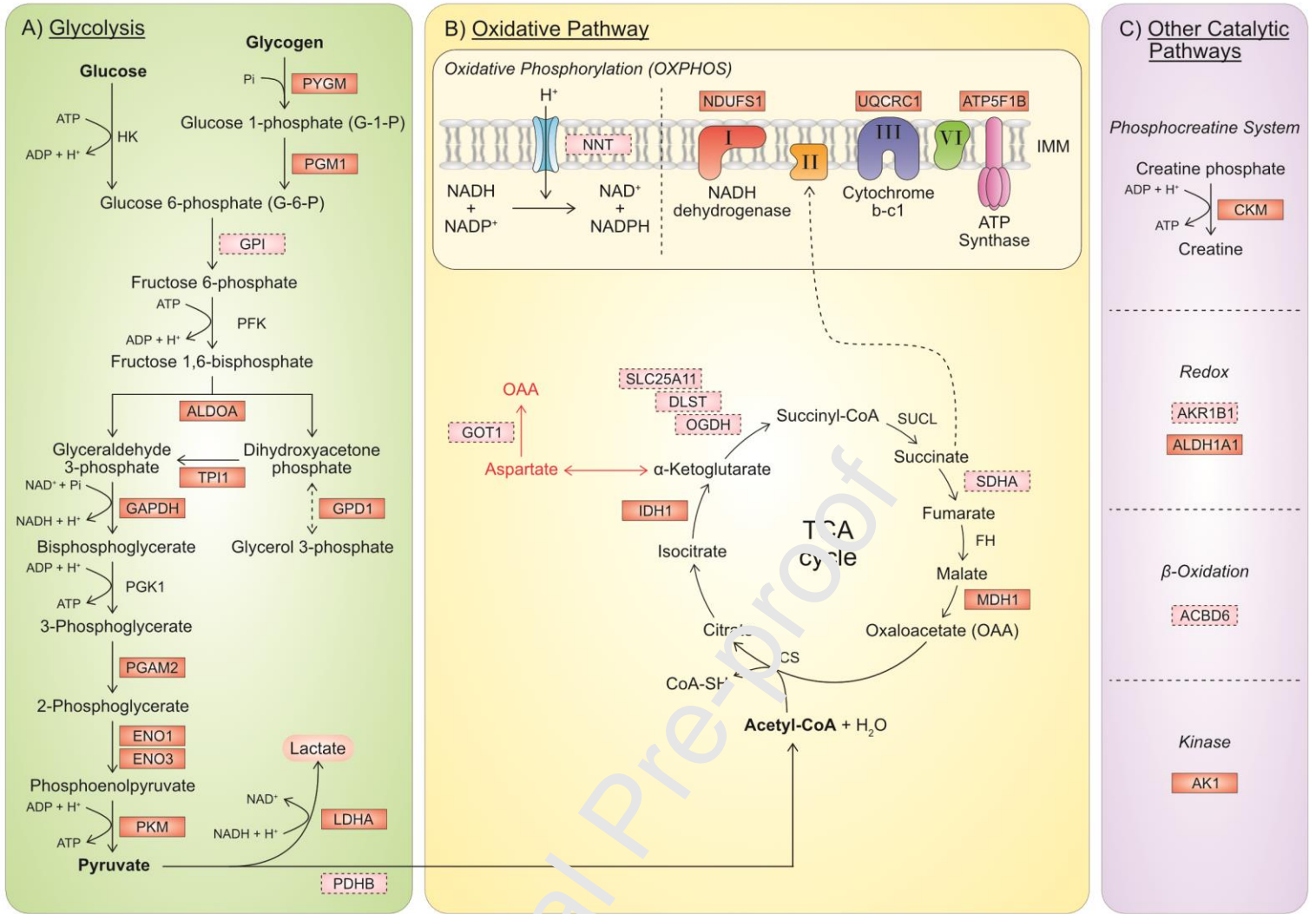
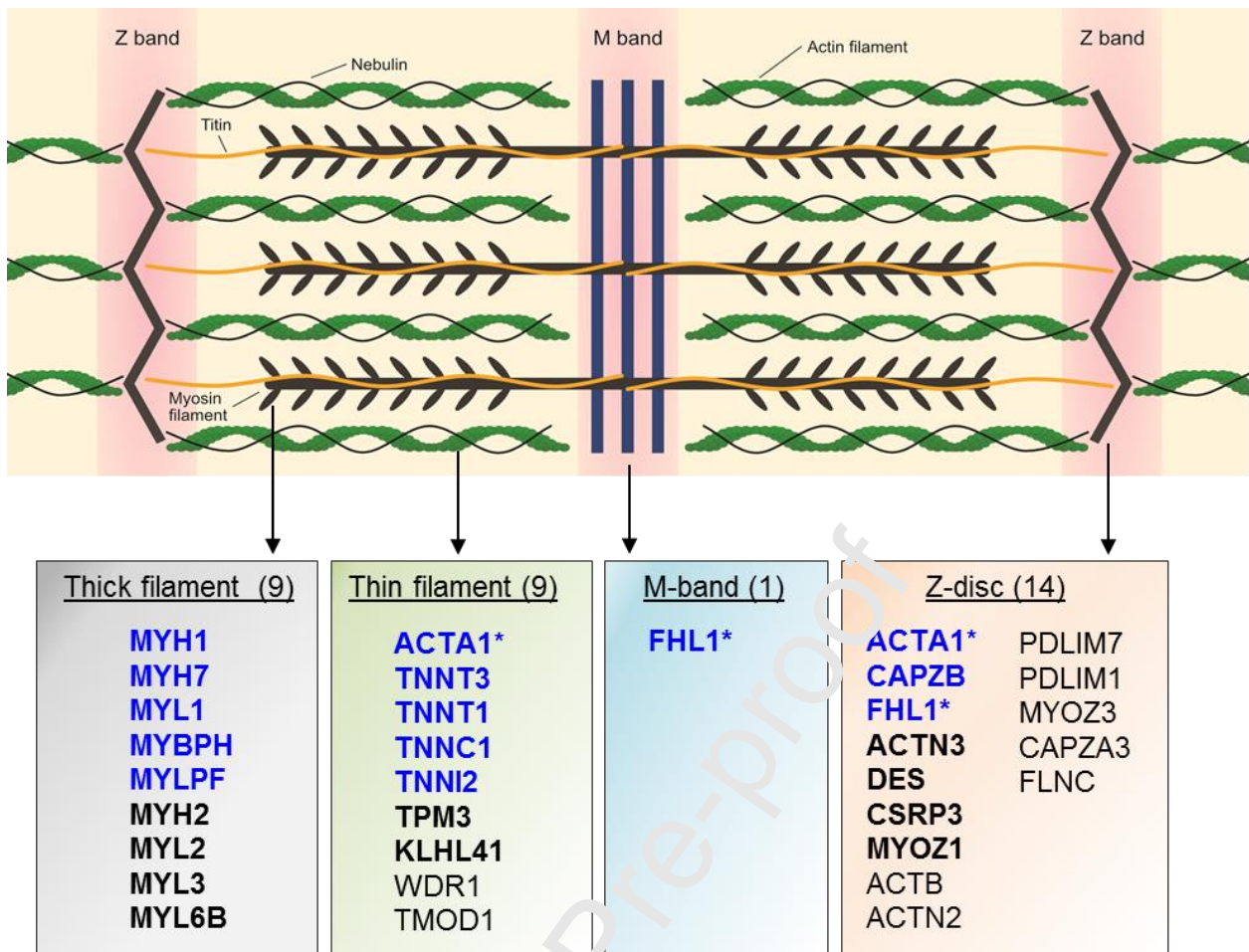

Figure 8.



OTHER PROTEINS NOT ALLOCATED ABOVE

SMTNL1: Smoothelin-like protein 1

VCL: Vinculin

COL1A1: Collagen alpha-1(I) chain

COL1A2: Collagen alpha-2(I) chain

* Proteins present in different compartments

Figure 9.

Table 1. Continued.

Bovine Uniprot ID	Full protein name	Gene name	Experiments (Exp.) ^a																										#Σp		
			1	2	3	4	5	6	7	8	9	10	11	12	13	14	15	16	17	18	19	20	21	22	23	24	25	26		27	28
Energy metabolism^b (n = 29) – Glycolytic enzymes (n = 13) are marked with asterisks.																															
Q9XSC6	Creatine kinase M-type	CKM				◆	●		●	●	●	●					●		■	◆	●								●		11
Q3ZC09	Beta-enolase	ENO3*						■		●			●			■		●	■					●	●		■	■	●		11
P10096	Glyceraldehyde-3-phosphate dehydrogenase	GAPDH*				◆	◆		●			●	●							■	◆								■		8
Q9XSI4	Alpha-enolase	ENO1*									●								■					■	●	●		●			6
Q08DP0	Phosphoglucomutase-1	PGM1*									●										◆			■	●		■		■		6
Q5E956	Triosephosphate isomerase	TPI1*									●								●	■			●	■	●						6
Q3T145	Malate dehydrogenase, cytoplasmic	MDH1			●							●												■						●	4
A6QLL8	Fructose-bisphosphate aldolase A	ALDOA*													●			●		●	■										4
Q3ZC87	Pyruvate kinase	PKM*					●		●							◆			●												4
P19858	L-lactate dehydrogenase A chain	LDHA*										■	●		●																3
Q32KV0	Phosphoglycerate mutase 2	PGAM2*											●							■			■								3
P79334	Glycogen phosphorylase	PYGM*					■												●					■							3
Q9XSG3	Isocitrate dehydrogenase [NADP] cytoplasmic	IDH1														◆										●					2
Q5EA88	Glycerol-3-phosphate dehydrogenase [NAD(+)], cytoplasmic	GPD1*																						■	●						2
P48644	Retinal dehydrogenase 1	ALDH1A1																	●											■	2
P00570	Adenylate kinase isoenzyme 1	AK1					●														●										2
P00829	ATP synthase subunit beta, mitochondrial	ATP5F1B				◆																									2
P31800	Cytochrome b-c1 complex subunit 1, mitochondrial	UQCRC1												●																	2
P15690	NADH-ubiquinone oxidoreductase 75 kDa subunit	NDUFS1					●																						●		2
P11966	Pyruvate dehydrogenase E1 component subunit beta	PDHB*																								●					1
Q3ZBD7	Glucose-6-phosphate isomerase	PFKP																						■							1
P31039	Succinate dehydrogenase [ubiquinone]	SDHA	●																												1
P16116	Aldo-keto reductase family 1 member B1	AKR1B1																							■						1
P11179	DLST component of 2-oxoglutarate dehydrogenase complex	DLST							●																						1
P33097	Aspartate aminotransferase, cytoplasmic	GOT1																							●						1
A2VDR2	Acyl-CoA-binding domain-containing protein 6	ACBD6												●																	1
P11024	NAD(P) transhydrogenase, mitochondrial	NNT																							●						1
Q148N0	2-oxoglutarate dehydrogenase, mitochondrial	OGDH																							●						1
P22292	Mitochondrial 2-oxoglutarate/malate carrier protein	SLC25A11																							●						1

Table 1. Continued.

Bovine Uniprot ID	Full protein name	Gene name	Experiments (Exp.) ^a																												#Σp
			1	2	3	4	5	6	7	8	9	10	11	12	13	14	15	16	17	18	19	20	21	22	23	24	25	26	27	28	
Heat Shock Proteins^b (n = 11) – small HSPs (n = 3) are marked with asterisks.																															
Q3T149	Heat shock protein beta-1	HSPB1*	◆	■			●				◆	●			◆	■	■	●	●					◆	●	■	◆	◆	◆	■	17
Q148F8	Heat shock protein beta-6	HSPB6*				●		■			●	◆	■					■	●					●				◆	■	■	11
Q27975	Heat shock 70 kDa protein 1A	HSPA1A								■	●		■		●				●	●		●	●			●				9	
P02510	Alpha-crystallin B chain	CRYAB*				◆		●			●								●	●							●	■	■	8	
P19120	Heat shock cognate 71 kDa protein	HSPA8									■						■		●	●	●					●				6	
Q27965	Heat shock 70 kDa protein 1B	HSPA1B									●				■								■	■	■	■				6	
Q3ZCH0	Stress-70 protein, mitochondrial	HSPA9			■		●				●											■		■				●		5	
P62261	14-3-3 protein epsilon	YWHAE								●												●	■					●		4	
Q3ZBZ8	Stress-induced-phosphoprotein 1	STIP1																										■		1	
P34933	Heat shock-related 70 kDa protein 2	HSPA2																							■					1	
Q3ZCI9	T-complex protein 1 subunit theta	CCT8		■																										1	
Oxidative stress Proteins^b (n = 11)																															
Q5E946	Protein/nucleic acid deglycase DJ-1	PARK7			■							●				■		■	●					■			●	■		8	
O77834	Peroxiredoxin-6	PRDX6			●		■					●				●		■					■							5	
P00442	Superoxide dismutase [Cu-Zn]	SOD1								■						■		●	●					■						5	
P54149	Mitochondrial peptide methionine sulfoxide reductase	MSRA																				●			●	●				3	
P28801	Glutathione S-transferase P	GSTP1																					■				●			2	
P41976	Superoxide dismutase [Mn], mitochondrial	SOD2																												1	
Q5E947	Peroxiredoxin-1	PRDX1																												1	
Q9BGI3	Peroxiredoxin-2	PRDX2																												1	
P38657	Protein disulfide-isomerase A3	PDI A3																									■			1	
Q3ZCL8	SH3 domain-binding glutamic acid-rich-like protein 3	SH3LGR13									■																			1	
P02666	Beta-casein	CSN 2									●																			1	
Proteolysis^b (n = 2)																															
Q5E9K0	Proteasome subunit beta type-2	PSMB2																										●		1	
Q5E9F9	26S proteasome regulatory subunit 7	PSMC2																										●		1	

^a The proteins from the 28 proteomic-based experiments (datasets) were retrieved from 22 studies that are categorized in the order of their year of publication: Exp.1_Sensory_Bulls (Morzel *et al.* 2008); Exp.2_WBSF_Bulls+Steers (Kim *et al.* 2008); Exp.3_WBSF_Bulls (Jia *et al.* 2009); Exp.4_WBSF_Steers (Zapata *et al.* 2009); Exp.5_WBSF_Bulls (Laville *et al.* 2009); Exp.6_WBSF_Bulls+Steers (Guillemin *et al.* 2011); Exp.7_WBSF_Bulls (Sierra *et al.* 2012); Exp.8_WBSF_Bulls (Bjarnadottir *et al.* 2012); Exp.9_WBSF_Bulls (D'Alessandro *et al.* 2012b); Exp.10_WBSF_Bulls (D'Alessandro *et al.* 2012a); Exp.11_WBSF+Sensory_Bulls (Picard *et al.* 2014); Exp.12_WBSF_Steers (Zhao *et al.* 2014); Exp.13_WBSF_Bulls (Carvalho *et al.* 2014); Exp.14_WBSF_Bulls (Baldassini *et al.* 2015); Exp.15_WBSF_Cows (Gagaoua *et al.* 2017a); Exp.16_WBSF_Cows (Beldarrain *et al.* 2018); Exp.17_WBSF+Sensory_Bulls (Gagaoua *et al.* 2018b); Exp.18_WBSF_Steers ((Malheiros *et al.* 2019); Exp.19_WBSF_Bulls+Steers (Silva *et al.* 2019); Exp.20_WBSF+Sensory_Heifers (Boudon *et al.* 2020); Exp.21_WBSF_Steers (Picard & Gagaoua 2020a); Exp.22_WBSF_Bulls (Picard & Gagaoua 2020a); Exp.23_WBSF_Cows (Picard & Gagaoua 2020a); Exp.24_WBSF_Cows (Picard & Gagaoua 2020a); Exp.25_Sensory_Bulls (Picard & Gagaoua 2020a); Exp.26_Sensory_Bulls (Picard & Gagaoua 2020a); Exp.27_Sensory_Bulls (Picard & Gagaoua 2020a) and Exp.28_WBSF_Cows (Gagaoua *et al.* 2020a). Sensory means the evaluation of tenderness using trained sensory panelists and WBSF means the use of an instrumental method based on Warner-Bratzler Shear force for the analysis of the meat steaks from different animal categories (bulls, steers, mix of bulls and steers, heifers or cows).

^b The proteins in the rows shown with blue dots “●” had highest abundance in tender meat (positive, ↑ up-abundance), those in red squares “■” had the lowest abundance in tender meat (negative, ↓ down-abundance) and those in orange diamonds “◇” are in both positive and negative directions (↔) due to either different isoforms or detection under different conditions such as breed or tenderness measurement or ageing time used in the experiment. Details can be found in each study for the 15 proteins in this situation when both directions are observed.

#Σp: highlights the sum or the total number of studies where a unique gene name (protein) was reported. Numbers in front bold character in each intense yellow box are those identified with cut-off ≥ 4 times and those reported 2 or 3 times are in normal character with slight colored yellow box. The proteins identified one time only are left blank. The rows of the gene names corresponding to proteins with cut-off ≥ 4 are also colored in gray.

Table 2. Top 20 clusters with their representative enriched terms (one per cluster) using the 64 putative proteins biomarkers of beef tenderness identified with a cut-off ≥ 2 among the 28 independent proteomic-based studies comparing the five animal categories.

Pattern ^a	Gene Ontology	Category	Description	Count ^b	% ^c	Log10(P) ^d	Log10(q) ^e
■■■■■	GO:0006936	GO Biological Processes	muscle contraction	26	40.62	-30.36	-26.05
■■■■■	GO:0046034	GO Biological Processes	ATP metabolic process	21	32.81	-23.74	-20.12
■■■■■	GO:0061061	GO Biological Processes	muscle structure development	17	26.56	-11.88	-9.49
■■■■■	GO:0006979	GO Biological Processes	response to oxidative stress	14	21.88	-10.89	-8.59
■■■■■	GO:0061077	GO Biological Processes	chaperone-mediated protein folding	6	18.18	-9.72	-7.63
■■■■■	GO:0015980	GO Biological Processes	energy derivation by oxidation of organic compounds	10	15.62	-8.5	-6.29
■■■■■	R-HSA-2262752	Reactome Gene Sets	Cellular responses to stress	12	21.05	-8.02	-6.13
■■■■■	GO:0016999	GO Biological Processes	antibiotic metabolic process	6	18.18	-7.27	-5.45
■■■■■	GO:0006081	GO Biological Processes	cellular aldehyde metabolic process	5	15.15	-7.22	-5.41
■■■■■	GO:0006089	GO Biological Processes	lactate metabolic process	4	7.02	-7.08	-5.28
■■■■■	GO:0030036	GO Biological Processes	actin cytoskeleton organization	8	34.78	-6.84	-5.07
■■■■■	GO:0002366	GO Biological Processes	leukocyte activation involved in immune response	12	18.75	-6.51	-4.38
■■■■■	R-HSA-445355	Reactome Gene Sets	Smooth Muscle Contraction	4	7.02	-5.62	-4.03
■■■■■	GO:1903580	GO Biological Processes	positive regulation of ATP metabolic process	4	6.25	-5.1	-3.09
■■■■■	GO:0009611	GO Biological Processes	response to wounding	9	14.06	-4.08	-2.16
■■■■■	GO:0050848	GO Biological Processes	regulation of calcium-mediated signaling	3	13.04	-3.94	-2.57
■■■■■	hsa03018	KEGG Pathway	RNA degradation	3	9.09	-3.8	-2.44
■■■■■	GO:0071417	GO Biological Processes	cellular response to organonitrogen compound	8	12.5	-3.76	-1.87
■■■■■	hsa04530	KEGG Pathway	Tight junction	4	9.3	-3.63	-2.29
■■■■■	GO:0031333	GO Biological Processes	negative regulation of protein complex assembly	4	7.02	-3.38	-2.07

^a The colour code used to distinguish the protein lists among the five animal categories are in the following order ■ Bulls; ■ Bulls + Steers; ■ Cows; ■ Heifers and ■ Steers, where the term is found statistically significant, *i.e.*, multiple colours indicate a pathway/process that is shared across multiple lists.

^b The number of protein names from the shortlisted 64 putative protein biomarkers of beef tenderness with membership in the given ontology term.

^c Percentage of protein among the shortlisted 64 putative protein biomarkers of beef tenderness that are found in the given ontology term (only input genes with at least one ontology term annotation are included in the calculation).

^d The *p*-value in log base 10.

^e The multi-test adjusted *p*-value in log base 10. An adjusted (Benjamini–Hochberg corrected) *p*-value < 0.05 was considered as the threshold for statistical significance.

Table 3. List of the Quantitative trait loci (QTL) of beef tenderness (sensory and shear force) and their chromosomes (Chr.) from the list of the 64 putative protein biomarkers with cut-off ≥ 2 .

QTL linked to QTLdb ^a	Gene Name (# of identification) ^b	Full protein Name	Biological process	UniProt ID (bovine)	Chromosome ^c
Tenderness score (n = 4)	VDAC2 (2)	Voltage-dependent anion-selective channel protein 2	Ion transport (Calcium) and apoptosis	<u>P68002</u>	Chr.28
	GSTP1 (2)	Glutathione S-transferase P	Glutathione metabolic process and oxidative stress	<u>P28801</u>	Chr.29
	TNNT3 (10)	Troponin T, fast skeletal muscle	Muscle contraction, structure	<u>Q8MKI1</u>	Chr.29
	PYGM ^d (3)	Glycogen phosphorylase, muscle form	Energy metabolism	<u>P79334</u>	Chr.29
Shear force (n = 15)	PYGM ^d (3)	Glycogen phosphorylase, muscle form	Energy metabolism	<u>P79334</u>	Chr.29
	LDHA (3)	L-lactate dehydrogenase A chain	Energy metabolism	<u>P19858</u>	Chr.29
	CSRP3 (2)	Cysteine and glycine-rich protein 3	Muscle contraction, structure	<u>Q4U0T9</u>	Chr.29
	TNNC1 (4)	Troponin C, slow skeletal and cardiac muscles	Muscle contraction, structure	<u>P63315</u>	Chr.22
	MYL3 (3)	Myosin light chain 3	Muscle contraction, structure	<u>P85100</u>	Chr.22
	UQCRC1 (2)	Cytochrome b-c1 complex subunit 1, mitochondrial	Energy metabolism	<u>P31800</u>	Chr.22
	ATP5F1B (2)	ATP synthase subunit beta, mitochondrial	Energy metabolism	<u>P00829</u>	Chr.5
	MYL6B (3)	Myosin light chain 6B	Muscle contraction, structure	<u>Q148H2</u>	Chr.5
	HSPA9 (6)	Stress-70 protein, mitochondrial	Chaperone: cellular response to unfolded protein	<u>Q3ZCH0</u>	Chr.7
	HSPA8 (6)	Heat shock cognate 71 kDa protein	Chaperone: cellular response to unfolded protein	<u>P19120</u>	Chr.15
	PGM1 (6)	Phosphoglucomutase-1	Energy metabolism	<u>Q08DP0</u>	Chr.3
	ALDH1A1 (2)	Retinal dehydrogenase 1	Oxidation-reduction process and apoptosis	<u>P48644</u>	Chr.8
	CA3 (4)	Carbonic anhydrase 3	Bicarbonate transport & Oxidative stress	<u>Q3SZX4</u>	Chr.14
EEF1A2 (2)	Elongation factor 1- β , p. a 2	Protein biosynthesis and apoptosis	<u>Q32PH8</u>	Chr.13	
MYL2 (3)	Myosin regulatory light chain 2, ventricular/cardiac muscle	Muscle contraction, structure	<u>Q3SZE5</u>	Chr.17	

^a ProteQTL tool included in ProteINSIDE (<http://www.proteinside.org/>) interrogates a public library of published QTL in the Animal QTL Database (<https://www.animalgenome.org/QTLdb/>) that contains cattle QTL and association data curated from published scientific articles.

^b Between brackets are the number of identification of the protein across proteomics-based studies. For example, TNNT3 that is Troponin T, fast skeletal muscle was identified in 10 independent proteomics experiments and considered as a robust biomarker of beef tenderness as it belong to the panel of the 33 shortlisted biomarkers with cut-off ≥ 4 .

^c Eleven chromosomes grouped the 18 proteins (genes) from which 10 were in three chromosomes that are: 5 genes in Chr.29 (GSTP1, TNNT3, PYGM, LDHA and CSRP3), 3 genes in Chr.22 (TNNC1, MYL3 and UQCRC1) and 2 genes in Chr.5 (ATP5F1B and MYL6B).

^d PYGM is the only protein found in the same Chr.29 whatever the tenderness traits (sensory by trained panelists and instrumental method by Warner-Bratzler shear force).

Highlights

- Beef tenderness proteomics studies published during the last decade are gathered and analyzed
- 124 protein biomarkers of beef tenderness were retrieved from 28 independent proteomics experiments
- Protein biomarkers of beef tenderness belong to 6 interconnected biological pathways
- 64 biomarkers were identified with a cut-off ≥ 2 and 33 robust biomarkers were shortlisted with a cut-off ≥ 4
- Muscle structure, energy metabolism and heat stress are the main pathways underpinning beef tenderness

Journal Pre-proof

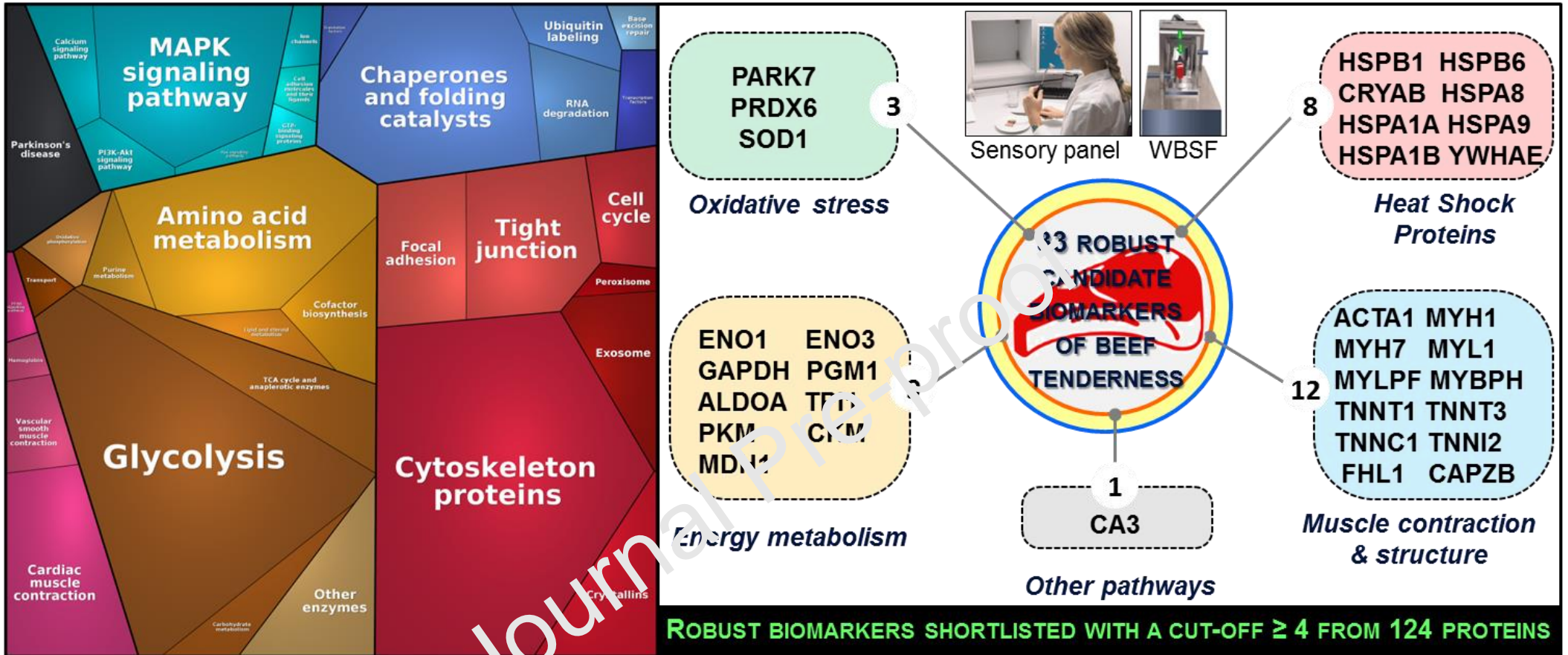

Declaration of competing interest

The authors declared that there is no conflict of interest.

Journal Pre-proof