



HAL
open science

Time as the fourth dimension in the hippocampus

Jean-Paul Banquet, Philippe Gaussier, Nicolas Cuperlier, Vincent Hok,
Etienne Save, Bruno Poucet, Mathias Quoy, Sidney I Wiener

► **To cite this version:**

Jean-Paul Banquet, Philippe Gaussier, Nicolas Cuperlier, Vincent Hok, Etienne Save, et al..
Time as the fourth dimension in the hippocampus. *Progress in Neurobiology*, 2021, pp.101920.
10.1016/j.pneurobio.2020.101920 . hal-03122646

HAL Id: hal-03122646

<https://hal.science/hal-03122646>

Submitted on 12 Oct 2021

HAL is a multi-disciplinary open access archive for the deposit and dissemination of scientific research documents, whether they are published or not. The documents may come from teaching and research institutions in France or abroad, or from public or private research centers.

L'archive ouverte pluridisciplinaire **HAL**, est destinée au dépôt et à la diffusion de documents scientifiques de niveau recherche, publiés ou non, émanant des établissements d'enseignement et de recherche français ou étrangers, des laboratoires publics ou privés.

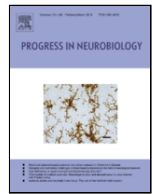

Review article

Time as the fourth dimension in the hippocampus

Jean-Paul Banquet^{a,*}, Philippe Gaussier^a, Nicolas Cuperlier^a, Vincent Hok^b, Etienne Save^b, Bruno Poucet^b, Mathias Quoy^a, Sidney I. Wiener^c

^a ETIS UMR 8051, CY Cergy-Paris Université, ENSEA, CNRS, 2 Avenue Adolphe Chauvin, B.P. 222, F-95000, Cergy-Pontoise, France

^b Laboratory of Cognitive Neurosciences, Aix-Marseille University, CNRS UMR 7291, 3 Place Victor Hugo, CS 80249, 13331 Marseille CEDEX 3, France

^c Center for Interdisciplinary Research in Biology (CIRB), CNRS, INSERM, PSL Research University, Collège de France, 11 Place Marcelin Berthelot, 75005 Paris, France

ARTICLE INFO

Keywords

Hippocampus
Time cells
Prospective/Retrospective coding
Phase precession
Replay/Replay
Transitions

ABSTRACT

Experiences of animal and human beings are structured by the continuity of space and time coupled with the uni-directionality of time. In addition to its pivotal position in spatial processing and navigation, the hippocampal system also plays a central, multiform role in several types of temporal processing. These include timing and sequence learning, at scales ranging from meso-scales of seconds to macro-scales of minutes, hours, days and beyond, encompassing the classical functions of short term memory, working memory, long term memory, and episodic memories (comprised of information about when, what, and where). This review article highlights the principal findings and behavioral contexts of experiments in rats showing: 1) timing: tracking time during delays by hippocampal 'time cells' and during free behavior by hippocampal-afferent lateral entorhinal cortex ramping cells; 2) 'online' sequence processing: activity coding sequences of events during active behavior; 3) 'off-line' sequence replay: during quiescence or sleep, orderly reactivation of neuronal assemblies coding awake sequences. Studies in humans show neurophysiological correlates of episodic memory comparable to awake replay. Neural mechanisms are discussed, including ion channel properties, plateau and ramping potentials, oscillations of excitation and inhibition of population activity, bursts of high amplitude discharges (sharp wave ripples), as well as short and long term synaptic modifications among and within cell assemblies. Specifically conceived neural network models will suggest processes supporting the emergence of scalar properties (Weber's law), and include different classes of feedforward and recurrent network models, with intrinsic hippocampal coding for 'transitions' (sequencing of events or places).

1. Introduction/Overview

Neuroscientists have a long history investigating the processing of temporal information. Such processes include estimations of intervals after a cue, recall of order of previously experienced sequences, various forms of memory, as well as anticipation and preparing the execution of sequences. It is important to distinguish interval timing, which only concerns estimation of time elapsed from a cue or event from working memory, where information is stored over a discrete interval. Note, however, that overlapping neural circuitry could underlie both types of processes, although differences in time scales likely implicate different mechanisms in both cases. These frequently invoke some sort of buffer. A related, but rarely discussed, issue concerns the mechanisms by which the buffers are reset and the related events are forgotten, or, alternatively, consolidated in long term memory (LTM). Seminal work showed the hippocampus' importance for tracking delay intervals (Berger and Thompson, 1978; Meck et al., 1984). However, timing

functions in general are most often attributed to the cerebellar hemispheres or the prefrontal-basal ganglia-thalamic network, both of which the hippocampus is closely associated to (Coull et al., 2011; Doeller et al., 2014). Neural activity underlying timing could include clock-like signals, either as action potentials, rhythmic oscillations of excitability, linear ramping (up or down) of activity, or patterns of peaks or dips of activity over time. These types of activity will be discussed further below in the context of recordings in the hippocampal system (HS) in behaving animals. First, we will present fundamental processes from the micro-time scale of elementary cellular events (on the order of milliseconds and tens of milliseconds), through the meso-time scale (on the order of seconds) and finally the macro-time scales (minutes, hours or days) of behavior. Two inter-related subjects are covered: coding for temporal information such as intervals and sequences, and temporal codes in neuronal activity, such as phase locking to field potential oscillations. While there is a large literature concerning deficits in temporal

* Corresponding author: ETIS UMR 8051, Université de Cergy-Pontoise, ENSEA, CNRS, 2 avenue Adolphe-Chauvin, B.P. 222, F-95000 Cergy-Pontoise, France.

E-mail address: jean-paul.banquet@sorbonne-universite.fr (J-P Banquet)

processing induced by HS inactivation or lesions, this cannot be comprehensively reviewed here.

1.1. Overview of neurophysiological principles of temporal coding in the hippocampus

1.1.1. Micro-time scale

Neurons in the hippocampus and associated structures have certain neurophysiological properties propitious for tracking or representing temporal information. The electrical characteristics of neuronal membranes and their ion channels confer time constants that govern spike generation and maintenance of plateau potentials.

A basic principle of neuronal coding and signal processing is based upon the production of action potentials and the events associated with them. Such 'behavioral correlates' can include responses when the animal is exposed to a sensory cue, is located in a certain place, performs a certain behavior, or some combination of these. Of course, these events occur at specific times, can last for specific durations of time, and may occur as sequences, or within them, and this temporal information and associations can be encoded as well.

Action potentials as well as synchronous activations of multiple neurons (i.e., assembly activations) can signal behavioral correlates via 'rate codes', where the average activation rate corresponds to the intensity of expression of the correlate. This firing rate at a given instant is the reciprocal of recent inter-spike interval(s), and thus can be informative at the micro-scale. A minimal time limit for processing by single neurons is imposed by the refractory period of ~1 ms between successive action potentials. Individual CA3 and CA1 hippocampal neurons can fire as single spikes or as 'complex spikes', that is, a large action potential followed by a train of several progressively smaller ones at short intervals. The implications for coding of these dynamics will not be further explored here, although a complex spike would clearly be expected to more strongly excite downstream neurons than would a single spike.

Alternatively, there are several types of 'temporal codes' where the timing of the spikes encodes information, without necessarily involving a change in firing rate (Huxter et al., 2003). It is important to distinguish between coding by spike timing vs. neuronal coding of temporal information, both of which are discussed in this review. In cases where neurons in a population have different behavioral, and in particular, temporal correlates, computations combining these diverse properties can provide accurate estimates of the behavioral state – these are detected with 'population analyses'. Note however that population analyses often take firing rates averaged over extended periods, losing temporal precision to discern behavioral correlates.

When the collective spiking of a neuronal population occurs within the membrane time constant (10–30 ms) (Koch et al., 1996) of downstream 'reader' neurons, it can be integrated by the readers to code the coincident firing as a single event (Buzsáki, 2010).

1.1.2. Meso- and macro-time scales: brain rhythms

Another form of temporal coding in the hippocampus (and elsewhere) is based upon the relation between spikes and the phase of cerebral oscillations of excitation and inhibition of large populations of neurons (so-called 'brain waves'). These oscillations appear at the levels of individual cells, local circuits, and at progressively larger scales. Theta oscillations (4–10 Hz in rodents) and gamma rhythmic oscillations (30–130 Hz) play an important role in the organization of hippocampal activity (see Colgin, 2013, and Jensen and Colgin, 2007, for reviews). The hippocampal theta rhythm occurs during exploration or navigation, and also during quiet alertness. This rhythm plays two complementary functions elaborated in this review. First, it provides a scaffold for sequencing place- and event-coding cells and cell assemblies within the theta phase space. Second, by providing cycles of exci-

tation and inhibition, it synchronizes these sequentially activated cells within a time window propitious for synaptic plasticity, thus favoring the representation of sequences of events.

Indeed, hippocampal NMDA receptors (NMDARs) are instrumental for synaptic plasticity and learning (reviewed by Morris, 2013). The NMDAR is a non-specific cation channel (i.e., permitting Ca^{2+} and Na^+ influx, and K^+ efflux). This increased intracellular Ca^{2+} concentration acts as a second messenger in various signaling pathways leading to synaptic plasticity. At resting membrane potential, the NMDA receptor cation channel is blocked by Mg^{2+} . To unblock this, the postsynaptic cell must already be depolarized for a certain period of time (due to other synaptic inputs). Thus, the NMDA receptor has been called a "molecular coincidence detector", and is thus crucial for temporal processing at the cellular level. An informative experimental model for formation of NMDAR-dependent memory traces is Long-Term Potentiation (LTP), where repeated stimulation leads to enhanced neural synaptic responses over extended periods of time. A related important property that can be derived from NMDAR binding is spike time dependent plasticity (STDP), which is preferentially induced when a presynaptic cell fires in a particular time window relative to postsynaptic cell firing (Bi and Poo, 1998). These properties are crucial building blocks for neural processing underlying temporal processing at the meso- and macro- time scales. In this review, we explore how network phenomena such as variations in population activity, oscillations and synchronization between neural activations could result from bridging the micro-, meso-, and macro-time scales.

1.2. Fundamental theories of temporal processing

Modern experimental techniques ranging from large scale, extra-cellular ensemble recordings, calcium imaging, and optogenetic manipulations of neuronal firing in animals, to fMRI in humans suggest a distributed representation of time, redundant in multiple, independent systems across the brain. Time coding may emerge as a byproduct of event processing in neural populations. The early models of Scalar Timing (Gibbon, 1977; Gibbon et al., 1984) and the corresponding internal clock model proposed the scalar invariance property, i.e., variance in the timing signal is proportional to the timing magnitude, thus conforming to the Weber-Fechner law. We will see that this property is maintained in various timing signals in the hippocampus.

New models emphasize a neural population approach to timing, as already employed in several domains of cognitive processing. In this distributed representation, time is encoded across a set of interval timers corresponding to a population of neurons with different time constants that each present a peak response at a different latency after a start signal. Learning consists of identifying those responses corresponding to the end of the interval. The spectral timing models (Grossberg and Merrill, 1992, 1996; Grossberg and Schmajuk, 1989; Section 2.4.1) were originally designed to emulate trace classical conditioning (where an interval separates the onset of conditioned and unconditioned stimuli), and may be incarnated in part by the time cells discussed in Section 2.2. Hippocampal implementation of the spectral timing model is described in Section 2.4.2. Various models of trace conditioning in the HS are critically reviewed in Kryukov, 2012) and combined into a unified model. Some related models use a population of oscillators at different frequencies, eventually harmonically related, converging onto striatal neurons (Catalin et al., 2009; Matell et al., 2003; Miall, 1989).

1.3. Hippocampal processing of temporal information

The distributed cognitive processing network devoted to time evaluation is proposed to involve neural assemblies within brain structures including the hippocampal system (HS), cerebellum and prefrontal cor-

tex (PFC) in particular. Here, the HS is considered to include dentate gyrus (DG), hippocampus proper (CA1, CA2 and CA3), and parahippocampal regions (including entorhinal cortex, EC, and subiculum). The HS operates in the broad range from micro- to macro-time scales and is therefore well suited for interfacing neural representations of experience, for memory and behavioral implementation.

HS architecture comprises a cascading network suited to rapidly encoding sequences and coincidences between complex cortical signals, under the modulation of motivational signals (Banquet et al., 1997, 2005; Gaussier et al., 2002, 2019; Hirel et al., 2013). The HS, through its capacity to bridge temporal intervals separating events (Wallenstein et al., 1998), could thus form the building blocks of memories of sequences. From many decades of clinical and experimental observations, the HS is widely accepted as essential for learning and recalling unique sequences of events (episodic memory) after brief and long intervals. While there are some variations in the types of observations that can be made in humans and in experimental animal models, strong evidence suggests similarities in the mechanisms of HS processing of temporal information across species.

Most recordings of neural activity in behaving animals or humans concern processes that are inseparably temporal and spatial. The rodent literature primarily focuses on spatial orienting and navigation although, in a few paradigms, processing of time is fully dissociated from that of space. The capacity to navigate requires self-localization, but also information on the relative position of desired goals and the (shortest and safest) routes leading to these goals. Many hippocampal pyramidal cells discharge selectively at particular locations in the environment and were thus named place cells (PCs) (O'Keefe and Dostrovsky, 1971). These cells are implicated in learning sequences of adjacent locations and, more generally, maps and goal locations, thus contributing to a global navigation system. Here we will concentrate more on the temporal and sequential aspects of spatial-temporal processing, and finally will present an alternative framework to interpret temporal-spatial activity in terms of transitions.

In order to illustrate how the HS is integral to and exploits different types of temporal and sequence processing, this review will present findings from recording studies in behaving animals involving: first, timing, i.e., tracking time during delays by hippocampal 'time cells' and during free behavior by hippocampal-afferent lateral entorhinal cortex (LEC) ramping cells; second 'online' sequence processing: activity coding sequences of events during active behavior; third, 'off-line' sequence replay: during quiescence or sleep, orderly reactivation of neuronal assemblies coding awake sequences; and also studies in humans showing comparable neurophysiological correlates of episodic memory (Table 1). Mathematical models specifically designed to account for these results will be examined to shed light on the underlying mechanisms. We will expose elements of a model of HS (Banquet et al., 1997, 2005; Gaussier et al., 2002; Hirel et al., 2013) relevant to timing and sequence processing in the HS.

2. Timing during delays and active behavior

Three apparently different types of rodent HS activity will be reviewed here, either at the levels of single cells, or groups of cells. Firstly, early reports showed that, after learning, some CA1 neurons fired maximally at a latency corresponding to the end of an interval, during trace conditioning or in a continuous navigation task. Secondly, during delays within a structured task, individual neurons in the HS, referred to as time cells, show spiking activity at specific parts of temporal intervals. The population displays a succession of phasic activations referred to here as 'tiling' (like overlapping shingles on a roof), and this activity spans the entire duration of the delay. Typically, (except for trace conditioning), the animal is not motivated to track the interval in order to perform the task, since the interval is indicated by

salient cues like tones, closure and opening of barriers, etc. In such cases neural coding of timing may be another way of tracking current context (just as place cell activity is observed in situations not requiring navigation). Yet, these tasks do require recall of previous events or actions, and/or anticipation of future decisions. Finally, more recently, Tsao et al. (2018) showed evidence, during foraging behavior, for LEC cells with firing rates ramping over time, 'inherently' coding time at a very large range of time scales, from seconds to hours. These signals could then be integrated in downstream hippocampal structures, to track time and encode the order of events.

2.1. Evidence for interval encoding by hippocampal neurons

Several studies of classical conditioning demonstrated that an intact HS was necessary to learn that a tone (the conditioned stimulus, CS) predicts an aversive stimulus (the unconditioned stimulus, UCS, an airpuff or a mild shock), but only when a trace interval separated these stimuli (trace conditioning). The HS was not necessary when there was no trace interval (McEchron et al., 1998, 2000; Solomon et al., 1986). After trace conditioning, in CS-alone retention trials (no UCS delivered), rabbit hippocampal CA1 neurons fired at the end of the previously trained intervals, i.e., 10 or 20 s after the CS (McEchron et al., 2003). This encoding of the trace duration shared a similar time course with the expression of the heart rate (HR) response associated with the fear conditioning. Additionally, learning-related changes in CA1 activity have been described during eyeblink conditioning (Berger and Thompson, 1978; McEchron and Disterhoft, 1997).

More recently, in a calcium imaging study in mice, with a much larger sample of neurons, Modi et al. (2014) observed stimulus-locked response of CA1 cells prior to trace conditioning. As the animals learned, groups of time cells progressively emerged and became activated at successive times in the trace interval, effectively tiling the entire period between CS and UCS. Noise correlation (trial-by-trial correlations in spontaneous activity), an indicator of functional connectivity, transiently increased during the training session, especially between similarly time-tuned neurons.

In a continuous navigation task combining goal navigation, timing and foraging, dorsal CA1 pyramidal cells showed an anticipatory buildup of activity tracking time. Rats foraging in a circular arena had to wait 2 s in an unmarked 'goal' zone in order to trigger release of a food pellet from an overhead dispenser (Hok et al., 2005, 2007). Most hippocampal place cells increased their 'out-of-field' firing rate during the waiting period in the goal zone. The activity reached a peak anticipating the end of the 2 s waiting period (Fig. 1). Note that similar goal zone responses also occur in downstream medial prefrontal cortex (mPFC), but these are suppressed by ventral hippocampal lesions (Burton et al., 2009). However mPFC lesions did not affect hippocampal goal zone delay activity or its activity profile (Hok et al., 2013). This indicates that mPFC neurons are dependent on the HS for this timing function, but not the reverse.

2.2. Time cell tiling activity during delay periods

Hippocampal neurons can fire continuously within intervals occurring along a delay period, with overlapping tiling of the activity of different cells. This may be an example of a more general property of hippocampal neurons firing in repeated sequences (discussed in Section 4.1; Buzsáki and Tingley, 2018). Such cells have been recorded in the HS during delays imposed in memory tasks. The cells are referred to as 'time cells', and the periods when they fire have been referred to as 'time fields', inspired by the place cell nomenclature (Eichenbaum, 2017).

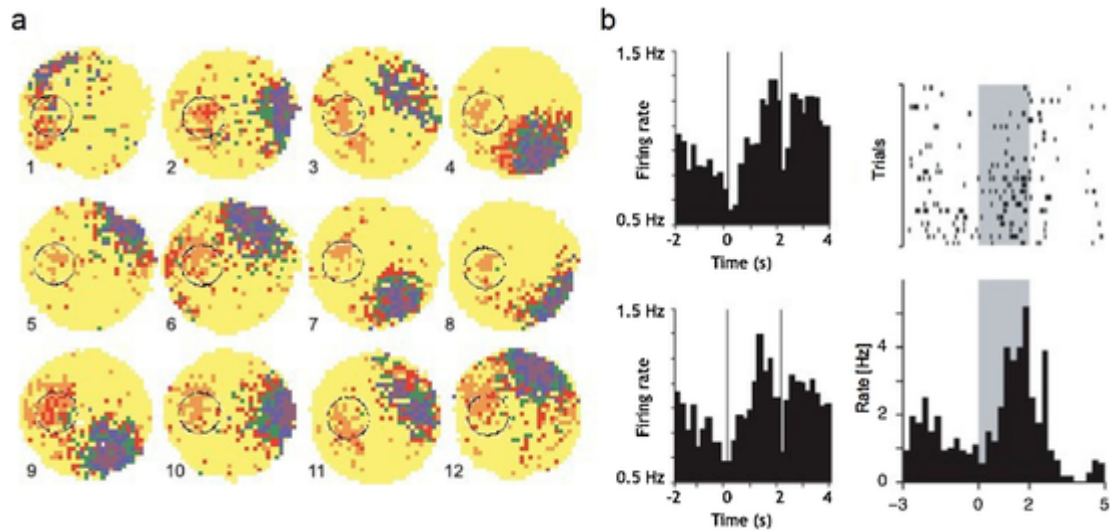

Fig. 1. Secondary field cell activity in the goal zone in hippocampal dorsal CA1 neurons. Dark purple, red, and yellow squares represent maximal, intermediate and minimal activity respectively. a) Spatial responses of 12 goal-zone responsive place cells. The green dashed circles mark the goal zone. (b) Left) Cumulative PETHs for all recorded hippocampal neurons synchronized with arrival in the goal zone. Upper histogram is for extinction trials and lower histogram is for rewarded trials. Right) Raster plot (upper) and PETH (lower) for a representative mPFC neuron. Adapted from Hok et al. (2007) and Burton et al. (2009) with permission.

2.2.1. CA1 time cells

In a seminal experiment, single hippocampal CA1 neurons were recorded as rats alternated right and left turns on a figure-8 maze. The rats had been trained to run on a running wheel for 10 or 20 s before entering the central arm leading to the choice point (Pastalkova et al., 2008). Different neurons successively fired for durations on the order of seconds during wheel running (Fig. 2). The entire run periods were spanned by tiling neuronal activations. The neuron firing sequences were different in trials when the rat turned right or left. When the rats were tested in a control task with no memory requirement, this activity disappeared. Furthermore, this time cell activity displayed phase precession relative to the theta rhythm, as do place cells (discussed in Section 3.2).

In another experiment with a comparable paradigm, a treadmill was placed in the stem of a figure-8 maze and dorsal CA1 neurons were recorded during a delay period before each alternation trial. The treadmill forced the animals to run at varying speeds (Kraus et al., 2013) permitting dissociation of neural activity responses to time elapsed, to distance run, or both. Most neurons were simultaneously influenced by both distance traveled and time, but some were significantly influenced by only one of the two.

MacDonald et al. (2011) trained rats performing an object-odor matching task with a 10 s delay between sampling and response. Like Pastalkova et al. (2008), they observed time cells with their collective activity spanning the delay period. When the delay duration was changed, 37 % of the neurons still fired at the same absolute delay, 6% rescaled their timing to the new interval, while others changed their re-

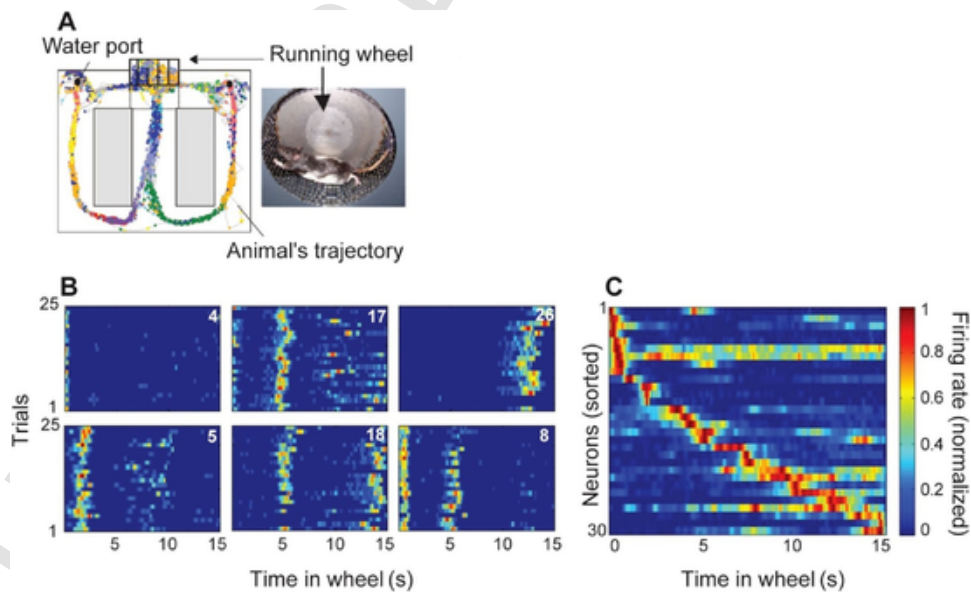

Fig. 2. Time fields during wheel running during delays in an alternation task. (A) The Fig. 8 maze with running wheel. Color-coded dots represent spike activity of respective CA1 place cells on the maze. B) Normalized firing rate of six simultaneously recorded neurons during wheel running (each line shows the color rasters of activity on a single trial when the left arm was chosen). The color scales are linear with the maximum value inset at the upper right. The time cells' activities occurred at specific delays after the start of the wheel run. (C) Normalized firing rate of 30 simultaneously recorded time cells during wheel running, ordered by the latency of their peak firing rate. Adapted from Pastalkova et al. (2008) with permission.

sponses completely. The latter was referred to as 'retiming', analogous to remapping, where place cells completely change their positional responses when the rodent is transferred between two different environments. MacDonald et al. (2011) also noted that other neurons were selectively active during different times during the sampling and choice periods of the task, with other spatial and odor correlates appearing as well.

In the same vein, CA1 time cells were recorded in head-fixed rats in performing a delayed matching to sample task (MacDonald et al., 2013). There, distinct time cell firing sequences were associated with the target odor during the delays after the sampling. These sequences predicted performance accuracy. This supports a role for these activations in working memory (WM), keeping a trace of what happened when.

In another non-spatial task, a pre-trained sequence of five odors was presented; in the test phase, rats had to report the relative order of two of the odors (Shahbaba et al., 2019). Time cells spanned the presentations of the respective odors (as well as the delays afterwards). The populations changed their order of firing for each successive odor, but for each odor they maintained the same orderly sequence of activations between trials. Statistical tools developed by the authors showed selectivity for odor identity and order, and provided the most accurate estimates for correct trials.

These characteristics of time cells suggest similar fundamental mechanisms for processing of spatial and temporal context of behavioral events. Indeed, in rats shuttling between the center and the four corners of a square arena, individual hippocampal CA1 neurons fired selectively at equivalent points along two or more of these trajectories (Wiener et al., 1995; Wiener, 1996). This was interpreted to support the view that, "hippocampal neuronal discharge correlates represent the spatial and temporal organization of the environment as well as of the behavior of the rat. These elements would be partitioned from information abstracted along one or more systems of categorization or 'information domains': the physical structure of the environment and of sensory stimuli, regularities in the behavioral exigencies of the current situation. Order, patterns and structure, both spatial and temporal, appear to have been extracted, abstracted and re-differentiated into subsidiary elements which are represented individually, or recombined as conjunctions, in discharges of single hippocampal CA3 and CA1 neurons."

Another study (Gill et al., 2011) recorded hippocampal CA1 neurons during the delay period between trials of a plus maze task. In different blocks of trials, the rats had to go to either the East or West arms (after starting in the North or South arms). During the delays between trials, distinct episode fields emerged in the first training session and continued developing over sessions. The time cells' sequences were specific to the respective goal arm selected after the delay (East or West), regardless of the start arm for the trajectory. The gradual development of these responses paralleling learning, and specificity for the goal, but not the trajectory, are both consistent with participation in a WM trace. Indeed, such coding of impending choice during delays by serial activation of time cells shows that the HS can encode certain parameters relevant for successful task performance. However, there are counter-examples where hippocampal system spatial representations are not consistent with behavioral choices (Golob et al., 2001; Lenck-Santini et al., 2001). In the latter cases, the HS can be considered to provide a representation of current context which may or may not be engaged in decision making. It remains to be seen whether the episode fields' correlation with behavioral choice is generated in the HS, or elsewhere, or both. Indeed, some regions of the mPFC (directly connected to HS) are also capable of representing parameters related to task performance.

2.2.2. CA3 time cells

More recently, Salz et al. (2016) observed time cell responses in rats during a delay period in a memory task (as did Sabariego et al., 2019). There was a similar prevalence in both CA1 and CA3. However, here, this activity persisted when the memory requirement was removed from the task. The authors suggest that this difference from the results of Pastalkova et al. (2008) was due to the latter's control task bearing a low level of "fixed temporal structure of events within trials". This would be consistent with the hippocampus representing temporal (and spatial) structure in the environment, when present, and one's interactions with it. Furthermore, Pastalkova et al. (2008) hypothesized that information about choice behavior is reflected in sequences on the running wheel. However, Sabariego et al. (2019) found that MEC lesions spared time cell activity in CA1, but led to working memory deficits in a delayed alternation task. The deficits were milder than those seen after lesions of both MEC and hippocampus, suggesting that MEC inputs contribute to, but may not be as crucial as hippocampus for working memory in this task.

2.2.3. MEC and temporal processing

Tiling representations of elapsed time during immobility were also found in mouse MEC cells (Heys and Dombeck, 2018). These were anatomically clustered separately from cells selective for places during locomotion.

Another type of temporal processing in MEC concerns cells selective for locomotion speed. These responses vary according to cell type and layer, with layer II CA1-projecting pyramidal cells representing upcoming speed (i.e., prospectively), while in CA1 and MEC layers III and V, speed responses are retrospective (Iwase et al., 2020). Indeed, speed signals could be path integrated over time to give rise to position signals, perhaps via mechanisms involving summation of plateau potentials, or a theta rhythm based clock (Navrátilová and McNaughton, 2014). The elaboration of grid cell activity in MEC would benefit from such a mechanism (Gaussier et al., 2007, 2019; Gil et al., 2018). However, the engagement of a time signal for carrying out such integration has not yet been shown, although LEC ramping signals could participate (Section 2.3).

Indeed, in rats running on a treadmill in the central arm of a Fig. 8 maze, MEC grid cells (and other cells on the same electrodes) fired as a function of both time and distance after the start of the run (Kraus et al., 2015). But unlike free running (with changing visual cues), occasionally there were two peaks and the second field on the treadmill runs were consistently longer in duration and spatial extent than the first one, consistent with scalar invariance.

2.2.4. Time cells in structures related to the hippocampal system

Cells of primate striatum and prefrontal cortex fire selectively at various times in meso-time intervals between events in a visual tracking task with no memory requirement. The same neurons fired sequentially for short and long intervals. These were referred to as 'time stamp' responses (Jin et al., 2009). The authors found that a perceptron decoder of population response data could accurately report all times in the task with 50 ms precision. Other studies have also reported time cells in the striatum (Adler et al., 2012; Akhlaghpour et al., 2016; Mello et al., 2015). In monkeys performing a delayed match-to-category task, sequential activations of prefrontal cortical time cells encoded the respective stimuli and elapsed time (Tiganj et al., 2018). In rodent prefrontal cortex, time cells firing during a delay represent 10 % of the population (Tiganj et al., 2017). In all of these cases, time field durations increased over the delay, as found with scalar invariance.

2.2.5. Time cell coding at macro-time scales

Finally, time cell activity does not seem limited to encoding on meso-time scales. In a calcium imaging study, CA1 tiling responses were observed over a 10 s delay, and these also gradually changed over longer time periods. These changes could serve as time stamps (Mau et al., 2018). Indeed, sequences bear some similarities over several days, but the neurons in the sequences change over time. Thus, time cells could code information over delays of both seconds and days. The authors suggest that a possible mechanism for changes in time cell activity over minutes and days would involve endogenous cycling of cyclic AMP (cAMP) response element-binding protein (CREB). The simultaneous observation of these two scales of variations is important in light of numerous behavioral studies showing meso- and macro-time scale memory functions of the HS.

2.3. Sustained ramping activity at different time scales in lateral entorhinal cortex

Tsao et al. (2018) showed ramp-like increases in firing activity in LEC neurons over a wide range of time scales. The animals foraged for twelve 240 s periods in white or black square enclosures, with 120 s inter-period intervals. Ramp-like activity in 20 % of the neurons extended over time scales ranging from seconds to hours, within individual periods or across periods. Bayesian classifiers reliably decoded elapsed time over minutes and days. Structuring the behavior of the animals in a figure-eight maze reduced the incidence of ramping activity across trials within a session, but improved the coding of time relative to the start of trials. This reduction led the authors to conclude that temporal information in LEC is not explicitly clock-like, but rather arises from integration of the amount of change of the animal's moment-to-moment experience. Indeed, the changes across trials can be considered to decrease over identical repetitions.

This could correspond to the transformation of an episodic memory into a procedural memory, independent of the HS. LEC ramping activity could be instrumental in the elaboration of time cell activity, and also the decorrelation/drift of place cell population activity in CA fields over minutes to hours. This is consistent with the finding that MEC lesions do not reduce the incidence of time cells or of prospective/retrospective activity in CA1 (Sabariego et al., 2019; discussed in 3.2). Thus, LEC can provide temporal "scaffolding" in the form of time stamp information for signaling 'When' information for episodic memory at multiple time scales. This could be homologous in the temporal domain to the spatial coordinate system provided by grid cells of the MEC.

2.4. Models of timing

2.4.1. Models with spectral timing

The spectral timing model (Grossberg and Merrill, 1992) was designed to emulate the hippocampal recording data available at that time. It could also account for more recently discovered LEC ramping responses and time cells. In this model, after parallel activation at CS onset, individual cell activities peak at successive delays during the CS-US interval, according to their respective time constants (Fig. 3, top). In the model, the synaptic weights between cells signaling the CS input and these spectral cells develop differently during learning. Indeed, the level of activation of the cells at the time of the unconditioned stimulus (US) signals how much the weights should be modified at these synapses (Fig. 3, middle). The weighted summation of these spectral activities provides a global trace peaking just prior to the delivery of the UCS (Fig. 3, bottom). Time cell activity resembles that of 'spectral cells', although the nature of their time constants is not yet known. This global activity emulates the incremental response of the CA3-CA1 cell population, with maximal firing anticipating the UCS. After learn-

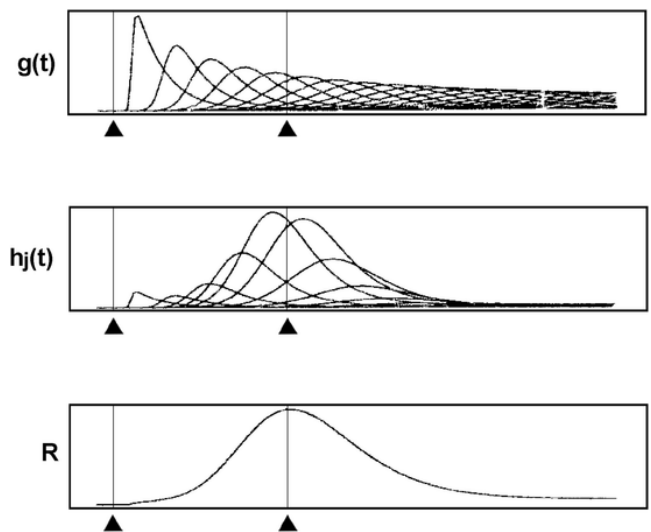

Fig. 3. Properties of the spectral timing model. Spectral timing is a weighted spectral decomposition of a temporal signal by a neural population with activity emerging due to a large spectrum of time constants. The onsets of CS and US are denoted by the vertical lines and arrowheads to the left and right, respectively. The singly gated spectrum $g(t)$ is derived from the product of the input signal and a habituation gate, expressing the cell time constant; the doubly gated spectrum $h_j(t)$ arises from a further gating by the synaptic weights; the corresponding output signal $R(t)$ results from the summation of the differentially weighted inputs. i and j are indices labelling the neural components of the neural network. In the model equations, the sampling signals g_{ij} and the US (expressed via a teaching signal N) conjointly activate adaptive weights, constituting LTM traces, w_{ij} , which generate adaptively gated output signals $h_{ij} = g_{ij} \cdot w_{ij}$. Although individual signals h_{ij} do not time the inter-stimulus interval (ISI) well, the population sum R of the adaptive signals does. Adapted with permission from Grossberg and Merrill (1992).

ing, the presentation of the CS alone reactivates this pattern through the modified synaptic weights.

A continuum of different levels of precision of temporal dynamics could exist along the septo-temporal axis of the hippocampus, comparable to the septal to temporal increase in place field sizes (Jung et al., 1994). Indeed, dorsal hippocampal lesions lead to underestimations of interval duration (Merchant et al., 2013; Tam et al., 2013, 2015), while ventral hippocampal lesions produce temporary overestimation (Yin and Meck, 2014). Oprisan (2018) reproduced this with a model based on the hypothesis of a topological mapping in the hippocampus, where longer durations are stored more dorsally (in rat; septally in primates) while shorter ones are stored ventrally (temporally). However, in the tasks studied to date with meso-time delays, dorsal hippocampal time cells respond at both short and long delays. Perhaps ventral hippocampal neurons have time cell responses at even longer delays.

The observation by Hok et al., 2007 of goal-related out-of-field firing of CA1 place cells and mPFC neurons Hok et al., 2005 was modeled according to the same principle of spectral timing cells, supported by neurons displaying time-sensitive activity, presumably granule cells of DG. This involved a neural network emulating the complex reciprocal relations between HS and mPFC in the rat (Hirel et al., 2013).

2.4.2. The Itskov continuous attractor neural network (CANN)

To explain the results of Pastalkova et al. (2008); Itskov et al. (2011) developed a recurrent network model that belongs to the class of continuous attractor neural networks, with a fixed Mexican hat connectivity among the cells. A 'bump' of neural activity represents the current state (i.e., the animal's position) and can be maintained stable, or travel in the state space of the model under the influence of internal perturbations. The model generates unique sequences of CA1 pyramidal cell assembly activations depending upon the initial conditions, which are noisy, unstructured inputs (corresponding to stationary sensory in-

put). The sequences generated depend also upon the internal state of the network, in the form of post-firing threshold elevation for the neurons contributing to the active 'bump'. The asymmetric modulation of the strength of the recurrent synaptic weights is an alternative mechanism (Zhang, 1996). The network reliably produces the same sequences from the same initial conditions and successfully predicts elapsed time during wheel running. However, most of the patterns of serial activation of cells assemblies in the model do not follow Weber's law. In spite of this, the model presents the remarkable advantage of proposing the same framework as that used for 'externally' generated sequences in response to a succession of external events (cf., Section 4.3), in order to produce 'internally' generated sequences (such as sequentially activated time cells in response to a single trigger event). In the first case, the active and/or hidden internal states play a fundamental role for the sequential activation of cell populations in the network. In the second case, the sequential activation depends on a combination of the external sequence of events and the internal states of the system.

2.4.3. Laplace transform model with leaky integrators

Howard et al. (2014) proposed a model that encodes an integrated representation of spatiotemporal context incorporating all of the aspects of a behavioral episode, a function ascribed to the hippocampus (Eichenbaum et al., 1994; Manns et al., 2007). Both spatial location and time were computed here, but these can be considered as special cases of more general conjunctive processing. The authors posit that as episodes occur over time they are encoded as a Laplace transform of their input in a set of leaky integrators with different time constants. An approximation to the inverse Laplace transform then recovers the encoded information, be it spatial, temporal or conjunctive. This reconstruction provides temporal history and, by integrating movements, can perform path integration. An important requirement is that the rate of change of the respective contextual parameters must be available at all times. Indeed, the intermediate representation changes over time and, crucially, the rate of change of the encoded parameter (position, time) at each moment enables the leaky integrators' activity to be updated accordingly. This represents the hidden variable via path integration. The authors provide support for the leaky integration being carried out in MEC. The model generates activities resembling those of time cells, retrospectively modulated place cells (discussed in Section 3.2), and boundary vector cells (coding for the distance to a boundary of the environment; Lever et al., 2009).

Yet, scale invariance in timing allows an animal to use the same mechanisms to integrate information over different time scales, thus sparing processing resources. Using the same mathematical framework of the Laplace transform, represented by a set of leaky integrators with different time constants, and its approximated inverse (Howard et al., 2014), Liu et al. (2019) conceived a three layer feedforward neural network model. The output layer III neurons present sequentially firing, approximately scale-invariant time cells in response to an input function. The inverse Laplace transform producing this result is implemented in the neural network via the weight matrix W connecting layer II to layer III neurons. The matrix W approximates an off-center/on-surround 'receptive field' of time cells when time constants are densely spaced in layer I neurons. If temporal and visual/spatial information processing share similar principles of maximizing statistical independence or sparsity in perceived patterns, this type of receptive field could reflect adaptation of the mechanism of temporal information processing to statistical properties of the world (Howard, 2018). Layer I neurons are exponentially decaying persistent firing neurons, maintained by the calcium-activated non-specific (CAN) cation current. Simulated neural sequences can be rescaled by adjusting the gain of the layer I neurons receiving the inputs. In contrast, in recurrent neural network models based on a reservoir computing framework (Laje and Buonomano, 2013), rescaling requires learning new sets of weights.

2.4.4. Modelling LEC ramping cells and time cells

A recent neural network model (Rolls and Mills, 2019) combines two networks to account for how LEC ramping cells contribute to hippocampal time cells. First, an integrate-and-fire attractor network includes coupled populations functioning as gated dipoles (Grossberg, 1972), and shows slow temporal ramping of the neuronal firing rates, thanks to synaptic adaptation mechanisms with different time constants. Second, a competitive network, as implemented in DG and CA1 (Banquet et al., 2005; Gaussier et al., 2002), combines slowly ramping cells with different time scales to yield 'orthogonal' discrete time cells in the hippocampus. As an emergent property of the simulations, forward and reverse replay of the sequences are generated. Similar mechanisms have been implemented to transform MEC grid cell activities with different spatial frequencies into hippocampal place cells with different field sizes in the hippocampus (Gaussier et al., 2007, 2019; Solstad et al., 2006).

Up to this point we have essentially considered how activation of single cells or populations could represent elapsed time and/or maintain memories over a delay, and also how time can be inherently tracked during free or constrained behavior, at different time scales, through the ramping activity of LEC cells. In time cells, serial activation of neurons with different time constants results from their reactions to a unique event at the onset of the delay. Yet, in many circumstances during active behavior, a succession of several distinct external events could trigger the successive activation of distinct neural populations. While the temporal order is stored, the precise timing between successive events within these sequences is not necessarily important. An animal can run along the same trajectory at different speeds, and still activate the same sequence of neurons. In the HS, this would successively activate changing, yet overlapping populations of neurons, or cell assemblies.

3. 'Online' timing and sequence coding of behavioral episodes

In most experiments showing time cells, animals were constrained in a small area during a delay imposed by the behavioral task. The sequential activations of neurons were generated internally rather than by the sequential appearance of external stimuli. Delay timing can be considered as a special case of WM where the stored content consists of the behaviors performed: first, before the interval; second, during the interval (e.g., waiting, running in place), and third, at the end of the interval (e.g., continue with the next phase of the task). Thus, these memories concern events of the immediate past, but also anticipation of the imminent future as well. We now consider sequential activation of cell populations in relation to the external changes in sensory cues, spatial position and context during behavior, usually on a background of theta oscillations, which we refer to as 'online'.

3.1. WM and 'online' prospective and retrospective coding on the meso-time scale

HS cell activity reflects current behavioral contingencies and WM on a background of theta oscillations. These occur during active behavior or alertness, i.e., online states, such as mobility during task performance. In contrast, offline activity occurs during delays, pauses, or sleep, and can be related to previous or imminent behaviors (discussed in Section 4).

3.1.1. WM and STM

Short-term memory (STM) briefly stores information. It demonstrates temporal decay and limited chunk (i.e., number of elements) capacity. On the other hand, working memory (WM) is a system that manages and engages STMs for behavior and cognitive function. WM is a temporary buffer of information whose principal properties are the

duration of time the information is to be retained (and thus when to delete it, a crucial process), the amount and the content of information stored. Lisman and Idiart (1995) proposed a model of STM trace storage based upon the modulation of hippocampal gamma oscillations (40 Hz) by the theta rhythm (8 Hz). In this coding scheme (Jensen and Lisman, 1996), the subset of cells that fire during a given gamma cycle (sometimes referred to as a cell assembly or an ensemble) represents a given item. In effect, largely non-overlapping assemblies are sequentially active in successive gamma cycles, i.e., at different theta phases. Given that there are four to eight gamma cycles nested within a theta cycle, multiple items can be represented in a defined order. This would limit STM storage to approximately 7 items.

3.1.2. Prospective and retrospective activity in different paradigms

Online, spatial responses in entorhinal and hippocampal neurons are also modulated by recent (retrospective) (Frank et al., 2000; Wood et al., 2000), or pending (prospective) actions (Ainge et al., 2007). These responses would be of particular interest for solving Markovian decision problems, which involve accumulation of memories of recent events to predict action-outcome contingencies in the imminent future. Frank et al. (2000) demonstrated prospective and retrospective modulation in rats trained to alternate trajectories from a central

start arm to the two lateral goal arms on a m-shaped track, then returning to the center for a new trial. Entorhinal cortical, and CA1 neurons firing rates varied at the same location on the central arm of the maze, depending on which goal arm the rat was going to next (prospective activity) or coming from (retrospective activity). Thus, these 'splitter' cell activities could predict the animals future choice for outbound paths, or reflect the previous choice for inbound paths. Conversely, other cells in deep EC layers fired at different locations of the track corresponding to similar trajectories in terms of orientation and distance traveled, thus encoding path equivalence, i.e., similarities between locations or regularities across spatially distinct trajectories (Fig. 4, third row).

Comparable results were found in a T-maze with return arms (thus with a figure-8 topology), when rats were trained to alternate right and left goal arms (Wood et al., 2000). Two-thirds of the hippocampal CA1 pyramidal cells fired differentially on the common stem for the left turn trials vs. right turn trials.

Several experiments have demonstrated prospective and retrospective activity when rats perform a spatial win-stay task in a plus maze (e.g., Ferbinteanu and Shapiro, 2003). The start arm varies pseudo-randomly from North to South in successive series of trials, whereas the rewarded arm remains constant (e.g., East) until the rat performs

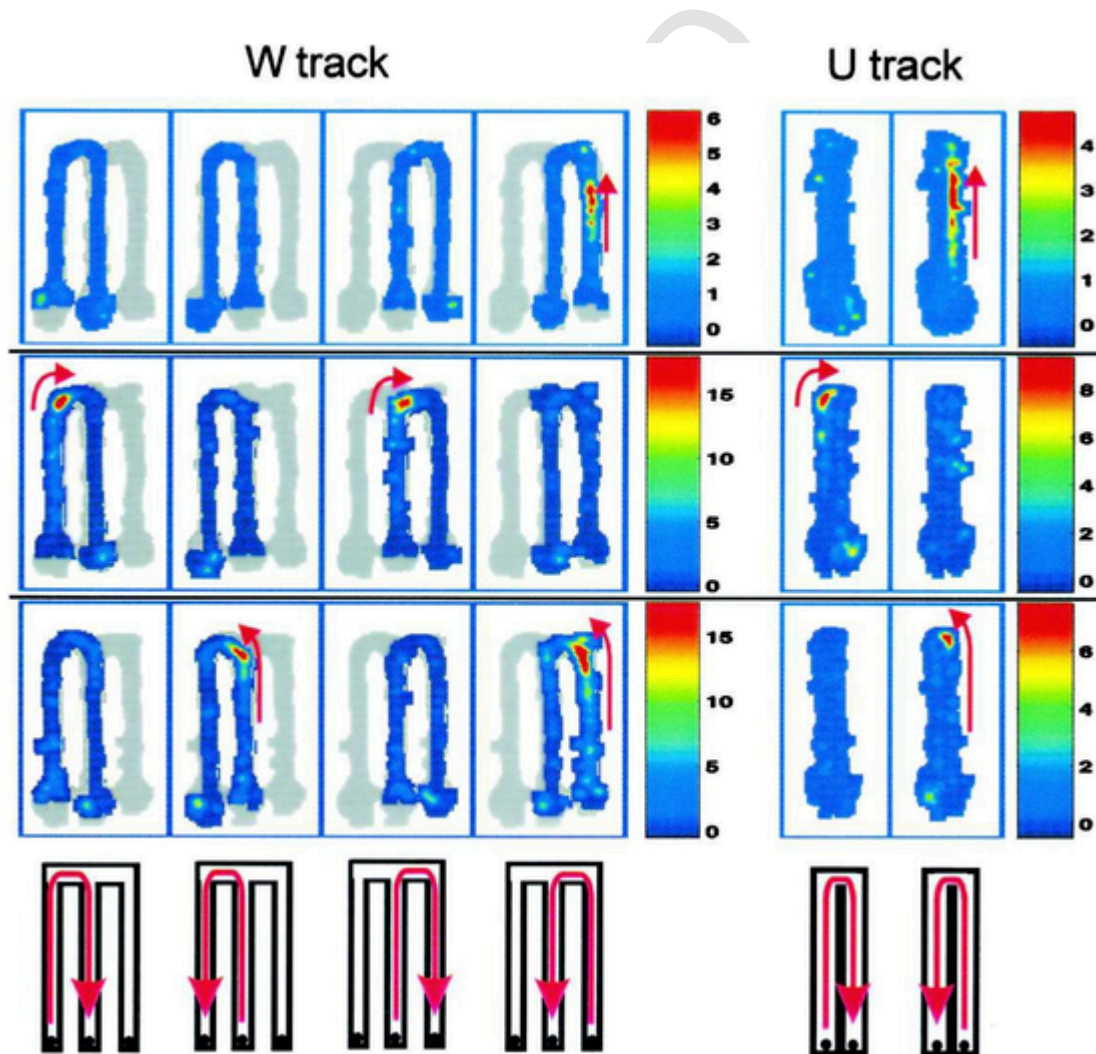

Fig. 4. Position of an animal running between food wells on a m-shaped track was coded as distances from food wells at the beginning of each path. Four paths (bottom) were explored. Firing rate maps by path are shown for representative neurons from each region. Color scales are in spikes/s. The top row shows a superficial EC cell, the second row a CA1 cell, and the third row, a deep EC cell. The color map indicates the firing rate. The section of the maze the animal did not traverse on a given path is shown in light gray. HS appears to represent the animal's position through each trajectory. EC, deep EC in particular, seems to represent regularities across different trajectories, suggesting a generalization across experiences. Adapted from Frank et al. (2000), with permission.

consecutive correct trials, and then the reward is shifted to the opposite goal arm (i.e., West). Activity was compared in overlapping path segments either on the start arms with different destinations or on the goal arms after leaving from different starting points, to reveal prospective or retrospective activities respectively (Fig. 6). In this example, during prospective coding, the cell fired more in the South arm for trajectories terminating in the East rather than West arm. During retrospective coding, in this example the cell fired more in the East goal arm when coming from the North arm than from the South arm.

Even in a continuous alternation task, there is evidence for at least partial modulation of prospective firing by goal location. On the stem of a T-maze, place fields of prospective cells shift gradually forward towards the goal across trials, while place fields of non-prospective cells remain stationary (Lee et al., 2006). The dramatic reduction of prospective activity on error trials suggests that it supports correct choices (Ferbinteanu and Shapiro, 2003). Furthermore, such responses appear during a goal-directed task requiring decision-making, but not during random foraging (Smith and Mizumori, 2006). Note also that in some studies, prospective activity is rare or not observed at all (Bower et al., 2005) for as yet undetermined reasons (Ainge et al., 2007).

In general, retrospective and prospective modulations of hippocampal place responses involve events on the order of hundreds of ms and seconds in the recent past or imminent future. Catanese et al. (2014) recorded in the dorsal CA1 region of the rat hippocampus in the T-maze with return arms, and provided evidence supporting a role for prospective and retrospective modulations as temporary memory buffers of recent experience and imminent behavior, rather than constituting activity within distinct maps for the two paths. In effect, retrospectively modulated fields are concentrated at early parts of the central stem, while prospective ones are near the end, although they do overlap (Fig. 5). These buffers could be engaged for representing ongoing behavior in the broader context of a trajectory. Interestingly, retrospective modulation is twice more prevalent than prospective responses (Catanese et al., 2014). This echoes the dominance of retrospective representations in delay activity in ensembles of eye-movement directional neurons in the dorsolateral prefrontal cortex of monkey (homolog of rat mPFC) (Funahashi, 2006).

3.1.3. Similarities between HS and neighbor structures in temporal context representation

The similarities between HS and prefrontal cortex in the representation of temporal context could reflect some common principle of representations of past and future events, or shared information between HS and PFC. An exhaustive account of the implication of PFC in temporal processing is out of the scope of this article. Nevertheless, the PFC is strongly involved in working memory and could be crucial for transiently storing and controlling the implementation of these prospective and retrospective modulations in the HS, according to the prevailing context. Hippocampal-prefrontal synchrony is required for spatial working memory, and reuniens and rhomboid (Re/Rh) nuclei of the ventral midline thalamus facilitate bidirectional communication between the dorsal hippocampus and mPFC in a WM task (Griffin, 2015). Trajectory-dependent activity occurs in Re, and Re/Rh inactivation reduces trajectory-dependent activity in hippocampus, indicating that it is transmitted from PFC by Re/Rh (Ito et al., 2015). This provides evidence for a causal role of Re/Rh in regulating hippocampal-prefrontal synchrony and WM-dependent spatial behavior (Hallock et al., 2016).

Trajectory-dependent hippocampal activity does not necessarily support the selection of the appropriate behavior during continuous alternation tasks. Indeed, rats with complete HS lesions can learn and perform continuous spatial alternation (Ainge et al., 2007). However, hippocampal-lesioned rats are significantly impaired if a delay of 2 or

10 s is imposed between alternation trials. This however does not necessarily implicate prospective or retrospective activity. Rather, preplay (presented in Section 4.2), as well as time cell activity, also appear during the delay period, but only if the task requires the rat to make a memory-based choice. The presence of prospective and retrospective activity in tasks not requiring the HS suggests that other associated areas such as mPFC and striatum could be implicated in the functional elaboration of this contextual activity. Depending upon task and learning conditions, in particular stability vs variability in the task demands, the most appropriate control structure would be engaged (Banquet et al., 2016). In this view, the introduction of a delay during the alternation task could disrupt the 'HS-independent' automatic performance of continuous alternation resulting from overtraining, and lead to behavioral control by the HS and/or mPFC, with their working memory processing. But after the onset of a visual cue indicating the future path to take in a T maze, there is a delay exceeding 300 ms before prospective activity appears in hippocampal CA1 neurons (Catanese et al., 2012). This is considerably greater than the latency between motor command signals and movement, e.g., there is only a 150 ms post-stimulus delay between choice predictive activity in superior colliculus and movement in an olfactory-cued choice task (Felsen and Mainen, 2008). For other types of tasks much briefer delays on the order of 100 ms are also observed (Kirchner and Thorpe, 2006). The long delay of the hippocampal responses suggests that hippocampal prospective activity is not implicated in the early stages of trajectory selection. Rather, the decision signals would be transmitted from other structures such as prefrontal areas.

3.2. Sequence compression, phase precession and theta sequences

A likely mechanism for compression of information from the meso- and macro-time scales of behavior to the micro-scale of neural circuit interactions involves the phenomenon of phase precession of cell firing relative to the ongoing theta rhythm (Fig. 7). As a rat enters a place field, the corresponding place cell (population) fires late in the theta cycle. As the animal moves through the place field, the PC fires at progressively earlier phases of the subsequent cycles (O'Keefe and Recce, 1993). This process is repeated as the rat traverses firing fields of other neurons along its trajectory. Hence the activation of neurons whose field was first entered several cycles back takes place at the earliest phases of a given theta cycle. Then follows activity of neurons with fields entered more recently, and finally of the neurons whose fields are just being entered (Fig. 7) and will be traversed next (Skaggs and McNaughton, 1996). Within a single cycle, the order of the represented places corresponds to their order of occurrence during actual behavior. This is called a 'theta sequence' (Foster and Wilson, 2007).

While a theta cycle lasts about 130 ms, the sequence of PC activations it carries is on the order of several seconds of movement, corresponding to the trajectory of the animal in a temporally compressed manner. Some models of phase precession propose a repeated read out of these time-compressed sequences of space in each theta cycle (Jensen and Lisman, 1996) and a phase precession advance of one gamma cycle per theta cycle. The existence of coupling between the power of gamma oscillations and the phase of theta oscillations suggests that gamma activity might divide theta cycles into discrete temporal slots supporting phase coding (Jensen and Colgin, 2007).

The path represented by theta sequences extends farther ahead of the animal's actual position as it accelerates towards (e.g., at the beginning of the maze arm) or leaves landmarks (Gupta et al., 2012), but the fields lag further behind as the animal decelerates while it approaches landmarks or a goal. Forward skewed representations could reflect a predictive recall cued by inputs from impending landmarks supporting anticipation in navigation (Hasselmo, 2009). Conversely,

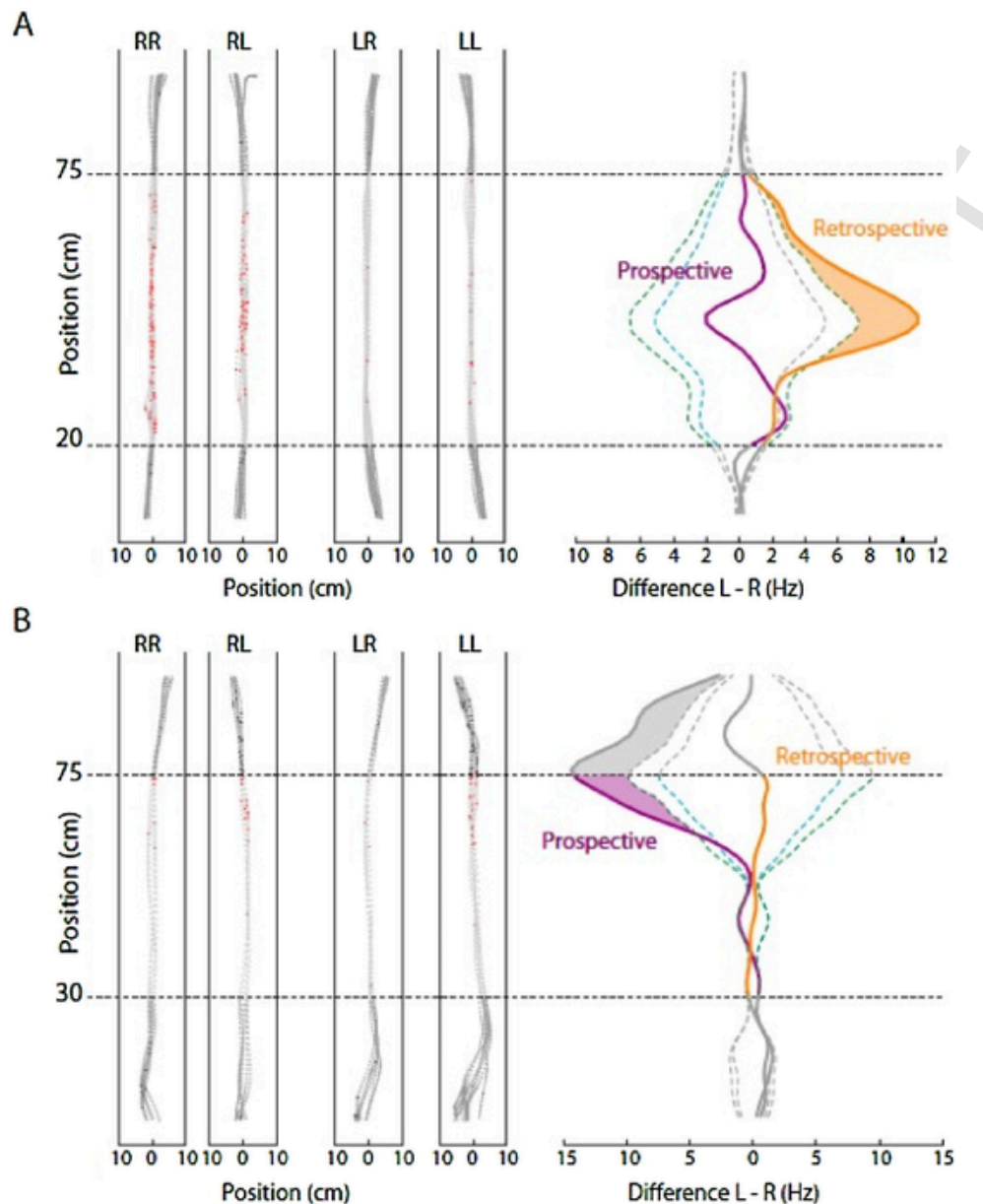

Fig. 5. Examples of trajectory-modulation of CA1 place responses. **A**, Retrospective modulation. Left, Action potentials (red dots) superimposed on position samples of the four types of trajectories (RR, RL, LR, LL) along the central arm of the T-maze with return arms. Gray dots are position samples with no cell activity. Right, Left minus right differences for prospective (purple trace) and retrospective (orange trace) analyses. The inner dashed blue line is the global confidence limit derived from the Monte Carlo bootstrap analysis, and the outer dashed green line is the pointwise confidence limit. The shaded zone corresponds to the significant retrospective activity; the prospective activity is not significant. Horizontal dashed lines delimit the zone where trajectories did not diverge. Data outside this zone is dark gray. **B**, Significant prospective modulation is shaded in purple. Adapted from Catanese et al. (2014), with permission.

backward biased representations could facilitate the encoding of the preceding experience (Buzsáki, 2005).

The phase precession phenomenon is not limited to PCs. In head-fixed rats performing an odor-sound configuration discrimination task, Terada et al. (2017) found that the CA1 neurons had sustained responses to particular cue combinations. The neurons showed transient phase precession (with theta phase sequencing), and this was followed by phase locking later in the trial (Fig. 8). A Bayesian decoder showed that the cue combination conditions for current trials were correctly represented during the descending phases of theta, while the future lever press choice was encoded in the ascending phases. Conversely, in error trials, inaccurate cue combinations were represented on descending theta phases and erroneous choices were represented on ascending phases. In a task where rats sampled two odors in sequence, and re-

sponded about their relative order in a test template sequence of five odors, Shahbaba et al. (2019) found theta sequencing of past, present and future events.

In another non-spatial task, rats learned sequences of five odors and responded for odors presented in or out of order (Allen et al., 2016). Hippocampal CA1 single neurons and ensembles were selective for presentations of odors in sequential order, and others for odors out of order.

Some cells also had conjunctive responses for in (or out of) sequence odors as well as selectivity for odor identity and ordinal position. Others were selective for whether breaking the sequence was due to skipping an odor, or repeating it, regardless of odor identity or ordinal position in the sequence. In this same study, slow gamma (20–40 Hz) power was greater during the odor sampling period, and

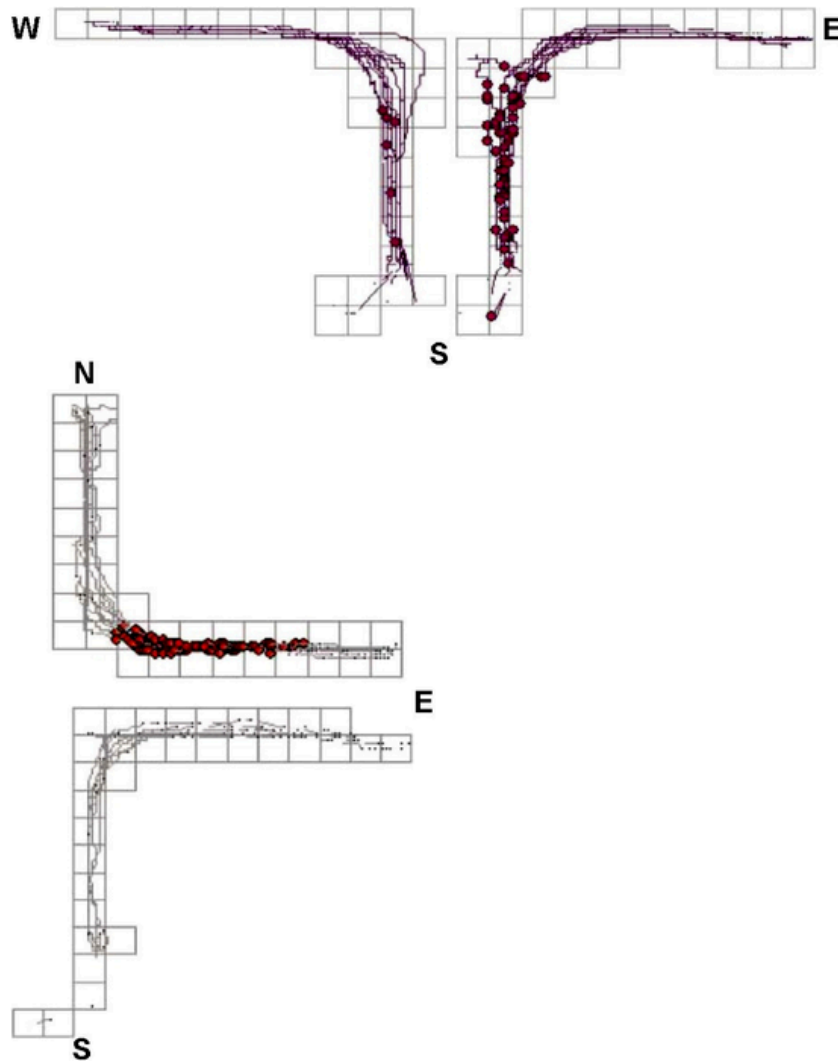

Fig. 6. Above: Journey-dependent fields showing prospective coding in a plus maze. The cell fired (colored circles) reliably in the South arm during correct choices to the East arm but rarely during South to West trajectories. Below: Retrospective coding during North to East rather than South to East journeys. Lines indicate trajectories, and red dots are locations where cells fired in the North to East trajectory. Adapted from Ferbinteanu and Shapiro (2003), with permission.

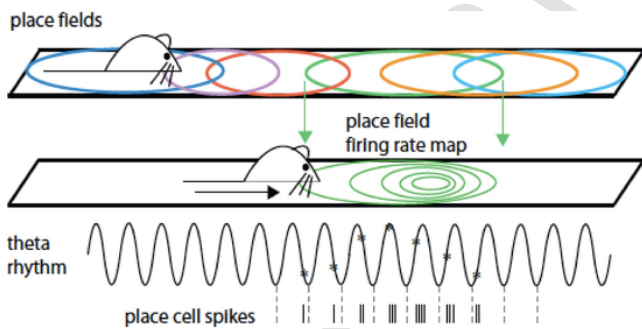

Fig. 7. Theta phase precession. Top) A rat running left to right on a linear track traverses the borders of the spatial firing fields (place fields) of successive hippocampal neurons (place cells). Middle) Activity in the place field indicated in green in A is shown in more detail. As the rat runs through the place field, the firing rate profile is symmetrical in an approximately Gaussian form. Bottom) The precise timing of the spikes relative to the phase of the theta cycle provides a temporal code for the animal's location within the place field. Thus, the first spikes of the cell fire at a late phase of the theta rhythm (indicated by the first asterisk), and each successive burst of spikes occurs at increasingly earlier phases of the rhythm. Cycles are delimited by vertical dashed lines. Adapted from Foster and Knierim, 2012, with permission.

was even higher for odors in the correct sequence than those out of sequence.

Furthermore, the magnitude of slow-gamma modulation CA1 neurons during odor-sampling periods was significantly correlated with performance across sessions. These gamma results were not significant when tested for theta, although theta power did have a greater magnitude prior to odor sampling.

Thus sequences of both spatial and non-spatial information can appear in a temporal code involving the sequential activation of neurons with identified properties at successive phases of the theta cycle. But the Allen et al. (2016) study also shows that sequence information can be rate coded as well. Furthermore, gamma is likely involved in mechanisms underlying the processing of sequence information as well.

3.3. Stimulus order and temporal representation by gradually changing neural populations

3.3.1. Population coding of stimulus order

A few experiments have explored how changes in hippocampal neuronal ensemble activity could support memory of the order of successive events. Rats experienced unique sequences of five odors, and in a test phase only two of these odors were presented. The rats were re-

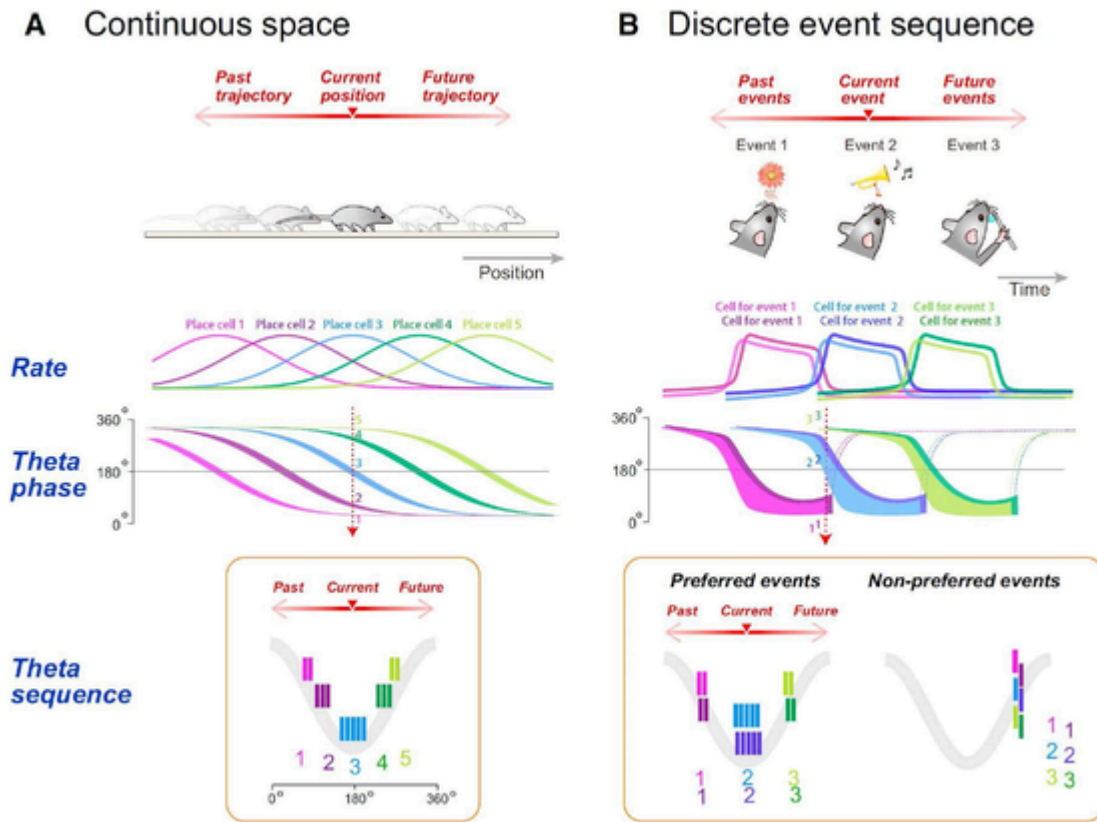

Fig. 8. Temporal coding via phase precession and theta sequences for positions (A) and events (B). A) As in Dragoi and Buzsáki, 2006, place cells fire as the animal's trajectory covers the corresponding place fields. Since the theta phase of each cell's spikes advance to earlier phases on each theta cycle, at the current position their firing in respective phases indicates past, present and future positions. B) In the case of sequential non-spatial events consisting of a cue light, a cue sound and a reward, Terada et al. (2017) observed cells with selective activation for combinations of the cue identities and a left or right lever choice, but lower activation for other combinations. The cells preferentially active for the successive events also fire sequentially at earlier phases on each theta cycle. At the time of the current event, their theta phase represents past, present and future events, but for the cell's 'preferred' events only. Reproduced with permission from Terada et al. (2017).

warded for selecting the odor that had been presented first (Manns et al., 2007). Contextual representations were operationally defined as the activity of groups of simultaneously recorded neurons active from 1 s before to 3 s after each sniffing bout. These were represented as population vectors and activations were compared with a distance index. The patterns of activity of these groups gradually evolved during odor sampling. They predicted accurate recall in the probe tests of memory for the order of the odors, and their absence was correlated with erroneous choices. These trial-unique sequences of neuron ensemble activations also depended on spatial contexts, and varied among different locations where the odor stimuli were presented.

As evoked above, Allen et al. (2016) also showed hippocampal ensemble coding for odor sequences. This demonstrates the importance of temporal context in trial classification within the hippocampus. Ginther et al. (2011) presented rats with two series of odors with an overlapping subsequence in the middle, e.g., sequence 1 was MN ABC OP while sequence 2 was WX ABC YZ, with letters representing different odors. Some hippocampal neurons fired differentially during the two presentations of the overlapping sequence ABC, reflecting a coding of temporal context, comparable to the spatially prospective and retrospective modulation presented above.

3.3.2. Timing by gradual changes and drift in neural populations

The hippocampal neural representation of different temporal contexts can also extend over periods of time longer than the usual duration of an experimental session. Several studies have shown that neuronal firing in the hippocampus fluctuates over hours and days. These fluctuations may concern their level of activity or the set of neurons

participating to these populations. Variations of place cell responses over the course of many hours of recordings were first observed by Ludvig (1999). Manns et al. (2007) found that the population vectors of CA1 neurons during odor sampling were more similar for the same trial types closer together in time than those with greater delays between them. The authors suggest that this is an example of tracking time through gradual changes in network states (Estes, 1955; Karmarkar and Buonomano, 2007). Indeed, estimates of elapsed time, and performance in sequence memory tasks can be predicted by activity changes over time in the HS (humans: Ezzyat and Davachi, 2014; Hsieh et al., 2014; rats: Manns et al., 2007). In rats foraging in circular and square enclosures, monotonic decreases in similarity in spatial responses at the levels of individual cells and populations over 6 and 24 h were observed in CA1 (Mankin et al., 2012), while CA3 neurons remained unchanged. Mankin et al. (2012) compared CA1, CA2 and CA3 population responses in rats in square and circular enclosures. In repeated recordings over two days they found that CA2 was the area with the most pronounced changes in its population code, even over intervals of hours (Mankin et al., 2015).

Ziv et al. (2013) performed calcium imaging on hundreds of CA1 neurons in mice running on a linear track. They found that place coding was dynamic. Active subsets of neurons (generally with the same place fields) overlapped from day to day, but the overlap diminished over the course of days and weeks. Yet, there was a 15–25% overlap between the cells with significant place fields in any two of these subsets, and cells generally retained the same place fields. This sufficed to preserve an accurate spatial representation across weeks. Similarly, Rubin et al. (2015) recorded hundreds of CA1 neurons in mice in square

and cylindrical enclosures. They found that decoding of population activity recordings close to each other in time in the two contexts were similar and thus had the same 'time stamp'. Conversely, temporally remote episodes had distinct time stamps, even if they occurred within the same spatial context. Thus, over days, hippocampal population dynamics could support the formation of a timeline in which experienced events could be mnemonically associated or dissociated based on their temporal separation.

Large populations of hippocampal CA1 neurons were monitored with calcium imaging in mice exposed to an environmental context A, and a week later, to two other different environmental contexts B and C separated by a five hour interval (Cai et al., 2016). The contexts five hours apart were represented by distinct but overlapping neuronal populations. But, the contexts experienced a week apart demonstrated little overlap in their neural representation. Two days later, mice were exposed to shock in context C, evoking fear responses. Context B then also triggered fear responses, but context A less so. This was ascribed to the greater overlap of representations of B and C leading to greater generalization between their associated memories. The conditioned response did not transfer to the context experienced a week earlier. Thus, the overlap of the population codes between events separated by hours would establish a link between these events. Conversely, the low overlap in this active population for distinct events separated by days would result in an absence of linkage between these events in memory.

Similarly, in mPFC, Hyman et al. (2012) found that ensemble responses exhibited significantly greater differences over time relative to hippocampal ensembles. This was interpreted as evidence for greater sensitivity of mPFC for temporal context.

3.4. Models emulating retrospective and prospective activity

The model presented above based on the principle of temporal context and the Laplace transform (Section 2.4) accounts not only for time cells but also for retrospective and prospective activity (Howard et al., 2014).

A model also based on the principle of temporal context (Hasselmo and Eichenbaum, 2005) accounts for the context-dependent retrieval of memory episodes and navigation sequences. Its neural architecture features the complex relationships between EC layers II and III on one hand, and DG/CA3 and CA1 fields on the other. Here, EC layer III drives non-specific associative retrieval of sequences. Each element of a stored sequence evokes subsequent elements, and therefore triggers the retrieval of the remainder of the sequence, as in previous models (Banquet et al., 2001; et al., 2001). But the selective retrieval of a specific episode depends on EC layer II inputs to DG/CA3 pyramidal neurons. These signals inform the process of selection between different episodes associated with the same cue. This selection of a specific sequence among several potential ones is effected through a multiplicative interaction between signals from EC layer III and from CA3 (deriving from EC layer II) the CA1 dendrites, where the two pathways converge. In earlier models (Blum and Abbott, 1996; Jensen and Lisman, 1996; Lisman, 1999; Tsodyks et al., 1996; Wallenstein and Hasselmo, 1997), similar mechanisms for sequence retrieval were implemented in the CA3 recurrent network. At a more local scale, the EC layer III network activation could play the role of a local map, which stores associations between elements, in this case, sequences of locations on a trajectory. In our model (presented below), this function in the HS is assigned to the top-down control of CA1 neurons by cortical inputs, which would be transmitted through the nucleus reuniens of the thalamus (Banquet et al., 1997, 2005; Gaussier et al., 2002; Hirel et al., 2013).

In a global approach, a Brain Based Device (BBD) large-scale architecture (Fleischer et al., 2007) emulates the results of the plus maze paradigm (Ferbinteanu and Shapiro, 2003) with its retrospective

and prospective splitter cells. The architecture combines visual, proprioceptive, and directional inputs to inferotemporal (IT) and posterior-parietal (PP) cortices, and subcortical areas such as anterior thalamic nucleus (ATN), and basal forebrain. Multimodal inputs converge on medial temporal lobe (MTL), which features, in particular, a detailed architecture of the hippocampus proper. Importantly, this neural network (NN) simulation gives access to the history leading up to the final state of activation for all brain areas in the model. An analysis that recursively traces activation of CA1 place cells back in time to synaptically connected upstream neurons reveals that the contribution of HS and EC inputs to the activation of journey-dependent (splitter) cells is more important than the contribution of inputs from cortical areas. Conversely, the inputs from cortical areas to CA1 neurons dominate journey-independent neurons. This supports the hypothesis that trajectory-dependent context coding is generated, at least partially at a local level, in EC and/or HS, acting as relays between local and global representations. Then, mPFC and PP, the supposed storage sites of the maps, could operate during planning or navigation, at a more global level, for trajectory selection. It would be of interest to determine the properties of the simulated hippocampal and cortical neurons responsible for this difference, in particular because this is an alternative to the results of Ito et al. (2015) showing that this activity in HS depends upon mPFC inputs. Indeed, these results could also depend on the dynamics of the multiple embedded loops of the large-scale architecture rather than specific dynamical properties of the neural elements.

4. 'Offline' sequence replay/preplay during sharp wave ripples (SWR) or REM sleep theta

'Offline' is the term we use here to refer to states without direct interaction with the environment, including slow wave sleep (SWS) and awake immobility, all featuring the presence of SWRs (Fig. 9). An exceptional offline state is rapid eye movement (REM) sleep since it is characterized by theta oscillations, like the awake state. These states could play roles for memory consolidation, albeit for different types of memories.

Hippocampal replay consists of brief episodes of spontaneous sequential activation of PCs, reproducing sequences observed during active behavior. This was first observed in pair-wise co-activations during sharp-wave-ripples (SWRs) in SWS (Kudrimoti et al., 1999; Wilson and McNaughton, 1994). The activation of PC pairs, and, by extension, of whole sequences of PCs can preserve the order observed during awake trajectories (Lee and Wilson, 2002). Replay during ripples during both awake immobility and slow wave sleep is accelerated 5 to 20 times relative to the sequences of activation occurring during the actual trajectories. The activation is limited to a single SWR event lasting on the order of 100–200 ms, a compressed time window conducive to STDP between successively activated neurons (Lee and Wilson, 2002; Nádasdy et al., 1999). However, multiple successive awake replay sequences can span the totality of a trajectory. Recordings from rats as they pause along an extended 10 m track can show replay over consecutive ripples (Davidson et al., 2009).

4.1. Sleep replay

The simultaneous or sequential firing of pyramidal cells during sleep replay tends to replicate their spatial and temporal firing pattern during exploration (Fig. 10). Its content may involve long episodes on the order of several minutes. According to the two-stage model of memory formation (Buzsáki, 1989), the first stage occurs online during waking, active exploration and training. Then, in a second stage, following the acquisition of a labile memory trace, this information is transferred to cortical areas to produce a more permanent trace. This occurs during reactivation during sleep, immobility and consummatory behaviors, driving synaptic changes in cortex. Consistent with this, tar-

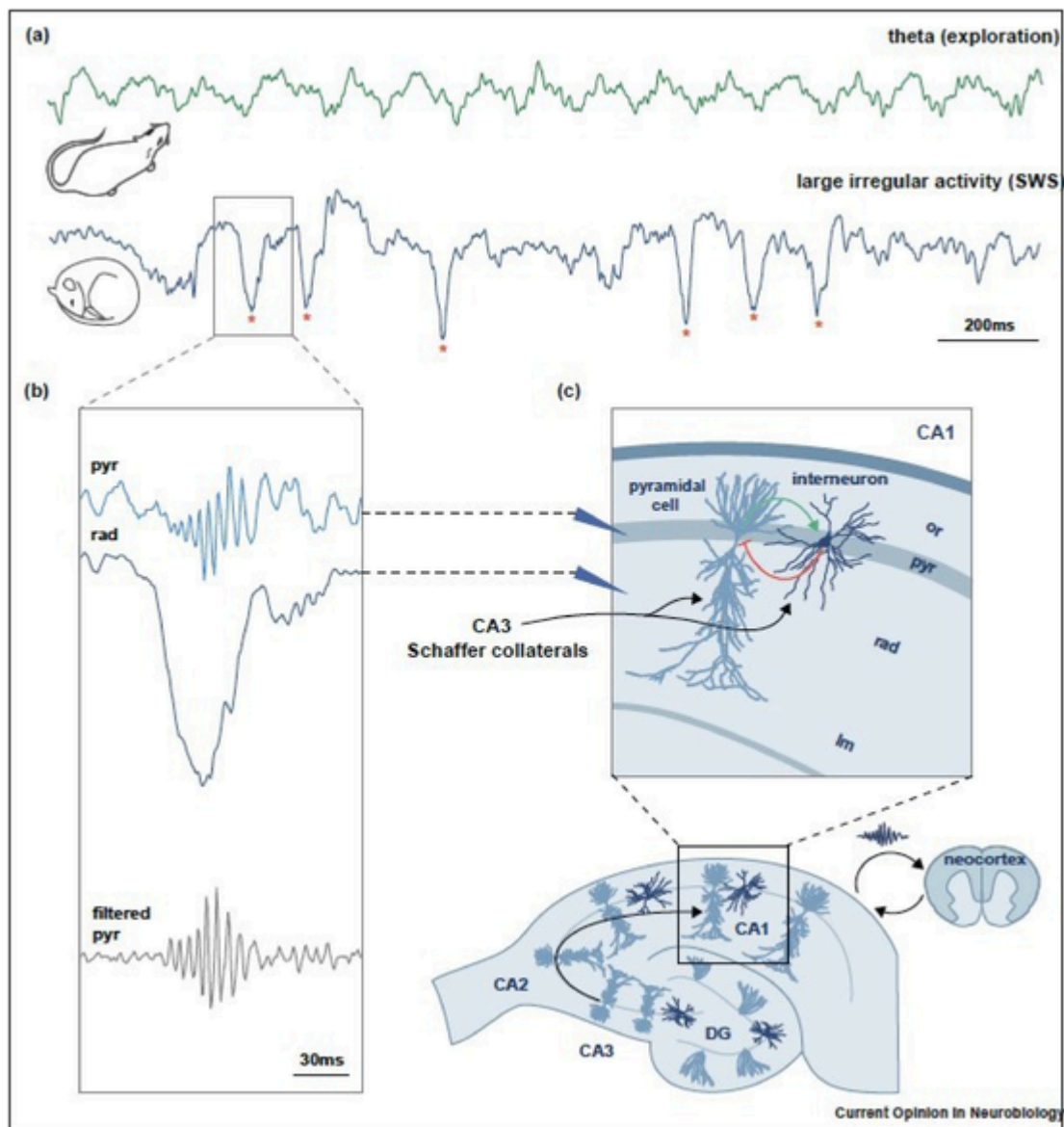

Fig. 9. Hippocampal local field potentials (LFPs) during exploration and rest/sleep. (a) Theta rhythm (green trace) and large irregular activity (blue trace) are characterized by the occurrence of sharp wave events (red stars). (b) Detailed view of the LFP trace. Simultaneous with the sharp wave recorded in stratum radiatum (rad), a high frequency (200 Hz) ripple oscillation is recorded in stratum pyramidale (pyr). Below: Trace with ripple-band filtering between 150 and 250 Hz. (c) Sharp waves in stratum radiatum reflect massive excitation of CA1 neurons by CA3 pyramidal cells via the Schaffer collaterals. The concomitant synchronization of the interneuron network at 200 Hz generates a ripple in the pyramidal layer (or: stratum oriens, lm: stratum lacunosum moleculare, rad: stratum radiatum). Adapted from Girardeau and Zugaro, 2011, with permission.

geted suppression of SWRs (and hence replay) during post-training SWS impedes acquisition in a hippocampal-dependent task (Ego-Stengel and Wilson, 2010; Girardeau et al., 2009). Moreover, in rats, posterior parietal, prefrontal, cingulate and retrosplenial (but not primary sensory) cortices displayed localized ripple oscillations during non-REM sleep, and coupling between ripples in hippocampus and these areas was strengthened during sleep following learning (Khodagholy et al., 2017). This supports the hypothesis that ripple-ripple coupling supports hippocampus-association cortex transfer for memory consolidation, as it could also support episodic memory recollection (Vaz et al., 2019, discussed in Section 4.3)

Note that Dragoi and Tonegawa (2011) found pre-existing temporal sequences of CA1 neuron firing (during sleep or quiet rest prior to experience), and these were subsequently mapped onto new experiences on a novel track identical and adjacent to a familiar one. This is controversial however (Silva et al., 2015), and could simply be related to previous learning. Nevertheless, the hippocampus has been

proposed to be “a general-purpose sequence generator that carries content-limited ordinal structure, and tiles the gaps between events or places to be linked” (Buzsáki and Tingley, 2018; Friston and Buzsáki, 2016).

Temporal sequences representing tens of seconds of behavioral experience can be reproduced during REM sleep episodes. REM reactivation recapitulates waking activity at approximately the same speed or slower (Louie and Wilson, 2001) upon a background of theta rhythmic oscillations. This suggests that the underlying mechanisms of REM replay may be distinct from those of SWR replay, bearing functional significance. When the same task is repeated on successive days, except for the initial conditions, the maximal correlation in sequential activations is found between REM episodes prior to the behavioral session and the session itself. This contrasts with replay during SWRs in SWS, where post-session sleep replay recapitulates the activity of the awake session. This puzzling result suggests that REM sleep preceding a ses-

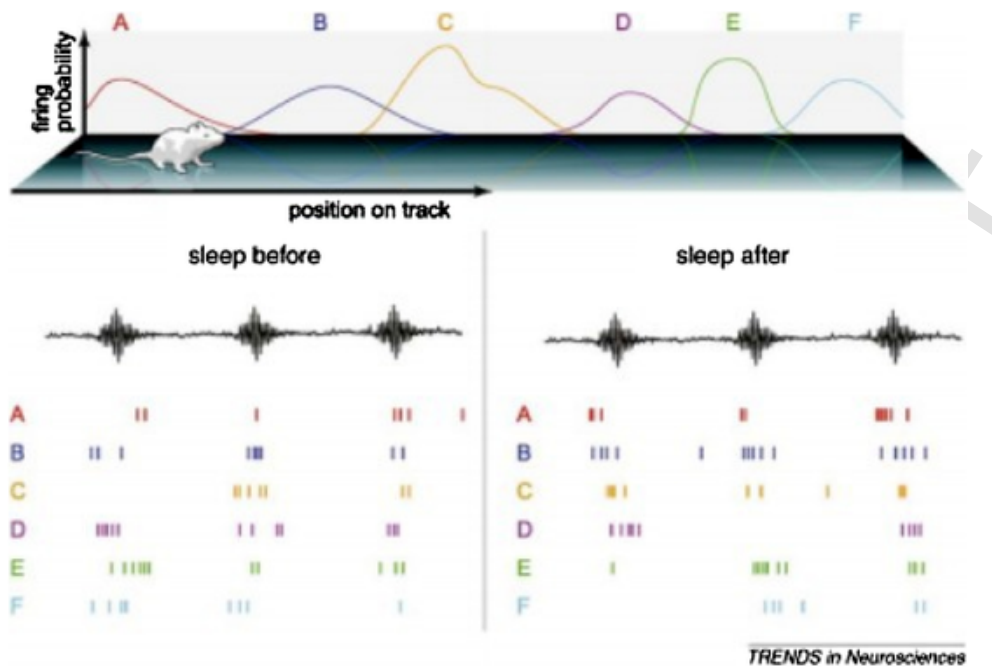

Fig. 10. Reactivation of CA1 pyramidal cells in the same order during slow wave sleep as during a prior session running on a track. Upper panel: firing probability of hippocampal pyramidal cells A to F as a function of the location of the rat as it traverses the linear track. Bottom panels: spike times of the same cells during sleep before and after the track running. Note that in the first sleep session, cells fire during SWRs but in an order that is unrelated to ensemble firing patterns during subsequent track running. However, in sleep after exploration, the cell firing during SWRs reflects the order that the cells fired during track running. Adapted from O'Neill et al. (2010), with permission.

sion could reactivate the behavioral experience of the previous day's session.

Imaging studies of brain activity during REM (Braun et al., 1998) show that extrastriate cortex and its projection areas are intensely active then too. These active structures could function as a closed system, functionally disconnected from visual inputs and frontal cortex, where high-level integration of visual information takes place. The functional significance of this REM activity could correspond to preparation of future behavior as well as a step in consolidation, i.e. elaboration of the corresponding memory traces in LTM. REM reactivations could represent an extension to the two-stage schema, and this will be elaborated in Section 4.

Sequential reactivations during sleep are not limited to the hippocampus. Coordinated sequential activations of head direction responses in anterodorsal thalamic nucleus and postsubiculum neurons are also observed with temporal compression during SWS, but at awake rates in REM (Peyrache et al., 2015).

4.2. Awake replay/preplay

Awake replay and preplay can be considered 'offline' because they usually occur during pauses preceding or following active behavior. The term 'preplay' refers to sequential activation prior to the initiation of a trajectory (not necessarily during SWRs). In rats shuttling on a linear platform, during SWRs occurring during pauses prior to movements, PCs are activated in the sequence of the forthcoming trajectory (forward preplay) (Diba and Buzsaki, 2007), and these predict the trajectory of the animal to a remembered goal (Pfeiffer and Foster, 2013). Therefore, these preplay sequences can be assimilated to the planning of forthcoming paths. Yet, some preplayed sequences do not correspond to actual behaviors. Also, it is not clear if predictive preplay originates in the hippocampus or is elaborated in conjunction with other structures.

Conversely, during pauses at the end of the platform, the replay may first represent the firing field at this end point and then proceed backwards along the platform (reverse replay). Alternatively, the replay

may proceed in the temporal order experienced by the rat (forward replay of the prior trajectory). Most of the forward and reverse replays start with the rat's current position (Davidson et al., 2009). SWRs can also occur during theta or non-theta exploration phases (eSWRs). Awake replay is hypothesized to reinforce synaptic connectivity among PCs with overlapping place fields. Priming of synapses during awake replay could support population reactivation of these cells and in the structures they project to during subsequent sleep (O'Neill et al., 2006).

The presence of reward can lead to increased rates of SWRs and coordinated reactivation of PCs compared to when reward is absent (Singer and Frank, 2009). Yet, only the rates of reverse replay occurring during these SWRs increase with reward magnitude while forward replays remain unaffected (Ambrose et al., 2016). Moreover, the SWR rate changes in relation to changing reward contingencies across trials (e.g., above-baseline rates after reinstatement of a reward at a given site). This resembles activity changes in ventral tegmental area (VTA) dopamine (DA) neurons signaling prediction errors (Gomperts et al., 2015). These DA neurons may interact with the HS by directly modulating the cell populations generating SWRs. Note that the HS projects to nucleus accumbens shell (in ventral striatum) which then projects to VTA. This connectivity could account for similarities in the activities of HS and ventral striatum during sequence coding (Banquet et al., 2016). This increase in reverse replay following changes in reward contingencies suggests a possible solution to the temporal credit assignment dilemma (Foster and Wilson, 2006), that is, how does the brain reinforce activated pathways leading up to the reward? In cell culture, 20 μ M dopamine during paired pre- and post-synaptic spikes expands the time window for spike time-dependent plasticity (STDP) at glutamatergic synapses of hippocampal neurons, and permits LTP induction by otherwise ineffectually weak stimuli with fewer spike pairs (Zhang et al., 2009). This conjecture on the solution of the credit assignment problem was recently supported by direct experimental results. A pre-established silent synaptic eligibility trace initiated by synaptic activity underwent synaptic strengthening by later action of reward-related dopamine release, thereby associating specific trajectory-

ries with behaviorally and temporally distant rewarding outcomes (Shindou et al., 2019).

A particular form of reward-related preplay was observed in an eight-arm radial maze WM task (Sasaki et al., 2018). There, sparsely active (less than 0.1 Hz) spatially non-selective DG granule cells consistently increased firing at multiple arm ends, after the onset of reward. Interestingly, at the ends of successive arm visits on a given trial, CA3 cells with fields on not yet visited arms were preferentially active. This is consistent with CA3 representing the remaining goal locations to be visited. Therefore, within the trisynaptic loop, DG, in cooperation with CA3 and CA1, could thus be implicated in generating neural firing patterns supporting future goal-directed behavior. The exact mechanisms of this remain to be elucidated.

Other offline sequential activations also have implications for action selection and decision-making. At strategic locations such as junctions on a T-maze, rats may briefly pause and look back and forth as if deliberating over the path to choose. This pause-and-look behavior is called vicarious trial and error (VTE) (Tolman, 1948), suggesting that the rat was anticipating the future. Indeed, during VTE, even though the rat is immobile, the hippocampal PC activities alternate between serial representations of the paths towards the two goals. Neurons fire in rapid sequences, or 'sweeps', lasting 150 ms (Johnson and Redish, 2007). These sequences are accelerated relative to actual locomotion, and can occur seconds prior to the actual displacement. More recent experiments suggest parallels to the human process of deliberation prior to decision making (Redish, 2016). This anticipatory firing occurs during hippocampal theta oscillations, in contrast with awake SWR-related predictive activity presented above.

In humans, awake reactivations transiently destabilized representations, and may thus provide a window of opportunity to update representations with new information. Conversely reactivation during SWS immediately strengthened them, and may serve to incorporate hippocampal information within preexisting representations outside the HS (Diekelmann et al., 2011).

4.3. Electrophysiological correlates of episodic memory in humans

'Episodic' memories of past experiences include information about what happened, and its spatial and temporal context: where and when it happened (Tulving, 2002). Recalling when an event occurred implies a representation of the historical sequence of 'landmark' events experienced by the subject. These may be referenced ordinally or as veridical dates. The process of recall inspired the metaphor of mental time travel (Suddendorf et al., 2009; Roberts, 2006; Roberts et al., 2008), possibly involving internally generated cell assembly sequences prompted by the event to be recalled, or simply spontaneously. The 'when' information can then be extracted from the conjunctive 'what/when/where' content of the episodic memory. Interestingly, this is not limited to humans since experimental evidence in scrub jays (Clayton and Dickinson, 1998) and in rats (Babb and Crystal, 2006) indicates that they may be able to date past events, and thus to have a form of episodic memory.

Work described above from the rodent literature suggests that the human medial temporal lobe (MTL) promotes episodic memory retrieval by reinstating neural representations present in other cortical areas during the original experience. (Note that in much of the human literature, for technical reasons, the hippocampal system and associated areas are described together as MTL.) Deep electrode recordings in epileptic patients have uncovered electrocorticographic correlates of episodic memory recall. In these studies, semantic memory, as word lists or verbal paired associates, is used in the service of episodic memory.

In studies by Manning et al., 2011 and Miller et al. (2013), subjects were exposed to lists of items. When they recalled particular

items, the electrocorticographic 'signatures' in MTL not only resembled the one during the original presentation, but also resembled those for previous and subsequent items as well. This is referred to as a 'temporal contiguity' effect, wherein recollection of an item is facilitated by the presentation or spontaneous recall of another item that occurred close in time to the item just recalled (Howard and Kahana, 1999). Folkerts et al. (2018) showed subjects 100 photographs and, after a delay, they were asked whether photos had been seen previously, or not. Remembering with high confidence a probe from the list again reinstated the same population vector of simultaneous recorded single unit activity in MTL that was observed during the first exposure. The population vector on these test trials was also more similar to the population vector for photos that had been presented close to the time of the original probe, another example of temporal contiguity in brain representations (Folkerts et al., 2018). The authors interpreted this as evidence for a neural 'jump back in time' associated with remembering.

This context reinstatement holds also for spatial-temporal events during navigation. A link between place cells and episodic memory in humans is provided by a study in a virtual reality maze where each place was associated with an item. Miller et al. (2013) first identified place cells in the hippocampus of implanted subjects during free navigation. Then, when subjects spontaneously recalled an item, the associated hippocampal place cell was also activated, even though subjects were not instructed to recall the location in the maze. This is consistent with 'where' contextual information being recalled in conjunctive episodic memories.

Other studies have focused on the neural basis of MTL-mediated reinstatement of experience-related activity during recall. These dialogues between MTL and associated cortical areas could be coordinated through coupled ripple-like activity in hippocampus and cortex. In patients performing a paired-associates verbal memory task, Vaz et al. (2019) observed single unit burst activity in middle temporal gyrus (MTG) associated with medial temporal lobe (MTL) ripples. Sequences of spiking in MTG neurons during encoding were repeated during recall. Furthermore, in correct trials, bursting events in a time window after MTL ripples manifested greater replay of the sequences present during encoding. During correct memory trials only, the distributed pattern of neural activity present during encoding was robustly reinstated in an item-specific manner. While there was no explicit sequencing of behavior in the task, there still may be stereotyped sequential aspects to the neural processing in respective brain areas, and this might be coded in the spike sequences. These results are consistent with the Jadhav et al. (2012) finding that awake ripples support spatial memory in rats. In the same verbal task, Yaffe et al. (2014) found reinstatement of oscillatory activity patterns, in particular in theta and high gamma bands in electrodes in MTL, and other cortical areas. Temporal contiguity was also observed here, consistent with mental time travel during recall.

The dynamics of MTL interactions with other cortical areas was examined by Watrous et al., 2013. They studied phase coherence of slow oscillations (an estimate of functional connectivity) recorded between subdural (local) EEG electrodes placed above the parahippocampal gyrus (PHG, which interfaces hippocampus with cortex), parietal and frontal cortical areas in patients performing a virtual taxi navigation task. Recall of temporal information was associated with synchrony at 8 Hz, while 2 Hz corresponded to retrieval of spatial memories. Temporal recall selectively implicated parahippocampal connectivity with inferior parietal lobe, consistent with the latter's activation in a working memory task (Marshuetz et al., 2006). Again, this is consistent with hippocampal-mediated reactivation of relevant brain areas during recall. Thus, MTL acts as a hub in these interactions with PFC, PP and MTG, with possible complementary functions for hippocampus proper (e.g., differentiating between competing contextual

representations) and PHG (e.g., integrating scene-specific context) (Copara et al., 2014).

In conclusion, in humans, episodic memory recall, characterized by representations of events embedded in their spatial-temporal context, is associated with the reinstatement of the distributed patterns of activity elicited by the first occurrence of the event, as well as immediately previous and subsequent patterns, a signature of a jump back in time. The fact that synchronous theta and fast gamma oscillations (ripples) in MTL and adjacent temporal association cortices are observed both during sequence encoding, or replay/preplay in animals and during episodic memory recall in humans, supports the hypothesis that awake preplay/replay in animals could be considered homologous to neural activity underlying human episodic memory processing.

4.4. Models of sequential 'offline' replay within the HS

In the CA3 field of the HS, it is hypothesized that single triggers could set off long sequences of experience-related activity patterns via its recurrent collateral network (Gardner-Medwin, 1976; McNaughton and Morris, 1987). Compared to cortical associative areas, these collaterals are more widespread with lower connectivity, favorable to reactivation of sparse activity patterns. Indeed, in the CA3 recurrent network, single cell firing can trigger population activity (Miles and Wong, 1983; Fujisawa et al., 2006). Potential reverberation of activity in the CA3 recurrent loops, as well as in the hippocampal circuit, could maintain information for several hundreds of milliseconds required for the association between two successive behavioral events or stimuli.

Some models emphasize the importance, for sequence learning, of heterosynaptic connections upon the CA3 and CA1 fields. This approach will be developed in Section 5, in relation with transitions. Some other models use Continuous Attractor Neural Networks (CANN) and their recurrent connections, for example, in Itskov et al.'s (2011) model of time cells. Experimental results strongly suggest that recurrent networks either in CA3, EC layer III, or neocortex play an important role in the generation of sequences. The confirmation of chaotic dynamics at the microscopic level of neural membranes (Aihara et al., 1990), but also at the macroscopic level of the EEG (Freeman, 1987) motivated some authors to implement chaotic dynamics in recurrent neural networks, as a generalization of CANN. In neuroscience applications, the term 'chaotic neural networks' extends to systems that receive external inputs (as opposed to closed systems that are extremely sensitive to initial conditions), and are characterized by trajectories of neural states dependent on noise and, to some extent, external stimuli ('tamed' chaos). The class of state-dependent network models presented here supposes that hippocampal-cortical networks are inherently capable of processing temporal-spatial stimuli. They encode time as a result of an interaction between external stimuli and the state- and time-dependent properties related to ongoing activity and hidden states (short-term synaptic plasticity, slow IPSPs, etc). Some of these Random Recurrent Network (RRN) models are presented next.

Sequential activation of neurons within the HS can be viewed as the expression of dynamical chaotic attractors in a recurrent network of interconnected pyramidal cells such as in CA3 or EC layer III. Yet, here the trigger is not necessarily a single event, as in time cell models, but a repetitive sequence of external or internal events. Tsuda (2009) proposed such a model of event and sequence coding in CA3. In the state space of a chaotic system generated by auto-associative recurrent networks, the trajectory followed by the solutions of the system between unstable chaotic attractors of different types constitutes a chaotic itinerancy (Tsuda, 2001). During learning, memory traces of sequences of events are formed in CA3 by Milnor attractors which are unstable along particular directions (Fig. 11). The transition from memory to memory is performed via the chaotic dynamics of the network. The proposed

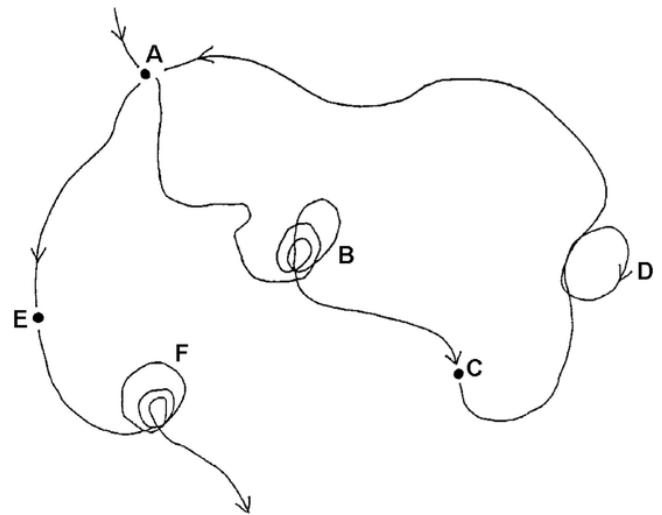

Fig. 11. Chaotic itinerancy as a model of sequential learning and replay (illustrated in the state space of the chaotic model). Inhibitory neurons in a recurrent network destabilize attractors. Noise or inputs lead the system to a new attractor, generating chaotic itinerancy and the successive association of memories. A, C, and E are fixed point attractors; D is a cyclic attractor (the limit cycle may correspond to oscillatory activity of neurons); B and F are chaotic attractors. These are all Milnor attractors, i.e., along a given trajectory direction. The dynamical system may leave one attractor state and converge to another. Adapted from Tsuda (2001), with permission.

link to neurophysiology relies on a mechanism involving GABAergic inhibition. The inclusion of inhibitory neurons in an auto-associative network does not suppress its attractors, but, rather, destabilizes them, inducing itinerancy (Table 1).

Buonomano and Maass (2009) and Laje and Buonomano (2013) propose temporal and spatial processing models belonging to the class of state-dependent networks, based on RRNs with chaotic dynamics providing a reservoir of dynamical states. As in the previous model, spatial-temporal computations are inextricably linked, and emerge from the interaction between external events, the inherent dynamics of cortical networks, and the time-dependent properties of neurons. Information is encoded in evolving neural trajectories, rather than in fixed point attractors, as originally proposed by Hopfield, 1982). In contrast with the previous model, learning takes place both on the recurrent synapses of the network and on the synapses between the recurrent network and the output pathways. The learning procedure occurs off-line, which could correspond to the reactivation of the hippocampal system during sleep, although this was not explicitly evoked by the authors. Instead, their main biological reference is to cortical networks. This system can predict both the timing of events and the dynamics of a trajectory. Previously, Daucé et al., 1998 proposed a chaotic recurrent neural network model for learning sequences. This model simulated the CA3 field of the HS, and was applied in a navigation paradigm (Daucé et al., 2002).

Next in Section 5.1, we extend the spectral timing model (Grossberg and Merrill, 1996) for coding not just time intervals, but timed sequences of any type, on the basis of heterosynaptic associations (Andry et al., 2001; Banquet et al., 2001, 2002; Gaussier et al., 1998).

5. Transitions, cognitive maps and sequence representations

In the perspective of timing and sequence learning, we developed a global model using the concepts of transitions and cognitive maps. The complete presentation of this global model is out of the scope of the present article. A sketch of the model will be presented, highlighting the features related to timing and sequence learning. The issue of HS temporal processing for learning sequences is explored in terms of cod-

Table 1
Overview of timing and sequencing functions with non-comprehensive bibliography.

Timing and Sequences	Processes	Structure	Representative References
2 Timing	2.1 Interval Tracking	CA1/CA3	Berger and Thompson, 1978; Burton et al., 2009; Hok et al., 2005; McEchron and Disterhoft, 1997; Solomon et al., 1986
	2.2 Tiling by Time Cells	CA1	Gill et al., 2011; Kraus et al., 2013; MacDonald et al., 2011; MacDonald et al., 2013; Modi et al., 2014; Pastalkova et al., 2008; Shahbaba et al., 2019
	2.3 Ramping	LEC	Sabariego et al., 2019; Salz et al., 2016; Heys and Dombeck, 2018; Tsao et al., 2018
3 Online Sequence Processing	3.1 Prospective and Retrospective Coding	CA1	Ainge et al., 2007; Catanese et al., 2014; Ferbinteanu and Shapiro, 2003; Frank et al., 2000; Lee et al., 2006; Smith and Mizumori, 2006; Wood et al., 2000
	3.2 θ Sequences and Phase Precession	CA1	Allen et al., 2016; Foster and Wilson, 2007; Gupta et al., 2012; Skaggs and McNaughton, 1996; O'Keefe and Recce, 1993; Terada et al., 2017

Timing and Sequences	Processes	Structure	Representative References
4 Offline Sequence Replay	3.3 Stimulus Order and Timing by Neural Populations	CA1/CA2	Allen et al., 2016; Cai et al., 2016; Ezzyat and Davachi, 2014; Ginther et al., 2011; Hsieh et al., 2014; Mankin et al., 2012, 2015; Manns et al., 2007; Rubin et al., 2015; Ziv et al., 2013
	4.1 Sequential Activation during Sleep Replay	CA3/CA1	Dragoi and Tonegawa, 2011; Girardeau et al., 2009; Kudrimoti et al., 1999; Lee and Wilson, 2002; Louie and Wilson, 2001; Nádasdy et al., 1999; Silva et al., 2015; Wilson and McNaughton, 1994; Ylinen et al., 1995
4.2 Awake Replay	4.2 Awake Replay	CA1	Ambrose et al., 2016; Davidson et al., 2009; Diba and Buzsáki, 2007; Johnson and Redish, 2007; O'Neill et al., 2006; Pfeiffer and Foster, 2013; Sasaki et al., 2018; Singer and Frank, 2009
	4.3 Episodic Memory		Babb and Crystal, 2006; Clayton, 1998; Copara et al., 2014; Folkerts et al., 2018; Miller, 2013; Roberts, 2002; Vaz et al., 2019; Watrous et al., 2013; Yaffe, 2013

ing transitions. Our hippocampal-inspired neural network models (Banquet et al., 1997, 2005; Gaussier et al., 2002, 2019; Hirel et al., 2013) aimed to achieve three goals. First, the architecture should combine the essential processing features of the different hippocampal fields (Fig. 12), organized into an entorhinal-hippocampal closed loop,

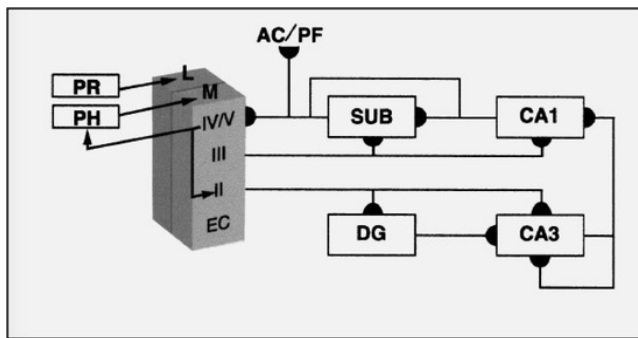

Fig. 12. Schematic representation of the entorhinal-hippocampal loop in the model. Superficial layers of lateral (L) and medial (M) entorhinal cortex (EC) receive information from the perirhinal (PR) and parahippocampal (PH) cortices, respectively. EC layer II transmits information to the DG granule cells and CA3 pyramidal cells, which also receive input from DG. CA3 pyramidal neurons connect to other CA3 neurons by recurrent collaterals and to CA1. CA1 also receives direct connections from EC layer III. CA1 connects to subiculum (SUB) and directly to deep EC layers. Subicular connections to EC layer V close both the hippocampal loop through a one-way connection from layer V to EC superficial layers. Direct connections link subiculum to prefrontal cortex (PF) and accumbens (AC). Semicircular terminals represent modifiable synapses. Adapted from Banquet et al. (2005), with permission.

embedded in a hippocampal-neocortical closed system (Fig. 13). The integrated system should function coherently, where the output of each structure serves as input to the downstream structures. Second, the hippocampo-entorhinal loop performs spatio-temporal processing of events and places, while the efferent projections store this information in the cortex over the long term. Third, this hippocampal-inspired model serves as a control system for autonomous agents, permitting its validity to be tested by their performance during goal-directed navigation, and delay estimation under physical constraints of the real world.

The model's central concept of coding transitions combines the notions of time intervals and sequences. There were two reasons for this construct. First, the patterns processed during behavior are rarely static, but rather are temporally dynamic (e.g., optic flow). Second, the population response of hippocampal or cortical networks does not simply code the current event, but rather generates a representation of each incoming event in the context of the previous events (Buonomano and Merzenich, 1995). Transition cells code the association between two successive events, such as occupying adjacent place fields, by integrating the direction of the movement between them. Transition representations combine externally-driven localization signals with internally-generated path integration and can be elementary components of longer sequences or trajectories. The underlying mechanism of transitions could correspond to mere synaptic facilitation between cells coding consecutive events or with overlapping place fields, or to establish a distributed population code. The two processes are not exclusive, and could correspond to two different phases of learning.

5.1. Sequence learning model with transition cells

The core architecture of our model is based upon fundamental elements coding transitions between events (including places occupied) and it performs sequence learning, timing and navigation (Banquet et al., 1997, 2005; Gaussier et al., 2002, 2007, 2019; Hirel et al., 2013). Thus these transition cells are basic processing elements with a temporal component. We assume that the lateral and medial EC superficial layers respectively receive 'what' information from the perirhinal cortex and 'where' information from the parahippocampal cortex (Fig. 12). This conjunction creates landmark representations in EC (see Connor and Knierim, 2017). A constellation of such landmarks maintained in buffers in EC is sufficient to establish place representations in EC and downstream hippocampus. DG granule cells maintain information during delays. Potential alternatives to maintain this information

between two successive events could involve reverberation in DG-CA3 circuit or in CA3 recurrent collaterals. Thus, they signal to CA1 information about previous states, while information about current states is transmitted through the direct pathway. Through repeated activation, transitions from previous to current states could become encoded by plasticity of heterosynaptic CA3 and CA1 synaptic connections. Thus, transitions can be learned in CA3, with distinct codes for transitions between states (e.g., places, odors) AB, CB, DB, etc. (with states A, C and D being adjacent in time, or time and space, to B). This could be considered to correspond to an implementation of retrospective coding at point B from different trajectories (Frank et al., 2000; Wood et al., 2000). This would be prospective as well, because of the extensive CA3 recurrent connectivity, the activation of any transition to point B primes all other transitions accessible from B (which were previously experienced during exploration) (Ainge et al., 2007; Frank et al., 2000). In the case of delays, learned sequences, or navigation, these potential transitions are then transmitted through the Schaffer collaterals to the CA1 field which, in conjunction with top-down input from the activated path on the cortical map (Fig. 13), bias the activity in favor of that transition most relevant for the currently relevant delay, sequences, or navigation plan resulting from activation of the representation of the delay duration, final event or goal position. In the case of a learned delay, this would trigger successive activation of appropriate time cells. Finally, for coding successive sets of sequences, the transitions are integrated as chunks that are transmitted to cortical areas such as mPFC and posterior parietal cortex, where they are combined into maps, undergoing a process of abstraction (e.g., path equivalence in deep EC layers; Frank et al., 2000; Fig. 4).

In the case of navigation, at any given place, several actions can be possible. As a consequence, the recognition of this place is not sufficient to trigger the appropriate action. In contrast, each transition concerns only a single step forward in the sequence. Hence, a small top-down bias in favor of the appropriate transition allows its associated action, event, or time cell sequence to prevail over the others possible. For this, a subthreshold activation of the representation of the delay endpoint, final event in the sequence, or goal location is differentially diffused through the cortical map, and a top-down signal is then transmitted to EC and CA1 (Fig. 13). This biases the selection of the sequence leading to the endpoint in time and space. The combination of this bottom-up and top-down signaling closes the hippocampal-cortical loop.

5.2. A timing and sequencing model with transition cells

An extension of the previous model is based on the same core architecture, but is more oriented towards timing and sequence learning (Banquet et al., 1997, 2001; Gaussier et al., 1998). We generalized the navigation paradigm to temporal sequences of events, and also episodic memory (Fig. 14). In order to model delay activity in CA1 and mPFC (Hirel et al., 2013) DG granule cells are also endowed with the capacity for spectral timing (Grossberg and Merrill, 1992), in a manner comparable to time cells. Such coding could be derived from LEC ramping activity (Tsao et al., 2018). The sequenced events can include salient environmental stimuli (Hirel et al., 2013) such as the light-sound sequences of Terada et al. (2017). Waniek (2020) attributes multiscale coding of transitions to MEC grid cells which then would provide this information to downstream hippocampal cells.

5.3. Experimental support

Several experimental results are consistent with transition coding in the HS. The hippocampal representation of a specific location can depend on the accessibility of other places in the immediate environment (Alvernhe et al., 2008). Some CA1 place cells are activated indepen-

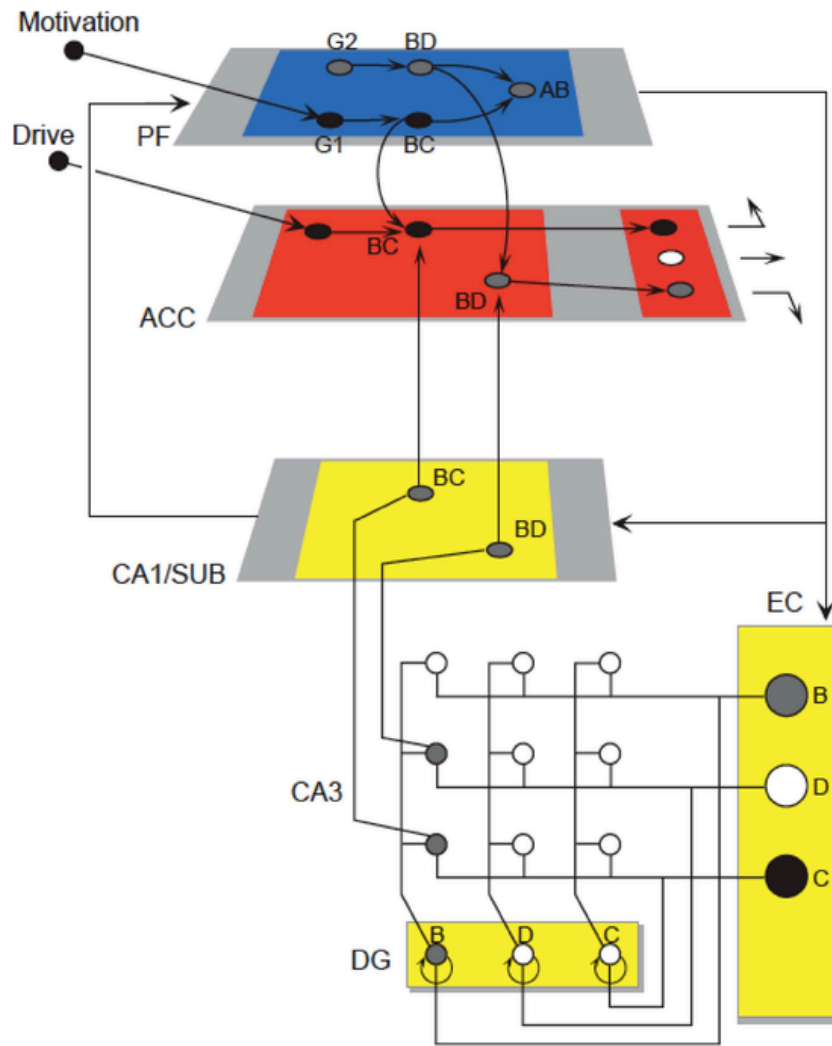

Fig. 13. Schematic representation of the hippocampal-prefrontal loop. In this architecture for navigation control, EC superficial layers receive external inputs from associative cortices. DG 'orthogonalizes' the inputs and activates delay neurons that maintain information between two successive events. A, B, C, and D code places, or any other event, including the delay and duration of a time cell activation. CA3 associates two successive events and learns transitions BC and BD that are transmitted to CA1, accumbens (ACC) and prefrontal cortex (PF), where they help code trajectories to the goals (or endpoints) G1 and G2. This benefits from prefrontal cortex (PF) top-down signaling of the active trajectory on the map, permitting selection of the appropriate transition among all possible choices. ACC and PF learn, store, and implement temporal-spatial sequences. Reprinted from Banquet et al. (2002), with permission.

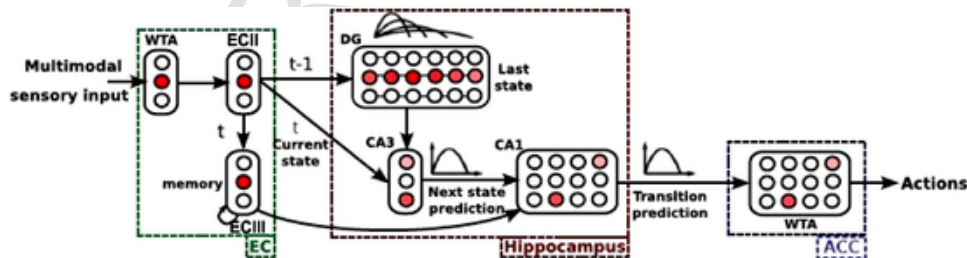

Fig. 14. A model for timing and sequence learning engaging spectral timing. Multi-modal signals (e.g. vision, sound, odometry, etc.) are integrated in EC. A Winner-Take-All (WTA) competition ensures that the activity of the most active neuron is transmitted to DG. In contrast with the original model where transitions were learned in CA3, here CA3 learns to predict the next EC state depending on the time elapsed. Transitions between EC states are learned in CA1 where the memory of the current EC state comes from ECIII (perforant path) and the predicted EC state comes from CA3. A WTA mechanism in nucleus accumbens (ACC) selects the most active transition and the corresponding motor action. Hippocampal output is transferred to the ACC. Adapted from Hirel et al. (2013), with permission.

dently of the metric of the environment, but rather in relation to its topology (Dabaghian et al., 2014). Moreover, position coding in CA1 and CA3 occurs only while the animal is moving. On the other hand, CA2 codes for position during immobility (Kay et al., 2016) and codes temporal changes better than changes in spatial context (Mankin

et al., 2015). The anticipatory or hypothesis-testing function attributed to CA3 in our model, concerning the states or places accessible from the current state, is consistent with both the preferential firing of CA3 cells with place fields on not-yet-visited arms of an eight arm radial maze (Sasaki et al., 2018) and with CA3 neurons firing corre-

sponding to the alternative trajectories at a choice point in a maze, during VTE (Johnson and Redish, 2007). Finally, those models that use temporal context to disambiguate sequences (Howard and Kahana, 2002; Howard et al., 2005) can be viewed as a generalization of the concept of transition. Contiguity effects in human MTL are also consistent with transition coding; the immediate temporal context is coded along with the event.

6. Synthesis and discussion

The behavioral aspects and possible functional significance of several types of temporal and order processing in the HS have been reviewed. Relevant models provided some hints on the underlying mechanisms. Cell properties (e.g., time constants, delay activity which is ultimately based on membrane properties, and ion channel dynamics, etc.) are complemented by other processes relying on population dynamics and network properties, like connectivity changes, recurrent connections, and loops. Nevertheless, most models combine both levels of explanations to varying degrees.

6.1. Tracking time

6.1.1. Delay activity and time cells

Several hippocampal-dependent tasks involve tracking delay intervals, maintaining information over a delay, and memory and recall of the order of events. For example, trace conditioning requires an evaluation of elapsed time for optimal task performance. For these functions, some earlier studies found maximal activity of HS neural populations at the end of the delay period (Berger and Thompson, 1978; Hok et al., 2007; McEchron et al., 2003). There is sparse or no evidence of tonic or ramping activity in the hippocampus proper, although these can be found in entorhinal cortex, striatum and neocortex (Egorov et al., 2002; Fransén et al., 2006; Khamassi et al., 2008). On the other hand, numerous studies have shown that the HS does have time cells which provide a population code with their tiling responses, even during trace conditioning (Modi et al., 2014). Time cells could code for 'what' happened and 'when'. They could also track elapsed time, and be coordinated for information storage necessary for task performance at the end of the delay. Finally, self-generated assembly sequences disengaged from external or body-related constraints could support mental time travel (cf., Section 4.3)

These results are consistent with the spectral timing model (Grossberg and Merrill, 1992) which provides a mechanism to transform transient patterns of neuronal activation into a more permanent LTM store engraved in the strength of synaptic weights. This model also suggests that the weighted summation of the spectral timing activity of time cells could lead to the emergence of ramping activity (Fig. 3, bottom). This last mechanism still awaits experimental verification.

Other related models invoke cortical oscillators tuned to different frequencies and these converge on striatal spiny neurons which integrate these signals (Catalin et al., 2009; Matell et al., 2003). These plausible alternatives raise the question of the relation between parallel timing systems. Some authors make a distinction between an automatic timing system for discrete, discontinuous events in the millisecond range, involving cerebellum and motor systems; versus a continuous-event, cognitively-controlled system on the time scale of seconds involving prefrontal and parietal cortices. In this context, the hippocampal timing system clearly belongs to the second category. Some results (Section 2.1) suggest that the HS could provide timing information to cortical structures, mPFC in particular (Burton et al., 2009; Hok et al., 2013). Conversely, mPFC could control temporal processing in striatal structures, including dorsomedial striatum (Emmons et al., 2017) and ventral striatum (Khamassi et al., 2008).

The mathematical framework of the Laplace transform of inputs by a set of leaky integrators with different time constants (Howard et al.,

2014) is implemented by a two or three layer neural network. This framework is sufficiently general and powerful to account for both spatial and temporal aspects of hippocampal processing in terms of conjunctive processing. In the temporal domain, it accounts in particular for the retrospective activity of PCs and the scalar property of time cells. Rescaling temporal sequences takes place via a simple modulation of the cortical gain control (Liu et al., 2019).

6.1.2. Multiscale timing by ramping activity in LEC

Two models propose how the LEC ramping activity could depend on, or contribute to other time codes such as time cells, decorrelation of activity of neural populations over time, and even ramping responses in neocortex and striatum. First, these results suggest that the spectral timing model (Grossberg and Merrill, 1992) could operate at large time scales. This model integrates the discrete events of the 'spectral cells' through a weighted summation to obtain ramp-like activity, which can be recorded in structures downstream of hippocampus such as PFC and striatum (Emmons et al., 2017, Khamassi et al., 2008). Conversely, the Rolls and Mills, 2019 model, differentiates, by competitive inhibition, a spectral combination of LEC cells' ramping activity, in order to produce hippocampal time cells with different time constants. Indeed, both processes could successively happen at different processing stages.

6.2. 'Online' timing and sequence learning during active behavior

6.2.1. Theta-gamma oscillations and sequential organization of events

Theta phase modulation of gamma power is the most conspicuous instance of cross-frequency coupling in the HS at a micro-time scale. Several, not necessarily exclusive, consequences resulting from theta and theta-gamma interactions (reviewed by Colgin, 2013) include: 1) facilitation of inter-regional interactions (Benchenane et al., 2010; Hyman et al., 2010; Kim et al., 2011); 2) grouping together signals containing related information (Buzsáki, 2006; Gupta et al., 2012; Lisman and Idiart, 1995); and 3) providing synchronization at time intervals propitious for fostering changes in synaptic strength (Greenstein et al., 1988; Larson et al., 1986). Thus, they could coordinate linking together representations of short sequences of successive events into longer sequences. But, simultaneously, they act as a temporal scaffold for segregating event-coding assembly sequences in the phase space. The time window corresponding to the membrane constant (10–30 ms) of downstream reader neurons that segregate cell assemblies (Buzsáki, 2010; Buzsáki and Moser, 2013), spike time-dependent plasticity window and the time constants of GABA and AMPA receptors (whose interactions generate the gamma oscillations) are of the same order of magnitude. This opens the possibility for hippocampal cells coding the same spatial position or item to form a distinct assembly in the time window of theta-modulated gamma oscillation.

This leads to respective neurons firing successively on the descending, trough, and ascending phases of the theta oscillation to represent sequences of the past, current and future positions of the animal's journey (Fig. 8A), or sequential events of the task (Fig. 8B). Hence, the spike time lags of overlapping PCs in the theta cycle scale are correlated with the distances of their corresponding place field peaks in physical space. This forms the basis of time-compressed representation of travelled distances in the temporal domain.

Finally, as suggested by earlier models (O'Keefe and Recce, 1993), the frequency interference pattern known as phase precession could result from an oscillation frequency of the waxing-waning spike activity of hippocampal pyramidal cells being faster than the frequency of the background population expressed by the local field potential theta rhythm. However this is hardly compatible with the results of Zugaro et al. (2005) which showed that extra-hippocampal inputs are crucial for phase precession.

In an alternative hypothesis, within each cycle, the interplay between internally-driven look-ahead process and externally-driven activation could facilitate the impact of phase precession on Hebbian learning of the sequence. A recurrent network can be activated by both heterosynaptic and intrinsic recurrent connections, as found in CA3 or EC layer III.

A place cell (population) that just fired during a trajectory has an enhanced capacity to subsequently prime another one to fire (Hebb, 1949), anticipating the learned forthcoming place field in the same trajectory. This can be considered as a cued memory retrieval of the imminent event which had previously occurred in the same situation. According to Colgin et al. (2009), this anticipated firing would rely on CA3 inputs to CA1 PCs during the appropriate phase of slow gamma (40 Hz) oscillations. As the animal progresses through the just anticipated place field, external stimuli drive spike activity until arrival at the center of the place field. There, 'externally-driven' peak firing of CA1 PCs would depend on direct EC layer III inputs to CA1 during a fast gamma (100 Hz) oscillation phase, taking place at the trough (coding the present) of a theta wave (Colgin et al., 2009). Thus, the spike burst of a specific PC is elicited earlier and earlier in the phase of successive theta cycles (phase precession).

A hybrid model proposes an oscillation-based phase precession in MEC cells that induces look-ahead in hippocampal neurons, reinforced by sequence learning in CA3 (Maurer and McNaughton, 2007). The role of MEC in the organization of hippocampal firing patterns is controversial. For some authors, MEC inputs to the hippocampus are required for the temporal organization of hippocampal firing patterns. Thus, precise neuronal sequences in the theta cycle (and the cognitive functions related to them) depend on intact MEC function (Schlesinger et al., 2015). Nevertheless, Sabariego et al. (2019) provided evidence that MEC is required for WM, but not necessary to sustain hippocampal time cell activity during delay periods.

The anatomical and functional relationships between the HS and associated structures such as mPFC, posterior parietal cortex, retrosplenial cortex and ACC during timing and sequence learning or performance are out of the scope of this review. Nevertheless, their close functional relationships and theta-timed integration are considered important for learning and recall. HS and mPFC oscillations are coherent in the theta band during successful trials in a spatial WM task (Jones and Wilson, 2005), during a delayed non-match to position task (Hyman et al., 2010), during rule learning in a Y-maze (Benchenane et al., 2010), and after learning an object-place association (Kim et al., 2011). Theta coherence between the HS and dorsolateral striatum increases after acquisition of a tone-cued T-maze task (DeCoteau et al., 2007). Theta coupling between the HS and the lateral amygdala is correlated with fear memory retrieval (Seidenbecher et al., 2003). This theta coupling between structures is thus pervasive, implicating a variety of cognitive functions. This would coordinate communication among structures wherein excitability is elevated in downstream neurons when upstream neurons are active. The relatively long time scale of theta (~140 ms) tolerates long synaptic delays necessary for coupling of widely distributed brain regions.

6.2.2. Ordering of events by changes in active neural populations

The order of a few events can be encoded by a population of neurons at the meso-scale of a few seconds. Yet, simultaneous recordings of the activity of large populations of neurons, e.g. by calcium imaging, have provided evidence of a gradually changing activity of the population over long intervals of hours, days, or even weeks, along with a partial turnover in the set of neurons in the population. This process has been documented during delays at the level of the time cells (Mau et al., 2018), and also at the level of PCs during free behavior in different arenas (Mankin et al., 2012; Ziv et al., 2013). This phenomenon

is interpreted as a possible timestamp of the events for ordering events on the macro-time scale in episodic memory.

6.3. Replay and memory consolidation

6.3.1. Sharp wave ripples, and episodic memory consolidation

Many studies have demonstrated a correlation between SWRs and memory. The rate of ripple occurrence increases following training on a spatial discrimination task, or after a change in task contingencies, and this is associated with improved performance (Ramadan et al., 2009). Selective suppression of SWRs impairs learning, providing evidence of a causal role of SWRs for memory consolidation (Ego-Stengel and Wilson, 2010; Girardeau et al., 2009). Behavioral and neuroimaging studies in humans, in particular with the 'remember/know' or the 'what-where-when' paradigms (Rugg and Yonelinas, 2003), confirm that SWS strengthens episodic memory of temporal context for explicit recollection, whereas implicit familiarity-based or recognition judgments remain unaffected.

Decreased neocortical input to HS during the hyperpolarized cortical down-state of sleep could favor SWR emergence, which in turn, would facilitate down-to-up transitions. Recurrent connections within the HS become more active because of reduced cholinergic suppression. The ensuing endogenous activation of CA3 fields and consecutive CA1 SWRs preferentially target the recently active neural populations. The high level of synchronous activation within CA3 during SWRs favors the spread of activation to CA1, EC deep layers and neocortex. This would facilitate consolidation of memory traces through synaptic modifications. Indeed, SWRs and prefrontal cortical sleep spindles are correlated (Siapas and Wilson, 1998), and artificial increases in spindle-ripple synchrony improve recall (Maingret et al., 2016).

During ripples, there is activation of neural sequences corresponding to recent experience, but also to remote trajectories (Karlsson and Frank, 2009), or non-local trajectories to the goal (Gupta et al., 2010). These results are consistent with a potential role in the consolidation or completion of the cognitive map through covert reactivation of the relevant circuits (Banquet et al., 2005; Gaussier et al., 2002). Awake ripples are also required for normal spatial learning (Jadhav et al., 2012). During awake SWRs, the fast component of the SWR (O'Keefe and Nadel, 1978), acts as a pacemaker for the spike sequences of selected neurons (Ylinen et al., 1995) in CA3 and CA1. These spike sequences are coordinated both within and across hemispheres. During SWRs, increases in slow gamma (20–50 Hz) power and synchrony entrain CA3 and CA1 spiking, and predict higher quality replay of previous experiences (Carr et al., 2012). This transient synchronization in awake memory replay could foster coordinated memory reactivation across the hippocampal network.

6.3.2. REM sleep and procedural memory

Neurons from the EC deep layers projecting to the neocortex become selectively active during hippocampal SWRs (Chrobak and Buzsáki, 1994), both during sleep and the quiet awake state. But this directionality of information transfer should reverse during REM sleep, which, like the awake state, is characterized by the dominance of hippocampal theta and cortical high frequency oscillations.

During the awake state, high levels of ACh and norepinephrine in neocortex and subcortical structures mediate tonic suppression of CA1 outputs (Hasselmo et al., 1997; Hasselmo and McGaughy, 2004), and thus may limit signaling from HS to cortex. But the impact of external novel inputs on HS activity and the feedforward connections through HS is preserved. The information flow from neocortex to HS is reinforced (Hasselmo, 1999). This neuromodulator configuration also attenuates the internally-driven activation of the HS pathways by suppressing excitatory glutamatergic transmission from CA3 to CA1 (Herreras et al., 1988; Hounsgaard, 1978). This dominant cortical-hip-

poampal flow of activity fosters input from the environment during the awake state, and could bias the competition between externally-driven and internally-driven activation of the parahippocampal and neocortical networks. Interferences of reactivated memories on processing external inputs would thus be diminished.

As in the awake state, during REM there is hippocampal theta and cortical fast frequency activity. High levels of ACh in the hippocampus contrast with lower levels of both ACh and norepinephrine in neocortex. This could favor communication between cortical regions, and also facilitate cortical-to-hippocampal signaling. Thus, REM activity could reflect neocortical activation of hippocampal circuits and constitute a later stage of memory consolidation. REM sleep could facilitate the slower interleaving, in neocortex, of the newly acquired episodic memories with preexisting representations of similar episodes (Stickgold, 2000; Stickgold and Walker, 2005), perhaps as semantic memories.

Several experimental results point to the specific contribution of REM sleep to a later 'third stage' of memory consolidation. As evoked in Section 4.1, in a task repeated on successive days, hippocampal firing patterns during REM episodes prior to the behavioral session resembled those of the previous day, and were also correlated with patterns during performance that day. This suggests a recall of repeated remote experience which influences ensuing performance (Kudrimoti et al., 1999; Louie and Wilson, 2001), possibly leading to procedural or habit memory formation. Second, the time scale of the sequences reactivated during REM sleep are longer than the time scales of replay during SWRs (Kudrimoti et al., 1999; Wilson and McNaughton, 1994). Also, REM reactivation replays waking activity at approximately the same speed (Louie and Wilson, 2001), in contrast to the accelerated replay during SWRs. This suggests that HS sequence activations during REM involve a specific network-dependent mechanism for encoding temporal information at these longer time scales, in contrast with the events coded in the precession of a few theta cycles or SWR reactivations described above. The 'real-time' durations of the (pre- or) re-activated sequences seems commensurate to those of the stored sequences in the respective cortical structures. Third, REM sleep suppression in humans affects only the acquisition of procedural memories (see Stickgold et al., 2001, for a review). After overtraining, these cortical sequences may become critical for the HS-independent performance of procedural tasks and habitual behavior in general (Banquet et al., 2016; Karni et al., 1994). Finally, hippocampal lesions only slow down learning the eight arm maze (Jarrard, 1995), but do not usually prevent procedural learning. This indicates that the supporting structures for this slower acquisition are extra-hippocampal, e.g., cortical-striatal.

These results support the existence of REM related mechanisms for the consolidation of memories for repeated, highly similar experiences. Yet, for navigation, sequencing and other complex behaviors, this process would occur after initial acquisition and consolidation stages. This interpretation builds upon the standard memory consolidation theory, which concerns declarative memories with explicit retrieval. It assumes that the mechanisms of consolidation are similar for the episodic and semantic types of declarative memory. Like the trace transformation theory (Nadel and Moscovitch, 1997; Winocur et al., 2010), our proposal points to the possible transformation of an episodic representation through overlapping repeated reactivations leading to abstract semantic and schema-like representations, independent of the HS for their retrieval. A similar mechanism could generate the formation of procedural and habit memories.

7. Conclusion

This review of behavioral, electrophysiological, brain imaging and theoretical bases for timing and sequence learning in HS leads to a few conclusions.

First, concerning timing, three distinct complementary processes occur: 1) at a meso-scale, the 'tiling' time cells seem to carry information on 'what' happened 'when', as well as tracking elapsing time during delays; 2) at a macro-scale, the population activity and composition changes could 'time stamp' events for an episodic memory 'time line'; 3) at any time scale, the inherent timing of ramping cells in LEC could be at the origin of the two others processes.

Second, concerning sequences, there are three distinct processes: 1) Online, the HS represents consecutive events as sequences, either at the scale of phase sequences, or, at a macro-scale, through the drift of activity in neural populations or the turnover in the neurons composing these populations; 2) HS can endogenously generate sequential activation of neural assemblies during delays, as time cell sequences in particular, in order to bridge the gap between significant events, and possibly during recollection of the past and planning future behavior; 3) Offline, during rest or sleep SWR episodes following behavior, the HS can reactivate neural population sequences, thus fostering permanent storage of information in LTM. Whatever the state of the sleep-waking cycle in animals and humans, synchronized oscillations coordinate both local (gamma) and distal (theta) neural activity interactions between HS and associative cortices. A spectral fingerprint of large-scale neural interactions supports a spectro-temporal multiplexing process to learn, store and retrieve spatial-temporal contexts encoded in interconnected neural populations.

Third, timing and sequencing are tightly linked. Sequences unfold necessarily through time, and conversely two successive elements of a sequence constitute the boundaries for time intervals and elapsed time. However, sequences unfolding at different speeds do not always need precise timing of each of their component intervals. Remarkably, sophisticated behaviors (like imitation, language prosody, song, music performance or dance) share a subtle combination of sequential ordering of discrete events along with precise timing of their succession. These processes require coordination of past, present and future, and therefore implicate memory and planning, i.e., time travel in the future. HS activity indeed codes elapsed time, intervals, or sequences, and is a likely contributor to representing such temporal processes. Yet, other systems, in particular those involved in implementing appropriate actions, such as prefrontal-striatal loops and cerebellum, are likely to participate in tight coordination with HS for these temporal functions, thus yielding well-coordinated behaviors. The respective contributions of these structures and their interplay remain to be further explored, and are a promising subject for future research.

Buzsáki, 1989, Buzsáki and Moser (2013), Daucé et al. (1998), Daucé et al. (2002), Huxter et al. (2003), , , , Manning et al. (2011), , Navrátilová and McNaughton (2014), , Roberts (2006), Suddendorf et al. (2009) and .

Acknowledgments

This work was supported by French Agence Nationale pour la Recherche grant NEUROBOT (ANR-BLAN-SIMI2-LS-100617-13-01), Labex Memolife and the Fondation Bettencourt-Schueller. We thank two anonymous reviewers, Angelika Gissler, Jean-Philippe and Yann-Eric Banquet for help in figure design and programming, respectively, and France Maloumian for help with figures.

Appendix A. The Peer Review Overview and Supplementary data

The Peer Review Overview and Supplementary data associated with this article can be found in the online version, at doi: <https://doi.org/10.1016/j.pneurobio.2020.101920>.

References

- Adler, A., Katabi, S., Finkes, I., Israel, Z., Prut, Y., Bergman, H., 2012. Temporal convergence of dynamic cell assemblies in the striato-pallidal network. *J. Neurosci.* 32 (7), 2473–2484.
- Aihara, K., Takabe, T., Toyoda, M., 1990. Chaotic neural networks. *Phys. Lett. A* 144 (6), 333–340.
- Ainge, J., Tamosiunaite, M., Woergoetter, F., Dudchenko, P., 2007a. Hippocampal CA1 place cells encode intended destination on a maze with multiple choice points. *J. Neurosci.* 27 (36), 9769–9779.
- Ainge, J., van der Meer, M., Langston, R., Wood, E., 2007b. Exploring the role of context-dependent hippocampal activity in spatial alternation behaviour. *Hippocampus* 17, 988–1002.
- Akhlaghpour, H., Wiskerke, J., Choi, J., Taliaferro, J., Au, J., Witten, L., 2016. Dissociated sequential activity and stimulus encoding in the dorsomedial striatum during spatial working memory. *eLife* 5, e19507.
- Allen, T., Salz, D., McKenzie, S., Fortin, N., 2016. Nonspatial sequence coding in CA1 neurons. *J. Neurosci.* 36, 1547–1563.
- Alvernhe, A., Van Cauter, T., Save, E., Poucet, B., 2008. Different CA1 and CA3 representations of novel routes in a shortcut situation. *J. Neurosci.* 28 (29), 7324–7333.
- Ambrose, R., Pfeiffer, B., Foster, D., 2016. Reverse replay of hippocampal place cells is uniquely modulated by changing reward. *Neuron* 91 (5), 1124–1136.
- Andry, P., Gaussier, P., Moga, S., Banquet, J., Nadel, J., 2001. Learning and communication via imitation: An autonomous robot perspective. *IEEE Transactions on Systems, Man, and Cybernetics-Part A: Systems and Humans* 31 (5), 431–442.
- Babb, S.J., Crystal, J.D., 2006. Episodic-like memory in the rat. *Curr. Biol.* 16 (1317–21), 61.
- Banquet, J.P., Gaussier, P., Dreher, J., Joulain, C., Revel, A., Günther, W., 1997. Space-time, order, and hierarchy in fronto-hippocampal system: A neural basis of personality. *Adv. Psychol.* 124, 123–189.
- Banquet, J.P., Gaussier, P., Quoy, M., Revel, A., 2001. From reflex to planning: Multimodal versatile complex systems in biorobotics. *Behav. Brain Sci.* 24 (6), 1051–1053.
- Banquet, J.P., Gaussier, P., Quoy, M., Revel, A., Burnod, Y., 2002. Cortico-hippocampal maps and navigation strategies in robots and rodents. In: Hallam, B., Floreano, D., Hallam, J., Meyer, J.-A. (Eds.), *Proc. 7th International Conf. Simulation of Adaptive Behavior. From Animals to Animats, ICSAB*. MIT Press, Cambridge. pp. 141–150.
- Banquet, J., Gaussier, P., Quoy, M., Revel, A., Burnod, 2005. A hierarchy of associations in hippocampo-cortical systems, cognitive maps and navigation strategies. *Neural Comput. Appl.* 17 (6), 1339–1384.
- Banquet, J., Souheil, H., Gaussier, P., Quoy, M., 2016. From cognitive to habit behaviour during navigation through cortico-basal ganglia loops. In: Villa, A., Masulli, P., Pons Rivero, A. (Eds.), *Artificial Neural Networks and Machine Learning*. Springer, New York, pp. 238–247.
- Benchenane, K., Peyrache, A., Khamassi, M., Tierney, P., Gioanni, Y., Battaglia, F., Wiener, S., 2010. Coherent theta oscillations and reorganization of spike timing in the hippocampal-prefrontal network upon learning. *Neuron* 66, 921–936.
- Berger, T.W., Thompson, R., 1978. Identification of pyramidal cells as the critical elements in hippocampal neuronal plasticity during learning. *Proc. Natl. Acad. Sci. U. S. A.* 75 (3), 1572–1576.
- Bi, G.Q., Poo, M.M., 1998. Synaptic modifications in cultured hippocampal neurons, dependence on spike timing, synaptic strength, and postsynaptic cell type. *J. Neurosci.* 18, 10464–10472.
- Blum, K., Abbott, L., 1996. A model of spatial map formation in the hippocampus of the rat. *Neur. Comp.* 8 (1), 85–93.
- Bower, M., Euston, D., McNaughton, B., 2005. Sequential-context-dependent hippocampal activity is not necessary to learn sequences with repeated elements. *J. Neurosci.* 25 (6), 1313–1323.
- Braun, A., Balkin, T., Wesensten, N., Gwady, F., Carson, R., Varga, M., Baldwin, P., Belenky, G., Herscovitch, P., 1998. Dissociated pattern of activity in visual cortices and their projections during human rapid eye movement sleep. *Science* 279 (5347), 91–95.
- Buonomano, D.V., Maass, W., 2009. State-dependent computations: spatiotemporal processing in cortical networks. *Nat. Rev. Neurosci.* 10 (2), 113–125. doi:10.1038/nrn2558.
- Buonomano, D., Merzenich, M., 1995. Temporal information transformed into a spatial code by a neural network with realistic properties. *Science* 267, 1028–1030.
- Burton, B., Hok, V., Save, E., Poucet, B., 2009. Lesion of the ventral and intermediate hippocampus abolishes anticipatory activity in the medial prefrontal cortex of the rat. *Behav. Brain Res.* 199 (2), 222–234.
- Buzsáki, G., 1989. Two-stage model of memory trace formation: a role for “noisy” brain states. *Neurosci.* 31 (3), 551–570.
- Buzsáki, G., 2005. Theta rhythm of navigation: link between path integration and landmark navigation, episodic and semantic memory. *Hippocampus* 15 (7), 827–840.
- Buzsáki, G., 2006. *Rhythms of the Brain*. Oxford University Press, New York.
- Buzsáki, G., 2010. Neural syntax: cell assemblies synsembles and readers. *Neuron* 68, 362–385.
- Buzsáki, G., Moser, E., 2013. Memory, navigation and theta rhythm in the hippocampal-entorhinal system. *Nat. Neurosci.* 16, 130–138.
- Buzsáki, G., Tingley, D., 2018. Space and time: the hippocampus as a sequence generator. *Trends Cogn. Sci.* 22 (10), 853–869.
- Cai, D., Aharoni, D., Shuman, T., Shobe, J., Biane, J., Lou, J., Kim, I., Baumgaertel, K., Levenstain, A., Tuszynski, M., 2016. A shared neural ensemble links distinct contextual memories encoded close in time. *Nature* 534, 530–540.
- Carr, M., Karlson, M., Frank, L., 2012. Transient slow gamma synchrony underlies hippocampal memory replay. *Neuron* 75, 700–713.
- Catalin, V., Buhusi, C., Meck, W., 2009. Relativity theory and time perception: Single or multiple clocks? *PLoS One* 4 (7), e6268 doi, 10.1371.
- Catanese, J., Cerasti, E., Zugaro, M., Viggiano, A., Wiener, S., 2012. Dynamics of decision-related activity in hippocampus. *Hippocampus* 22 (9), 1901–1911.
- Catanese, J., Cerasti, E., Zugaro, M., Viggiano, A., Wiener, S., 2014. Retrospectively and prospectively modulated hippocampal place responses are differentially distributed along a common path in a continuous T-maze. *J. Neurosci.* 34 (39), 13163–13169.
- Chrobak, J., Buzsáki, G., 1994. Selective activation of deep layer V-VI retrohippocampal cortical neurons during hippocampal sharp waves in the behaving rat. *J. Neurosci.* 14 (10), 6160–6170.
- Clayton, N.S., Dickinson, A., 1998. Episodic-like memory during cache recovery by scrub jays. *Nature* 395, 372–374.
- Colgin, L., 2013. Mechanisms and functions of theta rhythms. *Ann. Rev. Neurosci.* 36, 295–312.
- Colgin, L., Denninger, T., Fyhn, M., Hafting, T., Bonnevie, T., Jensen, O., Moser, M., Moser, E., 2009. Frequency of gamma oscillations routes flow of information in the hippocampus. *Nature* 462, 353–357 63.
- Connor, C., Knierim, J., 2017. Integration of objects and space in perception and memory. *Nat. Neurosci.* 20 (11), 1493–1503.
- Copara, M.S., Hassan, A.S., Kyle, C.T., Libby, L.A., Ranganath, C., Ekstrom, A.D., 2014. Complementary roles of human hippocampal subregions during retrieval of spatiotemporal context. *J. Neurosci.* 34 (20), 6834–6842.
- Coull, J., Cheng, R., Meck, W., 2011. Neuroanatomical and neurochemical substrates of timing. *Neuropsychopharm.* 36 (1), 3–25.
- Dabaghian, Y., Brandt, V., Frank, L., 2014. Reconcepting the hippocampal map as a topological template. *eLife* 3, 1–03476.
- Daucé, E., Quoy, M., Cessac, B., Doyon, B., Samuelides, M., 1998. Self-organization and dynamics reduction in recurrent networks: stimulus presentation and learning. *Neural Netw.* 11, 521–533.
- Daucé, E., Quoy, M., Doyon, B., 2002. Resonant spatio-temporal learning in large random neural networks. *Biol. Cybern.* 87, 185–198.
- Davidson, T., Kloosterman, F., Wilson, M.A., 2009. Hippocampal replay of extended experience. *Neuron* 63 (4), 497–507.
- DeCoteau, W., Thorn, C., Gibson, D., Courtenanche, R., Mitra, P., Kubota, Y., Graybiel, A., 2007. Learning-related coordination of striatal and hippocampal theta rhythms during acquisition of a procedural maze task. *Proc. Natl. Acad. Sci. U. S. A.* 104, 5644–5649.
- Diba, K., Buzsáki, G., 2007. Forward and reverse place-cell sequences during ripples. *Nat. Neurosci.* 10 (10), 1241–1242.
- Diekelmann, S., Buchel, C., Born, J., Rasch, B., 2011. Labile or stable: opposing consequences for memory when reactivated during waking and sleep. *Nat. Neurosci.* 14 (3), 381–386.
- Doeller, K., Paradis, A., Benchenane, K., Berthoz, A., Burgess, B., Rondi-Reig, L., 2014. Interaction between hippocampus and cerebellum crus I in sequence-based but not place-based navigation. *Cereb. Cortex* 25 (11), 4146–4154.
- Dragoi, G., Buzsáki, G., 2006. Temporal encoding of place sequences by hippocampal cell assemblies. *Neuron* 50 (1), 145–157.
- Dragoi, G., Tonegawa, S., 2011. Preplay of future place cell sequences by hippocampal cellular assemblies. *Nature* 469 (7330), 397–401.
- Egorov, A., Hamam, B., Fransén, E., Hasselmo, M., Alonso, A., 2002. Graded persistent activity in entorhinal cortex neurons. *Nature* 420 (6912), 173–178.
- Ego-Stengel, V., Wilson, M., 2010. Disruption of ripple associated hippocampal activity during rest impairs spatial learning in the rat. *Hippocampus* 20 (1), 1–10.
- Eichenbaum, H., 2017. On the integration of space, time, and memory. *Neuron* 95, 1007–1018.
- Eichenbaum, H., Otto, T., Cohen, N., 1994. Two functional components of the hippocampal memory system. *Behav. Brain Sci.* 17, 449–518.
- Emmons, E.B., De Corte, B.J., Kim, Y., Parker, K.L., Matell, M.S., Narayanan, N.S., 2017. Rodent medial frontal control of temporal processing in the dorsomedial striatum. *J. Neurosci.* 37 (36), 8718–8733.
- Estes, W., 1955. Statistical theory of spontaneous recovery and regression. *Psychol. Rev.* 62, 145–154.
- Ezzyat, Y., Davachi, L., 2014. Similarity breeds proximity, pattern similarity within and across contexts is related to later mnemonic judgments of temporal proximity. *Neuron* 81, 1179–1189.
- Felsen, G., Mainen, Z., 2008. Neural substrates of sensory-guided locomotor decisions in the rat superior colliculus. *Nat. Neurosci.* 11, 137–148.
- Ferbinteanu, J., Shapiro, M., 2003. Prospective and retrospective memory coding in the hippocampus. *Neuron* 40, 1227–1239.
- Fleischer, G., Gally, J.A., Edelman, G.M., Krichmar, J.L., 2007. Retrospective and prospective responses arising in a modeled hippocampus during maze navigation by a brain-based device. *PNAS* 104 (9), 3556–3560.
- Folkerts, S., Rutishauser, U., Howard, M.W., 2018. Human episodic memory retrieval is accompanied by a neural contiguity effect. *J. Neurosci.* 38 (17), 4200–4211.
- Foster, D.J., Knierim, J.J., 2012. Sequence learning and the role of the hippocampus in rodent navigation. *Curr. Opin. Neurobiol.* 22 (2), 294–300. doi:10.1016/j.conb.2011.12.005.
- Foster, D., Wilson, M., 2006. Reverse replay of behavioural sequences in hippocampal place cells during the awake state. *Nature* 440, 680–683.
- Foster, D., Wilson, M., 2007. Hippocampal theta sequences. *Hippocampus* 17 (11), 1093–1099.
- Frank, L., Brown, E., Wilson, M., 2000. Trajectory encoding in the hippocampus and entorhinal cortex. *Neuron* 27 (1), 169–178.
- Fransén, E., Tahvildari, B., Egorov, A., Hasselmo, M., Alonso, A., 2006. Mechanism of graded persistent cellular activity of entorhinal cortex layer V neurons. *Neuron* 49 (5), 735–746.
- Freeman, W., 1987. Simulation of chaotic EEG patterns with a dynamic model of the olfactory system. *Biol. Cybern.* 56, 139–150.
- Friston, K., Buzsáki, G., 2016. The functional anatomy of time: what and when in the brain. *Trends Cogn. Sci.* 20, 500–511.

- Fujisawa, S., Matsuiki, N., Ikegaya, Y., 2006. Single neurons can induce phase transitions of cortical recurrent networks with multiple internal states. *Cereb. Cortex* 16, 639–654.
- Funahashi, S., 2006. Prefrontal cortex and working memory processes. *Neurosci.* 139 (1), 251–261.
- Gardner-Medwin, A.R., 1976. The recall of events through the learning of associations between their parts. *Proc. R. Soc. Lond. B, Biol. Sci.* 194, 375–402.
- Gaussier, P., Moga, S., Quoy, M., Banquet, J.P., 1998. From perception-action loops to imitation processes: a bottom-up approach of learning by imitation. *Appl. Artif. Intell.* 12 (7–8), 701–727.
- Gaussier, P., Revel, A., Banquet, J., Babeau, V., 2002. From view cells and place cells to cognitive map learning: processing stages of the hippocampal system. *Biol. Cybern.* 86 (1), 15–28.
- Gaussier, P., Banquet, J.P., Sargolini, F., Giovannangeli, C., Save, E., Poucet, B., 2007. A model of grid cells involving extra hippocampal path integration, and the hippocampal loop. *J. Integrat. Neurosci.* 6 (3), 447–476.
- Gaussier, P., Banquet, J.P., Cuperlier, N., Quoy, M., Aubin, L., Jacob, P., Sargolini, F., Save, E., Krichmar, J., Poucet, B., 2019. Merging information in the entorhinal cortex: what can we learn from robotic experiments and modeling? *J. Exp. Biol.* 222, 1–13.
- Gibbon, J., 1977. Scalar expectancy theory and Weber's law in animal timing. *Psychol. Rev.* 84 (3), 279–325.
- Gibbon, J., Church, R., Meck, W., 1984. Scalar timing in memory. *Ann. NY. Acad. Sci.* 423, 52–77.
- Gil, M., Ancau, M., Schlesiger, M., Neitzl, A., Allen, K., De Marco, R., Monyer, H., 2018. Impaired path integration in mice with disrupted grid cell firing. *Nat. Neurosci.* 21, 81–91.
- Gill, P., Mizumori, S., Smith, D., 2011. Hippocampal episode fields develop with learning. *Hippocampus* 21 (11), 1240–1249.
- Ginther, M., Walsh, D., Ramus, S., 2011. Hippocampal neurons encode different episodes in an overlapping sequence of odors task. *J. Neurosci.* 31 (7), 2706–2711.
- Girardeau, G., Benchenane, K., Wiener, S., Buzsáki, G., Zugaro, M., 2009. Selective suppression of hippocampal ripples impairs spatial memory. *Nat. Neurosci.* 12 (10), 1222–1223.
- Girardeau, G., Zugaro, M., 2011. Hippocampal ripples and memory consolidation. *Curr. Opin. Neurobiol.* 21 (3), 452–459. doi:10.1016/j.conb.2011.02.005.
- Golob, E., Stackman, R., Wong, A., Taube, J., 2001. On the behavioral significance of head direction cells: Neural and behavioral dynamics during spatial memory tasks. *Behav. Neurosci.* 115 (2), 285–304.
- Gomperts, S.N., Kloosterman, F., Wilson, M., 2015. VTA neurons coordinate with the hippocampal reactivation of spatial experience. *eLife* 4, e05360.
- Greenstein, Y., Pavlides, C., Winson, J., 1988. Long-term potentiation in the dentate gyrus is preferentially induced at theta rhythm periodicity. *Brain Res.* 438, 331–334.
- Griffin, A., 2015. Role of the thalamic nucleus reuniens in mediating interactions between the hippocampus and medial prefrontal cortex during spatial working memory. *Front. Sys. Neurosci.* 9, 29. doi:10.3389/fnys.2015.00029.
- Grossberg, S., 1972. A neural theory of punishment and avoidance, II. Quantitative theory. *Math. Biosci.* 15, 253–285.
- Grossberg, S., Merrill, J., 1992. A network model of adaptively timed reinforcement learning and hippocampal dynamics. *Cogn. Brain Res.* 1, 3–38.
- Grossberg, S., Merrill, J., 1996. The hippocampus and cerebellum in adaptively timed learning, recognition, and movement. *J. Cogn. Neurosci.* 8, 257–277.
- Grossberg, S., Schmajuk, N., 1989. Neural dynamics of adaptive timing and temporal discrimination during associative learning. *Neural Netw.* 2 (2), 79–102.
- Gupta, A., van der Meer, M., Touretzky, D., Redish, A.D., 2010. Hippocampal replay is not a simple function of experience. *Neuron* 65 (5), 695–705.
- Gupta, A., van der Meer, M., Touretzky, D., Redish, A.D., 2012. Segmentation of spatial experience by hippocampal theta sequences. *Nat. Neurosci.* 15, 1032–1039.
- Hallock, H., Wang, A., Griffin, A., 2016. Ventral midline thalamus is critical for hippocampal-prefrontal synchrony and spatial working memory. *J. Neurosci.* 36 (32), 8372–8389.
- Hasselmo, M., 1999. Neuromodulation, acetylcholine and memory consolidation. *Trends Cogn. Sci.* 3 (9), 351–359.
- Hasselmo, M., 2009. A model of episodic memory: mental time travel along encoded trajectories using grid cells. *Neurobiol. Learn. Mem.* 92 (4), 559–573.
- Hasselmo, M., Eichenbaum, H., 2005. Hippocampal mechanisms for the context-dependent retrieval of episodes. *Neural Netw.* 18 (9), 1172–1190.
- Hasselmo, M., McLaughlin, J., 2004. High acetylcholine levels set circuits dynamic for attention and encoding and low acetylcholine levels set dynamics for consolidation. *Prog. Brain Res.* 145, 207–231.
- Hasselmo, M., Linster, C., Patil, M., Ma, D., Cekic, M., 1997. Noradrenergic suppression of synaptic transmission may influence cortical signal-to-noise ratio. *J. Neurophysiol.* 77 (6), 3326–3339.
- Hebb, D., 1949. *The Organization of Behaviour*. John Wiley Sons, New York.
- Herreras, O., Solís, J., Herranz, A., Del Río, R., Lerma, J., 1988. Sensory modulation of hippocampal transmission. II. Evidence for a cholinergic locus of inhibition in the Schaffer-CA1 synapse. *Brain Res.* 461 (2), 303–313.
- Heys, J., Dombeck, D., 2018. Evidence for a sub-circuit in medial entorhinal cortex representing elapsed time during immobility. *Nat. Neurosci.* 21 (11), 1574–1582.
- Hirel, J., Gaussier, P., Quoy, M., Banquet, J., Save, E., Poucet, B., 2013. The hippocampal-cortical loop: Spatio-temporal learning and goal-oriented planning in navigation. *Neural Netw.* 43, 8–21.
- Hok, V., Save, E., Lenck-Santini, P., Poucet, B., 2005. Coding for spatial goals in prelimbic/infralimbic area of the rat frontal cortex. *Proc. Natl. Acad. Sci. U. S. A.* 102, 4602–4607.
- Hok, V., Lenck-Santini, P., Save, E., Gaussier, P., Banquet, J., Poucet, B., 2007. A test of the time estimation hypothesis of place cell goal-related activity. *J. Integr. Neurosci.* 6 (3), 367–378.
- Hok, V., Chah, E., Save, E., Poucet, B., 2013. Prefrontal cortex focally modulates hippocampal place cell firing patterns. *J. Neurosci.* 33 (8), 3443–3451.
- Hopfield, J., 1982. Neural networks and physical systems with emergent collective computational abilities. *Proc. Natl. Acad. Sci. U. S. A.* 79, 2554–2558.
- Hounsgaard, J., 1978. Presynaptic inhibitory action of acetylcholine in area ca1 of the hippocampus. *Exp. Neurol.* 62 (3), 787–797.
- Howard, M., 2018. Memory as perception of the past: compressed time in mind and brain. *Trends Cogn. Sci.* 22 (2), 124–136.
- Howard, M., Kahana, M., 1999. Contextual variability and serial position effects in free recall. *J. Exp. Psychol. Learn. Mem. Cogn.* 25, 923–941.
- Howard, M., Kahana, M., 2002. A distributed representation of temporal context. *J. Math. Psychol.* 46 (3), 269–299.
- Howard, M., Fotedar, M., Datey, A.V., Hasselmo, M., 2005. The temporal context model in spatial navigation and relational learning: Toward a common explanation of medial temporal lobe function across domains. *Psychol. Rev.* 112 (1), 75–116.
- Howard, M., MacDonald, C., Tiganj, Z., Shankar, K., Du, Q., Hasselmo, M., 2014. A unified mathematical framework for coding time, space, and sequences in the hippocampal region. *J. Neurosci.* 34 (13), 4692–4707.
- Hsieh, L., Gruber, M., Jenkins, L., Ranganath, C., 2014. Hippocampal activity patterns carry information about objects in temporal context. *Neuron* 81, 1165–1178.
- Huxter, J., Burgess, N., O'Keefe, J., 2003. Independent rate and temporal coding in hippocampal pyramidal cells. *Nature* 425 (6960), 828–832.
- Hyman, J., Zilli, E., Paley, A., Hasselmo, M., 2010. Working memory performance correlates with prefrontal-hippocampal theta interactions but not with prefrontal neuron firing rates. *Front. Integr. Neurosci.* 4, 2. doi:10.3389/fnint.07.002.2010.
- Hyman, J.M., Ma, L., Balaguer-Ballester, E., Durstewitz, D., Seamans, J.K., 2012. Contextual encoding by ensembles of medial prefrontal cortex neurons. *Proc Natl Acad Sci U SA* 109, 5086–5091.
- Ito, H., Zhang, S., Witter, M., Moser, E., Moser, M., 2015. A prefrontal-thalamo-hippocampal circuit for goal-directed spatial navigation. *Nature* 522 (7554), 50–55.
- Itskov, V., Curto, C., Buzsáki, G., 2011. Cell assembly sequences arising from spike threshold adaptation keep track of time in the hippocampus. *J. Neurosci.* 31 (8), 2828–2834.
- Iwase, M., Kitanishi, T., Mizuseki, K., 2020. Cell type, sub-region, and layer-specific speed representation in the hippocampal-entorhinal circuit. *Sci. Rep.* 10, 1407.
- Jadhav, S., Kemere, C., German, P., Frank, L., 2012. Awake hippocampal sharp-wave ripples support spatial memory. *Science* 336 (6087), 1454–1458.
- Jarrard, L.E., 1995. What does the hippocampus really do? *Behav. Brain Res.* 71 (1–2), 1–10.
- Jensen, O., Colgin, L., 2007. Cross-frequency coupling between neuronal oscillations. *Trends Cogn. Sci.* 11, 267–269.
- Jensen, O., Lisman, J., 1996. Hippocampal CA3 region predicts memory sequences: accounting for the phase precession of place cells. *Learn. Mem.* 3 (2–3), 279–287.
- Jin, D., Fujii, N., Graybiel, A., 2009. Neural representation of time in cortico-basal ganglia circuits. *Proc. Natl. Acad. Sci. U. S. A.* 106 (45), 19156–19161.
- Johnson, A., Redish, A., 2007. Neural ensembles in CA3 transiently encode paths forward of the animal at a decision point. *J. Neurosci.* 27 (45), 12176–12189.
- Jones, M., Wilson, M., 2005. Theta rhythms coordinate hippocampal-prefrontal interactions in a spatial memory task. *PLoS Biol.* 3 (12), 402.
- Jung, M., Wiener, S., McNaughton, B., 1994. Comparison of spatial firing characteristics of units in dorsal and ventral hippocampus of the rat. *J. Neurosci.* 8, 437–450.
- Karlsson, M., Frank, L., 2009. Awake replay of remote experiences in the hippocampus. *Nat. Neurosci.* 12 (7), 913–918.
- Karmarkar, U., Buonomano, D., 2007. Timing in the absence of clocks: encoding time in neural network states. *Neuron* 53 (3), 427–438.
- Karni, A., Tanne, D., Rubenstein, B., Askenasy, J., Sagi, D., 1994. Dependence on REM sleep of overnight improvement of a perceptual skill. *Science* 265, 679–682.
- Kay, K., Sosa, M., Chung, J., Karlsson, M., Larkin, M., Frank, L., 2016. A hippocampal network for spatial coding during immobility and sleep. *Nature* 531 (7593), 185–190.
- Khamassi, M., Mulder, A., Tabuchi, E., Douchamps, V., Wiener, S., 2008. Anticipatory reward signals in ventral striatal neurons of behaving rats. *Eur. J. Neurosci.* 28 (9), 1849–1866.
- Khodagholi, D., Gelinis, J.N., Buzsáki, G., 2017. Learning-enhanced coupling between ripple oscillations in association cortices and hippocampus. *Science* 358, 369–372.
- Kim, J., Delcasso, S., Lee, I., 2011. Neural correlates of object-in-place learning in hippocampus and prefrontal cortex. *J. Neurosci.* 31, 16991–17006.
- Kirchner, H., Thorpe, S., 2006. Ultra-rapid object detection with saccadic eye movements: visual processing speed revisited. *Vis. Res.* 46 (11), 1762–1776.
- Koch, C., Rapp, M., Seev, 1996. A brief history of time (constants). *Cereb. Cortex* 6, 93–101.
- Kraus, B., Robinson, R., White, J., Eichenbaum, H., Hasselmo, M., 2013. Hippocampal time cells: Time versus path integration. *Neuron* 78 (6), 1090–1101.
- Kraus, B.J., Brandon, M.P., Robinson, R.J., 2nd, Connerney, M.A., Hasselmo, M.E., Eichenbaum, H., 2015. During running in place, grid cells integrate elapsed time and distance run. *Neuron* 88 (3), 578–589.
- Kryukov, V., 2012. Towards a unified model of pavlovian conditioning: short review of trace conditioning models. *Cogn. Neurodyn.* 6 (5), 377–398.
- Kudrimoti, H., Barnes, C., McNaughton, B., 1999. Reactivation of hippocampal cell assemblies: effects of behavioral state, experience, and EEG dynamics. *J. Neurosci.* 19 (10), 4090–4101.
- Laje, R., Buonomano, D., 2013. Robust timing and motor patterns by taming chaos in recurrent neural networks. *Nat. Neurosci.* 16 (7), 925–933.
- Larson, J., Wong, D., Lynch, G., 1986. Patterned stimulation at the theta frequency is optimal for the induction of hippocampal long-term potentiation. *Brain Res.* 368, 347–350.
- Lee, A., Wilson, M., 2002. Memory of sequential experience in the hippocampus during slow wave sleep. *Neuron* 36 (6), 1183–1194.
- Lee, I., Griffin, A., Zilli, E., Eichenbaum, H., Hasselmo, M., 2006. Gradual translocation of spatial correlates of neuronal firing in the hippocampus toward prospective reward locations. *Neuron* 51 (5), 639–650.

- Lenck-Santini, P., Save, E., Poucet, B., 2001. Place-cell firing does not depend on the direction of turn in a Y-maze alternation task. *Eur. J. Neurosci.* 13 (5), 1055–1058.
- Lever, C., Burton, S., Jeevawee, A., O'Keefe, J., Burgess, N., 2009. Boundary vector cells in the subiculum of the hippocampal formation. *J. Neurosci.* 29, 9771–9777.
- Lisman, J., 1999. Relating hippocampal circuitry to function: recall of memory sequences by reciprocal dentate-CA3 interactions. *Neuron* 22 (2), 233–242.
- Lisman, J.E., Idiart, M.A., 1995. Storage of 7+/-2 short-term memories in oscillatory subcycles. *Science* 267 (5203), 1512–1515.
- Liu, Y., Tiganj, Z., Hasselmo, M., Howard, M., 2019. A neural microcircuit model for a scalable scale-invariant representation of time. *Hippocampus* 29, 260–274.
- Louie, K., Wilson, M., 2001. Temporally structured replay of awake hippocampal ensemble activity during rapid eye movement sleep. *Neuron* 29 (1), 145–156.
- Ludvig, N., 1999. Place cells can flexibly terminate and develop their spatial firing. A new theory for their function. *Physiol. Behav.* 67, 57–67.
- MacDonald, C., Lepage, K., Eden, U., Eichenbaum, H., 2011. Hippocampal “time cells” bridge the gap in memory for discontinuous events. *Neuron* 71 (4), 737–749.
- MacDonald, C., Carrow, S., Place, R., Eichenbaum, H., 2013. Distinct hippocampal time cell sequences represent odor memories in immobilized rats. *J. Neurosci.* 33 (1), 14607–14616.
- Maingret, N., Girardeau, G., Todorova, R., Goutierre, M., Zugaro, M., 2016. Hippocampal coupling mediates memory consolidation during sleep. *Nat. Neurosci.* 19 (7), 959–964.
- Mankin, E., Sparks, F., Slayeha, B., Sutherland, R., Leutgeb, S., Leutgeb, J., 2012. Neuronal code for extended time in the hippocampus. *Proc. Natl. Acad. Sci. U.S.A.* 109 (47), 19462–19467.
- Mankin, E., Diehl, G., Sparks, F., Leutgeb, S., Leutgeb, J., 2015. Hippocampal CA2 activity patterns change over time to a larger extent than between spatial contexts. *Neuron* 85, 190–201.
- Manning, J.R., Polyn, S.M., Litt, B., Baltuch, G.H., Kahana, M.J., 2011. Oscillatory patterns in temporal lobe reveal context reinstatement during memory search. *Proc Natl Acad Sci U S A* 108, 12893–12897.
- Manns, J., Howard, M., Eichenbaum, H., 2007. Gradual changes in hippocampal activity support remembering the order of events. *Neuron* 56 (3), 530–540.
- Marshuetz, C., Reuter-Lorenz, P.A., Smith, E.E., Jonides, J., Noll, D.C., 2006. Working memory for order and the parietal cortex: an event-related functional magnetic resonance imaging study. *Neurosci.* 139, 311–316.
- Matell, M., Meck, W., Nicolelis, M., 2003. Interval timing and the encoding of signal duration by ensembles of cortical and striatal neurons. *Behav. Neurosci.* 117 (4), 760–773.
- Mau, W., Sullivan, D., Kinsky, N., Hasselmo, M., Howard, M., Eichenbaum, H., 2018. The same hippocampal CA1 population simultaneously codes temporal information over multiple timescales. *Curr. Biol.* 28, 499–508.
- Maurer, A.P., McNaughton, B.L., 2007. Network and intrinsic cellular mechanisms underlying theta phase precession of hippocampal neurons. *Trends Neurosci.* 30 (7), 325–333.
- McEchron, M., Disterhoft, J., 1997. Sequence of single neuron changes in CA1 hippocampus of rabbits during acquisition of trace eyeblink conditioned responses. *J. Neurophysiol.* 78, 1030–1044 71.
- McEchron, M., Bouwmeester, H., Tseng, W., Weiss, C., Disterhoft, J., 1998. Hippocampal activity disrupts trace auditory-cued fear conditioning and contextual fear conditioning in the rat. *Hippocampus* 8, 638–646.
- McEchron, M., Tseng, W., Disterhoft, J., 2000. Neurotoxic lesions of the dorsal hippocampus disrupt auditory-cued trace heart-rate (fear) conditioning in rabbits. *Hippocampus* 10, 739–751.
- McEchron, M., Tseng, W., Disterhoft, J., 2003. Single neurons in CA1 hippocampus encode trace interval duration during trace heart-rate (fear) conditioning in rabbit. *J. Neurosci.* 23 (4), 1535–1547.
- McNaughton, B., Morris, R.G.M., 1987. Hippocampal synaptic enhancement and information storage within a distributed memory system. *Trends Neurosci.* 10, 408–415.
- Meck, W., Church, R., Olton, D., 1984. Hippocampus, time, and memory. *Behav. Neurosci.* 98 (1), 3–22.
- Mello, G., Soares, S., Paton, J., 2015. A scalable population code for time in the striatum. *Curr. Biol.* 25 (9), 1113–1122.
- Merchant, H., Harrington, D., Meck, W., 2013. Neural basis of the perception and estimation of time. *Ann. Rev. Neurosci.* 36, 313–336.
- Miall, C., 1989. The storage of time intervals using oscillating neurons. *Neural Comput. Appl.* 1, 359–371.
- Miles, R., Wong, R.K.S., 1983. Single neurones can initiate synchronized population discharge in the hippocampus. *Nature* 306, 371–373.
- Miller, J.F., Neufang, M., Solway, A., Brandt, A., Trippel, M., Mader, I., Hefft, S., Merkow, M., Polyn, S.M., Jacobs, J., Kahana, M.J., Schulze-Bonhage, A., 2013. Neural activity in human hippocampal formation reveals the spatial context of retrieved memories. *Science* 342, 1111–1114.
- Modi, M., Dhawale, A., Bhalla, U., 2014. CA1 cell activity sequences emerge after reorganization of network correlation structure during associative learning. *eLife* 2014 (3), e01982. doi:10.7554/eLife.01982.
- Morris, R.G.M., 2013. NMDA receptors and memory encoding. *Neuropharmacol.* 74, 32–40.
- Nádasdy, Z., Hirase, H., Czúrkó, A., Csicsvari, J., Buzsáki, G., 1999. Replay and time compression of recurring spike sequences in the hippocampus. *J. Neurosci.* 19 (21), 9497–9507.
- Nadel, L., Moscovitch, M., 1997. Memory consolidation, retrograde amnesia and the hippocampal complex. *Curr. Opin. Neurobiol.* 7 (2), 217–227.
- Navrátilová, Z., McNaughton, B., 2014. Models of path integration in the hippocampal complex. In: Derdikman, D., Knierim, J.J. (Eds.), *Space, Time and Memory in the Hippocampal Formation*. Springer, Vienna, pp. 191–224.
- O'Keefe, J., Dostrovsky, J., 1971. The hippocampus as a spatial map. Preliminary evidence from unit activity in the freely moving rat. *Brain Res.* 34, 171–175.
- O'Keefe, J., Nadel, L., 1978. *The Hippocampus as a Cognitive Map*. Oxford University Press, USA.
- O'Keefe, J., Recce, M., 1993. Phase relationship between hippocampal place units and the EEG theta rhythm. *Hippocampus* 3 (3), 317–330.
- O'Neill, J., Senior, T., Csicsvari, J., 2006. Place-selective firing of CA1 pyramidal cells during sharp wave/ripple network patterns in exploratory behavior. *Neuron* 49 (1), 143–155.
- O'Neill, J., Pleydell-Bouverie, B., Dupret, D., Csicsvari, J., 2010. Play it again: reactivation of waking experience and memory. *Trends Neurosci.* 33 (5), 220–229.
- Oprisan, S.A., Aft, T., Buhusi, M., Buhusi, C.V., 2018. Scalar timing in memory: a temporal map in the hippocampus. *J. Theor. Biol.* 438, 133–142.
- Pastalkova, E., Itskov, V., Amarasingham, A., Buzsáki, G., 2008. Internally generated cell assembly sequences in the rat hippocampus. *Science* 321 (5894), 1322–1327. doi:10.1126/science.1159775.
- Peyrache, A., Lacroix, M., Petersen, P., Buzsáki, G., 2015. Internally organized mechanisms of the head direction sense. *Nat. Neurosci.* 18 (4), 569–575.
- Pfeiffer, B., Foster, D., 2013. Hippocampal place-cell sequences depict future paths to remembered goals. *Nature* 497 (7447), 74–79.
- Ramadan, W., Eschenko, O., Sara, S., 2009. Hippocampal sharp wave/ripples during sleep for consolidation of associative memory. *PLoS One* 4 (8), e6697.
- Redish, A.D., 2016. Vicarious trial and error. *Nat. Rev. Neurosci.* 17 (3), 147–159.
- Roberts, W.A., 2006. Animal memory: episodic-like memory in rats. *Curr. Biol.* 16 (15), 601–603. doi:10.1016/j.cub.2006.07.001.
- Roberts, W.A., Feeney, M.C., Macpherson, K., Petter, M., McMillan, N., Musolino, E., 2008. Episodic-like memory in rats: is it based on when or how long ago? *Science* 320 (5872), 113–115. doi:10.1126/science.1152709.
- Rolls, E., Mills, P., 2019. The generation of time in the hippocampal memory system. *Cell Rep.* 28, 1649–1658.
- Rubin, A., Geva, N., Sheintuch, L., Ziv, Y., 2015. Hippocampal ensemble dynamics timestamp events in long-term memory. *eLife* 2015 (4), e12247. doi:10.7554/eLife.12247.
- Rugg, M., Yonelinas, A., 2003. Human recognition memory: a cognitive neuroscience perspective. *Trends Cogn. Sci.* 7 (7), 313–319.
- Sabariño, M., Schonwald, A., Boublil, B., Zimmermann, D., Ahmadi, S., Gonzalez, N., Leibold, C., Clark, R., Leutgeb, J., Leutgeb, S., 2019. Time cells in the hippocampus are neither dependent on medial entorhinal cortex inputs nor necessary for spatial working memory. *Neuron* 102, 1–14.
- Salz, D., Tiganj, Z., Khasnabish, S., Kohley, A., Sheehan, D., Howard, M., Eichenbaum, H., 2016. Time cells in hippocampal area CA3. *J. Neurosci.* 36 (28), 7476–7484.
- Sasaki, T., Piatti, V., Hwaun, E., Ahmadi, S., Lisman, J., Leutgeb, S., Leutgeb, J., 2018. Dentate network activity is necessary for spatial working memory by supporting CA3 sharp-wave ripple generation and prospective firing of CA3 neurons. *Nat. Neurosci.* 21 (2), 258–269.
- Schlesinger, M., Cannova, C., Boublil, B., Hales, J., Mankin, E., Brandon, M., Leutgeb, J., Leibold, C., Leutgeb, S., 2015. The medial entorhinal cortex is necessary for temporal organization of hippocampal neuronal activity. *Nat. Neurosci.* 18 (8), 1123–1132. doi:10.1038/nn.4056.
- Seidenbecher, T., Laxmi, T., Stork, O., Pape, H., 2003. Amygdalar and hippocampal theta rhythm synchronization during fear memory retrieval. *Science* 301, 846–850.
- Shahbaba, B., Li, L., Agostinelli, F., Saraf, M., Elias, G., Baldi, P., Fortin, N., 2019. Hippocampal ensembles represent sequential relationships among discrete nonspatial events. *bioRxiv* http://dx.doi.org/10.1101/840199.
- Shindou, T., Shindou, M., Watanabe, S., Wickens, J., 2019. A silent eligibility trace enables dopamine-dependent synaptic plasticity for reinforcement learning in the mouse striatum. *Eur. J. Neurosci.* 49, 726–736.
- Siapas, A., Wilson, M., 1998. Coordinated interactions between hippocampal ripples and cortical spindles during slow-wave sleep. *Neuron* 21 (5), 1123–1128.
- Silva, D., Feng, T., Foster, D., 2015. Trajectory events across hippocampal place-cells require previous experience. *Nat. Neurosci.* 18 (12), 1772–1779.
- Singer, A., Frank, L., 2009. Rewarded outcomes enhance reactivation of experience in the hippocampus. *Neuron* 64 (6), 910–921.
- Skaggs, W.E., McNaughton, B., 1996. Theta phase precession in hippocampal neuronal populations and the compression of temporal sequences. *Hippocampus* 6, 149–172.
- Smith, D., Mizumori, S., 2006. Learning-related development of context-specific neuronal responses to places and events: the hippocampal role in context processing. *J. Neurosci.* 26 (12), 3154–3163.
- Solomon, P., Van der Schaaf, E., Thompson, R., Weisz, D., 1986. Hippocampus and trace conditioning of the rabbit's classically conditioned nictitating membrane response. *Behav. Neurosci.* 100 (5), 729–744. doi:10.1037/0735-7044.100.5.729.
- Solstad, T., Moser, E., Einevoll, G., 2006. From grid cells to place cells: A mathematical model. *Hippocampus* 16, 1026–1031.
- Stickgold, R., Walker, M., 2005. Memory consolidation and reconsolidation: what is the role of sleep? *Trends Neurosci.* 28 (8), 408–415.
- Stickgold, R., Whidbee, D., Schirmer, B., Patel, V., Hobson, J., 2000. Visual discrimination task improvement: A multi-step process occurring during sleep. *J. Cogn. Neurosci.* 12 (2), 246–254.
- Stickgold, R., Hobson, J., Fosse, R., Fosse, M., 2001. Sleep, learning, and dreams: off-line memory reprocessing. *Science* 294 (5544), 1052–1057.
- Suddendorf, T., Addis, D.R., Corballis, M.C., 2009. Mental time travel and the shaping of the human mind. *Philos. Trans. R. Soc. Lond., B, Biol. Sci.* 364 (1521), 1317–1324.
- Tam, S., Jennings, D., Bonardi, C., 2013. Dorsal hippocampal involvement in conditioned-response timing and maintenance of temporal information in the absence of the CS. *Exp. Brain Res.* 227, 547–559.
- Tam, S., Jennings, D., Bonardi, C., 2015. Effects of dorsal hippocampal damage on conditioning and conditioned-response timing: A pooled analysis. *Hippocampus* 25 (4), 444–459.
- Terada, S., Sakurai, Y., Nakahara, H., Fujisawa, S., 2017. Temporal and rate coding for discrete event sequences in the hippocampus. *Neuron* 94, 1248–1262. doi:10.1016/j.neuron.2017.05.024.

- Tiganj, Z., Jung, M., Kim, J., Howard, M., 2017. Sequential firing codes for time in rodent medial prefrontal cortex. *Cereb. Cortex* 27, 5663–5671.
- Tiganj, Z., Cromer, J., Roy, J., Miller, E., Howard, M., 2018. Compressed timeline of recent experience in monkey lateral prefrontal cortex. *J. Cogn. Neurosci.* 30 (7), 935–950.
- Tolman, E., 1948. Cognitive maps in rats and men. *Psychol. Rev.* 55 (4), 189–208.
- Tsao, A., Sugar, J., Lu, L., Wang, C., Knierim, J., Moser, M., Moser, E., 2018. Integrating time from experience in the lateral entorhinal cortex. *Nature* 561, 57–62.
- Tsodyks, M., Skaggs, W., Sejnowski, T., McNaughton, B., 1996. Population dynamics and theta rhythm phase precession of hippocampal place cell firing: a spiking neuron model. *Hippocampus* 6 (3), 271–280.
- Tsuda, I., 2001. Toward an interpretation of dynamic neural activity in terms of chaotic dynamical systems. *Behav. Brain Sci.* 24 (5), 793–810.
- Tsuda, I., 2009. Hypothesis on the functional role of chaotic transitory dynamics. *Chaos* 19 015113-1–015113-10.
- Tulving, E., 2002. Episodic memory: from mind to brain. *Ann. Rev. Psychol.* 53, 1–25.
- Vaz, A.P., Inati, S.K., Brunel, N., Zaghoul, K.A., 2019. Coupled ripple oscillations between the medial temporal lobe and neocortex retrieve human memory. *Science* 363 (6430), 975–978.
- Wallenstein, G., Hasselmo, M., 1997. Gabaergic modulation of hippocampal population activity, sequence learning, place field development, and the phase precession effect. *J. Neurophysiol.* 78 (1), 393–408.
- Wallenstein, G., Eichenbaum, H., Hasselmo, M., 1998. The hippocampus as an associator of discontinuous events. *Trends Neurosci.* 21, 317–323.
- Waniek, N., 2020. Transition scale-spaces: a computational theory for the discretized entorhinal cortex. *Neur. Comput.* 32 (2), 330–394. doi:10.1162/neco_a_01255.
- Watrous, A.J., Tandon, N., Conner, C.R., Pieters, T., Ekstrom, A.D., 2013. Frequency-specific network connectivity increases underlie accurate spatiotemporal memory retrieval. *Nat. Neurosci.* 16 (3), 349–356.
- Wiener, S., 1996. Spatial, behavioral and sensory correlates of hippocampal CA1 complex spike cell activity: implications for information processing functions. *Prog. Neurobiol.* 49 (4), 335–361.
- Wiener, S., Korshunov, V., Garcia, R., Berthoz, A., 1995. Inertial, substratal and landmark cue control of hippocampal CA1 place cell activity. *Eur. J. Neurosci.* 7, 2206–2219.
- Wilson, M., McNaughton, B., 1994. Reactivation of hippocampal ensemble memories during sleep. *Science* 265 (5172), 676–679.
- Winocur, G., Moscovitch, M., Bontempi, B., 2010. Memory formation and long-term retention in humans and animals, convergence towards a transformation account of hippocampal- neocortical interactions. *Neuropsychologia* 45 (8), 2339–2356.
- Wood, E., Dudchenko, P., Robitsek, R.J., Eichenbaum, H., 2000. Hippocampal neurons encode information about different types of memory episodes occurring in the same location. *Neuron* 27 (3), 623–633.
- Yaffe, R.B., Kerr, M.S., Damera, S., Sarma, S.V., Inati, S.K., Zaghoul, K.A., 2014. Reinstatement of distributed cortical oscillations occurs with precise spatiotemporal dynamics during successful memory retrieval. *Proc. Natl. Acad. Sci. U. S. A.* 111, 18727–18732.
- Yin, B., Meck, W., 2014. Comparison of interval timing behaviour in mice following dorsal or ventral hippocampal lesions with mice having d-opioid receptor gene deletion. *Philos. Trans. Biol. Sci.* 369 (1637), 20120466. doi:10.1098/rstb.2012.0466.
- Ylinen, A., Bragin, A., Nádasdy, Z., Jandó, G., Szabó, I., Sik, A., Buzsáki, G., 1995. Sharp wave-associated high-frequency oscillation (200 Hz) in the intact hippocampus: network and intracellular mechanisms. *J. Neurosci.* 15 (1), 30–46.
- Zhang, K., 1996. Representation of spatial orientation by the intrinsic dynamics of the head-direction cell ensemble: a theory. *J. Neurosci.* 16, 2112–2126.
- Zhang, J., Lau, P.-M., Bi, G.-Q., 2009. Gain in sensitivity and loss in temporal contrast of STDP by dopaminergic modulation at hippocampal synapses. *Proc. Natl. Acad. Sci. U. S. A.* 106 (31), 13028–13033.
- Ziv, Y., Burns, L., Cocker, E., Hamel, E., Ghosh, K., Kitch, L., El Gamal, A., Schnitzer, M., 2013. Long-term dynamics of CA1 hippocampal place codes. *Nat. Neurosci.* 16 (3), 264–266.
- Zugaro, M.B., Monconduit, L., Buzsáki, G., 2005. Spike phase precession persists after transient intrahippocampal perturbation. *Nat. Neurosci.* 8 (1), 67–71.