



HAL
open science

Flexibility assessment of a biorefinery distillation train: Optimal design under uncertain conditions

Alessandro Di Pretoro, Ludovic Montastruc, Flavio Manenti, Xavier Joulia

► To cite this version:

Alessandro Di Pretoro, Ludovic Montastruc, Flavio Manenti, Xavier Joulia. Flexibility assessment of a biorefinery distillation train: Optimal design under uncertain conditions. *Computers & Chemical Engineering*, 2020, 138, pp.106831. 10.1016/j.compchemeng.2020.106831 . hal-03116591

HAL Id: hal-03116591

<https://hal.science/hal-03116591>

Submitted on 20 Jan 2021

HAL is a multi-disciplinary open access archive for the deposit and dissemination of scientific research documents, whether they are published or not. The documents may come from teaching and research institutions in France or abroad, or from public or private research centers.

L'archive ouverte pluridisciplinaire **HAL**, est destinée au dépôt et à la diffusion de documents scientifiques de niveau recherche, publiés ou non, émanant des établissements d'enseignement et de recherche français ou étrangers, des laboratoires publics ou privés.





Open Archive Toulouse Archive Ouverte (OATAO)

OATAO is an open access repository that collects the work of Toulouse researchers and makes it freely available over the web where possible

This is an author's version published in: <http://oatao.univ-toulouse.fr/27259>

Official URL: <https://doi.org/10.1016/j.compchemeng.2020.106831>

To cite this version:

Di Pretoro, Alessandro  and Montastruc, Ludovic  and Manenti, Flavio and Joulia, Xavier  *Flexibility assessment of a biorefinery distillation train: Optimal design under uncertain conditions.* (2020) *Computers & Chemical Engineering*, 138. 106831. ISSN 0098-1354

Any correspondence concerning this service should be sent to the repository administrator: tech-oatao@listes-diff.inp-toulouse.fr

Flexibility assessment of a biorefinery distillation train: Optimal design under uncertain conditions

Alessandro Di Pretoro^{a,b}, Ludovic Montastruc^{a,*}, Flavio Manenti^b, Xavier Joulia^a

^aLaboratoire de Génie Chimique, Université de Toulouse, CNRS/INP/UPS, Toulouse, France

^bPolitecnico di Milano, Dipartimento di Chimica, Materiali e Ingegneria Chimica Giulio Natta, Piazza Leonardo da Vinci 32, Milano 20133, Italy

ARTICLE INFO

Keywords:

Flexibility
Biorefinery
Distillation
RCMs
Trains

ABSTRACT

Multicomponent mixtures can be separated into their single components by mean of different distillation system configurations. The typical distillation train design procedure consists of the assessment of the optimal columns configuration according to the economic and operational aspects. However, this optimal design is strictly related to the operating conditions, i.e. perturbations, when present, can seriously compromise the operation profitability. In these cases a flexibility analysis could be of critical importance to assess the operating conditions range of better performance for different system configurations. This is the typical case of biorefineries where the floating nature of the feedstock causes composition disturbances downstream the fermenter across the year's seasons. A brand new ABE/W mixture separation case study has been set up; this mixture derives from an upstream microbial conversion process and the successful recovery of at least biobutanol and acetone is crucial for the return on the investments. This paper then compares the possible distillation train configurations from a flexibility point of view. The analysis is focused in particular in highlighting the differences, if present, between the economic optimal solution and flexibility optimal configuration that could not be the same, causing this way a very profitable design to be much less performant under perturbed conditions. Furthermore, a detailed analysis correlating the complex thermodynamics to the operation under uncertain conditions is thoroughly discussed. The proposed design procedure allowed to highlight the differences between weak and strong flexibility constraints and resulted in a dedicated "additional costs vs. flexibility" trend useful to improve the decision making.

1. Introduction

1.1. Conventional vs flexible design procedure

The typical methodology for chemical plants design is usually made up of several steps performed in series as listed in Fig. 1. Given a preliminary feasibility assessment, the system configuration and equipment sizing is outlined according to the process specifications. If a certain number of degrees of freedom is still present, the optimal configuration or operating conditions are selected based on a total annualized costs optimization.

Process variables disturbances or uncertain operating conditions, if taken into account, are often discussed in a sensitivity analysis usually performed a posteriori. Whether the optimal design is not able enough to withstand external perturbations it can be modified at the cost of higher investments.

In case an equipment oversizing is not needed, the external duty response to process deviations is assessed during the control system design by mean of a dynamic simulation leading (hopefully) to the final project validation.

One of the main problems related to this kind of procedure is that the sensitivity analysis is carried out on a design optimized with respect to other parameters than the system flexibility. This means that the model, or simulation, to which disturbances are applied is able to predict operating conditions and the corresponding costs variations of that specific predefined configuration. Moreover, when the process simulation is not able to converge, it could be very challenging to understand if the solution failure is due to the fact that the design optimized under nominal operating conditions is not able to accommodate the perturbed variables and more variables should have been included during the optimization phase, if the specifications cannot be physically achieved under the disturbed operating conditions or if the unconverged state is simply related to an algorithm convergence issue.

* Corresponding author.

E-mail address: ludovic.montastruc@ensiacet.fr (L. Montastruc).

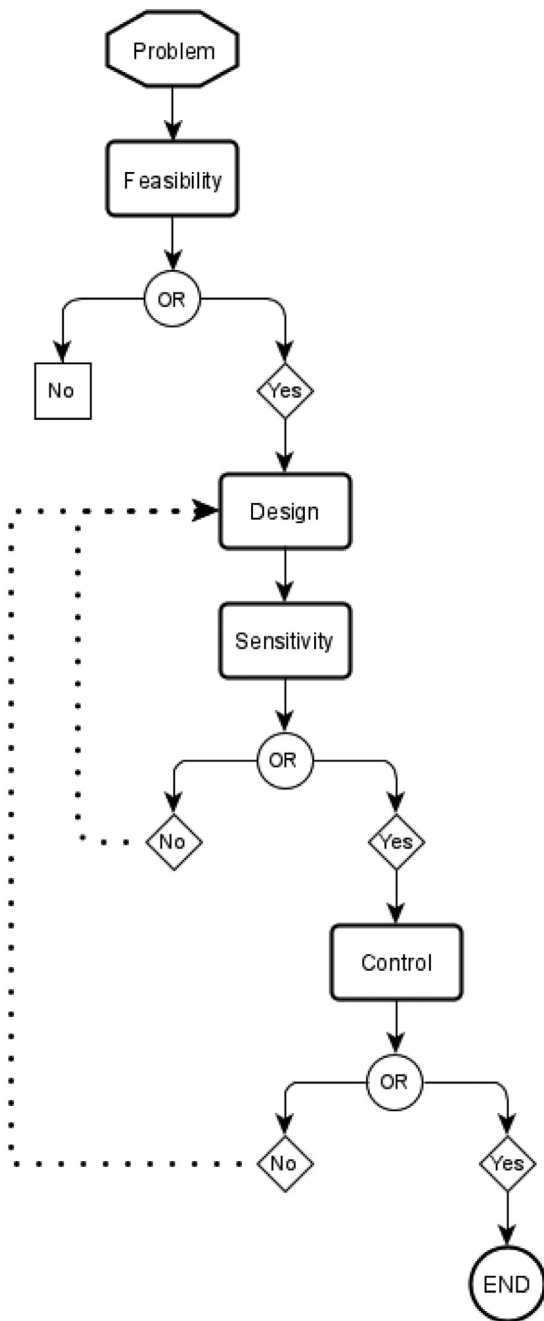

Fig. 1. Conventional design procedure.

For all those reasons, in recent years, the usual design procedure has been replaced by the flexible one as shown in Fig. 2. Flexibility is defined as the ability of a process to accommodate a set of uncertain parameters (Hoch and Eliceche, 1996) and it can be selected as one of the functions to optimize in the multi-objective optimal design.

Flexible design has become a non-negligible practice for all the systems likely to undergo perturbations or operating under uncertain conditions such as all processes based on biomass feedstocks whose nature floats across the seasons. During the last few years an extensive literature production was indeed published in order to deeply analyze the main features and applications of design under uncertainty. However, when discussing about flexibility, they usually refer to the optimal series of operations among a superstructure of alternatives or to the comparison of a discrete number

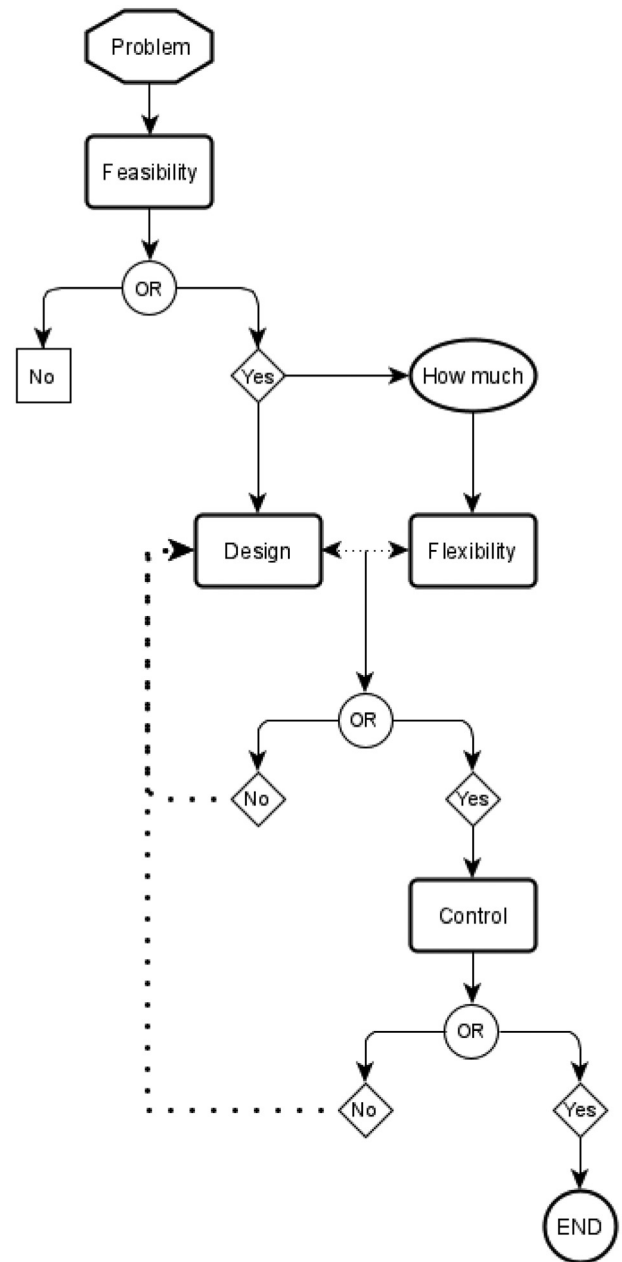

Fig. 2. Flexible design procedure.

of case studies with variable parameter values with a consequent MINLP to be solved.

A different kind of flexibility analysis can be performed by using proper flexibility indexes, discussed in the corresponding chapter 2, over a continuous uncertain variables domain and correlate them to the corresponding optimal design and related costs.

An additional way to take advantage of a flexibility assessment can be the estimation of possible existing units reuse or adaptation in case of plant revamping or production changeover.

1.2. Multicomponent mixtures separation

Among refinery operations distillation has always been the leading process for mixtures separation into their single components. In fact it is based on a well-established technical know-how, it is suitable for high plant capacity and, for a given separation ef-

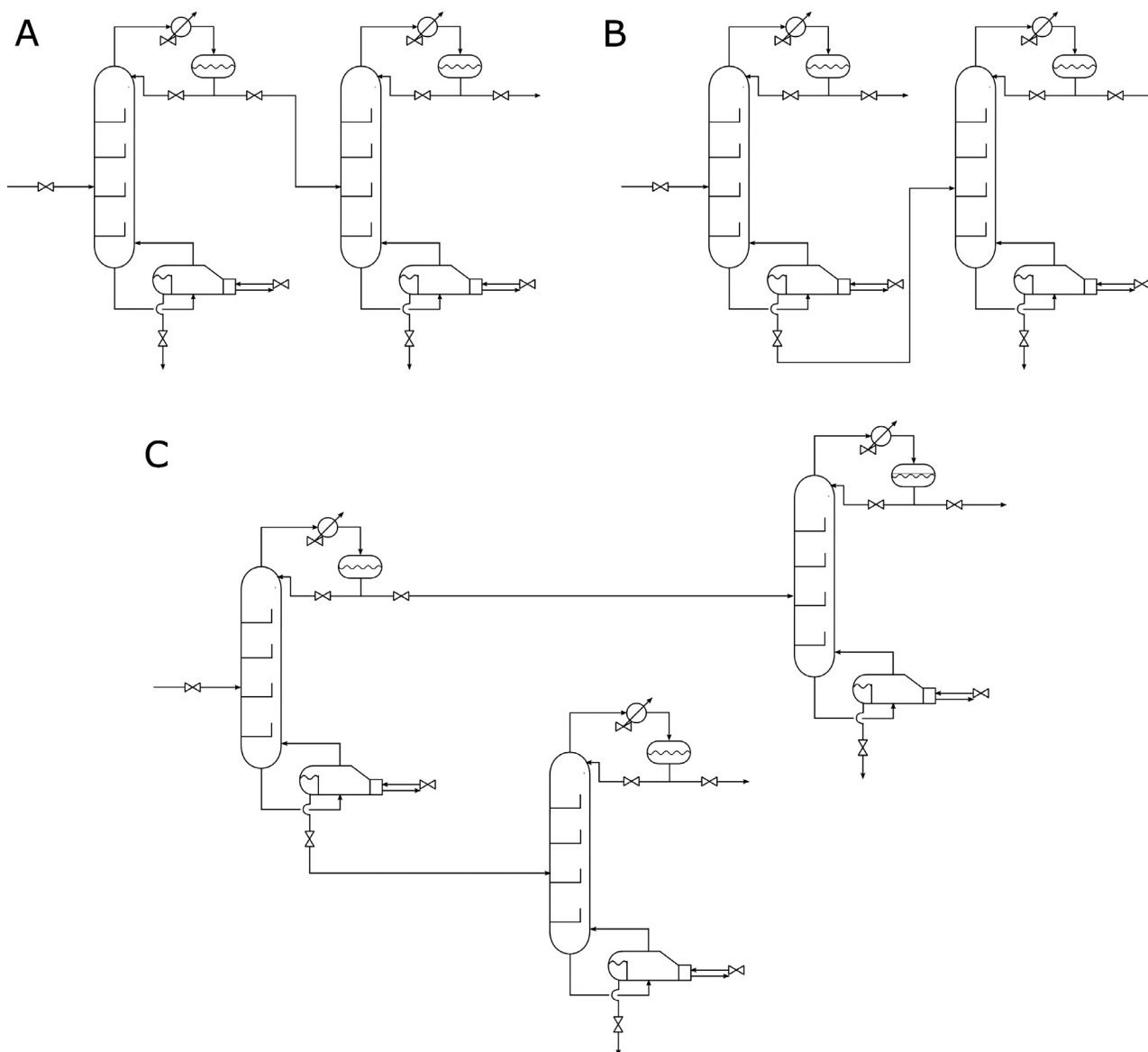

Fig. 3. Distillation train configurations for two components recovery.

efficiency, it is relatively cheap with respect to more refined operations.

Distillation trains design is the most common practice for multicomponent mixtures separation. For instance the simplest configurations in case two components should be recovered are shown in Fig. 3. defined as:

1. Indirect configuration: sequential recovery from the heaviest to the lightest component;
2. Direct configuration: sequential recovery from the lightest to the heaviest component;
3. Midsplit configuration: a preliminary split between heaviest and lightest components is performed, then the separation is refined to achieve specification.

Each column (and its related equipment) is designed on the basis of the lowest total annualized costs and the cheapest train configuration is selected as the optimal one. The main limitation of this procedure is that the economic assessment and equipment design are strictly related to the nominal operating conditions, i.e. they don't take into account feedstock or operating conditions perturbations.

The direct consequence is that, whether a feed composition perturbation occurs, the system could not be able to achieve the separation specifications or at least a relevant operating costs increase can be detected causing the most profitable design not to be as profitable as expected.

In recent years integrated solutions for multicomponent mixtures separation have become the best practice. Modern multicomponent distillation design indeed employs Petlyuk/Keybal columns (Petlyuk, 1965) or their arrangement in a single distillation column shell, also known as dividing wall column (DWC), as well as other various thermally integrated column arrangements (Kiss, 2013; Okoli and Adams, 2015; Errico et al., 2017; Le et al., 2015; Ramapriya et al., 2018).

However, although the theoretical background related to those units is wide and well-established, there's little evidence of their employment and, in particular, of the fact that they've completely replaced the traditional distillation systems. For this reason the flexibility analysis of classical distillation train and the corresponding economic assessment will be discussed in this paper with the aim of highlighting the main features and problems deriving from this procedure while the study of the design under uncertain con-

ditions of more complex integrated distillation systems will be addressed in a dedicated paper.

In refinery's operation problems related to variables uncertainty are less appreciable since long-term contracts for crude oil supplying and blending processes ensure an almost constant and stable feedstock quality.

However, during last 15 years there has been an increasing interest for the production of chemicals and fuels from renewable resources because of growing concerns about global warming and climatic change, increasing crude oil price and existing legislations restricting the use of non-renewable energy sources. The direct consequence of this trend results in an even more increasing demand for bio-based fuels and raw materials, i.e. bio-refinery processes. Bio-processes are nevertheless highly subjected to composition perturbations downstream the fermenter across the year's seasons due to the floating nature of the feedstock. Being fermentation usually carried out as a batch process, in order to ensure the desired daily productivity, several fermenters working at the same time are required. On the other hand, even when continuous fermenters are used, their scale up and then the feed flowrate that can be processed has a limit. These conditions cause the fermentation process section to be very expensive, therefore a constantly good performance of the products recovery section is of critical importance for the profitability of the plant.

In the light of the above an a priori flexibility analysis of the different distillation train configurations is non-optional for this kind of separations in order to allow the decision maker to make a multi-criteria-based choice about the optimal design to be selected.

2. Flexibility operational definition and flexibility indexes

From a process engineering point of view flexibility is defined as the ability of a process to accommodate a set of uncertain parameters (Hoch and Eliceche, 1996). As a direct consequence of this definition, flexibility can be seen as a accurate measure of feasibility.

In order to quantify this measurement an effective tool is required. For this purpose several flexibility indexes, both deterministic and stochastic, were proposed in literature. The first ones are the result of the works carried out by Swaney and Grossmann (1985) and Saboo et al. (1985). The Swaney and Grossmann flexibility index F_{SG} is defined as the maximum fraction of the expected deviation of all the uncertain variables at once that can be accommodated by the system. On the other hand the resilience index RI by Saboo et al. is defined as the largest total disturbance load, independent of the direction of the disturbance, that a system is able to withstand without becoming unfeasible. Although they look similar they evaluate different properties of the same physical system; namely the former is much more conservative since, for a given flexibility index value, the perturbation to be withstood involves all the uncertain parameters at the same time. A graphical comparison between these two different indexes can be seen in Fig. 4. From a geometrical point of view the F_{SG} index represents the distance between the nominal operating condition (the star) and the side of the maximum hyperrectangle that can be inscribed in the feasible space. On the other hand, given the maximum allowed parameter deviations independently of each other (green circles), the Resilience Index defines the distance between the operating conditions and the most constraining of them.

Since these indexes assess different properties, in order to carry out a reliable flexibility assessment, the most suitable one should be identified. As it can be deduced from their definition, the compliance of the index is necessarily related to the expected deviation nature. In any case both of them assign to any deviation type and

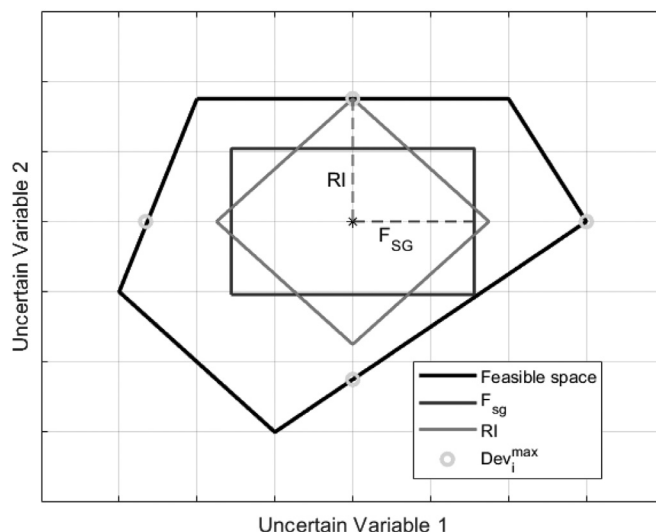

Fig. 4. Flexibility index (F_{SG}) vs Resilience Index (RI) (Di Pretoro et al., 2019).

magnitude the same likelihood (that's why they can be defined as "deterministic").

The need of estimating the perturbation likelihood was fulfilled by the introduction of a stochastic flexibility index SF proposed by Pistikopoulos and Mazzuchi (1990). It is defined as the integral of the deviation probability density function over the feasible domain. The price to pay to use such a detailed index is the need to know the required probability function that is seldom available. In order to outline this probability function there are two main possible procedures:

- Data collection of the system disturbances and consequent fitting with the most compliant PDF form in order to obtain the corresponding parameters;
- A priori selection of a PDF according to the state of information (e.g. symmetric or skew PDF, normal distribution etc.) and parameters calculation according to reasonable hypothesis (e.g. maximum probability value under nominal operating conditions, variance selection in order to have almost the entire perturbation likelihood within the maximum deviation range etc)

In order to better understand the stochastic flexibility index a simple heat exchanger case study is shown in Fig. 5. The feasibility constraint is represented by the heat transfer area of the available heat exchanger (red hyperbolic surface) according to the characteristic equation:

$$A = \frac{Q}{U \cdot \Delta T_{lm}}$$

As it can be noticed, a positive deviation of the cooling water temperature or a negative deviation of the heat transfer coefficient make the cooling operation unfeasible. The stochastic flexibility index SF is then represented by the integral of the probability distribution function (colored Gaussian bell curve) over the right side of the uncertain space.

Finally a volumetric flexibility index F_V , whose properties can be associated to the stochastic one, was introduced by Lai and Hui (2008, 2007). It is defined as the fraction of the expected deviation volume contained in the feasible domain. A more complete review about these indexes and a thorough procedure to integrate them in the distillation column design were provided by Di Pretoro et al. (2019).

After the flexibility assessment an economic analysis needs to be performed in order to evaluate the additional costs related to a

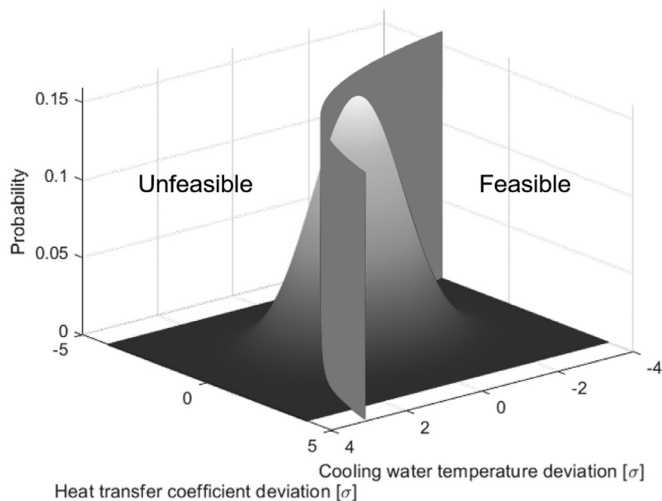

Fig. 5. Stochastic Flexibility (SF) assessment of a heat exchanger (Di Pretoro et al., 2019).

more flexible design. In case of deterministic indexes the distillation train design for which capital and operating costs should be estimated is univocally determined. On the contrary, if a stochastic index is employed, several design could lead to the same SF value. An economic optimization is thus required at each stochastic flexibility analysis step in order to find the cheapest system design providing the same SF value. This procedure corresponds to looking for the most flexible configuration for a given additional cost.

If cost minimization is not the most interesting or constraining condition a different constraint (e.g. controllability, energy consumption etc) should be provided in any case to fulfill the remaining degree of freedom of the flexibility problem. In the presented case study when the “x” stochastic flexibility design is discussed it will be referred to the cheapest design corresponding to the “x” SF value.

Capital and operating costs for the flexibility and economic based design coupling have been estimated using (Guthrie, 1969; 1974; Ulrich, 1984; Navarrete and Cole, 2001) correlations. For further detail please refer to the dedicated section in the Appendix Appendix B.

3. The biorefinery case study

Several interesting flexibility analysis and design applications to distillation trains have been found in literature (Adams et al., 2018; Benz and Cerda, 1992; Caballero and Grossmann, 2001). However, when talking about flexibility, they almost refer to the optimal operation sequencing or to the optimal system configuration with respect to a given number of different operating conditions. The main purpose of this paper instead is to assess the performances of several configurations under a continuous wide range of operating conditions. In order to do that, a new case study referring to the separation of an ABE/W (acetone, n-butanol, ethanol, water) mixture has been outlined. The history of ABE fermentation and its industrial applications during the 20th century are wide and complex. In 1912 Chaim Weizmann succeeded in isolating a bacterium strain (later named *Clostridium acetobutylicum*) which was capable of using starch as a substrate in the butanol production process with higher butanol and acetone product yields with respect to the previous ones. The fermentation process via *Clostridium acetobutylicum* replaced then the previous technology and, with some modifications, it is still the base for the industrial fermentation applications (Gabriel and Crawford, 1930). However, later studies highlighted that these microorganisms used in ABE fermentation

Table 1
Feed composition and physical properties.

Component/Property	Value	Unit
Acetone	12.030	mol/s
n-Butanol	61.328	mol/s
Ethanol	3.839	mol/s
Water	12.428	mol/s
Pressure	101.325	kPa
Temperature	361.26	K

still suffer from product inhibition, giving a low acetone and butanol final concentration. A complete review about this process and its future perspectives is provided by García et al. (2011).

Due to the high alcohols dilution in the fermentation broth a dewatering extraction column is present downstream the fermenter and before the distillation train. For the same reason the effectiveness of the separation process is a critical variable for the fraction and purity of recovered product.

Biorefinery operations are particularly suitable for flexibility assessment due to the feedstock composition fluctuations during the year as a consequence of the different biomasses to be treated. On the other hand feed perturbations can be also seen as the result of a lower effectiveness in the preliminary dewatering process. In fact, as discussed by Dalle Ave and Adams (2018), the outlet fermenter composition is strictly related to the selected extractant and to stable operating conditions. However this study will address the entire uncertain domain for water and n-butanol partial flowrates in order to provide a complete overview that could be adapted to different extraction layouts.

Even though the ABE process is a well-established technology and it has been widely studied during the last years, it still results to be one of the most suitable examples for the addressed flexibility assessment due to its highly non-ideal thermodynamics. Due to the presence of homogeneous and heterogeneous azeotropes, liquid-liquid equilibrium and complex activity model, if the system flexibility were evaluated through a sensitivity analysis, it would be very difficult to understand whether the failure to achieve a physical results is due to the actual impossibility of the system to attain the desired specification or to the inability of the algorithm to converge. Further details about thermodynamic flexibility will be then discussed in the corresponding Section 4.

The nominal feed composition and properties related to this case study are listed in Table 1.

The successful recovery of at least biobutanol and acetone is considered crucial for the profitability of the operation. In order to accomplish this task, a minimum of two distillation columns are required and three configurations are possible as previously shown in Fig. 3.

Midsplit configuration specifications are as follows:

- 1) Split column:
 - (a) Acetone recovery ratio in the distillate: 0.995;
 - (b) n-Butanol recovery ratio in the bottom: 0.98;
- 2) Acetone recovery column (top column):
 - (a) Acetone recovery ratio in the distillate: 0.995;
 - (b) Distillate acetone mass fraction: 0.995;
- 3) n-Butanol recovery column (bottom column):
 - (a) n-Butanol recovery ratio in the bottom: 0.98;
 - (b) Bottom n-butanol mass fraction: 0.99.

Specifications for direct and indirect configuration can be easily deduced from the midsplit ones.

The direct configuration resulted unfeasible under nominal operating conditions. The presence of acetone in the ABE/W mixture improves the separation performance, thus its preliminary removal moves the feed composition of the second column closer to the

distillation region boundary (cf chapter 4) causing the desired butanol recovery at the designed purity to be impossible. Only indirect and midsplit configurations will be then discussed and compared.

As already mentioned, the complexity of the proposed case study, mainly caused by its highly non-ideal physical behaviour, results in the impossibility to obtain the desired split specifications independently on the operating conditions. This particular circumstances forces us to find a dedicated tool in order to preliminary assess the physical process limitations (strong flexibility constraints).

The selected methodology to perform the thermodynamic assessment will be then described in detail in the following ad-hoc chapter; in case of mixtures with no singular points, this analysis wouldn't be needed since all sharp splits would be possible with a sufficiently high number of equilibrium stages.

4. Thermodynamic flexibility analysis

4.1. RCMs overview

Thermodynamics of multicomponent mixtures is an ever-present research field in distillation theory. A widespread and well established tool to assess whether a mixture can be separated by distillation is the use of Residue Curve Maps (RCMs) on phase diagrams, usually ternary or quaternary. Despite their usefulness and the robustness of the theory behind them and although they are the more immediate and effective way to analyze the constraints of azeotropic multicomponent systems, RCMs have received relatively poor attention from engineers. These lines were introduced first by Ostwald (1900) and Schreinemakers (1901) to describe the thermodynamic behavior of three-component azeotropic mixtures but only after half a century Gurikov (1958) developed the first classification of three-component residue curve diagrams. Later Zharov (1967, 1968a, 1968b) and Serafimov (1969), Zharov and Serafimov (1975) generalized their application to the analysis and classification of four or higher multicomponent mixtures. However, most of these works were in Russian and were not available in the other countries. The application of residue curve bundles to reversible distillation and to finite reflux distillation column optimal design is due to (Petlyuk, 2004) and the following discussion will mainly refer to its works.

A residue curve is defined as the locus of compositions satisfying the equation:

$$\frac{dx_i}{d\xi} = x_i - y_i \quad (1)$$

It represents both the change in a mixture composition during an open distillation process and the composition profile of an infinite column at infinite reflux. Each point of this line corresponds to a certain moment of time and to a portion of evaporated liquid as well as to an equilibrium tray of an infinite distillation column. RCMs are convenient for the description of phase equilibrium because they are continuous and noncrossing.

In order to clarify how to read a phase diagram when residue curve mapping is performed a few notation details by referring to Fig. 6 will follow.

- Stable nodes (square): a stationary point at which all residue curves come to an end (the heavy compound (or pseudo-compound) of a distillation bundle);
- Unstable nodes (circle): a stationary point at which all residue curves start (the light compound (or pseudo-compound) of a distillation bundle);
- Saddles (triangle): a stationary point to which residue curves come close but neither start nor end;

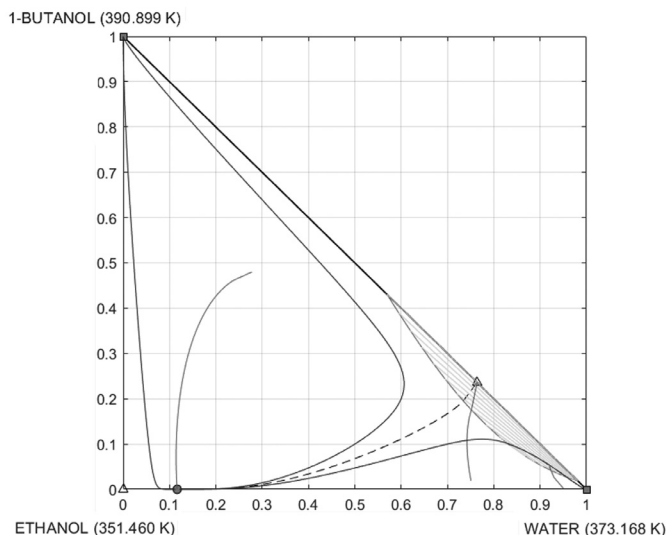

Fig. 6. RCMs on a ternary diagram.

- Separatrix (black line): a boundary separating one bundle from another. In contrast to the other residue curves, the separatrixes begin or come to an end, not in the node points but in the saddle points. A characteristic feature of a separatrix is that in any vicinity of its every point, no matter how small it is, there are points belonging to two different bundles of residue curves;
- Immiscibility region (Green): the composition region where two liquid phases are present. The real compositions related to the aqueous and organic phase respectively are those at the extremal points of the corresponding tie line;
- Univolatility line (Red): they are lines where $\alpha_{ij} = \frac{K_i}{K_j} = 1$. Univolatility α -lines (α -surfaces and α -hypersurfaces) divide the concentration simplex into regions of order of components Reg_{ord}^{ijk} (in Reg_{ord}^{ijk} $K_i > K_j > K_k$).

Temperature increases moving from the unstable node to the stable one (the same direction of a residue curve). A residue curves bundle is defined as a subregion with its own stable and unstable points and it is separated by another bundle of the whole concentration space by mean of a separatrix. In case of ideal mixtures the entire concentration space is filled with one RCMs bundle. From a topological point of view while residue curves keep being lines even for a four components system, the separatrix boundaries become surfaces (and hypersurfaces for higher dimension).

Separatrix lines are of critical importance to assess the distillation feasibility since they define at which side of the azeotropic composition the feed is located, i.e. the lightest and heaviest compounds that can be obtained by distillation for a given feed composition. That's why these subregions are also called distillation bundles and separatrixes are also called distillation boundaries. In general, if separatrixes have a relatively regular shape (i.e. not particularly skew) as for the vast majority of mixtures, it can be stated that separation by distillation is possible if feed, distillate and bottom composition points lie in the same distillation region (for further details about the theoretical background please refer to Petlyuk, 2004).

4.2. Thermodynamic model

As suggested by Errico et al. (2017), the selected thermodynamic model for the ABE/W mixture equilibrium description is the Non-Random Two Liquids (NRTL) (Renon and Prausnitz, 1968).

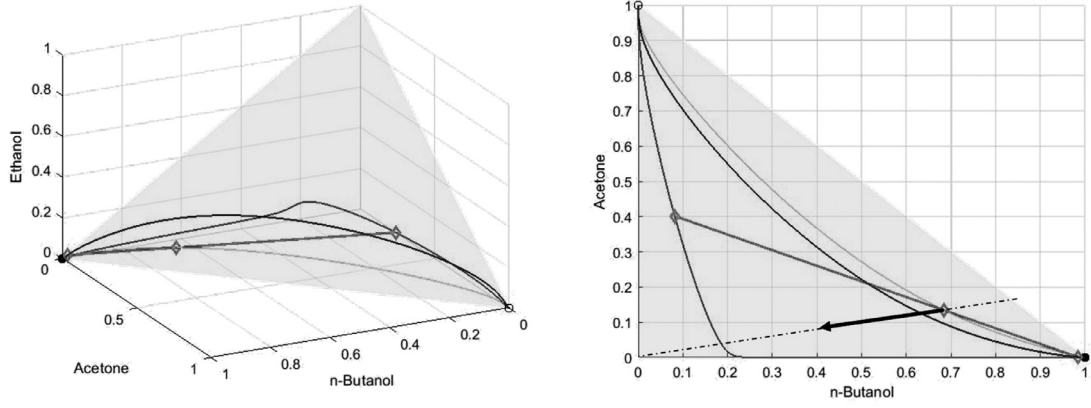

(a) Nominal operating conditions

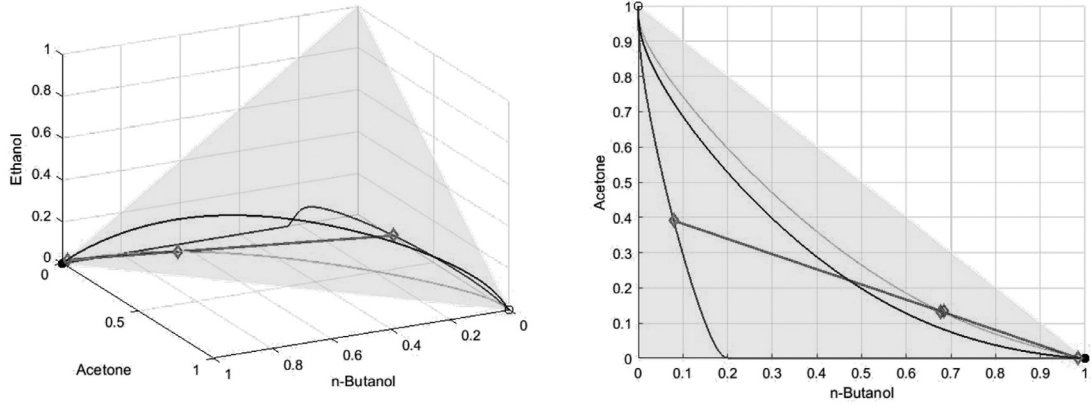

(b) Perturbed conditions (8%)

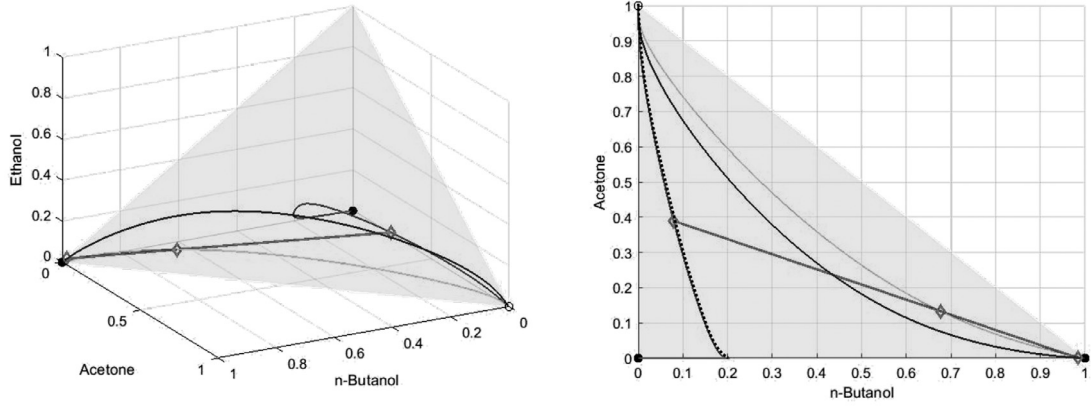

(c) Unfeasible distillation

Fig. 7. Feasibility boundaries assessment via residue curve maps.

Moreover, it results to be the most appropriate to describe water-alcohols as well as biofuels equilibria in general (Kiss, 2013; Okoli and Adams, 2015; Le et al., 2015).

The activity coefficient for the species i in a mixture of n components is given by:

$$\ln(\gamma_i) = \frac{\sum_{j=1}^{j=1} x_j \cdot \tau_{ji} \cdot G_{ji}}{\sum_{k=1}^{k=1} x_k \cdot G_{ki}} + \sum_{n=1}^{j=1} \frac{x_j \cdot G_{ij}}{\sum_{k=1}^{k=1} x_k \cdot G_{kj}} \cdot \left(\tau_{ij} - \frac{\sum_{m=1}^{m=1} x_m \cdot \tau_{mj} \cdot G_{mj}}{\sum_{k=1}^{k=1} x_k \cdot G_{kj}} \right) \quad (2)$$

where:

$$\ln(G_{ij}) = -a_{ij} \cdot \tau_{ij} \quad (3)$$

$$a_{ij} = a_{ij}^0 + a_{ij}^1 \cdot T \quad (4)$$

$$\tau_{ij} = \frac{\Delta g_{ij}}{R \cdot T} \quad (5)$$

$$\Delta g_{ij} = g_{ij} - g_{jj} = C_{ij}^0 + C_{ij}^1 \cdot T \quad (6)$$

Not all the process simulators have provided standard binary interaction parameters able to correctly describe the azeotrope location and the liquid-liquid equilibrium. Only Simulis® Thermodynamics values resulted to be reliable for the azeotropes and the liquid-liquid equilibrium prediction, but unfortunately no coefficients for the organic binary mixtures (i.e. n-Butanol-Acetone, Acetone-Ethanol, n-Butanol-Ethanol) were present. In order to have a reliable thermodynamic model, a regression was then used to adjust the missing parameters with respect to experimental equilibrium data.

As it can be noticed in Fig. 6, the NRTL activity model with the adjusted binary interaction parameters is able to correctly predict liquid-liquid demixing (green region) as well as heterogeneous (empty triangle on the Water-Butanol side) and homogeneous azeotropes (full circle on the Water-Ethanol side) at $x_{water} = 0.763$ and $x_{water} = 0.11$ respectively. These values corresponds to those obtained by Luyben (2008) for what concerns the heteroazeotrope as well as to the values reported in the Dortmund Data Bank (0000) for the homogeneous one. Moreover, the LLE described by the adjusted binary interaction parameters matches with the experimental data provided by Lee et al. (2004) and agrees with the model prediction of Kosuge and Iwakabe (2005).

4.3. Thermodynamic feasibility assessment

In the light of the above the thermodynamic feasibility assessment is straightforward. The mixture under analysis shows two azeotropes, namely the water-butanol heterogeneous azeotrope and the water-ethanol homogeneous one. Columns operating conditions and composition profiles are always far from the homogeneous azeotrope; moreover, even once butanol is removed, the presence of acetone mitigates the non-ideal behaviour of the remaining fractions. It can be then concluded that the critical operation in both midsplit and indirect configuration is the butanol separation even because the most likely perturbations downstream the fermenter are related to water and butanol relative content. Since RCMs refer to infinite columns at infinite reflux, the analysis of the sharp split AEW/B holds true for the midsplit configuration as well.

Given the feed composition and the butanol product purity the corresponding two points can be plotted in a quaternary phase diagram as shown in Fig. 7a (violet diamonds). Since recovery ratio is fixed the lever rule resulting from mass balances can be applied in order to obtain the third point related to the distillate composition. The RCMs passing through these points were then calculated and plotted as well. It can be noticed that all these RCMs have the same stable and unstable nodes, that means separation by simple distillation is possible under nominal operating conditions.

In order to assess the thermodynamic feasibility boundaries the uncertain variables need to be perturbed. The most constraining variable is the water content in the feed stream, in particular we expect the distillation to be more critical, i.e. the butanol recovery at the desired purity to be more difficult, for a higher water fraction. The increase in water partial flowrate keeping unchanged the amount of the other components in the mixture can be represented on phase diagrams by moving the feed characteristic point along the line connecting the actual feed point and the pure water vertex (cf black arrow in Fig. 7a). For an increase in the water content up to 8% the RCMs corresponding to distillate, feed and bottom still lie in the same distillation bundle as shown in Fig. 7b. When a 9% deviation is applied, on the contrary, the stable node of the residue curve related to the distillate stream moves from pure butanol to pure water, i.e. it crosses a separatrix (cf Fig. 7c). The separatrix crossing results in the impossibility of obtaining such a distillate from the given feed by mean of a distillation.

Table 2
Distillation train optimal design.

		Indirect	Midsplit
1st Column	N (feed)	16 (10)	35 (9)
	Cost (\$/y)	580 016	455 493
2nd Column	N (feed)	50 (46)	50 (47)
	Cost (\$/y)	353 493	352 224
3rd Column	N (feed)	/	16 (8)
	Cost (\$/y)	/	276 365
Total cost		933 509	1 084 082

The same analysis was carried out with respect to each of the four components. As expected, the water molar fraction resulted to be the most constraining variable from a flexibility point of view. It can be then stated that the system thermodynamic flexibility limit is about 8%. This value represents the chemico-physical constraint to this operation whatever the affordable investment to design the distillation train is. If a higher flexibility is required the only possible solution is to select a different separation process for such a mixture.

The same procedure was performed for the F_{SG} index, i.e. by simultaneously varying both butanol and water partial flowrates, and a value about 5% was found.

Residue curve maps analysis was carried out by interfacing Matlab®, used to solve the ODE system 1 and to plot the corresponding graphs, to the software Simulis® Thermodynamics aimed to provide the equilibrium data related to the NRTL model previously described.

5. Economic assessment and optimal design under uncertain conditions

As already mentioned, the ordinary design procedure has been conducted as usual: CAPital and OPERating EXPenses have been evaluated for each column of the two configurations at different numbers of stages with the optimal feed location under nominal operating conditions. Considering a life span of 10 years, for each column the number of stages corresponding to the minimum annualized cost, given by the expression

$$TAC = OPEX + \frac{CAPEX}{lifetime} \quad (7)$$

was then identified and the overall annualized cost of each configuration was calculated.

All simulations required for the columns design were carried out by mean of ProSim Plus® process simulator. An equilibrium based distillation model with no simplifying assumptions was employed. Among the several available distillation column models, the three-phase distillation column model accounting for liquid phase demixing was selected. Optimal number of stages, feed tray and relative TAC for each column of each configuration are listed in Table 2.

With a total cost of 933,509 \$/y vs 1,084,082 \$/y the indirect configuration results to be the most convenient with respect to the midsplit one under nominal operating conditions. The addition of a preliminary column indeed does not substantially affect the acetone column utilities consumption.

In order to validate this design configuration under uncertain conditions the flexibility analysis should be then performed. The most critical parameters, as already discussed in chapter 4, are water and butanol feed content, that's why their partial flowrates were selected as uncertain parameters for the analysis. The flexibility assessment results via process simulation confirmed the preliminary thermodynamic evaluation providing a F_{SG} value about 5% (4% for the midsplit) and a RI value about 8% (7% for the midsplit)

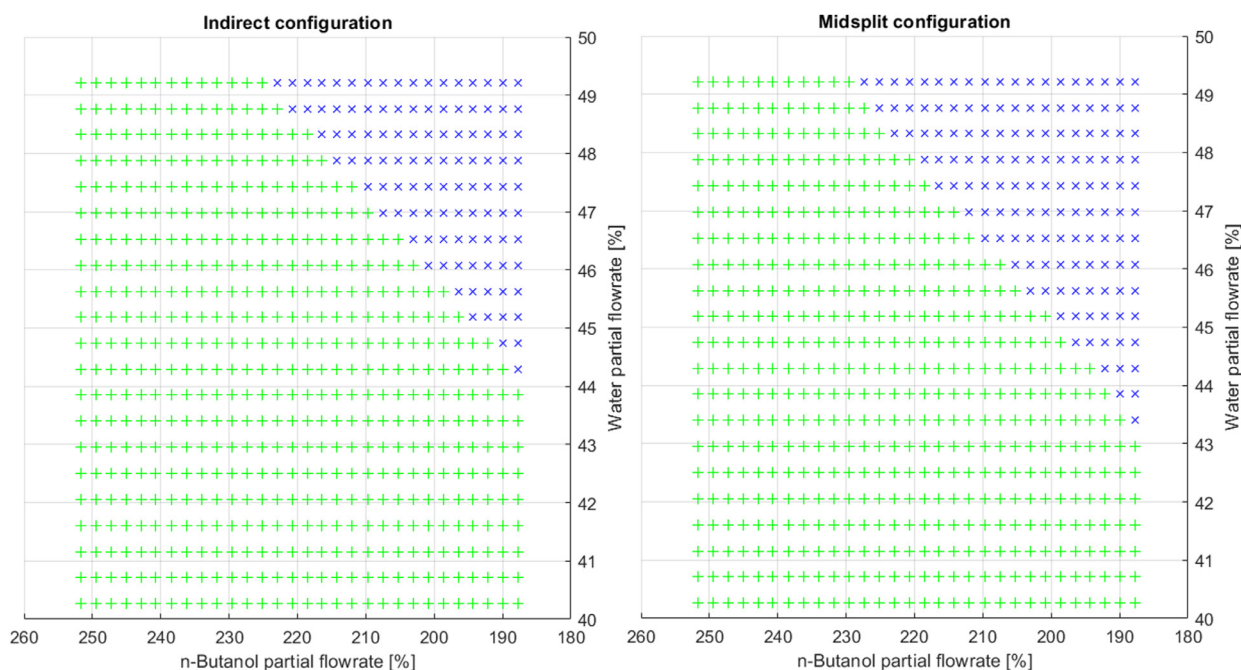

Fig. 8. Indirect vs midsplit feasibility (Green +: feasible, Blue x: unfeasible). (For interpretation of the references to color in this figure legend, the reader is referred to the web version of this article.)

for both configurations as shown in Fig. 8. With a proper deviation range discretization, several simulations were run over the whole uncertain domain by using as process variables initial guess the previously converged values in the closest point; the green squares refer to simulations that revealed themselves as feasible and operable, while blue squares correspond to operating conditions that didn't allow the specifications achievement.

In particular midsplit configuration resulted slightly less flexible due to the difficulty to recover enough acetone without the preliminary butanol removal. The stochastic index SF corresponding values are respectively 77.86% for the indirect configuration and 75.85% for the midsplit configuration in case of a perturbation normal PDF with a 10% variance (i.e. more than 99% disturbance likelihood within the 30% disturbance range). This PDF parameters were selected taking into account the higher butanol concentration boundary in the fermentation broth due to product inhibition (García et al., 2011) and in a way that water perturbations, related to the dewatering process inefficiency, affected the analysis result with a comparable magnitude. The F_V volumetric flexibility index analysis was not carried out since it can be reconducted to a particular case of the stochastic flexibility assuming a step PDF for the uncertain variables as shown by Di Pretoro et al. (2019).

Given these results the indirect configuration results slightly more flexible than the midsplit one. However, the higher flexibility of a process design is not sufficient to provide its final validation under uncertain conditions until its higher profitability is proved as well.

Flexibility analysis was then coupled to the economic assessment according to the procedure suggested by Di Pretoro et al. (2019). The costs corresponding to every perturbed operating conditions were calculated and correlated to the different flexibility values by mean of the corresponding indexes. Even in this case the cost of an additional preliminary column was not compensated by a lower utility consumption and the indirect design still results the more convenient. Total annualized costs vs. partial flowrates perturbations have been plotted for the indirect configuration in Fig. 9.

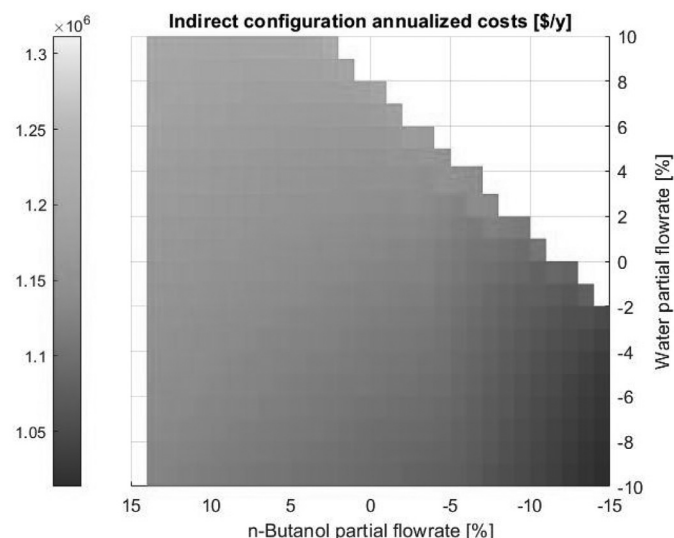

Fig. 9. Total annualized costs vs. partial flowrates perturbations.

An analogous trend with higher values was obtained for the midsplit configuration. Costs result to be higher whether a bigger oversizing is necessary, i.e. positive deviation for both water and butanol flowrates, and under operating conditions close to the feasibility boundary. Fig. 10 shows for instance the trend of the first column reboiler heat transfer surface area, that is one of the most sensitive parameters, varying over a range going from 393 to 538 m^2 , i.e. more than 35% deviation with respect to the nominal operating conditions value.

The plot resuming the indirect configuration additional cost vs. flexibility for the deterministic indexes is then reported in Fig. 11.

The shaded regions represent the flexibility limit that can't be overcome despite the affordability of a higher expense. As expected by their definition the F_{SG} index results more conservative

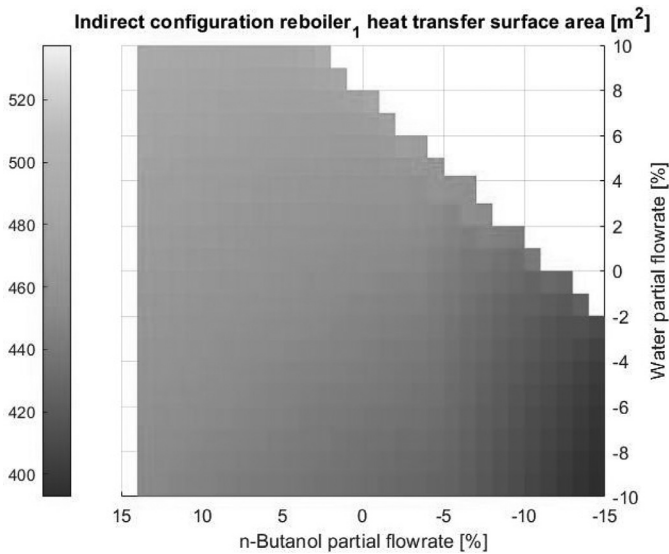

Fig. 10. First column reboiler heat transfer surface.

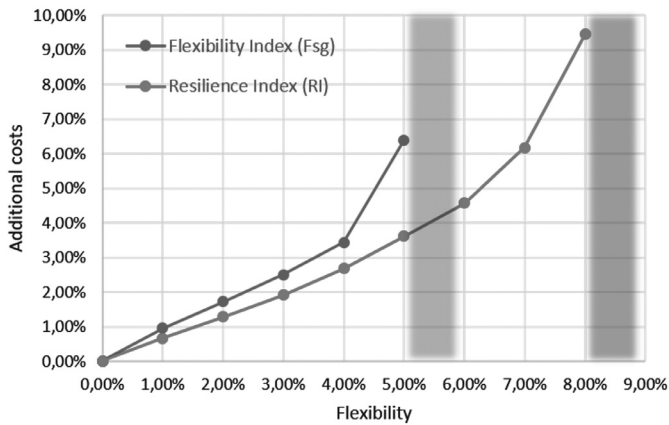

Fig. 11. Deterministic indexes economic comparison.

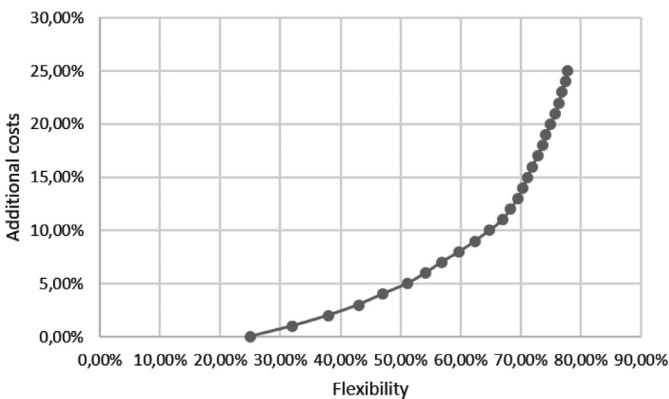

Fig. 12. Additional costs vs. stochastic flexibility.

than the *RI* one since it involves the simultaneous deviation of all the uncertain variables at once. Moreover in both cases it can be noticed that after 4% flexibility (7% for *RI*) much higher additional investments are required for a corresponding flexibility increase of 1% only.

The stochastic flexibility *SF* index trend is plotted in Fig. 12.

Differently from deterministic indexes, stochastic flexibility has non-null value even at nominal operating conditions since the de-

signed system is already able to withstand part of the negative perturbations. Another characteristic feature of this index is the asymptotical trend when *SF* approaches the feasibility boundary value. This behaviour is independent on the selected PDF and its interpretation is that an always increasing investment should be afforded if the lowest risk of underperformance has to be attained.

The conclusions that the engineer or the decision maker in general can derive from these results are different and mainly depend on his needs and his resources. In general, except if really needed, it is not profitable to design a system in the region after the cost vs. flexibility line slope increase or close to the asymptote in case *SF* is used. Moreover, if a stochastic analysis is performed, an optimal design region can be calculated as shown in (Di Pretoro et al., 2019).

An alternative solution in case of plant capacity variation across the year could be the design of more than one unit in parallel and shut down/start up scheduling optimization for some of them according to the feed to be processed. In general this option is rather expensive but in specific cases it can meet other system needs (e.g. safety, maintenance operations etc) and thus become more convenient.

6. Conclusions

The aim of this paper is to define a thorough procedure to design a distillation train under uncertain conditions. This procedure is based on an economic and flexibility multi-criteria design optimization and analysis of the possible train configurations. A biorefinery products separation section was selected as case study due to the characteristic fluctuations related to fermentation processes; in particular the object of this analysis was the ABE process since among the biomass based processes it is one of those with the most promising future perspectives according to the goals of the fossil fuel replacement politics.

An a priori thermodynamic feasibility assessment was carried out via residue curve maps to evaluate the maximum attainable flexibility from a physical point of view and its results were confirmed by process simulation. Then the standard design procedure was carried out to detect the best configuration under nominal operating conditions. It was then followed by a flexibility assessment coupled to an economic analysis to validate the result. Both deterministic and stochastic indexes have been used in order to make a comparison and provide a complete overview according to several possible perturbation natures.

The final product of this procedure is an additional costs vs. flexibility plot allowing the decision maker to make the most possible informed choice.

The indirect configuration, that was the cheapest one under nominal operating conditions, resulted to be also slightly more flexible than the midsplit configuration. The economic gap due to the additional column is not compensated by a lower external duty demand and it is conserved under uncertain conditions as well. Although this design solution provides a maximum flexibility of $F_{SG} = 5\%$ ($RI = 8\%$ and $SF = 77.86\%$) it can be stated that beyond $F_{SG} = 4\%$ ($RI = 7\%$ and $SF = 67\%$) it is less worth investing since the additional costs line becomes steeper.

Beside the numerical results, the outcome of general validity is that, in thermodynamically constrained system, the feasibility and flexibility boundaries cannot go over a certain value by investing more. An a priori flexibility analysis and economic assessment could then be crucial for making the best design choice and to know the system limitation if perturbations are likely to occur.

Finally it is worth remarking that, even if the provided results are case specific, the proposed procedure can be considered valid for any analogous case study.

Declaration of Competing Interest

The authors declare that they have no known competing financial interests or personal relationships that could have appeared to influence the work reported in this paper.

Appendix A. List of acronyms and symbols

Symbol	Definition	Unit
A	Characteristic dimension	m^n
ABE/W	Acetone-Butanol-Ethanol/Water	Acronym
a_{ij}	NRTL non-randomness parameters	1
CAPEX	Capital Expenses	\$
C_{ij}^n	Excess Gibbs energy coefficients	$J/(mol \cdot K^n)$
C_{BM}	Equipment bare module cost	\$
C_P^0	Purchase equipment cost in base conditions	\$
F_{BM}	Bare module factor	1
F_M	Material factor	1
F_P	Pressure factor	1
F_q	Column trays factor	1
F_{SG}	Swaney & Grossmann flexibility index	1
F_V	Lai & Hui flexibility index	1
g_{ij}	NRTL excess Gibbs energy	J/mol
K_i	Vapor-liquid distribution ratio	1
LLE	Liquid-Liquid Equilibrium	Acronym
MINLP	Mixed Integer Non-Linear Programming	Acronym
M&S	Marshall & Swift cost index	1
NDF	Normal distribution function	Function
NRTL	Non-Random Two Liquids	Acronym
ODE	Ordinary Differential Equation	Acronym
OPEX	OPERating EXpenses	\$/y
P	Pressure	bar
PDF	Probability distribution function	Function
Q	Exchanged heat duty	W
R	Gas constant	$J/(mol \cdot K)$
RCM	Residue Curve Map	Function
Reg_{ord}^{ijk}	Region of order of components	\
RI	Resilience index	1
SF	Stochastic flexibility index	1
U	Heat transfer coefficient	$W/(m^2 \cdot K)$
T	Temperature	K
TAC	Total Annualized Cost	\$/y
ΔT_{lm}	Logarithmic mean temperature difference	K
x_i	Liquid molar fraction	1
y_i	Vapor molar fraction	1
α_{ij}	Relative volatility	1
ξ	RCMs integration variable	s
τ_{ij}	NRTL dimensionless interaction parameter	1

Appendix B. Capital costs estimations

In order to evaluate the investment cost required for the whole system or make any kind of economic consideration and comparison, the cost of every single unit needs to be estimated.

For this purpose the Guthrie-Ulrich-Navarrete correlations described in the next paragraphs will be used (Guthrie, 1969; 1974; Ulrich, 1984; Navarrete and Cole, 2001).

B1. Purchase equipment cost in base conditions

The purchase equipment cost in base conditions is obtained by mean of the following equation:

$$\log_{10}(C_P^0[\$]) = K_1 + K_2 \cdot \log_{10}(A) + K_3 \cdot [\log_{10}(A)]^2 \quad (B.1)$$

where A is the characteristic dimension and the K_i coefficients are relative to the equipment typology (cf. Table 3).

The provided coefficients refer to the year 2001 and to a M&S index equal to 1110. In order to update the costs estimation to the year 2016 calculations will refer to a M&S index equal to 1245.2 by mean of the correlation:

$$C_{P,2}^0 = \frac{M\&S_2}{M\&S_1} \cdot C_{P,1}^0 \quad (B.2)$$

Table 3

Equipment cost in base conditions parameters.

Equipment	Typology	K_1	K_2	K_3	A
Heat exchanger	Fixed tubes	4.3247	-0.3030	0.1634	Heat transfer area [m^2]
	Kettle	4.4646	-0.5277	0.3955	Heat transfer area [m^2]
Columns (vessel) Trays	Packed/tray	3.4974	0.4485	0.1074	Volume [m^3]
	Sieved	2.9949	0.4465	0.3961	Cross sectional area [m^2]

Table 4

Bare module parameters.

Equipment	Typology	B_1	B_2	F_M	F_P
Heat exchanger	Fixed tubes	1.63	1.66	1	1
	Kettle	1.63	1.66	1	$F_{P,Kettle}$
Columns/vessel	/	2.25	1.82	1	1
Pumps	Centrifugal	1.89	1.35	1.5	1

B2. Bare module cost

The equipment bare module cost can be calculated according to the following correlation:

$$C_{BM} = C_P^0 \cdot F_{BM} \quad (B.3)$$

where the bare module factor is given by:

$$F_{BM} = B_1 + B_2 \cdot F_M \cdot F_P \quad (B.4)$$

The F_M and F_P factors refers to the actual constructions materials and operating pressure while the B_i coefficients refers to the equipment typology (cf. Table 4).

The $F_{P,Kettle}$ value is given by:

$$\log_{10}(F_P) = 0.03881 - 0.11272 \cdot \log_{10}(P) + 0.08183 \cdot [\log_{10}(P)]^2 \quad (B.5)$$

where P is the relative pressure in bar.

For column trays bare module cost a slightly different correlation should be used:

$$C_{BM} = N \cdot C_P^0 \cdot F'_{BM} \cdot F_q \quad (B.6)$$

where N is the real trays number, $F_{BM} = 1$ e F_q is given by the correlation:

$$\log_{10}(F_q) = 0.4771 + 0.08561 \cdot \log_{10}(N) - 0.3473 \cdot [\log_{10}(N)]^2 \quad \text{if } N < 20 \quad (B.7)$$

$$F_q = 1 \quad \text{if } N \geq 20 \quad (B.8)$$

Supplementary material

Supplementary material associated with this article can be found, in the online version, at doi:10.1016/j.compchemeng.2020.106831.

CRedit authorship contribution statement

Alessandro Di Pretoro: Conceptualization, Methodology, Writing - original draft. **Ludovic Montastruc:** Conceptualization, Methodology, Writing - review & editing. **Flavio Manenti:** Supervision. **Xavier Joulia:** Conceptualization, Methodology, Writing - review & editing, Supervision.

References

- Adams II, T.A., Thatho, T., Le Feuvre, M.C., Swartz, C.L.E., 2018. The optimal design of a distillation system for the flexible polygeneration of dimethyl ether and methanol under uncertainty. *Front. Energy Res.* 6. doi:10.3389/ferg.2018.00041.
- Benz, S.J., Cerda, J., 1992. Optimal synthesis of flexible heat-integrated distillation trains. *Comput. Chem. Eng.* 16, 753–776. doi:10.1016/0098-1354(92)80059-I.
- Caballero, J.A., Grossmann, I.E., 2001. Generalized disjunctive programming model for the optimal synthesis of thermally linked distillation columns. *Ind. Eng. Chem. Res.* 40, 2260–2274. doi:10.1021/ie000761a.
- Dalle Ave, G., Adams, T.A., 2018. Techno-economic comparison of acetone-butanol-ethanol fermentation using various extractants. *Energy Convers. Manage.* 156, 288–300. doi:10.1016/j.enconman.2017.11.020.
- Di Pretoro, A., Montastruc, L., Manenti, F., Joulia, X., 2019. Flexibility analysis of a distillation column: indexes comparison and economic assessment. *Comput. Chem. Eng.* 124, 93–108. doi:10.1016/j.compchemeng.2019.02.004.
- Dortmund Data Bank. www.ddbst.de.
- Errico, M., Sanchez-Ramirez, E., Quiroz-Ramirez, J.J., Rong, B.-G., Segovia-Hernandez, J.G., 2017. Multiobjective optimal acetone-butanol-ethanol separation systems using liquid-liquid extraction-assisted divided wall columns. *Ind. Eng. Chem. Res.* 56, 11575–11583. doi:10.1021/acs.iecr.7b03078.
- Gabriel, C.L., Crawford, F.M., 1930. Development of the butyl-acetonic fermentation industry. *Ind. Eng. Chem* 22, 1163–1165.
- García, V., Pääkkilä, J., Ojamo, H., Muurinen, E., Keiski, R.L., 2011. Challenges in biobutanol production: how to improve the efficiency? *Renew. Sustain. Energy Rev.* 15, 964–980. doi:10.1016/j.rser.2010.11.008.
- Gurikov, Y.V., 1958. Some questions concerning the structure of two-phase liquid-vapor equilibrium diagrams of ternary homogeneous solutions. *J. Phys. Chem.* 32, 1980–1996.
- Guthrie, K.M., 1969. Capital cost estimating. *Chem. Eng.* 76 (3), 114–142.
- Guthrie, K.M., 1974. *Process Plant Estimating, Evaluation, and Control*. Craftsman Book Company of America.
- Hoch, P.M., Eliceche, A.M., 1996. Flexibility analysis leads to a sizing strategy in distillation columns. *Comput. Chem. Eng.* 20, S139–S144. doi:10.1016/0098-1354(96)00034-8.
- Kiss, A.A., 2013. Novel applications of dividing-wall column technology to biofuel production processes. *J. Chem. Technol. Biotechnol.* 88, 1387.
- Kosuge, H., Iwakabe, K., 2005. Estimation of isobaric vapor-liquid-liquid equilibria for partially miscible mixture of ternary system. *Fluid Phase Equilib.* 233, 47–55. doi:10.1016/j.fluid.2005.04.010.
- Lai, S. M., & Hui, C. W. (2007). Measurement of plant flexibility.
- Lai, S.M., Hui, C.W., 2008. Process flexibility for multivariable systems. *Ind. Eng. Chem. Res.* 47, 4170–4183. doi:10.1021/ie070183z.
- Le, Q.-K., Halvorsen, I.J., Pajalic, O., Skogestad, S., 2015. Dividing wall columns for heterogeneous azeotropic distillation. *Chem. Eng. Res. Des.* 99, 111–119. doi:10.1016/j.cherd.2015.03.022.
- Lee, M.-J., Tsai, L.-H., Hong, G.-B., Lin, H.M., 2004. Multiphase equilibria for binary and ternary mixtures containing propionic acid, n-butanol, butyl propionate, and water. *Fluid Phase Equilib.* 216, 219–228. doi:10.1016/j.fluid.2003.09.009.
- Luyben, W.L., 2008. Control of the heterogeneous azeotropic n-butanol/water distillation system. *Energy Fuels* 22, 4249–4258. doi:10.1021/ef8004064.
- Navarrete, P.F., Cole, W.C., 2001. *Planning, Estimating, and Control of Chemical Construction Projects*. 2nd Edition, CRC Press.
- Okoli, C.O., Adams, T.A., 2015. II Design of dividing wall columns for butanol recovery in a thermochemical biomass to butanol process. *Chem. Eng. Process.* 95, 302.
- Ostwald, W., 1900. *Dampfdrucke ternärer gemische, abhandlungen der mathematisch-physischen classe derkonige sachsichen. Gesellschaft derWissenschaften*, 25, 413–453.
- Petlyuk, F.B., 1965. Thermodynamically optimal method for separating multicomponent mixtures. *Int. Chem. Eng.* 5, 555–561.
- Petlyuk, F.B., 2004. *Distillation Theory and its Application to Optimal Design of Separation Units*. Cambridge University Press.
- Pistikopoulos, E.N., Mazzuchi, T.A., 1990. A novel flexibility analysis approach for processes with stochastic parameters. *Comput. Chem. Eng.* 14, 991–1000. doi:10.1016/0098-1354(90)87055-T.
- Ramapriya, G.M., Tawarmalani, M., Agrawal, R., 2018. A systematic method to synthesize all dividing wall columns for n-component separation: part II. *AIChE J.* 64, 660–672. doi:10.1002/aic.15963.
- Renon, H., Prausnitz, J.M., 1968. Local compositions in thermodynamic excess functions for liquid mixtures. *AIChE J.* 14 (1), 135–144.
- Saboo, A.K., Morari, M., Woodcock, D., 1985. Design of resilient processing plants.8. A resilience index for heat-exchanger networks. *Chem. Eng. Sci.* 40, 1553–1565. doi:10.1016/0009-2509(85)80097-X.
- Schreinemakers, F.A.H., 1901. *Dampfdrucke ternärer gemische*. *J. Phys. Chem.* 36, 413–449.
- Serafimov, L.A., 1969. The azeotropic rule and the classification of multicomponent mixtures. 4. N-component mixtures. *J. Phys. Chem.* 43, 981–983.
- Swaney, R.E., Grossmann, I.E., 1985. An index for operational flexibility in chemical process design. Part i: formulation and theory. *AIChE J.* 31, 621–630. doi:10.1002/aic.690310412.
- Ulrich, G.D., 1984. *A Guide to Chemical Engineering Process Design and Economics*. Wiley.
- Zharov, V.T., 1967. Free evaporation of homogeneous multicomponent solutions. *J. Phys. Chem.* 41, 1539–1555.
- Zharov, V.T., 1968a. Free evaporation of homogeneous multicomponent. Solutions. 2. Four-component systems. *J. Phys. Chem.* 42, 58–70.
- Zharov, V.T., 1968b. Free evaporation of homogeneous multicomponent solutions. 3. Behavior of distillation lines near singular points. *J. Phys. Chem.* 42, 195–211.
- Zharov, V.T., Serafimov, L.A., 1975. *Physico-Chemical Foundations of Bath Open Distillation and Distillation*. Leningrad: Khimiya (Rus.).