



**HAL**  
open science

## Development and validation of the numerical model of an innovative PCM based thermal storage system

Letizia Roccamena, Mohamed El Mankibi, Nikolaos Stathopoulos

### ► To cite this version:

Letizia Roccamena, Mohamed El Mankibi, Nikolaos Stathopoulos. Development and validation of the numerical model of an innovative PCM based thermal storage system. *Journal of Energy Storage*, 2019, 24, pp.100740. 10.1016/j.est.2019.04.014 . hal-03116406

**HAL Id: hal-03116406**

**<https://hal.science/hal-03116406>**

Submitted on 22 Oct 2021

**HAL** is a multi-disciplinary open access archive for the deposit and dissemination of scientific research documents, whether they are published or not. The documents may come from teaching and research institutions in France or abroad, or from public or private research centers.

L'archive ouverte pluridisciplinaire **HAL**, est destinée au dépôt et à la diffusion de documents scientifiques de niveau recherche, publiés ou non, émanant des établissements d'enseignement et de recherche français ou étrangers, des laboratoires publics ou privés.



Distributed under a Creative Commons Attribution - NonCommercial 4.0 International License

# 1 Development and validation of the numerical model of an innovative PCM 2 based thermal storage system

3 *Letizia Roccamena<sup>a\*</sup>, Mohamed El Mankibi<sup>a</sup>, Nikolaos Stathopoulos<sup>b</sup>*

4  
5 <sup>a</sup>Laboratory of Tribology and Systems Dynamics (LTDS), Ecole Nationale des Travaux  
6 Publics de l'État (ENTPE), 3 Rue Maurice Audin, Vaulx-en-Velin, France

7 <sup>b</sup>Department of Architecture and Civil Engineering, Sven Hultins gata 6, Chalmers University  
8 of Technology, Division of Building Technology, Gothenburg, SE-412 96, Sweden

9 \*Corresponding author. E-mail address: [letizia.roccamena@entpe.fr](mailto:letizia.roccamena@entpe.fr)

## 10 ABSTRACT

11 Because of the high costs of experimental tests in the real conditions of buildings, numerical  
12 simulation, developed analytical methods and different modelling studies are needed to  
13 predict the behaviour and results of phase change materials (PCMs) usage in buildings in  
14 order to optimize the thermal energy storage techniques and to make them more efficient and  
15 cost-effective. The aim of this study is to develop a numerical model reproducing the  
16 behaviour of an innovative water-PCM heat exchanger for cooling purposes particularly  
17 created for HIKARI, the first positive energy, mixed use district in France. Once numerically  
18 calibrated and experimentally validated, this model was used to optimize the system's  
19 technology applying Genetic Algorithms methods. The model presented in this article was  
20 developed based on the heat balance approach and solved using the finite difference method.  
21 It was validated both numerically, using a Computational Fluid Dynamics model and  
22 experimentally using both the results of an innovative experimental prototype designed and  
23 constructed in laboratory conditions and HIKARI in situ monitoring results. The Normalized  
24 Mean Bias Error and the Coefficient of Variation of the Root Mean Squared Error, used to  
25 analyse the validation results, show that the choice of the heat balance approach provided a  
26 valid model able to reproduce the PCM-water heat exchange with high accuracy.

## 27 KEYWORDS

28 PCM, Thermal storage, Modelling, Numerical validation, Experimental validation

29

30 1. INTRODUCTION

31 Thermal energy storage (TES) is a technology that can enable greater and more efficient use  
32 of renewable energy sources by matching the energy supply with the demand, as it consists of  
33 stocking thermal energy by heating a material (the “Heat Storage Medium”) capable to release  
34 the stored thermal energy at a later time. In this way, this technology can help balance energy  
35 consumption and reduce peak demand, CO<sub>2</sub> emissions and costs, while increasing overall  
36 efficiency of energy systems [1-4]. In view of this, TES is considered one of the most  
37 promising technologies, as it can play a key role in energy efficient buildings by stocking  
38 thermal energy in order to reduce indoor air temperature fluctuation or reinstating it to the  
39 system (building, district, and town) at a later period with an hourly, daily or even seasonal  
40 time lag [5-8].

41 The current study aims to design, model and numerically and experimentally validate a water  
42 /PCM heat exchanger with TES purposes [9]. This system is part of the multi-energy  
43 production and storage systems of HIKARI project (Figure 1), a positive energy district  
44 located in Lyon consisting of three buildings, combining commercial, residential and office  
45 usage [10].

46

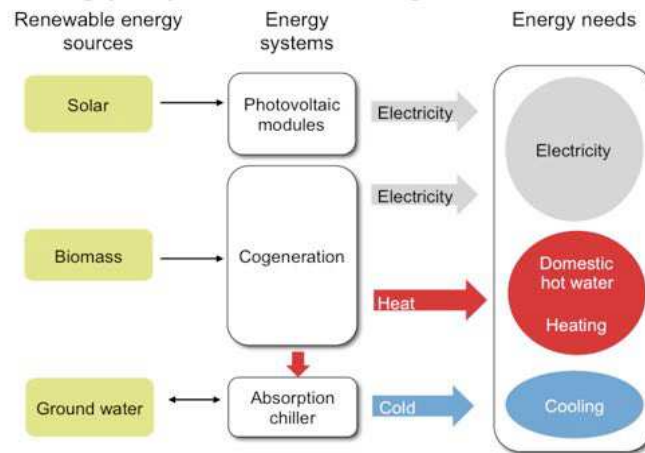

47 *Figure 1 - Overview of the HIKARI energy system design.*

48

49 The scheme of the HVAC technology of the HIKARI district is shown in Figure 2. The  
50 cooling system includes an absorption chiller, an adiabatic dry cooler, a vapor-compression  
51 refrigeration system and a storage system, while the heating system includes a cogeneration  
52 unit feed with rapeseed oil, a gas boiler (that is connected to the absorption chiller) and a  
53 storage system. The PCM based thermal storage system at low temperatures (indicated in the  
54 green circle) is connected to the HIKARI’s absorption chiller (46kW) that provides the water  
55 during the charging and discharging phases. This cold water storage system is used in order to  
56 improve the performance of the absorption chiller.

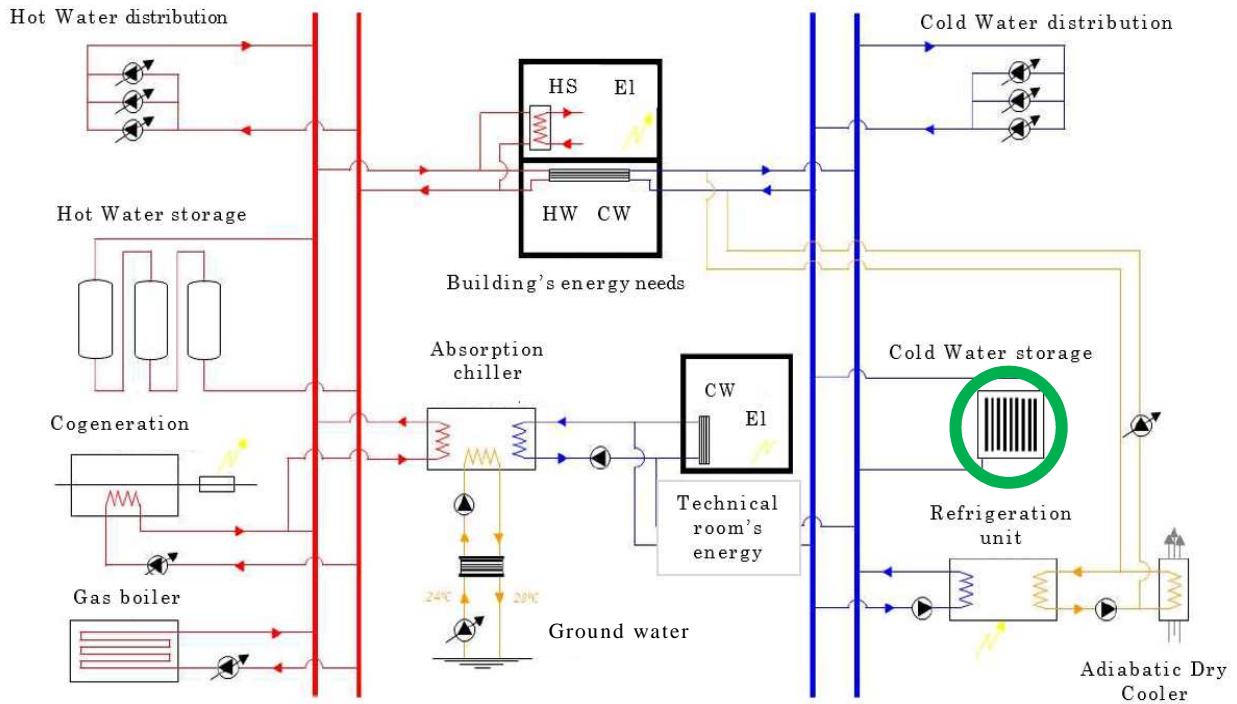

Figure 2 – Scheme of the HVAC technology of HIKARI. The reference thermal energy storage system is indicated in the green circle.

57 The positive effect of PCMs integration on the performance of air conditioning systems has  
 58 already been tested in different studies [11- 13]. Nevertheless, the challenges linked to the big  
 59 dimensions of the HIKARI district and the presence of its multi-source energy architecture,  
 60 made the technology of this thermal storage system particularly complex.

61 Concerning its technology, the water-PCM heat exchanger consists of 27 m<sup>3</sup> of phase change  
 62 material (PCM) (subject to a phase change between 9 and 11°C) processed into a gelatinous  
 63 form and enclosed in impermeable cylindrical stick packages (Figure 3.a). Each cylindrical  
 64 package encloses 100g of a PCM, the JX Nippon Oil branded paraffin Ecojoule<sup>®</sup>, able to store  
 65 and to release approximately 154 kJ/kg. The sticks are inserted in plastic cases (Figure 3.b),  
 66 which are subsequently inserted in four insulated thermal storage tanks (Figure 3.c) filled with  
 67 water. The total thermal energy storage capacity of the system is 3000 MJ.



68

Figure 3 – (a) Latent Heat Thermal Storage material package (gel pack), (b) plastic case filled with gel packs and (c) typical installation of the plastic cases into the isolated tank.

69 Water circulates into this tank as the heat transfer fluid, entering in the system from tubes  
70 situated on the top of the tank, passing from small openings with a flow rate of 50 g/s. For all  
71 the tanks, 180 opening can be counted (each opening is positioned in front of a single plastic  
72 case). The plastic cases have large apertures so as not to impede the water flow that runs into  
73 the tank when they are stacked in it. After passing through the gel sticks layer, the water exits  
74 the system passing through openings present in other tubes located at the bottom of the tanks  
75 (Figure 4).

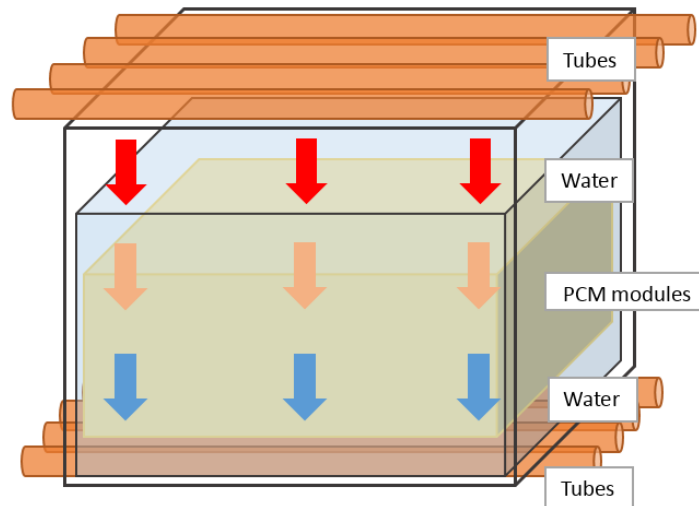

Figure 4 - Scheme of one of the four tanks composing the system.

76  
77 Once the temperature of the water into the four tanks is 6°C, the system is considered “100 %  
78 charged”, and the water that it contains is sent to the absorption chiller, reducing the  
79 difference between the chiller’s cold and hot inlet water temperature. After the heat exchange,  
80 the water flow is redirected to the storage tank continuing this cycle until the tank’s  
81 temperature reaches 10.5°C. At that point, the system is considered “discharged”, remaining  
82 unavailable until it is charged again.

## 83 2. NUMERICAL MODELLING

### 84 2.1 The heat balance approach

85 Contrary to experimental studies, numerical simulations can help to analyse physical  
86 phenomena quickly and cost-effectively [14]. Furthermore, validated models can be used in  
87 parametric studies having a greater versatility compared to experimental prototypes.

88 Fundamentally, the developed models are based on the formulation of a series of energy  
89 related equations and their solutions using analytical and numerical methods. Because of the  
90 complexity linked to the calculation of the moving boundary of phases, numerical methods  
91 are more frequently used for phase change problems [15-17]. In order to obtain a dynamic  
92 model able to reproduce the behaviour of our reference technology, the heat balance approach

93 was chosen. It is based on the division of the analysed system into a defined number of  
94 volume elements (it is a fixed grid method) and the subsequent application of the energy  
95 balance equations for each of them. The heat balance equations are formed for every volume  
96 element and solved at each time step in order to calculate the temperature evolution at the  
97 considered nodes.

98 This approach assumes that the temperature value is the same for each volume element. When  
99 the system is composed of two or more materials (as in our case with water and PCM)  
100 different layers are considered, in order to better study the behaviour of each material.

101 In this study, the first step consisted in analysing all the relevant energy flows present in the  
102 system, in order to write the energy balance equations, considering conduction, convection  
103 and advection transfers. Once the energy balance equations were written, the finite difference  
104 method was employed, in order to approximate the partial differential equations. Finally, the  
105 equations were solved at each time step and for each volume through the software MATLAB  
106 Simulink.

107 This method was chosen as it was previously used and provided good results for similar  
108 configurations [18, 19].

## 109 2.2 Selection of the development environment

110 As the HIKARI's HVAC model was created under MATLAB-Simulink environment, this  
111 software was selected for the development of the model reproducing the HIKARI's cold  
112 storage system energy behaviour. Also, the software offers the possibility of fast calculations  
113 and modification of several parameters for the subsequent optimization phase [20].

## 114 2.3 The apparent heat capacity method

115 The heat capacity and enthalpy methods are often used to model the PCM thermal behaviour  
116 in buildings [21, 22]. In this case, the problem of the phase change of the heat storage medium  
117 was resolved using the “apparent heat capacity method”, that consists in representing the  
118 phase change through an apparent increase of the material's heat capacity value for a certain  
119 temperature range; this increase represents the corresponding latent heat absorption/release  
120 [23-24].

121 In case of uniform process, we can define the apparent heat capacity ( $C_p$ ) as:

$$122 \quad C_{p,app} = \begin{cases} C_{p,s} & (\text{for the solid phase, where } T < T_s) \\ C_p(T) & (\text{for the phase change, where } T_s < T < T_l) \\ C_{p,l} & (\text{for the liquid phase, where } T > T_l) \end{cases}$$

126 In order to obtain the  $C_p$  values of the Ecojoule<sup>®</sup> PCM, a Differential Scanning Calorimetry  
127 (DSC) test was made.

128 2.4 The nodal discretisation of the model and the application of the heat balance approach

129 The heat exchange between the PCM and the water flow was modeled by reproducing the  
 130 thermal exchange between a single PCM gel stick and water.

131 As the thickness of the enclosing plastic film of the gel sticks is minor (0.5 mm), the thermal  
 132 resistance of this layer is considered negligible. Thus, two layers were considered for the  
 133 discretization: PCM and water. Each layer was then discretized lengthwise into n equal  
 134 regions (nodes) of length L/n, where L is the total length of the PCM/water exchanger (length  
 135 of the PCM stick). The PCM layer was further discretized crosswise in m nodes which  
 136 correspond to m concentric cylinders with a thickness of  $r=R/m$  where R is the radius of the  
 137 gel stick contained in a cylinder of water ( $i=w$  node) (Figure 5.a). The discretization into  
 138 multiple nodes offers the possibility of a more thorough treatment of the medium where the  
 139 phase change occurs. Subscript letter j signifies the nodal lengthwise position for each layer  
 140 ( $j=1$  to n) and the subscript i signifies the nodal crosswise position in the PCM layer ( $i=1$  to  
 141 m). The thermal resistances (represented with black rectangles) are formulated between nodes  
 142 (represented with red dots) (Figure 5.b).

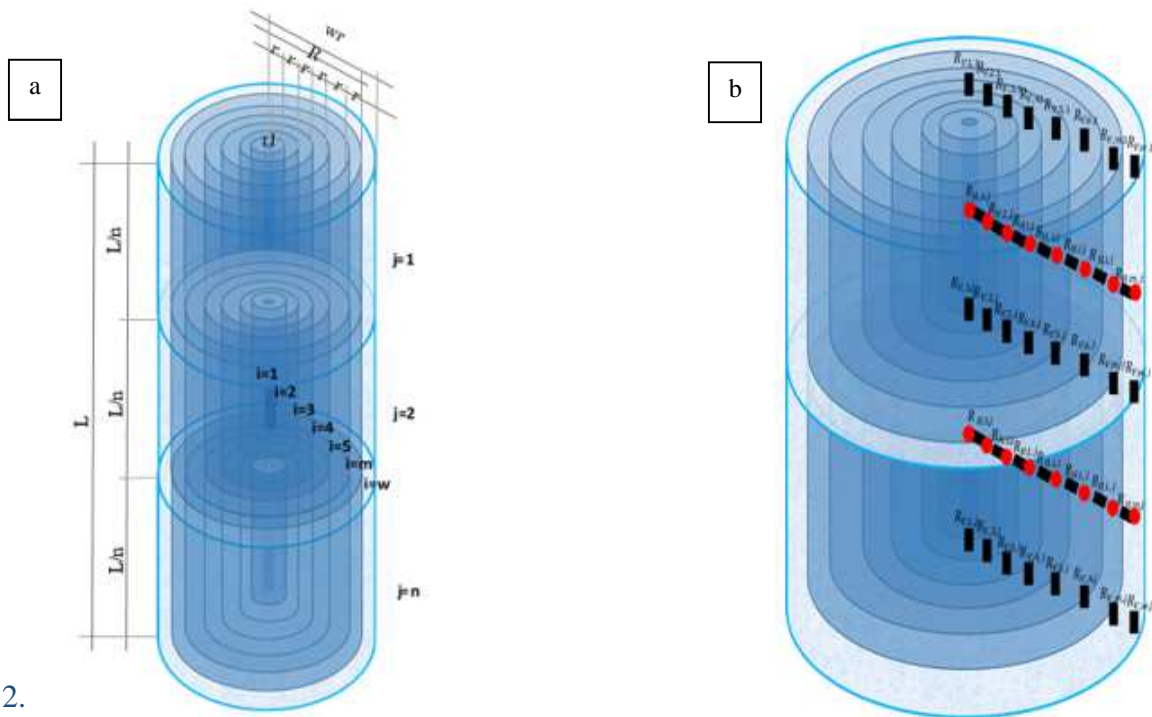

Figure 5 – (a) Scheme of the discretization of the model and (b) overview of the resistances between the control volumes.

160 In order to write the energy balance equations we considered conduction in PCM, convection  
 161 between water and PCM and advection in water as the possible transfer phenomena that could  
 162 take place in each node, so the equations could be written as follows:

$$\left\{ \begin{array}{l} \text{Temperature} \\ \text{change rate} \\ \text{in node} \end{array} \right\} = \left\{ \begin{array}{l} \text{Conduction} \\ \text{transfers} \\ \text{in node} \end{array} \right\} + \left\{ \begin{array}{l} \text{Convective} \\ \text{transfers} \\ \text{in node} \end{array} \right\} + \left\{ \begin{array}{l} \text{Advection} \\ \text{transfers} \\ \text{in node} \end{array} \right\} \tag{Equation 1}$$

6

165 The energy balance equation was written for each node, taking into account that the heat  
 166 entering into that node is equal to the heat exiting that position.

167 The temperature change rate (or storage of heat in the node) can be expressed as follows:

168  
 169 
$$\left\{ \begin{array}{l} \text{Temperature} \\ \text{change rate} \\ \text{in node} \end{array} \right\} = \rho C_p V \frac{dT}{dt}$$
  
 170 *Equation 2*

171 Where:

$\rho$ :	Density of the node's medium	[kg/m <sup>3</sup> ]
$C_p$ :	Specific heat capacity of the node's medium	[J/kg·K]
$V$ :	Volume of the node	[m <sup>3</sup> ]
$T$ :	Temperature of the node	[°C]
$t$ :	Time	[s]

172

173 The conduction term concerns the PCM nodes. It is given by the following equation:

174  
 175 
$$\left\{ \begin{array}{l} \text{Conduction} \\ \text{transfers} \\ \text{in node} \end{array} \right\} = \frac{T_{i-1} - 2 \cdot T_i + T_{i+1}}{R_{cond}}$$
  
 176 *Equation 3*

177 Where:

$T_i$ :	Node temperature at node i	[°C]
$T_{i-1}$ ::	Node temperature at node i-1	[°C]
$T_{i+1}$	Node temperature at node i+1	[°C]
$R_{cond} = \frac{L/n}{S \cdot \lambda}$	Thermal resistance between neighbouring nodes	[K/W]
$L/n$ :	Length of node	[m]
$S$ :	Contact surface between neighbouring PCM nodes	[m <sup>2</sup> ]
$\lambda$ :	Conductivity of the node's material	[W/m· K]



178 The advection term concerns the water layer and represents the heat transported into a water  
 179 node i from a neighbouring water node i-1 and from the water node i to a neighbouring water  
 180 node i+1. In its explicit form, the advection term is given by the following equation:

$$181 \quad \left\{ \begin{array}{l} \text{Advection} \\ \text{transfers} \\ \text{in node} \end{array} \right\} = \dot{m} C_p (T_{j-1} - 2 \cdot T_j + T_{j+1}) \quad \text{Equation 4}$$

184 Where

$T_i$ :	Node temperature at node j	[°C]
$T_{i-1}$ ::	Node temperature at node j-1	[°C]
$T_{i+1}$	Node temperature at node j+1	[°C]
$C_p$ :	Specific heat capacity of the node's medium	[J/kg·K]
$\dot{m}$ :	Water flowrate	[kg/s]

185

186 The convection term concerns the water layer and the most external nodes of the PCM layer,  
 187 adjacent to the water layer. It is given by the following equation:

$$188 \quad \left\{ \begin{array}{l} \text{Convective} \\ \text{transfers} \\ \text{in node} \end{array} \right\} = \frac{(\Delta T_{w-m})}{R_{conv}} \quad \text{Equation 5}$$

191 Where

$\Delta T_{w-m}$ :	Temperature difference between adjacent water and PCM nodes	[°C]
$R_{conv} = \frac{1}{s \cdot h}$	Thermal resistance between neighbouring nodes	[K/W]
:		
$S$ :	Contact surface between water and PCM nodes	[m <sup>2</sup> ]
$h$ :	Heat transfer coefficient	[W/m <sup>2</sup> ·K]

192

193 The application of the heat balance equation results are shown in the following equation for  
 194 the water (Equation 6) and PCM (Equation 7) nodes:

195

$$196 \quad \frac{\rho_w \cdot C_p \cdot V_w}{dt} \cdot 2 \cdot (\overline{T_{w,j}} - T_{w,j}^{t-dt}) = \dot{m} C_p (\overline{T_{w,j-1}} - 2\overline{T_{w,j}} + \overline{T_{w,j+1}}) + \frac{(\overline{T_{m,j}} - \overline{T_{w,j}})}{(R_{cond} + R_{conv})} =$$

198

$$199 \quad \frac{\rho_w \cdot C_p \cdot V_w}{dt} \cdot 2 \cdot (\overline{T_{w,j}} - T_{w,j}^{t-dt}) =$$

$$200 \quad \dot{m} \cdot C_p \cdot (\overline{T_{w,j-1}} - 2\overline{T_{w,j}} + \overline{T_{w,j+1}}) + \frac{(\overline{T_{m,j}} - \overline{T_{w,j}})}{\left[ \frac{1}{h \cdot 2 \cdot \pi \cdot (m-1) \cdot r \cdot (L/n)} + \frac{\ln\left(\frac{mr-r}{mr-3r/2}\right)}{2\pi \cdot k \cdot (L/n)} \right]} \quad \text{Equation 6}$$

$$201 \quad \frac{\rho_p \cdot C_{p,p} \cdot V_p}{dt} \cdot 2 \cdot (\overline{T}_{i,j} - T_{i,j}^{t-dt}) = \frac{(\overline{T}_{i,j-1} - 2\overline{T}_{i,j} + \overline{T}_{i,j+1})}{R_{cond}} + \frac{(\overline{T}_{i+1,j} - \overline{T}_{i,j})}{R_{cond}} + \frac{(\overline{T}_{i-1,j} - \overline{T}_{i,j})}{R_{cond}} =$$

202

$$203 \quad \frac{\rho_p \cdot C_{p,p} \cdot V_p}{dt} \cdot 2 \cdot (\overline{T}_{i,j} - T_{i,j}^{t-dt}) = \frac{(\overline{T}_{i,j+1} - 2\overline{T}_{i,j} + \overline{T}_{i,j-1})}{\frac{L}{n \cdot \lambda \cdot \pi \cdot \{[(i-1)r]^2 - [(i-2)r]^2\}}} + \frac{(\overline{T}_{i+1,j} - \overline{T}_{i,j})}{\frac{\ln\left(\frac{(i-r)/2}{(i-3r)/2}\right)}{2\pi \cdot \lambda \cdot (L/n)}} + \frac{(\overline{T}_{i-1,j} - \overline{T}_{i,j})}{\frac{\ln\left(\frac{(i-r)/2}{(i-5r)/2}\right)}{2\pi \cdot \lambda \cdot (L/n)}} \quad \text{Equation 7}$$

204

205

206 The average temperature

207

$$208 \quad \overline{T}_{i,j} = \frac{(T_{i,j}^t + T_{i,j}^{t-dt})}{2} \quad \text{Equation 8}$$

209

210

211 is introduced as the temperature variation is considered to be linear and the heat balance  
 212 equation is formulated for each layer. The finite difference method is used to approximate the  
 213 temperature derivative terms and the final form of the equations leads to a matrix formulation  
 214 for each layer [25].

## 215 2.6 Model assumptions

216 The objective of the numerical modelling was to reproduce the behaviour of the reference  
 217 system in order to obtain a model able to calculate the temperature of the water after its heat  
 218 exchange with the PCM modules. In order to develop an accurate and fast model, some  
 219 assumptions had to be made.

220 First of all, the water flow is considered the same for all the sticks: it was calculated by  
 221 dividing the water flow that crosses each tank with the total number of gel sticks.

222 The model considers convection transfers between the water and the PCM layers, conduction  
 223 transfers between the PCM layers and advection transfers between adjacent water nodes. It  
 224 does not take into account convection inside the PCM during the melting and the liquid  
 225 phases, irradiation and the thermal resistance of the enclosing plastic film of the gel sticks.

226 For the calculation of the temperature change rate in  $j=n$  nodes a convection transfer was  
 227 considered between PCM nodes and the average temperature of the adjacent water node at the  
 228 previous time step ( $\overline{T}_{w,n}^{t-dt}$ ). This was necessary as the water temperature value for the

229 convection transfer calculation was needed but the temperature of the water node  $\overline{T}_{w,n}$  could  
 230 be obtained prior to calculation. The same assumption for the advection transfer calculation  
 231 was used between the  $j=n$  water node and the adjacent water node.

232 Another assumption concerned the  $i=1$  node: a unidirectional conduction transfer was  
 233 considered from it to the  $i=2$  node (without considering an exchange between another internal  
 234 node). This assumption was made for simplifying the calculation. In order to reduce the effect  
 235 of this assumption, a fixed radius of 0.001 m ( $r_1$ ) to the  $i=1$  node was assigned.

236 **2.7 The heat transfer coefficient calculation**

237 The convective heat transfer coefficient was calculated taking into account the packing  
 238 density of the gel sticks into the water tanks  $\left(\frac{D_h}{R_{c,out}}\right)$ , with  $D_h$ =equivalent diameter and  
 239  $R_{c,out}$ =outer radius of the PCM cylinder. The relation between the packing density of the gel  
 240 sticks and the Nusselt number (Nu) value is shown in figure 6:

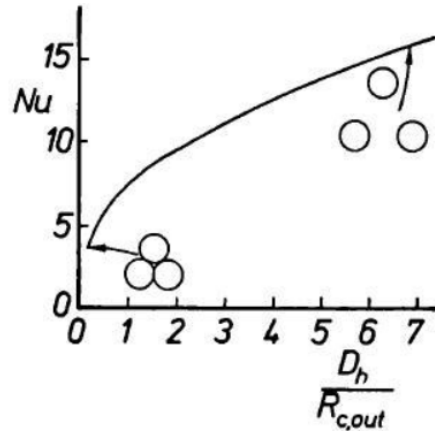

241  
242  
243  
244  
245  
246  
247  
248  
249  
250 *Figure 6 - Nusselt number values curve with reference to the packing density of the gel sticks for laminar flow [26].*

251 Therefore, the Nusselt number can be defined using the formula [26]:

$$Nu = 3.66 + 4.12 \cdot \left( \frac{D_h}{R_{c,out}} - 0.205 \right)^{0.569} \quad \text{Equation 9}$$

252  
253 Once calculated, the convective heat transfer coefficient can be calculated using the formula

$$h = \frac{Nu \cdot \lambda}{R_{c,out}} \quad \text{Equation 10}$$

254  
255 (with  $R_{c,out}$  = external radius of the gel stick and  $\lambda$ = water conductivity).

256 **2.8 Robustness and coherence test**

257 Once the MATLAB Simulink model created, a simulation scenario was established, in order  
 258 to run the simulations. The scenario corresponds to a thermal cycle of the unit: charging and

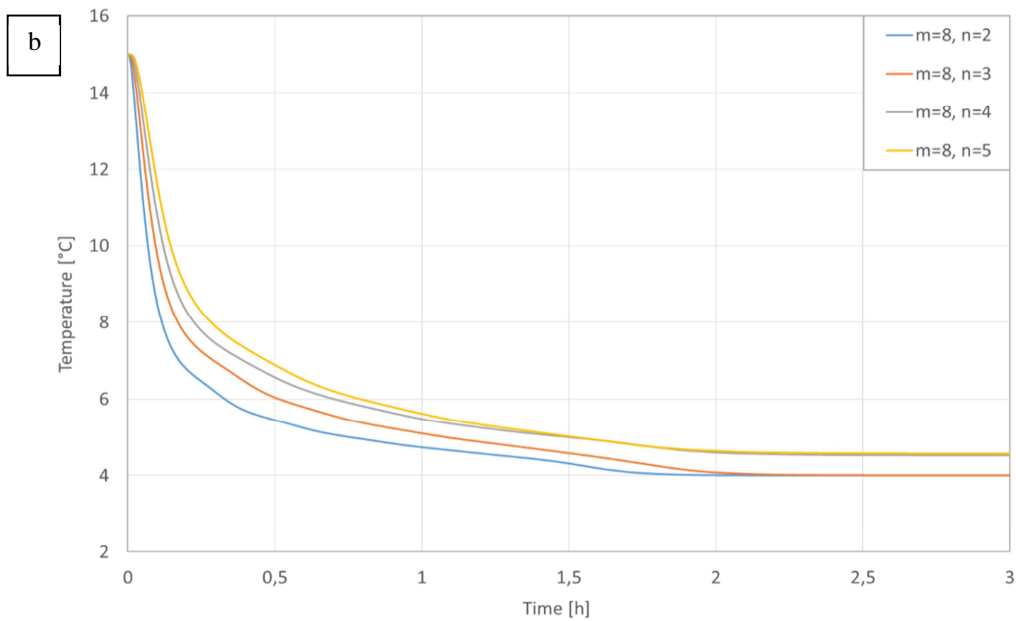
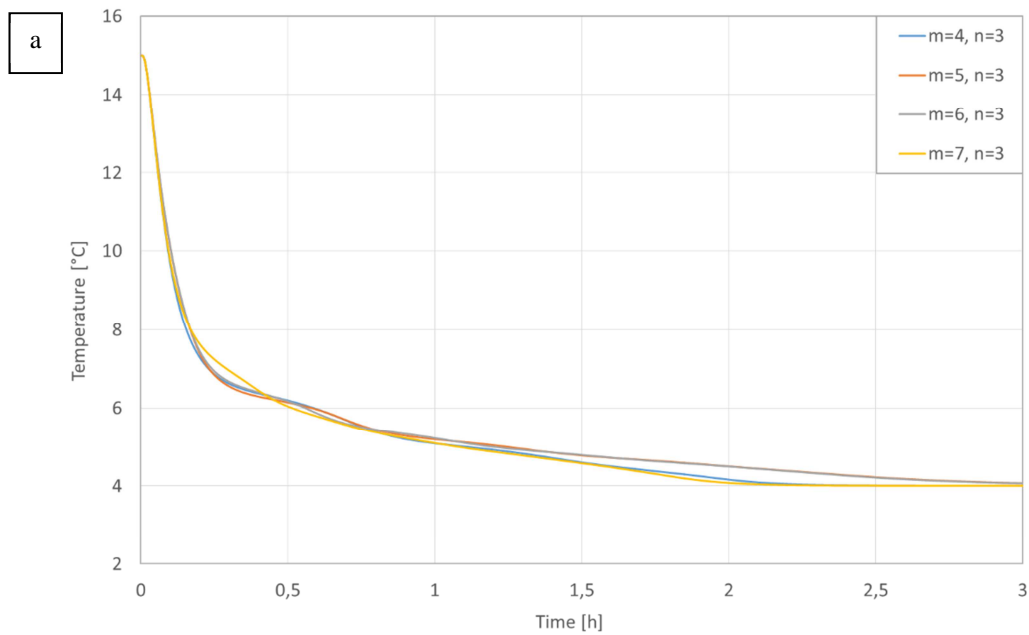

259 discharging period. It was decided to provide to the water-PCM stick exchanger a vertical  
 260 water flow rate of 0.3 g/s (exactly the same water flow rate of the reference system for each  
 261 PCM stick) at 4 °C during 3 hours. The initial temperature of the exchanger was set at 15°C  
 262 and the acquisition time step at 10 seconds. The same scenario was adopted for each  
 263 simulation, changing only the nodes' discretization crosswise and lengthwise. An example of  
 264 the temperature evolution obtained for the same point through the comparison between  
 265 models differently crosswise and lengthwise discretized is shown in figures 7.a and 7.b.

266  
 267

268  
269

270 The temperature curves of the figure 7.a correspond to the points indicated with red circles in  
271 figure 8.a, while those of the figure 7.b are indicated in figure 8.b.

272

273

274

275

276

277

278

279

280

281

282

283

284

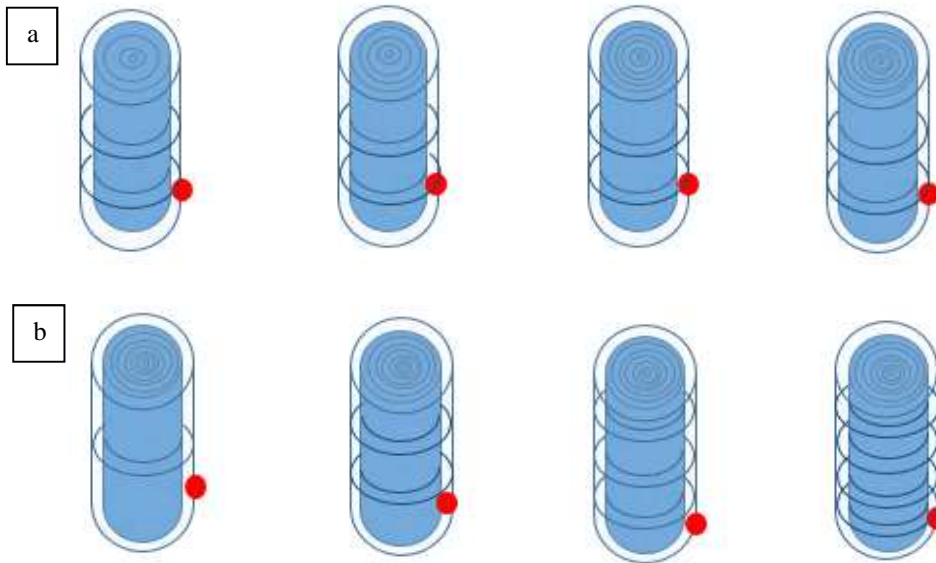

285 *Figure 8 – (a) Position of the points analyzed in figure 6.a in accordance to the different*  
286 *discretizations, (b) Position of the points analyzed in figure 6.b in accordance to the different*  
287 *discretizations.*

288 As it can be noticed, every discretization caused a different temperature evolution curve in  
289 each node. This is due to the volume difference between all the different discretization  
290 configurations and, in the case shown in figure 6.b, to the different position of the analysed  
291 node in relation to the total length of the stick (as it can be observed in figure 8.b).

292 Once these first results obtained, a comparison was made between them and the in situ  
293 monitored values, in order to calibrate the model and validate it [27].

### 294 3. NUMERICAL VALIDATION

#### 295 3.1 The Computational Fluid Dynamics

296 Once the model developed, a second numerical model was developed, using a different  
297 simulation method -the Computational Fluid Dynamics (CFD)-, in order to provide a first  
298 numerical validation, as the HIKARI's reference thermal storage system was still inoperative.

299 As the objective of this work was to develop a fast and accurate numerical tool that could be  
300 used for the optimization of the reference heat-exchanger technology, this second model has  
301 been used only for validation purposes, because of its slow computational speed. For instance,  
302 for simulating the same phenomenon, the time needed is more than 100 times greater than the  
303 time needed using the MATLAB Simulink model.

304 The strategy of CFD is to replace the continuous problems domain with a discrete domain  
305 using a cylindrical meshing method. The CFD works by means of mathematical modelling  
306 (using the partial differential equations), numerical methods (discretisation and solution  
307 techniques) and software tools (solvers, pre- and post-processing utilities).

308 In this work, the software ANSYS Fluent was used. This software is based on the finite  
309 volume method. Navier-Stokes equations are solved numerically thanks to the discretisation  
310 of the domain into a finite set of control volumes and the sequent writing of the general  
311 conservation equations for mass, momentum, energy, species, etc. [28] All the partial  
312 differential equations are discretized into a system of algebraic equations and are solved  
313 numerically, in order to render the solution field.

### 314 3.2 The CFD model development

315 The created model should respect the geometry and the proprieties of the PCM water model  
316 developed through MATLAB Simulink. A water layer of 30 cm was nevertheless added on  
317 the top and on the bottom of the stick, in order to respect the geometry of the real system  
318 obtaining the CFD model represented in Figure 9. The meshing of the model was chosen  
319 using the meshing interface and the proprieties of the materials were added.

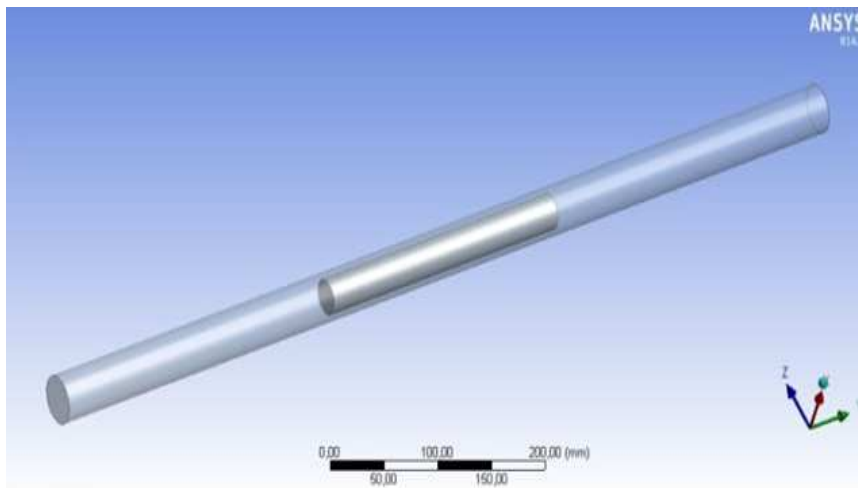

320 *Figure 9 - CFD model of the system realized through the software ANSYS Fluent.*

322 In order to make a valid comparison, we inserted the heat capacity values of the PCM  
323 obtained through the DSC method (as anticipated in paragraph 2.3).

324 Once the model and the materials properties defined, a simulation scenario was established, in  
325 order to run the simulations.

326 The protocol is composed of 3 scenarios, with varying water flow rate (0.15 g/s, 0.3 g/s and  
327 0.45 g/s); every scenario consists of 2 steps:

- 328 1) The initial temperature of the exchanger is set at 12°C and the acquisition time step at  
329 10 seconds. A water flow rate at 2°C is sent to the system during 330 minutes.
- 330 2) The initial temperature of the exchanger is set at 2°C and the acquisition time step at  
331 10 seconds. A water flow rate at 12°C is sent to the system during 330 minutes.

332 These water flow rates were chosen because 0.3 g/s is the real flow rate that crosses a single  
333 PCM stick in the HIKARI reference system, while 0.15 g/s and 0.45 g/s are respectively the  
334 half and one and a half times its value.

### 335 3.3 Robustness and coherence test

336 Once all the simulations were run, we compared the temperature results obtained through the  
337 developed MATLAB Simulink model and the ANSYS Fluent one for the same points.  
338 Examples of the temperature evolution at the same point ( $i=w$ ,  $j=3$ ) for different  
339 discretizations (see paragraph 2.4 for discretisation description) during the first and the  
340 second step of the 0.45 g/s water flow rate scenario are shown in figures 10.a and 10.b:

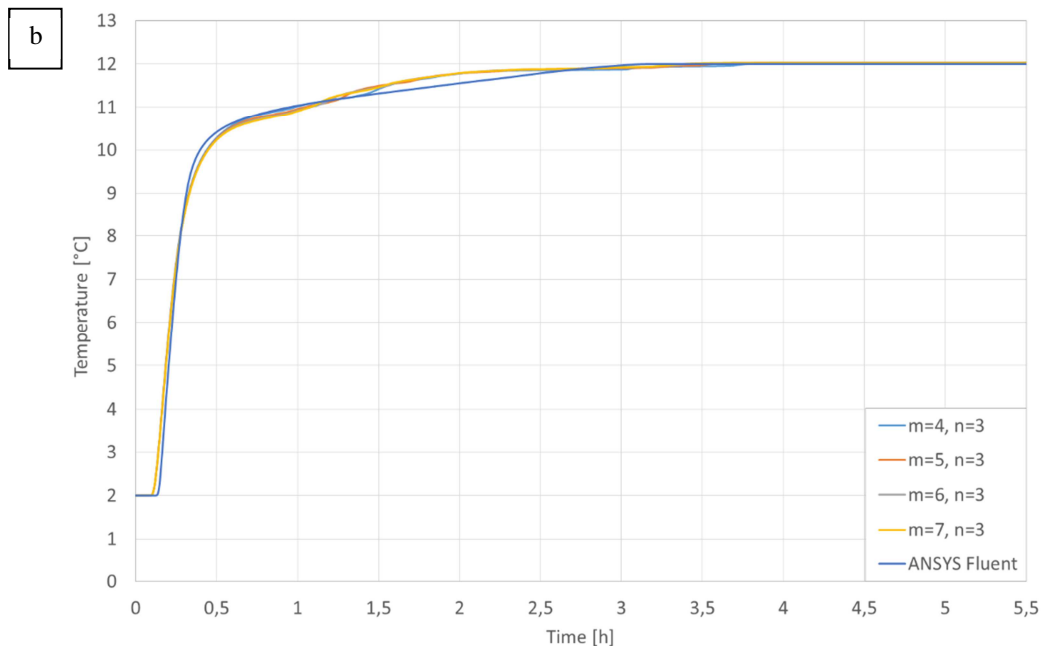
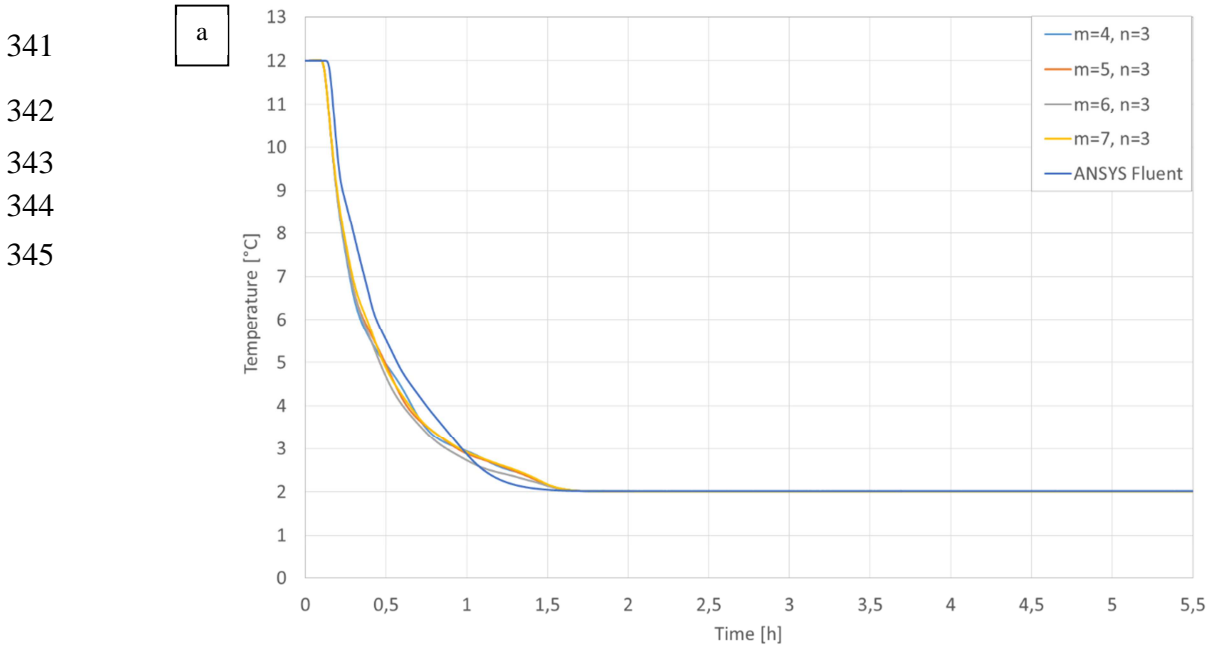

15 *Figure 10 - Comparison of the temperature curves obtained with the two different software in the first step (a) and the second step (b) of the 0.45 g/s water flow rate for the same point obtained using different crosswise discretization and the same lengthwise discretization ( $n=3$ ).*



346 The temperature evolution curves in figures 10.a and 10.b show the values obtained through  
347 different crosswise discretisation for the same water node ( $i=w, j=3$ ) shown in figure 8.a, that  
348 corresponds to the point shown in figure 11 in the ANSYS Fluent model:

349  
350  
351  
352  
353  
354  
355  
356  
357  
358  
359  
360

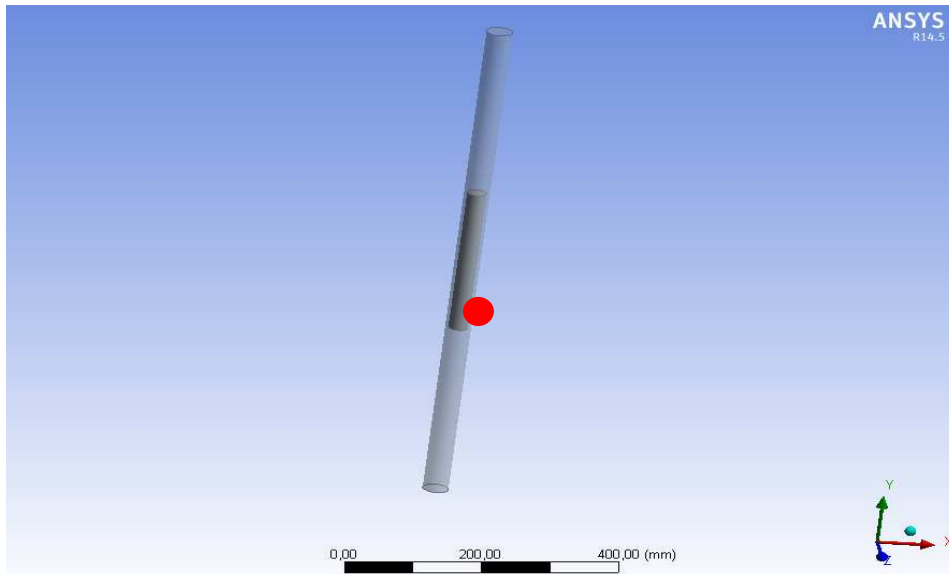

361 *Figure 11 - Position of the analyzed point in the ANSYS Fluent model.*

362  
363  
364  
365  
366  
367  
368  
369  
370  
371  
372  
373  
374  
375  
376  
377

A small time difference between the two software is noticed, this concerning the point when the water starts being chilled (or heated). In fact, for all the scenarios the ANSYS Fluent model starts being chilled (and heated) some minutes after the MATLAB Simulink one, with a difference of the order of 5 minutes. This time delay could be due to the difference between the dimension of the meshing in the two software and to the different solving methods.

Another interesting phenomenon that can be observed is that the MATLAB Simulink model provides some not acceptable results according to physics when it is lengthwise discretized in 4 or more nodes. In fact, one of the assumption made during the modelling phase was that the PCM-water system was considered adiabatic, as all the tanks of the reference system were thermally insulated. For this reason, if a continue water flow rate at 2°C is sent to the system, the whole system should stabilise at 2°C after some time, as there is no heat exchange with the external ambient environment. Instead, some of the results obtained through particular discretizations, never reach the temperature of 2°C. This could be due to a particular relationship between the length and the thickness of the nodes that prevents the software adequately from solving the heat balance equations for those discretizations.

### 378 3.4 Numerical calibration

379 Following the different comparisons between the ANSYS Fluent model and the MATLAB  
380 Simulink model's results for the same node, an error analysis between the results obtained  
381 through the two software was carried out.

382 In order to test the accuracy of the MATLAB Model two criteria were calculated:

383 - The Normalized Mean Bias Error (NMBE)

384  
385 
$$NMBE = \frac{\sum_{i=1}^n (y_{simulated,i} - y_{reference,i})}{\bar{y}_{reference} \times (n - p)} \times 100$$
 Equation 11  
386

387 - The Coefficient of Variation of the Root Mean Squared Error (CV(RMSE))

388  
389 
$$CV(RMSE) = \frac{1}{\bar{y}_{reference}} \times \sqrt{\frac{\sum_{i=1}^n (y_{simulated,i} - y_{reference,i})^2}{(n - p - 1)}} \times 100$$
 Equation 12  
390

391

392 Typically and according to ASHRAE, models are declared to be calibrated if they produce  
393 NMBEs within  $\pm 10\%$  and CV(RMSE)s within  $\pm 30\%$  [29].

394 For the calculation of these coefficients, the ANSYS Fluent model results were considered as  
395 the “reference values”, and the difference between them and the MATLAB Simulink model  
396 results was calculated.

397 It was noticed that the discretization that provided the best results was the one with 8 nodes  
398 crosswise (7 concentric cylinder and a water layer) and 3 nodes lengthwise ( $m=7, n=3$ ).

399 In Table 1 the NMBE and the CV(RMSE) values for this discretization are showed, while  
400 Figures 12.a, 12.b and 12.c illustrate the difference between the results obtained with the two  
401 software for the point ( $i=w, j=3$ ) when the flow rates is 0.15 g/s, 0.3 g/s and 0.45 g/s.

402

403 *Table 1 - NMBE and the CV(RMSE) values for the comparison between the results obtained through*  
404 *the software ANSYS Fluent and the discretization ( $m=7, n=2$ ) of the MATLAB Simulink model.*

Scenario	Statistical Index	Values [%]
1) Flow rate : 0.15 g/s	NMBE	-0.26
	CV(RMSE)	17
2) Flow rate : 0.3 g/s	NMBE	-0.18
	CV(RMSE)	12
3) Flow rate : 0.45 g/s	NMBE	-0.21
	CV(RMSE)	13

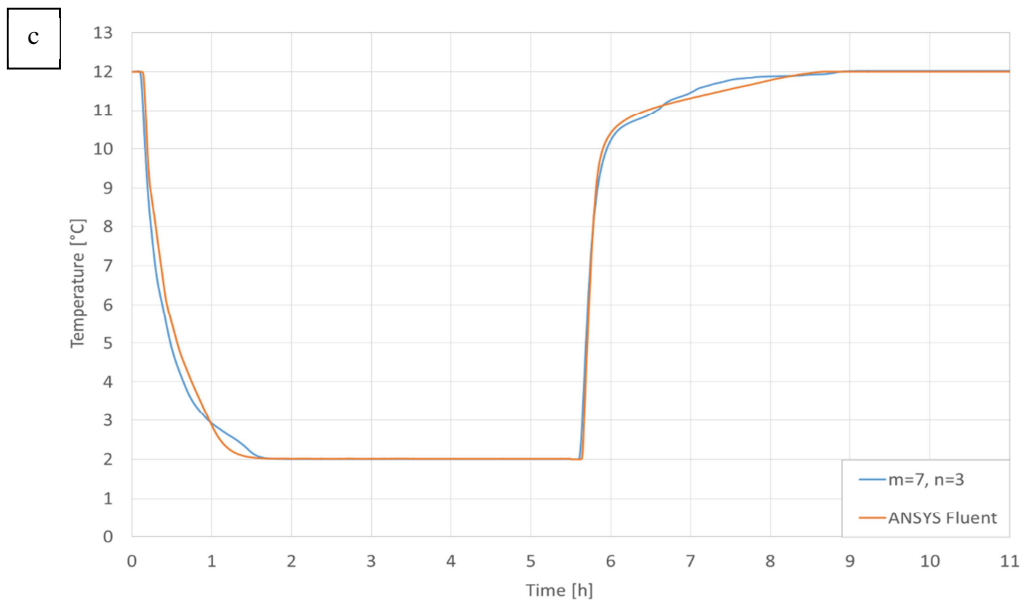
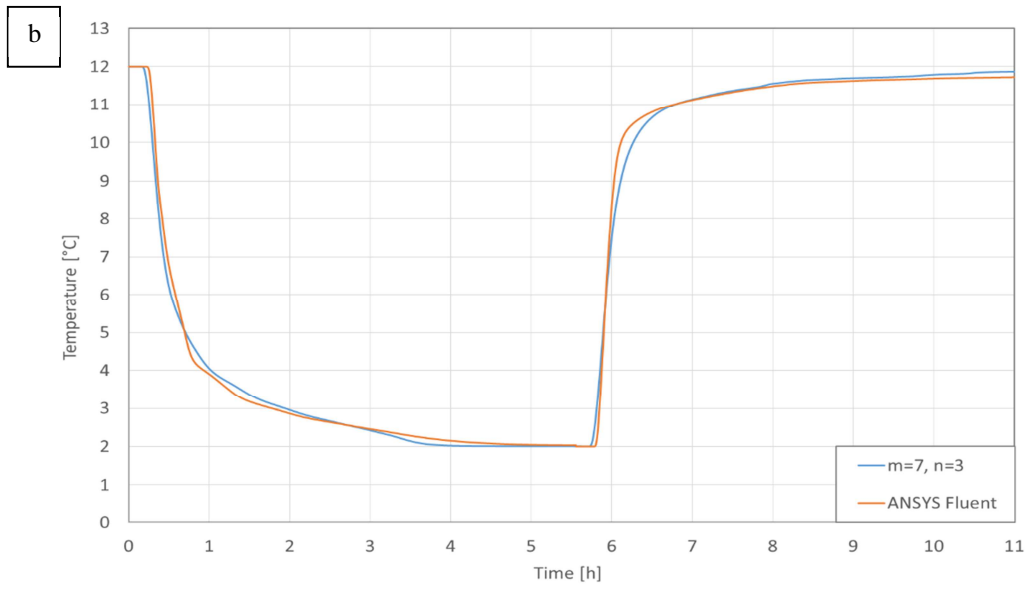
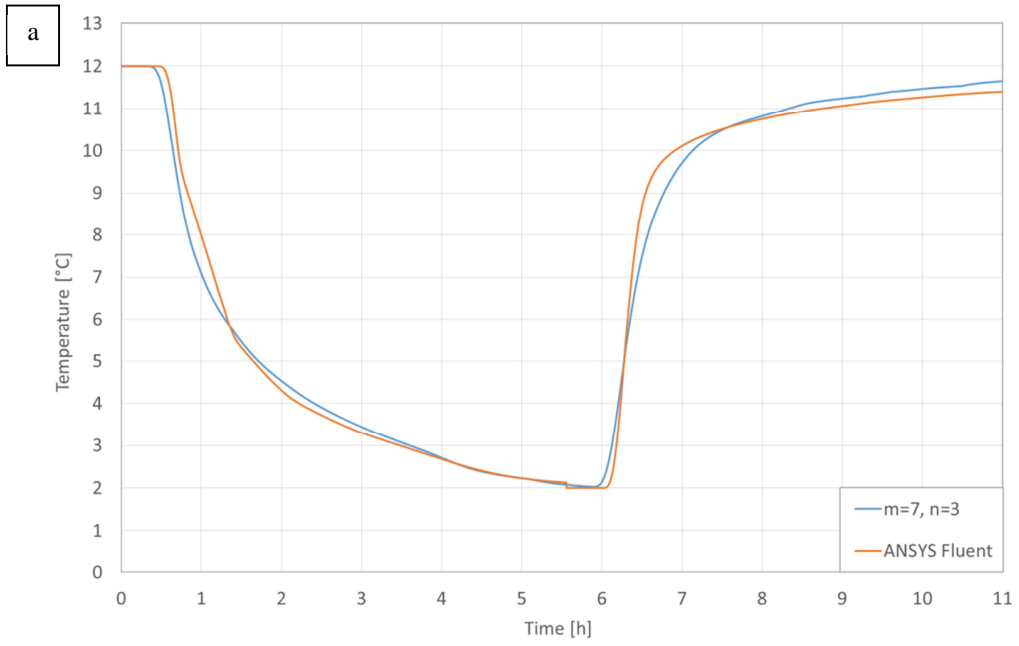

407 The behaviour of the two models is similar, even though some discretization provided a time  
408 difference between the two software's results. For this reason, it was necessary to conduct an  
409 experimental validation in order to obtain a clearer view on eventual inaccurate assumptions  
410 or input errors.

#### 411 4. EXPERIMENTAL VALIDATION

412 An original experimental prototype reproducing the HIKARI cold storage system was  
413 developed in the ENTPE Laboratory of Tribology and Systems Dynamics (LTDS), in order to  
414 perform a first experimental validation. An extended description of the prototype can be  
415 found in Reference [30].

##### 416 4.1 The experimental prototype

417 The prototype (Figure 13.a) consists of two insulated Plexiglas tanks filled with water, into  
418 one of which is inserted a plastic case filled with the PCM sticks. The temperature of the  
419 water on the tank 1 is regulated by an external cryostat and then it is directed to tank 2, where  
420 it crosses the PCM modules layer, charging and discharging it.

421 The scheme of the prototype is showed in Figure 13.b:

422

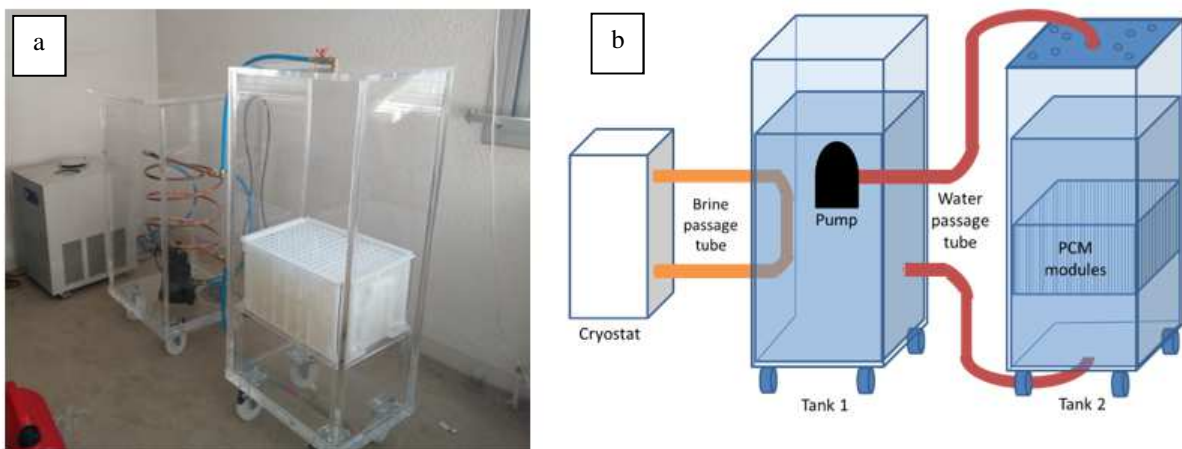

423

424 *Figure 13 – (a) The experimental prototype and (b) scheme of the experimental prototype.*

425

426 At first, only one PCM module has been inserted in tank 2, in order to test the PCM-water heat  
427 exchange prevision of the model along the length of a single gel stick. Temperature evolution  
428 in various depths of the tank 2 were monitored using PT100 temperature sensors (Figure 14.a)  
429 placed at 15 points of interest as illustrated in Figure 14.b.

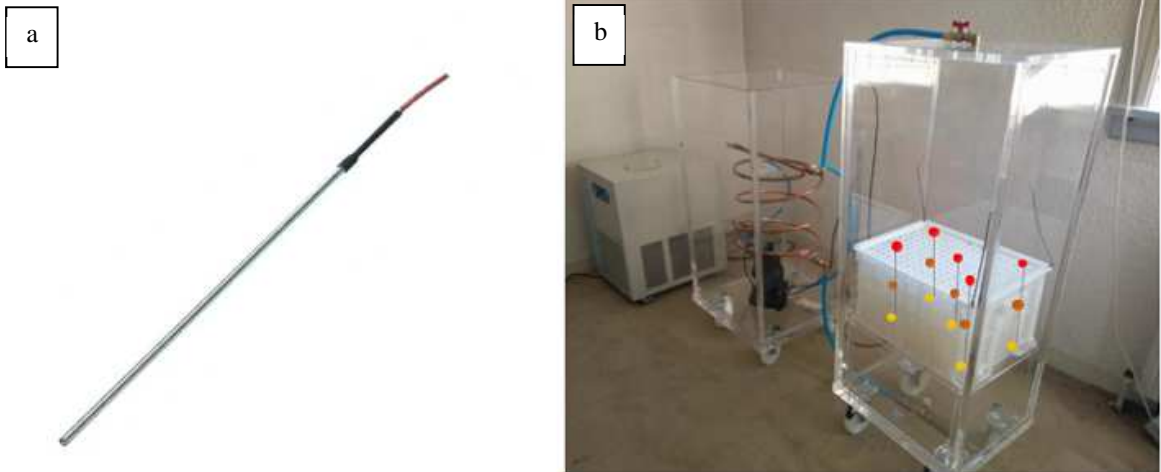

Figure 14 – (a) PT100 temperature sensor and (b) positions of the 15 points analyzed using the temperature sensors.

430  
431  
432  
433  
434  
435  
436  
437  
438

In a second step, another PCM module has been inserted on top of the first one in tank 2, in order to test if the model is able to simulate the heat exchange module-module beside the module-water flow one. In this second case the PT100 temperature sensors have been placed at 15 different points corresponding to the points analyzed in the model of a double PCM gel stick-water heat exchange (scheme in Figure 15).

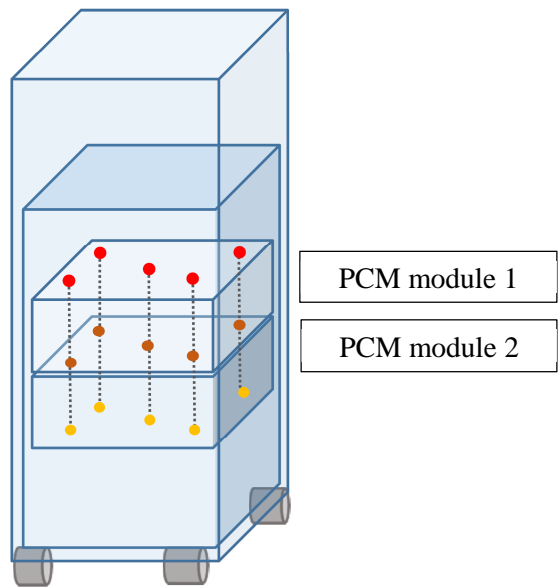

Figure 15 – Positions of the 15 points analyzed using the temperature sensors when 2 PCM modules are inserted in tank 2.

439  
440  
441  
442

An experimental protocol was established in order to test the “goodness of fit” between the numerical model prediction and the experimental data in different scenarios. The objective of this protocol was to recreate particular situations that could be registered in different systems

443 operating scenarios. In particular, the objective was to overcome two factors that were  
444 imposed by the real functioning of the reference system: the constant water flow rate and  
445 temperature range.

446 The water flow rates were chosen considering the flow rate for every plastic case of the  
447 reference system during the charge period (50 g/s).

448 It was decided to test the heat exchange when the flow rate between the two tanks is the half  
449 (25 g/s) and the double (100 g/s) of that value in order to verify the validity of the numerical  
450 model when it is used in different contexts. As the reference storage system works between 6  
451 and 10°C, it was decided to operate the prototype with water temperatures ranging from 3 to  
452 20°C. At the end, the protocol was composed of 6 scenarios, with varying water flow rate (25,  
453 50 and 100 g/s) and different PCM quantity (1 or 2 plastic cases).

454 Every scenario consisted of 4 steps:

- 455 1) In the first step the cryostat was set to  $-2$  °C. As the pump that regulated the water  
456 flow between the two tanks was off, only the water of tank 1 was chilled.
- 457 2) After 8 hours, the pump was switched on, so the heat exchange between the PCM  
458 modules and the chilled water flow coming from the tank 1 happened, reproducing the  
459 “charging” phase of the reference system.
- 460 3) After 16 hours, the pump that regulated the water flow between the two tanks was  
461 switched off and the cryostat was set to 20 °C.
- 462 4) Finally, after 8 hours, the pump was switched on again, so the heat exchange between  
463 the PCM modules and the heated water flow occurred, reproducing the “discharging”  
464 phase of the reference system during 16 h.

465 For every scenario, the temperature evolution was registered.

## 466 4.2 Experimental validation

467 The results were grouped in 3 outputs, in order to reduce the effect of the proximity of the  
468 sensors at the tank walls:

469 **1) Inlet** (Arithmetical mean of the temperatures registered by the 5 sensors placed at the top  
470 of the plastic cases)

471 **2) Intermediate** (Arithmetical mean of the temperatures registered by the 5 sensors placed in  
472 the middle of the plastic cases)

473 **3) Outlet** (Arithmetical mean of the temperatures registered by the 5 sensors placed at the  
474 bottom of the plastic cases).

475

476 Using these pooled data it will be possible to validate the MATLAB-Simulink model  
477 comparing the water temperature evolution along the stick length during the heat exchange.

478 The output that was compared to the results obtained through the numerical model was the  
479 “outlet” one, as this would be one of the key parameters in the optimization phase of this

480 technology. Two examples of comparison between the prototype data and the model outlet  
481 results are shown in figures 16.a and 16.b:

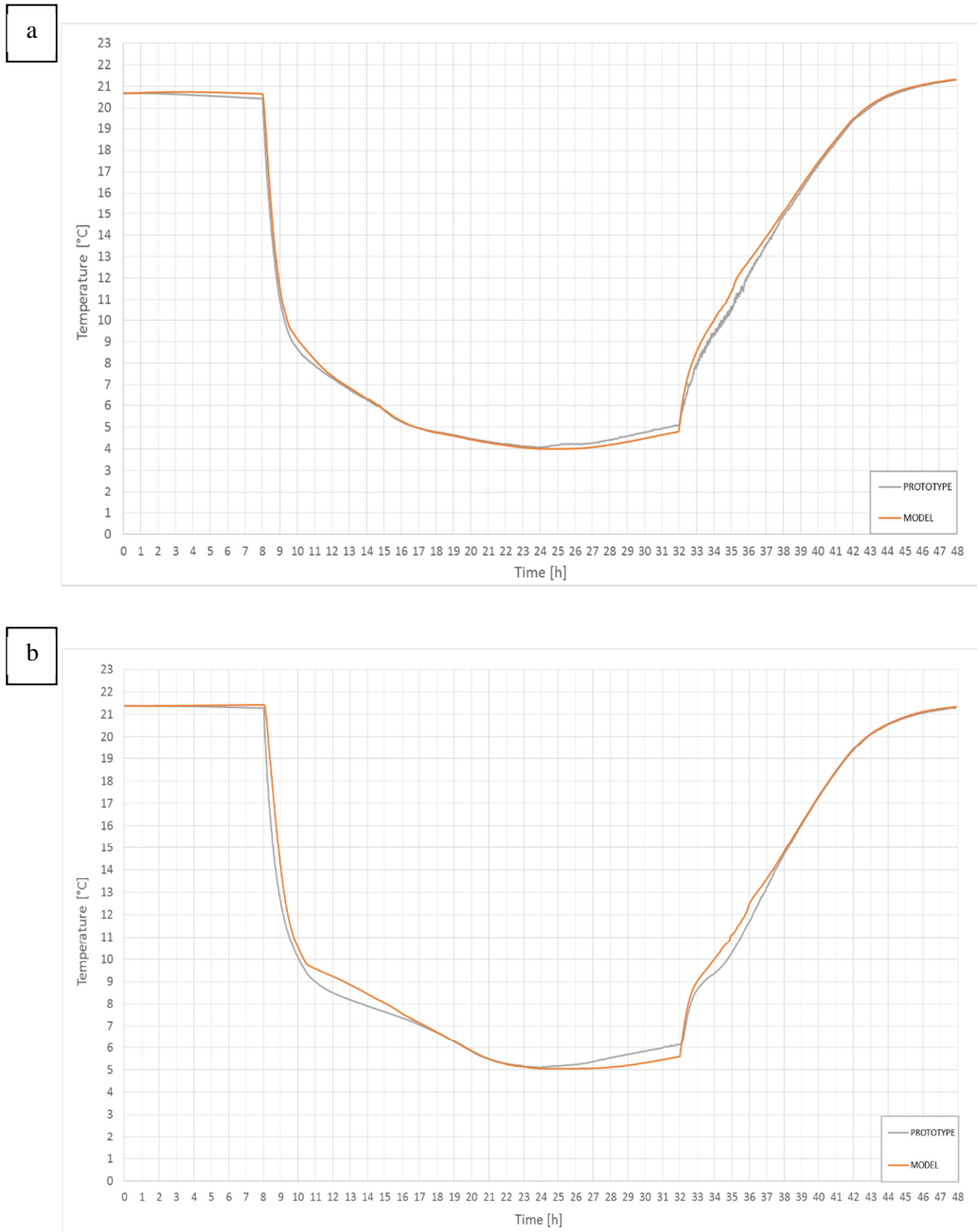

482 *Figure 16 – Comparison of the temperature curves for the same point between the*  
483 *experimental and the model results for 50 g/s flowrate when (a) one PCM module is inserted*  
484 *in tank 2, (b) two PCM modules are inserted in tank 2.*

485 As in the numerical calibration case, the Normalized Mean Bias Error (NMBE) and the  
486 Coefficient of Variation of the Root Mean Squared Error (CV(RMSE)) were used as  
487 validation criteria, considering the prototype data as the reference values.

488 The results for each scenario are shown in table 2:

489



490  
491

*Table 2 - NMBE and the CV(RMSE) values for the comparison between the results obtained through the prototype monitoring and the discretization (m=7, n=3) of the MATLAB Simulink model.*

Scenario	Statistical Index	Values [%]
1) 1 Plastic case Flow rate : 25 g/s	NMBE	1,07
	CV(RMSE)	3,21
2) 1 Plastic case Flow rate : 50 g/s	NMBE	0,97
	CV(RMSE)	2,57
3) 1 Plastic case Flow rate : 100 g/s	NMBE	0,56
	CV(RMSE)	2,72
4) 2 Plastic cases Flow rate : 25 g/s	NMBE	2,08
	CV(RMSE)	5,79
5) 2 Plastic cases Flow rate : 50 g/s	NMBE	1,23
	CV(RMSE)	3,72
6) 2 Plastic cases Flow rate : 100 g/s	NMBE	-0,05
	CV(RMSE)	2,81

492

493 The validation results showed that the numerical model produces the same behaviour as the  
494 prototype one. The Normalized Mean Bias Error (NMBE) and the Coefficient of Variation of  
495 the Root Mean Squared Error (CV(RMSE)) used to analyse the validation results showed that  
496 the reference model was very accurate and fitted largely the ASHRAE specifications for all  
497 tested configurations.

## 498 5. IN SITU VALIDATION

499 Once the HIKARI buildings inaugurated, the monitoring process started in order to evaluate  
500 the performance of the building and its equipment, so as to reach the positive energy balance  
501 target. In order to test the HIKARI energy behaviour, all the measured data are compared  
502 every month with the expected simulated data for the same weather conditions to detect any  
503 failure or decay between actual and planned performance of equipment and systems.

504 The temperature values registered during the cold storage system monitoring campaign were  
505 compared to those obtained using the numerical model presented in this work in order to  
506 make an in situ validation.

507

508

509 5.1 The reference system monitoring obtained data

510 In the specific case of the HIKARI's cold storage system, 14 temperature sensors were  
511 inserted in each insulated tank of the system in 14 points of interest represented in the section  
512 of the tank 1 shown in Figure 17 and the scheme shown in Figure 18.

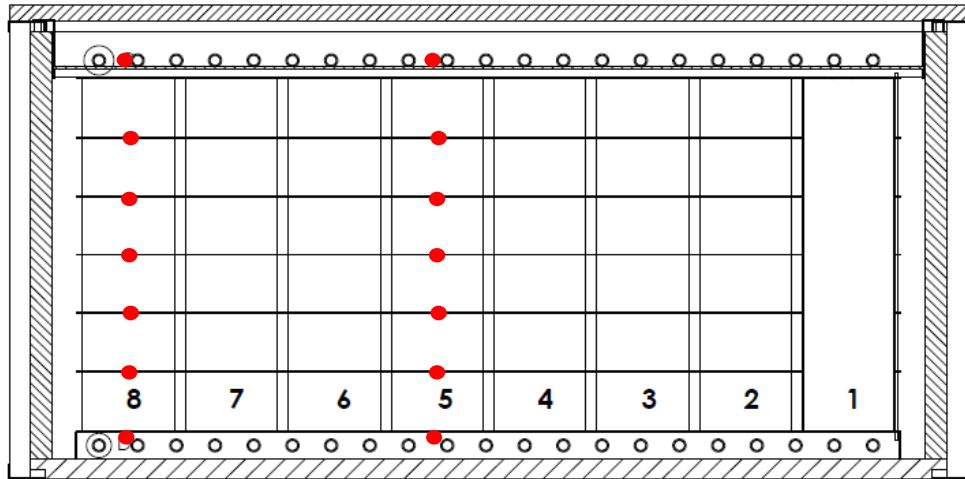

513

Figure 17 – Section of the tank 1 showing the positions of the temperature sensors.

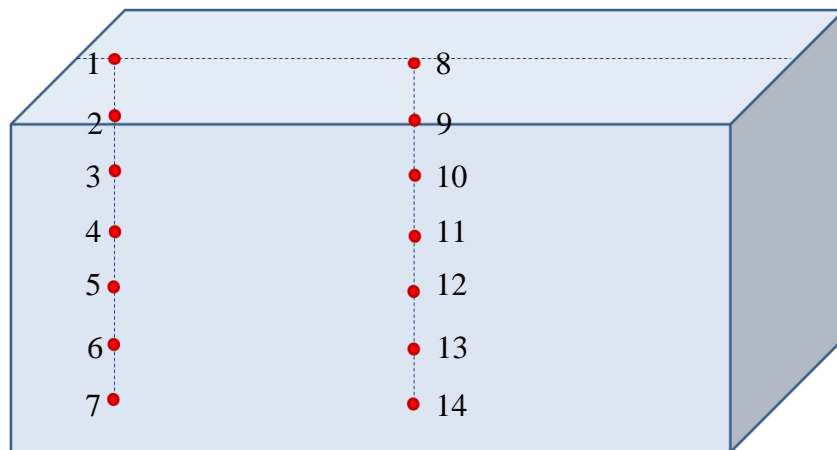

Figure 18 - Scheme of the positions of the temperature sensors in each

514

515 As it can be noticed, the temperature sensors were inserted at the top and the bottom of the set  
516 of plastic cases filled with the PCM modules and between all the plastic cases. The central  
517 and an external column of plastic cases were chosen in order to test the impact of the external  
518 leakage and the homogeneity of the vertical heat transfer. The temperature values were  
519 registered with a time step of 60 seconds.

520 An example of the temperature recorded for the tank 1 by the 14 sensors is shown in Figure  
521 19:

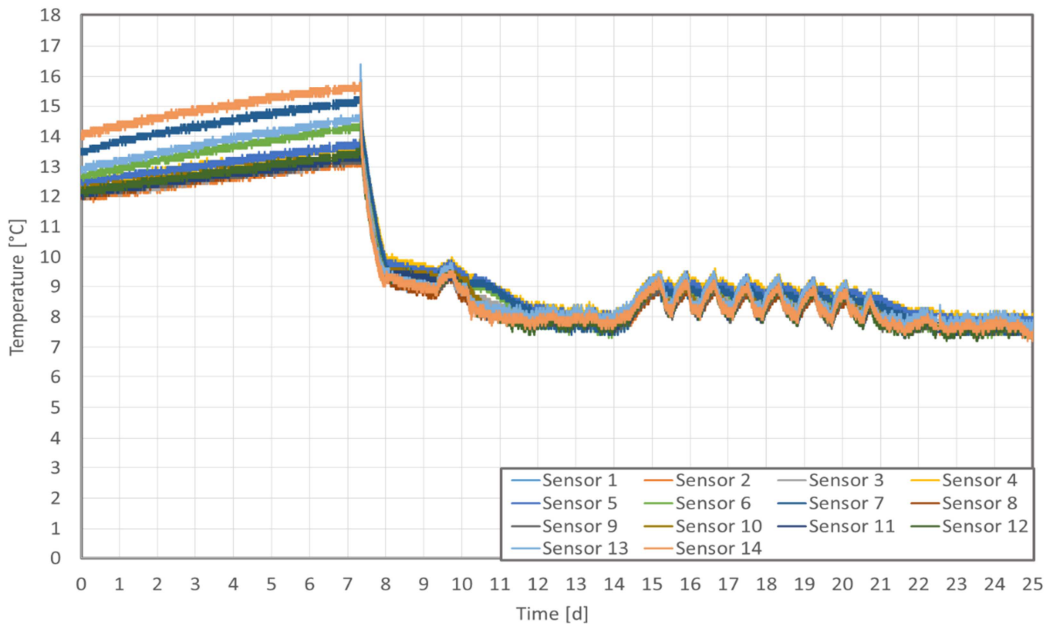

Figure 19- Example of the temperature recorded by the 14 sensors of the tank 1.

522 5.2 In situ validation

523 A comparison was then made between the results obtained through the model and the in situ  
 524 data, as registered by the last sensor of the central column of the tank (number 14 as shown in  
 525 Figure 19), corresponding to the output value of our model.

526 As for the numerical calibration (Paragraph 3.4), the Normalized Mean Bias Error (NMBE)  
 527 and the Coefficient of Variation of the Root Mean Squared Error (CV(RMSE)) between the  
 528 reference results (the data obtained through the in situ monitoring) and the model results were  
 529 calculated. The graphic showing the difference between the in situ data recorded by the sensor  
 530 14 and the model results for this discretization is shown in Figure 20, while the results of the  
 531 NMBE and CV(RMSE) criteria are shown in table 3:

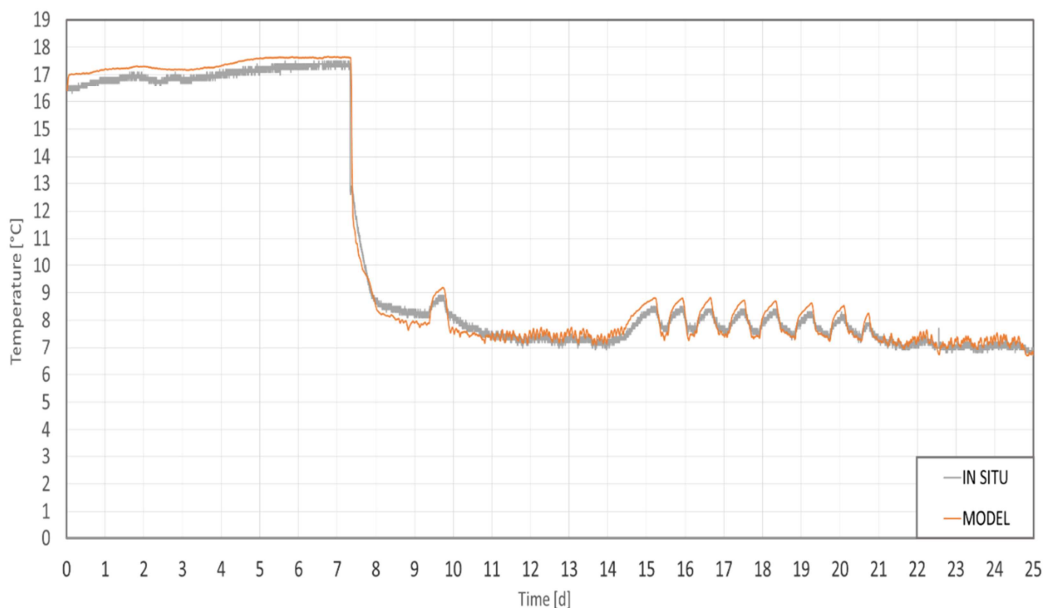

Figure 20 - Comparison of the temperature curves recorded by sensor 14 and the model results.

Normalized Mean Bias Error	1,86%
Coefficient of Variance of Root Mean Square Error	4,02%

533

534 For this case as well, the obtained results show that the MATLAB-Simulink model is able to  
 535 reproduce the energy behaviour of the reference thermal energy storage system at low  
 536 temperatures.

## 537 6. CONCLUSIONS

538 The results obtained show that the choice of the heat balance approach provided a fast,  
 539 accurate and re-utilizable numerical model able to reproduce the heat exchange between the  
 540 Phase Change Material (PCM) contained in the reference system and a water flow, that can be  
 541 used for the optimization of this energy storage technology.

542 Once developed, the model was firstly calibrated using the results obtained through a second  
 543 numerical model that was developed using the Computational Fluid Dynamics method. The  
 544 results of this calibration showed that the model was accurate and faster in long duration  
 545 simulation studies when compared to ANSYS Fluent results.

546 A first experimental validation was realized using an original experimental prototype  
 547 reproducing the HIKARI's cold storage system, which was designed and developed in order  
 548 to obtain reliable experimental data useful for a complete experimental validation of the  
 549 numerical model and for the validation of other kinds of phase change materials in the future.  
 550 For this reason, the prototype had the advantage to be easy to disassemble and reassemble (in  
 551 case of transport) but at the same time able to provide fast heat transfer rates to the PCM and  
 552 to record all the temperature changes with a very good precision.

553 Finally, a second experimental validation was realized once the HIKARI in situ data obtained  
 554 thanks to in-situ monitoring. This comparison allowed us to make the in situ validation of the  
 555 model.

556 The results obtained through its construction showed that the developed model was able to  
 557 reproduce the PCM-water heat exchange with a high accuracy. A slightly delayed response  
 558 during its phase change can be noticed (maybe due to the effect of further minor heat transfer  
 559 phenomena that were not taken into account in the heat balance equations definition).  
 560 Nevertheless, the use of the Normalized Mean Bias Error (NMBE) and the Coefficient of  
 561 Variation of the Root Mean Squared Error (CV(RMSE)), showed that the developed model  
 562 was very accurate and fitted largely the ASHRAE specifications for all tested configurations.

563 Once numerically calibrated and experimentally validated, the model was coupled to the  
564 HIKARI's HVAC systems model in order to test the effects of geometry and thermo-physical  
565 changes of the reference system on the efficiency of some other systems and on HIKARI  
566 energy needs.

567 Applying the validation techniques shown in this work, new geometries and solving methods  
568 can be tested as well for this and other systems in the future.

## 569 References

- 570 [1] IEA-ETSAP and IRENA (2013) "Thermal Energy Storage. Technology Brief."
- 571 [2] Stathopoulos N., El Mankibi M., Issoglio R., Michel P., Haghghat H. (2016) "Air-PCM  
572 heat exchanger for peak load management: Experimental and simulation." *Solar Energy*.  
573 Vol. 132, pp 453–466.
- 574 [3] Alva G., Liu L., Huang X., Fang G. (2017) "Thermal energy storage materials and  
575 systems for solar energy applications". *Renewable and Sustainable Energy Reviews*. Vol.  
576 68, Part 1, pp 693–706.
- 577 [4] Reddy K.S., Mudgal V., Mallick T.K. (2018) "Review of latent heat thermal energy  
578 storage for improved material stability and effective load management". *Journal of Energy*  
579 *Storage*. Vol. 15, pp 205–227.
- 580 [5] Zalba B., Marín J. M., Cabeza L. F., Mehling H. (2003)" Review on thermal energy  
581 storage with phase change: materials, heat transfer analysis and applications". *Applied*  
582 *Thermal Engineering*. Vol. 23, pp 251–283.
- 583 [6] Khudhair A.M., Farid M.M. (2004) "A review on energy conservation in building  
584 applications with thermal storage by latent heat using phase change materials". *Energy*  
585 *Conversion and Management*. Vol. 45 pp 263–275.
- 586 [7] Zhu N., Ma Z., Wang S. (2009) "Dynamic characteristics and energy performance of  
587 buildings using phase change materials: A review". *Energy Conversion and*  
588 *Management*. Vol.50, Issue 12, pp 3169-3181.
- 589 [8] Cabeza L. F., Castell A., Barreneche C., de Gracia A., Fernández A. I. (2011) "Materials  
590 used as PCM in thermal energy storage in buildings: A review". *Renewable and*  
591 *Sustainable Energy Reviews*, Vol. 15, pp 1675-1695.
- 592 [9] Roccamena L. (2017) "Optimization of an innovative thermal energy storage technology  
593 at low temperatures when coupled to multi-source energy architectures". Doctoral thesis.  
594 Ecole Nationale des Travaux Publics de l'Etat, Lyon (France).
- 595 [10] Simon F., Corgier D., El Mankibi M. "Innovative and energy-flexible design for a  
596 positive energy balance plot in Lyon (France): the HIKARI project". Nordic Passive House  
597 Conference, 27-29 September 2017, Helsinki (Finland).
- 598 [11] Souayfane F., Fardoun F., Biwole P.-H. (2016) "Phase change materials (PCM) for  
599 cooling applications in buildings: A review". *Energy and Buildings*, Vol. 129, pp 396-431.

- 600 [12] Chaiyat N. (2015) “Energy and economic analysis of a building air-conditioner with a  
601 phase change material (PCM)”. *Energy Conversion and Management*, Vol.94, pp 150-158.
- 602 [13] Fang G., Wu S., Liu X. (2010) “Experimental study on cool storage air-conditioning  
603 system with spherical capsules packed bed”. *Energy and Buildings*, Vol. 42, pp 1056-1062.
- 604 [14] Kasaeian A., Bahrami L., Pourfayaz F., Khodabandeh E., Yan W. (2017) “Experimental  
605 Studies on the Applications of PCMs and Nano-PCMs in Buildings: A Critical Review”,  
606 *Energy and Buildings*, Vol. 154, pp 96-112.
- 607 [15] Liu S., Li Y., Zhang Y. (2014) “Mathematical solutions and numerical models employed  
608 for the investigations of PCMs' phase transformations”. *Renewable and Sustainable  
609 Energy Reviews*. Vol. 33, pp 659-674.
- 610 [16] Radhakrishnan K.B., Balakrishnan A.R. (1992) “Heat transfer analysis of thermal energy  
611 storage using phase change materials”. *Heat Recovery Systems and CHP*. Vol. 12, Issue 5,  
612 pp 427-435.
- 613 [17] Kürklü A., Wheldon A., Hadley P. (1996) “Mathematical modeling of the thermal  
614 performance of a phase-change material store: cooling cycle”. *Applied Thermal  
615 Engineering*. Vol. 16, Issue 7, pp 613-623.
- 616 [18] El Mankibi M., Stathopoulos N., Rezaï N., Zoubir A. (2015) “Optimization of an Air-  
617 PCM heat exchanger and elaboration of peak power reduction strategies”. *Energy and  
618 Buildings*, Vol. 106, pp 74-86.
- 619 [19] Liu Z., Yu Z., Yang T., Roccamena L., Sun P., Li S., Zhang G., El Mankibi M. (2019),  
620 “Numerical modeling and parametric study of a vertical earth-to-air heat exchanger  
621 system”. *Energy*, Vol.172, pp 220-231.
- 622 [20] Van Schijndel A.W.M. (2009) “Integrated modeling of dynamic heat, air and moisture  
623 processes in buildings and systems using SimuLink and COMSOL”. *Building Simulation*.  
624 Vol. 2, Issue 2, pp 143–155.
- 625 [21] AL-Saadi S.N., Zhai Z. (2013) “Modeling phase change materials embedded in building  
626 enclosure: A review”. *Renewable and Sustainable Energy Reviews*. Vol. 21, pp 659-673.
- 627 [22] Bouhal T., El Rhafiki T., Kousksou T., Jamil A., Zeraouli Y. (2018) “PCM addition  
628 inside solar water heaters: Numerical comparative approach”. *Journal of Energy Storage*.  
629 Vol.19, pp 232-246.
- 630 [23] Idelsohn S.R., Storti M.A., Crivelli L.A. (1994) “Numerical methods in phase-change  
631 problems”. *Archives of Computational Methods in Engineering*. Vol. 1, Issue 1, pp 49–  
632 74.
- 633 [24] Hu H., Argyropoulos S.A. (1996) “Mathematical modelling of solidification and melting:  
634 a review”. *Modelling and Simulation in Materials Science and Engineering*. Vol.4, pp.  
635 371-396.

- 636 [25] Stathopoulos N. (2015) “Optimisation numérique et expérimentale de stratégies  
637 d’effacement énergétique”. Doctoral thesis. Ecole Nationale des Travaux Publics de  
638 l’Etat, Lyon (France).
- 639 [26] Visser H. (1986) “Energy storage in phase-change materials. Development of a  
640 component model compatible whit the “TRNSYS” transient simulation program”.  
641 Commission of European communities.
- 642 [27] Dutil Y., Rouse D.R., Ben Salah N., Lassue S., Zalewski L. (2011) “A review on phase-  
643 change materials: Mathematical modeling and simulations”. *Renewable and Sustainable*  
644 *Energy Reviews*. Vol.15, Issue 1, pp 112-130.
- 645 [28] Fan Y., Ito K. (2014) “Optimization of indoor environmental quality and ventilation load  
646 in office space by multilevel coupling of building energy simulation and computational  
647 fluid dynamics”. *Building Simulation*. Vol. 7, Issue 6, pp 649–659.
- 648 [29] ASHRAE (2002) Guideline 14 - Measurement of Energy and Demand Savings.
- 649 [30] Roccamena L., El Mankibi M., Stathopoulos N. (2018) “Experimental test bed design  
650 and development for PCM-water exchangers characterization”. *Sustainable Cities and*  
651 *Society*. Vol. 37, pp 241-249.