



HAL
open science

Dynamical modeling of reaction networks Mathematics of system biology

Romain Yvinec

► **To cite this version:**

Romain Yvinec. Dynamical modeling of reaction networks Mathematics of system biology. 2020 Workshop - 'bioinformatics and biomathematical approaches to integrate the GPCR signal, Nov 2020, Online, France. pp.1-70. hal-03115099

HAL Id: hal-03115099

<https://hal.science/hal-03115099>

Submitted on 19 Jan 2021

HAL is a multi-disciplinary open access archive for the deposit and dissemination of scientific research documents, whether they are published or not. The documents may come from teaching and research institutions in France or abroad, or from public or private research centers.

L'archive ouverte pluridisciplinaire **HAL**, est destinée au dépôt et à la diffusion de documents scientifiques de niveau recherche, publiés ou non, émanant des établissements d'enseignement et de recherche français ou étrangers, des laboratoires publics ou privés.

Dynamical modeling of reaction networks

Mathematics of system biology

Romain Yvinec

Systems Biology and Networks

Motivations and Objectives

Chemical reaction network formalism

Parameter estimation

Applications

Outline

Systems Biology and Networks

Motivations and Objectives

Chemical reaction network formalism

Parameter estimation

Applications

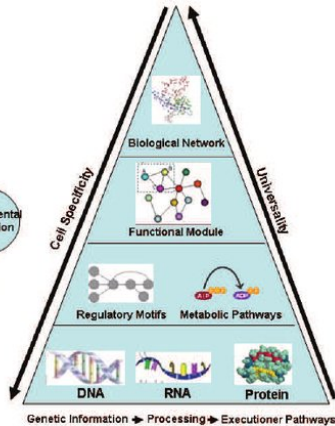
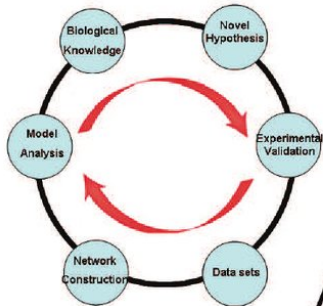

Oltvai and Barabasi, Science 25 :763-764, 2002.

Small networks in Population dynamics

(Interactions between populations, Epidemiology)

Lotka-Volterra model

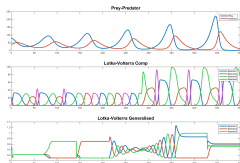
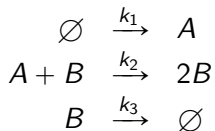

S.I.R model

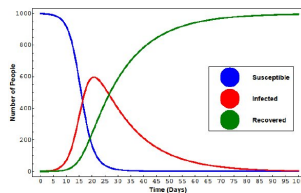
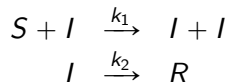

Small networks in molecular biology

('Toy' molecular models with isolated components)

Enzymatic kinetics

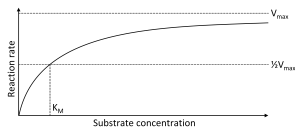
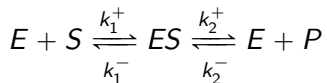

Pharmacology model

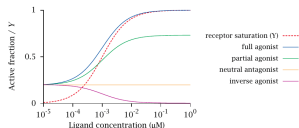
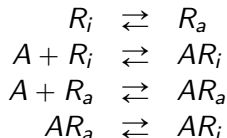

(Single) Gene Expression

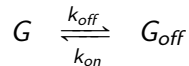
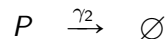
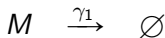
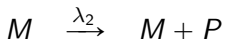
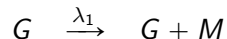

Eldar and Elowitz (*Nature* 2010)

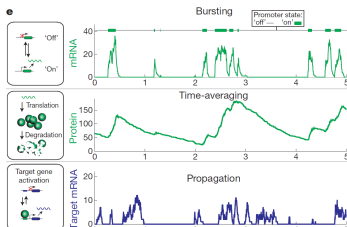
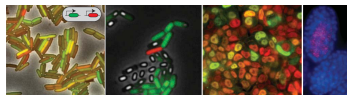

Co-expression genes network

Small motifs

Gene Co-expression

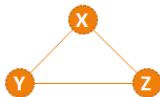

Gene Regulation

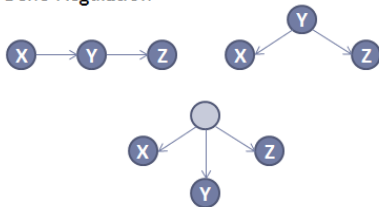

Large networks

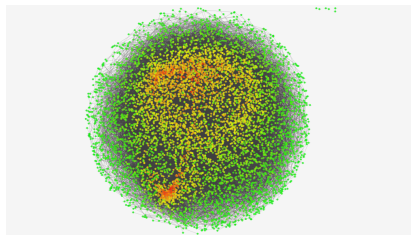

Systems Biology and Networks at different scales

Signaling system

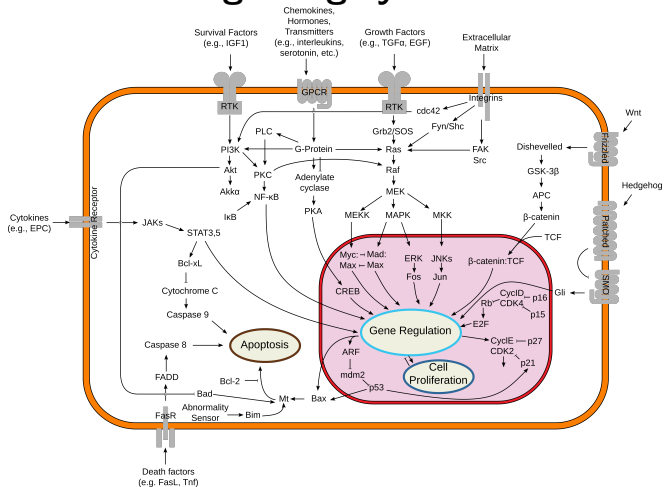

Systems Biology and Networks at different scales

Metabolomic Network

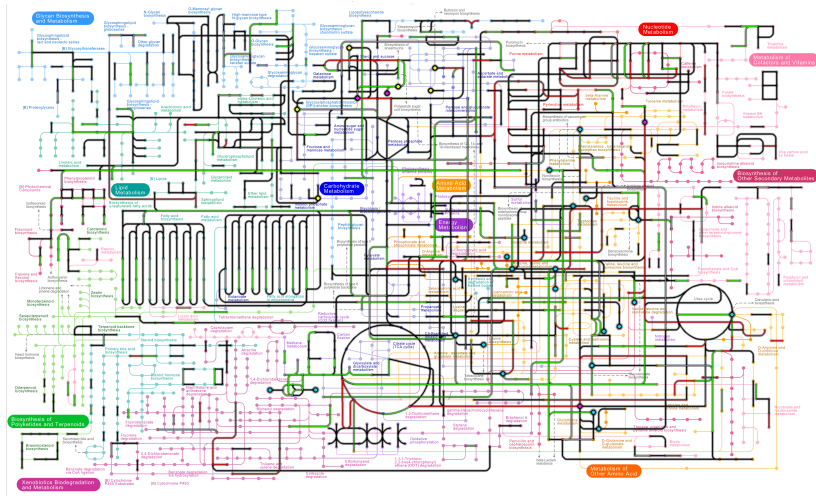

Outline

Systems Biology and Networks

Motivations and Objectives

Chemical reaction network formalism

Parameter estimation

Applications

Possible applications of mathematical modelling

- ▶ Understand non-trivial behavior of a biological system (by reproducing this behavior with an understandable model, starting from 'first principles')
- ▶ Help to identify key regulatory process in signaling cascades
- ▶ Quantify some non-observables quantities, in particular :
molecules concentrations, reaction rates.

Possible applications of mathematical modelling

Today : Understand the mathematical formalism of dynamical reactions network

Possible applications of mathematical modelling

Today : Understand the mathematical formalism of dynamical reactions network

- ▶ Build a model from a network of interactions [Cell Designer]
- ▶ Parameter calibration with kinetic data [GraphPad Prism / Copasi]

Warning!

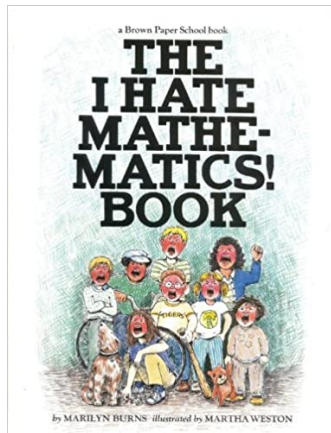

#Ihatemathematics

The following couples of slides contain some abstract notions...
Why that?

Maths is about structures...and is generic !

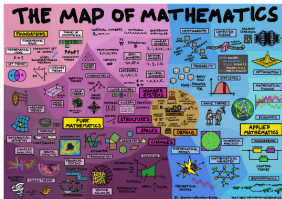

Reactions networks applications range from

- ▶ Chemistry
- ▶ molecular biology
- ▶ epidemiology
- ▶ and beyond !

Binding experiments

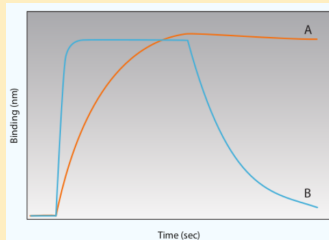

Covid-19 models

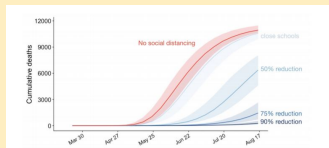

Outline

Systems Biology and Networks

Motivations and Objectives

Chemical reaction network formalism

Parameter estimation

Applications

Chemical Reaction Network, vocabulary

Definition

A **chemical reaction network** is given by the sets $(\mathcal{S}, \mathcal{C}, \mathcal{R})$:

- **Species**, $\mathcal{S} := \{S_1, \dots, S_d\}$: molecules that undergo a series of chemical reactions.
- **Reactant / Product**, $\mathcal{C} := \{y^1, \dots, y^n\}$: Linear combination of species, that represent either 'what is consumed', or 'what is produced', in any reaction.
- **Reaction**, $\mathcal{R} := \{y^k \rightarrow y^{k'}, y^k, y^{k'} \in \mathcal{C}\}$: ensemble of reactions between species or combination of species (directed graph between Reactant / Product).

Chemical Reaction Network, vocabulary

Definition

A **chemical reaction network** is given by the sets $(\mathcal{S}, \mathcal{C}, \mathcal{R})$:

- **Species**, $\mathcal{S} := \{S_1, \dots, S_d\}$: molecules that undergo a series of chemical reactions.
- **Reactant / Product**, $\mathcal{C} := \{y^1, \dots, y^n\}$: Linear combination of species, that represent either 'what is consumed', or 'what is produced', in any reaction.
- **Reaction**, $\mathcal{R} := \{y^k \rightarrow y^{k'}, y^k, y^{k'} \in \mathcal{C}\}$: ensemble of reactions between species or combination of species (directed graph between Reactant / Product).
- **Mass-action law**, κ : a list of positive parameter (kinetic rate) for each reaction in \mathcal{R}

Example

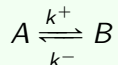

Species $\mathcal{E} := \{A, B\}$

R / P $\mathcal{C} := \{A, B\}$

Reaction $\mathcal{R} := \{A \rightarrow B, B \rightarrow A\}$

Rate $\{k^+, k^-\}$

Chemical Reaction Network, vocabulary

Example (minimal cAMP production model)

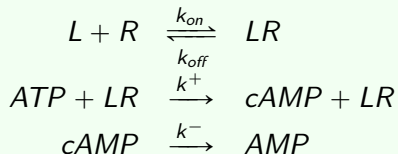

Species $\mathcal{E} := \{L, R, LR, ATP, cAMP, AMP\}$

R / P $\mathcal{C} := \{L + R, LR, ATP + LR, cAMP + LR, cAMP, AMP\}$

Reaction $\mathcal{R} := \{L + R \rightarrow LR, LR \rightarrow L + R, ATP + LR \rightarrow cAMP + LR, cAMP \rightarrow AMP\}$

Rate $\{k_{on}, k_{off}, k^+, k^-\}$

Chemical Reaction Network, FSHR-induced cAMP signals

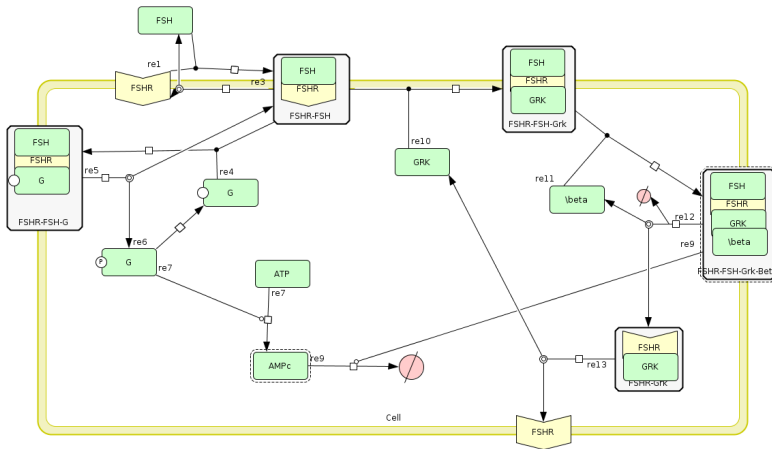
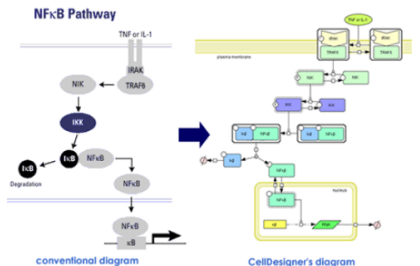
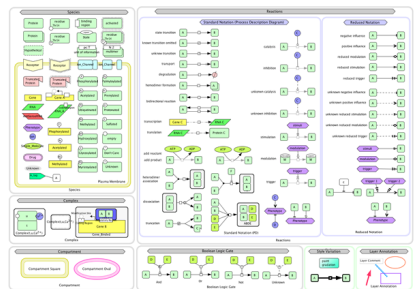

Figure – FSHR ($G\alpha_s$ -coupled GPCR) models build on CellDesigner

About diagrams and layout...



...with well-defined conventions



Funahashi, A., Tanimura, N., Morohashi, M., and Kitano, H.,
CellDesigner : a process diagram editor for gene-regulatory and
biochemical networks, BIOSILICO, 1 :159-162, 2003

Chemical Reaction Network, "real" example

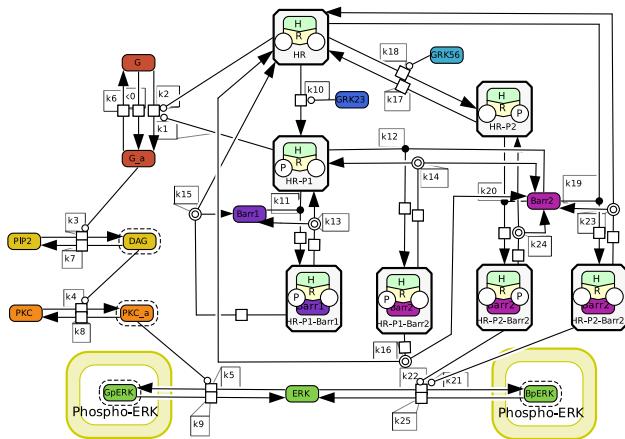

Figure – ERK Phosphorylation pathways build on CellDesigner, Heitzler et al. MSB 2012

Summary so far

We have seen

- ▶ Many examples of dynamical system biology models
- ▶ The formalism of *reaction network* models
- ▶ How to *build* a reaction network within Cell Designer

Summary so far

We have seen

- ▶ Many examples of dynamical system biology models
- ▶ The formalism of *reaction network* models
- ▶ How to *build* a reaction network within Cell Designer

NB : there exists public databases of reaction network models.

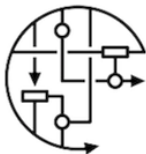

Pathguide) the pathway resource list



KEGG NETWORK Database
From gene variation to network variation

Summary so far

We have seen

- ▶ Many examples of dynamical system biology models
- ▶ The formalism of *reaction network* models
- ▶ How to *build* a reaction network within Cell Designer

NB : there exists public databases of reaction network models.

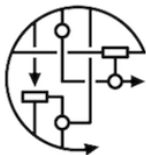

Pathguide the pathway resource list



KEGG NETWORK Database
From gene variation to network variation

NB (bis) : A reaction network is a network... but a network is
NOT a reaction network !

We have seen

- ▶ Many examples of dynamical system biology models
- ▶ The formalism of *reaction network* models
- ▶ How to *build* a reaction network within Cell Designer
- ▶ **What about dynamics?**

Warning!

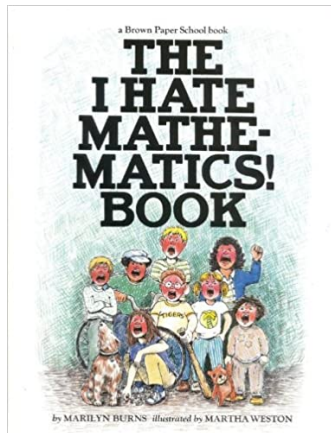

#Ihatemathematics

The following couples of slides contain some abstract notions...let's try to catch the meaning!

Chemical Reaction Network and Dynamical models

We build a model that

- Keep track of **concentration** of species along **time**.
- Satisfy **Law of Mass action** : The velocity of a reaction is proportional to the concentrations of its reactants.
- Is a system of Ordinary Differential Equations, in which reactions are "added" on top of each other, e.g. they happens **continuously** and **simultaneously**.

Example

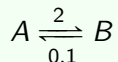

$$\frac{dx_A}{dt}(t) = -0.1x_A(t) + 2x_B(t), \quad x_A(t=0) = A_{tot}$$

$$\frac{dx_B}{dt} = +0.1x_A(t) - 2x_B(t), \quad x_B(t=0) = 0$$

$x_A(t)$ = time dependent concentration of species A

Example



$$\begin{aligned}\frac{dx_L}{dt}(t) &= -k_{on}x_L(t)x_R(t) + k_{off}x_{LR}(t), & x_L(0) &= Dose \\ \frac{dx_R}{dt}(t) &= -k_{on}x_L(t)x_R(t) + k_{off}x_{LR}(t), & x_R(0) &= R_{tot} \\ \frac{dx_{LR}}{dt}(t) &= k_{on}x_L(t)x_R(t) - k_{off}x_{LR}(t), & x_{LR}(0) &= 0.\end{aligned}$$

Chemical Reaction Network and Dynamical models

Example (minimal cAMP production model)

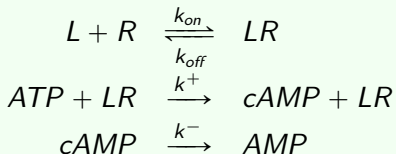

$$\begin{aligned}\frac{dx_L}{dt} &= -k_{on}x_Lx_R + k_{off}x_{LR}, & x_L(0) &= Dose \\ \frac{dx_R}{dt} &= -k_{on}x_Lx_R + k_{off}x_{LR}, & x_R(0) &= R_{tot} \\ \frac{dx_{LR}}{dt} &= k_{on}x_Lx_R - k_{off}x_{LR}, & x_{LR}(0) &= 0 \\ \frac{dx_{cAMP}}{dt} &= k^+x_{ATP}x_{LR} - k^-x_{cAMP}, & x_{cAMP}(0) &= 0 \\ \frac{dx_{ATP}}{dt} &= -k^+x_{ATP}x_{LR} & x_{ATP}(0) &= ATP_{tot}.\end{aligned}$$

But what is an "Ordinary Differential Equation"? A math theory in one slide!

The equation

$$\frac{dx}{dt} = v(x),$$

is numerically solved by successive time-step iteration, of small length $\Delta t \ll 1$:

- 1) Start at a given initial condition x_0 at time $t_0 = 0$

But what is an "Ordinary Differential Equation"? A math theory in one slide!

The equation

$$\frac{dx}{dt} = v(x),$$

is numerically solved by successive time-step iteration, of small length $\Delta t \ll 1$:

- 1) Start at a *given initial condition* x_0 at time $t_0 = 0$
- 2) To calculate the value of x at the first time step, remember that (*assuming constant speed*)

Final Position = Initial Position + velocity * Time ,

which becomes, in mathematical notations,

$$x(\Delta t) = x_0 + v(x_0) * \Delta t ,$$

But what is an "Ordinary Differential Equation"? A math theory in one slide!

The equation

$$\frac{dx}{dt} = v(x),$$

is numerically solved by successive time-step iteration, of small length $\Delta t \ll 1$:

- 1) Start at a given initial condition x_0 at time $t_0 = 0$
- 2) To calculate the value of x at the first time step, remember that (*assuming constant speed*)

Final Position = Initial Position + velocity * Time ,

which becomes, in mathematical notations,

$$x(\Delta t) = x_0 + v(x_0) * \Delta t ,$$

Iterate : To calculate the value of x at the next time step, use

$$x((i + 1) * \Delta t) = x(i * \Delta t) + v(x(i * \Delta t)) * \Delta t ,$$

But what is an "Ordinary Differential Equation"? A math theory in one slide...and a figure!

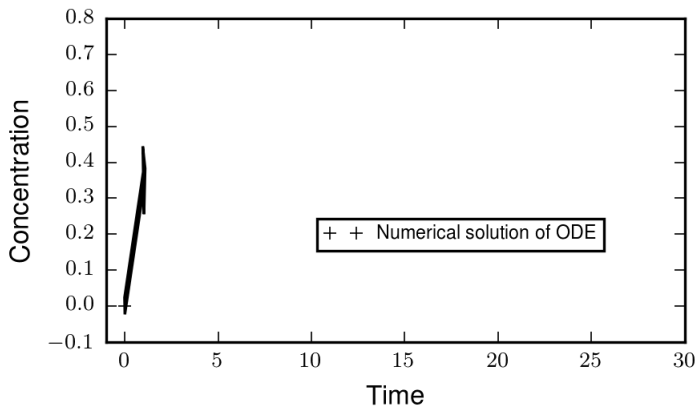

Figure – Solving an ODE

But what is an "Ordinary Differential Equation"? A math theory in one slide...and a figure!

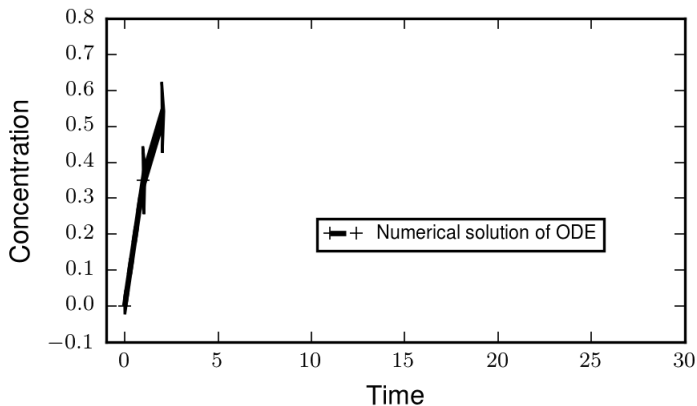

Figure – Solving an ODE

But what is an "Ordinary Differential Equation"? A math theory in one slide...and a figure!

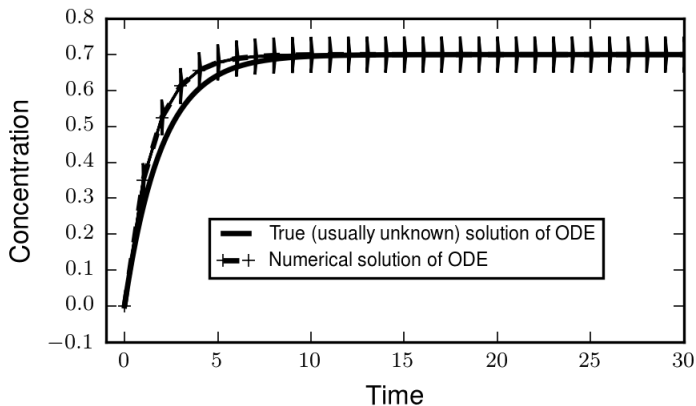
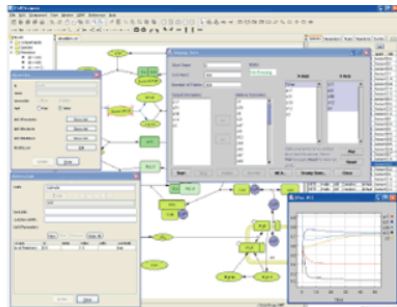
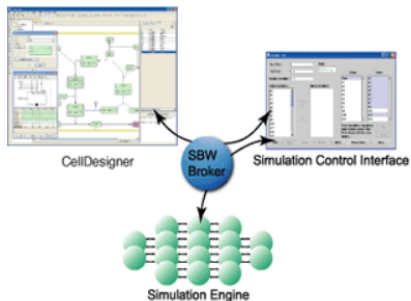

Figure – Solving an ODE

Solving an ODE in practice : no need to code !

ODE solver within Cell Designer



Funahashi, A., Tanimura, N., Morohashi, M., and Kitano, H.,
CellDesigner : a process diagram editor for gene-regulatory and
biochemical networks, BIOSILICO, 1 :159-162, 2003

Summary so far

We have seen

- ▶ Many examples of dynamical system biology models
- ▶ The formalism of *dynamical* reaction network models
- ▶ How to *build and simulate* a reaction network within Cell Designer

Summary so far

We have seen

- ▶ Many examples of dynamical system biology models
- ▶ The formalism of *dynamical* reaction network models
- ▶ How to *build and simulate* a reaction network within Cell Designer

NB : You don't need to code, but you need to specify kinetic rate and initial condition values to simulate a reaction network.

Summary so far

We have seen

- ▶ Many examples of dynamical system biology models
- ▶ The formalism of *dynamical* reaction network models
- ▶ How to *build and simulate* a reaction network within Cell Designer

NB : You don't need to code, but you need to specify kinetic rate and initial condition values to simulate a reaction network.

NB (bis) : You can play with this tools to "explore" the behavior of a model. But that can be time consuming and inefficient...

Summary so far

We have seen

- ▶ Many examples of dynamical system biology models
- ▶ The formalism of *dynamical* reaction network models
- ▶ How to *build and simulate* a reaction network within Cell Designer

What about inferring those values from data ?

Outline

Systems Biology and Networks

Motivations and Objectives

Chemical reaction network formalism

Parameter estimation

Applications

Parameter and network inference in Chemical Reaction Network

Goal : Given some time series data, find the minimal (biologically plausible) reaction network with its parameter (=reaction rates and initial conditions) that fits consistently the data.

Parameter and network inference in Chemical Reaction Network

Goal : Given some time series data, find the minimal (biologically plausible) reaction network with its parameter (=reaction rates and initial conditions) that fits consistently the data.

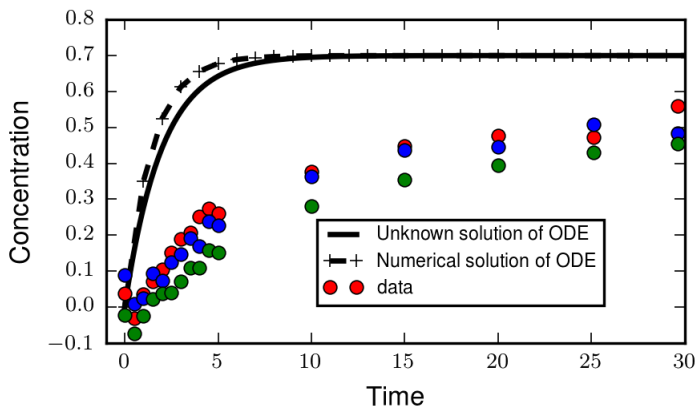

Parameter and network inference in Chemical Reaction Network

Goal : Given some time series data, find the minimal (biologically plausible) reaction network with its parameter (=reaction rates and initial conditions) that fits consistently the data.

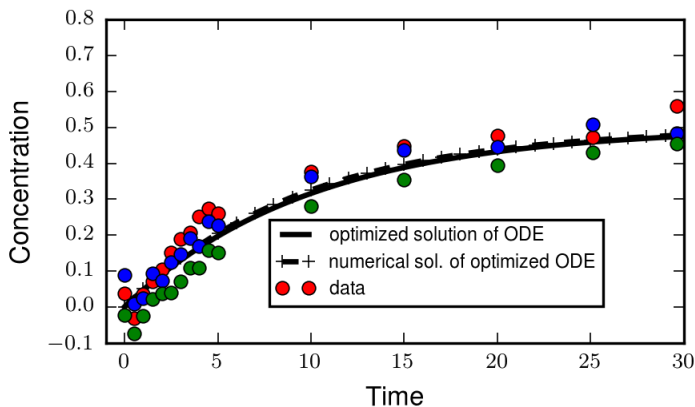

Regression analysis and Parameter estimation with time series : What is difficult ?

- ▶ In linear models, there exists a *unique optimal* solution
- ▶ Yet in practice, (generalized) linear models do not perform well on biochemical data due to **Heteroscedasticity** and **highly dependent time point** data.

Regression analysis and Parameter estimation with time series : What is difficult ?

- ▶ For most of (nonlinear) reaction network, there is no guarantee to find a unique optimal solution.
- ▶ Reaction network models allows to perform multifactorial analysis ("Anova-like")

Regression analysis and Parameter estimation with time series : What is difficult ?

- ▶ For most of (nonlinear) reaction network, there is no guarantee to find a unique optimal solution.
- ▶ Reaction network models allows to perform multifactorial analysis ("Anova-like")
- ▶ Many other tools exists from the statistical field of *time series analysis*.

Warning!

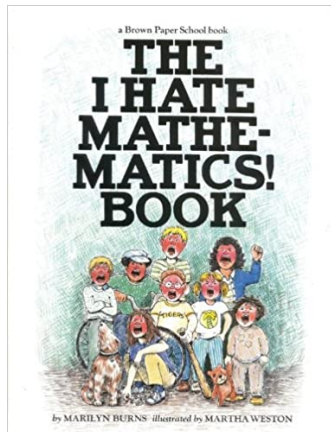

#Ihatemathematics

The following couples of slides contain some abstract notions...*but that the last ones!*

Parameter and network optimization in Chemical Reaction Network

Goal : Given some time series data, find the minimal (biologically plausible) reaction network with its parameter (=reaction rates and initial conditions) that fits consistently the data.

Strategy 1) From a given network $(\mathcal{S}, \mathcal{C}, \mathcal{R})$, with given parameter values, solve the ODEs,

$$\frac{dx}{dt} = v(x, k), \quad x(0) = x_0,$$

and compute a **distance** between the solution and the data.

Parameter and network optimization in Chemical Reaction Network

Goal : Given some time series data, find the minimal (biologically plausible) reaction network with its parameter (=reaction rates and initial conditions) that fits consistently the data.

Strategy 1) From a given network $(\mathcal{S}, \mathcal{C}, \mathcal{R})$, with given parameter values, solve the ODEs,

$$\frac{dx}{dt} = v(x, k), \quad x(0) = x_0,$$

and compute a **distance** between the solution and the data.

Strategy 2) Using **optimization** algorithms, find the best parameter values k, x_0 , to minimize the distance

Parameter and network optimization in Chemical Reaction Network

Goal : Given some time series data, find the minimal (biologically plausible) reaction network with its parameter (=reaction rates and initial conditions) that fits consistently the data.

Strategy 1) From a given network $(\mathcal{S}, \mathcal{C}, \mathcal{R})$, with given parameter values, solve the ODEs,

$$\frac{dx}{dt} = v(x, k), \quad x(0) = x_0,$$

and compute a **distance** between the solution and the data.

Strategy 2) Using **optimization** algorithms, find the best parameter values k, x_0 , to minimize the distance

Strategy 3) If needed, change the reaction network (add or delete species/reactions)

Parameter and network optimization in Chemical Reaction Network

Goal : Given some time series data, find the minimal (biologically plausible) reaction network with its parameter (=reaction rates and initial conditions) that fits consistently the data.

Statistics There exists a well developed statistical theory to assess the **quality of a fit** and to give **confidence interval** on parameter values (-> See Likelihood maximization or Bayesian statistics).

Parameter estimation in



Predefined or user-defined time-dependent equations

Model

Radioligand=HotNM*1e-9
Kob=[Radioligand]*Kon+Koff
Kd=Koff/Kon
Eq=Bmax*radioligand/(radioligand + Kd)
Association=Eq*(1-exp(-1*Kob*X))
YatTime0 = Eq*(1-exp(-1*Kob*Time0))
Dissociation= YatTime0*exp(-1*Koff*(X-Time0))
Y=IF(X<Time0, Association, Dissociation) + NS

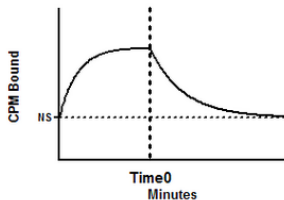

Parameter estimation in



- ▶ Limited to *solvable* models
- ▶ Adapted to analyze one single output at a time, assuming excess of Ligand.

Pharmechanics

Pharmacology Data Analysis
and Consulting

HOME DATA ANALYSIS CURVE FITTING CONSULTING ABOUT CONTACT

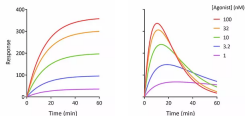

Hoare et al., Analyzing kinetic signaling data for G-protein-coupled receptors, Scientific Reports 10(1) :12263 2020

Predefined or user-defined time-dependent equations

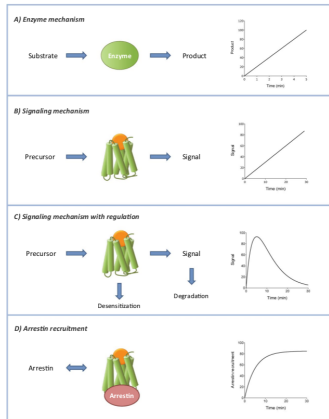

Parameter estimation in Copasi

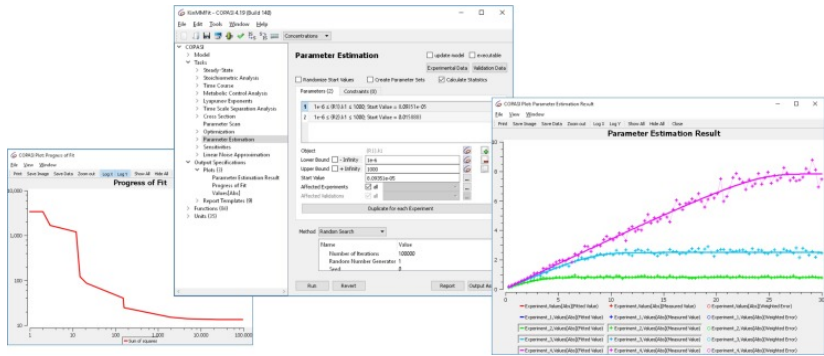

- ▶ Models can be imported from Cell Designer.
- ▶ Supports both graphical interface and command line.



Bergman et al. COPASI and its applications in biotechnology, *Journal of Biotechnology* 261 :215-220, 2017.

Hoops et al. COPASI : a COmplex PATHway Simulator. *Bioinformatics* 22 :3067-74, 2006.

Remember ! it's an iterative and interdisciplinary workflow !

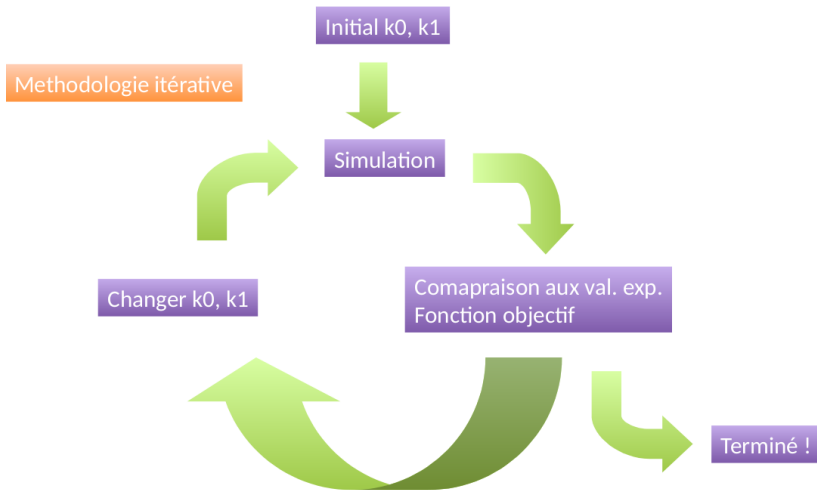

Remember! it's an iterative and interdisciplinary workflow!

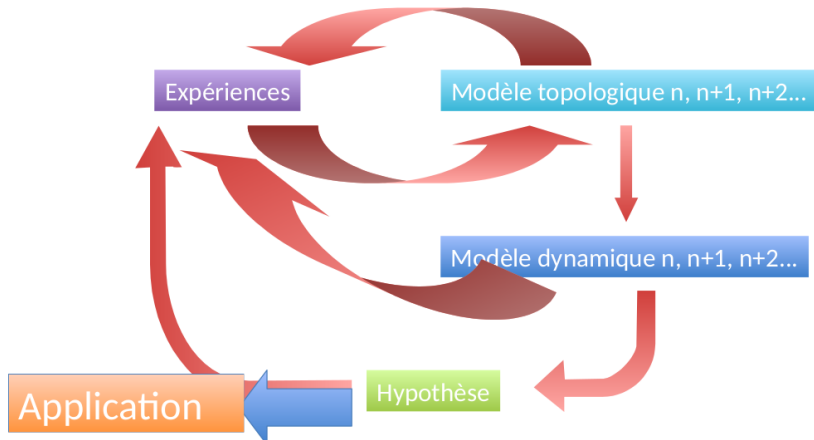

Is the monkey who typed Hamlet actually a good writer ?

Overfitting

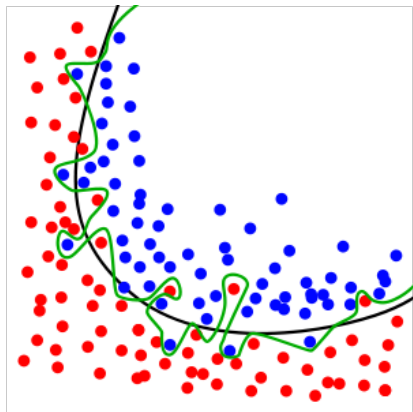

- ▶ There is a trade-off between toy minimal models and detailed biochemistry pathways.
- ▶ Overfitting leads to **unreliable** prediction and **meaningless** model / parameter value.
- ▶ (Advanced) statistical tools exist to sort this out : **model selection** (especially for hierarchical models) and **parameter identifiability**.

Summary so far

We have seen

- ▶ Many examples of dynamical system biology models
- ▶ The formalism of dynamical reaction network models
- ▶ How to build and simulate a reaction network model within Cell Designer.
- ▶ How to calibrate parameters of a dynamical reaction network model with GraphPad Prism and/or Copasi.

Summary so far

We have seen

- ▶ Many examples of dynamical system biology models
- ▶ The formalism of dynamical reaction network models
- ▶ How to build and simulate a reaction network model within Cell Designer.
- ▶ How to calibrate parameters of a dynamical reaction network model with GraphPad Prism and/or Copasi.

NB : The full workflow can be long and require collaboration with statistician / applied mathematician.

Summary so far

We have seen

- ▶ Many examples of dynamical system biology models
- ▶ The formalism of dynamical reaction network models
- ▶ How to build and simulate a reaction network model within Cell Designer.
- ▶ How to calibrate parameters of a dynamical reaction network model with GraphPad Prism and/or Copasi.

NB bis : **What about applications?** Go to session 8 :
Computational approaches !

Outline

Systems Biology and Networks

Motivations and Objectives

Chemical reaction network formalism

Parameter estimation

Applications

Some applications : Understanding G protein activation cycle

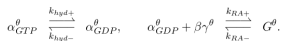
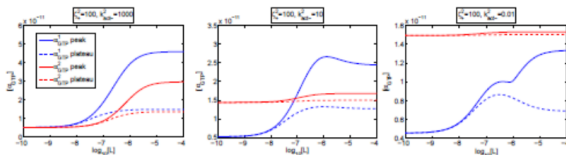

Bridge, Meads, Frattini, Winfield, Ladds, Modelling and simulation of biased agonism dynamics at a G protein-coupled receptor, J. Theoret. Biol. 442 :44–65, 2018

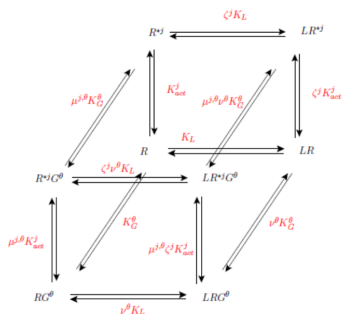

Some applications : Shedding light on GPCR-induced Calcium oscillations in Astrocytes

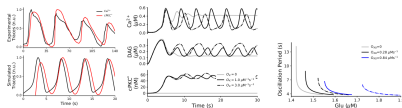
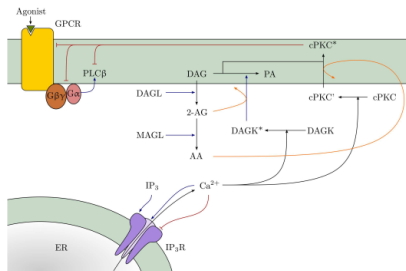

De Pittà, Ben-Jacob, Berry, G protein-coupled receptor-mediated calcium signaling in astrocytes, in Computational Glioscience, Springer 2019.

Some applications : Revisiting signaling bias using dynamical model

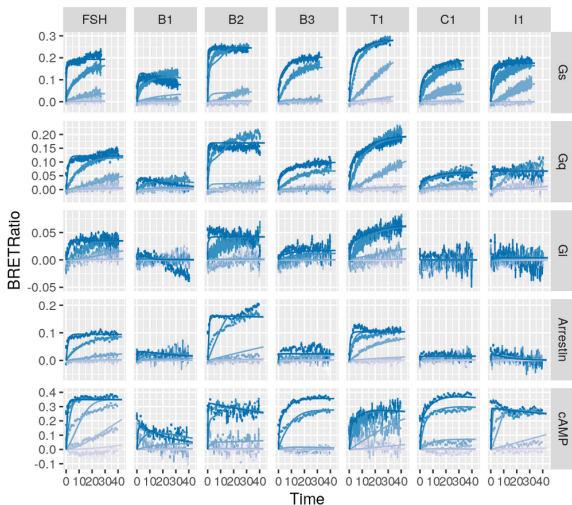

De Pascali, ..., R.Y.,..., *in preparation.*

Conclusions

- ▶ Dynamical reaction network framework has many different applications.
- ▶ Its a powerful framework to reveal comprehensive spatio-temporal patterns behind GPCR signaling complexities.
- ▶ Its a powerful framework to analyze quantitatively time series data in GPCR signaling.
- ▶ Adequate tools foster necessary interdisciplinary collaborations by providing a common language.