



HAL
open science

Modeling GPCR-induced biased signaling Towards a system biology definition of drugs selectivity

Romain Yvinec

► **To cite this version:**

Romain Yvinec. Modeling GPCR-induced biased signaling Towards a system biology definition of drugs selectivity. 9th GDR3545-GPCR international meeting, Nov 2020, Online, France. pp.1-42. hal-03115093

HAL Id: hal-03115093

<https://hal.science/hal-03115093>

Submitted on 19 Jan 2021

HAL is a multi-disciplinary open access archive for the deposit and dissemination of scientific research documents, whether they are published or not. The documents may come from teaching and research institutions in France or abroad, or from public or private research centers.

L'archive ouverte pluridisciplinaire **HAL**, est destinée au dépôt et à la diffusion de documents scientifiques de niveau recherche, publiés ou non, émanant des établissements d'enseignement et de recherche français ou étrangers, des laboratoires publics ou privés.

Modeling GPCR-induced biased signaling

Towards a system biology definition of drugs selectivity

Romain Yvinec

BIOS, INRAE Tours

Take-home Message : use Maths!

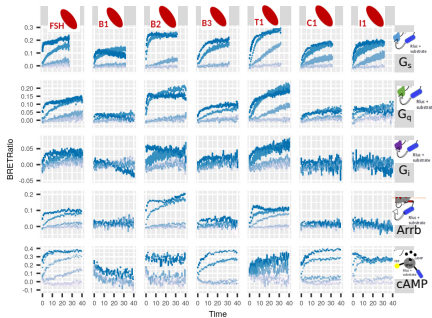

Kinetic pathway modeling to
 # Fully exploit kinetic data
 # Give mechanistic insight of pharmacological Ligand properties

$$\frac{d}{dt}[LR] = k_{ON}[L][R] - k_{OFF}[LR]$$

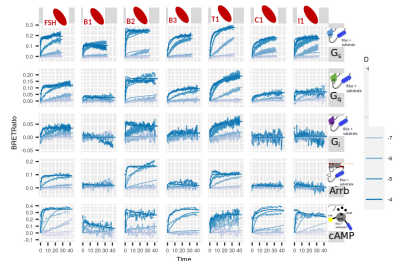
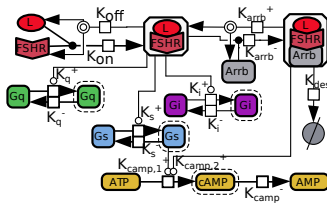

Biased signaling & standard quantification

Operational model

$$y = E_{tot} \frac{\tau [L]}{K_A + (\tau + 1)[L]}$$

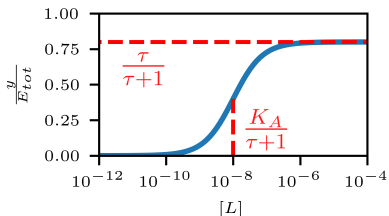

⇒ **Transduction coefficient :**

$$\log(R) := \log\left(\frac{\tau}{K_A}\right) = \frac{\text{Observed Efficacy}}{\text{Observed Potency}}$$

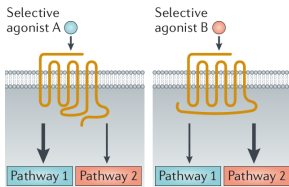

Kenakin and Christopoulos, *Nat. Rev. Drug Discov.* (2013)

J. W. Black and P. Leff



Equilibrium operational model

Black and Leff, *Proc. R. Soc. Lond. B* (1983).

Biased signaling & standard quantification

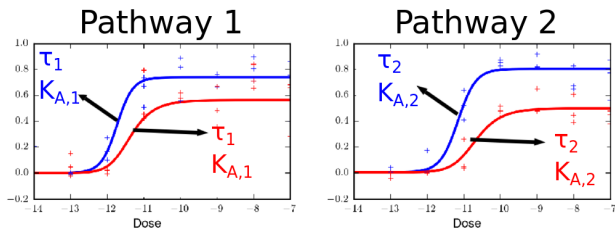

⇒ **Bias** : $\Delta \Delta \log(\tau/Ka) =$



$$(\log(\tau_1/K_{A,1}) - \log(\tau_2/K_{A,2})) - (\log(\tau_1/K_{A,1}) - \log(\tau_2/K_{A,2}))$$

Identifiability issue : Zhu et al., BJP 175 :1654–1668, 2018

Pro

- ★ Mechanistic basis
- ★ Generic and widely applicable
- ★ A single parameter

Cons

- ★ No kinetic
- ★ Inconsistent within a transduction pathway
- ★ A single parameter

Biased signaling & standard quantification

- The transduction coefficient is not always meaningful
- Identifiability rely on correct estimation of observed Potency

Pro

- ★ Mechanistic basis
- ★ Generic and widely applicable
- ★ A single parameter

Scanning over fixed R

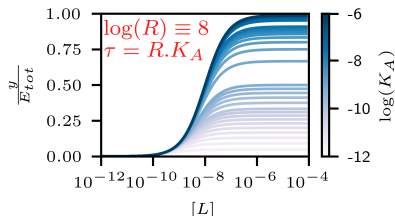

Cons

- ★ No kinetic
- ★ Inconsistent within a transduction pathway
- ★ A single parameter

Time-dependent bias ?

The role of kinetic context in apparent biased agonism at GPCRs

Carmen Klein Herenbrink¹, David A. Sykes², Prashant Donthamsetti^{3,4}, Meritxell Canals¹, Thomas Coudrat¹, Jeremy Shonberg⁵, Peter J. Scammells⁵, Ben Capuano⁵, Patrick M. Sexton¹, Steven J. Charlton², Jonathan A. Javitch^{3,4,6}, Arthur Christopoulos¹ & J Robert Lane¹

- Bias value may change according to the response time after stimulation.
- Kinetic explanation : Ligands with a **slow binding** kinetics may have changing bias value according to time.



Klein Herenbrink et al., *Nat. Commun* (2016)

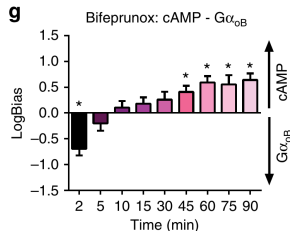
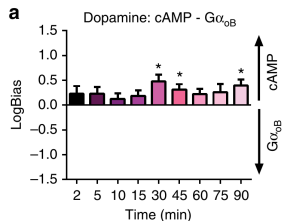

Time-dependent bias ?

The role of kinetic context in apparent biased agonism at GPCRs

Carmen Klein Herenbrink¹, David A. Sykes², Prashant Donthamsetti^{3,4}, Meritxell Canals¹, Thomas Coudrat¹, Jeremy Shonberg⁵, Peter J. Scammells⁵, Ben Capuano⁵, Patrick M. Sexton¹, Steven J. Charlton², Jonathan A. Javitch^{3,4,6}, Arthur Christopoulos¹ & J Robert Lane¹

- Bias value may change according to the response time after stimulation.
 - Kinetic explanation : Ligands with a **slow binding** kinetics may have changing bias value according to time.
- ⇒ **We need to take into account dynamic patterns in bias quantification**

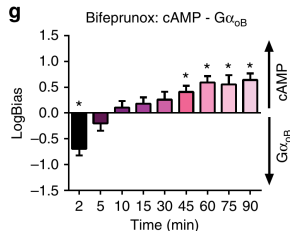
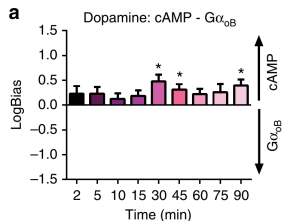

Motivations and Case study

Use **reaction network modeling** (*kinetic pathway*) to

- Fully exploit kinetic data
- Give more mechanistic insight of **signaling bias**
- Develop a parsimonious and **statistically significant** framework to characterize pharmacological ligand properties

Motivations and Case study

Use **reaction network modeling** (*kinetic pathway*) to

- Fully exploit kinetic data
- Give more mechanistic insight of **signaling bias**
- Develop a parsimonious and **statistically significant** framework to characterize pharmacological ligand properties

Case study on FSHR

- ★ 5 BRET sensors : NES-Venus mG, yPET- β -arrestin 2, Camy1
- ★ FSH + 6 LMW compounds (Benzamides, Thiazolidinone, Chromenopyrazole, Imidazole) (TocopheRx, Burlington, VT, USA).

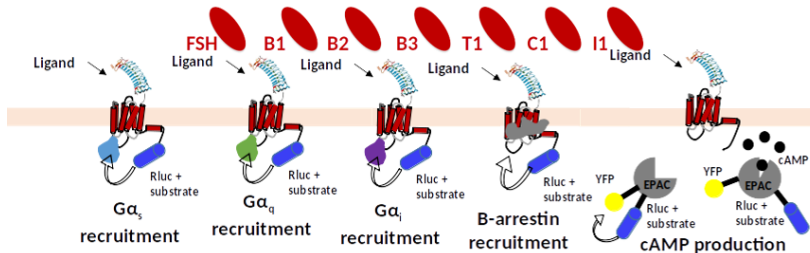



Francesco De Pascali

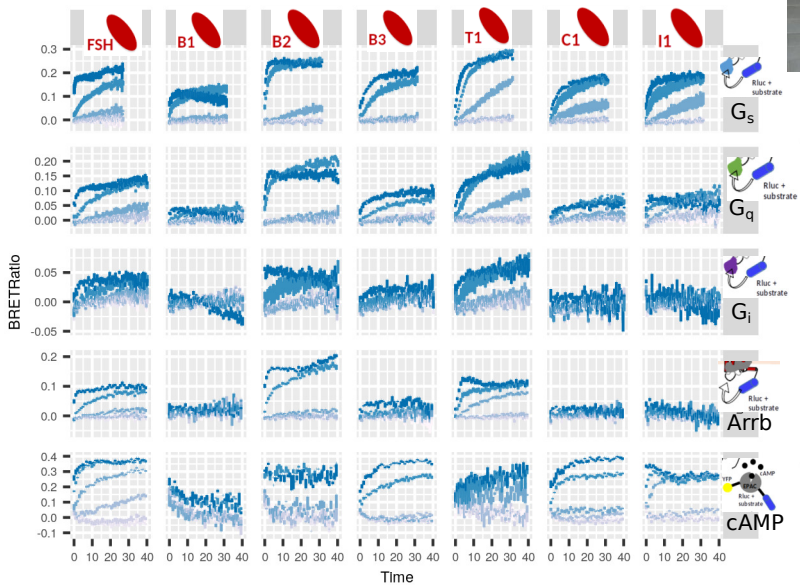

Potency and Efficacy (and bias) are time point dependent

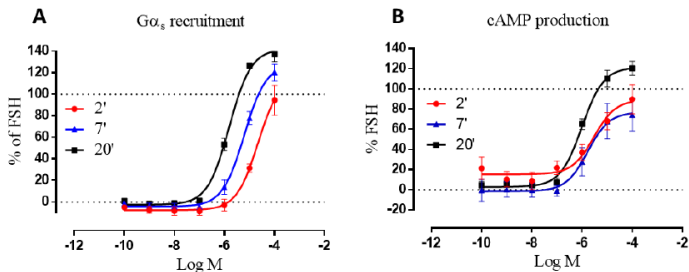

C

	$G\alpha_s$ recruitment			cAMP production		
Ligand	2'	7'	20'	2'	7'	20'
Emax (% of max average) \pm SEM (n=6)						
FSH	117.1 \pm 10.6	120.2 \pm 11.5	104.1 \pm 8.3	102.7 \pm 1.8	100.6 \pm 2.1	98.2 \pm 1.3
T1	116.9 \pm 12.2	127.7 \pm 5.8	129.1 \pm 2.7	89.5 \pm 9.5	77.3 \pm 10.1	121.6 \pm 4.3
Ligand pEC ₅₀ \pm SEM (n=6)						
T1	4.7 \pm 0.1	5.2 \pm 0.1	5.8 \pm 0.1	5.5 \pm 0.3	5.7 \pm 0.3	6.0 \pm 0.1

Operational model with A.U.C

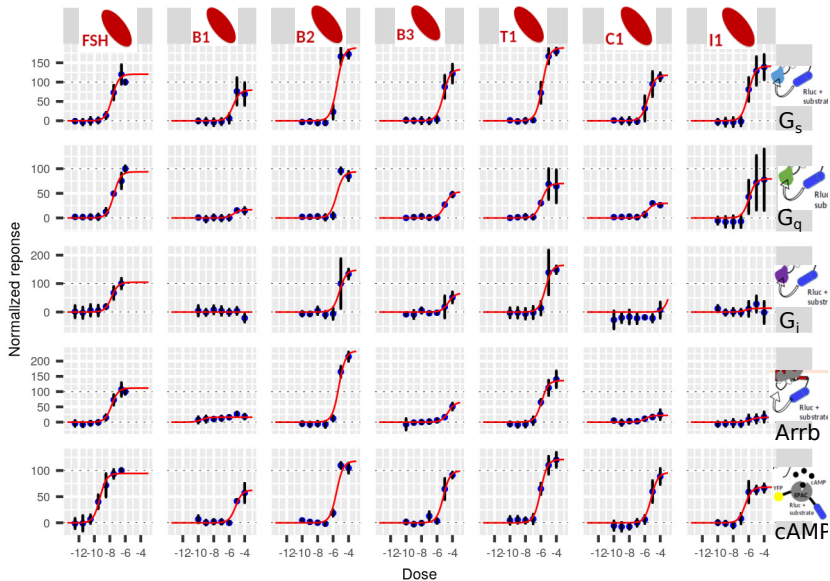

Operational model with A.U.C

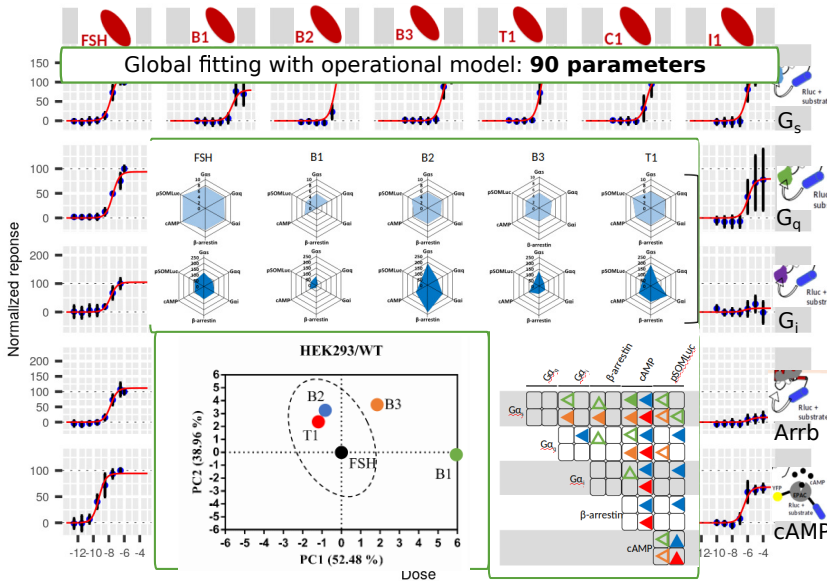

Reaction network : multiple Pathways modeling

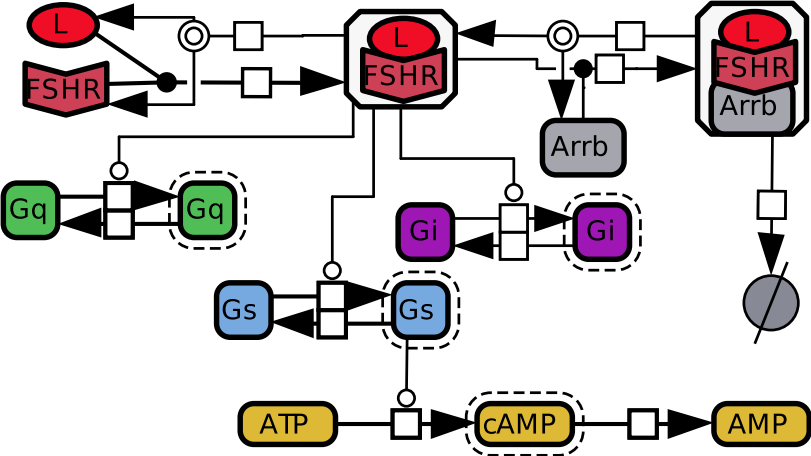

Generate all pathways at once

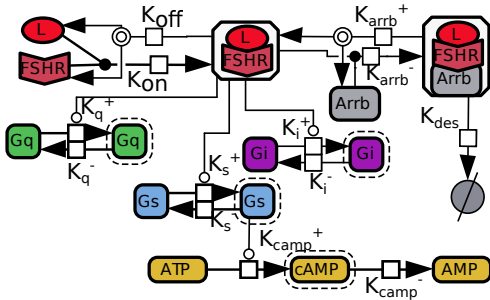

- Dynamic reaction networks (ODE) keep track of **concentration** of each molecule along time.
- Parameters : **initial quantity** of molecules and **kinetic rates** (13).

Mechanistic link with data

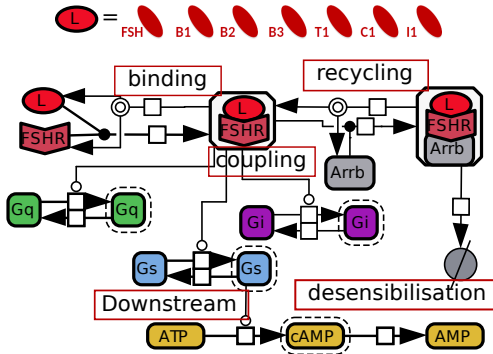

We hypothesize that

- Kinetic rate values reflects **pharmacological ligand properties**.
- Measurements are performed in a same cellular context.
- Measurements are **proportional** to concentration of molecules.

Mechanistic link with data

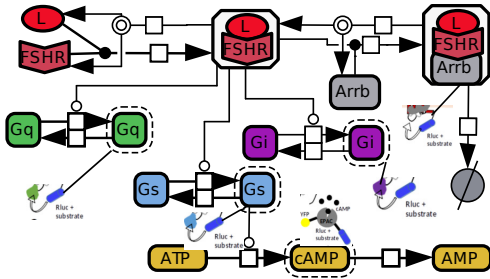

We hypothesize that

- Kinetic rate values reflects **pharmacological ligand properties**.
- Measurements are performed in a same cellular context.
- Measurements are **proportional** to concentration of molecules.

Signaling profile diversity

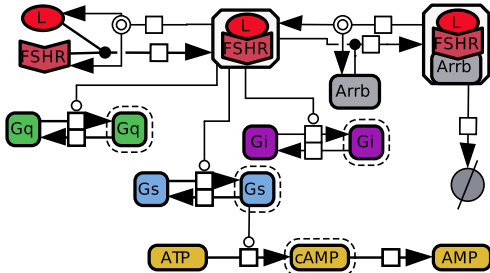

- The model is "minimal" (*model selection criteria*)
- We generalize recent attempts to define a "kinetic operational model" (Watch Nicola Dijon's flash presentation)



Hoare et al., Analyzing kinetic

signaling data for G-protein-coupled receptors,

Scientific Reports 2020

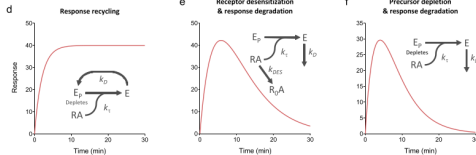

Global fitting enforcing sparsity

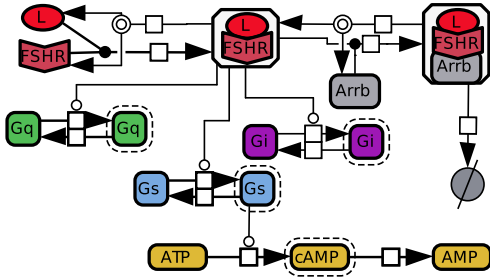

- Our method is a global fitting approach (all pathways, all ligand).
- We enforce Ligand specific parameters through penalization.



Raue et al., Data2Dynamics : a

modeling environment tailored to parameter estimation in dynamical systems,

Bioinformatics 2015



Steiert et al., L1 regularization

facilitates detection of cell type-specific parameters in dynamical systems,

Bioinformatics 2016

Can we really infer parameter from kinetic data ?

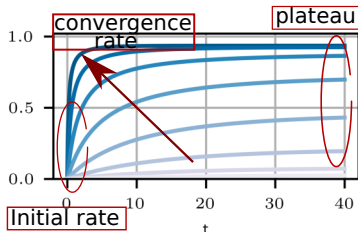
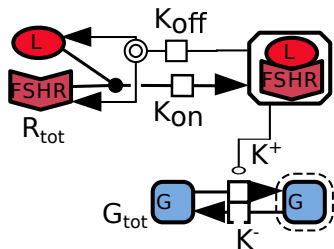

- Initial rate

$$\frac{1}{2} R_{tot} G_{tot} k_{on} k^+ [L] t^2$$

- Equilibrium

$$\frac{R_{tot} G_{tot} [L]}{K_A + (R_{tot} + K_E) [L]}$$

- Convergence rate

$$k^+ \frac{R_{tot} [L]}{K_A + [L]} + k^-$$

$$K_A = \frac{K_{off}}{K_{on}}, K_E = \frac{K^-}{K^+}$$

Can we really infer parameter from kinetic data ?

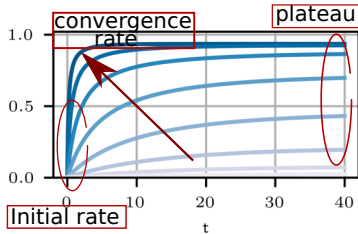
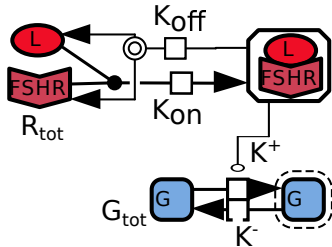

- Initial rate
 $\frac{1}{2} R_{tot} G_{tot} k_{on} k^+ [L] t^2$
 - Equilibrium $\frac{R_{tot} G_{tot} [L]}{K_{A+} (R_{tot} + K_E) [L]}$
 - Convergence rate
 $k^+ \frac{R_{tot} [L]}{K_{A+} [L]} + k^-$
- In practice the global fitting improves parameter identifiability.
- Low doses and long time signal are important.

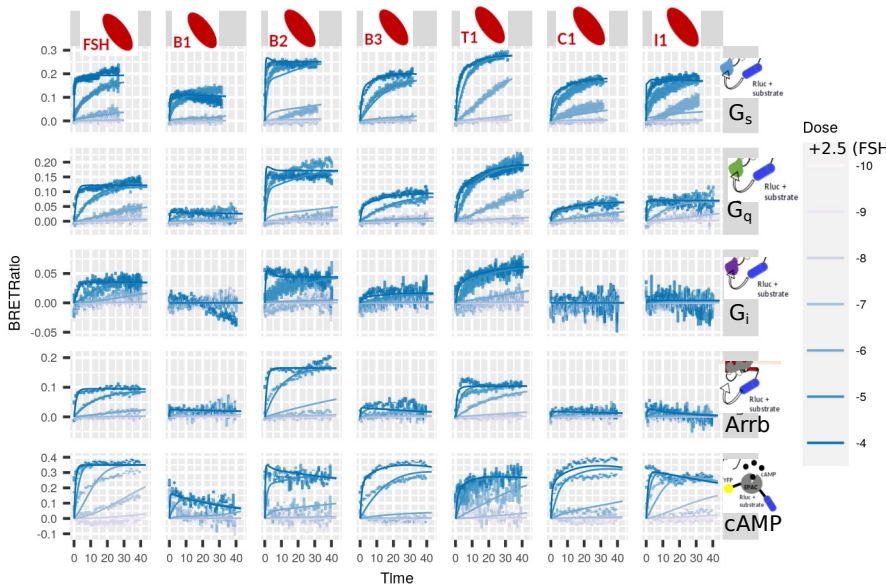

Inferring Binding and Desensibilisation constants

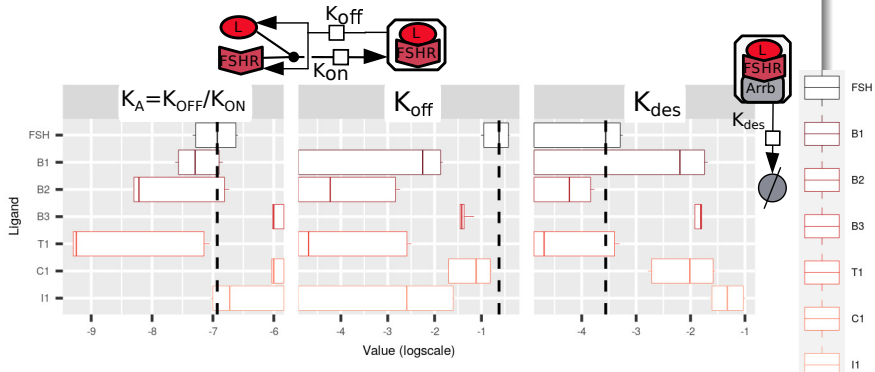

⇒ We can infer K_A (with potentially asymmetric confidence intervals).

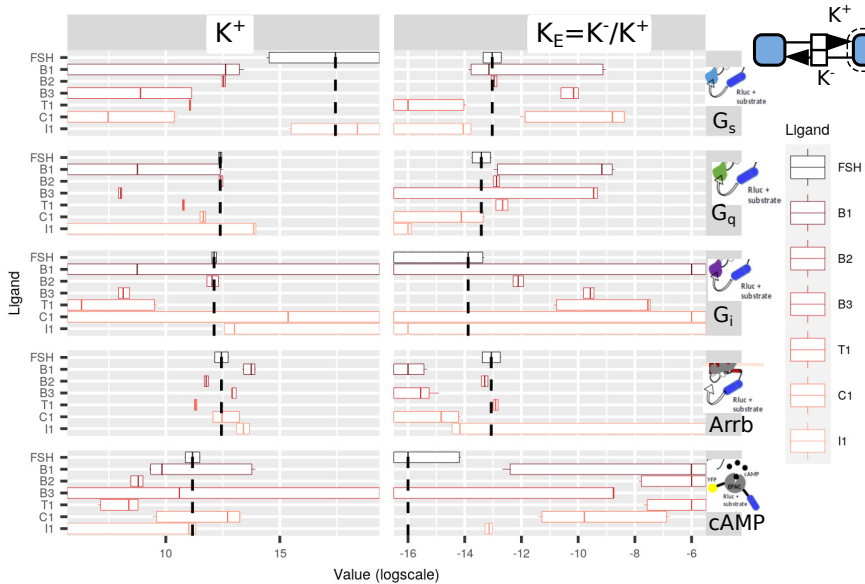

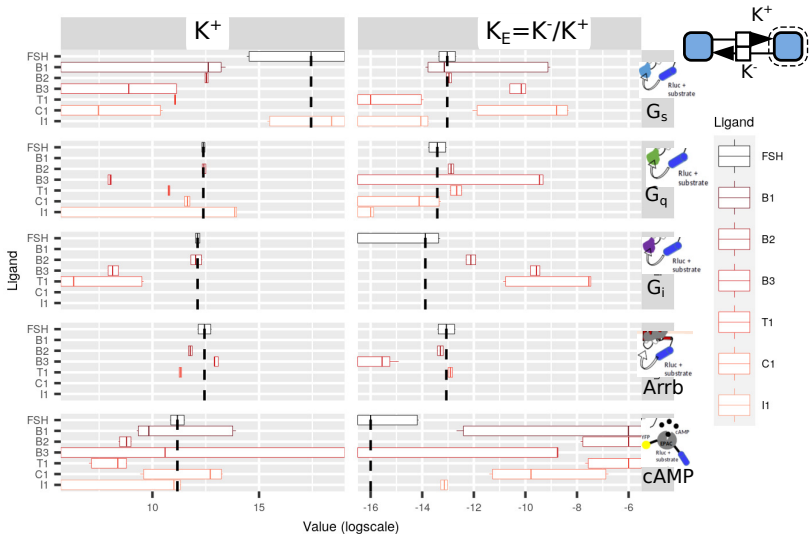

⇒ Non-identifiable parameters are consistent with no signals from data.

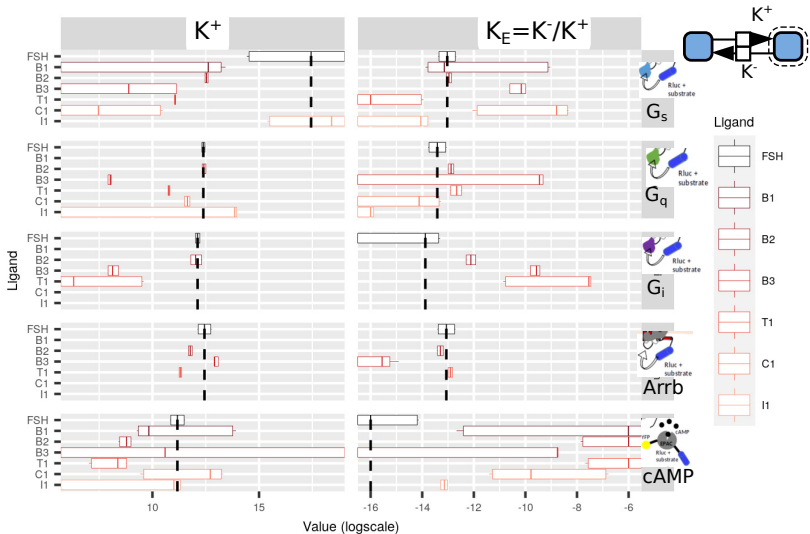

⇒ Large confidence intervals result from "incomplete/noisy" time series.

"FSH" cluster

Higher affinity
smaller "kinetic efficacy"

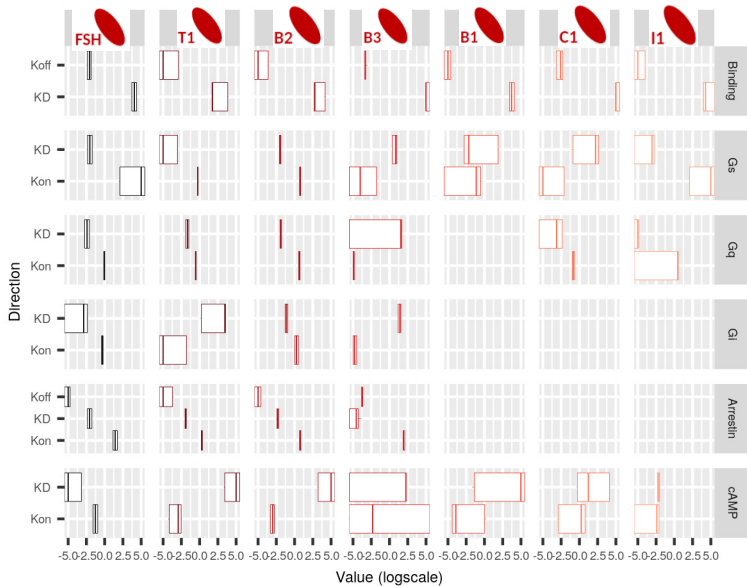

Ligand

FSH

T1

B2

B3

B1

C1

I1

"FSH" cluster

Higher affinity
smaller "kinetic efficacy"

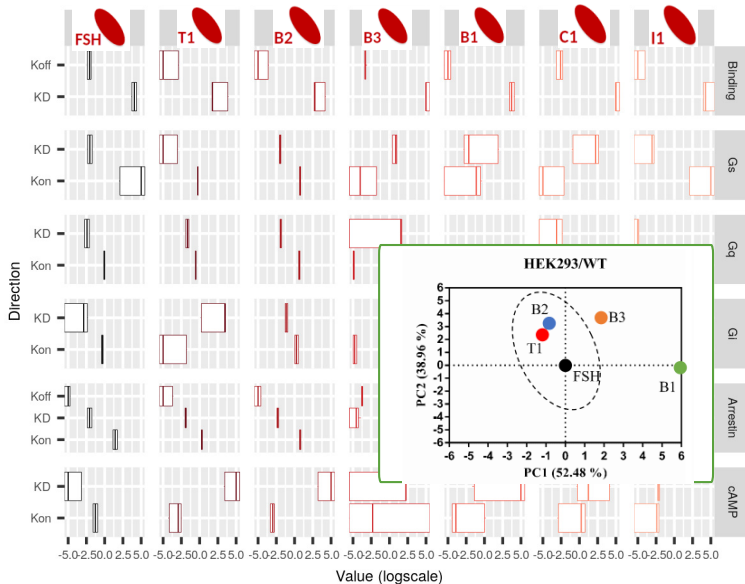

Ligand

FSH

T1

B2

B3

B1

C1

I1

Consistency with the Operational model

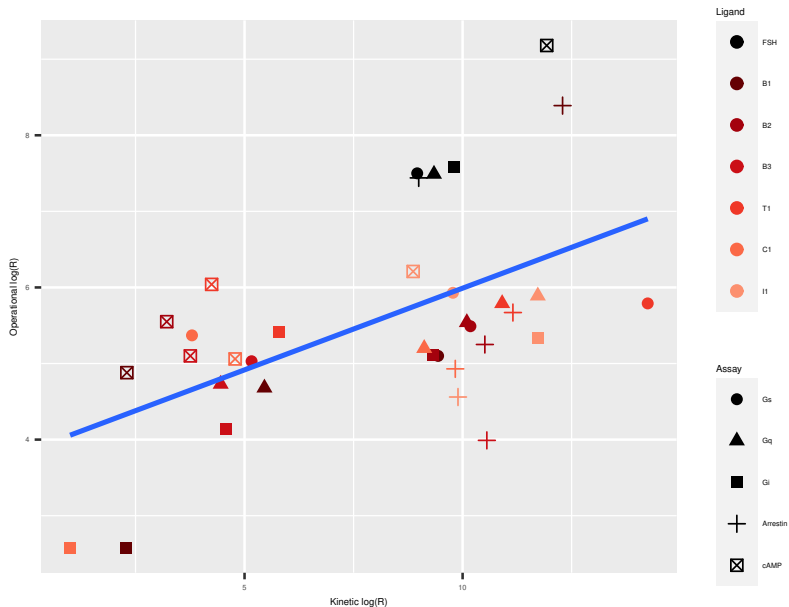

Summary

- We gave a fully kinetic and mechanistic description of Ligand biased, which rely on kinetic data and dynamic (ODE) modeling, with (advanced) statistical parameter estimation and L^1 penalization to reduce combinatorial complexity.
- Our approach was consistent with equilibrium operational model, yet shed lights on ad-hoc clustering analysis.
- Parameter identifiability requires a case by case study (highly dependent on data "quality").

- Include different cell-type \rightarrow system bias
- Measurements : sensor needs to be robust ! (Initial rate, long time behavior, dynamics range)
- Use time-dependent input to improve identifiability

Prediction for washed out experiments

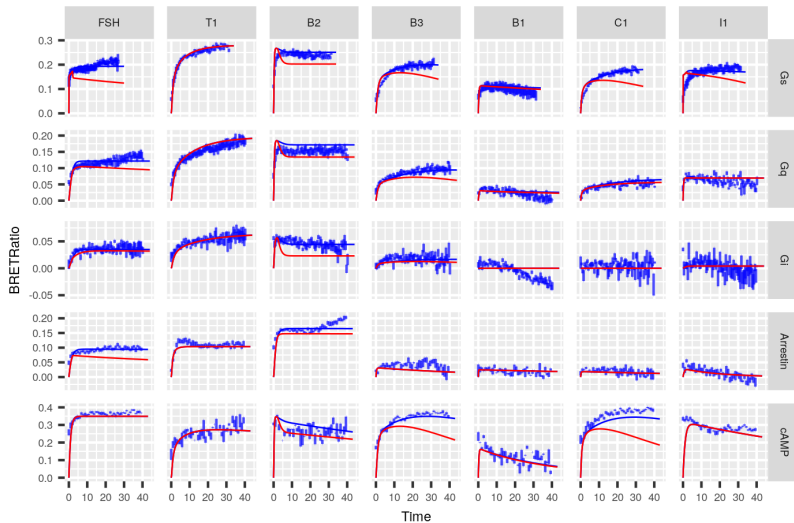

Prediction for washed out experiments

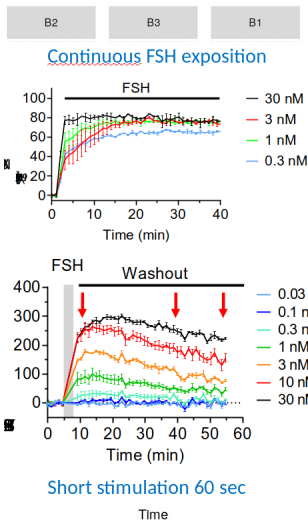
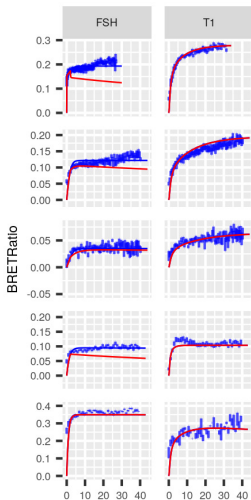

Work in progress
Fred Jean-Alphonse

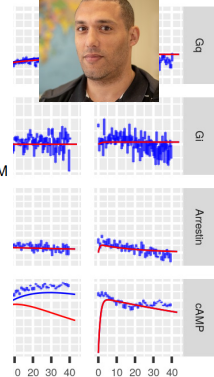

Thanks for your attention !

Bios Team, PRC, INRAE (Tours, Fr)

- ★ Eric Reiter
- ★ Pascale Crépieux
- ★ Anne Poupon
- ★ Frédéric Jean-Alphonse
- ★ Lucie Pelissier
- ★ Francesco De Pascali

Musca Team, INRIA-CNRS-INRAE

- ★ Frédérique Clément
- ★ Béatrice Laroche

United Arab Emirates University

- ★ Mohammed Ayoub



M. Ayoub et al., *Molecular and Cellular Endocrinology* 436 (2016)



L. Riccetti et al., *Scientific Reports* 7 :940 (2017)



R.Y. et al., *Methods in Molecular Biology*, in press (2018)



De Pascali, ..., R.Y.,..., *in preparation*

Fitting and identifiability : why not more relevant details ?

General trends while increasing model complexity :

- Improve data adjustment (increase likelihood)

- Loss of parameter identifiability

⇒ Model selection provides a solution to find an optimum model within a series of submodel, and given a dataset.

Methodological challenges

- ⇒ How to make the network and parameter inference more robust?
- ⇒ How to make the modeling and optimization process "automatic" and "generic"?

