



HAL
open science

Kinetic biased signaling: towards a system biology definition of drugs selectivity

Romain Yvinec

► **To cite this version:**

Romain Yvinec. Kinetic biased signaling: towards a system biology definition of drugs selectivity. Thematic Month on Mathematical Issues in Biology - Networks and molecular biology, Mar 2020, Luminy, France. pp.1-75. hal-03115087

HAL Id: hal-03115087

<https://hal.science/hal-03115087v1>

Submitted on 19 Jan 2021

HAL is a multi-disciplinary open access archive for the deposit and dissemination of scientific research documents, whether they are published or not. The documents may come from teaching and research institutions in France or abroad, or from public or private research centers.

L'archive ouverte pluridisciplinaire **HAL**, est destinée au dépôt et à la diffusion de documents scientifiques de niveau recherche, publiés ou non, émanant des établissements d'enseignement et de recherche français ou étrangers, des laboratoires publics ou privés.

Kinetic biased signaling: towards a system biology definition of drugs selectivity.

Romain Yvinec

BIOS, INRAE Tours

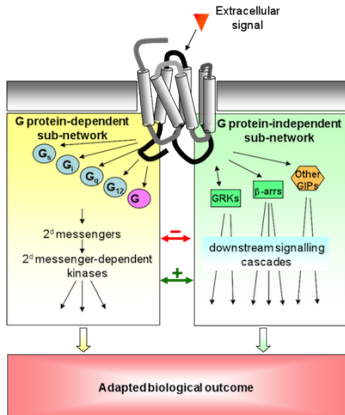

INRAE Tours, Physiologie
de la Reproduction et des
Comportements

Biology & Bioinformatics of Signaling Systems : multidisciplinary approaches, linking biology, mathematics and information technology to experimental biology, in order to decipher the intracellular effects induced by reproductive hormones through the activation of their cognate receptors.

Functional selectivity, biased signaling

What is Drugs Selectivity ?

- Several reaction pathways are generally associated to a given receptor, and lead to various cell response.

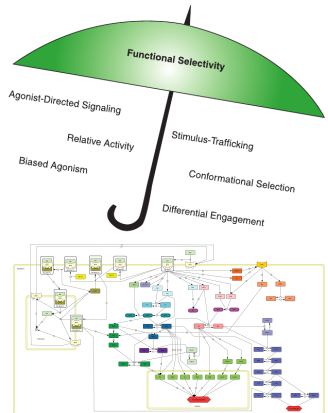

Functional selectivity, biased signaling

What is Drugs Selectivity ?

- Several reaction pathways are generally associated to a given receptor, and lead to various cell response.
- Differential activation of those reaction pathways, that differs between (natural or synthetic) ligand

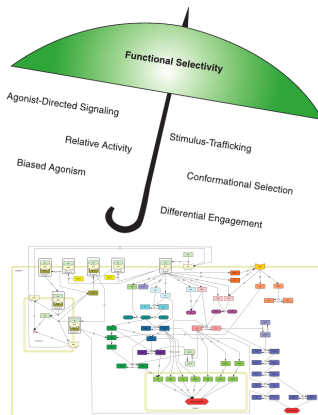

Functional selectivity, biased signaling

What is Drugs Selectivity ?

- Several reaction pathways are generally associated to a given receptor, and lead to various cell response.
- Differential activation of those reaction pathways, that differs between (natural or synthetic) ligand
- **Drugs Selectivity** = Ligand-dependent selectivity for certain signal transduction pathways at one given receptor

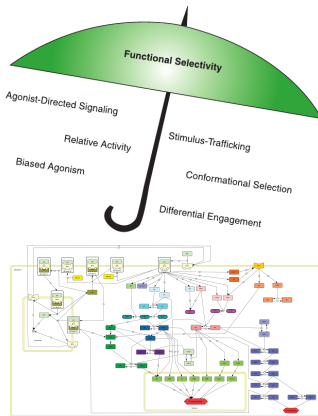

Key concept in pharmacology

- ◇ Drugs Selectivity (or Biased Signaling) is a key concept to be distinguish from
 - Partial or full agonist.
 - Antagonist, inverse agonist.
 - Affinity (K_d), potency (EC_{50}), efficacy (E_{max}).

Key concept in pharmacology

- ◇ Drugs Selectivity (or Biased Signaling) is a key concept to be distinguish from
 - Partial or full agonist.
 - Antagonist, inverse agonist.
 - Affinity (K_d), potency (EC_{50}), efficacy (E_{max}).
- ◇ A bias might be **context-dependent** (cell type, physiological state, etc.)

Key concept in pharmacology

- ◇ Drugs Selectivity (or Biased Signaling) is a key concept to be distinguish from
 - Partial or full agonist.
 - Antagonist, inverse agonist.
 - Affinity (K_d), potency (EC_{50}), efficacy (E_{max}).
 - ◇ A bias might be **context-dependent** (cell type, physiological state, etc.)
 - ◇ Biased agonism is becoming a **major tool in drug discovery**.
- ⇒ Candidate screening requires to accurately quantify bias.

Key concept in pharmacology

- ◇ Drugs Selectivity (or Biased Signaling) is a key concept to be distinguish from
 - Partial or full agonist.
 - Antagonist, inverse agonist.
 - Affinity (K_d), potency (EC_{50}), efficacy (E_{max}).
 - ◇ A bias might be **context-dependent** (cell type, physiological state, etc.)
 - ◇ Biased agonism is also a powerful tool to **challenge our knowledge of signaling systems**.
- ⇒ "Perturbation" experiments with different biased ligands.

Theoretical foundation

A receptor may adopt several spatial conformations, each of which has different activation pathway profiles.

Conformational selectivity =
Ligand-specific modification
of the energetic landscape,
changing affinities and
efficacies of signaling
pathways.

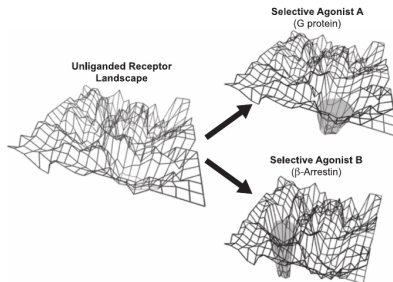

Kenakin, *J Pharmacol Exp Ther* (2011)

Theoretical foundation

A receptor may adopt several spatial conformations, each of which has different activation pathway profiles.

Conformational selectivity = Ligand-specific modification of the energetic landscape, changing affinities and efficacies of signaling pathways.

Similar concept : modulating bias

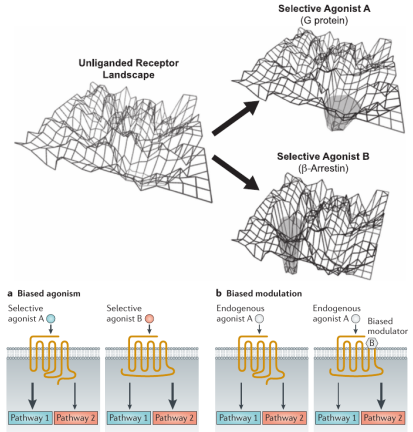

Minimal setting

To speak about signaling bias, one necessarily needs **two** ligands and **two** responses, in a **same** cellular context.

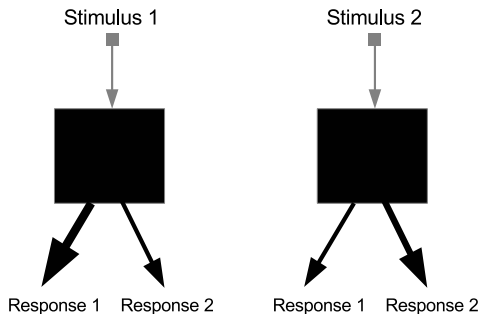

⇒ We always compare a ligand with respect to a reference one.

Some examples

Bias quantification - standard method : operational model

Time-dependent bias

Biased quantification using dynamical model

Serotonin receptor 5 – HT_{2C}

- Quipazine is biased towards *PI* accumulation with respect to AA production, compared to the reference agonist DOI.
- LSD is not biased.



Berg et al., *Mol. Pharmacol.* (1998)

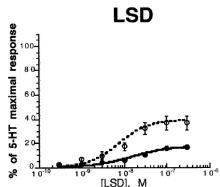
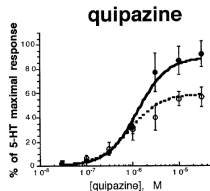
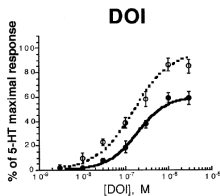

--○-- AA release
—●— IP accumulation

Serotonin receptor 5 – HT_{2C}

- Quipazine is biased towards PI accumulation with respect to AA production, compared to the reference agonist DOI .
 - LSD is not biased.
- ⇒ Bias due to an E_{max} difference.



Berg et al., *Mol. Pharmacol.* (1998)

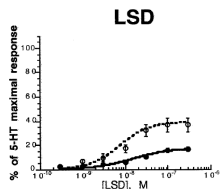
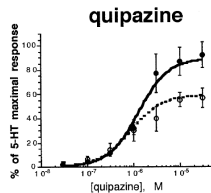
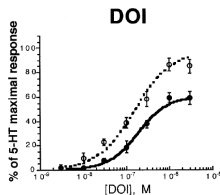

---○--- AA release
—●— IP accumulation

Serotonin receptor 5 – HT_{2A}

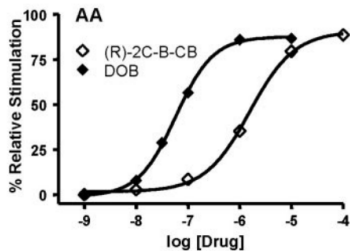
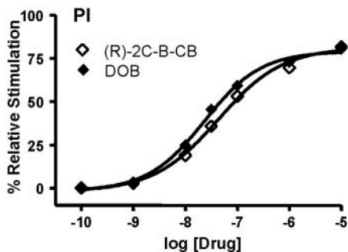

- (*R*) – 2C – B – CB is biased towards *PI* accumulation with respect to *AA* production, compared to the reference agonist *DOB*.



Urban et al., *J Pharmacol Exp Ther* (2007)

Serotonin receptor 5 – HT_{2A}

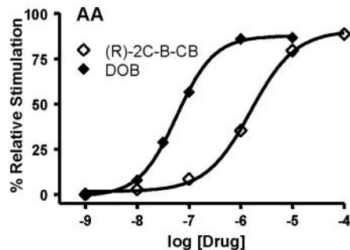
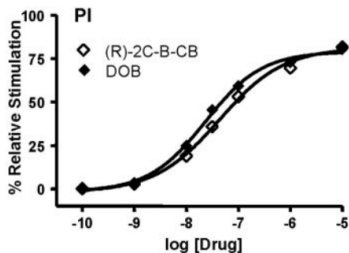

- (*R*) – 2C – B – CB is biased towards *PI* accumulation with respect to *AA* production, compared to the reference agonist *DOB*.

⇒ Bias due to an EC_{50} difference.



Urban et al., *J Pharmacol Exp Ther* (2007)

Many more examples on G Protein Coupled Receptor

Many GPCR's are known to have biased ligands

- *G* vs β -arrestin dependent signaling pathway



Kenakin, *Chem Rev* (2017)

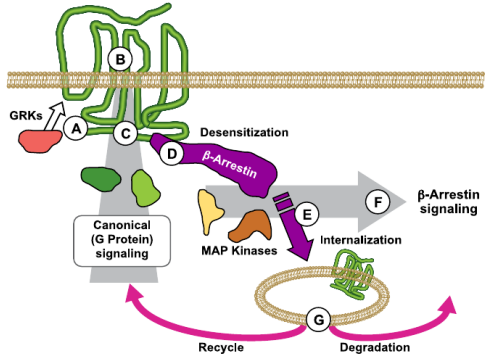

Biased at more "integrated" response : Steroidogenesis modulated by NAM

Some negative allosteric modulators (NAM) can bias Progesterone production with respect to Testosterone production, under stimulation of LH/CG receptor by hCG.



Ayoub et al., *Mol. Cell. Endocrinol* (2016)

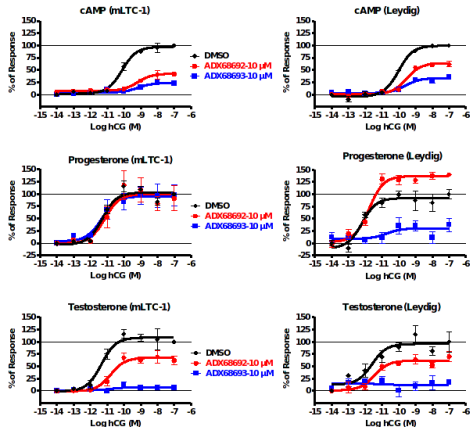

Biased at more "integrated" response : Steroidogenesis modulated by NAM

Some negative allosteric modulators (NAM) can bias Progesterone production with respect to Testosterone production, under stimulation of LH/CG receptor by hCG.

⇒ Selective (biased) allosteric modulation



Ayoub et al., *Mol. Cell. Endocrinol* (2016)

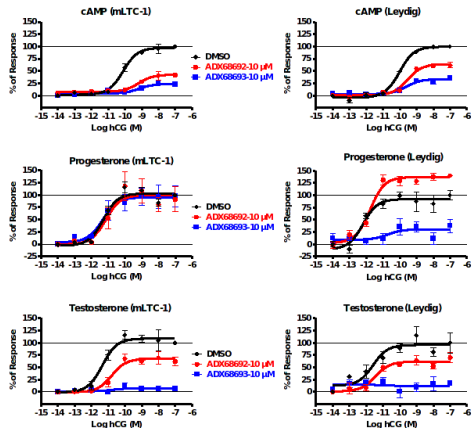

Outline

Some examples

Bias quantification - standard method : operational model

Time-dependent bias

Biased quantification using dynamical model

Dose-response data are fitted with the function

$$y = E_{tot} \frac{\tau^n [L]^n}{([L] + Ka)^n + \tau^n [L]^n} \cdot$$

- Response at equilibrium of a Michaelis-Menten type model.
- Ka = **Dissociation constant** of the couple Ligand/Receptor
- τ = **Efficacy coefficient** of the transduction pathway

J. W. Black and P. Leff

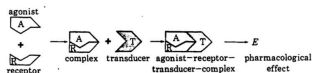

Black and Leff, *Proc. R. Soc. Lond. B* (1983)

Dose-response data are fitted with the function

$$y = E_{tot} \frac{\tau^n [L]^n}{([L] + Ka)^n + \tau^n [L]^n} .$$

For $n = 1$,

- $EC_{50} = \frac{Ka}{\tau+1}$
- Efficacy $y_{\infty}/E_{tot} = \frac{\tau}{\tau+1}$

J. W. Black and P. Leff

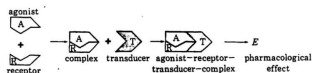

Black and Leff, *Proc. R. Soc. Lond. B* (1983)

Dose-response data are fitted with the function

$$y = E_{tot} \frac{\tau^n [L]^n}{([L] + Ka)^n + \tau^n [L]^n} .$$

For $n = 1$,

- $EC_{50} = \frac{Ka}{\tau + 1}$
- Efficacy $y_{\infty} / E_{tot} = \frac{\tau}{\tau + 1}$

Then, we define

⇒ **Transduction coefficient** :

$$R := \log \left(\frac{\tau}{Ka} \right)$$

J. W. Black and P. Leff

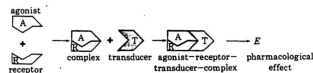

Black and Leff, *Proc. R. Soc. Lond. B* (1983)

Bias quantification : with the operational model

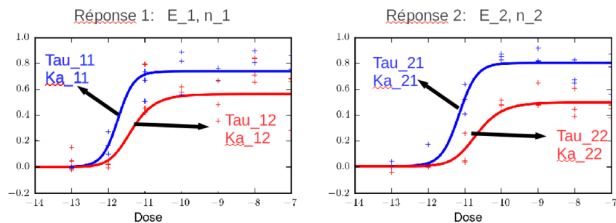

Two ligands ($j = 1, 2$) and **two** measured responses ($i = 1, 2$) :
Each dose-response data is fitted with the operational model :

$$y_{ij} = E_i \frac{\tau_{ij}^{n_i} [L]^{n_i}}{([L] + Ka_{ij})^{n_i} + \tau_{ij}^{n_i} [L]^{n_i}} .$$

Bias quantification : with the operational model

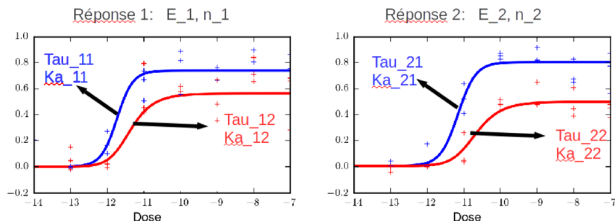

Two ligands ($j = 1, 2$) and **two** measured responses ($i = 1, 2$) :
Each dose-response data is fitted with the operational model :

$$y_{ij} = E_i \frac{\tau_{ij}^{n_i} [L]^{n_i}}{([L] + Ka_{ij})^{n_i} + \tau_{ij}^{n_i} [L]^{n_i}}$$

For a given response i , we calculate
 $\Delta_i \log(\tau/Ka) = \log(\tau_{i2}/Ka_{i2}) - \log(\tau_{i1}/Ka_{i1})$.

Bias quantification : with the operational model

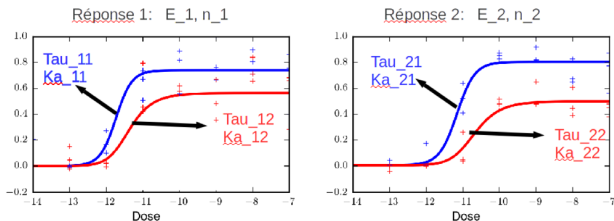

Two ligands ($j = 1, 2$) and **two** measured responses ($i = 1, 2$) :
Each dose-response data is fitted with the operational model :

$$y_{ij} = E_i \frac{\tau_{ij}^{n_i} [L]^{n_i}}{([L] + Ka_{ij})^{n_i} + \tau_{ij}^{n_i} [L]^{n_i}}$$

For a given response i , we calculate
 $\Delta_i \log(\tau/Ka) = \log(\tau_{i2}/Ka_{i2}) - \log(\tau_{i1}/Ka_{i1})$.

The **Bias** is then defined by

$$\Delta\Delta \log(\tau/Ka) = \Delta_2 \log(\tau/Ka) - \Delta_1 \log(\tau/Ka)$$

Statistical consideration : parameter confidence interval and (un-)identifiability

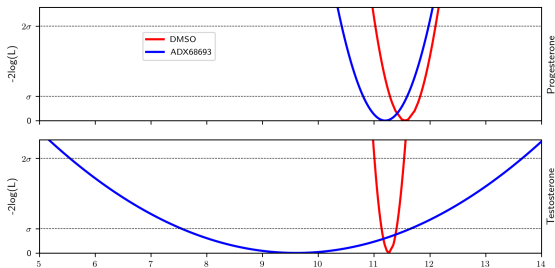
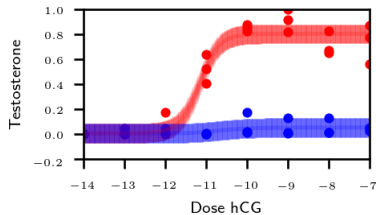
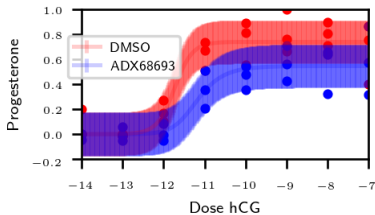

Some examples

Bias quantification - standard method : operational model

Time-dependent bias

Biased quantification using dynamical model

Time-dependent bias ?

The role of kinetic context in apparent biased agonism at GPCRs

Carmen Klein Herenbrink¹, David A. Sykes², Prashant Donthamsetti^{3,4}, Meritxell Canals¹, Thomas Coudrat¹, Jeremy Shonberg⁵, Peter J. Scammells⁵, Ben Capuano⁵, Patrick M. Sexton¹, Steven J. Charlton², Jonathan A. Javitch^{3,4,6}, Arthur Christopoulos¹ & J Robert Lane¹

- Bias value may change according to the response time after stimulation.
- Kinetic explanation : Ligands with a slow binding kinetics may have changing bias value according to time.



Klein Herenbrink et al., *Nat. Commun* (2016)

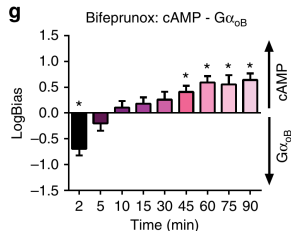
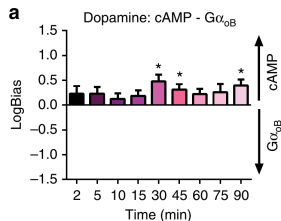

Time-dependent bias ?

The role of kinetic context in apparent biased agonism at GPCRs

Carmen Klein Herenbrink¹, David A. Sykes², Prashant Donthamsetti^{3,4}, Meritxell Canals¹, Thomas Coudrat¹, Jeremy Shonberg⁵, Peter J. Scammells⁵, Ben Capuano⁵, Patrick M. Sexton¹, Steven J. Charlton², Jonathan A. Javitch^{3,4,6}, Arthur Christopoulos¹ & J Robert Lane¹

- Bias value may change according to the response time after stimulation.
 - Kinetic explanation : Ligands with a slow binding kinetics may have changing bias value according to time.
- ⇒ **We need to take into account dynamic patterns in bias quantification**

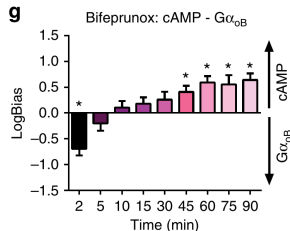
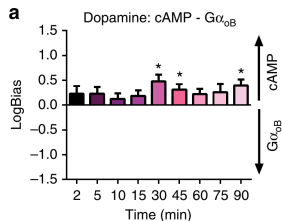

Physiological role of a kinetic profile (PTHR)

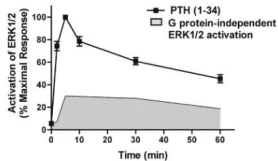
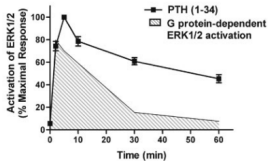

Gesty-Palmer et al., *J. Biol. Chem* (2006)

The mitogen-activated protein kinase ERK activation profile is the sum of two different activation pathways (G vs β -arrestin dependent), linked to two different spatial distribution of activated ERK (nucleus vs cytoplasm).

The balance of activation of the two pathways controls cell fate outcome.

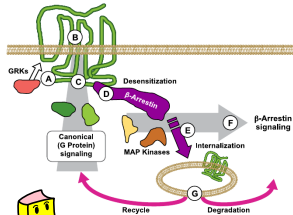

Kenakin, *Chem Rev* (2017)

Physiological role of a kinetic profile (PTHR)

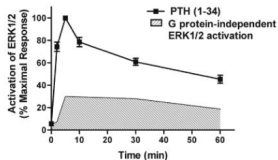
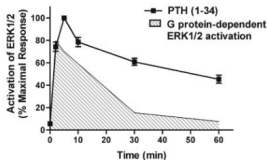

Gesty-Palmer et al., *J. Biol. Chem* (2006)

The mitogen-activated protein kinase ERK activation profile is the sum of two different activation pathways (G vs β -arrestin dependent), linked to two different spatial distribution of activated ERK (nucleus vs cytoplasm).

The balance of activation of the two pathways is finely controlled by G protein coupled receptors kinases.

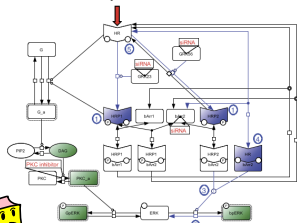

Heitzler et al., *Mol. Sys. Biol.* (2012)

Physiological role of a kinetic profile (PTHR)

Short and Long acting Ligands activates the same secondary effector molecules (cAMP) through different mechanisms, and lead to different physiological responses.

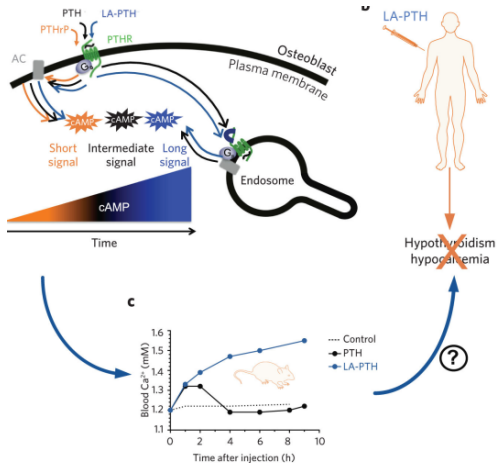

Outline

Some examples

Bias quantification - standard method : operational model

Time-dependent bias

Biased quantification using dynamical model

How to quantify dynamic bias?

- Ligand-specific modification of the energetic landscape controls signaling bias

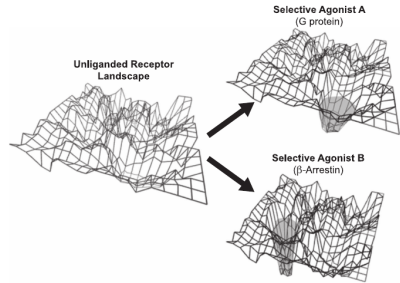

Kenakin, *J Pharmacol Exp Ther* (2011)

How to quantify dynamic bias?

- Ligand-specific modification of the energetic landscape controls signaling bias
- However this information is barely accessible.

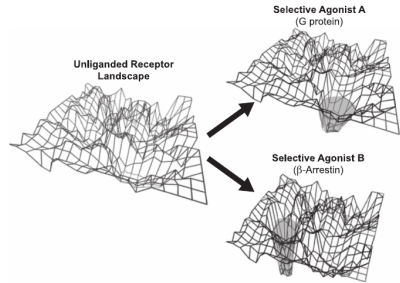

Kenakin, *J Pharmacol Exp Ther* (2011)

How to quantify dynamic bias?

- Ligand-specific modification of the energetic landscape controls signaling bias
- But we have access to the kinetic profile of receptor downstream signaling

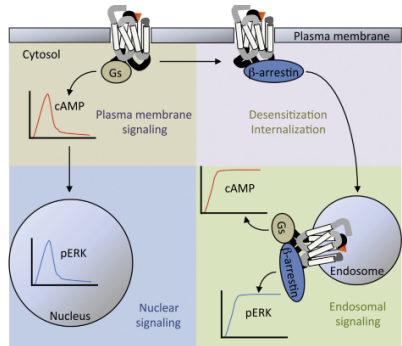

Poupon and Reiter, *Cell. Endocrin. in Health and Disease*. (2014)

How to quantify dynamic bias?

- Ligand-specific modification of the energetic landscape controls signaling bias
 - But we have access to the kinetic profile of receptor downstream signaling
- Dynamic modeling.

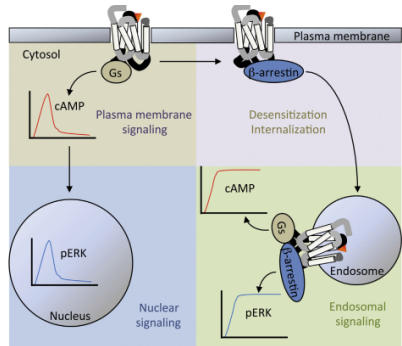

Poupon and Reiter, *Cell. Endocrin. in Health and Disease*. (2014)

Dynamic data (on FHSR in HEK cells)

Instead of focusing on dose-response curves, we deal with **kinetic data** performed at several doses (here : induced BRET data)

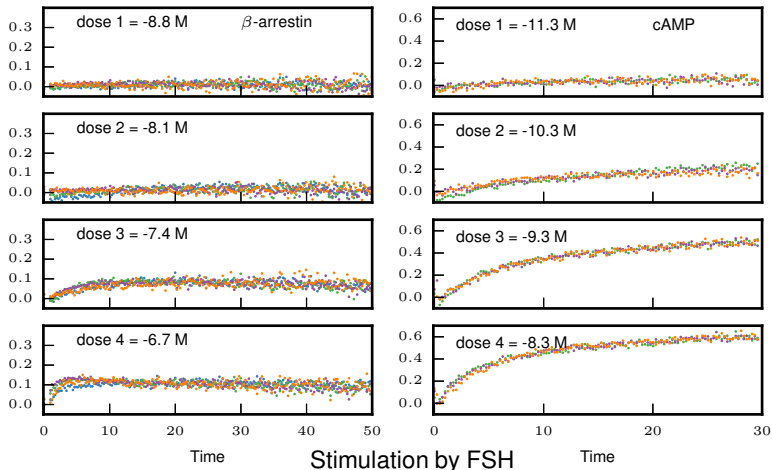

Dynamic data (on FHSR in HEK cells)

Instead of focusing on dose-response curves, we deal with **kinetic data** performed at several doses (here : induced BRET data)

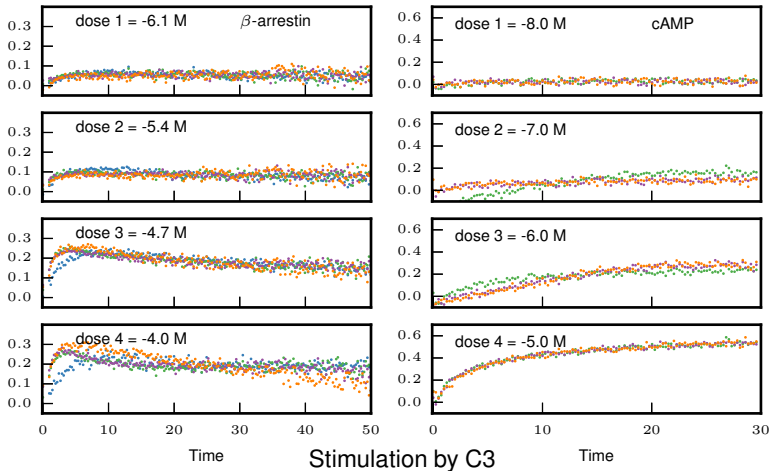

Principle of the methodology

I) We use chemical reaction network and ODE modeling (based on mass action law) to generate time series

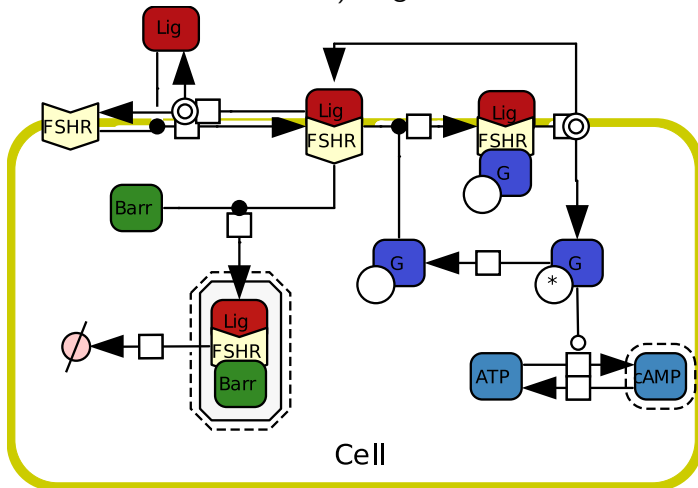

Principle of the methodology

I) We verify the network is able to accurately fit the data (one **separate fit** for each Ligand)

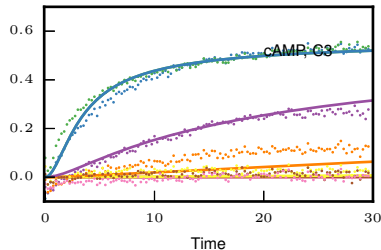
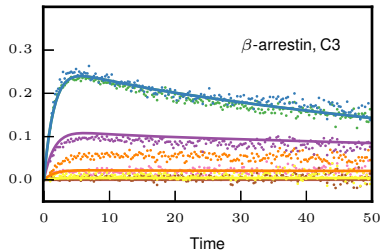
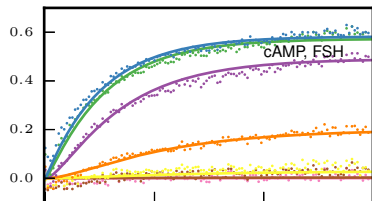
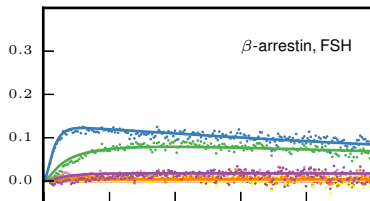

Principle of the methodology

II) We fit **all data at once**, using some **common** parameters (initial concentration of molecules, measurement parameters...) and some **different** ones (kinetic parameters...)

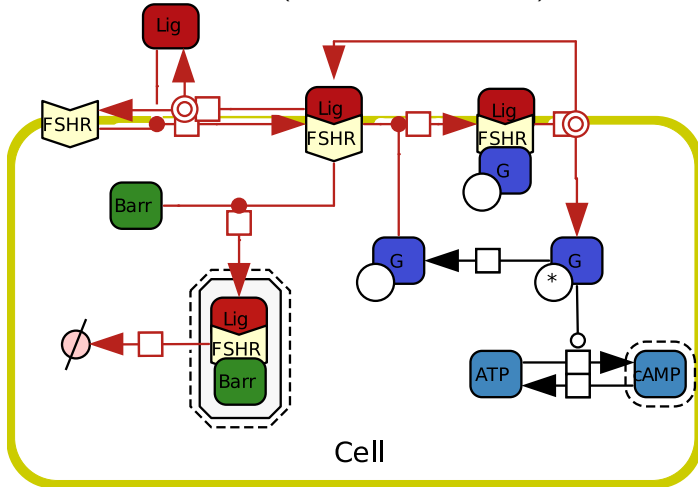

Principle of the methodology

II) We fit **all data at once**, using some **common** parameters (initial concentration of molecules, measurement parameters...) and some **different** ones (kinetic parameters...)

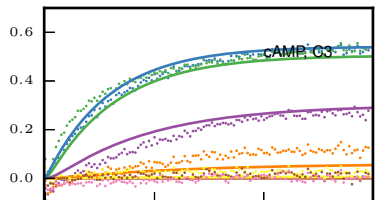
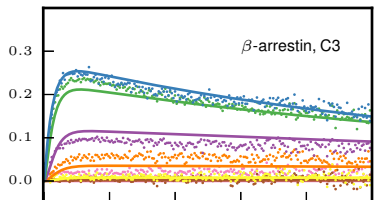
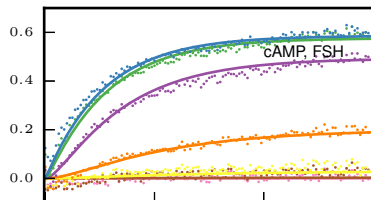
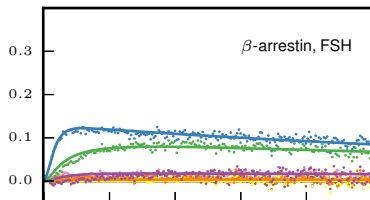

Time

Time

Principle of the methodology

III) We use L^1 -penalization to find **ligand specific parameters**

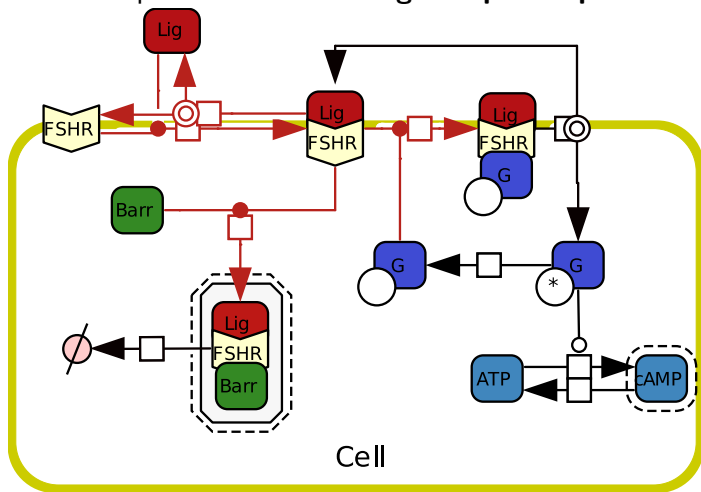

Data2Dynamics : Steiert, Timmer and Kreutz, *Bioinformatics* (2016)

Principle of the methodology

III) We use L^1 -penalization to find **ligand specific parameters**, keeping the fit 'as good as before'

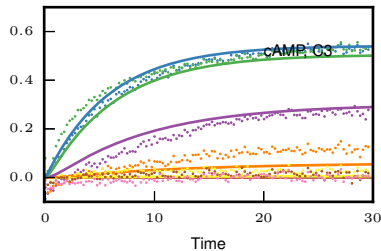
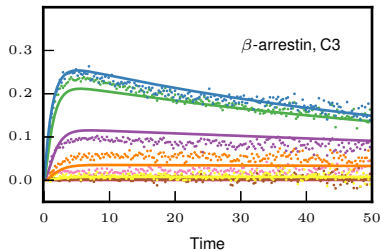
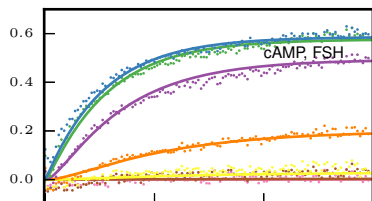
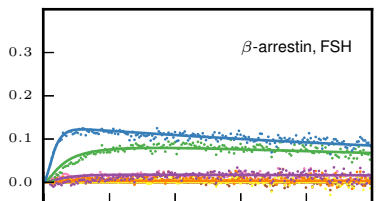

Principle of the methodology

IV) After re-optimization, the set of distinct (ligand-specific) kinetic parameters gives us an accurate description of ligand specificity.

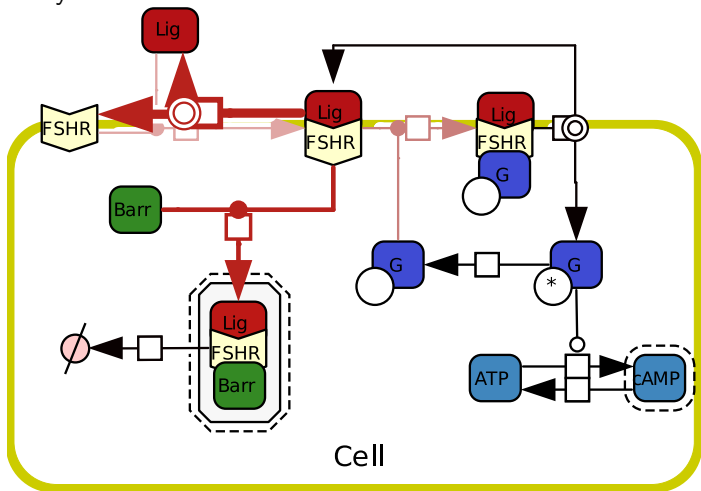

Principle of the methodology

V) Significant differences between parameters is assessed by statistical methods (Profile Likelihood)

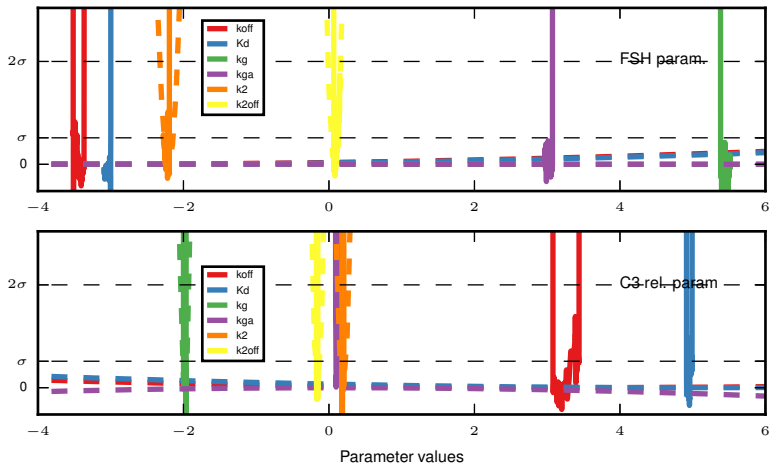

→ **here** : C3 is biased towards β -arr, compared to cAMP, in comparison to FSH

Practical problems...

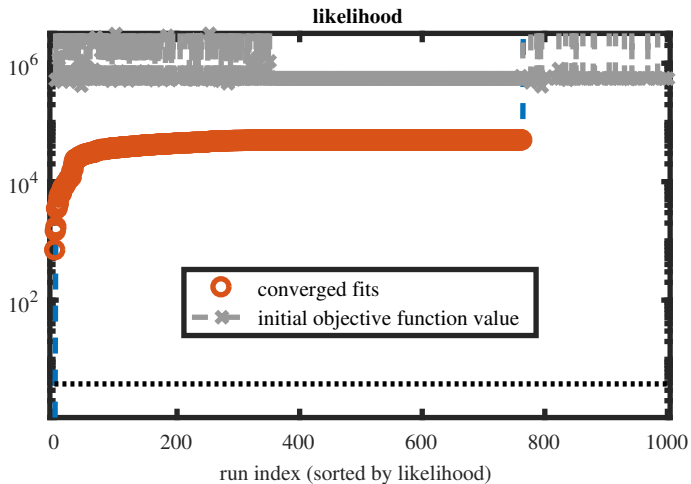

Practical problems...

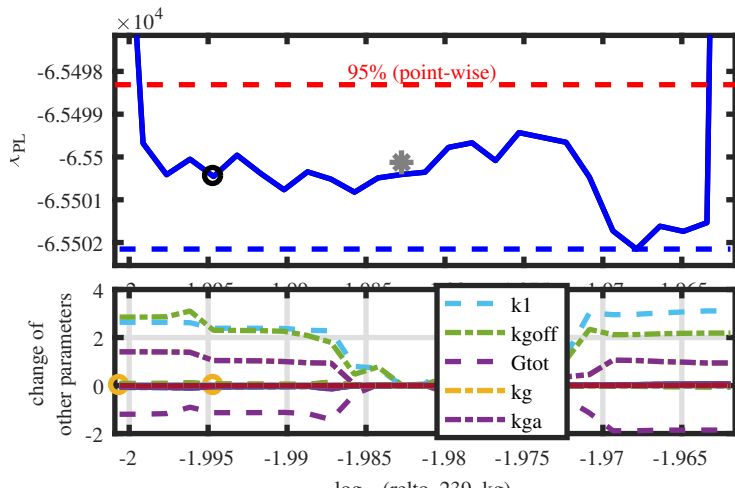

With a "simpler" model

Kinetic model without G-protein

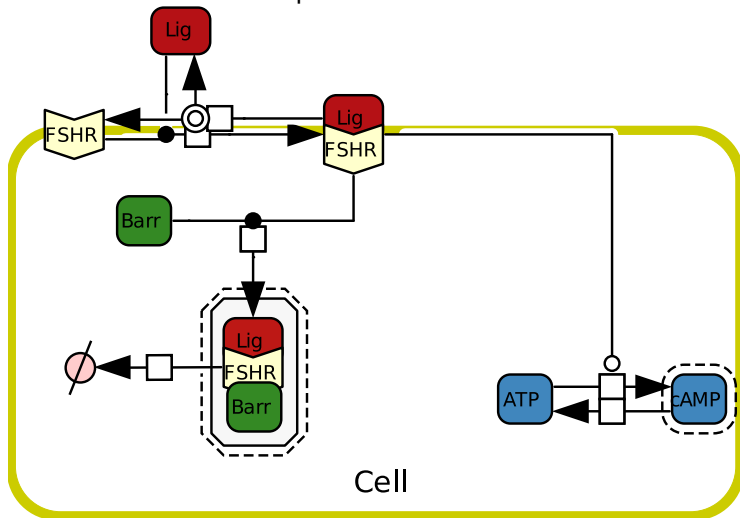

With a "simpler" model

We obtain a slightly worse fit

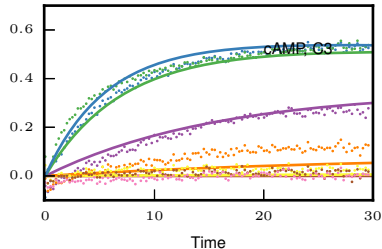
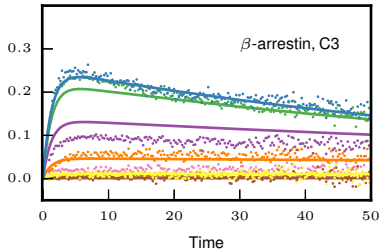
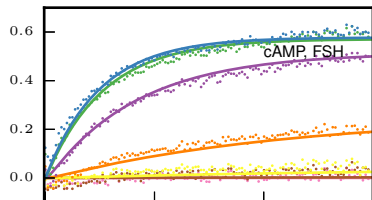
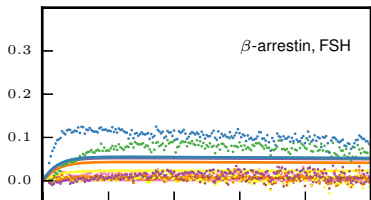

With a "simpler" model

But consistent results

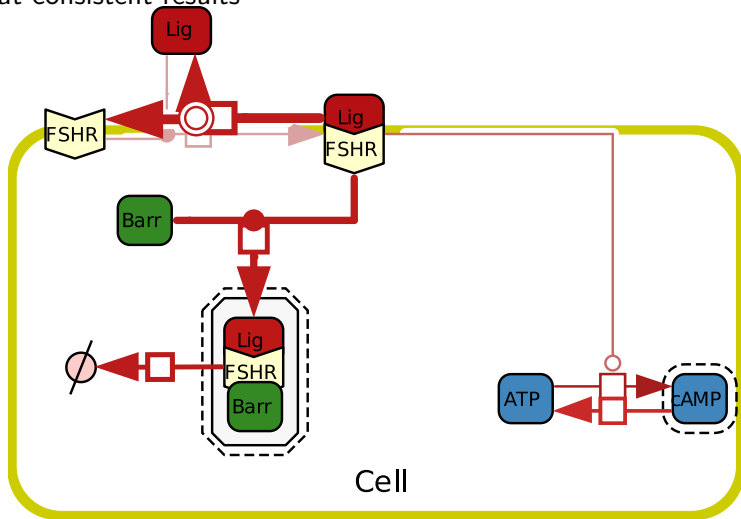

With a "simpler" model

And "better" parameter identifiability

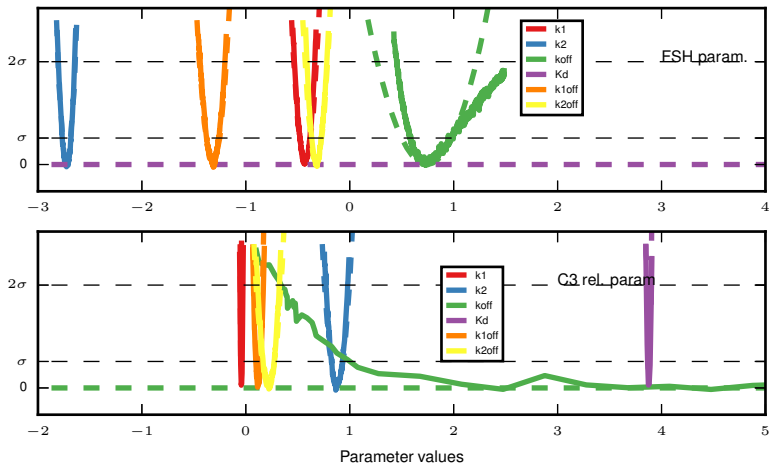

C3 is biased towards β -arr, compared to cAMP, in comparison to FSH.

With a "simpler" model

And "better" convergence curves

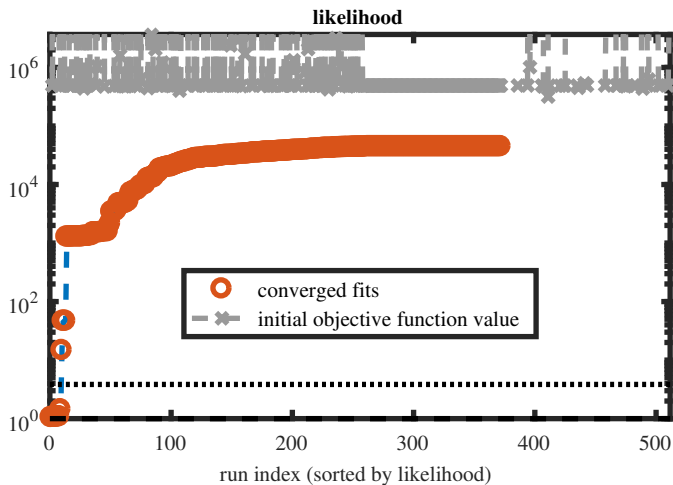

Summary

- Notion of signaling bias to quantify differential activation of several pathways by a Ligand at a given receptor.
- Standard quantification has several drawbacks (no time, limited to sigmoid scenario, et).
- We gave a kinetic interpretation of Ligand biased, which rely on kinetic data and dynamic (ODE) modeling, with numerical parameter estimation and L^1 penalization to reduce combinatorial complexity.

Summary

- Notion of signaling bias to quantify differential activation of several pathways by a Ligand at a given receptor.
 - Standard quantification has several drawbacks (no time, limited to sigmoid scenario, et).
 - We gave a kinetic interpretation of Ligand biased, which rely on kinetic data and dynamic (ODE) modeling, with numerical parameter estimation and L^1 penalization to reduce combinatorial complexity.
- ⇒ How to deal with "fuzzy/noisy" PLE ?
- ⇒ How to deal with non uniqueness of optimal parameters ?
- ⇒ How to perform a model reduction that would lead to both a satisfactory fit and identifiable parameters ?

Thanks for your attention !

Bios Team, PRC, INRAE (Tours, Fr)

- ★ Eric Reiter
- ★ Pascale Crépieux
- ★ Anne Poupon
- ★ Frédéric Jean-Alphonse
- ★ Francesco De Pascali



United Arab Emirates University

- ★ Mohammed Ayoub



M. Ayoub et al., *Molecular and Cellular Endocrinology* 436 (2016)



L. Riccetti et al., *Scientific Reports* 7 :940 (2017)



R.Y. et al., *Methods in Molecular Biology*, in press (2018)

Comparison with dose-response (on FHSR in HEK cells)

We systematically calculate bias value using standard method
(operational model on dose-response curves :)

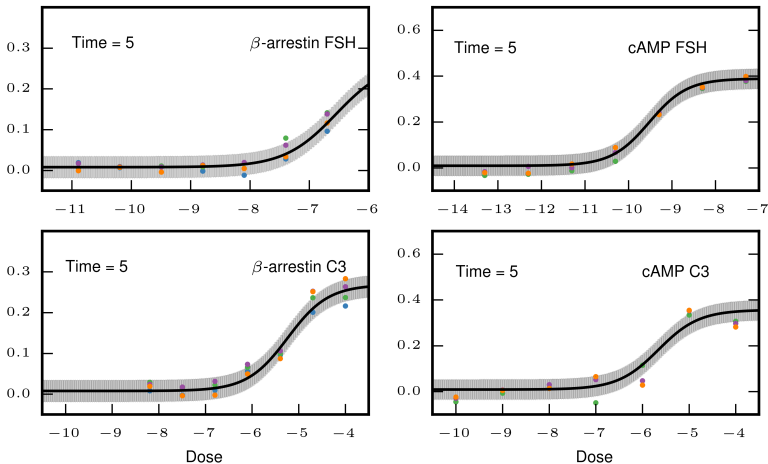

Bias=2.3 : C3 is biased towards β -arr, compared to cAMP, in comparison to FSH.

Comparison with dose-response (on FHSR in HEK cells)

We systematically calculate bias value using standard method
(operational model on dose-response curves :)

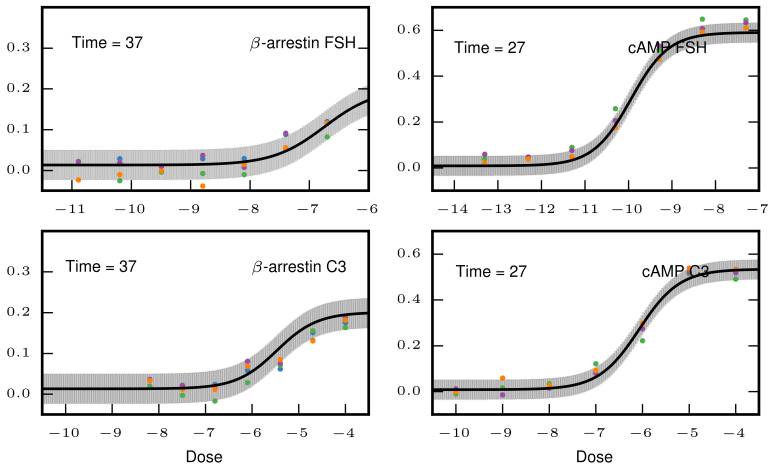

Bias=2.64 : C3 is biased towards β -arr, compared to cAMP, in comparison to FSH.

Comparison with dose-response (on FHSR in HEK cells)

We systematically calculate bias value using standard method
Different times gives (slightly) different bias values

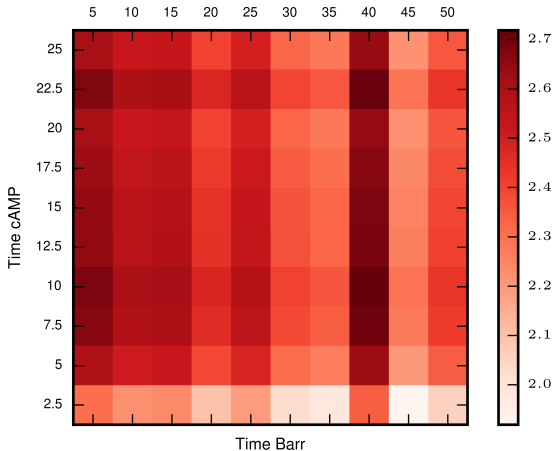

C3 is biased towards β -arr, compared to cAMP, in comparison to FSH.

Comparison with dose-response (on FHSR in HEK cells)

We systematically calculate bias value using standard method

Uncertainty can be large according to the time of measurement

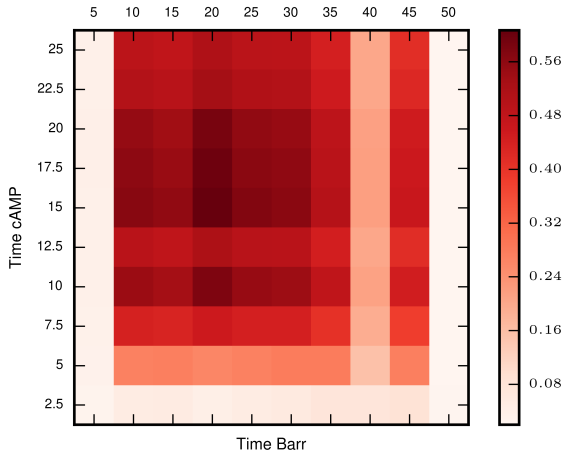

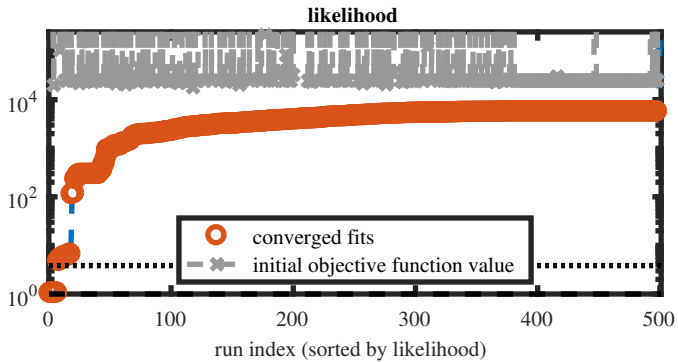

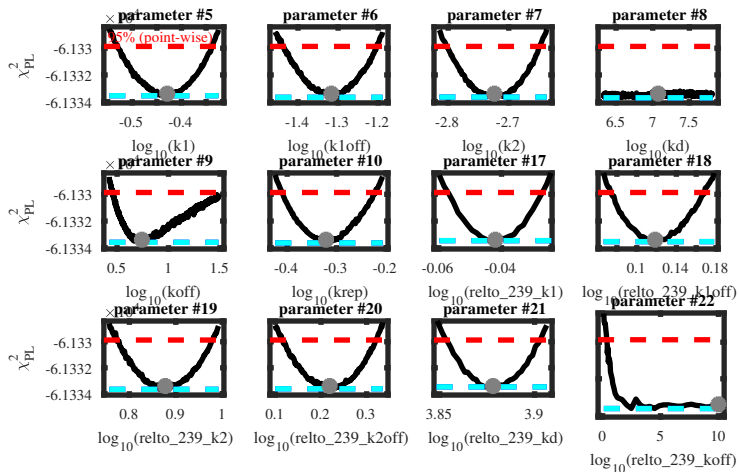

("trick" to minimize variance...)

Original "raw" data

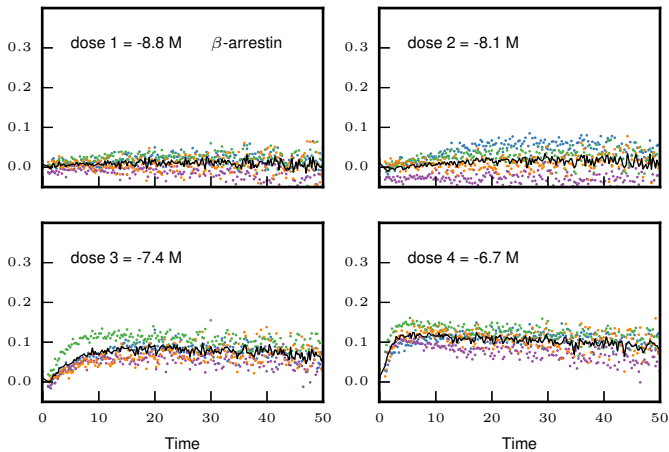

("trick" to minimize variance...)

"Adjusted" data

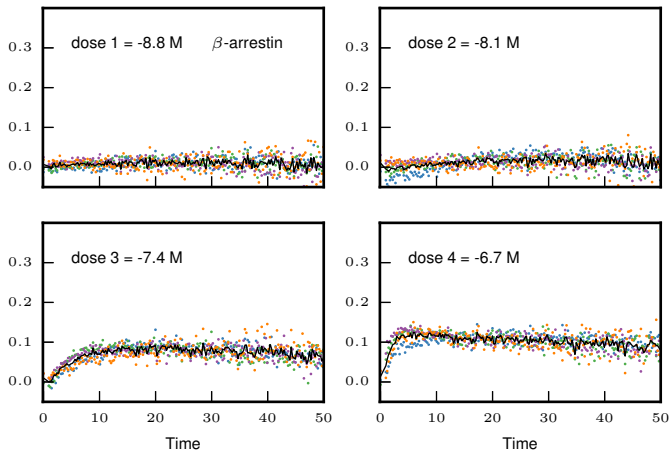

("trick" to minimize variance...)

"Adjusted" data

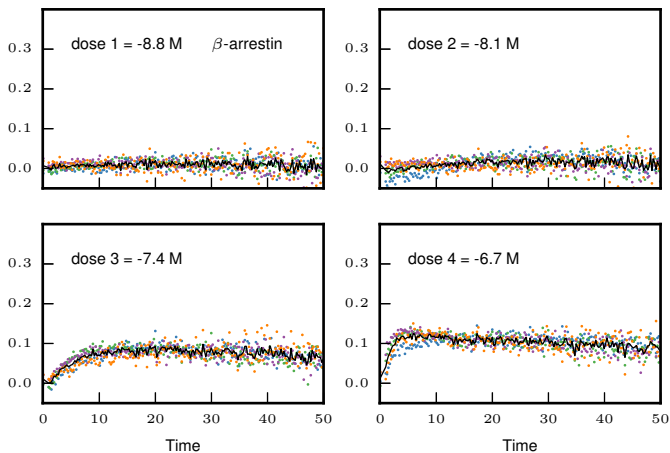

+ adjusting the number of data points ...

Other extensions

Dose-dependent bias



Barak and Peterson et al.,
Biochem. (2012)

Extension of the operational
model



Kenakin, *Chem. Rev.* (2017)

Method based on Intrinsic
activities and rank ordering



Onaran et al., *Sci. Rep.*
(2017)

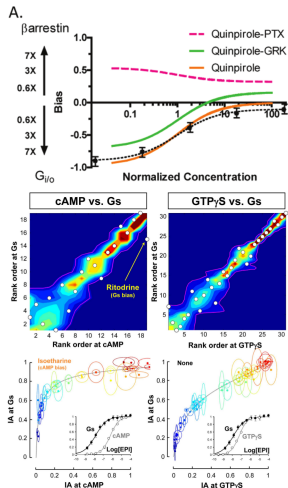

Is bias calculation intuitive? (simulated data)

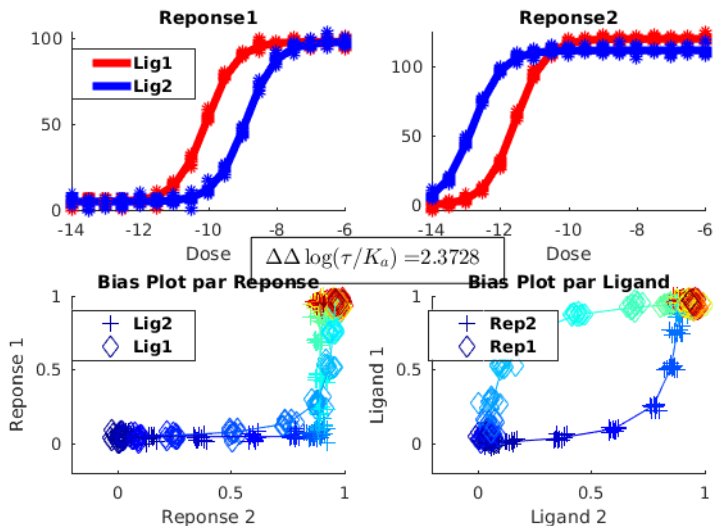

A strong bias is usually 'apparent' on dose-response curves or bias plot

Is bias calculation intuitive? (simulated data)

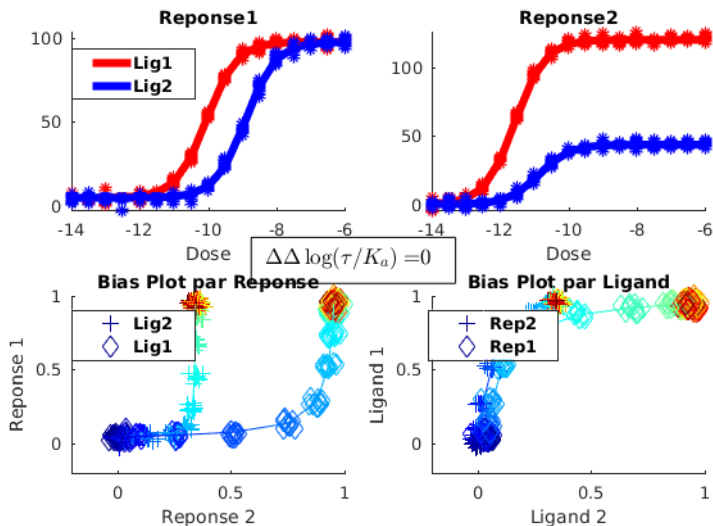

But there may be counter-intuitive situation...

Is bias calculation intuitive? (simulated data)

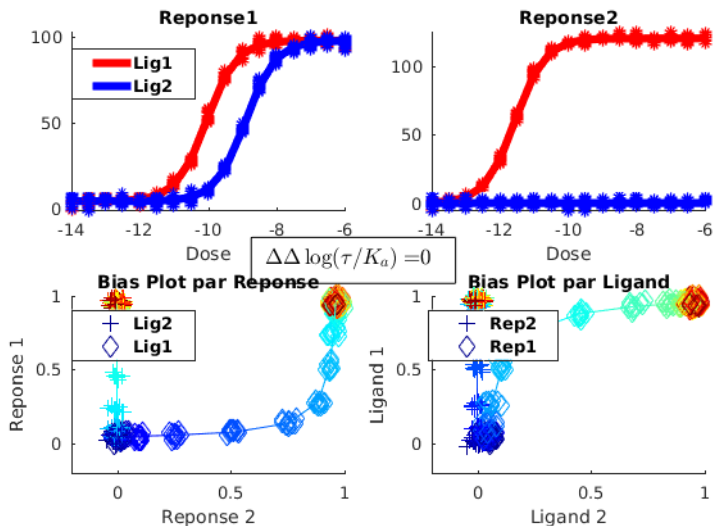

But there may be counter-intuitive situation...

Is bias calculation intuitive? (simulated data)

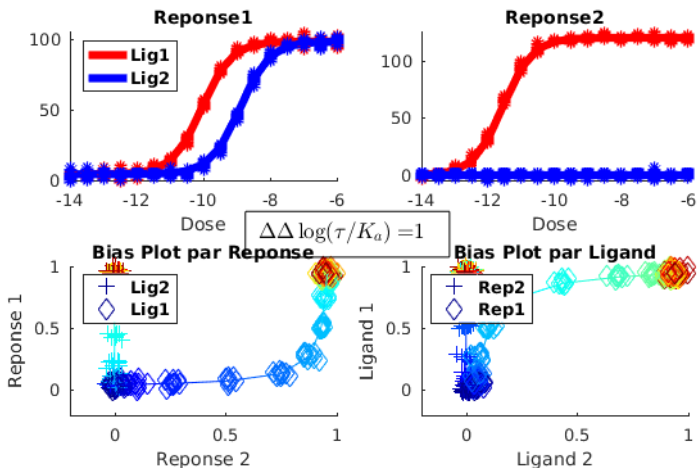

But there may be counter-intuitive situation...

... and those situations occur in real life!

