



HAL
open science

A modelling framework for energy system planning: Application to CHP plants participating in the electricity market

Lise Mallier, Gilles Hetreux, Raphaële Théry Hétreux, Philippe Baudet

► To cite this version:

Lise Mallier, Gilles Hetreux, Raphaële Théry Hétreux, Philippe Baudet. A modelling framework for energy system planning: Application to CHP plants participating in the electricity market. *Energy*, 2021, 214, pp.118976. <10.1016/j.energy.2020.118976>. <hal-03110110>

HAL Id: hal-03110110

<https://hal.science/hal-03110110v1>

Submitted on 14 Jan 2021

HAL is a multi-disciplinary open access archive for the deposit and dissemination of scientific research documents, whether they are published or not. The documents may come from teaching and research institutions in France or abroad, or from public or private research centers.

L'archive ouverte pluridisciplinaire **HAL**, est destinée au dépôt et à la diffusion de documents scientifiques de niveau recherche, publiés ou non, émanant des établissements d'enseignement et de recherche français ou étrangers, des laboratoires publics ou privés.



HAL Authorization





Open Archive Toulouse Archive Ouverte (OATAO)

OATAO is an open access repository that collects the work of Toulouse researchers and makes it freely available over the web where possible

This is an author's version published in: <http://oatao.univ-toulouse.fr/27126>

Official URL: <https://doi.org/10.1016/j.energy.2020.118976>

To cite this version:

Mallier, Lise  and Hétreux, Gilles  and They, Raphaëlle  and Baudet, Philippe
A modelling framework for energy system planning: Application to CHP plants participating in the electricity market. (2021) Energy, 214. 118976. ISSN 0360-5442

Any correspondence concerning this service should be sent to the repository administrator: tech-oatao@listes-diff.inp-toulouse.fr

A modelling framework for energy system planning: Application to CHP plants participating in the electricity market

Lise Mallier ^{a,*}, Gilles Hétreux ^a, Raphaelae Thery-Hétreux ^a, Philippe Baudet ^b

^a Laboratoire de Génie Chimique (LGC), Université de Toulouse, CNRS, INPT, UPS, Toulouse, France

^b Proesis SAS, 42 Avenue Du Général de Croutte, Toulouse, France

ARTICLE INFO

Keywords:

Modelling framework
Fast prototyping
Short-term planning
Energy management system
Mixed integer linear programming
Combined heat and power plants

ABSTRACT

This article presents a general modelling framework dedicated to the short term planning of energy systems, which supports the fast prototyping of optimization models. Due to the need for its applicability to practical problem instances, the methodology is based on a generic *Mixed Integer Linear Programming* (MILP) formulation. In addition, a specific graphical formalism called *Extended Resource Task Network* (ERTN) is proposed for the configuration step, which enables the modelling of any type of system and the automatic instantiation of the optimization models. The value of implementing such a tool is demonstrated through the modelling, operational planning and performance evaluation of a *Combined Heat and Power* (CHP) plant that participates in the French Day ahead electricity market. Indeed, while real time control of utility plants plays an important role in ensuring the balance between production and needs, forecasting and planning these production systems is becoming increasingly necessary to make them more energy and economically efficient. The case study shows, on the one hand the potentialities of the modelling approach through the ability to achieve rapid development and implementation of complex systems, and on the other hand significant opportunities to improve the site's economic profitability as well as its environmental impact.

1. Introduction

Within the framework of the Paris Agreement, OECD member countries have announced a series of national energy transition plans aimed at developing clean energy production and reducing demand through more efficient energy use [1]. Representing 22% of energy consumption in OECD countries, the industrial sector has a real role to play in this field [2]. In France, recent studies [3] have shown that the production of utilities (electricity, steam at various pressure levels, hot/cold water ...) corresponds to nearly a third of the energy consumed. Produced mainly by in situ power plants, it generates relatively high energy costs that directly impact production costs and reduce margins. In a highly competitive context, the management of utility plants has become considerably more complex due to the need of flexibility, an uncertain economic environment, stricter environmental legislation and the liberalization of the energy market. In order to operate these installations, softwares known as *Energy Management Systems* (EMS)

are generally implemented. Such systems are based on an analysis of data from the installation via the industrial site's instrumentation, as well as data that affect their activities (market data, weather, etc.) to provide operators with recommendations and enable them to manage the energy of industrial units (Fig. 1). Currently, most EMS on the market mainly offer real time monitoring functions of energy flows and data visualization through dashboards. While this is a first step towards greater energy efficiency, these services may appear insufficient in these new operating situations. In order to be energy efficient and to make the most of the various opportunities for recovery (sale of the electricity produced for example), it is necessary to be able to forecast and plan the production of utility plants, taking into account all operational and environmental constraints as well as economic criteria. This leads to the resolution of real optimization problems that can be difficult to grasp without specialized tools. These difficulties are even more noticeable when utility plants include *Combined Heat and Power* (CHP) units.

Whatever the layout and the units included in the utility plant, a model that describes the system is needed to formulate the optimization problem. For this purpose [4], indicates that authors

* Corresponding author.

E-mail address: lise.mallier@toulouse-inp.fr (L. Mallier).

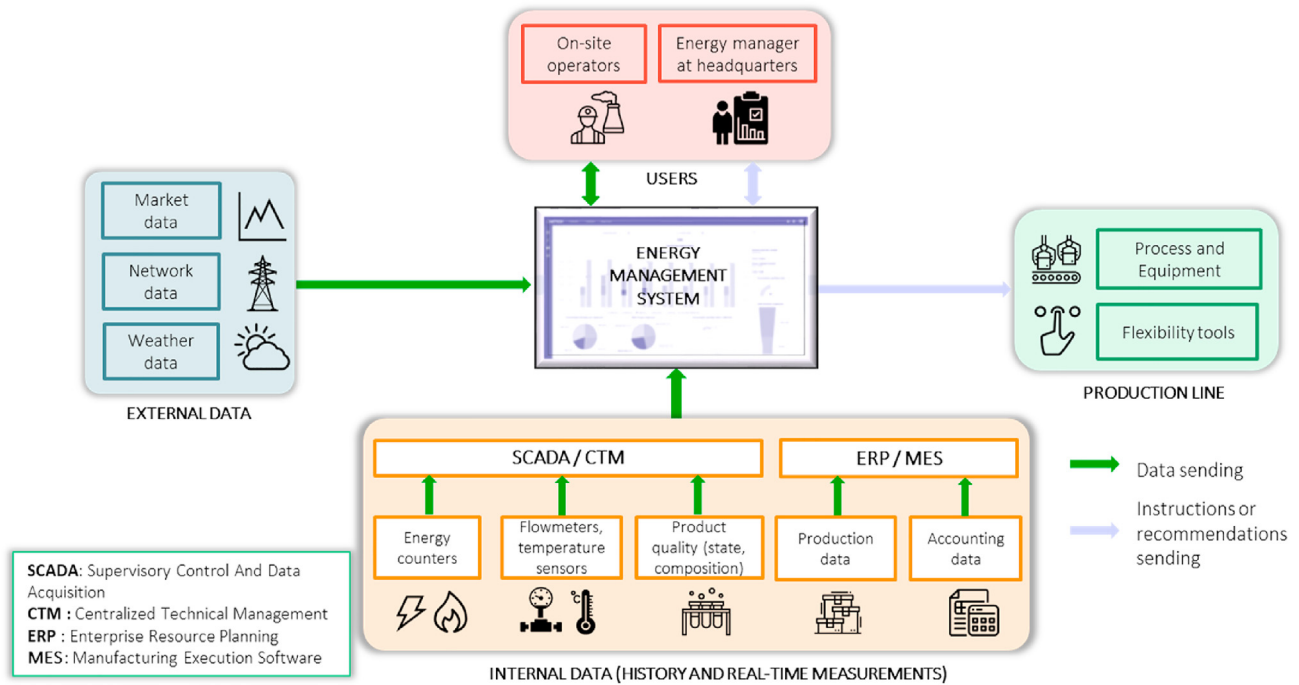

Fig. 1. Data flow in an EMS.

generally use two basic approaches for system modelling:

- either *black box approaches* using data interpolation [5] or defining operating regions of whole plants [6] or of individual components,
- or *first principles approaches* employing balance equations [7–9]. Here, mathematical programming methods are the most widely used. The main advantage of the approach is its generalization capability. It can therefore be used even when historical data are not available or incomplete and it can offer solutions that were not considered before.

In recent literature, optimal planning problems are formulated using linear or non linear mixed integer models and are solved by general purpose solvers (specialized software packages). On a practical view, these approaches can be criticized for the need for expertise in mathematical programming to build such models. Moreover, the optimization models proposed in the literature are rarely generic and are written for a specific field of application with different levels of precision. However, whatever the topology of the plant, the basic constraints always come down to mass flow and energy balance equations.

In order to allow a better dissemination of these techniques, the main contribution and novelty of the work presented in this paper is to propose a methodology and a modelling framework that can deal with most production systems without manipulating explicitly equations. By introducing several level of abstraction, the system can also be decomposed into a set of connected components, which is consistent with the modelling approach of object oriented technologies. Implemented through two main software components, this methodology is intended to simplify the modelling step, to handle real world instances of problem by reducing development times and to solve them in reasonable computational times. The resulting code is then integrated into a third party software application specially developed for each end customer's production unit.

The remainder of this paper is organized as follows. The main principles and challenges of the modelling framework are introduced in section 2. Section 3 presents the semantic of graphical modelling formalism named *Extended Resource Task Network* and the general underlying *Mixed Integer Linear Programming* (MILP) planning model. Section 4 describes a case study, which aims to simultaneously optimize CHP plant operations and trade in a standardized electricity market. Section 5 illustrates the use of the modelling framework and the computational results are discussed.

2. Outlines of the modelling and optimization framework

2.1. Context and challenges of the PLANENER project

The Proesis company exploits a first generation EMS software named *ARIANETM*, which is able to optimize the configuration of a utility plant in near real time, i.e. determine the production level of each equipment required to satisfy an operating scenario at a given time. However, the new technical and dynamic economic context in which energy systems are evolving requires to be able to predict and plan the production of utility plants, taking into account all the constraints mentioned above (operational, environmental, etc.). Wishing to investigate the market of new generation EMS, the LGC and Proesis have launched in partnership the *PLANENER* project. This project aims to design methodological and software components for the implementation of decision support tools whose objective is to improve the energy efficiency and economic profitability of production systems. To address these issues, several challenges have to be met. Concerning the methodological aspects:

- propose a configuration tool allowing to quickly model the flows and states of any type of production system thanks to a graphical formalism to which are associated construction rules, in order to limit the development time of third party applications delivered to the end users of the industrial sites.
- find a generic formulation for the planning model:

o adapted to the modelling formalism so as to limit as much as possible the interventions on the optimization model equations for each new system treated,
o providing reliable and viable production plans with reasonable response times,

- build a decision architecture, which permits responsiveness to the hazards of production and robust to the uncertainty of certain data (as prices not in line with forecasts, underestimated demand, etc.).

Concerning the outputs of the proposed applications, they have to:

- determine an energy optimum by integrating real and multiple production, technical and environmental constraints,
- integrate the various opportunities for electricity recovery when appropriate.

For this purpose, the new findings of these works lie in the proposal of a general modelling methodology using a formal graphical modelling language named *Extended Resource Task Network* in order to instantiate automatically a *Mixed Integer Linear Programming* planning model that is general enough to be useable for any industrial production system. The modelling formalism, the MILP model and the configuration tool described in this paper are part of the results and functionalities developed during this project.

2.2. The Extended Resource Task Network (ERTN) formalism

An ERTN model is an oriented flow graph composed of a reduced collection of semantic elements (7 types of nodes and 5 types of arcs), whose construction is based on a set of well established rules [10]. These elements make it possible to model the main characteristics of industrial processes such as material and utility flows, manufacturing procedures, resource constraints (unit topology, equipment capacity, fixed or dependent operating times, resource sharing, multimodal equipment, etc.). The *ERTN* modelling allows in particular the description of recipes and production processes, the unambiguous representation of material and energy flows as well as the representation of multimodal equipment. Table 1 summarizes all the notations associated with this formalism (column 2).

2.3. The mathematical programming model underlying the ERTN formalism

Different methods are proposed in the literature to solve scheduling problems recognized as NP complex. The quality of the plan and the computational effort are often properties for which a compromise must be found. *Mixed Integer Non Linear Programming* (MINLP) formulation have the benefit of allowing a finer representation of the system [11]. Unfortunately, no current solver for MINLP problems can handle the problems as large as this paper deals with (up to hundreds of thousands variables). For this reason, MILP approaches are widely adopted for the formulation of large optimization problem (and consequently for industrial application) and for its computational stability and convergence [12,13]. The main drawback of the MILP problem representation is the need for linear description, generally dealt with piecewise linear approximations of non linear functions. However in Ref. [14], the authors compare MILP and MINLP approaches and conclude that a MILP formulation with piecewise linearization gives a good approximation of the optimal solution while ensuring easy resolution of a large problem. In light of this analysis, the model developed in this work is based on a MILP formulation.

Various MILP formulations are proposed in the literature, mainly dependent of time representation. Globally, they can be classified into two main categories [15]. We can distinguish MILP models based on discrete time formulation (such as *Global Time Intervals*) presented in Refs. [16,17], or [18] or based on continuous time formulation (such as *Global Time Points*, *Unit specific time event*, *Time slots*, etc.) like in Ref. [19].

Approaches based on *discrete time formulation* mainly consist in dividing the time horizon into a number of periods of uniform duration. The “events” (start or end of operations) can then only occur at the limits of these periods. The advantage of this approach is that it significantly reduces the complexity of the sequencing problem since it can be solved by working only at period boundaries. On the other hand, the accuracy of the system’s representation over time depends directly on the length of the period. The shorter the duration of the period, the more accurate the model will be. In approaches based on *continuous time formulation*, the events can occur at any time on the horizon (concept of *variable event points*) is used. The advantage of this approach is that it is then only necessary to define variables and constraints on a limited number of event points, reducing a priori the complexity of the resulting model. However, the variable nature of event dates can make problem modelling more complex. Indeed, this approach can lead to the introduction of more *big M* constraints or make certain constraints non linear. Moreover, when continuous operations are mainly concerned, many intermediate balance nodes must be introduced (and not only at the beginning or end of an operation), each corresponding to as many event points. In this case, the advantage of this formulation is lost.

For all these reasons, the *MILP* models encapsulated in the *PLANENER* component are based on the *Global time intervals* formulation. Since MILP models and ERTN graphs are closely interdependent, an important point is that the constraints constituting these models are written in such a way that they can be automatically instantiated with the parameters derived from the ERTN representation. Nevertheless, any formulation that covers the *ERTN* semantics could be attached to this graphical formalism (see a continuous time *MILP* formulation in Ref. [20]).

2.4. PLANENER software components and general architecture of third party applications

From the software architecture point of view, each application built with the *PLANENER* components is structured in four layers (Fig. 2):

- *Layer 1* integrates the computation engine based on the *CPLEX* solver dedicated to the resolution of mixed integer linear programs.
- *Layer 2* manages the construction and instantiation of mathematical models and the extraction of results.
- *Layer 3* contains the routines for formatting input data, algorithms for calculating various energy and economic performance indicators, summarizing operational instructions and management recommendations to guide the operator’s decision making, and formatting the results for graphical visualization (Gantt chart, histograms, etc.).
- *Layer 4* is the external presentation layer and defines the *Graphical User Interface* (GUI) offered to the end users of the application.

As mentioned above, one of the fundamental theoretical contributions of this work relies on the use of a formal graphical representation that enables to instantiate automatically a generic MILP models, thus significantly reducing the development time of the

Table 1
Semantic elements of the ERTN formalism.

	NAME	STANDARD SYMBOL	ERTN BUILDER SYMBOL	ANNOTATIONS
1	Batch operation Node			The batch size $B_{k,t}$ is such that $V_k^{\min} \leq B_{k,t} \leq V_k^{\max}$, the processing time is p_{f_k}
2	Continuous operation Node			The flowrate size $B_{k,t}$ is such that $V_k^{\min} \leq B_{k,t} \leq V_k^{\max}$, the minimum and maximum operating times are respectively D_k^{\min} and D_k^{\max}
3	Cumulative Resource Node			The amount $S_{r,t}$ of stored resource r is such that $S_{r,t} \leq C_r^{\max}$, the initial amount is $S0_r$, the storage policy is UIS, NIS, FIS or ZW
4	Disjunctive Resource Node			Resource which can be used by only one processing task at a given time
5	Logical Resource Node			The amount $R_{r,t}$ is an integer indicating the actual state of the disjunctive resource r . It is such that $R_{r,t} \leq CL_r^{\max}$, the initial marking is $R0_r$, the storage policy is UIS, NIS, FIS or ZW
6	Provision and Demand Node			Provision and demand of cumulative resource r
7	Import and Export Node			Import and export of cumulative resource r
8	Fixed Flow arc			Cumulative resource flow governed by a conservative mass balance. $p^{\text{cons}}_{k,r}$ (resp. $p^{\text{prod}}_{k,r}$) is the fixed proportion of resource r consumed (resp. produced) with respect of $B_{k,t}$ (by default, $p^{\text{cons}}_{k,r} = 1$ (resp. $p^{\text{prod}}_{k,r} = 1$))
9	Free Flow arc			Cumulative resource flow governed by a conservative mass balance. A free proportion of resource r is consumed with respect of $B_{k,t}$
10	Production / Consumption arc			Cumulative resource flow not governed by a conservative mass balance. The produced (resp. consumed) amount of cumulative resource r by task k is $u^{\text{prod}}_{k,r} = u^{\text{prod}}_{k,r} + u^{\text{prod}}_{k,r} B_{k,t}$ (resp. $u^{\text{cons}}_{k,r} = u^{\text{cons}}_{k,r} + u^{\text{prod}}_{k,r} B_{k,t}$)
11	Use Arc			Indicates that the disjunction resource r has the capability to perform the processing task k
12	Transition Arc			Indicates an evolution of the actual state of the disjunctive resource which performs the processing task k . The integer $\alpha^{\text{in}}_{k,r} \geq 1$ (resp. $\alpha^{\text{out}}_{k,r} \geq 1$) if a transition state arc exists between state resource r and task k . 0 otherwise. By default, $\alpha^{\text{in}}_{k,r} = 1$ (resp. $\alpha^{\text{out}}_{k,r} = 1$)
13	Component			Macro-representation of a component with internal (in grey) and external (in black) ports

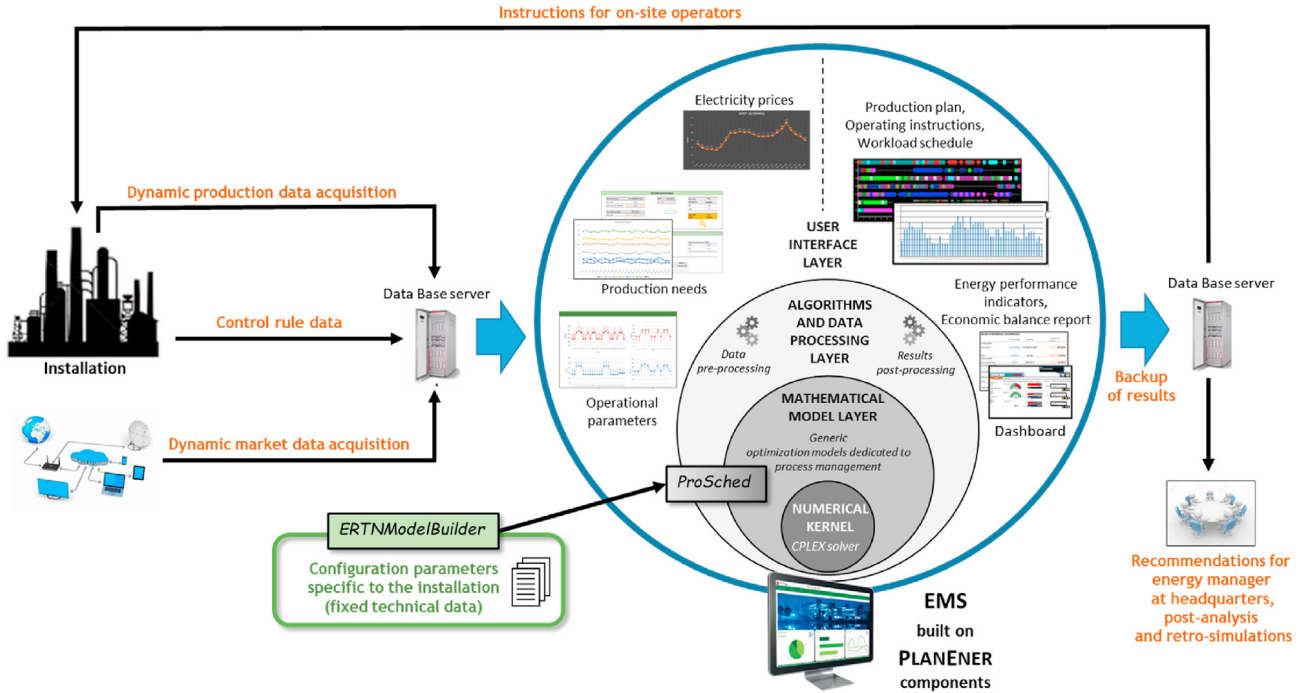

Fig. 2. Architecture and data flow of third-party applications built from PLANENER components.

process model and then, the third party applications. For this purpose, layers 2 and 3 are implemented within the PLANENER component called **ProSched**. Part of this component is instantiated by the specific configuration parameters of the studied system, which are automatically generated by the **ERTNModelBuilder** component. This configuration tool offers a *drag and drop* graphical user interface to build the ERTN model of a system using an adapted version of the symbols (see column 3 in Table 1).

2.5. Modelling steps of a production system

In order to be able to provide predictive capabilities to third party applications, a "digital twin" of the plant to be controlled has to be built beforehand. The modelling of any system takes place in four main steps described in Fig. 3:

- firstly, raw data are recovered either by on site measurements or through process simulation if some data are incomplete or missing. In this regard, process simulation software such as **ARIANE™** can be used. Several kind of technical data are thus collected. Topological or structural data (such as min/max capacities of devices, connection and material/energy flow between operations, etc) are directly translated as ERTN parameters. The other data are processed in the second step.
- the second step consists to establish the needed relationships between the physical data (such as HP steam flow vs fuel flow for example) to calculate the ERTN parameters that characterize the various operations present in the system under study. The calculation methodology is different according to the nature of the equipment (multi modal or not) and the linear or non linear nature of the operations.
- thirdly, the ERTN model of the considered system is built with the configuration tool **ERTNModelBuilder**. The ERTN diagram is assembled from generic pre built components and/or from the basic semantic elements of the ERTN formalism annotated with the parameters calculated in the previous step.

- finally, from the processing of the resulting graph, an algorithm performs the automatic extraction and generation of the parameters necessary for the instantiation of the short term planning models included in the component **ProSched**. Additional external data (such as initial stocks, demands, etc) complete the instantiation of the models before their resolution with the CPLEX solver.

3. Description of the MILP model underlying the ERTN semantic structures

The whole MILP model associated to the ERTN formalism has the ability to manage systems in which continuous and discontinuous operations, as well as continuous and discontinuous external flows (environment), coexist and interact simultaneously. Nevertheless, the rest of this paper deals only with the continuous part of these items. Beyond simplifying the presentation of the MILP model, this is also justified by the fact that the energy systems considered in the rest of the paper only contain operations of a continuous nature. As a discrete time model is implemented in PLANENER, the time horizon is therefore discretized into NP periods of uniform duration Δt . This implies that all variables are identified by a period index and time data are always equal to an integer number of periods. The complete nomenclature of parameters and decision variables of the model is provided in the supplementary materials.

3.1. Cumulative resources nodes

The **cumulative resource** nodes (Ⓢ in Table 1) represent resources that can be shared by several operations simultaneously. For example, they make it possible to model a material, a mixture of several components, a finished product, a utility in a given physical state, etc. They are characterized by a sequence number Sr (where r is the resource number), a label and three parameters: SO_r , C_r^{\max} and $Policy_r$ that specifies the transfer or storage policy, where the

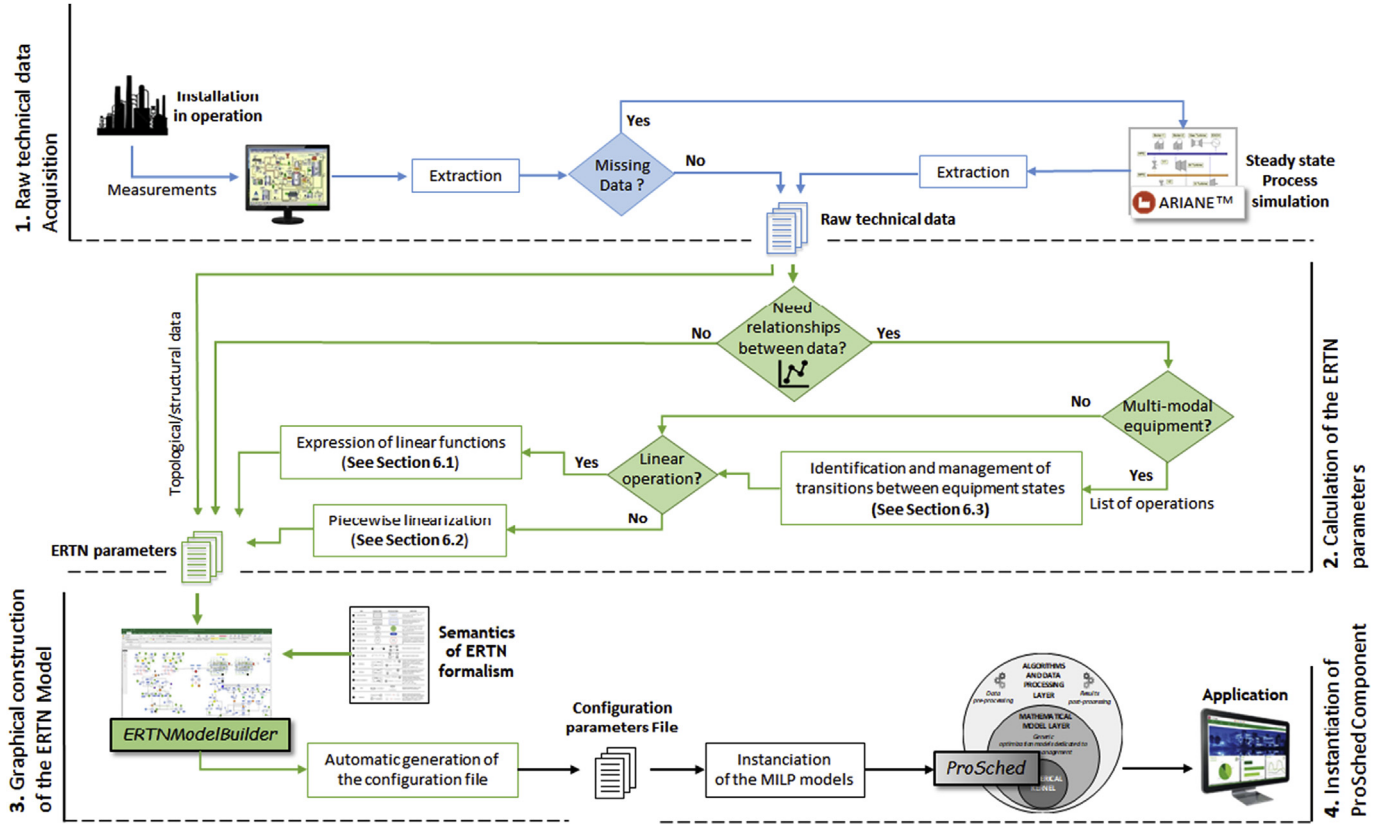

Fig. 3. Modelling steps of a production system.

alternatives are either *UIS* (Unlimited Intermediate Storage $\rightarrow C_r^{\max} = \infty$), *FIS* (Finite Intermediate Storage $\rightarrow 0 < C_r^{\max} < +\infty$) or *ZW* (Zero Wait $\rightarrow C_r^{\max} = 0$ and immediate transfer between up stream and downstream equipment).

Constraint (1) states that the amount $S_{r,t}$ of resource r in stock at the end of period t should never exceed its maximum storage capacity, while constraint (2) affects the initial amount $S_{0,r}$ to the variable $S_{r,t}$ at $t = 0$:

$$S_{r,t} \leq C_r^{\max} \quad \forall r \in R^C, \forall t \in T \quad (1)$$

$$S_{r,0} = S_{0,r} \quad \forall r \in R^C \quad (2)$$

3.2. Task nodes

Task nodes model any operation that transforms matter or energy. They are identified by a sequence number Tk (where k is the number of the task) and a label. In order to take into account its production mode, the symbolization distinguishes between **discontinuous** (⊙ in Table 1) and **continuous** (⊙ in Table 1) task nodes. In this paper, only *continuous task* nodes $k \in K^C$ are considered. During continuous operation, the equipment is traversed by a supposed continuous and constant flow of material. If the time spent in the device is negligible in relation to the duration of the period, it is assumed that the material is produced and available throughout the production operation. The associated parameters are V_k^{\min} , V_k^{\max} , D_k^{\min} and D_k^{\max} . The elementary duration of a continuous operation is always equal to the duration Δt of the period. Thus, if the effective duration D_k of a task $k \in K^C$ is such that

$D_k = n \cdot \Delta t$ with n integer and $D_k^{\min} \leq D_k \leq D_k^{\max}$, then n mass balances must be evaluated to account for “continuous” consumption and production over time. This is modelled by launching n consecutive tasks of elementary duration Δt . If task $k \in K^C$ has no minimum duration then $D_k^{\min} = 1$. If task $k \in K^C$ has no maximum time limit then $D_k^{\max} = +\infty$ (in practice, $D_k^{\max} = NP + 1$).

A continuous task is governed by four decision variables. First of all:

- let $W_{k,t}$ be a binary variable. $W_{k,t} = 1$ if a task $k \in K$ is started at period t , $W_{k,t} = 0$ otherwise.
- let $B_{k,t}$ be a real variable representing the quantity of matter processed by task $k \in K^C$ launched in period t (i.e. when $W_{k,t} = 1$).

Constraint (3) makes it possible to limit the quantity of matter treated continuously by the task $k \in K^C$ during period t . Note that the variable $B_{k,t}$ is forced to 0 when $W_{k,t} = 0$.

$$W_{k,t} \cdot V_k^{\min} \leq B_{k,t} \leq W_{k,t} \cdot V_k^{\max} \quad \forall k \in K, \forall t \in T \quad (3)$$

Two additional binary variables are required to take into account the production durations D_k^{\min} and D_k^{\max} . On the one hand, a binary variable $WD_{k,t}$ is such that $WD_{k,t} = 1$ if the continuous task $k \in K^C$ starts in period t and $WD_{k,t} = 0$ otherwise. On the other hand, a binary variable $WA_{k,t}$ is such that $WA_{k,t} = 1$ if a continuous task $k \in K^C$ ends in period t and $WA_{k,t} = 0$ otherwise. The variables $WD_{k,t}$ are governed by constraints (4) and (5) whereas variables $WA_{k,t}$ are governed by constraints (6) and (7). Constraints (4) and (6) detect a rising (for a start) or falling (for the end) edge of the variables $W_{k,t}$.

between two successive periods.

$$WD_{k,t} \geq W_{k,t} - W_{k,t-1} \quad \forall k \in K^c, \forall t \in T \quad (4)$$

$$WD_{k,t} \leq W_{k,t} \quad \forall k \in K^c, \forall t \in T \quad (5)$$

$$WA_{k,t} \geq W_{k,t} - W_{k,t+1} \quad \forall k \in K^c, \forall t \in T \quad (6)$$

$$WA_{k,t} \leq W_{k,t} \quad \forall k \in K^c, \forall t \in T \quad (7)$$

Constraint (8) ensures that any continuous task $k \in K^c$ is completed on the study horizon.

$$\sum_{t \in T} WD_{k,t} = \sum_{t \in T} WA_{k,t} \quad \forall k \in K^c \quad (8)$$

Constraints (9) and (10) make it possible to take into account the minimum production time D_k^{\min} and the maximum production time D_k^{\max} of the continuous task $k \in K^c$ respectively.

$$\sum_{p=t}^{t+D_k^{\min}-1} W_{k,p} \geq D_k^{\min} \quad M \cdot (1 - WD_{k,t}) \quad \forall k \in K^c, \forall t \in T \quad (9)$$

$$\sum_{p=t-D_k^{\max}}^t W_{k,p} \leq D_k^{\max} \quad \forall k \in K^c, \forall t \in T \quad D_k^{\max}, \dots, NP \quad (10)$$

3.3. Flow arcs

Any task $k \in K$ can produce or consume one or more cumulative resources r . The quantities of resources r passing through a task can either be governed by a mass balance equation for conserving flows between inputs and outputs, or not subject to such a conservation balance.

3.3.1. Flow arcs subject to a conservation balance with fixed or free ratio

Let $C_{r,k,t}$ be the amount of resource r consumed by task k during period t and $P_{r,k,t}$, the amount of resource r produced by task k during period t .

Based on Fig. 4, the conservation balance on the inlet (resp. outlet) flows in task k induces the constraint (11) (resp. constraint (12)).

$$B_{k,t} = \sum_{r \in R_k^{\text{cons}}} C_{r,k,t} \quad \forall k \in K, \forall t \in T \quad (11)$$

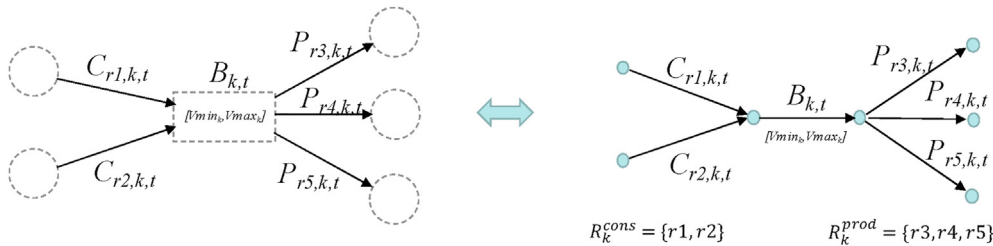

Fig. 4. Flow graph associated with conservation balances on tasks.

$$B_{k,t} = \sum_{r \in R_k^{\text{prod}}} P_{r,k,t} \quad \forall k \in K, \forall t \in T \quad (12)$$

The evaluation of flows $C_{r,k,t}$ and $P_{r,k,t}$ depends on the nature of the arcs linking the resource r and the task k . When a *fixed proportion flow arc* (Ⓢ in Table 1) links a resource r and a task k , then the flow $C_{r,k,t}$ (resp. $P_{r,k,t}$) is equal to the proportion $\rho_{r,k}^{\text{cons}}$ (resp. $\rho_{r,k}^{\text{prod}}$) of flow $B_{k,t}$ through the task k , that is $C_{r,k,t} = \rho_{r,k}^{\text{cons}} \cdot B_{k,t}$ (resp. $P_{r,k,t} = \rho_{r,k}^{\text{prod}} \cdot B_{k,t}$).

When a *free proportion flow arc* (Ⓣ in Table 1) links a resource r and a task k , then the flow $C_{r,k,t}$ (resp. $P_{r,k,t}$) represents an unfixed part of the flow $B_{k,t}$ through the task k , such that $C_{r,k,t} \leq B_{k,t}$ and $P_{r,k,t} \leq B_{k,t}$. In this case, the flows $C_{r,k,t}$ and $P_{r,k,t}$ are calculated when the optimization problem is solved and are limited respectively via constraints (11) and (12). The *free proportion inlet* (resp. *outlet*) flow arcs are characterized by the parameters $\mu_{r,k}^{\text{cons}}$ (resp. $\mu_{r,k}^{\text{prod}}$) whose value equal to 1 indicates the presence of the arc and a 0, its absence.

Constraints (13) and (14) (resp. constraints (15) and (16)) allow to calculate the flows generated (resp. consumed) by a task, whatever the nature of the flow arcs:

$$P_{r,k,t} \leq (\rho_{r,k}^{\text{prod}} + \mu_{r,k}^{\text{prod}}) \cdot B_{k,t} \quad \forall k \in K, \forall r \in R^C, \forall t \in T \quad (13)$$

$$P_{r,k,t} \geq \rho_{r,k}^{\text{prod}} \cdot B_{k,t} \quad \forall k \in K, \forall r \in R^C, \forall t \in T \quad (14)$$

$$C_{r,k,t} \leq (\rho_{r,k}^{\text{cons}} + \mu_{r,k}^{\text{cons}}) \cdot B_{k,t} \quad \forall k \in K, \forall r \in R^C, \forall t \in T \quad (15)$$

$$C_{r,k,t} \geq \rho_{r,k}^{\text{cons}} \cdot B_{k,t} \quad \forall k \in K, \forall r \in R^C, \forall t \in T \quad (16)$$

3.3.2. Flow arcs not subject to a conservation balance

This kind of flow arcs also known as *Production/Consumption arcs* (Ⓢ in Table 1) allow the consumption or production of a cumulative resource r to be defined independently of other resources r' consumed or produced by this task. The flows carried by these arcs comprise a constant term and a variable part proportional to flow rate passing through the task k . For this reason, these arcs are annotated by two parameters, $u_{k,r}^{\text{cons}}$ (resp. $u_{k,r}^{\text{prod}}$) for the constant part, and $uv_{k,r}^{\text{cons}}$ (resp. $uv_{k,r}^{\text{prod}}$) for the variable part of the consumption (resp. production) of resource r by task k .

Let variable $UC_{r,k,t}$ (resp. variable $UP_{r,k,t}$) be the amount of cumulative resource r consumed (resp. produced) by task k during period t . This flow is quantified by the constraint (17) (resp. constraint (18)).

$$UC_{r,k,t} \quad uf_{k,r}^{cons} W_{k,t} + uv_{k,r}^{cons} B_{k,t} \quad \forall r \in R^C, \forall k \in K, \forall t \in T \quad (17)$$

$$UP_{r,k,t} \quad uf_{k,r}^{prod} W_{k,t} + uv_{k,r}^{prod} B_{k,t} \quad \forall r \in R^C, \forall k \in K, \forall t \in T \quad (18)$$

3.4. Disjunctive resource node and disjunction arc

A **disjunctive resource** node (④ in Table 1) represents a resource that, at any given time, can only be used to perform one and only one task, such as a device, operator, etc. A **disjunction** arc (⊕ in Table 1) allows to model the mutual exclusion mechanism. Thus, the *disjunctive resource* at the origin of the arc can execute the operation pointed by the arc and induces an exclusive use of the resource. Each structure including a *disjunctive resource* arc leads to the formulation of an allocation constraint. At a given time period t , a disjunctive resource m ($m \in R^D$), such as processing equipment, can at most initiate one operation k ($k \in K_m$). Furthermore, this equipment m can not execute another task k' ($k' \in K_m$) during the duration of task k . The allocation constraint (19) is as follows:

$$\sum_{k \in K_m} W_{k,t} \leq 1 \quad \forall m \in R^D, \forall t \in T \quad (19)$$

3.5. Semantic elements linking the system to its environment

The ERTN diagram is a formalism for describing the transformation processes and flows in a system. This system is therefore included in a boundary enclosure. Beyond this border is the *environment*, environment with which our system necessarily interacts via material or energy flows. In concrete terms, it represents the economic market on which, on the one hand, raw materials and primary energies are purchased, and on the other hand, finished products are sold or waste (material and energy) is rejected.

3.5.1. Provision and Demand element

Provision and **Demand** elements (⊙ in Table 1) allow to model flows from or to the environment, as data supposedly known and fixed. For the purposes of this article, it is assumed that *provision* or *demand* are made continuously over a period and are therefore defined by a flow rate (mass unit per period). Thus, a supply (resp. demand) of cumulative resource r is characterized by a component vector $App_{r,t}$ (resp. a component vector $Dem_{r,t}$) defined for each period t of the horizon. For example, the vector App_r can represent a forecasted supply planning of resource r while the vector Dem_r can represent a forecasted needs planning of resource r .

3.5.2. Import and Export element

Import and **Export** elements (⊗ in Table 1) allow to model resource flows received from external sources or provided to external consumers whose value is not known. It is therefore a decision variable that in this case, may appear as a relaxation variable of a constraint. Here again, for the purposes of this article, it is assumed that imports or exports are carried out continuously over a period and are therefore defined by a flow rate (mass unit per period).

Let $Imp_{r,t}$ (resp. $Exp_{r,t}$), be a real variable representing the total mass of resource r imported (resp. exported) during period t . This is limited by a minimum bound Imp_r^{min} (resp. Exp_r^{min}) and maximum bound Imp_r^{max} (resp. Exp_r^{max}) via the constraint (20) (resp. constraint (21)):

$$Imp_r^{min} \leq Imp_{r,t} \leq Imp_r^{max} \quad \forall r \in R^C, \forall t \in T \quad (20)$$

$$Exp_r^{min} \leq Exp_{r,t} \leq Exp_r^{max} \quad \forall r \in R^C, \forall t \in T \quad (21)$$

3.6. Dynamic mass balance on a cumulative resource node

Fig. 5 illustrates all flows corresponding to cumulative resource consumption or production at borders and within a given period t . Constraint (22) represents the generalized mass balance over time applicable to all cumulative resources r that allows the evaluation of the stock $S_{r,t}$ obtained at the end of the period t .

$$S_{r,t} = S_{r,t-1} + \sum_{k \in K_r^{prod}} P_{r,k,t} - \sum_{k \in K_r^{cons}} C_{r,k,t} + \sum_{k \in K_r^{prod}} UP_{r,k,t} - \sum_{k \in K_r^{cons}} UC_{r,k,t} + Imp_{r,t} - Exp_{r,t} + App_{r,t} - Dem_{r,t} \quad \forall r \in R^C, \forall t \in T \quad (22)$$

3.7. Logical resource node and transition arc

Logical resource nodes (⊙ in Table 1) are used to authorize (or not) the execution of a task at a given time. They are particularly useful for managing *multimodal devices*, i.e. devices in which different tasks can be performed successively (each corresponding to an operating mode) but in which the transition from one to the other must respect a predetermined transition sequence. The state of a logical resource can be considered as a marking. The discrete entities contained in these logical resources are assimilated to *tokens* requisitioned at the start of a task and released at its end. These nodes are identified by an **RI** number (where l is the logical resource number), a label and three parameters: O_l , CL_l^{max} and $Policy_l$ that specifies the associated storage or transfer policy (the same as for cumulative resources r). Each logical resource l is associated with an integer variable $R_{l,t}$ representing its marking at the end of the period t . The constraint (23) ensures that the marking of the logical resource l does not exceed its capacity, while the constraint (24) allows its marking to be initialized at

$$R_{l,t} \leq CL_l^{max} \quad \forall l \in R^L, \forall t \in T \quad (23)$$

$$R_{l,0} = RO_l \quad \forall l \in R^L, \forall t \in T \quad (24)$$

t 0:

Logical resources are linked to the tasks by **transition** arcs incoming or outgoing from the task (⊗ in Table 1). They are annotated according to the weight of the arc, i.e.:

- for an arc entering the task k , $\alpha_{k,l}^{cons}$ is equal to the number of tokens of the logical resource l that must be requisitioned by this task for its execution,
- for an arc leaving the task k , $\alpha_{k,l}^{prod}$ is equal to the number of tokens of the logical resource l that must be released once this task is completed.

A logical resource is always:

- consumed at the beginning of the period t when operation k starts, i.e. when $WD_{k,t} = 1$,

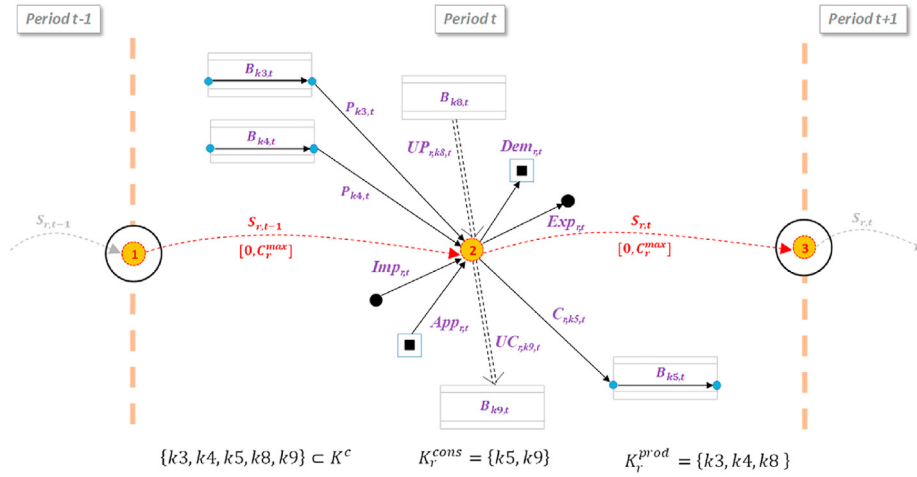

Fig. 5. Mass balance on a cumulative resource node.

- released at the end of the period t when operation k ends, i.e. when $WA_{k,t} = 1$.

Under these conditions, the marking of the logical resource l over time is governed by constraint (25):

$$R_{l,t} = R_{l,t-1} + \sum_{k \in K^c} \alpha_{k,l}^{prod} WA_{k,t} - \sum_{k \in K^c} \alpha_{k,l}^{cons} WD_{k,t} \quad \forall l \in R^L, \forall t \in T \quad (25)$$

Finally, it should be noted that, like cumulative resource nodes, it is possible to connect a logical resource node to *Provision* or *Demand* elements, as well as to *Import* or *Export* elements.

3.8. Notion of component: a ERTN macro representation

This semantic element ($\textcircled{\text{}}$ in Table 1) aims to encapsulate a sequence of tasks and resources in a single entity (Fig. 6).

A *component* can be nested on several levels. The inlet/outlet of the *component* are identified on the border of the element as *ports*. An *outlet port* is represented by a hexagon with a black background while an *inlet port* is represented by a hexagon with a grey background. Each port is annotated with the nature of the stream to which it has to be connected. Only a *cumulative resource* node can

be connected to a *port* via a *flow arc* or a *Production/Consumption arc* (no *task* node or *disjunctive* resource). No additional parameters or variables are added. Thanks to the notion of component, the configuration tool **ERTNModelBuilder** offers a module based approach to facilitate the modelling of complex systems. A modeler can then construct the ERTN graphs of a system by combining these different modules, where each module is itself an assembly of semantic elements representing a device as a whole and for which only the particular parameters remain to be entered.

4. Description of the case study

4.1. Challenges of utility plant management included Combined Heat and Power (CHP) units

As shown in Fig. 7, the operation of on site utility plants is currently more complex due to the many internal and external interactions to be considered. Firstly, process units must be increasingly responsive to economic market fluctuations, leading to greater variability in utility consumption. As a result, utility plants must be more flexible [21]. This implies thinking about the possible shutdowns and start ups of production devices to cope with fluctuating process demands under any circumstance. In addition,

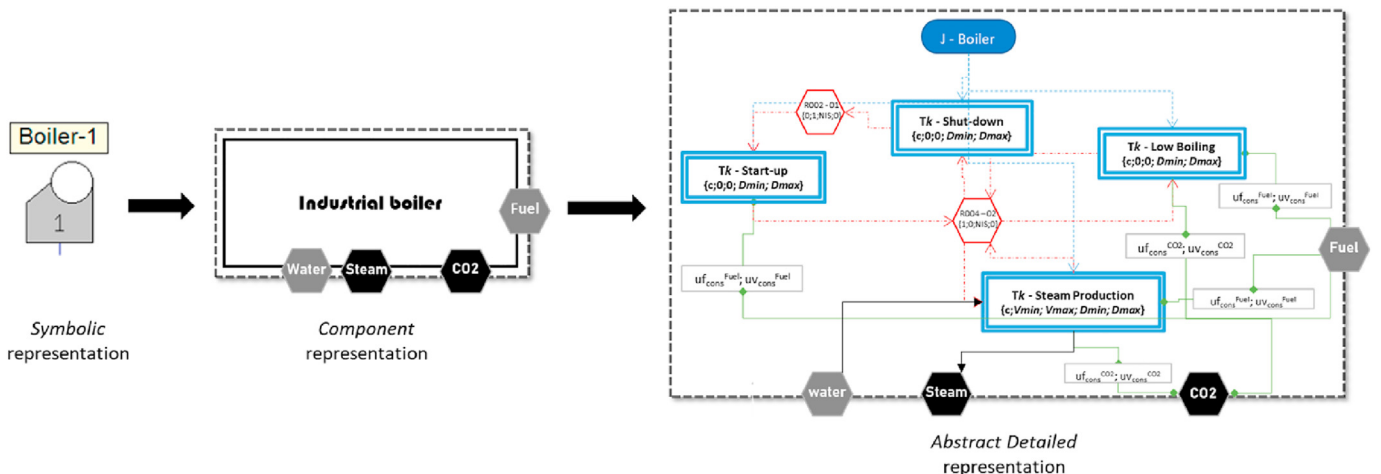

Fig. 6. Notion of Component.

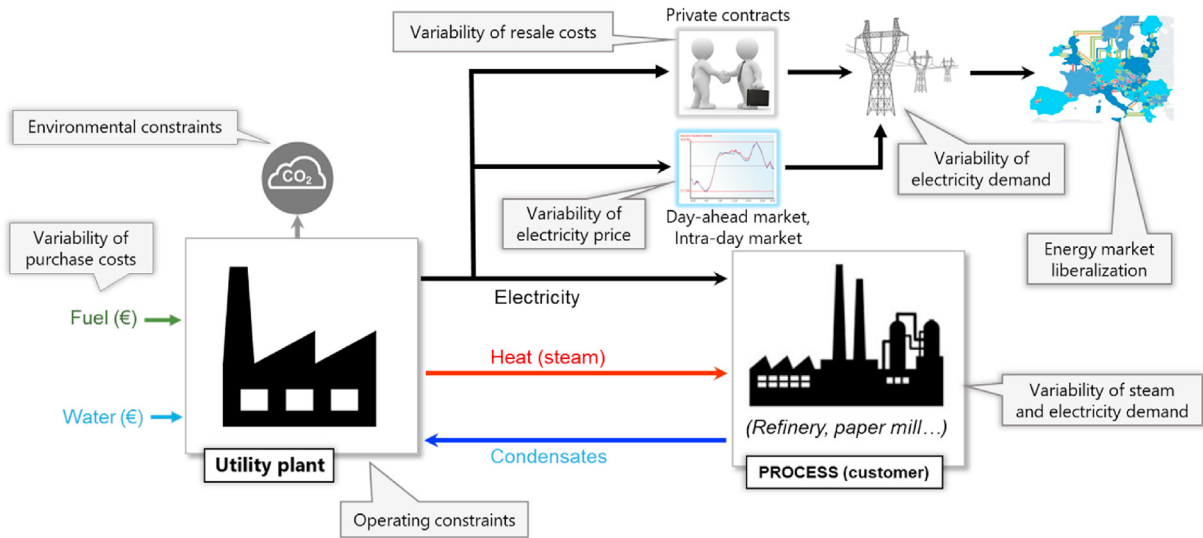

Fig. 7. Economical and technical context of the Management of a Utility Plant.

technical operating constraints (such as equipment capacities, permissible pressures and temperatures or minimum time between two restarts) are all parameters to be taken into account in the management of the utility plant. Besides, the variability of fuel purchase cost as well as the environmental constraints have now a significant impact on the site's economic profitability [22].

At the same time, since the liberalization of the energy market [23], utility plant including CHP units have become interesting contributors to electricity production [24]. Frequently used on onsite utility systems, CHP plants results in a noticeable energy conservation (usually ranging from 10% to 30%) while the avoided CO₂ emissions are similar to the amount of energy saving [25,26]. Legislation encouraging the spread of cogeneration [27], roughly 50% of the installed CHP capacity is in the industry, mainly in the paper, ceramics, chemicals, refineries and food/drinks sectors [28].

4.2. Decision making procedure

Considering the classic hierarchical organization of companies, the PLANENER project focus specifically on the methodology that addresses the short term planning level (Fig. 8). On this horizon, note that companies can carry out transactions on the *Day Ahead market*. Through *EPEX SPOT*, which manages the European electricity market, the price is set every day for the next day based on calls for tenders. This in time sensitive electricity price depends on the day, time and other external factors such that the increasing share of renewable energies in the electricity mix [29].

In the literature, many articles deal with short term CHP planning. The review on short term CHP planning published in Ref. [30] classifies the research in terms of problem formulations and solution methodology. In Ref. [31], the literature review has been divided into three parts. The first part concerns the relevant literature on CHP plant operation planning only, the second part deals

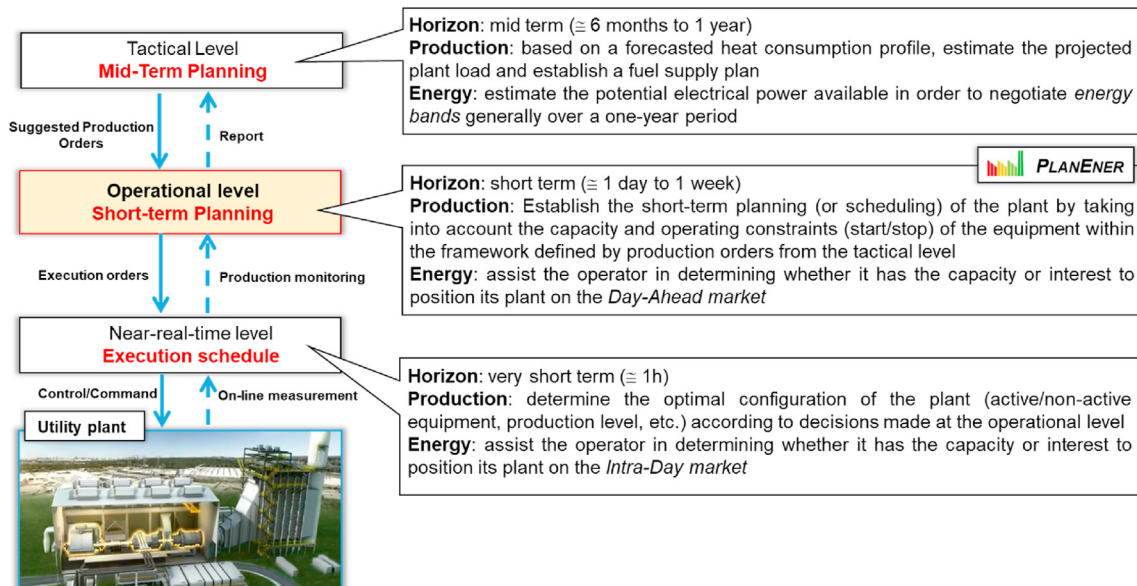

Fig. 8. Position of the PLANENER project in the classic hierarchical organization of companies.

- Utility plant equipment :**
- 2 natural gas-fired **boilers** (Boiler-1 and Boiler-2) with different efficiencies
 - 1 **cogeneration train** (Cogeneration Train including a **Gas Turbine** and a heat recovery exchanger EXCH)
 - 2 **desuperheating valves** (V1 and V2)
 - 1 **multi-stage steam turbine** (M-Turbine)
 - 1 **single steam turbine** (S-Turbine)
- Utility plant operation :**
- **Steam production** : 3 pressure levels (HPS=20 bars, MPS=12.7 bars, BPS=2 bars)
 - **Boiler-1, Boiler-2** and **Cogeneration Train** generate **High Pressure Steam (HPS)** from deaerated water
 - **V1** converts HPS into **Medium Pressure Steam (MPS)**
 - **V2** converts MPS into **Low Pressure Steam (LPS)**
 - **M-Turbine** converts HPS into MPS and LPS
 - **S-Turbine** converts HPS into LPS
 - **Deaerated water** is produced in a tank from LPS and **demineralized water**
 - **Electricity generation** sold on the **Day-ahead market** *Epex Spot* by means of the **Gas Turbine**, the **M-Turbine** and the **S-Turbine**
 - **Natural gas** is consumed as **fuel** by all steam producers
 - Each equipment is able to instantly return to its nominal operation point after a shutdown, except **Boiler-1** and **Boiler-2**

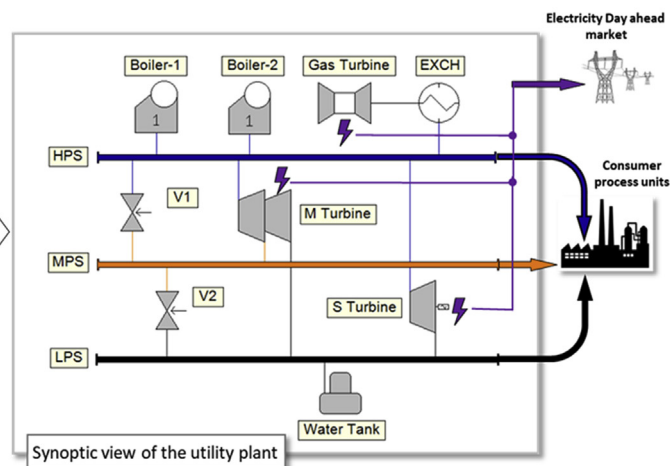
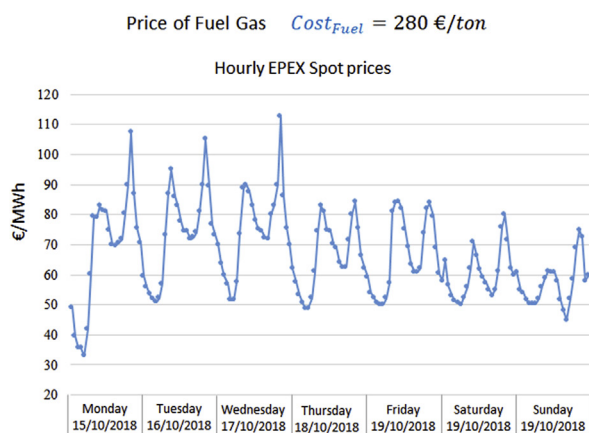
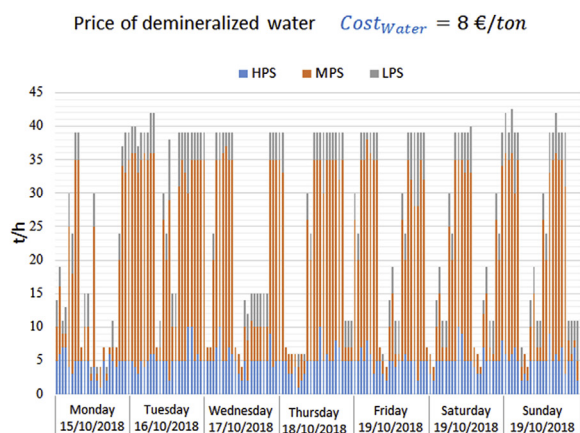

Fig. 9. Flowsheet of an industrial CHP plant.



(a) – Forecast Day-ahead market prices



(b) – Forecast steam demande profile

Fig. 10. Input data of the case study.

with literature on bidding in (multiple) electricity markets while the third part discusses literature that combines CHP plant operation planning with bidding in electricity markets.

4.3. Characteristics of the case study

Our methodology is applied to an industrial medium size utility plant, which includes a CHP unit. The equipment and the operation of this plant is summarized in Fig. 9. With a rated power of 40 MW of heat and 5 MW of electricity, this system is close to a real case. The output of this optimization is to establish the short term planning over a one week horizon (i.e. 168 periods where 1 period = 1 h). This sampling period has been chosen according to the needs of customers as the electricity is traded with the granularity of 1 h. In addition, for the purpose of planning, the granularity of 1 h is sufficient as the faster dynamics is supposed not of interest in the view of operations plans.

Scheduling power in Day ahead market requires accurate predictions of steam and electricity production. Fig. 10 (a) depicts the electricity prices ($Spot_t$) in the *Epex Spot* observed from 15 to 21 October 2018. Prices range from approximately 30 to more than 110 €/MWh and their changes are very frequent showing their volatile

nature. A diurnal pattern can also be seen meaning that there is a periodicity of 24 h. We consider that these prices are the prices forecasted for a coming week and are entered as model input data. The objective is to determine the periods for which it is cost effective to sell electricity in the Day ahead market.

Finally, Fig. 10 (b) shows the cumulative steam demand that the utility plant must satisfy, ranging from approximately 2.0 ton/h to 42.5 ton/h and distributed according to the three pressure levels. This forecast is considered as reliable because the steam demand is directly dependent on the production plan that the process will have to carry out over the coming week.

5. Case study modelling and results

Note that the case study presented here is fictitious and therefore the data are obtained using *ARIANE*TM software. The first step is to model this case study as explain in section 2.5 in order to obtain the configuration parameters that instantiate the MILP model. Then, production planning is obtained by solving the resulting mathematical model.

1. Ariane modelling and simulation

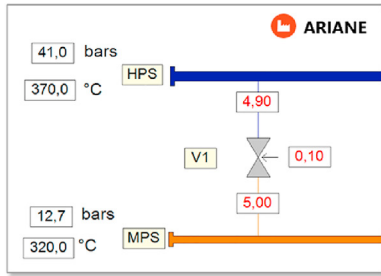

2. Calculation of the parameters for ERTN diagram

MPS flowrate (t/h)	5
Inlet water fraction (-)	=0.1/5=0.02
Inlet HPS fraction (-)	=4.9/5=0.98

3. Construction of ERTN diagram

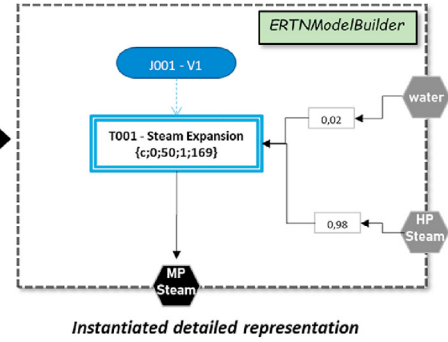

Fig. 11. Modelling steps of the desuperheating valve V1.

5.1. Modelling linear behaviour equipment: the example of the desuperheating valve

There are devices whose operation can be considered as linear (such as the two desuperheating valves V1 and V2, the two steam turbines S Turbine and M Turbine, the Water Tank and the two boilers Boiler 1 and Boiler 2). The valve V1 is used as an example to explain the approach. In this particular case, HPS and MPS networks have to be described as well as the deaerated water consumed by the valve. Then, a simulation of an operating case enables to determine the parameters required for the ERTN modelling which are the quantitative ratios of deaerated water and HPS steam necessary to produce one ton of MPS steam, the temperature and pressure of the two steam networks being fixed. Finally, the construction of the ERTN diagram follows the rules of the formalism and shows the node corresponding to the equipment and the one corresponding to the operation. The “steam expansion” operation consumes water and HPS, each represented by an internal port, the associated coefficients corresponding to the ratios are calculated in step 2, as shown in Fig. 11.

5.2. Modelling non linear behaviour equipment: the example of the cogeneration train

Some devices have an inherently non linear operation such as the cogeneration train. In this equipment, the gas turbine consumes fuel to produce flue gas at high temperature and electricity and emits CO₂. The flue gas then pass through a heat exchanger to produce steam at a high pressure level from deaerated water. There is a linear relationship between the electricity produced and the fuel flow consumed, as well as between the amount of CO₂ emitted and the fuel flow. An ARIANE™ simulation is used to determine the value of these proportionality coefficients named $uv_{k,r}^{prod}$ in the formalism. Since the coefficients found express quantities in terms of tonnes per hour of fuel consumed, *production arcs* are used. On the contrary, the amount of HPS produced in the exchanger does not depend linearly on the fuel flowrate at the inlet of the gas turbine. It is then necessary to perform a piecewise linearization to describe the operation of the cogeneration train. For this purpose, a specific MILP model has been developed that minimizes the number of pieces needed to respect an absolute difference ϵ

1. Ariane modeling and simulation

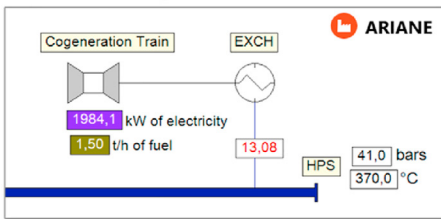

2. Piecewise linearization

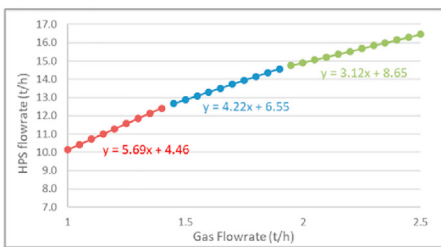

3. Calculation of the parameters for ERTN diagram

4. Construction of ERTN diagram

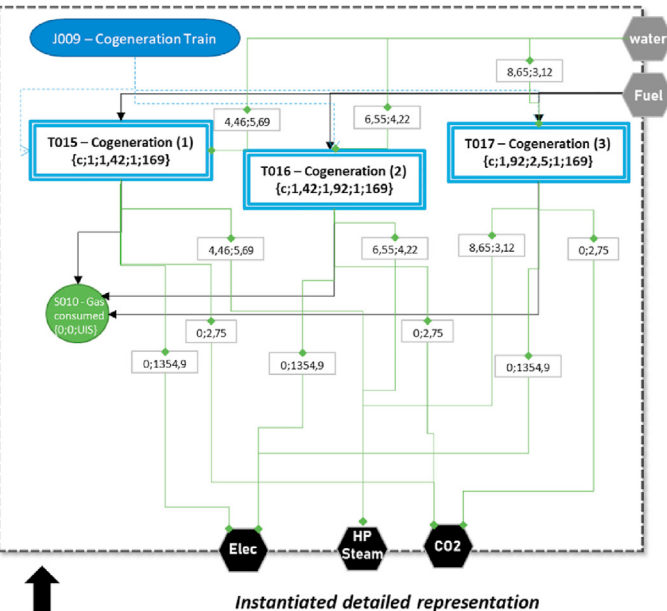

Fig. 12. Modelling steps of the cogeneration train.

between the “real” (here, a series of points calculated by an *ARIANE*TM simulation) and linearized values. The output of the optimization are the slopes of each segment and its boundaries. For instance, with $\epsilon = 0.04$ ton, a three piece linearization is required. The ERTN representation of the cogeneration train therefore involves duplicating in three the node that represents the operation of the train, as shown in Fig. 12.

The lower and upper bounds of each operation node corresponds to the consumption of fuel. The production of HPS steam is expressed with a *production* arc and the consumption of water with a *consumption* arc. The slope of each segment corresponds to the coefficient $uv_{k,r}^{prod}$ and the ordinate at origin to the coefficient $uf_{k,r}^{prod}$. Note that the material balance is respected since the coefficients for the water consumption and for the HPS production are identical.

5.3. Modelling of multi modal equipment: the example of the boiler

The ERTN formalism allows representing multimodal equipment, such as boilers Boiler 1 and Boiler 2. At first, they have a linear behaviour. The modelling steps are therefore identical to those done in section 6.1. The gas flow rate consumed depends linearly on the HPS steam flow rate produced, as well as the CO2 emissions. An *ARIANE*TM simulation is used to determine the coefficients required to construct the ERTN diagram. Then, we distinguish three other types of operations other than *steam production*: the *start up* operation, the *shutdown* operation and the *low boiling* operation. *Logical resource* nodes, as well as *transition arcs*, are used to define the legal transition sequences between these different modes, as shown in Fig. 13.

The state in which the equipment is at the beginning of the planning is initialized thanks to a *token* in the corresponding logical state. In this example, R002 is thus initialized to 1, and since the storage of tokens is prohibited (capacity of R002 sets to 0), the token has to be consumed at the first period of the horizon, either by the operation “T005–Steam production” or “T006–Low Boiling” or “T007–Shutdown”. If the token is consumed by the *Shutdown* operation, it has to go through the *Start up* operation before it can be made available again for consumption by the production operation. Finally, as the *Low Boiling* operation consumes gas and emits CO2, up to 5% of the maximum level of the *Production* operation, the associated coefficients are therefore calculated to respect this constraint. This corresponds to the $uf_{k,r}^{cons}$ coefficient for gas (or

$uf_{k,r}^{prod}$ for CO2 emissions) because the production capacity $B_{k,t}$ of the operation is zero. The *Start up* operation, that lasts 4 h, also consumes gas.

5.4. Representation of the complete system

The complete graphical representation is shown in Fig. 14. The ERTN diagram consists of 17 operation nodes, 11 cumulative resource nodes, 9 disjunctive resource nodes and 4 logical resource nodes. Once the data collection (by measurement or by simulation) is completed, a few hours are enough to fill in this graph with the ERTN calculated parameters. Then, the graphical construction with **ERTNModelBuilder** takes only a few tens of minutes. The generation of the configuration file that instantiates **ProSched** is instantaneous.

Note that this generic methodology is applicable to industrial systems that are much more complex than this case study. As proof, this tool is currently being validated at the CHP of the TOTAL group’s largest French refinery (more than 50 significant pieces of equipment, 16,000 tons of steam per day, 140 240 MW of electricity). The time required to develop the model for this system, following the steps described above, is approximately one week.

The accuracy of this linear model is evaluated by comparison with the high accuracy non linear modelling performed with *ARIANE*TM, which is considered as the reference. Several comparative tests were carried out and have showed that the results are similar, with a maximum deviation of $\pm 0.3\%$.

5.5. Short term planning of CHP plant that minimizes operating costs

The objective function aims to minimize operating costs of the CHP plant (i.e. minimize fuel purchase cost and water purchase cost minus the profit resulting from the sale of the electricity produced). Thus, the objective function z is as follows (26):

$$\min z = \sum_{t \in T} Imp_{Fuel,t} \times Cost_{Fuel} + \sum_{t \in T} Imp_{Water,t} \times Cost_{Water} + \sum_{t \in T} Exp_{Elec,t} \times Spot_t \quad (26)$$

The results are quantified in terms of fuel and CO2 emissions

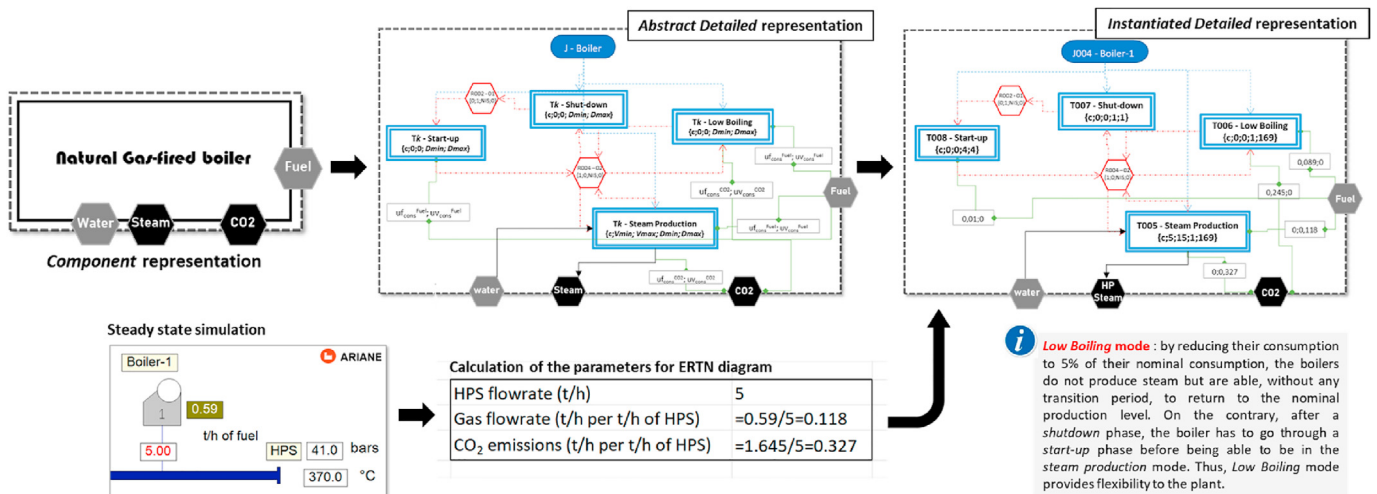

Fig. 13. Modelling steps of the boiler.

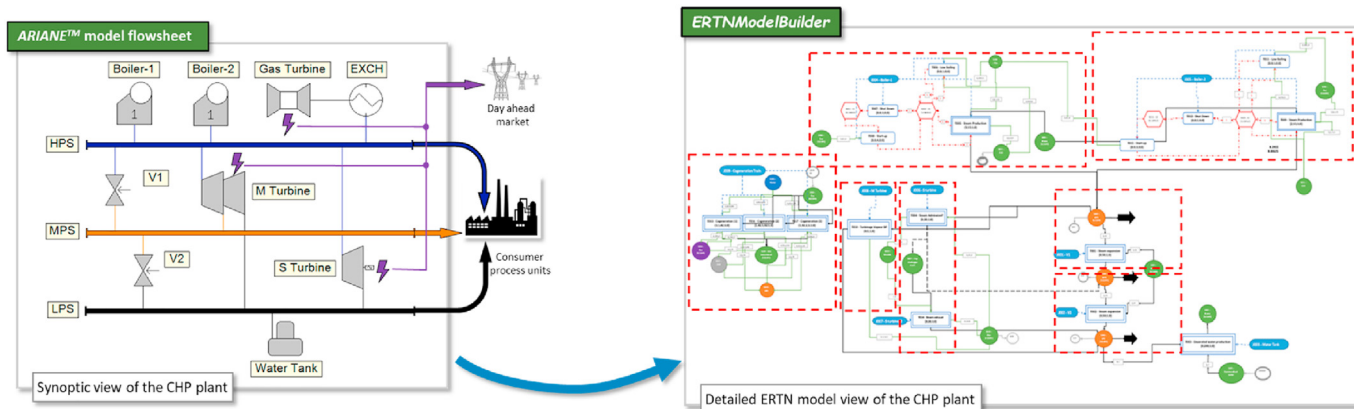

Fig. 14. Graphical representations of the CHP in ARIANE™ and the corresponding ERTN model.

Table 2
Key resolution features comparison between Case study and the TOTAL Refinery.

	Time periods	Constraints	Variables (including binary)	Gap	CPU Time (s)
Case study	168	211,878	139,465 (2856)	0%	9.6
TOTAL Refinery	168	5,397,166	3,397,166 (18,144)	0%	285.8

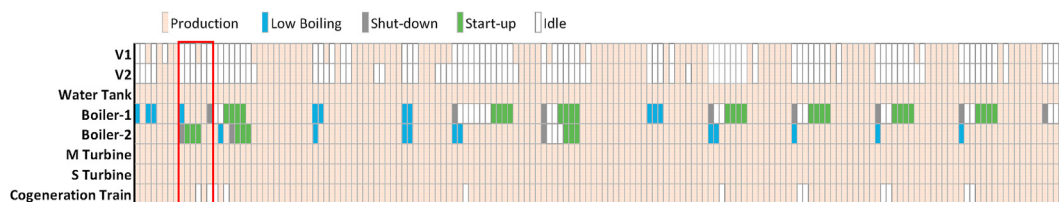

Fig. 15. Short-term planning of the CHP.

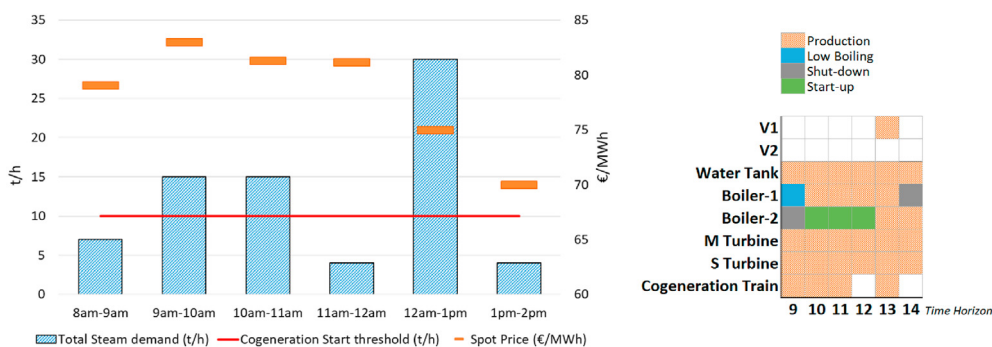

Fig. 16. Data used for the studied scenarios (a). Focus on the corresponding scheduling (b).

savings. The resolution of the planning model is performed on IntelCore i7 (2.8 GHz, 16 Go RAM). The key features of the resolution are given in Table 2. Note that the very short calculation time makes it possible to reach the optimal solution for TOTAL's CHP planning over a one week horizon at hourly step in less than 5 min.

The short term planning of the CHP is presented in Fig. 15, in the form of a GANTT chart where the production status of each piece of equipment appears. For multi modal equipment such as the two boilers or those whose production has been represented by a linear function by pieces, several tasks (and therefore several colors) appear on the diagram. To explain the results, six periods (from 8am to 2pm of the first day) of the diagram are examined in the

following.

Over this 6 period horizon, production data are summarized in Fig. 16 a and the corresponding scheduling is shown on Fig. 16 b. Not all scenarios have been explored in this article but the results of three of them are explained below.

- **Low steam demand and high electricity selling price**

In the first period observed, from 8am to 9am, only the cogeneration train produces steam. Boiler 1 is in *Low Boiling* and Boiler 2 is in *shutdown* phase. However, as shown in Fig. 16 a, the steam demand is lower than the start threshold of the cogeneration train,

represented by the red line. The steam produced is then sent to the vent, which means to the atmosphere. This is due to a very attractive electricity price. The waste of steam and therefore of fuel is compensated by the gain obtained by selling the electricity produced. On the contrary, from 11am to 12am, only Boiler 1 produces steam. Indeed, the steam demand is too low to justify an overproduction of steam, despite an attractive electricity price.

- **High steam demand and high electricity selling price**

Over the next two periods, from 9am to 11am, Boiler 1 and the cogeneration train are in production. Indeed, Fig. 16 shows that the steam demand has increased. Therefore, two equipment have to be in production at the same time and the resale price on the electricity market is still interesting for the cogeneration train's power production.

- **High steam demand and low electricity selling price**

From 12am to 1pm, the steam demand has increased and requires the activation of the *Production* mode for all three equipment. This explains why the Boiler 1 is not shut down at 9am. If the boiler is switched off, it does not produce steam for at least 5 h (1 h for shut down off and 4 h for start up). Finally, from 1pm to 2pm, only Boiler 2, which is the most efficient boiler, produces steam because steam demand is low and electricity price is not attractive for resale on the electricity market.

The planning obtained with *PLANENER* is compared to the result achieved if the same work is done with the *ARIANE™* software. Since *ARIANE™* considers each operating case independently (1 operating case 1 period), 168 independent optimizations are therefore carried out successively. *PLANENER* enables to obtain a lower operating cost than *ARIANE™*, reducing the utility plant's operating cost by 7%, which corresponds to a saving of €11 k. From the standpoint of fuel economy, 6% of natural gas is saved, i.e. 36 ton, which has a direct impact on CO₂ emissions, which are also reduced by 6%, i.e. 102 ton of avoided CO₂ emissions. Annually, it represents an average 1728 ton of natural gas saved and an average 4877 ton of avoided CO₂ emissions.

6. Conclusion

In this paper, a modelling framework and a methodology dedicated to the short term planning of production systems was presented. The main value of these works is the provision of a complete and in practice tested methodology for model development of energy systems. Based on the ERTN formalism, both multi modal and non linear behaviour equipment can be taken into account. The implementation of the configuration tool *ERTNModelBuilder* facilitates the rapid prototyping of models thanks to a drag and drop block oriented graphical modelling user interface. By processing the resulting graph, this tool generates the configuration parameters allowing the automatic instantiation of the generic planning MILP model. Its applicability and the performance of the optimization tool enables to handle any system even large problems.

As an illustrative application, this paper investigates CHP optimal short term hourly scheduling (one week ahead) in an industrial site. The goal is to minimize the site's operating cost by generating a profit on the electricity sold on the *Day ahead* market while satisfying the utility needs of a process. The validation phase of the tool currently underway on the TOTAL industrial case suggests that the proposed models, linearization and constraint formulation are efficient and adequate. On a practical level, the next step is to carry out an operational validation of the tool in a real

context and by the site operators.

Although short term planning for cogeneration plants shows significant energy and economic benefits, future work aims to fully integrate the tool into the plant's decision making process in order to improve its efficiency and responsiveness to uncertainty and to *Day ahead* market dynamics, as well as to be able to manage production disruptions (equipment failure). Indeed, uncertainty consideration, thus, is very important to preserve plant feasibility and viability during operations. In our approach, the robust planning is implemented through a sliding horizon (24 h rescheduling periodicity) decision making structure divided into two levels named respectively *forecast level* and *operational level*. These two decision making levels are necessary in order to take into account the variety of constraints and data dynamics.

Credit author statement

Lise Mallier: Conceptualization, Methodology, Software, Writing original draft, Visualization, Investigation, Gilles Hétreux: Conceptualization, Methodology, Software, Writing original draft, Visualization, Investigation, Raphaelé Thery Hétreux: Conceptualization, Methodology, Software, Visualization, Philippe Baudet: Supervision, Project administration, Funding acquisition

Declaration of competing interest

The authors declare that they have no known competing financial interests or personal relationships that could have appeared to influence the work reported in this paper.

Acknowledgements

We would like to thank Proesis SAS and ANRT for the financial support.

Appendix A. Supplementary data

Supplementary data to this article can be found online at <https://doi.org/10.1016/j.energy.2020.118976>.

References

- [1] Lee J, Yang J. Global energy transitions and political systems. *Renew Sustain Energy Rev* 2019;115:109370. <https://doi.org/10.1016/j.rser.2019.109370>.
- [2] IEA (International Energy Agency). *Annual energy outlook 2017, 2018*.
- [3] ADEME (Environment and Energy Management Agency). *Key Figures Climate Air and Energy 2018;224*. ISBN 979-10-297-1204-3. (in French).
- [4] Dvořák M, Havel P. Combined heat and power production planning under liberalized market conditions. *Appl Therm Eng* 2012;43:163–73. <https://doi.org/10.1016/j.applthermaleng.2011.12.016>.
- [5] Ferrari-Trecate G, Gallestey E, Letizia P, Spedicato M, Morari M, Antoine M. Modeling and control of co-generation power plants: a hybrid system approach. *IFAC Proc Vol* 2004;12:694–705. <https://doi.org/10.3182/20020721-6-ES-1901.01197>.
- [6] Rong A, Lahdelma R. Efficient algorithms for combined heat and power production planning under the deregulated electricity market. *Eur J Oper Res* 2007;176(2):1219–45. <https://doi.org/10.1016/j.ejor.2005.09.009>.
- [7] Yusta J, De Oliveira-De Jesus P, Khodr H. Optimal energy exchange of an industrial cogeneration in a day-ahead electricity market. *Elec Power Syst Res* 2008;78(10):1764–72. <https://doi.org/10.1016/j.epsr.2008.03.012>.
- [8] Aguilar O, Perry S, Kim J, Smith R. Design and optimization of flexible utility systems subject to variable conditions: Part 1: modelling framework. *Chem Eng Res Des* 2007;85(8):1136–48. <https://doi.org/10.1205/cherd06062>.
- [9] Velasco-Garcia P, Varbanov PS, Arellano-Garcia H, Wozny G. Utility systems operation: optimisation-based decision making. *Appl Therm Eng* 2011;31:3196–205. <https://doi.org/10.1016/j.applthermaleng.2011.05.046>.
- [10] Théry R, Hétreux G, Agha MH, Hait A, Le Lann JM. The extended resource task network: a framework for the combined scheduling of batch processes and CHP Plant. *Int J Prod Res* 2011;50(3):623–46.
- [11] Sadeghian H, Ardehali MM. A novel approach for optimal economic dispatch scheduling of integrated combined heat and power systems for maximum economic profit and minimum environmental emissions based on Benders

- decomposition. *Energy* 2016;102:10 23. <https://doi.org/10.1016/j.energy.2016.02.044>.
- [12] Alipour M, Zare K, Mohammadi-Ivatloo B. Short-term scheduling of combined heat and power generation units in the presence of demand response programs. *Energy* 2014;71:289 301. <https://doi.org/10.1016/j.energy.2014.04.059>.
- [13] Zapata Riveros J, Bruninx K, Poncelet K, D'haeseleer W. Bidding strategies for virtual power plants considering CHPs and intermittent renewables. *Energy Convers Manag* 2015;103:408 18. <https://doi.org/10.1016/j.enconman.2015.06.075>.
- [14] Taccari L, Amaldi E, Martelli A, Bischi A. Short-term planning of cogeneration power plants: a comparison between MINLP and piecewise-linear MILP formulations. *Comput Aid Chem Eng* 2015;37:2429 34. <https://doi.org/10.1016/B978-0-444-63576-1.50099-6>.
- [15] Floudas C, Lin X. Continuous-time versus discrete-time approaches for scheduling of chemical processes: a review. *Comput Chem Eng* 2004;28(11): 2109 29. <https://doi.org/10.1016/j.compchemeng.2004.05.002>.
- [16] Zhang Q, Sundaramoorthy A, Grossmann IE, Pinto JM. A discrete-time scheduling model for continuous power-intensive process networks with various power contracts. *Comput Chem Eng* 2016;84:382 93. <https://doi.org/10.1016/j.compchemeng.2015.09.019>.
- [17] Bindlish R. Power scheduling and real-time optimization of industrial cogeneration plants. *Comput Chem Eng* 2016;87:257 66. <https://doi.org/10.1016/j.compchemeng.2015.12.023>.
- [18] Tina GM, Passarello G. Short-term scheduling of industrial cogeneration systems for annual revenue maximisation. *Energy* 2012;42(1):46 56. <https://doi.org/10.1016/j.energy.2011.10.025>.
- [19] Maravelias CT. General framework and modeling approach classification for chemical production scheduling. *AIChE J* 2012;58(6):1812 28. <https://doi.org/10.1002/aic.13801>.
- [20] Hétreux G, Fabre F, LeLann JM, Zaraté P. Dynamic hybrid simulation of batch processes driven by a scheduling module. *Comput Chem Eng* 2011;35(10): 2098 112. <https://doi.org/10.1016/j.compchemeng.2011.04.007>.
- [21] Kopanos G, Georgiadis M, Pistikopoulos E. Scheduling energy cogeneration units under energy demand uncertainty. *IFAC Proceedings Volumes* 2013;46(9):1280 5. <https://doi.org/10.3182/20130619-3-RU-3018.00275>.
- [22] Agha MH, Théry R, Hétreux G, Hait A, Le Lann JM. Integrated production and utility system approach for optimizing industrial unit operations. *Energy* 2010;35(2):611 27. <https://doi.org/10.1016/j.energy.2009.10.032>.
- [23] Meyer NI. Distributed generation and the problematic deregulation of energy markets in Europe. *Int J Sustain Energy* 2003;23(4):217 21. <https://doi.org/10.1080/01425910412331290724>.
- [24] Santos MI, Uturbey W. A practical model for energy dispatch in cogeneration plants. *Energy* 2018;151:144 59. <https://doi.org/10.1016/j.energy.2018.03.057>.
- [25] Ren X-Y, Jia XX, Varbanov PS, Klemeš JJ, Liu ZY. Targeting the cogeneration potential for Total Site utility systems. *J Clean Prod* 2018;170:625 35. <https://doi.org/10.1016/j.jclepro.2017.09.170>.
- [26] Çakir U, Çomaklı K. The role of cogeneration systems in sustainability of energy. *Energy Convers Manag* 2012;63:196 202. <https://doi.org/10.1016/j.enconman.2012.01.041>.
- [27] The European Parliament. Directive 2004/8/EC of the European Parliament and of the Council of 11 February 2004 on the promotion of cogeneration based on a useful heat demand in the internal energy market and amending Directive 92/42/EEC 21/02/2004. 2004.
- [28] Cogen Europe. Cogen europe report. 2011. <http://www.cogeneurope.eu/medialibrary/2011/08/16/9a4bfd5/30062011-COGEN-Europe-report-Cogeneration-2050.pdf>.
- [29] De Ridder F, Claessens B. A trading strategy for industrial CHPs on multiple power markets. *Int Trans Elect Energy Syst* 2014;24(5):677 97. <https://doi.org/10.1002/etep.1725>.
- [30] Kumbartzky N, Schacht M, Schulz K, Werners B. Optimal operation of a CHP plant participating in the German electricity balancing and day-ahead spot market. *Eur J Oper Res* 2017;261(1):390 404. <https://doi.org/10.1016/j.ejor.2017.02.006>.
- [31] Salgado F, Pedrero P. Short-term operation planning on cogeneration systems: a survey. *Elec Power Syst Res* 2008;78(5):835 48. <https://doi.org/10.1016/j.epsr.2007.06.001>.