



**HAL**  
open science

## Twin-width I: tractable FO model checking

Edouard Bonnet, Eun Jung Kim, Stéphan Thomassé, Rémi Watrigant

► **To cite this version:**

Edouard Bonnet, Eun Jung Kim, Stéphan Thomassé, Rémi Watrigant. Twin-width I: tractable FO model checking. FOCS 2020, Nov 2020, online, United States. hal-03107581

**HAL Id: hal-03107581**

**<https://hal.science/hal-03107581>**

Submitted on 13 Aug 2022

**HAL** is a multi-disciplinary open access archive for the deposit and dissemination of scientific research documents, whether they are published or not. The documents may come from teaching and research institutions in France or abroad, or from public or private research centers.

L'archive ouverte pluridisciplinaire **HAL**, est destinée au dépôt et à la diffusion de documents scientifiques de niveau recherche, publiés ou non, émanant des établissements d'enseignement et de recherche français ou étrangers, des laboratoires publics ou privés.

# 1 Twin-width I: tractable FO model checking

2 Édouard Bonnet 

3 Univ Lyon, CNRS, ENS de Lyon, Université Claude Bernard Lyon 1, LIP UMR5668, France  
4 edouard.bonnet@ens-lyon.fr

5 Eun Jung Kim 

6 Université Paris-Dauphine, PSL University, CNRS UMR7243, LAMSADE, Paris, France  
7 eun-jung.kim@dauphine.fr

8 Stéphane Thomassé

9 Univ Lyon, CNRS, ENS de Lyon, Université Claude Bernard Lyon 1, LIP UMR5668, France  
10 stephan.thomasse@ens-lyon.fr

11 Rémi Watrigant 

12 Univ Lyon, CNRS, ENS de Lyon, Université Claude Bernard Lyon 1, LIP UMR5668, France  
13 remi.watrigant@univ-lyon1.fr

## 14 — Abstract —

---

15 Inspired by a *width* invariant defined on permutations by Guillemot and Marx [SODA '14], we  
16 introduce the notion of twin-width on graphs and on matrices. Proper minor-closed classes, bounded  
17 rank-width graphs, map graphs,  $K_t$ -free unit  $d$ -dimensional ball graphs, posets with antichains  
18 of bounded size, and proper subclasses of dimension-2 posets all have bounded twin-width. On  
19 all these classes (except map graphs without geometric embedding) we show how to compute in  
20 polynomial time a *sequence of  $d$ -contractions*, witness that the twin-width is at most  $d$ . We show  
21 that FO model checking, that is deciding if a given first-order formula  $\phi$  evaluates to true for a  
22 given binary structure  $G$  on a domain  $D$ , is FPT in  $|\phi|$  on classes of bounded twin-width, provided  
23 the witness is given. More precisely, being given a  $d$ -contraction sequence for  $G$ , our algorithm  
24 runs in time  $f(d, |\phi|) \cdot |D|$  where  $f$  is a computable but non-elementary function. We also prove  
25 that bounded twin-width is preserved by FO interpretations and transductions (allowing operations  
26 such as squaring or complementing a graph). This unifies and significantly extends the knowledge  
27 on fixed-parameter tractability of FO model checking on non-monotone classes, such as the FPT  
28 algorithm on bounded-width posets by Gajarský et al. [FOCS '15].

29 **2012 ACM Subject Classification** Theory of computation  $\rightarrow$  Graph algorithms analysis; Theory of  
30 computation  $\rightarrow$  Fixed parameter tractability

31 **Keywords and phrases** Twin-width, FO model checking, fixed-parameter tractability

## 32 **1** Introduction

33 Measuring how complex a class of structures is often depends on the context. Complexity  
34 can be related to algorithms (are computations easier on the class?), counting (how many  
35 structures exist per slice of the class?), size (can structures be encoded in a compact way?),  
36 decomposition (can structures be built with easy operations?), and so on. The most successful  
37 and central complexity invariants like treewidth and VC-dimension tick many of these boxes  
38 and, as such, stand as cornerstone notions in both discrete mathematics and computer  
39 science.

40 In 2014, Guillemot and Marx [22] solved a long-standing question by showing that  
41 detecting a fixed pattern in some input permutation can be done in linear time. This result  
42 came as a surprise: Many researchers thought the problem was  $W[1]$ -hard since all known  
43 techniques had failed so far. In their paper, Guillemot and Marx observed that their proof  
44 introduces a parameter and a dynamic programming scheme of a new kind and wondered  
45 whether a graph-theoretic generalization of their permutation parameter could exist.

46 The starting point of our paper is to answer that question positively, by generalizing their  
 47 width parameter to graphs and even matrices. This new notion, dubbed *twin-width*, proves  
 48 remarkably well connected to other areas of computer science, logic, and combinatorics. We  
 49 will show that graphs of bounded twin-width define a very natural class with respect to  
 50 computational complexity (FO model checking is linear), to model theory (they are stable  
 51 under first-order interpretations), to enumerative combinatorics (they form small classes [4]),  
 52 and to decomposition methods (as a generalization of both proper minor-closed and bounded  
 53 rank-width/cliq-width classes).

## 54 1.1 A dynamic generalization of cographs

55 When it comes to graph decompositions, arguably one of the simplest graph classes is the  
 56 class of *cographs*. Starting from a single vertex, cographs can be built by iterating disjoint  
 57 unions and complete sums. Another way to decompose cographs is to observe that they  
 58 always contain *twins*, that is two vertices  $u$  and  $v$  with the same neighborhood outside  $\{u, v\}$   
 59 (hence contracting  $u, v$  is equivalent to deleting  $u$ ). Cographs are then exactly graphs which  
 60 can be contracted to a single vertex by iterating contractions of twins. Generalizing the  
 61 decomposition by allowing more complex bipartitions provides the celebrated notions of  
 62 clique-width and rank-width, which extends treewidth to dense graphs. However, bounded  
 63 rank-width do not capture simple graphs such as unit interval graphs which have a simple  
 64 linear structure, and allow polynomial-time algorithms for various problems. Also, bounded  
 65 rank-width does not capture large 2-dimensional grids, on which we know how to design  
 66 FPT algorithms.

67 The goal of this paper is to propose a width parameter which is not only bounded on  
 68  $d$ -dimensional grids, proper minor-closed classes and bounded rank-width graphs, but also  
 69 provides a very versatile and simple scheme which can be applied to many structures, for  
 70 instance, patterns of permutations, hypergraphs, and posets. The idea is very simple: a  
 71 graph has bounded twin-width if it can be iteratively contracted to a singleton, where each  
 72 contracted pair consists of near-twins (two vertices whose neighborhoods differ only on a  
 73 bounded number of elements). The crucial ingredient to add to this simplified picture is to  
 74 keep track of the errors with another type of edges, that we call *red edges*, and to require  
 75 that the degree in red edges remains bounded by a threshold, say  $d$ .

76 In a nutshell (a more formal definition will be given in Section 3), we consider a sequence  
 77 of graphs  $G_n, G_{n-1}, \dots, G_2, G_1$ , where  $G_n$  is the original graph  $G$ ,  $G_1$  is the one-vertex  
 78 graph,  $G_i$  has  $i$  vertices, and  $G_{i-1}$  is obtained from  $G_i$  by performing a single contraction  
 79 of two (non-necessarily adjacent) vertices. For every vertex  $u \in V(G_i)$ , let us denote by  
 80  $u(G)$  the vertices of  $G$  which have been contracted to  $u$  along the sequence  $G_n, \dots, G_i$ . Two  
 81 disjoint sets of vertices are *homogeneous* if, between them, there are either all possible edges  
 82 or no edge at all. The red edges mentioned previously consist of all pairs  $uv$  of vertices of  
 83  $G_i$  such that  $u(G)$  and  $v(G)$  are not homogeneous in  $G$ . If the red degree of every  $G_i$  is at  
 84 most  $d$ , then  $G_n, G_{n-1}, \dots, G_2, G_1$  is called a *sequence of  $d$ -contractions*, or  *$d$ -sequence*. The  
 85 twin-width of  $G$  is the minimum  $d$  for which there exists a sequence of  $d$ -contractions. Hence,  
 86 graphs of twin-width 0 are exactly the cographs (since a red edge never appears along the  
 87 sequence when contracting twins). See Figure 1 for an illustration of a 2-sequence.

88 This basic definition proves to be extremely rich. The main algorithmic application  
 89 presented in this paper is the design of a linear-time FPT algorithm for FO model checking  
 90 on binary structures with bounded twin-width, provided a sequence of  $d$ -contractions is  
 91 given.

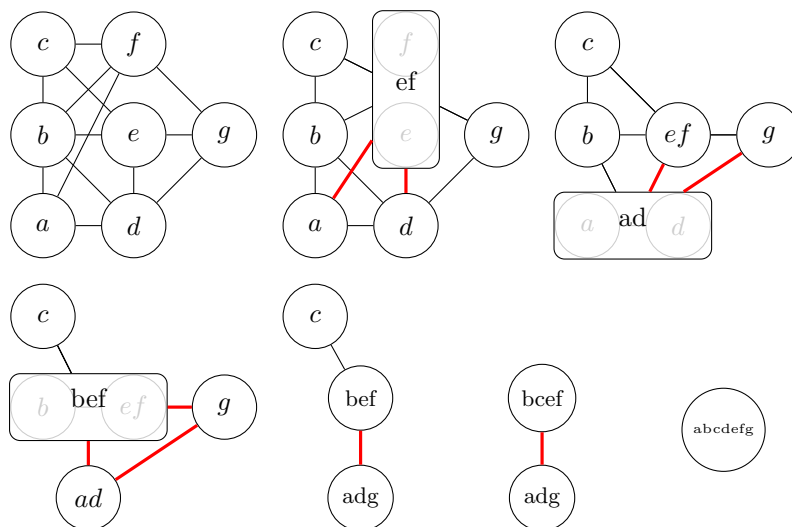

■ **Figure 1** A 2-sequence of contractions to a single vertex shows that the original graph has twin-width at most 2.

## 92 1.2 FO model checking

93 A natural algorithmic question given a graph class  $\mathcal{C}$  (i.e., a set of graphs closed under taking  
 94 induced subgraphs) is whether or not deciding first-order formulas  $\varphi$  on graphs  $G \in \mathcal{C}$  can  
 95 be done in time whose superpolynomial blow-up is a function of  $|\varphi|$  and  $\mathcal{C}$  only. A line of  
 96 works spanning two decades settled this question for monotone (that is, closed under taking  
 97 subgraphs) graph classes. It was shown that one can decide first-order (FO) formulas in  
 98 fixed-parameter time (FPT) in the formula size on bounded-degree graphs [30], planar graphs,  
 99 and more generally, graphs with locally bounded treewidth [13],  $H$ -minor free graphs [11],  
 100 locally  $H$ -minor free graphs [8], classes with (locally) bounded expansion [9], and finally  
 101 nowhere dense classes [21]. The latter result generalizes all previous ones, since nowhere  
 102 dense graphs contain all the aforementioned classes. Let us observe that the dependency on  
 103  $|V(G)|$  of the FPT model checking algorithm on classes with bounded expansion is linear  
 104 [9], while it is almost linear (i.e.,  $|V(G)|^{1+\varepsilon}$  for every  $\varepsilon > 0$ ) for nowhere dense classes [21].  
 105 In sharp contrast, if a monotone class  $\mathcal{C}$  is not nowhere dense then FO model checking on  
 106  $\mathcal{C}$  is AW[\*]-complete [24], hence highly unlikely to be FPT. Thus the result of Grohe et  
 107 al. [21] gives a final answer in the case of monotone classes. We refer the reader interested  
 108 in structural and algorithmic properties of nowhere dense classes to Nestril and Ossona de  
 109 Mendez's book [27].

110 Since then, the focus has shifted to the complexity of model checking on (dense) non-  
 111 monotone graph classes. Our main result is that FO model checking is FPT on classes with  
 112 bounded twin-width. More precisely, we show that:

113 ► **Theorem 1.** *Given an  $n$ -vertex (di)graph  $G$ , a sequence of  $d$ -contractions  $G = G_n, G_{n-1},$   
 114  $\dots, G_1 = K_1$ , and a first-order formula  $\varphi$ , we can decide  $G \models \varphi$  in time  $f(|\varphi|, d) \cdot n$  for  
 115 some computable, yet non-elementary, function  $f$ .*

116 This unifies and extends known FPT algorithms for

- 117 ■  $H$ -minor free graphs [11],
- 118 ■ posets of bounded width (i.e., size of the largest antichain) [15],

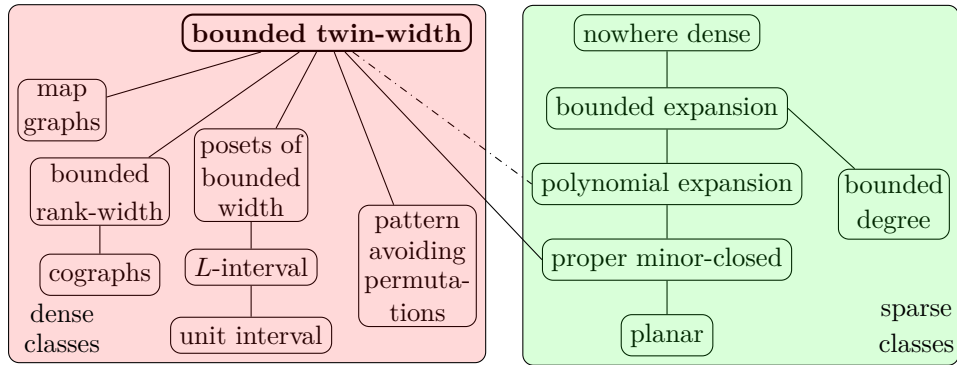

■ **Figure 2** Hasse diagram of classes on which FO model checking is FPT, with the newcomer twin-width. The dash-dotted edge means that polynomial expansion may well be included in bounded twin-width. Bounded twin-width and nowhere dense classes roughly subsume all the current knowledge on the fixed-parameter tractability of FO model checking. Do they admit a natural common superclass still admitting an FPT algorithm for FO model checking?

119 ■ permutations avoiding a fixed pattern [22]<sup>1</sup> and proper subclass of permutation graphs,  
 120 ■ bounded rank-width or bounded clique-width [7],<sup>2</sup>  
 121 since we will establish that these classes have bounded twin-width, and that, on them, a  
 122 sequence of  $d$ -contractions can be found efficiently. By transitivity, this also generalizes the  
 123 FPT algorithm for  $L$ -interval graphs [20], and may shed a new unified light on geometric  
 124 graph classes for which FO model checking is FPT [23]. In that direction we show that a  
 125 large class of geometric intersection graphs with bounded clique number, including  $K_t$ -free  
 126 unit  $d$ -dimensional ball graphs, admits such an algorithm. We also show that map graphs  
 127 have bounded twin-width but we only provide a  $d$ -contraction sequence when the input comes  
 128 with a planar embedding of the map. FO model checking was proven FPT on map graphs  
 129 even when no geometric embedding is provided [10]. See Figure 2 for the Hasse diagram of  
 130 classes with a fixed-parameter tractable FO model checking.

131 Permutation patterns can be represented as posets of dimension 2. Then any proper  
 132 (hereditary) subclass of posets of dimension 2 contains all permutations avoiding a fixed  
 133 pattern. Posets can in turn be encoded by directed graphs (or digraphs). Thus we formulated  
 134 Theorem 1 with graphs and digraphs, to cover all the classes of bounded twin-width listed  
 135 after the theorem. Twin-width and the applicability of Theorem 1 is actually broader: one  
 136 may replace “an  $n$ -vertex (di)graph  $G$ ” by “a binary structure  $G$  on a domain of size  $n$ ” in  
 137 the statement of the theorem, where a binary structure is a finite set of binary relations.

138 Let us observe that the non-elementary dependence of the function  $f$  of Theorem 1 in  
 139 the formula size  $|\varphi|$  and the twin-width  $d$  is very likely to be necessary. Indeed Frick and  
 140 Grohe [14] show that any FPT algorithm for FO model checking on trees (which we will see  
 141 have twin-width 2) requires a non-elementary dependence in the formula size, unless  $\text{FPT} =$   
 142  $\text{AW}[*]$ . Let us also mention that we cannot expect polynomial kernels of size  $(d+k)^{O(1)}$  on  
 143 graphs of twin-width at most  $d$  for FO model checking of formulas of size  $k$ , actually even for  
 144  $k$ -INDEPENDENT SET. Indeed we will see that twin-width is invariant by complementation

<sup>1</sup> Guillemot and Marx show that PERMUTATION PATTERN (not FO model checking in general) is FPT when the host permutation avoids a pattern, then a win-win argument proper to PERMUTATION PATTERN allows them to achieve an FPT algorithm for the class of *all* permutations.

<sup>2</sup> for this class, even deciding  $\text{MSO}_1$  is FPT, which is something that we do not capture.

145 and disjoint unions. More precisely, the complete sum of  $t$  graphs  $G_1, \dots, G_t$  of twin-width  
 146 at most  $d$  has twin-width at most  $d$ . So the complete sum of  $t$  instances of the NP-hard  
 147 problem MAX INDEPENDENT SET on graphs of twin-width  $d$  is an OR-composition (that  
 148 preserves the parameter  $d + k$ ). MAX INDEPENDENT SET is indeed NP-hard on graphs of  
 149 twin-width  $d$ , for a sufficiently large fixed value of  $d$ , since we will see that planar graphs have  
 150 constant twin-width. Therefore a polynomial kernel would imply the unlikely containment  
 151  $\text{NP} \subseteq \text{co-NP/poly}$  [3].

## 152 Roadmap for the proof of Theorem 1.

153 Instead of deciding “ $G \models \varphi$ ” for a specific formula  $\varphi$ , we build in FPT time a tree  $MT'_\ell(G)$   
 154 which contains enough information to answer all the queries of the form *is  $\phi$  true on  $G$ ?*,  
 155 for every prenex sentence  $\phi$  on  $\ell$  variables. A prenex sentence  $\phi$  starts with a quantification  
 156 (existential and universal) over the  $\ell$  variables, followed, in the case of graphs, by a Boolean  
 157 combination  $\phi'(x_1, \dots, x_\ell)$  of atoms of the form  $x = y$  (interpreted as: vertex  $x$  is vertex  $y$ )  
 158 and  $E(x, y)$  (interpreted as: there is an edge between  $x$  and  $y$ ). A simple but important  
 159 insight is that once Existential and Universal players have chosen the assignment  $v_1, \dots, v_\ell$ ,  
 160 the truth of  $\phi'(v_1, \dots, v_\ell)$  only depends on the induced subgraph  $G[\{v_1, \dots, v_\ell\}]$  and the  
 161 pattern of equality classes of the tuple  $(v_1, \dots, v_\ell)$ . Indeed the latter pair carries the truth  
 162 value of each possible atom.

163 Imagine now the complete tree  $MT_\ell(G)$  of all the possible “moves” assigning vertex  $v_i$  to  
 164 variable  $x_i$ . This tree, called *morphism-tree*, has arity  $|V(G)|$  and depth  $\ell$ . Thus  $MT_\ell(G)$  is  
 165 too large to be explicitly computed. However, up to labeling its different levels with  $\exists$  and  $\forall$ ,  
 166 it trivially contains what is needed to evaluate any  $\ell$ -variable prenex formula on  $G$ . In light of  
 167 the previous paragraph,  $MT_\ell(G)$  contains way too much information. Assume, for instance,  
 168 that two of its leaves  $v_\ell, v'_\ell$  with the same parent node define the same induced subgraph  
 169  $G[\{v_1, \dots, v_{\ell-1}, v_\ell\}] \cong G[\{v_1, \dots, v_{\ell-1}, v'_\ell\}]$  and the same pattern of equality classes. Then it  
 170 is safe to delete the “move  $v'_\ell$ ” from the possibilities of whichever player shall play at level  $\ell$ .  
 171 Indeed “move  $v_\ell$ ” is perfectly equivalent: As it sets to true the same list of atoms, it will  
 172 satisfy the exact same formulas  $\phi'$ , irrelevant of the nature of the quantifier preceding  $x_\ell$ .  
 173 We generalize this notion to any pair of sibling nodes at any level of the morphism-tree, and  
 174 we call *reduction* a morphism-tree obtained after removing equivalent sibling nodes (and  
 175 their subtree). It can be observed that a *reduct*, that is, a reduction that cannot be reduced  
 176 further, has size bounded by  $\ell$  only. Thus it all boils down to computing a reduct  $MT'_\ell(G)$   
 177 in FPT time.

178 Now the contraction sequence comes in. Actually, more convenient here than the  
 179 successive graphs  $G = G_n, G_{n-1}, \dots, G_1$ , we consider the equivalent partition sequence:  
 180  $\mathcal{P}_n, \mathcal{P}_{n-1}, \dots, \mathcal{P}_1$ , where  $\mathcal{P}_i$  is the partition of  $V(G)$  whose parts correspond to the vertices of  
 181  $V(G_i)$  ( $v(G) \in \mathcal{P}_i$  is the set of all the vertices of  $V(G)$  contracted to form  $v \in V(G_i)$ ). Recall  
 182 that two parts of  $\mathcal{P}_i$  are *homogeneous* if they are fully adjacent or fully non-adjacent in  $G$ .  
 183 Let  $G_{\mathcal{P}_i}$  be the graph whose vertices are the parts of  $\mathcal{P}_i$ , and edges link every pair of non-  
 184 homogeneous parts. It corresponds to the red edges of  $G_i$ . We also extend morphism-trees  
 185 to partitioned graphs:  $MT_\ell(G, \mathcal{P}_i)$  denotes the morphism-tree  $MT_\ell(G)$  where reductions are  
 186 only allowed between two vertices of the same part of  $\mathcal{P}_i$ . And for  $X \in \mathcal{P}_i$ ,  $MT_\ell(G, \mathcal{P}_i, X)$  is  
 187 the morphism-tree  $MT_\ell(G, \mathcal{P}_i)$  restricted to parts of  $\mathcal{P}_i$  in the relatively close neighborhood  
 188 of  $X$ . Again  $MT'_\ell(G, \mathcal{P}_i, X)$  denotes the reduct of  $MT_\ell(G, \mathcal{P}_i, X)$ .

189 By dynamic programming, we will maintain for  $i$  going from  $n$  down to 1, reducts  
 190  $MT'_\ell(G, \mathcal{P}_i, X_j)$  for every  $X_j \in \mathcal{P}_i$ .  $\mathcal{P}_n$  is a partition into singletons  $\{v\}$  (for each  $v \in V(G)$ ),  
 191 so we initialize the reducts to paths of length  $\ell$  labeled by  $v$ . Indeed all the variables can only

192 be instantiated to  $v$ , so the associated morphism tree has out-degree 1; hence is a path.  $\mathcal{P}_1$  is  
 193 the trivial partition  $\{V(G)\}$ , so the eventually computed reduct  $MT'_\ell(G, \{V(G)\}, V(G))$  is  
 194 exactly the reduct  $MT'_\ell(G)$  that we were looking for. Say that, to go from  $\mathcal{P}_{i+1}$  to  $\mathcal{P}_i$ , we fuse  
 195 two sets  $X'_i, X''_i$  into  $X_i$ . We shall now update the reducts  $MT'_\ell(G, \mathcal{P}_i, X_j)$  for every  $X_j \in \mathcal{P}_i$ ,  
 196 being given the reducts  $MT'_\ell(G, \mathcal{P}_{i+1}, X_j)$  for every  $X_j \in \mathcal{P}_{i+1}$ . For parts  $X_j$  at distance  
 197 more<sup>3</sup> than  $3^\ell$  of  $X_i$  in  $G_{\mathcal{P}_i}$ , nothing happens: we set  $MT'_\ell(G, \mathcal{P}_i, X_j) := MT'_\ell(G, \mathcal{P}_{i+1}, X_j)$ .  
 198 The value  $3^\ell$  is chosen so that two parts  $Y, Y'$  further apart than this threshold cannot  
 199 “interact” via non-homogeneous pairs of parts. This implies that the choice of a precise vertex  
 200 in  $Y$  does not affect in any way the choice of a precise vertex in  $Y'$ .

201 We therefore focus on the at most  $d^{3^\ell+1}$  parts (this is where the bound  $d$  on twin-width  
 202 comes into play) of  $X_j$  at distance at most  $3^\ell$  of  $X_i$  in  $G_{\mathcal{P}_i}$ . We first combine, by a so-called  
 203 *shuffle* operation, a bounded number of  $MT'_\ell(G, \mathcal{P}_{i+1}, Y)$  for  $Y \in \mathcal{P}_{i+1}$  sufficiently close  
 204 to  $X_i$  in  $G_{\mathcal{P}_i}$ , then strategically prune redundant nodes, and reduce further the obtained  
 205 morphism-tree  $(T, m)$ . The aggregation of the two former steps is dubbed *pruned shuffle*  
 206 and is the central operation of our algorithm. To define  $MT'_\ell(G, \mathcal{P}_i, X_j)$  we finally *project*  
 207 (or prune further)  $(T, m)$  on the nodes that are inherently *rooted at*  $X_j$ . To be formalized  
 208 the latter requires to introduce an auxiliary graph, called *tuple graph*, and a notion of *local*  
 209 *root*. These objects are instrumental in handling overlap or redundant information.

210 A crucial aspect of the algorithm relies on the following fact. If two connected components,  
 211 say  $X$  and  $Y$ , of  $G_{\mathcal{P}_{i+1}}$  are united in  $G_{\mathcal{P}_i}$ , then reductions of morphism-trees on  $X' \cup Y'$  with  
 212  $X' \subseteq X$  and  $Y' \subseteq Y$  are obtained by just interleaving (actually *shuffling*)  $MT'_\ell(G, \mathcal{P}_{i+1}, X')$   
 213 and  $MT'_\ell(G, \mathcal{P}_{i+1}, Y')$ . Indeed  $X'$  and  $Y'$  are by construction homogeneous to each other,  
 214 so the precise choices of vertices in  $X'$  and in  $Y'$  are totally independent. We can finally  
 215 observe that at each step  $i$ , we are updating a bounded number of reducts of bounded size.  
 216 Therefore the overall algorithm takes linear FPT time (see bottom part of Figure 3).

217 Although the use of the red graph is reminiscent of Gaifman’s locality theorem, or  
 218 extensions of this theorem, we do not rely on any classic from the logic toolbox (apart from  
 219 the prenex normal form). Therefore our algorithm and its presentation in Section 7 are  
 220 self-contained. We take a very combinatorial stance towards FO model checking. Formulas  
 221 are quickly converted into trees whose nodes are naturally mapped to subgraphs induced by  
 222 tuples. That way, our proof only deals with elementary mathematical objects such as tree  
 223 isomorphisms and auxiliary graphs. We thus hope that this novel way of solving FO model  
 224 checking is at the same time broadly accessible and could, in its first opening steps, help  
 225 outside of bounded twin-width.

### 226 1.3 How to compute the contraction sequences?

227 Given an arbitrary graph or binary structure, it seems tremendously hard to compute a  
 228 good –let alone, optimum– contraction sequence. Fortunately on classes with bounded  
 229 twin-width, for which this endeavor is algorithmically useful (in light of Theorem 1), we can  
 230 often exploit structural properties of the class to achieve our goal. In Section 4 we present a  
 231 simple polynomial-time algorithm outputting a  $(2^{k+1} - 1)$ -contraction sequence on graphs of  
 232 boolean-width at most  $k$  (see Theorem 3) and a linear-time algorithm for a  $3d$ -contraction  
 233 sequence of (subgraphs of) the  $d$ -dimensional grid of side-length  $n$  (see Theorem 4). The  
 234 bottleneck for the former algorithm would lie in finding the boolean-width decomposition in

<sup>3</sup> More than  $c^\ell$  with any fixed constant  $c > 2$  would work, since we will only use the fact that  $2 \cdot c^\ell < c^{\ell+1}$ . We choose  $c = 3$  for simplicity.



235 the first place. The latter result enables to find in polynomial time  $(3\lceil\sqrt{d}\rceil)^dk$ -contraction  
 236 sequences for unit  $d$ -dimensional ball graphs with clique number  $k$ , provided the geometric  
 237 representation is given.

238 For other classes, such as planar graphs, directly finding the sequence proves challenging.  
 239 Therefore we design in Section 5 a framework that reduces this task to finding an ordering  $\sigma$   
 240 –later called *mixed-free order*– of the  $n$  vertices such that the adjacency matrix  $A$  written  
 241 compliantly to  $\sigma$  is simple. Here by “simple” we mean that  $A$  cannot be divided into a  
 242 large number of blocks of consecutive rows and columns, such that no cell of the division is  
 243 vertical (repetition of the same row subvector) or horizontal (repetition of the same column  
 244 subvector). An important local object to handle this type of division is the notion of *corner*,  
 245 namely a consecutive 2-by-2 submatrix which is neither horizontal nor vertical. The principal  
 246 ingredient to show that simple matrices have bounded twin-width is the use of a theorem  
 247 by Marcus and Tardos [26] which states that  $n \times n$  0,1-matrices with at least  $cn$  1 entries  
 248 (for a large enough constant  $c$ ) admit large divisions with at least one 1 entry in each cell.  
 249 This result is at the core of Guillemot and Marx’s algorithm [22] to solve PERMUTATION  
 250 PATTERN in linear FPT time. As we now apply Marcus-Tardos theorem to the corners (and  
 251 not the 1 entries), we bring this engine to the dense setting. Indeed the matrix can be packed  
 252 with 1 entries, and yet we learn something non-trivial from the number of corners.

253 By Marcus-Tardos theorem the number of corners cannot be too large, otherwise the  
 254 matrix would not be simple. From this fact, we are eventually able to find two rows or  
 255 two columns with sufficiently small Hamming distance. Therefore they can be contracted.  
 256 Admittedly some technicalities are involved to preserve the simplicity of the matrix throughout  
 257 the contraction process. So we adopt a two-step algorithm: In the first step, we build a  
 258 sequence of partition coarsenings over the matrix, and in the second step, we extract the actual  
 259 sequence of contractions. The overall algorithm taking  $A$  (or  $\sigma$ ) as input, and outputting the  
 260 contraction sequence, takes polynomial time in  $n$ . It can be implemented in quadratic time,  
 261 or even faster if instead of the raw matrix, we get a list of pointers to corners of  $A$ .

262 We shall now find mixed-free orders. Section 6 is devoted to this task for three different  
 263 classes. Dealing with permutations avoiding a fixed pattern (equivalently, a proper subclass  
 264 of posets of dimension 2), the order is easy to find: it is imposed. For posets of bounded width  
 265 (that is, maximum size of an antichain or minimum size of a chain partition), a mixed-free  
 266 order is attained by putting the chains in increasing order, one after the other. Finally for  
 267  $K_t$ -minor free graphs, a hamiltonian path would provide a good order. As we cannot always  
 268 expect to find a hamiltonian path, we simulate it by a specific Lex-DFS. The top part of  
 269 Figure 3 provides a visual summary of this section.

## 270 1.4 How general are classes of bounded twin-width?

271 As announced in the previous section, we will show that proper minor-closed classes have  
 272 bounded twin-width. As far as we know, all classes of polynomial expansion may also have  
 273 bounded twinwidth. However on the one hand, as we will show in an upcoming paper [4],  
 274 cubic graphs have unbounded twin-width, whereas on the other hand, cliques have twin-  
 275 width 0. Thus bounded twin-width is incomparable with bounded degree, bounded expansion,  
 276 and nowhere denseness.

277 Nowhere dense classes are *stable*, that is, no arbitrarily-long total order can be first-  
 278 order interpreted from graphs of this class. In particular, unit interval graphs are not FO  
 279 interpretations (even FO *transductions*, where in addition copying the structure and *coloring*  
 280 it with a constant number of unary relations is allowed) of nowhere dense graphs. Thus even  
 281 any class of first-order transductions of nowhere dense graphs, called *structurally nowhere*



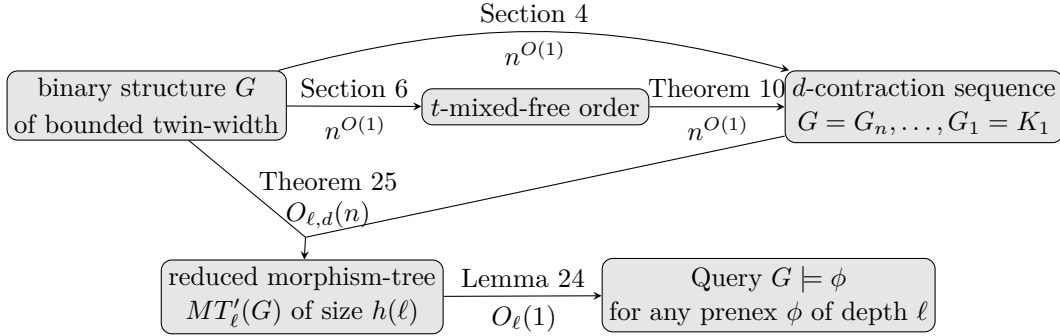

■ **Figure 3** The overall workflow. Two paths are possible to get a  $d$ -contraction sequence from a bounded twin-width structure  $G$ . Either a direct polytime algorithm as for bounded boolean-width, or via a domain-ordering yielding a  $t$ -mixed free matrix followed by Theorem 10 which converts it into a  $d$ -contraction sequence. From there, a tree of constant size (function of  $\ell$  only) can be computed in linear FPT time. This tree captures the evaluation of all prenex sentences  $\phi$  on  $\ell$  variables for  $G$ . Queries “ $G \models \phi$ ” can then be answered in constant time.

282 *dense*, is incomparable with bounded twin-width graphs. There have been recent efforts  
 283 aiming to eventually show that FO model checking is fixed-parameter tractable on any  
 284 structurally nowhere dense class. Gajarský et al. [16] introduce near-uniform classes based  
 285 on a so-called near- $k$ -twin relation, and the equivalent near-covered classes. They show that  
 286 FO model checking admits an FPT algorithm on near-covered classes, and that these classes  
 287 correspond to FO interpretations (even transductions) of bounded-degree graph classes. Let  
 288 us observe that the near- $k$ -twin relation, as well as the related neighborhood diversity [25],  
 289 can be thought as a static version of our twin-width. Gajarský et al. [19] gave the first step  
 290 towards an FPT algorithm on classes with structurally bounded expansion by characterizing  
 291 them via low shrub-depth decompositions. A second step was realized by Gajarský and  
 292 Kreutzer who presented a direct FPT algorithm computing shrub-depth decompositions [18].

293 We will show that bounded twin-width is preserved by FO interpretations and transduc-  
 294 tions, which makes it a robust class as far as first-order model checking is concerned. Despite  
 295 cubic graphs having unbounded twin-width, some particular classes with bounded degree,  
 296 such as subgraphs of  $d$ -dimensional grids, have bounded twin-width. More surprisingly, some  
 297 classes of expanders, will be shown to have bounded twin-width [4]. This showcases the  
 298 ubiquity of bounded twin-width, and the wide scope of Theorem 1. Even more so, when  
 299 in light of the previous paragraph, it implies that FO interpretations (such as elevating  
 300 the graph to a bounded power) of these classes keep the twin-width bounded. As we will  
 301 generalize twin-width to matrices, in order to handle permutations, posets, and digraphs, we  
 302 can potentially define a twin-width notion on hypergraphs, groups, and lattices.

## 303 1.5 Organization of the paper

304 Section 2 gives the necessary graph-theoretic and logic background. In Section 3 we formally  
 305 introduce contraction sequences and the twin-width of a graph. In Section 4 we get familiar  
 306 with these new notions. In particular we show with direct arguments that bounded rank-  
 307 width graphs,  $d$ -dimensional grids, and unit  $d$ -dimensional ball graphs with bounded clique  
 308 number, have bounded twin-width. In Section 5 we extend twin-width to matrices and show  
 309 a grid-minor-like theorem, which informally states that a graph has large twin-width if and  
 310 only if all its vertex orderings yield an adjacency matrix with a complex large submatrix.

311 This turns out to be a useful characterization for the next section. In Section 6 we show  
 312 how, thanks to this characterization, we can compute a witness of bounded twin-width, for  
 313 permutations avoiding a fixed pattern, comparability graphs with bounded independence  
 314 number (equivalently, bounded-width posets), and  $K_t$ -minor free graphs. In Section 7 we  
 315 present a linear-time FPT algorithm for FO model checking on graphs given with a witness  
 316 of bounded twin-width. In Section 8 we show that FO interpretations (even transductions)  
 317 of classes of bounded twin-width still have bounded twin-width. Finally in Section 9 we list  
 318 a handful of promising questions left for future work.

319 A quick walk through the paper may consist of reading Sections 3 and 7 for the basic  
 320 definitions and how bounded twin-width allows to efficiently solve FO model checking. This  
 321 may be followed by reading Sections 4 to 6 for some examples of classes with bounded twin-  
 322 width and how to compute on these classes the contraction sequences (witness of bounded  
 323 twin-width) necessary for the efficient FO model checking.

## 324 2 Preliminaries

325 We denote by  $[i, j]$  the set of integers  $\{i, i + 1, \dots, j - 1, j\}$ , and by  $[i]$  the set of integers  $[1, i]$ .  
 326 If  $\mathcal{X}$  is a set of sets, we denote by  $\cup \mathcal{X}$  the union of them.

### 327 2.1 Graph definitions and notations

328 All our graphs are undirected and simple (no multiple edge nor self-loop). We denote by  
 329  $V(G)$ , respectively  $E(G)$ , the set of vertices, respectively of edges, of the graph  $G$ . For  
 330  $S \subseteq V(G)$ , we denote the *open neighborhood* (or simply *neighborhood*) of  $S$  by  $N_G(S)$ , i.e.,  
 331 the set of neighbors of  $S$  deprived of  $S$ , and the *closed neighborhood* of  $S$  by  $N_G[S]$ , i.e.,  
 332 the set  $N_G(S) \cup S$ . For singletons, we simplify  $N_G(\{v\})$  into  $N_G(v)$ , and  $N_G[\{v\}]$  into  
 333  $N_G[v]$ . We denote by  $G[S]$  the subgraph of  $G$  induced by  $S$ , and  $G - S := G[V(G) \setminus S]$ . For  
 334  $A, B \subseteq V(G)$ ,  $E(A, B)$  denotes the set of edges in  $E(G)$  with one endpoint in  $A$  and the  
 335 other one in  $B$ . Two distinct vertices  $u, v$  such that  $N(u) = N(v)$  are called *false twins*, and  
 336 *true twins* if  $N[u] = N[v]$ . In particular, true twins are adjacent. Two vertices are *twins* if  
 337 they are false twins or true twins. If  $G$  is an  $n$ -vertex graph and  $\sigma$  is a total ordering of  
 338  $V(G)$ , say,  $v_1, \dots, v_n$ , then  $A_\sigma(G)$  denotes the adjacency matrix of  $G$  in the order  $\sigma$ . Thus  
 339 the entry in the  $i$ -th row and  $j$ -th column is a 1 if  $v_i v_j \in E(G)$  and a 0 otherwise.

340 The length of a path in an unweighted graph is simply the number of edges of the path.  
 341 For two vertices  $u, v \in V(G)$ , we denote by  $d_G(u, v)$ , the distance between  $u$  and  $v$  in  $G$ , that  
 342 is the length of the shortest path between  $u$  and  $v$ . The diameter of a graph is the longest  
 343 distance between a pair of its vertices. In all the above notations with a subscript, we omit  
 344 it whenever the graph is implicit from the context.

345 An *edge contraction* of two adjacent vertices  $u, v$  consists of merging  $u$  and  $v$  into a single  
 346 vertex adjacent to  $N(\{u, v\})$  (and deleting  $u$  and  $v$ ). A graph  $H$  is a *minor* of a graph  $G$  if  
 347  $H$  can be obtained from  $G$  by a sequence of vertex and edge deletions, and edge contractions.  
 348 A graph  $G$  is said  *$H$ -minor free* if  $H$  is not a minor of  $G$ . Importantly we will overload  
 349 the term “contraction”. In this paper, we call *contraction* the same as an edge contraction  
 350 without the requirement that the two vertices  $u$  and  $v$  are adjacent. This is sometimes called  
 351 an *identification*, but we stick to the shorter *contraction* since we will use that word often.  
 352 In the very rare cases in which we actually mean the classical (edge) contraction, the context  
 353 will lift the ambiguity. We will also somewhat overload the term “minor”. Indeed, in Section 5  
 354 we introduce the notions of “ $d$ -grid minor” and “ $d$ -mixed minor” on matrices. They are only  
 355 loosely related to (classical) graph minors, and it will always be clear which notion is meant.

356 **2.2 First-order logic, model checking, FO interpretations/transductions**

For our purposes, we define first-order logic without function symbols. A finite *relational signature* is a set  $\tau$  of relation (or *predicate*) symbols given with their arity  $\{R_{a_1}^1, \dots, R_{a_h}^h\}$ ; that is, relation  $R_{a_i}^i$  has arity  $a_i$ . A first-order formula  $\phi \in \text{FO}(\tau)$  over  $\tau$  is any string generated from letter  $\psi$  by the grammar:

$$\psi \rightarrow \exists x\psi, \forall x\psi, \psi \vee \psi, \psi \wedge \psi, \neg\psi, (\psi), R_{a_1}^1(x, \dots, x), \dots, R_{a_h}^h(x, \dots, x), x = x, \text{ and}$$

$$x \rightarrow x_1, x_2, \dots \text{ an infinite set of fresh variable labels.}$$

357 For the sake of simplicity, we will further impose that the same label cannot be reused  
 358 for two different variables. A variable  $x_i$  is then said *quantified* if it appears next to a  
 359 quantifier ( $\forall x_i$  or  $\exists x_i$ ), and *free* otherwise. We usually denote by  $\phi(x_{f_1}, \dots, x_{f_h})$  a formula  
 360 whose free variables are precisely  $x_{f_1}, \dots, x_{f_h}$ . A formula without quantified variables is said  
 361 *quantifier-free*. A *sentence* is a formula without free variables. With our simplification that  
 362 the same label is not used for two distinct variables, when a formula  $\phi$  contains a subformula  
 363  $Qx_i\phi'$  (with  $Q \in \{\exists, \forall\}$ ), all the occurrences of  $x_i$  in  $\phi$  lie in  $\phi'$ .

364 **Model checking.**

365 A first-order (FO) formula is purely syntactical. An *interpretation, model, or structure*  $\mathcal{M}$  of  
 366 the FO language  $\text{FO}(\tau)$  specifies a *domain of discourse*  $D$  for the variables, and a relation  
 367  $\mathcal{M}(R_{a_i}^i) = R^i \subseteq D^{a_i}$  for each symbol  $R_{a_i}^i$ .  $\mathcal{M}$  is sometimes called a  $\tau$ -*structure*.  $\mathcal{M}$  is a  
 368 *binary structure* if  $\tau$  has only relation symbols of arity 2. It is said *finite* if the domain  $D$   
 369 is finite. A sentence  $\phi$  interpreted by  $\mathcal{M}$  is *true*, denoted by  $\mathcal{M} \models \phi$ , if it evaluates to true  
 370 with the usual semantics for quantified Boolean logic, the equality, and  $R_{a_i}^i(d_1, \dots, d_{a_i})$  is  
 371 true if and only if  $(d_1, \dots, d_{a_i}) \in \mathcal{M}(R_{a_i}^i)$ . For a fixed interpretation, a formula  $\phi$  with free  
 372 variables  $x_{f_1}, \dots, x_{f_h}$  is *satisfiable* if  $\exists x_{f_1} \dots \exists x_{f_h} \phi$  is true.

373 In the FO model checking problem, given a first-order sentence  $\phi \in \text{FO}(\tau)$  and a finite  
 374 model  $\mathcal{M}$  of  $\text{FO}(\tau)$ , one has to decide whether  $\mathcal{M} \models \phi$  holds. The input size is  $|\phi| + |\mathcal{M}|$ ,  
 375 the number of bits necessary to encode the sentence  $\phi$  and the model  $\mathcal{M}$ . The brute-force  
 376 algorithm decides  $\mathcal{M} \models \phi$  in time  $|\mathcal{M}|^{|\phi|}$ , by building the tree of all possible assignments.  
 377 We will consider  $\phi$  to be fixed or rather small compared to  $|\mathcal{M}|$ . Therefore we wish to find  
 378 an FPT algorithm for FO model checking parameterized by  $|\phi|$ , that is, running in time  
 379  $f(|\phi|)|\mathcal{M}|^{O(1)}$ , or even better  $f(|\phi|)|D|$ .

FO( $\tau$ ) MODEL CHECKING

**Parameter:**  $|\phi|$

**Input:** A  $\tau$ -structure  $\mathcal{M}$  and a sentence  $\phi$  of  $\text{FO}(\tau)$ .

**Question:** Does  $\mathcal{M} \models \phi$  hold?

381 We restrict ourselves to FO model checking on finite binary structures, for which twin-  
 382 width will be eventually defined. For the most part, we will consider FO model check-  
 383 ing on graphs (and we may omit the signature  $\tau$ ). Let us give a simple example. Let  
 384  $\tau = \{E_2\}$  be a signature with a single binary relation. Finite models of the language  
 385  $\text{FO}(\tau)$  correspond to finite directed graphs with possible self-loops. Let  $\phi$  be the sentence  
 386  $\exists x_1 \exists x_2 \dots \exists x_k \bigwedge_{i < j} \neg(x_i = x_j) \wedge \bigwedge_{i \neq j} \neg E(x_i, x_j)$ . Let  $G$  be a  $\tau$ -structure or graph.  $G \models \phi$   
 387 holds if and if  $G$  has an independent set of size  $k$ . This particular problem parameterized  
 388 by  $|\phi|$  (or equivalently  $k$ ) is W[1]-hard on general graphs. However it may admit an FPT  
 389 algorithm when  $G$  belongs to a specific class of graphs, as in the case, for instance, of planar  
 390 graphs or bounded-degree graphs.

391 **FO interpretations and transductions.**

392 An FO interpretation of a  $\tau$ -structure  $\mathcal{M}$  is a  $\tau$ -structure  $\mathcal{M}'$  such that for every relation  
 393  $R$  of  $\mathcal{M}'$ ,  $R(a_1, \dots, a_h)$  is true if and only if  $\mathcal{M} \models \phi_R(a_1, \dots, a_h)$  for a fixed formula  
 394  $\phi_R(x_1, \dots, x_h) \in \text{FO}(\tau)$ . Informally every relation of  $\mathcal{M}'$  can be characterized by a formula  
 395 evaluated on  $\mathcal{M}$ .

396 Again we shall give some example on graphs since it is our main focus. Let  $G$  be a  
 397 simple undirected graph (in particular,  $E(x, y)$  holds whenever  $E(y, x)$  holds). Then the  
 398 FO ( $\phi$ -)interpretation  $I_\phi(G)$  is a graph  $H$  with vertex-set  $V(G)$  and  $uv \in E(H)$  if and  
 399 only if  $G \models \phi(x, y) \wedge \phi(y, x)$ . If for instance  $\phi(x, y)$  is the formula  $\neg E(x, y)$ , then  $I_\phi(G)$  is  
 400 the complement of  $G$ . If instead  $\phi(x, y)$  is  $E(x, y) \vee \exists z E(x, z) \wedge E(z, y)$ , then  $I_\phi(G)$  is the  
 401 square of  $G$ . The FO ( $\phi$ -)interpretation of a class  $\mathcal{C}$  of graphs is the set of all graphs that  
 402 are  $\phi$ -interpretations of graphs in  $\mathcal{C}$ , namely  $I_\phi(\mathcal{C}) := \{H \mid H = I_\phi(G), G \in \mathcal{C}\}$ . It is not  
 403 very satisfactory that  $I_\phi(\mathcal{C})$  is not hereditary. We will therefore either close  $I_\phi(\mathcal{C})$  by taking  
 404 induced subgraphs, or use the more general notion of FO transductions (see for instance [2]).

405 An FO transduction is an enhanced FO interpretation. We give a simplified definition  
 406 for undirected graphs, but the same definition generalizes to general (binary) structures.  
 407 First a *basic FO transduction* is slightly more general than an FO interpretation. It is a  
 408 triple  $(\delta, \nu, \eta)$ , with 0, 1, and, 2 free variables respectively, which maps every graph  $G$  such  
 409 that  $G \models \delta$  to the graph  $(\{v \mid G \models \nu(v)\}, \{\{u, v\} \mid G \models \eta(u, v)\})$ . Before we apply the  
 410 basic FO transduction, we allow two operations: an expansion and a copy operation. An  
 411 *h-expansion* maps a graph  $G$  to the set of all the structures obtained by augmenting  $G$  with  
 412  $h$  unary relations  $U^1, \dots, U^h$ . A  $\gamma$ -*copy operation* maps a graph  $G$  to the disjoint union  
 413 of  $\gamma$  copies of  $G$ , say,  $G^1, \dots, G^\gamma$ , where  $V(G^j) = \{(v, j) \mid v \in V(G)\}$ . Moreover, it adds  
 414  $\gamma$  unary relations  $C_1, \dots, C_\gamma$ , and a binary relation  $\sim$ , where  $C_i(v)$  holds whenever  $v \in V(G^i)$   
 415 and  $(u, i) \sim (v, j)$  holds when  $u = v$ . Informally the unary relations indicate in which copy a  
 416 vertex is, while the binary relation  $\sim$  links the copies of a same vertex.

417 Now, the  $(\phi, \gamma, h)$ -*transduction*  $\mathcal{T}_{\phi, \gamma, h}(G)$  of a graph  $G$  is the set  $\tau \circ \gamma_{\text{op}} \circ h_{\text{op}}(G)$  where  $h_{\text{op}}$   
 418 is the  $h$ -expansion,  $\gamma_{\text{op}}$  is the  $\gamma$ -copy operation, and  $\tau = (\delta, \nu, \eta)$  is a basic FO transduction.  
 419 Note that the formulas  $\nu$  and  $\eta$  may depend on the edge relation of  $G$  as well as all the  
 420 added unary relations and the binary relation  $\sim$ . Similarly to FO interpretations of classes,  
 421 we define  $\mathcal{T}_{\phi, \gamma, h}(\mathcal{C}) := \{H \mid H \in \mathcal{T}_{\phi, \gamma, h}(G), G \in \mathcal{C}\}$ .

422 As we will see in Section 8, a worthwhile property of twin-width is that every FO  
 423 interpretation/transduction of a bounded twin-width class has bounded twin-width itself.

424 **3 Sequence of contractions and twin-width**

425 We say that two vertices  $u$  and  $v$  are *twins* if they have the same neighborhood outside  
 426  $\{u, v\}$ . A natural operation is to contract (or identify) them and try to iterate the process.  
 427 If this algorithm leads to a single vertex, the graph was initially a *cograph*. Many intractable  
 428 problems become easy on cographs. It is thus tempting to try and extend this tractability  
 429 to larger classes. One such example is the class of graphs with bounded clique-width (or  
 430 equivalently bounded rank-width) for which any problem expressible in  $\text{MSO}_1$  logic can be  
 431 solved in polynomial-time [7]. A perhaps more direct generalization (than defining clique-  
 432 width) would be to allow contractions of near twins, but the cumulative effect of the errors<sup>4</sup>  
 433 stands as a barrier to algorithm design.

<sup>4</sup> By *error* we informally refer to the elements in the (non-empty) symmetric difference in the neighborhoods of the contracted vertices.

434 An illuminating example is provided by a bipartite graph  $G$ , with bipartition  $(A, B)$ ,  
 435 such that for every subset  $X$  of  $A$  there is a vertex  $b \in B$  with neighborhood  $X$  in  $A$ . Surely  
 436  $G$  is complex enough so that we should not entertain any hope of solving a problem like,  
 437 say,  $k$ -DOMINATING SET significantly faster on any class containing  $G$  than on general  
 438 graphs. For one thing, graphs like  $G$  contain all the bipartite graphs as induced subgraphs.  
 439 Nonetheless  $G$  can be contracted to a single vertex by iterating contractions of vertices whose  
 440 neighborhoods differ on only one vertex. Indeed, consider  $a \in A$  and contract all pairs of  
 441 vertices of  $B$  differing exactly at  $a$ . Applying this process for every  $a \in A$ , we end up by  
 442 contracting the whole set  $B$ , and we can eventually contract  $A$ .

443 Thus the admissibility of a contraction sequence should not solely be based on the current  
 444 neighborhoods. The key idea is to keep track of the past errors in the contraction history  
 445 and always require all the vertices to be involved in only a limited number of mistakes. Say  
 446 the errors are carried by the edges, and an erroneous edge is recorded as *red*. Note that in  
 447 the previous contraction sequence of  $G$ , after contracting all pairs of vertices of  $B$  differing  
 448 at  $a$ , all the edges incident to  $a$  are red, and vertex  $a$  witnesses the non-admissibility of the  
 449 sequence. Let us now get more formal.

450 It appears, from the previous paragraphs, that the appropriate structure to define twin-  
 451 width is a graph in which some edges are colored red. A *trigraph* is a triple  $G = (V, E, R)$   
 452 where  $E$  and  $R$  are two disjoint sets of edges on  $V$ : the (usual) edges and the *red edges*.  
 453 An informal interpretation of a red edge  $uv \in R$  is that some errors have been made while  
 454 handling  $G$  and the existence of an edge between  $u$  and  $v$ , or lack thereof, is uncertain.  
 455 A trigraph  $(V, E, R)$  such that  $(V, R)$  has maximum degree at most  $d$  is a  $d$ -*trigraph*. We  
 456 observe that any graph  $(V, E)$  may be interpreted as the trigraph  $(V, E, \emptyset)$ .

457 Given a trigraph  $G = (V, E, R)$  and two vertices  $u, v$  in  $V$ , we define the trigraph  
 458  $G/u, v = (V', E', R')$  obtained by *contracting*<sup>5</sup>  $u, v$  into a new vertex  $w$  as the trigraph on  
 459 vertex-set  $V' = (V \setminus \{u, v\}) \cup \{w\}$  such that  $G - \{u, v\} = (G/u, v) - \{w\}$  and with the  
 460 following edges incident to  $w$ :

- 461 ■  $wx \in E'$  if and only if  $ux \in E$  and  $vx \in E$ ,
- 462 ■  $wx \notin E' \cup R'$  if and only if  $ux \notin E \cup R$  and  $vx \notin E \cup R$ , and
- 463 ■  $wx \in R'$  otherwise.

464 In other words, when contracting two vertices  $u, v$ , red edges stay red, and red edges are  
 465 created for every vertex  $x$  which is not joined to  $u$  and  $v$  at the same time. We say that  
 466  $G/u, v$  is a *contraction* of  $G$ . If both  $G$  and  $G/u, v$  are  $d$ -trigraphs,  $G/u, v$  is a  $d$ -*contraction*.  
 467 We may denote by  $V(G)$  the vertex-set,  $E(G)$  the set of *black* edges, and  $R(G)$  the set of *red*  
 468 edges, of the trigraph  $G$ .

469 A (tri)graph  $G$  on  $n$  vertices is  $d$ -*collapsible* if there exists a sequence of  $d$ -contractions  
 470 which contracts  $G$  to a single vertex. More precisely, there is a  $d$ -*sequence* of  $d$ -trigraphs  
 471  $G = G_n, G_{n-1}, \dots, G_2, G_1$  such that  $G_{i-1}$  is a contraction of  $G_i$  (hence  $G_1$  is the singleton  
 472 graph). See Figure 1 for an example of a sequence of 2-contractions of a 7-vertex graph. The  
 473 minimum  $d$  for which  $G$  is  $d$ -collapsible is the *twin-width* of  $G$ , denoted by  $\text{tw}(G)$ .

474 If  $v$  is a vertex of  $G_i$  and  $j \geq i$ , then  $v(G_j)$  denotes the subset of vertices of  $G_j$  eventually  
 475 contracted into  $v$  in  $G_i$ . Two disjoint vertex-subsets  $A, B$  of a trigraph are said *homogeneous* if  
 476 there is no red edge between  $A$  and  $B$ , and there are not both an edge and a non-edge between  
 477  $A$  and  $B$ . In other words,  $A$  and  $B$  are fully linked by black edges or there is no (black or  
 478 red) edge between them. Observe that in any contraction sequence  $G = G_n, \dots, G_i, \dots, G_1$ ,  
 479 there is a red edge between  $u$  and  $v$  in  $G_i$  if and only if  $u(G)$  and  $v(G)$  are not homogeneous.

---

<sup>5</sup> Or *identifying*. Let us insist that  $u$  and  $v$  do not have to be adjacent.

480 We may sometimes (abusively) identify a vertex  $v \in G_i$  with the subset of vertices of  $G$   
 481 contracted to form  $v$ .

482 One can check that cographs have twin-width 0 (the class of graphs with twin-width 0  
 483 actually coincides with cographs), paths of length at least three have twin-width 1, red paths  
 484 have twin-width at most 2, and trees have twin-width 2. Indeed, they are not 1-collapsible, as  
 485 exemplified by the 1-subdivision of  $K_{1,3}$ , and they admit the following 2-sequence. Choose an  
 486 arbitrary root and contract two leaves with the same neighbor, or, if not applicable, contract  
 487 the highest leaf with its neighbor. We observe that in this 2-sequence, every  $G_i$  only contains  
 488 red edges which are adjacent to leaves. In particular, red edges are either isolated or are  
 489 contained in a path of length two.

490 The definition of twin-width readily generalizes to directed graphs, where we create a red  
 491 edge whenever the contracted vertices  $u, v$  are not linked to  $x$  in the same way. This way we  
 492 may speak of the twin-width of a directed graph or of a partial order. One could also wish  
 493 to define twin-width on graphs “colored” by a constant number of unary relations. To have  
 494 a unifying framework, we will later work with matrices (Section 5). Before that, we present  
 495 in the next section some basic results about twin-width of graphs.

## 496 **4 First properties and examples of classes with bounded twin-width**

497 Let us get familiar with contraction sequences and twin-width through simple operations:  
 498 complementing the graph, taking induced subgraphs, and adding apices.

### 499 **4.1 Complementation, induced subgraphs, and adding apices**

500 The *complement* of a trigraph  $G$  is the trigraph  $\overline{G}$  obtained by keeping all its red edges  
 501 while making edges its non-edges, and non-edges its edges. Thus if  $G = (V, E, R)$ , then  
 502  $\overline{G} = (V, \binom{V}{2} \setminus (E \cup R), R)$ , and it holds that  $\overline{\overline{G}} = G$ . Twin-width is invariant under  
 503 complementation. One can observe that any sequence of  $d$ -contractions for  $G$  is also a  
 504 sequence of  $d$ -contractions for  $\overline{G}$ . Indeed there is a red edge between two vertices  $u, v$  in a  
 505 trigraph obtained along the sequence if and only if  $u(G)$  and  $v(G)$  are homogeneous if and  
 506 only if  $u(\overline{G})$  and  $v(\overline{G})$  are homogeneous.

507 We can extend the notion of induced subgraphs to trigraphs in a natural way. A trigraph  
 508  $H$  is an *induced subgraph* of a trigraph  $G$  if  $V(H) \subseteq V(G)$ ,  $E(H) = E(G) \cap \binom{H}{2}$ , and  
 509  $R(H) = R(G) \cap \binom{H}{2}$ . The twin-width of an induced subgraph  $H$  of a trigraph  $G$  is at most  
 510 the twin-width of  $G$ . Indeed the sequence of contractions for  $G$  can be projected to  $H$  by  
 511 just ignoring contractions involving vertices outside  $V(H)$ . Then the red degree of trigraphs  
 512 in the contraction sequence of  $H$  is at most the red degree of the corresponding trigraphs in  
 513 the contraction sequence of  $G$ .

514 We now show that adding a vertex linked by black edges to an arbitrary subset of the  
 515 vertices essentially at most doubles the twin-width.

516 **► Theorem 2.** *Let  $G'$  be a trigraph obtained from a trigraph  $G$  by adding one vertex  $v$  and*  
 517 *linking it with black edges to an arbitrary subset  $X \subseteq V(G)$ . Then  $\text{tw}(G') \leq 2(\text{tw}(G) + 1)$ .*

518 **Proof.** Let  $d = \text{tw}(G)$  and let  $G = G_n, \dots, G_1$  be a sequence of  $d$ -contractions. We want to  
 519 build a good sequence of contractions for  $G'$ . The rules are that, while there are more than  
 520 three vertices in the trigraph, we never contract two vertices  $u$  and  $u'$  such that  $u(G) \subseteq X$   
 521 and  $u'(G) \subseteq V(G) \setminus X$ , neither do we contract  $v$  with another vertex. In words, until the  
 522 very end, we do not touch  $v$ , and we do only contractions internal to  $X$  or to  $V(G) \setminus X$ .

523 We start with  $G'$ . For  $i$  ranging from  $n$  down to 2, let us denote by  $u_i, u'_i$  the  $d$ -contraction  
 524 performed from  $G_i$  to  $G_{i-1}$ . With our imposed rules, instead of having one set  $u_i(G)$  of  
 525 contracted vertices, we have two:  $U_{i,X} := u_i(G) \cap X$  and  $U_{i,\bar{X}} := u_i(G) \setminus X$ . Similarly we can  
 526 define the (potentially empty)  $U'_{i,X}$  and  $U'_{i,\bar{X}}$  based on  $u'_i(G)$ . Any of these sets, if non-empty,  
 527 corresponds to a currently contracted vertex, that we denote with the same label. In the  
 528 current trigraph obtained from  $G'$ , we contract  $U_{i,X}$  and  $U'_{i,X}$  if they both exist. Next we  
 529 contract  $U_{i,\bar{X}}$  and  $U'_{i,\bar{X}}$  (again if they both exist). This preserves our announced invariant,  
 530 and terminates with a 3-vertex trigraph made of  $v$ , all the vertices of  $X$  contracted in a single  
 531 vertex, all the vertices of  $V(G) \setminus X$  contracted in a single vertex. Observe that a 3-vertex  
 532 trigraph is 2-collapsible and  $2 \leq 2(\text{tw}(G) + 1)$ .

533 We shall finally justify that in the sequence of contractions built for  $G'$ , all the trigraphs  
 534 have red degree at most  $2(\text{tw}(G) + 1)$ . Before we simulate the contraction  $u_i, u'_i$ , each  
 535 contracted vertex  $u(G) \cap X$  (resp.  $u(G) \setminus X$ ) of  $G'$  has red degree at most  $2d + 1$ . Indeed  
 536  $u(G) \cap X$  (resp.  $u(G) \setminus X$ ) can only have red edges to vertices  $w(G) \cap X$  and  $w(G) \setminus X$  such  
 537 that  $w$  is a red neighbor of  $u$ , and to  $u(G) \setminus X$  (resp.  $u(G) \cap X$ ). After we contract (if they  
 538 exist)  $U_{i,X}$  and  $U'_{i,X}$ , the newly created vertex, say  $U$ , has red degree at most  $2d + 2$ . The  
 539  $+2$  accounts for  $U_{i,\bar{X}}$  and  $U'_{i,\bar{X}}$ . The red degree of  $U_{i,\bar{X}}$  and  $U'_{i,\bar{X}}$  is at most  $2d + 1$ , where  
 540 the  $+1$  accounts for  $U$ . All the other vertices have their red degree bounded by  $2d + 1$ . After  
 541 we also contract (if they exist)  $U_{i,\bar{X}}$  and  $U'_{i,\bar{X}}$ , all the vertices have degree at most  $2d + 1$ .  
 542 Overall the red degree never exceeds  $2d + 2 = 2(\text{tw}(G) + 1)$ . ◀

543 The previous result implies that bounded twin-width is preserved by adding a constant  
 544 number of apices. In Section 6 we will show a far-reaching generalization of this fact:  
 545  $H$ -minor free graphs have bounded twin-width. We will not have to resort to the graph  
 546 structure theorem. Now if we have a second look at the proof of Theorem 2, we showed  
 547 that twin-width does not arbitrarily increase when we add one or a constant number of  
 548 unary relations (in Section 5 we will formally define twin-width for graphs colored by unary  
 549 relations, and even for arbitrary matrices on a constant-size alphabet). Again we will see in  
 550 Section 8 a considerable generalization of that fact and of the conservation of twin-width by  
 551 complementation: bounded twin-width classes are closed by first-order transductions.

## 552 4.2 Bounded rank-width/clique-width, and $d$ -dimensional grids

553 We now show that bounded rank-width graphs and  $d$ -dimensional grids (with or without diag-  
 554 onals) have bounded twin-width. We transfer the twin-width boundedness of  $d$ -dimensional  
 555 grids with diagonals to unit  $d$ -dimensional ball graphs with bounded clique number.

556 A natural inquiry is to compare twin-width with the width measures designed for dense  
 557 graphs: rank-width  $\text{rw}$ , clique-width  $\text{cw}$ , module-width  $\text{modw}$ , and boolean-width  $\text{boolw}$ .  
 558 It is known that, for any graph  $G$ ,  $\text{boolw}(G) \leq \text{modw}(G) \leq \text{cw}(G) \leq 2^{\text{rw}(G)+1} - 1$  (see for  
 559 instance Chapter 4 of Vatshelle's PhD thesis [31]). It is thus sufficient to show that graphs  
 560 with bounded boolean-width have bounded twin-width, to establish that bounded twin-width  
 561 classes capture all these parameters.

562 Crucially twin-width does not capture bounded mim-width graphs (the actual definition  
 563 of mim-width is not important here, and thus omitted). This is but a fortunate fact, since  
 564 the main result of the paper is an FPT algorithm for FO model checking on any bounded  
 565 twin-width classes. Indeed, interval graphs have mim-width 1 [1] and do not admit an FPT  
 566 algorithm for FO model checking (see for instance [20]).

567 We briefly recall the definition of boolean-width. The *boolean-width* of a partition  $(A, B)$   
 568 of the vertex-set of a graph is the base-2 logarithm of the number of different neighborhoods



569 in  $B$  of subsets of vertices of  $A$  (or equivalently, of different neighborhoods in  $A$  of subset  
 570 of vertices of  $B$ ). A *decomposition tree of a graph  $G$*  is a binary tree<sup>6</sup>  $T$  whose leaves are  
 571 in one-to-one correspondence with  $V(G)$ . Each edge  $e$  of  $T$  naturally maps to a partition  
 572  $P_e = (A_e, B_e)$  of  $V(G)$ , where the two connected components of  $T - e$  contain the leaves  
 573 labeled by  $A_e$  and  $B_e$ , respectively. The *boolean-width* of a decomposition tree  $T$  is the  
 574 maximum boolean-width of  $P_e$  taken among every edge  $e$  of  $T$ . Finally, the *boolean-width* of  
 575 a graph  $G$ , denoted by  $\text{boolw}(G)$ , is the minimum boolean-width of  $T$  taken among every  
 576 decomposition tree  $T$ .

577 ► **Theorem 3.** *Every graph with boolean-width  $k$  has twin-width at most  $2^{k+1} - 1$ .*

578 **Proof.** Let  $G$  be graph and let  $T$  be a decomposition tree of  $G$  with boolean-width  $k :=$   
 579  $\text{boolw}(G)$ . We assume that  $G$  has at least  $2^k + 1$  vertices, otherwise the twin-width is  
 580 immediately bounded by  $2^k$ . Starting from the root  $r$  of  $T$ , we find a rooted subtree of  $T$   
 581 with at least  $2^k + 1$  and at most  $2^{k+1}$  leaves. If the current subtree has more than  $2^{k+1}$   
 582 leaves, we move to the child node with the larger subtree. That way we guarantee that the  
 583 new subtree has at least  $2^k + 1$  leaves. We stop when we reach a subtree  $T'$  with at most  
 584  $2^{k+1}$  leaves, and let  $e$  be the last edge that we followed in the process of finding  $T'$  (the one  
 585 whose removal disconnects  $T'$  from the rest of  $T$ ).

586 By definition, the boolean-width of the partition  $P_e = (A_e, B_e)$  is at most  $k$ , which  
 587 upperbounds the number of different neighborhoods of  $A_e$  in  $B_e$  by  $2^k$ . In particular, among  
 588 the  $2^k + 1$  leaves of  $T'$ , corresponding to, say,  $A_e$ , two vertices  $u, v$  have the same neighborhood  
 589 in  $B_e$ . We contract  $u$  and  $v$  in  $G$  (and obtain the graph  $G/u, v$ ). The only red edges in  
 590  $G/u, v$  are within  $A_e$ , so the red degree is bounded by  $2^{k+1} - 1$ . We update  $T$  by removing  
 591 the leaf labeled by  $v$ , and smoothing its parent node which became a degree-2 vertex (to  
 592 keep a binary tree). We denote by  $T/u, v$  the obtained binary decomposition tree of  $G/u, v$ .

593 What we described so far yielded the first contraction. We start over with trigraph  
 594  $G/u, v$  and decomposition tree  $T/u, v$  to find the second contraction. We iterate this process  
 595 until the current trigraph is a singleton. We claim that the built sequence of contractions  
 596 only contains trigraphs with red degree at most  $2^{k+1} - 1$ . The crucial invariant is that our  
 597 contractions never create a red component of size more than  $2^{k+1}$ . Hence the red degree  
 598 remains bounded by  $2^{k+1} - 1$ . ◀

599 The  *$d$ -dimensional  $n$ -grid* is the graph with vertex-set  $[n]^d$  with an edge between two  
 600 vertices  $(x_1, \dots, x_d)$  and  $(y_1, \dots, y_d)$  if and only if  $\sum_{i=1}^d |x_i - y_i| = 1$ . Equivalently the  
 601  $d$ -dimensional  $n$ -grid is the Cartesian product of  $d$  paths on  $n$  vertices, hence we write it  $P_n^d$ .  
 602 Thus the 1-dimensional  $n$ -grid is the path on  $n$  vertices  $P_n$ , while the 2-dimensional  $n$ -grid is  
 603 the usual (planar)  $n \times n$ -grid. While all the width parameters presented so far (including  
 604 mim-width) are unbounded on the  $n \times n$ -grid, twin-width remains constant even on the  
 605  $d$ -dimensional  $n$ -grid, for any fixed  $d$ .

606 ► **Theorem 4.** *For every positive integers  $d$  and  $n$ , the  $d$ -dimensional  $n$ -grid has twin-width  
 607 at most  $3d$ .*

608 **Proof.** Let  $R_n^d$  the trigraph with vertex-set  $V(P_n^d)$ , red edges  $E(P_n^d)$ , and no black edge. We  
 609 will prove, by induction on  $d$ , that  $R_n^d$  has twin-width at most  $3d$ . The base case ( $d = 1$ )  
 610 holds since, as observed in Section 3, the twin-width of a red path is at most 2. As all

<sup>6</sup> All internal nodes have degree 3, except the root which has degree 2. Equivalently all internal nodes have exactly two children.

611 the edges will be red (no black edge can appear), we allow ourselves the following abuse of  
 612 language. For this proof only, by *edge* (resp. *degree*) we mean *red edge* (resp. *red degree*). We  
 613 now assume that  $d > 1$ .

614 We see  $R_n^d$  as the Cartesian product of  $R_n^{d-1}$  and  $R_n^1 = R_n$ . In other words,  $V(R_n^d)$   
 615 can be partitioned into  $n$  sets  $V_1, \dots, V_n$ , where each  $V_i = \{v_1^i, \dots, v_{n^{d-1}}^i\}$  induces a trigraph  
 616 isomorphic to  $R_n^{d-1}$ , and there is an edge between  $v_j^i$  and  $v_j^{i+1}$  for all  $i \in [n-1], j \in [n^{d-1}]$ .  
 617 By induction hypothesis, there is a sequence of  $3(d-1)$ -contractions of  $P_n^{d-1}$ . The idea is  
 618 to follow this sequence in each  $V_i$  “in parallel”, i.e., performing the first contraction in  $V_1$ ,  
 619 then in  $V_2$ , up to  $V_n$ , then the second contraction in  $V_1$ , then in  $V_2$ , up to  $V_n$ , and so on. By  
 620 doing so, the following invariants are maintained:

- 621 ■ when performing a contraction in  $V_1$ , the newly created vertex has degree at most  $3d-3$   
 622 in  $V_1$ , and 2 in  $V_2$  (and 0 elsewhere), so  $3d-1$  in total.
- 623 ■ when performing a contraction in  $V_i, i \in \{2, \dots, n-1\}$ , the created vertex has degree  
 624 at most  $3d-3$  in  $V_i$ , 1 in  $V_{i-1}$  (since the same pair has been contracted in  $V_{i-1}$  at the  
 625 previous step) and 2 in  $V_{i+1}$  (and 0 elsewhere), so  $3d$  in total.
- 626 ■ when performing a contraction in  $V_n$ , the created vertex has degree at most  $3d-3$  in  $V_n$ ,  
 627 and at most one in  $V_{n-1}$  (and 0 elsewhere), so  $3d-2$  in total.

628 Furthermore every vertex not involved in the current contraction has degree at most  $3d-2$ :  
 629 Its degree within its own  $V_i$  is  $3d-3$  (by induction hypothesis) and it has exactly one neighbor  
 630 in  $V_{i-1}$  (if this set exists) and exactly one neighbor in  $V_{i+1}$  (if this set exists). When this  
 631 process terminates, each  $V_i$  has been contracted into a single vertex. Hence the current  
 632 trigraph is the red path  $R_n$ , which admits a sequence of 2-contractions. ◀

633 As we even showed that the twin-width of the red graph  $R_n^d$  is at most  $3d$ , it implies that  
 634 the twin-width of any subgraph of the  $d$ -dimensional  $n$ -grid is bounded by  $3d$ .

635 The  *$d$ -dimensional  $n$ -grid with diagonals* is the graph on  $[n]^d$  with an edge between two  
 636 distinct vertices  $(x_1, \dots, x_d)$  and  $(y_1, \dots, y_d)$  if and only if  $\max_{i=1}^d |x_i - y_i| \leq 1$ . We denote  
 637 this graph by  $\mathcal{K}_{n,d}$  and by,  $\mathcal{K}_{n,d}^r$  the trigraph  $([n]^d, \emptyset, E(\mathcal{K}_{n,d}))$  with only red edges. By  
 638 the arguments of Theorem 4, one can see that every subgraph of  $\mathcal{K}_{n,d}$  (even of  $\mathcal{K}_{n,d}^r$ ) has  
 639 twin-width bounded by a function of  $d$  (observe that  $\mathcal{K}_{n,d}^r$  has red degree at most  $3^d$ ).

640 ► **Lemma 5.** *Every subgraph of  $\mathcal{K}_{n,d}^r$  has twin-width at most  $2(3^d - 1)$ .*

641 This fact permits to bound the twin-width of unit  $d$ -dimensional ball graphs with bounded  
 642 clique number; actually even their subgraphs.

643 ► **Theorem 6.** *Every subgraph  $H$  of a unit  $d$ -dimensional ball graph  $G$  with clique number  $k$   
 644 has twin-width at most  $d' := (3\lceil\sqrt{d}\rceil)^d k$ . Furthermore if  $G$  comes with a geometric repres-  
 645 entation (i.e., coordinates for each vertex of  $G$  in a possible model), then a  $d'$ -contraction  
 646 sequence of  $H$  can be found in polynomial time.*

647 **Proof.** The result is immediate for  $k = 1$ , so we assume that  $k \geq 2$ . We even show the result  
 648 when all the edges of  $H$  are in fact red edges, by exhibiting a sequence of contractions which  
 649 keeps the (red) degree below  $d'$ . We draw a geometric regular  $d$ -dimensional fine grid on  
 650 top of the geometric representation of  $G$ . The spacing of the grid is  $2/\sqrt{d}$  so that a largest  
 651 diagonal of each hypercubic cell has length exactly 2. Hence the unit balls centered within a  
 652 given cell form a clique. In particular, each cell contains at most  $k$  centers. We also consider  
 653 the coarser tessellation where a *supercell* is a hypercube made of  $\lceil\sqrt{d}\rceil^d$  (smaller) cells. Hence  
 654 a supercell contains at most  $\lceil\sqrt{d}\rceil^d k$  centers.

655 We contract the vertices of each supercell into a single vertex. This can be done in any  
 656 order of the supercells, and in any order of the vertices within each supercell. Observe that,  
 657 throughout this process, the (red) degree does not exceed  $(3\lceil\sqrt{d}\rceil)^dk$ .

658 After these  $d'$ -contractions, the graph that we obtain is a subgraph of  $\mathcal{K}_{n,d}^r$ . Hence it  
 659 admits a  $2(3^d - 1)$ -sequence by Lemma 5. We conclude since  $2(3^d - 1) \leq (3\lceil\sqrt{d}\rceil)^dk$ . ◀

660 Of course the constructive result of Theorem 6 can be proved in greater generality. It would  
 661 work with any collection of objects where the ratio between the smallest (taken over the  
 662 objects) radius of a largest enclosed ball and the largest radius of a smallest enclosing ball  
 663 is bounded, as well as the clique number. In [4] we will see that unit disk graphs (with no  
 664 restriction on the clique number), as well as interval graphs and  $K_t$ -free unit segment graphs,  
 665 have unbounded twin-width.

## 666 5 The grid theorem for twin-width

667 In this section, we will deal with matrices instead of graphs. Our matrices have their entries  
 668 on a finite alphabet with a special additional value  $r$  (for red) representing errors made along  
 669 the computations. This is the analog of the red edges of the previous section.

### 670 5.1 Twin-width of matrices, digraphs, and binary structures

671 The *red number* of a matrix is the maximum number of red entries taken over all rows and  
 672 all columns. Given an  $n \times m$  matrix  $M$  and two columns  $C_i$  and  $C_j$ , the *contraction* of  
 673  $C_i$  and  $C_j$  is obtained by deleting  $C_j$  and replacing every entry  $m_{k,i}$  of  $C_i$  by  $r$  whenever  
 674  $m_{k,i} \neq m_{k,j}$ . The same contraction operation is defined for rows. A matrix  $M$  has *twin-width*  
 675 at most  $k$  if one can perform a sequence of contractions starting from  $M$  and ending in some  
 676  $1 \times 1$  matrix in such a way that all matrices occurring in the process have red number at  
 677 most  $k$ . Note that when  $M$  has twin-width at most  $k$ , one can reorder its rows and columns  
 678 in such a way that every contraction will identify consecutive rows or columns. The reordered  
 679 matrix is then called *k-twin-ordered*. The *symmetric twin-width* of an  $n \times n$  matrix  $M$  is  
 680 defined similarly, except that the contraction of rows  $i$  and  $j$  (resp. columns  $i$  and  $j$ ) is  
 681 immediately followed by the contraction of columns  $i$  and  $j$  (resp. rows  $i$  and  $j$ ).

682 We can now extend the twin-width to digraphs, which in particular capture posets.  
 683 Unsurprisingly the twin-width of a digraph is defined as the symmetric twin-width of its  
 684 adjacency matrix; only we write the adjacency matrix in a specific way. Say, the vertices  
 685 are labeled  $v_1, \dots, v_n$ . If there is an arc  $v_i v_j$  (but no arc  $v_j v_i$ ), we place a 1 entry in the  
 686  $i$ -th row  $j$ -column of the matrix and a -1 entry in the  $j$ -th row  $i$ -th column. If there are  
 687 two arcs  $v_i v_j$  and  $v_j v_i$ , we place a 2 entry in both the  $i$ -th row  $j$ -column and  $j$ -th row  $i$ -th  
 688 column. If there is no arc  $v_i v_j$  nor  $v_j v_i$ , we place a 0 entry in both the  $i$ -th row  $j$ -column  
 689 and  $j$ -th row  $i$ -th column. We then further extend twin-width to a binary structure  $S$  with  
 690 binary relations  $E^1, \dots, E^h$ . When building the adjacency matrix, the entry at  $v_i, v_j$  is now  
 691  $(e_1, \dots, e_h)$  where  $e_p \in \{-1, 0, 1, 2\}$  is chosen accordingly to the encoding of the “digraph  
 692  $E^p$ ”. Again the twin-width of a binary structure is the symmetric twin-width of the so-built  
 693 adjacency matrix.

694 We call *augmented binary structure* a binary structure augmented by a constant number  
 695 of unary relations. The twin-width is extended to *augmented binary structures* by seeing  
 696 unary relations as hard constraints. More concretely, contractions between two vertices  $u$   
 697 and  $v$  are only allowed if they are in the exact same unary relations. Formally, in a binary  
 698 structure  $G$  augmented by unary relations  $U_1, \dots, U_h$ , the contraction of  $u$  and  $v$  is only

699 possible when for every  $j \in [h]$ ,  $G \models U_j(u) \Leftrightarrow G \models U_j(v)$ . When this happens, the contracted  
700 vertex  $z$  inherits the unary relations containing  $u$  (or equivalently  $v$ ).

701 Contrary to the contraction sequence of a binary structure (without unary relations),  
702 we cannot expect the contraction sequence to end on a single vertex. Instead a sequence  
703 now ends when no pair of vertices are included in the same unary relations. When this  
704 eventually happens, the number of vertices is nevertheless bounded by the constant  $2^h$ . We  
705 could continue the contraction sequence arbitrarily, but, anticipating our use of augmented  
706 binary structures in Section 8, it is preferable to stop the sequence there.

707 By a straightforward generalization of the proof of Theorem 2, one can see that adding  
708  $h$  unary relations can at most multiply the twin-width by  $2^h$ .

709 ► **Lemma 7.** *The twin-width of a binary structure  $G$  augmented by  $h$  unary relations is at  
710 most  $2^h \cdot \text{tw}(G)$ .*

711 Given a total order  $\sigma$  on the domain of a binary structure  $G$ , we denote by  $A_\sigma(G)$  the  
712 adjacency matrix encoded accordingly to the previous paragraph and following the order  $\sigma$ .  
713 Denoting  $M := A_\sigma(G) = (m_{ij} = (e_1^{ij}, \dots, e_h^{ij}))_{i,j}$ , the matrix  $M$  satisfies the important  
714 following property, mixing symmetry and skew-symmetry. If  $e_p^{ij} \in \{0, 2\}$  then  $e_p^{ij} = e_p^{ji}$ ,  
715 and if  $e_p^{ij} \in \{-1, 1\}$  then  $e_p^{ij} = -e_p^{ji}$ . We call this property *mixed-symmetry* and  $M$  is said  
716 *mixed-symmetric*. This will be useful to find *symmetric* sequences of contractions.

## 717 5.2 Partition coarsening, contraction sequence, and error value

718 Here we present an equivalent way of seeing the twin-width with a successive coarsening of a  
719 partition, instead of explicitly performing the contractions with deletion.

720 A partition  $\mathcal{P}$  of a set  $S$  *refines* a partition  $\mathcal{P}'$  of  $S$  if every part of  $\mathcal{P}$  is contained in a part  
721 of  $\mathcal{P}'$ . Conversely we say that  $\mathcal{P}'$  is a coarsening of  $\mathcal{P}$ , or *contains*  $\mathcal{P}$ . When every part of  $\mathcal{P}'$   
722 contains at most  $k$  parts of  $\mathcal{P}$ , we say that  $\mathcal{P}$  *k-refines*  $\mathcal{P}'$ . Given a partition  $\mathcal{P}$  and two distinct  
723 parts  $P, P'$  of  $\mathcal{P}$ , the *contraction* of  $P$  and  $P'$  yields the partition  $\mathcal{P} \setminus \{P, P'\} \cup \{P \cup P'\}$ .

724 Given an  $n \times m$  matrix  $M$ , a *row-partition* (resp. *column-partition*) is a partition of the  
725 rows (resp. columns) of  $M$ . A  $(k, \ell)$ -*partition* (or simply *partition*) of a matrix  $M$  is a pair  
726  $(\mathcal{R} = \{R_1, \dots, R_k\}, \mathcal{C} = \{C_1, \dots, C_\ell\})$  where  $\mathcal{R}$  is a row-partition and  $\mathcal{C}$  is a column-partition.  
727 A *contraction* of a partition  $(\mathcal{R}, \mathcal{C})$  of a matrix  $M$  is obtained by performing one contraction  
728 in  $\mathcal{R}$  or in  $\mathcal{C}$ .

729 We distinguish two extreme partitions of an  $n \times m$  matrix  $M$ : the *finest partition* where  
730  $(\mathcal{R}, \mathcal{C})$  have size  $n$  and  $m$ , respectively, and the *coarsest partition* where they both have size  
731 one. The finest partition is sometimes called the *partition of singletons*, since all its parts are  
732 singletons, and the coarsest partition is sometimes called the *trivial partition*. A *contraction*  
733 *sequence* of an  $n \times m$  matrix  $M$  is a sequence of partitions  $(\mathcal{R}^1, \mathcal{C}^1), \dots, (\mathcal{R}^{n+m-1}, \mathcal{C}^{n+m-1})$   
734 where

- 735 ■  $(\mathcal{R}^1, \mathcal{C}^1)$  is the finest partition,
- 736 ■  $(\mathcal{R}^{n+m-1}, \mathcal{C}^{n+m-1})$  is the coarsest partition, and
- 737 ■ for every  $i \in [n + m - 2]$ ,  $(\mathcal{R}^{i+1}, \mathcal{C}^{i+1})$  is a contraction of  $(\mathcal{R}^i, \mathcal{C}^i)$ .

738 Given a subset  $R$  of rows and a subset  $C$  of columns in a matrix  $M$ , the *zone*  $R \cap C$   
739 denotes the submatrix of all entries of  $M$  at the intersection between a row of  $R$  and a  
740 column of  $C$ . A *zone* of a partition pair  $(\mathcal{R}, \mathcal{C}) = (\{R_1, \dots, R_k\}, \{C_1, \dots, C_\ell\})$  is any  $R_i \cap C_j$   
741 for  $i \in [k]$  and  $j \in [\ell]$ . A zone is *constant* if all its entries are identical. The *error value* of  $R_i$   
742 is the number of non constant zones among all zones in  $\{R_i \cap C_1, \dots, R_i \cap C_\ell\}$ . We adopt a

743 similar definition for the *error value* of  $C_j$ . The *error value* of  $(\mathcal{R}, \mathcal{C})$  is the maximum error  
 744 value taken over all  $R_i$  and  $C_j$ .

745 We can now restate the definition of twin-width of a matrix  $M$  as the minimum  $t$  for  
 746 which there exists a contraction sequence of  $M$  consisting of partitions with error value at  
 747 most  $t$ . The following easy technical lemma will be used later to upper bound twin-width.

748 ► **Lemma 8.** *If  $(\mathcal{R}^1, \mathcal{C}^1), \dots, (\mathcal{R}^s, \mathcal{C}^s)$  is a sequence of partitions of a matrix  $M$  such that:*  
 749 ■  $(\mathcal{R}^1, \mathcal{C}^1)$  *is the finest partition,*  
 750 ■  $(\mathcal{R}^s, \mathcal{C}^s)$  *is the coarsest partition,*  
 751 ■  $\mathcal{R}^i$  *r-refines  $\mathcal{R}^{i+1}$  and  $\mathcal{C}^i$  r-refines  $\mathcal{C}^{i+1}$ , and*  
 752 ■ *all  $(\mathcal{R}^i, \mathcal{C}^i)$  have error value at most  $t$ ,*  
 753 *then the twin-width of  $M$  is at most  $rt$ .*

754 **Proof.** We extend the sequence  $(\mathcal{R}^i, \mathcal{C}^i)$  into a contraction sequence by performing in any  
 755 order the contractions to go from every pair  $(\mathcal{R}^i, \mathcal{C}^i)$  to the next pair  $(\mathcal{R}^{i+1}, \mathcal{C}^{i+1})$ . A worst-  
 756 case argument gives that the error value cannot exceed  $rt$ . Indeed, assume that a partition  
 757  $(\mathcal{R}, \mathcal{C})$  contains  $(\mathcal{R}^i, \mathcal{C}^i)$  and refines  $(\mathcal{R}^{i+1}, \mathcal{C}^{i+1})$  and that  $R$  is a part of  $\mathcal{R}$ . Every part of  $\mathcal{C}$   
 758 is contained in a part of  $\mathcal{C}^{i+1}$  and every part of  $\mathcal{C}^{i+1}$  contains at most  $r$  parts of  $\mathcal{C}$ . Moreover,  
 759 at most  $t$  parts of  $\mathcal{C}^{i+1}$  form non-constant zones with  $R$ . Therefore, at most  $rt$  parts of  $\mathcal{C}$   
 760 form non-constant zones with  $R$ . ◀

### 761 5.3 Matrix division and Marcus-Tardos theorem

762 In a contraction sequence of a matrix  $M$ , one can always reorder the rows and the columns  
 763 of  $M$  in such a way that all parts of all partitions in the contraction sequence consist of  
 764 consecutive rows or consecutive columns. To mark this distinction, a *row-division* is a  
 765 row-partition where every part consists of consecutive rows; with the analogous definition for  
 766 *column-division*. A  $(k, \ell)$ -*division* (or simply *division*) of a matrix  $M$  is a pair  $(\mathcal{R}, \mathcal{C})$  of a  
 767 row-division and a column-division with respectively  $k$  and  $\ell$  parts. A *fusion* of a division is  
 768 obtained by contraction of two consecutive parts of  $\mathcal{R}$  or of  $\mathcal{C}$ . Fusions are just contractions  
 769 preserving divisions. A *division sequence* is a contraction sequence in which all partitions are  
 770 divisions.

771 We now turn to the fundamental tool which is basically only applied once but is the  
 772 cornerstone of twin-width. Given a 0,1-matrix  $M = (m_{i,j})$ , a *t-grid minor* in  $M$  is a  
 773  $(t, t)$ -division  $(\mathcal{R}, \mathcal{C})$  of  $M$  in which every zone contains a 1 (see left of Figure 4). We say that  
 774 a matrix is *t-grid free* if it does not have a *t-grid minor*. A celebrated result by Marcus and  
 775 Tardos [26] (henceforth *Marcus-Tardos theorem*) asserts that every 0,1-matrix with large  
 776 enough linear density has a *t-grid minor*. Precisely:

777 ► **Theorem 9** ([26]). *For every integer  $t$ , there is some  $c_t$  such that every  $n \times m$  0,1-matrix*  
 778  *$M$  with at least  $c_t \max(n, m)$  entries 1 has a *t-grid minor*.*

779 Marcus and Tardos established this theorem with  $c_t = 2t^4 \binom{t^2}{t}$ . Fox [12] subsequently  
 780 improved the bound to  $3t2^{8t}$ . He also showed that  $c_t$  has to be superpolynomial in  $t$  (at least  
 781  $2^{\Omega(t^{1/4})}$ ). Then Cibulka and Kynčl [6] decreased  $c_t$  further down to  $8/3(t+1)^2 2^{4t}$ .

782 Matrices with enough 1 entries are complex in the sense that they contain large *t*-grids  
 783 minors. However here the role of 1 is special compared to 0, and this result is only interesting  
 784 for sparse matrices. We would like to extend this notion of complexity to the dense case, that  
 785 is to say for all matrices. In Marcus-Tardos theorem zones are *not simple* if they contain a 1,  
 786 that is, if they have rank at least 1. A natural definition would consist of substituting “rank

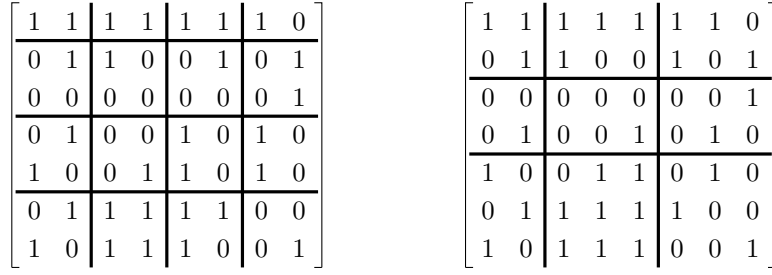

■ **Figure 4** To the left a 4-grid minor: every zone contains at least one 1. To the right a 3-mixed minor on the same matrix: no zone is horizontal or vertical.

787 at least 1” by “rank at least 2” in the definition of a  $t$ -grid minor. Since we mostly deal with  
 788 0, 1-matrices, and exclusively with discrete objects, we adopt a more combinatorial approach.

789 **5.4 Mixed minor and the grid theorem for twin-width**

790 A matrix  $M = (m_{i,j})$  is *vertical* (resp. *horizontal*) if  $m_{i,j} = m_{i+1,j}$  (resp.  $m_{i,j} = m_{i,j+1}$ )  
 791 for all  $i, j$ . Observe that a matrix which is both vertical and horizontal is constant. We say  
 792 that  $M$  is *mixed* if it is neither vertical nor horizontal. A  *$t$ -mixed minor* in  $M$  is a division  
 793  $(\mathcal{R}, \mathcal{C}) = (\{R_1, \dots, R_t\}, \{C_1, \dots, C_t\})$  such that every zone  $R_i \cap C_j$  is mixed (see right of  
 794 Figure 4). A matrix without  $t$ -mixed minor is  *$t$ -mixed free*. For instance, the  $n \times n$  matrix  
 795 with all entries equal to 1 is 1-mixed free but admits an  $n$ -grid minor.

796 The main result of this section is that  $t$ -mixed free matrices are exactly matrices with  
 797 bounded twin-width, modulo reordering the rows and columns. More precisely:

798 ► **Theorem 10** (grid minor theorem for twin-width). *Let  $\alpha$  be the alphabet size for the matrix*  
 799 *entries, and  $c_t := 8/3(t + 1)^2 2^{4t}$ .*

- 800 ■ *Every  $t$ -twin-ordered matrix is  $2t + 2$ -mixed free.*
- 801 ■ *Every  $t$ -mixed free matrix has twin-width at most  $4c_t \alpha^{4c_t+2} = 2^{2^{O(t)}}$ .*

802 A contraction sequence is a fairly complicated object. It can be seen as a sequence of  
 803 coarser and coarser partitions of the vertices, or as a sequence of pairs of vertices. The second  
 804 bullet of Theorem 10 simplifies the task of bounding the twin-width of a graph. One only  
 805 needs to find an ordering of the vertex-set such that the adjacency matrix written down with  
 806 that order has no  $t$ -mixed minor. A typical use to bound the twin-width of a class  $\mathcal{C}$ :

- 807 (1) find a good vertex-ordering process based on properties of  $\mathcal{C}$ ,
- 808 (2) assume that the adjacency matrix in this order has a  $t$ -mixed minor,
- 809 (3) use this  $t$ -mixed minor to derive a contradiction to the membership to  $\mathcal{C}$ , and
- 810 (4) conclude with Theorem 10.

811 Section 6 presents more and more elaborate instances of this framework and Table 1 reports  
 812 the orders and the bounds for different classes.

813 **5.5 Corners**

814 The proof of Theorem 10 will crucially rely on the notion of *corner*. Given a matrix  
 815  $M = (m_{i,j})$ , a *corner* is any 2-by-2 mixed submatrix of the form  $(m_{i,j}, m_{i+1,j}, m_{i,j+1},$   
 816  $m_{i+1,j+1})$ . Corners will play the same role as the 1 entries in Marcus-Tardos theorem, as  
 817 they localize the property of being mixed:

818 ► **Lemma 11.** *A matrix is mixed if and only if it contains a corner.*



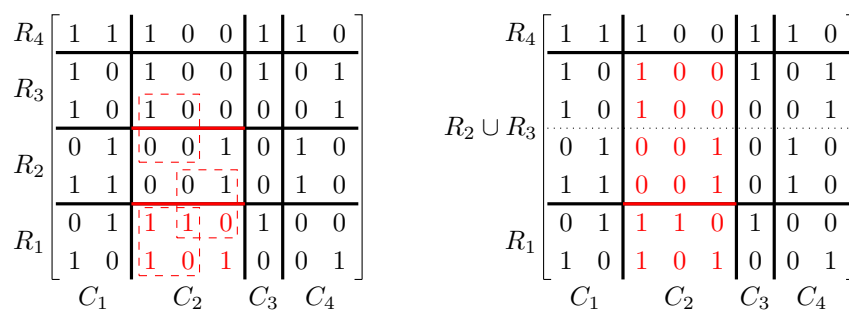

■ **Figure 5** To the left, the mixed value of  $C_2$  on  $\{R_1, R_2, R_3, R_4\}$  is 3: one mixed zone and two mixed cuts (all three in red, with a corner in each, highlighted by red dashed squares). To the right, the mixed value of  $C_2$  on  $\{R_1, R_2 \cup R_3, R_4\}$  is still 3. In general, the mixed value of a  $C_j \in \mathcal{C}$  cannot increase after the fusion of  $R_i, R_{i+1} \in \mathcal{R}$  since the only way for a new mixed zone to be created is that a mixed cut disappears, while new mixed cuts cannot be created. On the contrary, the number of mixed zones in  $C_2$  can increase as it went from 1 to 2.

819 **Proof.** A corner is certainly a witness of being mixed. Conversely let us assume that a matrix  
 820  $M$  has no corner. Either  $M$  is constant and we are done:  $M$  is not mixed. Or, without loss  
 821 of generality, there are in  $M$  two distinct entries  $m_{i,j} \neq m_{i+1,j}$ . To avoid a corner, both  
 822 entries  $m_{i,j+1}$  and  $m_{i,j-1}$  are equal to  $m_{i,j}$ . Similarly, both entries  $m_{i+1,j+1}$  and  $m_{i+1,j-1}$   
 823 are equal to  $m_{i+1,j}$ . Therefore the whole  $i$ -th row is constant as well as the  $i+1$ -st row. This  
 824 forces the rows of index  $i-1$  and  $i+2$  to be constant, and propagates to the whole matrix  
 825 which is then horizontal. Observe that if the two distinct adjacent entries would initially be  
 826  $m_{i,j} \neq m_{i,j+1}$ , then the same arguments would show that the matrix is vertical. ◀

## 827 5.6 Mixed zones, cuts, and values

828 Let  $\mathcal{R} = \{R_1, \dots, R_k\}$  be a row-division of a matrix  $M$  and let  $C$  be a set of consecutive  
 829 columns. We call *mixed zone* of  $C$  on  $\mathcal{R}$  any zone  $R_i \cap C$  which is a mixed matrix. We call  
 830 *mixed cut* of  $C$  on  $\mathcal{R}$  any index  $i \in [k-1]$  for which the 2-by- $|C|$  zone defined by the last  
 831 row of  $R_i$ , the first row of  $R_{i+1}$ , and  $C$  is a mixed matrix. Now the *mixed value* of  $C$  on  $\mathcal{R}$   
 832 is the sum of the number of mixed cuts and the number of mixed zones. See Figure 5 for an  
 833 illustration, and for why we use the mixed value instead of the mere number of mixed zones.  
 834 Analogously we define the mixed value of a set  $R$  of consecutive rows on a column-division  $\mathcal{C}$ .

835 ▶ **Lemma 12.** *The contraction of two consecutive parts of  $\mathcal{R}$  does not increase the mixed*  
 836 *value of  $C$  on  $\mathcal{R}$ .*

837 **Proof.** Assume that  $\mathcal{R} = \{R_1, \dots, R_k\}$  and  $\mathcal{R}'$  is obtained by contraction of  $R_i$  and  $R_{i+1}$ .  
 838 We just have to show that if  $R_i \cap C, R_{i+1} \cap C$  are not mixed zones and  $i$  is not a mixed cut,  
 839 then  $(R_i \cup R_{i+1}) \cap C$  is not a mixed zone. Indeed, if  $(R_i \cup R_{i+1}) \cap C$  is a mixed zone, it  
 840 contains a corner which must be in  $R_i \cap C$ , or in  $R_{i+1} \cap C$ , or otherwise sits in the mixed  
 841 cut  $i$ . ◀

842 The *mixed value* of a division  $(\mathcal{R}, \mathcal{C}) = (\{R_1, \dots, R_k\}, \{C_1, \dots, C_\ell\})$  is the maximum  
 843 mixed value of  $R_i$  on  $C$ , and of  $C_j$  on  $\mathcal{R}$ , taken over all  $R_i \in \mathcal{R}$  and  $C_j \in \mathcal{C}$ . Observe that  
 844 the finest division has mixed value 0 and the coarsest division has mixed value at most 1.



## 845 5.7 Finding a division sequence with bounded mixed value

846 Leveraging Marcus-Tardos theorem, we are ready to compute, for any  $t$ -mixed free matrix,  
 847 a division sequence with bounded mixed value. This division sequence is not necessarily  
 848 yet a contraction sequence with bounded error value (indeed a non-constant horizontal or  
 849 vertical zone counts for 0 in the mixed value but for 1 in the error value). But this division  
 850 sequence will serve as a crucial frame to find the eventual contraction sequence.

851 ► **Lemma 13.** *Every  $t$ -mixed free matrix  $M$  has a division sequence in which all divisions  
 852 have mixed value at most  $2c_t$  (where  $c_t$  is the one of Theorem 9).*

853 **Proof.** We start with the finest division of  $M$  and greedily perform fusions as long as  
 854 we can keep mixed value at most  $2c_t$ . Assume that we have reached a division  $(\mathcal{R}, \mathcal{C}) =$   
 855  $(\{R_1, \dots, R_k\}, \{C_1, \dots, C_\ell\})$ , in which, without loss of generality,  $k \geq \ell$ . Assume also, for  
 856 the sake of contradiction, that each fusion  $R_{2i-1}, R_{2i}$  for  $i = 1, \dots, \lfloor k/2 \rfloor$  leads to a mixed  
 857 value exceeding  $2c_t$ . By Lemma 12, the mixed value of  $C_j$  on  $\mathcal{R}$  does not increase when  
 858 performing a row-fusion. Thus, if the fusion of  $R_{2i-1}$  and  $R_{2i}$  is not possible, this is because  
 859 the mixed value of  $R'_i = R_{2i-1} \cup R_{2i}$  on  $\mathcal{C}$  is more than  $2c_t$ . Therefore the number of mixed  
 860 cuts or zones of each  $R'_i$  (for  $i = 1, \dots, \lfloor k/2 \rfloor$ ) on  $\mathcal{C}$  is greater than  $2c_t$ ; hence  $R'_i$  contains  
 861 more than  $2c_t$  corners in mixed zones and mixed cuts. Now we refine  $\mathcal{C}$  in two possible ways:  
 862 either  $\mathcal{C}' = \{C_1 \cup C_2, C_3 \cup C_4, \dots\}$  or  $\mathcal{C}'' = \{C_1, C_2 \cup C_3, C_4 \cup C_5, \dots\}$ . Observe that each  
 863 mixed cut of  $R'_i$  on  $\mathcal{C}'$  (resp.  $\mathcal{C}''$ ) corresponds to a mixed zone of  $R'_i$  on  $\mathcal{C}''$  (resp.  $\mathcal{C}'$ ). Let  
 864  $\mathcal{R}' = \{R'_1, \dots, R'_{\lfloor k/2 \rfloor}\}$  and consider the two divisions  $(\mathcal{R}', \mathcal{C}')$  and  $(\mathcal{R}', \mathcal{C}'')$ . Thus, in total,  
 865 the zones contained in these two divisions contain at least  $\lfloor k/2 \rfloor \cdot 2c_t$  corners. So one of these  
 866 subdivisions contains at least  $\lfloor k/2 \rfloor c_t$  zones with a corner, hence  $\lfloor k/2 \rfloor c_t$  mixed zones. By  
 867 applying Marcus-Tardos theorem (Theorem 9) to the smaller auxiliary matrix with a 1 if the  
 868 zone is mixed and a 0 otherwise, one can find a  $t$ -mixed minor in  $M$ . ◀

## 869 5.8 Finding a contraction sequence with bounded error value

870 We are now equipped to prove the main result of this section, which is the second item of  
 871 Theorem 10. The division sequence with small mixed value, provided by Lemma 13, will  
 872 guide the construction of a contraction sequence (not necessarily a division sequence) of  
 873 bounded error value. This two-layered mechanism is also present in the proof of Guillemot  
 874 and Marx, albeit in a simpler form since they have it tailored for sparse matrices, and  
 875 importantly they start from a permutation matrix.

876 **Proof of Theorem 10.** We first show that every  $t$ -twin-ordered matrix  $M$  is  $2t + 2$ -mixed  
 877 free. Let  $(\mathcal{R}, \mathcal{C}) = (\{R_1, \dots, R_{2t+2}\}, \{C_1, \dots, C_{2t+2}\})$  be a division of an  $n \times m$  matrix  $M$   
 878 and assume for contradiction that all its zones are mixed. Since  $M$  is  $t$ -twin-ordered, there is  
 879 a division sequence  $(\mathcal{R}^1, \mathcal{C}^1), \dots, (\mathcal{R}^{n+m-1}, \mathcal{C}^{n+m-1})$  in which all divisions have error value  
 880 at most  $t$ . Let us consider the first index  $s$  such that some  $R_i$  is contained in a part of  $\mathcal{R}^s$   
 881 or some  $C_j$  is contained in a part of  $\mathcal{C}^s$ . Assume without loss of generality that  $R \in \mathcal{R}^s$   
 882 contains  $R_i$ . Since a zone  $R_i \cap C_j$  in  $M$  is mixed for each  $C_j$  in  $\mathcal{C}$ , it is not vertical, and  
 883 therefore for each  $j \in [2t + 2]$  there exists a choice  $C'_j$  in  $\mathcal{C}^s$  which intersects  $C_j$  such that  
 884  $R \cap C'_j$  is not constant. Observe that we cannot have  $C'_j = C'_{j+2}$  since this would mean that  
 885  $C'_j$  contains  $C_{j+1}$ , a contradiction to the choice of  $s$ . In particular the error value of  $R$  in  $\mathcal{C}^s$   
 886 is at least  $(2t + 2)/2 > t$ , a contradiction.

887 We now show that every  $n \times m$  matrix  $M$  which does not contain a  $t$ -mixed minor has twin-  
 888 width at most  $4c_t \alpha^{4c_t+2}$ , where  $c_t$  is as defined in Theorem 9, and  $\alpha$  is the alphabet size for the  
 889 entries of  $M$ . By Lemma 13, there exists a division sequence  $(\mathcal{R}^1, \mathcal{C}^1), \dots, (\mathcal{R}^{n+m-1}, \mathcal{C}^{n+m-1})$

890 with mixed value at most  $t' := 2c_t$ . We now refine each division  $(\mathcal{R}^s, \mathcal{C}^s) = (\{R_1, \dots, R_a\},$   
 891  $\{C_1, \dots, C_b\})$ , into a partition  $(\mathcal{R}'^s, \mathcal{C}'^s)$  of  $M$  (which is not necessarily a division). We  
 892 consider  $R_i \in \mathcal{R}^s$  and we say that a subset  $J$  of consecutive indices of  $\{1, \dots, b\}$  is *good* if  
 893  $R_i \cap \cup_{j \in J} C_j$  is not mixed. Now, observe that if  $j \in [b-1]$  is not a mixed cut, and if  $R_i \cap C_j$   
 894 and  $R_i \cap C_{j+1}$  are both non-mixed zones, then  $R_i \cap (C_j \cup C_{j+1})$  is a non-mixed zone. Since  
 895 the mixed value of  $R_i$  on  $\mathcal{C}^s$  is at most  $t'$ , one can find at most  $t' + 1$  good subsets  $J_1, \dots, J_r$   
 896 covering all the non-mixed zones of  $R_i$  (each good subset spans all indices between two mixed  
 897 zones/cuts). We observe that a zone  $Z_c := R_i \cap \cup_{j \in J_c} C_j$  is either vertical or horizontal.  
 898 When  $Z_c$  is vertical, all rows of  $R_i$  are identical on indices in  $J_c$ . When  $Z_c$  is horizontal,  
 899 there are at most  $\alpha$  possible rows of  $R_i$  restricted to the indices in  $J_c$  where  $\alpha$  is the size  
 900 of the alphabet. In particular, there are at most  $\alpha^r \leq \alpha^{t'+1}$  different rows in  $R_i$ , when we  
 901 restrict them to  $\{1, \dots, b\} \setminus \{j \mid R_i \cap C_j \text{ is mixed}\}$ . We then partition  $R_i$  into these different  
 902 types of rows and proceed in the same way for all parts in  $\mathcal{R}^s$  and in  $\mathcal{C}^s$  to obtain a partition  
 903  $(\mathcal{R}'^s, \mathcal{C}'^s)$  of  $M$ .

904 We show that the error value of  $(\mathcal{R}'^s, \mathcal{C}'^s)$  does not exceed  $t' \alpha^{t'+1}$ . Suppose that a zone  
 905  $R \cap C$  where  $R \in \mathcal{R}'^s$  and  $C \in \mathcal{C}'^s$  is not constant. We denote by  $R_i \in \mathcal{R}^s$  and  $C_j \in \mathcal{C}^s$   
 906 the parts such that  $R \subseteq R_i$  and  $C \subseteq C_j$ . Note that the zone  $R_i \cap C_j$  must be mixed, since  
 907 otherwise, it has been divided into constant zones in  $(\mathcal{R}'^s, \mathcal{C}'^s)$ . In particular, the total  
 908 number of such  $C_j$  is at most  $t'$ . Since  $C_j$  has been partitioned at most  $\alpha^{t'+1}$  times, the  
 909 total number of zones  $R \cap C$  is at most  $t' \alpha^{t'+1}$ .

910 Let us show that the partition  $(\mathcal{R}'^s, \mathcal{C}'^s)$  refines  $(\mathcal{R}^{s+1}, \mathcal{C}^{s+1})$ . Take for instance  $R \in \mathcal{R}'^s$   
 911 and denote by  $R_i \in \mathcal{R}^s$  the part such that  $R \subseteq R_i$ . Now the rows in  $R$  have been selected in  
 912  $R_i$  as they coincide on all zones  $R \cap C$  where  $C \in \mathcal{C}'^s$  and  $R_i \cap C$  is not mixed. Since the  
 913 zones of  $(\mathcal{R}^{s+1}, \mathcal{C}^{s+1})$  contain the zones of  $(\mathcal{R}^s, \mathcal{C}^s)$ , the selection at stage  $s+1$  is based on  
 914 potentially less  $C_j$  such that  $R_i \cup C_j$  is not mixed (in case of a column fusion) or potentially  
 915 more rows to choose  $R$  from (in case of a row fusion with  $R_i$ ). In both cases,  $R$  has to appear  
 916 in some part of  $\mathcal{R}^{s+1}$ . We established that  $(\mathcal{R}'^s, \mathcal{C}'^s)$  refines  $(\mathcal{R}^{s+1}, \mathcal{C}^{s+1})$ . Moreover, since  
 917  $(\mathcal{R}'^s, \mathcal{C}'^s)$   $\alpha^{t'+1}$ -refines  $(\mathcal{R}^s, \mathcal{C}^s)$  which in turn 2-refines  $(\mathcal{R}^{s+1}, \mathcal{C}^{s+1})$ , we have that  $(\mathcal{R}'^s, \mathcal{C}'^s)$   
 918  $2\alpha^{t'+1}$ -refines  $(\mathcal{R}^{s+1}, \mathcal{C}^{s+1})$ . As  $(\mathcal{R}^{s+1}, \mathcal{C}^{s+1})$  refines  $(\mathcal{R}^{s+1}, \mathcal{C}^{s+1})$ ,  $(\mathcal{R}'^s, \mathcal{C}'^s)$   $2\alpha^{t'+1}$ -refines  
 919  $(\mathcal{R}^{s+1}, \mathcal{C}^{s+1})$ .

920 Finally, we apply Lemma 8 to the sequence  $(\mathcal{R}'^s, \mathcal{C}'^s)$  and conclude that the twin-width  
 921 of  $M$  is at most  $2\alpha^{t'+1} \cdot t' \alpha^{t'+1} = 2t' \alpha^{2(t'+1)} = 4c_t \alpha^{4c_t+2}$ .  $\blacktriangleleft$

922 The second item of Theorem 10 has the following consequence, which reduces the task  
 923 of bounding the twin-width of  $G$  and finding a contraction sequence to merely exhibiting a  
 924 *mixed free order*, that is a domain-ordering  $\sigma$  such that the matrix  $A_\sigma(G)$  is  $t$ -mixed free for  
 925 a bounded  $t$ .

926  $\blacktriangleright$  **Theorem 14.** *Let  $G$  be a (di)graph or even a binary structure. If there is an ordering*  
 927  $\sigma : v_1, \dots, v_n$  *of  $V(G)$  such that  $A_\sigma(G)$  is  $k$ -mixed free, then  $\text{tw}(G) = 2^{2^{O(k)}}$ .*

928 **Proof.** We shall just revisit the proof of Theorem 10 and check that, starting from a mixed-  
 929 symmetric matrix  $M := A_\sigma(G)$ , we can design a symmetric contraction sequence. As  
 930  $M = (m_{ij})_{i,j}$  is mixed-symmetric, it holds that  $m_{ij} = m_{i'j'} \Leftrightarrow m_{ji} = m_{j'i'}$ . In particular the  
 931 symmetric  $Z'$  about the diagonal of an off-diagonal zone  $Z$  is mixed if and only if  $Z'$  is mixed.  
 932 More precisely,  $Z'$  is horizontal (resp. vertical) if and only if  $Z$  is vertical (resp. horizontal).  
 933

934 The division sequence with bounded mixed value, greedily built in Lemma 13, can be  
 935 then made symmetric. Say the first fusion merges the  $i$ -th and  $i+1$ -st rows, and let us call  
 936  $R$  this new row-part. We perform the symmetric fusion of the  $i$ -th and  $i+1$ -st columns,  
 and denote by  $C$  the obtained column-part. After that operation, no mixed value among

937 the row-parts has increased. In particular the mixed value of  $R$  has not increased, and this  
 938 new mixed value equals the mixed value of  $C$ . Therefore the symmetric fusion was indeed  
 939 possible. We iterate this process and follow the rest of the proof of Lemma 13 to obtain a  
 940 symmetric division sequence.

941 The refinement of the division sequence into a sequence of partitions of bounded error  
 942 value, in the second step of the proof of Theorem 10, is now symmetric since the division is  
 943 symmetric and  $M$  is mixed-symmetric (so two columns are equal on a set of zones if and  
 944 only if the symmetric rows are equal on the symmetric set of zones). Finally the contraction  
 945 sequence is provided by Lemma 8. In this lemma, we observed that the contractions going  
 946 from the (symmetric)  $(\mathcal{R}^i, \mathcal{C}^i)$  to the (symmetric)  $(\mathcal{R}^{i+1}, \mathcal{C}^{i+1})$  can be done in any order. Thus  
 947 we can perform a symmetric sequence of contractions. Overall we constructed a symmetric  
 948 contraction sequence with error value  $2^{2^{O(k)}}$ . Hence the twin-width of  $G$  is bounded by that  
 949 quantity. This can be interpreted as a contraction sequence of the vertices of  $G$  (or domain  
 950 elements) with bounded red degree. ◀

951 We observe that the proof of Theorem 14 is constructive. It yields an algorithm which, given  
 952 a  $k$ -mixed free  $n \times n$  matrix  $M$ , outputs a  $2^{2^{O(k)}}$ -sequence of  $M$  in  $O(n^2)$ -time.

## 953 6 Classes with bounded twin-width

954 In this section we show that some classical classes of graphs and matrices have bounded  
 955 twin-width. Let us start with the origin of twin-width, which is the method proposed by  
 956 Guillemot and Marx [22] to understand permutation matrices avoiding a certain pattern.

### 957 6.1 Pattern-avoiding permutations

958 We associate to a permutation  $\sigma$  over  $[n]$  the  $n \times n$  matrix  $M_\sigma = (m_{ij})_{i,j}$  where  $m_{i\sigma(i)} = 1$   
 959 and all the other entries are set to 0. A permutation  $\sigma$  is a *pattern* of a permutation  $\tau$  if  $M_\sigma$   
 960 is a submatrix of  $M_\tau$ . A central open question was the design of an algorithm deciding if a  
 961 pattern  $\sigma$  appears in a permutation  $\tau$  in time  $f(|\sigma|) \cdot |\tau|^{O(1)}$ . The brilliant idea of Guillemot  
 962 and Marx, reminiscent of treewidth and grid minors, is to observe that permutations avoiding  
 963 a pattern  $\sigma$  can be iteratively decomposed (or collapsed), and that the decomposition gives  
 964 rise to a dynamic-programming scheme. This led them to a linear-time  $f(|\sigma|) \cdot |\tau|$  algorithm  
 965 for permutation pattern recognition. In Sections 3 and 5 we generalized their decomposition  
 966 to graphs and arbitrary (dense) matrices, and leveraged Marcus-Tardos theorem, also in the  
 967 dense setting. Section 5 would in principle readily apply here: If a permutation matrix  $M_\tau$   
 968 does not contain a fixed pattern of size  $k$ , then it is certainly  $k$ -mixed free since otherwise the  
 969  $k$ -mixed minor would contain any pattern of size  $k$ . Hence by Theorem 10,  $M_\tau$  has bounded  
 970 twin-width.

971 However, to be able to use our framework and derive that FO model checking is FPT in  
 972 the class of permutations avoiding a given pattern, we need to transform  $M_\tau$  into a different  
 973 matrix. Namely, we consider the directed graph  $D_\tau$  whose vertex-set is the union of two  
 974 total orders, respectively the natural increasing orders on  $\{1, \dots, n\}$  and on  $\{1', \dots, n'\}$ ,  
 975 where we add double arcs between  $i$  and  $\tau(i)'$ . The adjacency matrix  $A(D_\tau)$  of  $D_\tau$  where the  
 976 vertices are ordered  $1, \dots, n, 1', \dots, n'$  (recall the encoding mentioned in Section 5.1) consists  
 977 of four blocks. Two of them are  $M_\tau$  and its transpose, and the two others (encoding the  
 978 total orders) both consist of a lower triangle of 1, including the diagonal, completed by an  
 979 upper triangle of -1. If  $M_\tau$  is  $k$ -mixed free, the matrix  $A(D_\tau)$  is  $2k$ -mixed free, and thus has  
 980 bounded twin-width. Note also that every first-order formula expressible in the permutation

981  $\tau$  (where we can test equality and  $\leq$ ) is expressible in the structure  $D_\tau$ . In Section 7 we will  
 982 show that FO model checking is FPT for  $D_\tau$ , as we can efficiently compute a sequence of  
 983  $d$ -partitions. Therefore FO model checking is also FPT in the class of permutations avoiding  
 984 some fixed pattern  $\sigma$ .

985 As an illustrating example, let us consider the following artificial problem. Let  $\ell$  be a  
 986 positive integer, and  $\sigma, \sigma'$  be two fixed permutations. Given an input permutation  $\tau$ , we ask  
 987 if  $\tau$  contains the pattern  $\sigma'$  or every pattern of  $\tau$  of size  $\ell$  is contained in  $\sigma$ . There is an  
 988  $f(\ell, |\sigma|, |\sigma'|) \cdot |\tau|^2$  algorithm to solve this problem (actually the dependency in  $|\tau|$  could be  
 989 made linear in this particular case). We first compute an upper bound on the twin-width of  
 990 the matrix  $M_\tau$  associated to  $\tau$  (as defined previously). Either  $M_\tau$  has a  $|\sigma'|$ -mixed minor  
 991 (and we can answer positively:  $\sigma'$  appears in  $\tau$ ), or  $D_\tau$  has bounded twin-width. One of  
 992 these two outcomes can be reached in time  $O(|\tau|^2)$  by the previous section (even  $O(|\tau|)$ ). We  
 993 now assume that  $D_\tau$  has bounded twin-width. Then we observe that the property “every  
 994 pattern of  $\tau$  of size  $\ell$  is contained in  $\sigma$ ” is expressible by a first-order formula of size  $g(\ell, |\sigma|)$ .  
 995 By Section 7 that property can be tested in time  $f(\ell, |\sigma|, |\sigma'|) \cdot |\tau|$ .

996 Given a permutation  $\tau$ , we can form the *permutation graph*  $G_\tau$  on vertex-set  $[n]$  where  $ij$   
 997 is an edge when  $i < j$  and  $\tau(i) > \tau(j)$ . Note that  $G_\tau$  can be first-order interpreted from the  
 998 digraph  $D_\tau$  (defined as above) and the partition of  $V(D_\tau)$  into  $\{1, \dots, n\}$  and  $\{1', \dots, n'\}$ .  
 999 In Section 8 we will show that any FO interpretation of a graph  $G$  by a formula  $\phi(x, y)$  has  
 1000 twin-width bounded by a function of  $\phi$  and  $\text{tw}(G)$ . This implies the following:

1001 ► **Lemma 15.** *FO model checking is FPT on every proper subclass of permutation graphs*  
 1002 *(i.e., closed under induced subgraphs and not equal to all permutation graphs).*

1003 **Proof.** By assumption, there is a permutation graph  $G_\sigma$  which is not an induced subgraph  
 1004 of any graph  $G_\tau$  in the class. We thus obtain that  $D_\tau$  has bounded twin-width, as  $M_\tau$  does  
 1005 not contain the pattern  $M_\sigma$ . Therefore  $G_\tau$  itself has bounded twin-width, and a sequence of  
 1006 contractions can be efficiently found (by following the constructive proof of Section 5). We  
 1007 conclude by invoking Section 7. ◀

1008 A similar argument works for partial orders of (Dushnik-Miller) dimension 2, i.e., inter-  
 1009 sections of two total orders defined on the same set. We obtain:

1010 ► **Lemma 16.** *FO model checking is FPT on every proper subclass of partial orders of*  
 1011 *dimension 2.*

## 1012 6.2 Posets of bounded width

1013 The versatility of the grid minor theorem for twin-width is also illustrated with posets. Let  
 1014  $P = (X, \leq)$  be a poset of *width*  $k$ , that is, its maximum antichain has size  $k$ . For  $x_i, x_j \in X$ ,  
 1015  $x_i < x_j$  denotes that  $x_i \leq x_j$  and  $x_i \neq x_j$ . We claim that the twin-width of  $P$  is bounded  
 1016 by a function of  $k$ . By Dilworth’s theorem,  $P$  can be partitioned into  $k$  total orders (or  
 1017 *chains*)  $T_1, \dots, T_k$ . Now one can enumerate the vertices precisely in this order, say  $\sigma$ , that is,  
 1018 increasingly with respect to  $T_1$ , then increasingly with respect to  $T_2$ , and so on. We rename  
 1019 the elements of  $X$  so that in the order  $\sigma$ , they read  $x_1, x_2, \dots, x_n$ , with  $n := |X|$ . Let us  
 1020 write the adjacency matrix  $A = (a_{ij}) := A_\sigma(P)$  of  $P$ :  $a_{ij} = 1$  if  $x_i \leq x_j$ ,  $a_{ij} = -1$  if  $x_j < x_i$ ,  
 1021 and  $a_{ij} = 0$  otherwise. Recall that this is consistent with how we defined the adjacency  
 1022 matrix for the more general digraphs in Section 5. We assume for contradiction that  $A$  has a  
 1023  $3k$ -mixed minor.

1024 By the pigeon-hole principle, there is a submatrix of  $A$  indexed by two chains,  $T_i$  for  
 1025 the row indices and  $T_j$  for the column indices, which has a 3-mixed minor, realized by the

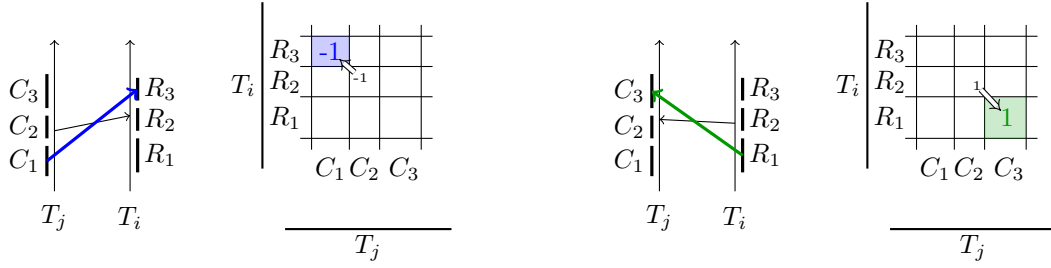

■ **Figure 6** Left: If there is one arc from  $C_2$  to  $R_2$ , then by transitivity there are all arcs from  $C_1$  to  $R_3$ . On the matrix, this translates as: a -1 entry in  $R_2 \cap C_2$  implies that all the entries of  $R_3 \cap C_1$  are -1. Right: Similarly, a 1 entry in  $R_2 \cap C_2$  implies that all the entries of  $R_1 \cap C_3$  are 1. Hence at least one zone among  $R_3 \cap C_1, R_2 \cap C_2, R_1 \cap C_3$  is constant, a contradiction to the  $3k$ -mixed minor.

1026  $(3, 3)$ -division  $(R_1, R_2, R_3), (C_1, C_2, C_3)$ . The zone  $R_2 \cap C_2$  is mixed, so it contains a -1 or  
 1027 a 1. If it is a -1, then by transitivity the zone  $R_3 \cap C_1$  is entirely -1, a contradiction to its  
 1028 being mixed. A similar contradiction holds when there is a 1 entry in  $R_2 \cap C_2$ : zone  $R_1 \cap C_3$   
 1029 is entirely 1. See Figure 6 for an illustration. Hence, by Theorem 10, the twin-width of  $A$   
 1030 (and the twin-width of  $P$  seen as a directed graph) is bounded by  $4c_k \cdot 4^{4c_k+2} = 2^{2^{O(k)}}$ .

1031 Of course there was a bit of work to establish Theorem 10 inspired by the Guillemot-  
 1032 Marx framework, and supported by Marcus-Tardos theorem. There was even more work to  
 1033 prove that FO model checking is FPT on bounded twin-width (di)graphs. It is nevertheless  
 1034 noteworthy that once that theory is established, the proof that bounded twin-width captures  
 1035 the posets of bounded width is lightning fast. Indeed the known FPT algorithm on posets  
 1036 of bounded width [15] is a strong result, itself generalizing or implying the tractability of  
 1037 FO model checking on several geometric classes [20, 23], as well as algorithms for *existential*  
 1038 FO model checking on posets of bounded width [5, 17]. We observe that posets of bounded  
 1039 twin-width constitute a strict superset of posets of bounded width. Arcless posets are trivial  
 1040 separating examples, which have unbounded maximum antichain and twin-width 0. A more  
 1041 elaborate example would be posets whose cover digraph is a directed path on  $\sqrt{n}$  vertices in  
 1042 which all vertices are substituted by an independent set of size  $\sqrt{n}$ . These posets have width  
 1043  $\sqrt{n}$  and twin-width 1.

1044 The next example does not qualify as a “lightning fast” membership proof to bounded  
 1045 twin-width. It shows however that the good vertex-ordering can be far less straightforward.

### 1046 6.3 Proper minor-closed classes

1047 A more intricate example is given by proper minor-closed classes. By definition, a proper  
 1048 minor-closed class does not contain some graph  $H$  as a minor. This implies in particular  
 1049 that it does not contain  $K_{|V(H)|}$  as a minor. Thus we only need to show that  $K_t$ -minor free  
 1050 graphs have bounded twin-width.

1051 If the  $K_t$ -minor free graph  $G$  admits a hamiltonian path, things become considerably sim-  
 1052 pler. We can enumerate the vertices of  $G$  according to this path and write the corresponding  
 1053 adjacency matrix  $A$ . The crucial observation is that a  $k$ -mixed minor yields a  $K_{k/2, k/2}$ -minor,  
 1054 hence a  $K_{k/2}$ -minor. So  $A$  cannot have a  $2t$ -mixed minor, and by Theorem 10, the twin-width  
 1055 of  $G$  bounded (by  $4c_{2t} 2^{4c_{2t}+2} = 2^{t^{O(t)}}$ ). Unfortunately, a hamiltonian path is not always  
 1056 granted in  $G$ . A depth-first search (DFS for short) tree may emulate the path, but any DFS  
 1057 will not necessarily work. Interestingly the main tool of the following theorem is a carefully  
 1058 chosen Lex-DFS.

	Permutations avoiding $\sigma$	Posets of width $w$	$K_t$ -minor free graphs
ordering	imposed	chains put one after the other	ad-hoc Lex-DFS
bound	$2^{O( \sigma )}$	$2^{2^{O(w)}}$	$2^{2^{2^{O(t)}}}$

■ **Table 1** Choice of the ordering and bound on the twin-width for the classes tackled in Section 6.

1059 ► **Theorem 17.** We set  $g : t \mapsto 2(2^{4t+1} + 1)^2$ ,  $c_k := 8/3(k+1)^2 2^{4k}$ , and  $f : t \mapsto 4c_{g(t)} 2^{4c_{g(t)}+2}$ .  
 1060 Every  $K_t$ -minor free graph have twin-width at most  $f(t) = 2^{2^{2^{O(t)}}}$ .

1061 **Proof.** Let  $G$  be a  $K_t$ -minor free graph, and  $n := |V(G)|$ . We wish to upperbound the  
 1062 twin-width of  $G$ . We may assume that  $G$  is connected since the twin-width of a graph is  
 1063 equal to the maximum twin-width of its connected components.

1064 **Definition of the appropriate Lex-DFS.** Let  $v_1$  be an arbitrary vertex of  $G$ . We perform  
 1065 a specific depth-first search from  $v_1$ . A vertex is said *discovered* when it is visited (for the  
 1066 first time) in the DFS. The *current discovery order* is a total order  $v_1, \dots, v_\ell$  among the  
 1067 discovered vertices, where  $v_i$  was discovered before  $v_j$  whenever  $i < j$ . We may denote that  
 1068 fact by  $v_i \prec v_j$ , and  $v_i \preceq v_j$  if  $i$  and  $j$  may potentially be equal. The *current DFS tree*  
 1069 is the tree on the discovered vertices whose edges correspond to the usual parent-to-child  
 1070 exploration. The *active* vertex is the lastly discovered vertex which still has at least one  
 1071 undiscovered neighbor. Initially the active vertex is  $v_1$ , and when all vertices have been  
 1072 discovered, there is no longer an active vertex. Before that, since  $G$  is connected, the active  
 1073 vertex is always well-defined. The (full) *discovery order* is the same total order when all the  
 1074 vertices have been discovered.

1075 We shall now describe how we break ties among the undiscovered neighbors of the active  
 1076 vertex. Let  $v_1, \dots, v_\ell$  be the discovered vertices (with  $\ell < n$ ),  $\mathcal{T}_\ell$  be the current DFS tree,  
 1077 and  $v$  be the active vertex. Let  $C_1, \dots, C_s$  be the vertex-sets of the connected components of  
 1078  $G - V(\mathcal{T}_\ell)$  intersecting  $N_G(v)$ . By definition of the active vertex,  $s \geq 1$ . For each  $i \in [s]$ , we  
 1079 interpret  $N_G(C_i) \cap V(\mathcal{T}_\ell)$  as a word  $w_\ell(C_i)$  of  $\{0, 1\}^\ell$  where, for every  $j \in [l]$ , the  $j$ -th letter of  
 1080  $w_\ell(C_i)$  is a 1 if and only if  $v_j \in N_G(C_i) \cap V(\mathcal{T}_\ell)$ . If  $w$  and  $w'$  are two words on the alphabet  
 1081  $\{0, 1\}$ , we denote by  $w \leq_{\text{lex}} w'$  the fact that  $w$  is not greater than  $w'$  in the lexicographic  
 1082 order derived from  $0 < 1$ . We can now define the successor of  $v_\ell$  in the discovery order. The  
 1083 new vertex  $v_{\ell+1}$  is chosen as an arbitrary vertex of  $C_i \cap N_G(v)$  where  $w_\ell(C_j) \leq_{\text{lex}} w_\ell(C_i)$  for  
 1084 every  $j \in [s]$ . Informally we visit first the component having the neighbors appearing first in  
 1085 the current discovery order.

1086 **The Lex-DFS discovery to order the adjacency matrix M.** Let  $v_1, \dots, v_n$  be the eventual  
 1087 discovery order, and let  $\mathcal{T}$  be the complete DFS tree. Let  $M$  be the  $\{0, 1\}^{n \times n}$  matrix  
 1088 obtained by ordering the rows and columns of the adjacency matrix of  $G$  accordingly to  
 1089 the discovery order. We set  $g(t) := 2h(t)^2$  and  $h(t) := 2^{4t+1} + 2$ . We will show that  $M$  is  
 1090  $g(t)$ -mixed free, actually even  $g(t)$ -grid free. For the sake of contradiction, let us suppose  
 1091 that  $M$  has a  $g(t)$ -grid minor defined by the consecutive sets of columns  $C_1, C_2, \dots, C_{g(t)}$   
 1092 and the consecutive sets of rows  $R_1, R_2, \dots, R_{g(t)}$ .

1093 Now our goal is to show that we can contract a non-negligible amount of the  $C_j$  and  
 1094  $R_i$ , thereby exhibiting a  $K_t$ -minor. Actually the  $K_t$ -minors will arise from  $K_{a,b}$ -minors with  
 1095  $t \leq \min(a, b)$ . We observe that either  $\bigcup_{j \in [1, g(t)/2]} C_j$  and  $\bigcup_{i \in [g(t)/2+1, g(t)]} R_i$  are disjoint,

1096 or  $\bigcup_{j \in [g(t)/2+1, g(t)]} C_j$  and  $\bigcup_{i \in [1, g(t)/2]} R_i$  are disjoint. Without loss of generality, let us  
 1097 assume that the former condition holds, and we will now try to find a  $K_{t,t}$ -minor between  
 1098  $C_1, \dots, C_{g(t)/2}$  and  $R_{g(t)/2+1}, \dots, R_{g(t)}$ . To emphasize the irrelevance of the first sets being  
 1099 columns and the second sets being rows, we rename  $C_1, \dots, C_{g(t)/2}$  by  $A_1, \dots, A_{g(t)/2}$ , and  
 1100  $R_{g(t)/2+1}, \dots, R_{g(t)}$  by  $B_1, \dots, B_{g(t)/2}$ .

1101 Note that all the vertices of  $\bigcup_{i \in [g(t)/2]} A_i$  are consecutive in the discovery order and  
 1102 appear before the consecutive vertices  $\bigcup_{i \in [g(t)/2]} B_i$ . Another important fact is that there  
 1103 is at least one edge between every pair  $(A_i, B_j)$  (by definition of a mixed minor, or even  
 1104 grid minor). Thus let  $a_{i,j} \in A_i$  be an arbitrary vertex with at least one neighbor  $b_{i,j}$  in  $B_j$ .  
 1105 At this point, if we could contract each  $A_i$  and  $B_j$ , we would be immediately done. This is  
 1106 possible if all these sets induce a connected subgraph. We will see that this is essentially the  
 1107 case for the sets of  $\{A_i\}_{i \in [g(t)/2]}$ , but not necessarily for the  $\{B_j\}_{j \in [g(t)/2]}$ .

1108 **The  $\{A_i\}_i$  essentially induce disjoint paths along the same branch.** Let  $A'_i$  be the vertex-  
 1109 set of the minimal subtree of  $\mathcal{T}$  containing  $\bigcup_{j \in [g(t)/2]} \{a_{i,j}\}$ . The following lemma only uses  
 1110 the definition of a DFS, and not our specific tie-breaking rules.

1111 **► Lemma 18.** *All the vertices  $a_{i,j}$ , for  $i, j \in [g(t)/2]$ , lie on a single branch of the DFS tree  
 1112 with, in the discovery order, first  $\bigcup_{j \in [g(t)/2]} \{a_{1,j}\}$ , then  $\bigcup_{j \in [g(t)/2]} \{a_{2,j}\}$ , and so on, up to  
 1113  $\bigcup_{j \in [g(t)/2]} \{a_{g(t)/2,j}\}$ . In particular, the sets  $A'_i$  induce pairwise-disjoint paths in  $\mathcal{T}$  along the  
 1114 same branch.*

1115 **Proof.** Assume for the sake of contradiction that  $a_{i,j}$  and  $a_{i',j'}$ , with  $a_{i,j} \prec a_{i',j'}$ , are not in  
 1116 an ancestor-descendant relationship in  $\mathcal{T}$ . Let  $w$  be the least common ancestor of  $a_{i,j}$  and  
 1117  $a_{i',j'}$ , and  $\mathcal{T}_w$  the current DFS tree the moment  $w$  is discovered. Hence  $w \prec a_{i,j}$ . We claim  
 1118 that  $b_{i,j}$  would be discovered before  $a_{i',j'}$ , a contradiction. Indeed when  $a_{i,j}$  is discovered, it  
 1119 becomes the active vertex (due, for instance, to the mere existence of  $b_{i,j}$ ). By design of a  
 1120 DFS,  $a_{i,j}$  is not in the same connected component of  $G - \mathcal{T}_w$  as  $a_{i',j'}$ , but its neighbor  $b_{i,j}$   
 1121 obviously is. So this connected component, and in particular  $b_{i,j}$ , is fully discovered before  
 1122  $a_{i',j'}$ . This proves that the sets  $A'_i$  induce paths in  $\mathcal{T}$  along the same branch.

1123 We claim that these paths are pairwise disjoint and in the order (from root to bottom)  
 1124  $A'_1, A'_2, \dots, A'_{g(t)/2}$ . This is immediate since, for every  $i < i'$ ,  $a_{i,j} \prec a_{i',j'}$ . Thus  $a_{i,j}$  can only  
 1125 be an ancestor of  $a_{i',j'}$  in  $\mathcal{T}$ . One can also observe that  $A'_i \subseteq A_i$  for every  $i \in [g(t)/2]$ . ◀

1126 **Handling the  $\{B_j\}_j$  with the enhancements  $\{B_j^*\}_j$ .** Let  $B_j^*$  be the vertex-set of the  
 1127 minimum subtree of  $\mathcal{T}$  containing  $B_j$ . Since  $B_j$  consist of consecutive vertices in the  
 1128 discovery order,  $B_j^* = B_j \uplus P_j$  where  $P_j$  is a path on a single branch of  $\mathcal{T}$ . One can see  $B_j^*$   
 1129 as an *enhancement* of  $B_j$ .

1130 We show that except maybe the last  $A'_i$ , namely  $A'_{g(t)/2}$ , every set enhancement  $B_j^*$  is  
 1131 disjoint from every  $A'_i$ .

1132 **► Lemma 19.** *For every  $j \in [g(t)/2]$ , for every  $i \in [g(t)/2 - 1]$ ,  $B_j^* \cap A'_i = \emptyset$ .*

1133 **Proof.** There is an edge between  $A'_{g(t)/2}$  and each  $B_j$ . Every  $B_j$  succeeds  $A'_{g(t)/2}$  in the  
 1134 discovery order. Therefore all the vertices of  $\bigcup_{j \in [g(t)/2]} B_j$  appear in  $\mathcal{T}$  in the subtree of the  
 1135 firstly discovered vertex, say  $u$ , of  $A'_{g(t)/2}$ . Hence all the trees  $B_j^*$  are fully contained in  $\mathcal{T}[u]$   
 1136 the subtree of  $\mathcal{T}$  rooted at  $u$ . We can then conclude since, by Lemma 18, all the vertices of  
 1137  $\bigcup_{j \in [g(t)/2-1]} A'_j$  are ancestors of  $u$ . ◀



1138 An enhancement is connected by design. Furthermore, by Lemma 19 contracting (in the  
 1139 usual minor sense) a  $B_j^*$  would not affect almost all  $A'_i$ . The remaining obvious issue that we  
 1140 are facing is that a pair of enhancements  $B_j^*$  and  $B_{j'}^*$  may very well overlap. Thus we turn  
 1141 our attention to their intersection graph.

1142 **The intersection graph  $H$  of the enhancements.** Let  $H$  be the intersection graph whose  
 1143 vertices are  $B_1^*, \dots, B_{g(t)/2}^*$  and there is an edge between two vertices whenever the corres-  
 1144 ponding sets intersect. As an intersection graph of subtrees in a tree,  $H$  is a chordal graph.  
 1145 In particular  $H$  is a perfect graph, thus  $\alpha(H)\omega(H) \geq |V(H)| = g(t)/2$ . Therefore either  
 1146  $\alpha(H) \geq \sqrt{g(t)/2}$  or  $\omega(H) \geq \sqrt{g(t)/2}$ . Moreover in polynomial-time, we can compute an  
 1147 independent or a clique of size  $\sqrt{g(t)/2} = h(t) = 2^{4t+1} + 2 > t$ . If we get a large independent  
 1148 set  $I$  in  $H$ , we can contract the edges of each  $B_j^*$  corresponding to a vertex of  $I$ . By Lemma 19  
 1149 we can also contract any  $h(t)$  paths  $A'_i$  which are not  $A'_{g(t)/2}$ , and obtain a  $K_{h(t),h(t)}$  (which  
 1150 contains a  $K_{h(t)}$ -minor, hence a  $K_t$ -minor). We thus assume that we get a large clique  $C$   
 1151 in  $H$ .

1152  **$H$  has a clique  $C$  of size at least  $h(t)$ .** By the Helly property satisfied by the subtrees of  
 1153 a tree, there is a vertex  $v$  of  $\mathcal{T}$  (or of  $G$ ) such that every  $B_j^* \in C$  contains  $v$ . If we potentially  
 1154 exclude the  $B_j^*$  of  $C$  with smallest and largest index, all the other elements of  $C$  are fully  
 1155 contained in  $\mathcal{T}[v]$  the subtree of  $\mathcal{T}$  rooted at  $v$ . Let  $C_1, \dots, C_s$  be the connected components  
 1156 of  $\mathcal{T}[v] - \{v\}$ , ordered by the Lex-DFS discovery order. Thus  $v$  has  $s$  children in  $\mathcal{T}$ .

1157 **The enhancements of  $C$  essentially intersect only at  $v$ .** We show that each connected  
 1158 component may intersect only a very limited number of  $B_j^* \in C$ .

1159 **► Lemma 20.** *For every  $i \in [s]$ , the connected component  $C_i$  intersects at most two  $B_j^* \in C$ .*

1160 **Proof.** Assume by contradiction that there is a connected component  $C_i$  intersecting  
 1161  $B_{j_1}^*, B_{j_2}^*, B_{j_3}^* \in C$ , with  $j_1 < j_2 < j_3$ . Since  $B_{j_2}$  appears after  $B_{j_1}$  and before  $B_{j_3}$  in  
 1162 the discovery order,  $B_{j_2}$  is fully contained in  $C_i$ . Hence  $B_{j_2}^*$  is also contained in  $C_i$  and  
 1163 cannot contain  $v$ , a contradiction. ◀

1164 Moreover Lemma 20 shows that only two consecutive  $B_{j_1}^*, B_{j_2}^* \in C$  (by consecutive, we mean  
 1165 that there is no  $B_j^* \in C$  with  $j_1 < j < j_2$ ) may intersect the same connected component  
 1166 of  $\mathcal{T}[v] - \{v\}$ . Let us relabel  $D_1, \dots, D_{(h(t)-1)/2}$ , every other elements of  $C$  except the last  
 1167 one (keeping the same order). Now no connected component  $C_i$  intersects two distinct sets  
 1168  $D_j, D_{j'}$ . Each  $D_j$  defines an interval  $I_j := [\ell(j), r(j)]$  of the indices  $i$  such that  $D_j$  intersects  
 1169  $C_i$ . The sets  $I_j$  are pairwise-disjoint intervals.

1170 **Definitions of the pointers  $z, j_b, j_e$  to iteratively build  $\mathcal{S}$  and  $\mathcal{L}$ .** Let  $z_1 \in N_G(C_{r(1)})$  be  
 1171 such that for every  $z' \in N_G(C_{r(1)})$ ,  $z_1 \preceq z'$ . This vertex exists by our DFS tie-breaking  
 1172 rule and the fact that there is an edge between, say,  $a_{2,1}$  and  $b_{2,1}$  (recall that this edge  
 1173 links  $A_2$  and  $B_1$ ). We initialize three pointers  $z, j_b, j_e$  and two sets  $\mathcal{S}, \mathcal{L}$  as follows:  $z := v_1$   
 1174 (the starting vertex in the DFS discovery order),  $j_b := 1$ ,  $j_e := (h(t) - 2)/2 = 2^{4t}$ ,  $\mathcal{S} := \emptyset$ ,  
 1175 and  $\mathcal{L} := \emptyset$ . Informally the indices  $j_b$  (begin) and  $j_e$  (end) lowerbound and upperbound,  
 1176 respectively, the indices of the sets  $\{D_j\}_j$  we are still working with. Every vertex  $v \prec z$  is  
 1177 simply disregarded.

1178 The sets  $\mathcal{S}$  and  $\mathcal{L}$  collect vertices (all discovered before  $B_1$  in the Lex-DFS order) which  
 1179 can be utilized to form a large biclique minor in two different ways. Vertices stored in  $\mathcal{S}$

1180 are not adjacent to too many  $\{D_j\}_j$ , thus they can be used to “connect” the components  
 1181 of some  $D_j - \{v\}$  without losing too many other  $D_{j'}$ . Vertices stored in  $\mathcal{L}$  are adjacent to  
 1182 very many  $\{D_j\}_j$ , so they can directly form a biclique minor with the leftmost connected  
 1183 component of the corresponding  $\{D_j\}_j$ .

1184 Let  $j_1 \in [(h(t) - 2)/2]$  be the smallest index such that  $N_G(C_{\ell(j_1)})$  does not contain  $z_1$ .  
 1185 We distinguish two cases:  $j_1 \leq (h(t) - 2)/4 = 2^{4t-1}$  and  $j_1 > 2^{4t-1}$ . If  $j_1 \leq 2^{4t-1}$ , we will  
 1186 use  $z_1$  to connect all connected components intersecting  $D_1$ : that is,  $C_{\ell(1)}, C_{\ell(1)+1}, \dots, C_{r(1)}$ .  
 1187 In that case, we set:  $j_b := j_1$  and  $\mathcal{S} := \mathcal{S} \cup \{z_1\}$ .

1188 If instead  $j_1 > 2^{4t-1}$ , we will use  $z_1$  itself as a possible vertex of a biclique minor. In that  
 1189 case we set:  $j_e := j_1 - 1$  and  $\mathcal{L} := \mathcal{L} \cup \{z_1\}$ . Observe that in both cases the length  $|j_e - j_b|$   
 1190 is at most halved. Hence we can repeat this process  $\log 2^{4t}/2 = 2t$  times. In both cases we  
 1191 replace the current  $z$  by the successor of  $z_1$  in the DFS discovery order.

1192 At the second step, we let  $z_2 \in N_G(C_{r(j_b)})$  be such that for every  $z' \in N_G(C_{r(j_b)})$  with  
 1193  $z \preceq z'$ , then  $z_2 \prec z'$ . In words,  $z_2$  is the first vertex (in the discovery order) appearing after  $z$   
 1194 with a neighbor in the last connected component  $C_i$  intersecting the current first  $D_j$ , namely  
 1195  $D_{j_b}$ . Again this vertex exists by the DFS tie-breaking rule. We define  $j_2 \in [j_b, j_e]$  as the  
 1196 smallest index such that  $N_G(C_{\ell(j_2)})$  does not contain  $z_2$ . We distinguish two cases:  $j_2$  below  
 1197 or above the threshold  $(j_b + j_e)/2$ , and so on.

1198 **Building a large minor when  $|\mathcal{L}|$  is large.** After  $\log((h(t) - 2)/2)/2 = 2t$  steps,  $\max(|\mathcal{S}|, |\mathcal{L}|)$   
 1199  $\geq t$ . Indeed at each step, we increase  $|\mathcal{S}| + |\mathcal{L}|$  by one unit. Also the length  $|j_e - j_b|$  after  
 1200 these steps is still not smaller than  $2^{4t}/2^{2t} = 2^{2t}$ . If  $|\mathcal{L}| \geq t$ , then we exhibit a  $K_{t,t}$ -minor in  
 1201  $G$  in the following way. We contract  $C_{\ell(j)}$  to a single vertex, for every  $j \in [j_b, j_e]$  (recall that  
 1202  $|j_e - j_b| > 2^{2t}$ ). These vertices form with the vertices of  $\mathcal{L}$  a  $K_{2^{2t}, |\mathcal{L}|}$ , thus a  $K_{t,t}$ -minor, and  
 1203 a  $K_t$ -minor.

1204 **Building a large minor when  $|\mathcal{S}|$  is large.** If instead  $|\mathcal{S}| \geq t$ , then we exhibit the following  
 1205  $K_{t,t}$ -minor. We use each  $z_i \in \mathcal{S}$ , to connect the corresponding sets  $D_j \setminus \{v\}$ . We contract  
 1206  $\{z_i\} \cup D_j \setminus \{v\}$  to a single vertex. We then contract all the disjoint paths  $A'_i$  (recall Lemma 18)  
 1207 which are not  $A'_{g(t)/2}$  nor contain a vertex in  $\mathcal{S}$ . This represents at least  $g(t)/2 - 1 - 2t > t$   
 1208 vertices. This yields a biclique  $K_{t,t}$ , hence  $G$  as a  $K_t$ -minor.

1209 **Concluding on the twin-width of  $G$ .** The two previous paragraphs reach a contradiction.  
 1210 Hence the adjacency matrix  $M$  is  $g(t)$ -mixed free, and even  $g(t)$ -grid free. By Theorem 10  
 1211 this implies that the twin-width of  $G$  is at most  $4c_{g(t)}2^{4c_{g(t)}+2}$ , where  $c_k := 8/3(k+1)^{2^{4k}}$ ,  
 1212 which was the announced triple-exponential bound.  $\blacktriangleleft$

1213 Applied to planar graphs, which are  $K_5$ -minor free, the previous theorem gives us a  
 1214 constant bound on the twin-width, but that constant has billions of digits. We believe that  
 1215 the correct bound should have only one digit. It is natural to ask for a more reasonable  
 1216 bound in the case of planar graphs. An attempt could be to show that for a large enough  
 1217 integer  $d$ , every planar  $d$ -trigraph admits a  $d$ -contraction which preserves planarity. However  
 1218 Figure 7 shows that this statement does not hold.

## 1219 **7 FO model checking**

1220 In this section, we show that deciding first-order properties in  $d$ -collapsible graphs is fixed-  
 1221 parameter tractable in  $d$  and the size of the formula. We let  $E$  be a binary relation symbol.

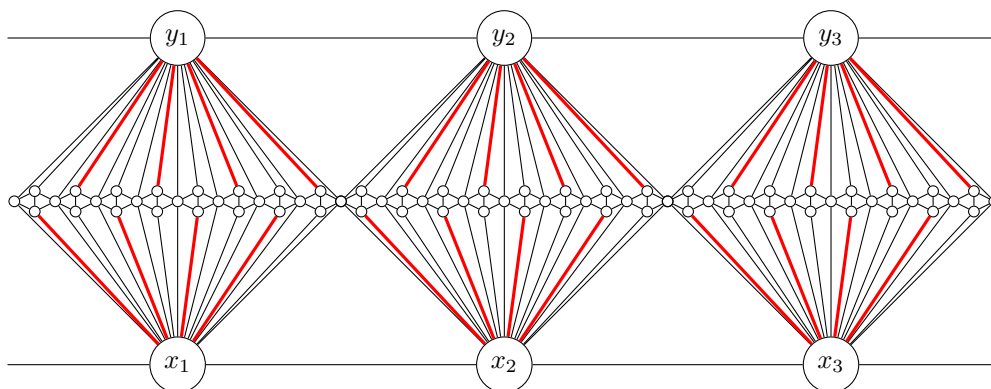

■ **Figure 7** For every integer  $d$  (here  $d = 4$ ), a planar  $d$ -trigraph without any  $d$ -contraction to a planar graph. The graph should be thought of as wrapped around a cylinder: there are edges  $x_1x_3$  and  $y_1y_3$ , and the leftmost and rightmost vertices are actually the same vertex.

1222 A graph  $G$  is seen as an  $\{E\}$ -structure with universe  $V(G)$  and binary relation  $E(G)$  (matching  
1223 the arity of  $E$ ). A *sentence* is a formula without free variables.

A *formula*  $\phi$  in *prenex normal form*, or simply *prenex formula*, is any sentence written as a sequence of non-negated quantifiers followed by a quantifier-free formula:

$$\phi = Q_1x_1Q_2x_2 \dots Q_\ell x_\ell \phi^*$$

1224 where for each  $i \in [\ell]$ , the variable  $x_i$  ranges over  $V(G)$ ,  $Q_i \in \{\forall, \exists\}$ , while  $\phi^*$  is a Boolean  
1225 combination in atoms of the form  $x_i = x_j$  and  $E(x_i, x_j)$ . Here we call *length* of  $\phi$  its number  
1226 of variables  $\ell$ . Note that this also corresponds to its quantifier depth. Every formula with  
1227 quantifier depth  $k$  can be rewritten as a prenex formula of depth  $\text{Tower}(k + \log^* k + 3)$  (see  
1228 Theorem 2.2. and inequalities (32) in [28]).

1229 ► **Theorem 21.** *Given as input a prenex formula  $\phi$  of length  $\ell$ , an  $n$ -vertex graph  $G$ , and a*  
1230  *$d$ -sequence of  $G$ , one can decide  $G \models \phi$  in time  $f(\ell, d) \cdot n$ .*

1231 Our proof of Theorem 21 is not specific to a single formula. Instead we compute a tree  
1232 of size bounded by a function of  $\ell$ , which is sufficient to check every prenex formula  $\phi$  of  
1233 length  $\ell$ .

## 1234 7.1 Morphism trees and shuffles

1235 All our trees are rooted and the root is denoted by  $\varepsilon$ . An *internal node* is a node with at least  
1236 one child. Non-internal nodes are called *leaves*. Given a node  $x_i$  in a tree  $T$ , we call *current*  
1237 *path* of  $x_i$  the unique path  $\varepsilon, x_1, \dots, x_i$  from  $\varepsilon$  to  $x_i$  in  $T$ . We will see this current path as  
1238 the tuple  $(x_1, \dots, x_i)$ . The current path of  $\varepsilon$  is the empty tuple, also denoted by  $\varepsilon$ . The  
1239 *depth* of a node  $x$  is the number of edges in the current path of  $x$ . A node  $x$  is a *descendant*  
1240 of  $y$  if  $y$  belongs to the current path of  $x$ . Given a tree  $T$ , we denote the parent of  $x$  by  
1241  $p_T(x)$ . Two nodes with the same parent are *siblings*. We denote by  $T^*$  the set of nodes of  $T$   
1242 distinct from its root  $\varepsilon$ , that is  $V(T) \setminus \{\varepsilon\}$ .

1243 A bijection  $f$  between the node-sets of two trees  $T_1, T_2$  is an *isomorphism* if it commutes  
1244 with the parent relation, i.e.,  $p_{T_2}(f(x)) = f(p_{T_1}(x))$  for every node  $x \in T_1^*$ . One can observe  
1245 that  $f^{-1} : V(T_2) \rightarrow V(T_1)$  is then also an isomorphism. Two trees are said *isomorphic* if  
1246 there is an isomorphism between them. An isomorphism mapping  $T$  to itself is called an

1247 *automorphism*. Given a node  $x$  in  $T$ , the *subtree* of  $x$ , denoted by  $B_T(x)$ , is the subtree of  $T$   
 1248 rooted at  $x$  and containing all descendants of  $x$ .

1249 An  $i$ -*tuple* is a tuple on exactly  $i$  elements, and a  $\leq i$ -*tuple* is a tuple on at most  $i$   
 1250 elements. A *subtuple* of a tuple  $a$  is any tuple obtained by erasing some entries of  $a$ . Given a  
 1251 tuple  $a = (a_i)$  and a set  $X$ , the *subtuple of  $a$  induced by  $X$* , denoted by  $a|_X$  is the subtuple  
 1252 consisting of the entries  $a_i$  which belongs to  $X$ . Given two disjoint sets  $A$  and  $B$ , and two  
 1253 tuples  $a \in A^s$  and  $b \in B^t$ , a *shuffle*  $c$  of  $a$  and  $b$  is any tuple of  $(A \cup B)^{s+t}$  such that  $c|_A = a$   
 1254 and  $c|_B = b$ . For instance  $(2, 0, 3, 1, 0)$  is one of the ten shuffles of  $(0, 1, 0)$  and  $(2, 3)$ . Given a  
 1255 tuple  $x = (x_1, \dots, x_{k-1}, x_k)$ , the *prefix* of  $x$  is  $(x_1, \dots, x_{k-1})$  if  $k > 1$ , and  $\varepsilon$  if  $k = 1$ .

1256 Given two trees  $T_1$  and  $T_2$  whose nodes are supposed disjoint, the *shuffle*  $s(T_1, T_2)$  of  $T_1$   
 1257 and  $T_2$  is the tree whose nodes are shuffles of all pairs of tuples  $P_1, P_2$  where  $P_1$  is a current  
 1258 path in  $T_1$  and  $P_2$  is a current path in  $T_2$ . The parent relation in  $s(T_1, T_2)$  is the prefix  
 1259 relation. The  $\ell$ -*shuffle*  $s_\ell(T_1, T_2)$  of  $T_1$  and  $T_2$  is the subtree of  $s(T_1, T_2)$  obtained by keeping  
 1260 only the nodes with depth at most  $\ell$ .

1261 The formal definition of shuffle is somewhat cumbersome since the current path of the node  
 1262  $(x_1, x_2, \dots, x_i)$  is the tuple  $((x_1), (x_1, x_2), \dots, (x_1, x_2, \dots, x_i))$ . Given a set  $V$ , a *morphism-*  
 1263 *tree in  $V$*  is a pair  $(T, m)$  where  $T$  is a tree and  $m$  is a mapping from  $T^*$  to  $V$ . Given a set  
 1264  $V$  and an integer  $\ell$ , we define the (complete)  $\ell$ -*morphism-tree*  $MT_\ell(V) = (T_{V,\ell}, m_{V,\ell})$  as the  
 1265 morphism-tree in  $V$  such that for every positive integer  $i \leq \ell$  and every  $i$ -tuple  $(v_1, \dots, v_i)$   
 1266 of possibly repeated elements of  $V$ , there is a unique node  $x_i$  of  $T_{V,\ell}$  whose current path  
 1267  $(x_1, \dots, x_i)$  satisfies  $m_{V,\ell}(x_j) = v_j$  for all  $j = 1, \dots, i$ . Informally,  $MT_\ell(V)$  represents all the  
 1268 ways of extending the empty set by iteratively adding one (possibly repeated) element of  $V$   
 1269 up to depth  $\ell$  in a tree-search fashion. Note that if  $V$  has size  $n$ , the number of nodes of  
 1270  $MT_\ell(V)$  is  $n^\ell + n^{\ell-1} + \dots + 1$ . The formal way of defining  $MT_\ell(V)$  is to consider that  $T_{V,\ell}$   
 1271 is the set of all tuples  $u = (u_1, \dots, u_i)$  of elements of  $V$  with  $0 \leq i \leq \ell$ , the parent relation is  
 1272 the prefix relation, and the image by  $m_{V,\ell}$  of a tuple  $(u_1, \dots, u_i)$  is  $u_i$ .

1273 Again, the formal definition of  $MT_\ell(V)$  is cumbersome since the current path of the  
 1274 node  $(u_1, u_2, \dots, u_i)$  is the tuple  $((u_1), (u_1, u_2), \dots, (u_1, u_2, \dots, u_i))$ . Hence, as an abuse of  
 1275 language, we may identify a node  $(u_1, u_2, \dots, u_i)$  to its current path. We can extend the  
 1276 notion of shuffle to morphism-trees by defining  $(T, m)$  as the *shuffle* of  $(T_1, m_1)$  and  $(T_2, m_2)$   
 1277 where  $T$  is the shuffle of  $T_1$  and  $T_2$  (supposed again on disjoint node-sets) and for every  
 1278 node  $x = (x_1, \dots, x_k)$  of  $T$ , we let  $m(x) = m_1(x_k)$  if  $x_k \in T_1^*$  and  $m(x) = m_2(x_k)$  if  $x_k \in T_2^*$ .  
 1279 Again, we define the  $\ell$ -shuffle by pruning the nodes with depth more than  $\ell$ .

1280 ► **Lemma 22.** *Let  $(V_1, V_2)$  be a partition of a set  $V$ . The  $\ell$ -shuffle of  $MT_\ell(V_1)$  and  $MT_\ell(V_2)$   
 1281 is  $MT_\ell(V)$ .*

1282 **Proof.** This follows from the fact that every  $\leq \ell$ -tuple of  $V$  is uniquely obtained as the  
 1283 shuffle of some  $\leq \ell$ -tuple of  $V_1$  and some  $\leq \ell$ -tuple of  $V_2$ . ◀

1284 One can extend the definition of shuffle to several trees. Given a sequence of (node  
 1285 disjoint) morphism trees  $(T_1, m_1), \dots, (T_k, m_k)$ , the nodes of the shuffle  $(T, m)$  are all tuples  
 1286 which are shuffles  $S$  of current paths  $P_1, \dots, P_k$ . Precisely, a tuple  $S$  is a node of  $(T, m)$  if  
 1287 all its entries are non-root nodes of  $T_i$ 's, and such that each subtuple  $S_i$  of  $S$  induced by  
 1288 the nodes of  $T_i$  is a (possibly empty) current path of  $T_i$ . As usual the parent relation is the  
 1289 prefix relation. Finally  $m(x_1, \dots, x_i)$  is equal to  $m_j(x_i)$  where  $x_i \in T_j$ . We speak of  $\ell$ -shuffle  
 1290 when we prune out the nodes with depth more than  $\ell$ . Note that  $MT_\ell(V)$  is the  $\ell$ -shuffle of  
 1291  $MT_\ell(\{v\})$  for all  $v \in V$ .

## 1292 7.2 Morphism trees in graphs and reductions

1293 We extend our previous definitions to graphs. The first step is to introduce graphs on tuples.  
 1294 A *tuple graph* is a pair  $(x, G)$  where  $x$  is a tuple  $(x_1, \dots, x_t)$  and  $G$  is a graph on the vertex-set  
 1295  $\{x_1, \dots, x_t\}$  (where repeated vertices are counted only once). Thus there is an edge  $x_i x_j$   
 1296 in  $(x, G)$  if  $x_i x_j$  is an edge of  $G$ . The main difference with graphs is that vertices can be  
 1297 repeated within a tuple. In particular if  $x_1 = x_3$  and there is an edge  $x_1 x_2$ , then the edge  
 1298  $x_2 x_3$  is also present. Two tuple graphs  $(x, G)$  and  $(y, H)$  are *isomorphic* if  $x = (x_1, \dots, x_t)$ ,  
 1299  $y = (y_1, \dots, y_t)$  and we have both  $x_i = x_j \Leftrightarrow y_i = y_j$ , and  $x_i x_j \in E(G) \Leftrightarrow y_i y_j \in E(H)$ , for  
 1300 every  $i, j \in [t]$ .

1301 A *morphism-tree* in  $G$  is a morphism-tree  $(T, m)$  in  $V(G)$ , supporting new notions based  
 1302 on the edge-set of  $G$ . Given a node  $x_i$  of  $T$  with current path  $(x_1, \dots, x_i)$ , the graph  $G$  induces  
 1303 a tuple graph on  $(m(x_1), \dots, m(x_i))$ , namely  $((m(x_1), \dots, m(x_i)), G[\{m(x_1), \dots, m(x_i)\}])$ .  
 1304 We call *current graph* of  $x_i$  this tuple graph. Given a node  $x_i$  and one of its children  $x_{i+1}$ ,  
 1305 observe that the current graph of  $x_{i+1}$  extends the one of  $x_i$  by one (possibly repeated)  
 1306 vertex. Informally, a morphism-tree in  $G$  can be seen as a way of iteratively extending  
 1307 induced subgraphs of  $G$  in a tree-search fashion.

1308 Two morphism-trees  $(T, m)$  in  $G$  and  $(T', m')$  in  $G'$  are *isomorphic* if there exists an  
 1309 isomorphism  $f$  from  $T$  to  $T'$  such that for every node  $x \in T^*$  and  $y$  descendant of  $x$ :

- 1310 ■  $m(x) = m(y)$  if and only  $m'(f(x)) = m'(f(y))$ .
- 1311 ■  $m(x)m(y)$  is an edge of  $G$  if and only  $m'(f(x))m'(f(y))$  is an edge of  $G'$ .

1312 In particular, the current graph of a node is isomorphic to the current graph of its image.  
 1313 Again an isomorphism  $f$  from  $(T, m)$  into itself is called an *automorphism*. Two sibling nodes  
 1314  $x, x'$  of a morphism-tree  $(T, m)$  are *equivalent* if there exists an automorphism  $f$  of  $(T, m)$   
 1315 such that  $f(x) = x'$  and  $f(x') = x$ . Note that if such an automorphism exists, then there  
 1316 is one which is the identity function outside of  $B_T(x) \cup B_T(x')$ . The interpretation of  $x, x'$   
 1317 being equivalent is that the current graph  $H$  of their parent can be extended up to depth  $\ell$   
 1318 in  $G$  in exactly the same way starting from  $x$  or from  $x'$ .

1319 The (complete)  $\ell$ -*morphism-tree*  $MT_\ell(G)$  of a graph  $G$  is simply<sup>7</sup>  $MT_\ell(V(G))$ . Observe  
 1320 that while  $E(G)$  is irrelevant for the syntactic aspect of  $MT_\ell(G)$ , the structure of  $G$  is  
 1321 nonetheless important for semantic properties of  $MT_\ell(G)$ . Indeed equivalent nodes are  
 1322 defined in  $MT_\ell(G)$  but not in  $MT_\ell(V(G))$ . Let us give a couple of examples to clarify that  
 1323 point. When  $G$  is a clique, all the sibling nodes are equivalent in  $MT_\ell(G)$ . When  $G$  is a  
 1324 path on the same vertex-set, the depth-1 nodes of  $MT_\ell(G)$  mapped to the first and second  
 1325 vertices of the path are in general *not* equivalent.

1326 Given two equivalent (sibling) nodes  $x, x'$  of a morphism-tree  $(T, m)$  in  $G$ , the  $x, x'$ -  
 1327 *reduction* of  $(T, m)$  is the morphism-tree obtained by deleting all descendants of  $x'$  (including  
 1328 itself). A *reduction* of a morphism-tree is any morphism-tree obtained by iterating a sequence  
 1329 of  $x, x'$ -reductions. Finally a *reduct* of  $(T, m)$  is a reduction in which no further reduction  
 1330 can be performed; that is, none of the pairs of siblings are equivalent.

1331 ► **Lemma 23.** *Any reduct of an  $\ell$ -morphism-tree has size at most  $h(\ell)$  for some function  $h$ .*

1332 **Proof.** Assume that  $(T, m)$  is a reduct of an  $\ell$ -morphism-tree in a graph  $G$ . Consider a node  
 1333  $x_{\ell-1}$  of depth  $\ell - 1$  in  $T$ . The maximum number of pairwise non-equivalent children  $x_\ell$  of  
 1334  $x_{\ell-1}$  is at most  $2^{\ell-1} + \ell - 1$ . Indeed there are (at most)  $2^{\ell-1}$  non isomorphic extensions of

<sup>7</sup> Technically, we should denote it by  $(MT_\ell(V(G)), G)$  but we will stick to this simpler notation.

1335 the current graph of  $x_{\ell-1}$  by adding the new node  $m(x_\ell)$ , and (at most)  $\ell - 1$  possible ways  
 1336 for  $m(x_\ell)$  to be a repetition of a vertex among  $m(x_1), \dots, m(x_{\ell-1})$ . In particular  $x_{\ell-1}$  has a  
 1337 bounded number of children in the reduct  $(T, m)$ , and therefore, there exist only a bounded  
 1338 number of non-equivalent  $x_{\ell-1}$  which are children of some  $x_{\ell-2}$ . This bottom-up induction  
 1339 bounds the size of  $(T, m)$  by a tower function in  $\ell$ . ◀

1340 Since  $MT_\ell(G)$  represents all possible ways of iterating at most  $\ell$  vertex extensions of  
 1341 induced subgraphs of  $G$  (starting from the empty set), one can check any prenex formula  
 1342  $\phi$  of depth at most  $\ell$  on  $MT_\ell(G)$ . In the language of games,  $MT_\ell(G)$  captures all possible  
 1343 games for Player  $\exists$  and Player  $\forall$  to form a joint assignment of the variables  $x_1, \dots, x_\ell$ . So far  
 1344 this does not constitute an efficient algorithm since the size of  $MT_\ell(G)$  is  $O(n^{\ell+1})$ . However  
 1345 reductions –deletions of one of two equivalent alternatives for a player– do not change the  
 1346 score of the game. Thus we want to compute reductions, or even reducts, and decide  $\phi$  on  
 1347 these smaller trees.

1348 ▶ **Lemma 24.** *Given a reduction of  $MT_\ell(G)$  of size  $s$  and a prenex formula on  $\ell$  variables,  
 1349  $G \models \phi$  can be decided in time  $O(s)$ , and in time  $h(\ell)$  if the reduction is a reduct.*

1350 **Proof.** Let  $\phi = Q_1 x_1 Q_2 x_2 \dots Q_\ell x_\ell \phi^*$ , where  $\phi^*$  is quantifier-free. Let  $T$  be the tree of the  
 1351 given reduction of  $MT_\ell(G)$ . We relabel the nodes of  $T$  in the following way. At each leaf  
 1352  $(v_1, \dots, v_\ell)$  of  $T$ , we put a 1 if  $\phi^*(v_1, \dots, v_\ell)$  is true, and a 0 otherwise. For each  $i \in [0, \ell - 1]$ ,  
 1353 at each internal node of depth  $i$ , we place a max if  $Q_{i+1} = \exists$ , and a min if  $Q_{i+1} = \forall$ . The  
 1354 computed value at the root of this minimax tree is 1 if  $G \models \phi$ , and 0 otherwise. Indeed this  
 1355 value does not change while we perform reductions on  $MT_\ell(G)$ . The overall running time  
 1356 is  $O(|T|)$ . By Lemma 23, if  $T$  is a reduct then the overall running time is  $h(\ell)$  for some tower  
 1357 function  $h$ . ◀

1358 Let us now denote by  $MT'_\ell(G)$  any reduct of  $MT_\ell(G)$ . It can be shown by local confluence  
 1359 that  $MT'_\ell(G)$  is indeed unique up to isomorphism, but we do not need this fact here. Now  
 1360 our strategy is to compute  $MT'_\ell(G)$  in linear FPT time using bounded twin-width.

1361 We base our computation on a sequence of partitions of  $V(G)$  achieving twin-width  $d$ . Let  
 1362  $\mathcal{P} = \{X_1, \dots, X_p\}$  be a partition of  $V(G)$ . Two distinct parts  $X_i, X_j$  of  $\mathcal{P}$  are *homogeneous*  
 1363 if there are between  $X_i$  and  $X_j$  either all the edges or no edges. Let  $G_{\mathcal{P}}$  be the graph  
 1364 on vertex-set  $\mathcal{P}$  and edge-set all the pairs  $X_i X_j$  such that  $X_i, X_j$  are distinct and not  
 1365 homogeneous. If  $G_{\mathcal{P}}$  has maximum degree at most  $d$ , we say that  $\mathcal{P}$  is a  *$d$ -partition* of  $G$ .  
 1366 Note that an  $n$ -vertex graph  $G$  has twin-width at most  $d$  if it admits a *sequence of  $d$ -partitions*  
 1367  $\mathcal{P}_n, \mathcal{P}_{n-1}, \dots, \mathcal{P}_1$  where  $\mathcal{P}_n$  is the finest partition, and for every  $i \in [n - 1]$ , the partition  $\mathcal{P}_i$   
 1368 is obtained by merging two parts of  $\mathcal{P}_{i+1}$ .

1369 Our central result is:

1370 ▶ **Theorem 25.** *A reduct  $MT'_\ell(G)$  can be computed in time  $f(\ell, d) \cdot n$ , given as input  
 1371 a sequence of  $d$ -partitions of  $G$ .*

1372 The proof will compute  $MT'_\ell(G)$  iteratively by combining partial morphism-trees obtained  
 1373 alongside the sequence of  $d$ -partitions. We start with the finest partition  $\mathcal{P}_n$ , where each  
 1374 morphism-tree is defined on a single vertex, and we finish with the coarsest partition  $\mathcal{P}_1$   
 1375 which results in the sought  $MT'_\ell(G)$ . We will thus need to define a morphism-tree for a  
 1376 partitioned graph. Before coming to these technicalities, let us illustrate how shuffles come  
 1377 into play for computing  $MT'_\ell(G)$ . The following two lemmas are not needed for the rest  
 1378 of the proof, but they provide a good warm-up for the more technical arguments involving  
 1379 partitions.

1380 The disjoint union  $G_1 \cup G_2$  of two graphs  $G_1, G_2$  with pairwise-disjoint vertex-sets is the  
 1381 graph on  $V(G_1) \cup V(G_2)$  with no edges between the two graphs  $G_1, G_2$ . In this particular  
 1382 case, reductions commute with shuffle.

1383 ► **Lemma 26.** *Let  $(T_1, m_1)$  and  $(T_2, m_2)$  be two morphism-trees in  $G_1$  and in  $G_2$ , respectively  
 1384 (on disjoint vertex-sets). Let  $(T, m)$  be the shuffle of  $(T_1, m_1)$  and  $(T_2, m_2)$ , defined in  $G_1 \cup G_2$ .  
 1385 Let  $(T'_1, m'_1)$  be a reduction of  $(T_1, m_1)$ . Then the shuffle  $(T', m')$  of  $(T'_1, m'_1)$  and  $(T_2, m_2)$  is  
 1386 a reduction of  $(T, m)$ .*

1387 **Proof.** We just need to show the lemma for single-step reductions. Indeed after we prove  
 1388 that shuffling morphism-trees defined on a disjoint union commutes with a single reduction  
 1389 performed in the first morphism-tree, we can iterate this process to establish that it commutes  
 1390 with reductions in general. Let  $f$  be an automorphism of  $(T_1, m_1)$  which swaps the equivalent  
 1391 nodes  $x, x'$  and is the identity outside of the subtrees rooted at  $x$  and  $x'$ . Let  $(T'_1, m'_1)$  be the  
 1392  $x, x'$ -reduction of  $(T_1, m_1)$ . Consider the mapping  $g$  from  $V(T)$  into itself which preserves the  
 1393 root  $\varepsilon$  and maps every node  $Z = (z_1, \dots, z_k)$  to  $Z' = (\tilde{f}(z_1), \dots, \tilde{f}(z_k))$  where  $\tilde{f}(z_i) = f(z_i)$   
 1394 if  $z_i \in T_1^*$  and  $\tilde{f}(z_i) = z_i$  if  $z_i \in T_2^*$ .

1395 We claim that  $g$  is an automorphism of  $(T, m)$ . It is bijective since  $f$  is bijective. It  
 1396 commutes with the parent relation since  $p_T(g(Z)) = p_T(g(z_1, \dots, z_{k-1}, z_k)) = p_T(\tilde{f}(z_1), \dots,$   
 1397  $\tilde{f}(z_{k-1}), \tilde{f}(z_k)) = (\tilde{f}(z_1), \dots, \tilde{f}(z_{k-1})) = g(p_T(Z))$ . Furthermore  $g$  behaves well with  
 1398 the morphism  $m$ . Indeed, for every node  $Z_1 = (z_1, \dots, z_i)$  of  $T$  and descendant  $Z_2 =$   
 1399  $(z_1, \dots, z_i, z_{i+1}, \dots, z_k)$ , we have:

- 1400 ■ If  $m(Z_1) = m(Z_2)$ , we either have  $z_i, z_k \in T_1^*$  and  $m_1(z_i) = m_1(z_k)$  and thus  $m_1(f(z_i)) =$   
 1401  $m_1(f(z_k))$  which implies  $m(g(Z_1)) = m_1(f(z_i)) = m_1(f(z_k)) = m(g(Z_2))$ . Or we have  
 1402  $z_i, z_k \in T_2$  and  $m_2(z_i) = m_2(z_k)$  which implies  $m(g(Z_1)) = m_2(z_i) = m_2(z_k) = m(g(Z_2))$ .
- 1403 ■ If  $m(Z_1)m(Z_2)$  is an edge of  $G_1 \cup G_2$  we either have  $z_i, z_k \in T_1^*$  and  $m_1(z_i)m_1(z_k)$  is  
 1404 an edge of  $G_1$ , or  $z_i, z_k \in T_2$  and  $m_2(z_i)m_2(z_k)$  is an edge of  $G_2$ . In the first case,  
 1405  $m_1(f(z_i))m_1(f(z_k))$  is an edge of  $G_1$  and we conclude since  $m_1(f(z_i))m_1(f(z_k)) =$   
 1406  $m(g(Z_1))m(g(Z_2))$ . In the second case,  $m_2(z_i)m_2(z_k) = m(g(Z_1))m(g(Z_2))$  is an edge of  
 1407  $G_2$ . Thus  $g$  maps edges to edges, and therefore non-edges to non-edges.

1408 Finally, consider any node  $Z = (z_1, \dots, z_k)$  of  $(T, m)$  such that  $z_k = x$ . By definition  
 1409 of the shuffle and the fact that  $x, x'$  are siblings, there is a node  $Z' = (z_1, \dots, z_{k-1}, x')$  in  
 1410  $(T, m)$ . By construction, we have  $g(Z) = Z'$  and  $g(Z') = Z$  and thus  $Z, Z'$  are equivalent in  
 1411  $(T, m)$ . Therefore we can reduce all such pairs  $Z, Z'$  in  $(T, m)$  in order to find a reduction in  
 1412 which we have deleted all nodes of  $(T, m)$  containing the entry  $x'$ , and therefore also all its  
 1413 descendants in  $T_1$ . This is exactly the shuffle  $(T', m')$  of  $(T'_1, m'_1)$  and  $(T_2, m_2)$ . ◀

1414 The previous lemma similarly holds for  $\ell$ -shuffles. We can now handle the disjoint union of  
 1415 two graphs.

1416 ► **Lemma 27.** *Given as input  $MT'_\ell(G)$  and  $MT'_\ell(H)$ , two reducts of the graphs  $G$  and  $H$ ,  
 1417 one can compute a reduct  $MT'_\ell(G \cup H)$  in time only depending on  $\ell$ .*

1418 **Proof.** We just have to compute the  $\ell$ -shuffle  $(T, m)$  of  $MT'_\ell(G)$  and  $MT'_\ell(H)$ , in time  
 1419 depending on  $\ell$  only. Indeed, by Lemma 22 the  $\ell$ -shuffle of  $MT_\ell(G)$  and  $MT_\ell(H)$  is  $MT_\ell(G \cup$   
 1420  $H)$ . Therefore, by repeated use of Lemma 26 applied to the sequence of reductions from  
 1421  $MT_\ell(G)$  to  $MT'_\ell(G)$  and from  $MT_\ell(H)$  to  $MT'_\ell(H)$ , the morphism-tree  $(T, m)$  is a reduction  
 1422 of  $MT_\ell(G \cup H)$ . Note that  $(T, m)$  is not necessarily a reduct but its size is bounded, and we  
 1423 can therefore reduce it further by a brute-force algorithm to obtain a reduct  $MT'_\ell(G \cup H)$ . ◀



1424 We now extend our definitions to partitioned graphs. Let  $G$  be a graph and  $\mathcal{P}$  be a  
 1425 partition of  $V(G)$ . A morphism-tree  $(T, m)$  in  $(G, \mathcal{P})$  is again a morphism-tree in  $V(G)$ . The  
 1426 difference with a morphism-tree in  $G$  lies in the allowed reductions. Now an automorphism  $f$   
 1427 of  $(T, m)$  in  $(G, \mathcal{P})$  is an automorphism of  $(T, m)$  in  $G$  which respects the partition  $\mathcal{P}$ .  
 1428 Formally, for any node  $x \in T^*$ , the vertices  $m(x)$  and  $m(f(x))$  belong to the same part of  $\mathcal{P}$ .  
 1429 Two sibling nodes  $x, x'$  in a morphism-tree  $(T, m)$  in  $(G, \mathcal{P})$  are equivalent if there is an  
 1430 automorphism of  $(T, m)$  in  $(G, \mathcal{P})$  which swaps  $x$  and  $x'$  (and in particular,  $m(x)$  and  $m(x')$ )  
 1431 are in the same part of  $\mathcal{P}$ ).

1432 As previously, we define  $MT_\ell(G, \mathcal{P})$  for a partitioned graph  $(G, \mathcal{P})$  as equal to  $MT_\ell(V(G))$ ,  
 1433 and we define  $MT'_\ell(G, \mathcal{P})$  as any reduct of  $MT_\ell(G, \mathcal{P})$ , where reductions are performed in  
 1434  $(G, \mathcal{P})$ . Observe that  $MT'_\ell(G, \mathcal{P})$  can be very different from  $MT'_\ell(G)$ . For instance if  $\mathcal{P}$  is  
 1435 the partition into singletons, no reduction is possible and thus  $MT'_\ell(G, \mathcal{P}) = MT_\ell(G, \mathcal{P})$ . At  
 1436 the other extreme, if  $\mathcal{P} = \{V(G)\}$ , then  $MT'_\ell(G, \mathcal{P})$  is a reduct of  $MT_\ell(G)$ .

1437 Our ultimate goal in order to use twin-width is to dynamically compute  $MT'_\ell(G, \mathcal{P}_1)$   
 1438 by deriving  $MT'_\ell(G, \mathcal{P}_i)$  from  $MT'_\ell(G, \mathcal{P}_{i+1})$ . This strategy cannot directly work since the  
 1439 initialization requires  $MT'_\ell(G, \mathcal{P}_n)$  which is equal to  $MT_\ell(G, \mathcal{P}_n)$  of size  $O(n^\ell)$ . Instead, we  
 1440 only compute a partial information for each  $(G, \mathcal{P}_i)$  consisting of all *partial morphism-trees*  
 1441  $MT'_\ell(G, \mathcal{P}_i, X)$  centered around  $X$ , where  $X$  is a part of  $\mathcal{P}_i$ . We will make this formal in  
 1442 the next section. Let us highlight though that for the initialization, the graph  $G_{\mathcal{P}_n}$  consists  
 1443 of isolated vertices, therefore its connected components are singletons. So the initialization  
 1444 step of our dynamic computation only consists of computing  $MT'_\ell(\{v\})$  for all vertices  $v$   
 1445 in  $G$ . Since all such trees consist of a path of length  $\ell$  whose non-root nodes are mapped  
 1446 to  $v$ , the total size of the initialization step is linear. However, observe that the  $\ell$ -shuffle of  
 1447 all these  $MT'_\ell(\{v\})$  gives  $MT'_\ell(G, \mathcal{P}_n)$ . The essence of our algorithm can be summarized as:  
 1448 Maintaining a linear amount of information, enough to build<sup>8</sup>  $MT'_\ell(G, \mathcal{P}_{i+1})$ , and updating  
 1449 this information at each step in time function of  $d$  and  $\ell$  only.

1450 To illustrate how we can make an update, let us assume that we are given a partitioned  
 1451 graph  $(G, \mathcal{Q}_1 \cup \mathcal{Q}_2)$  which can be obtained from the union of two partitioned graphs  $(G_1, \mathcal{Q}_1)$   
 1452 and  $(G_2, \mathcal{Q}_2)$  on disjoint sets of vertices by making every pair  $X \in \mathcal{Q}_1, Y \in \mathcal{Q}_2$  homogeneous.  
 1453 The proof of the next lemma is similar to the proof of Lemma 26.

1454 **► Lemma 28.** *The  $\ell$ -shuffle of the reducts  $MT'_\ell(G_1, \mathcal{Q}_1)$  and  $MT'_\ell(G_2, \mathcal{Q}_2)$  is a reduction*  
 1455 *of  $MT'_\ell(G, \mathcal{Q}_1 \cup \mathcal{Q}_2)$ .*

1456 Lemma 28 indicates how to merge two partial results into a larger one, when the partial  
 1457 computed solutions behave well, i.e., are pairwise homogeneous. But we are now facing  
 1458 the main problem: How to merge two partial solutions in the case of errors (red edges)  
 1459 in  $G_{\mathcal{P}_i}$ ? The solution is to compute the morphism-trees of overlapping subsets of parts  
 1460 of  $\mathcal{P}_i$ . Dropping the disjointness condition comes with a cost since shuffles of morphism-trees  
 1461 defined in overlapping subgraphs can create several nodes which have the same current graph.  
 1462 The difficulty is then to keep at most one copy of these nodes, in order to remain in the set  
 1463 of reductions of  $MT_\ell(G, \mathcal{P})$  of bounded size. The solution of pruning multiple copies of the  
 1464 same current graph is slightly technical, but relies on a fundamental way of decomposing a  
 1465 tuple graph induced by a partitioned graph  $(G, \mathcal{P})$ .

<sup>8</sup> while not explicitly computing it since it has linear size and would entail a quadratic running time

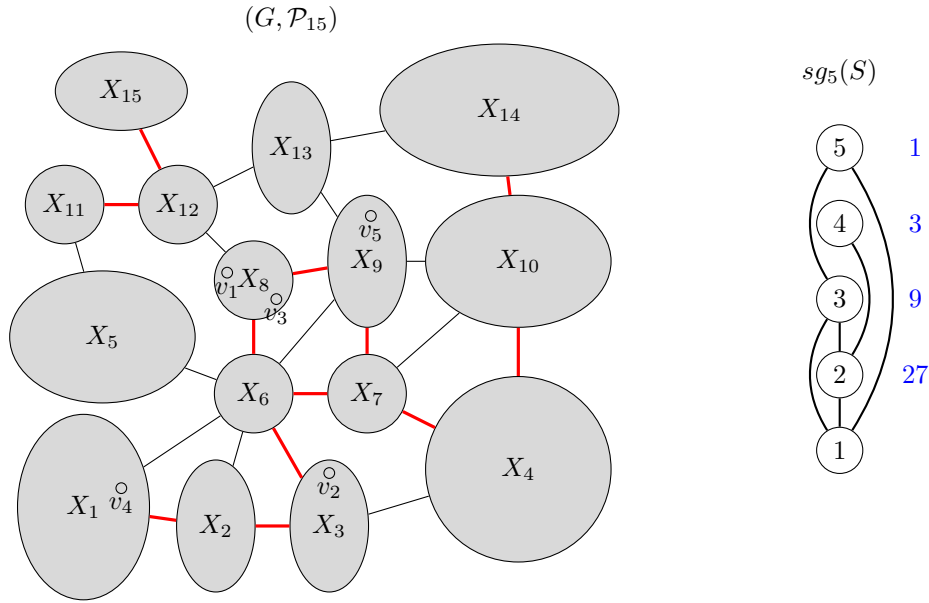

■ **Figure 8** Left: Partitioned graph  $(G, \mathcal{P}_{15})$  with the edges of  $G_{\mathcal{P}_{15}}$  in red. Right: The 5-sequence graph of  $S := (v_1 \in X_8, v_2 \in X_3, v_3 \in X_8, v_4 \in X_1, v_5 \in X_9)$ . In blue beside vertex  $i$ , the upperbound on the distance in  $G_{\mathcal{P}_{15}}$  for  $j < i$  to be linked to  $i$ . The graph  $sg_5(S)$  is connected so  $v_1, v_2, v_3, v_4, v_5$  have the same local root  $X_8 \ni v_1$  in  $S$ . Thus  $S$  is a connected tuple rooted at  $X_8$ .

1466 **7.3 Pruned shuffles**

1467 Let  $\ell > 0$  be some fixed integer,  $G$  be a graph and  $\mathcal{P}$  be a partition of  $V(G)$ . Given, for  $i \leq \ell$ ,  
 1468 a tuple  $S = (v_1, \dots, v_i)$  of vertices of  $G$  which respectively belong to the (non-necessarily  
 1469 distinct) parts  $(X_1, X_2, \dots, X_i)$  of  $\mathcal{P}$ , the  $\ell$ -sequence graph  $sg_\ell(S)$  on vertex-set  $[i]$  is defined  
 1470 as follows: there exists an edge  $jk$ , with  $j < k$ , if the distance between the part  $X_j$  and the  
 1471 part  $X_k$  is at most  $3^{\ell-k}$  in the graph  $G_{\mathcal{P}}$  (see Figure 8 for an illustration). This is rather  
 1472 technical, but  $sg_\ell(S)$  has some nice properties.

1473 ► **Lemma 29.** *If for  $a < b < c \in [i]$ ,  $ac$  and  $bc$  are edges of  $sg_\ell(S)$ , then  $ab$  is also an edge.*

1474 **Proof.** In  $G_{\mathcal{P}}$ , both the distances between  $X_a$  and  $X_c$ , and between  $X_b$  and  $X_c$ , are at most  
 1475  $3^{\ell-c}$ . So the distance between  $X_a$  and  $X_b$  is at most  $2 \cdot 3^{\ell-c}$  which is less than  $3^{\ell-b}$ . Hence  
 1476  $ab$  is also an edge. ◀

1477 Let  $j \in [i]$  be the minimum index of an element of the connected component of  $k \in [i]$  in  
 1478  $sg_\ell(S)$ . We call  $X_j$  the *local root* of  $v_k$  in  $S$ .

1479 ► **Lemma 30.** *Let  $S = (v_1, \dots, v_i)$  and  $k < i$ . The local root  $X_j$  of  $v_k$  in  $S$  is equal to the*  
 1480 *local root of  $v_k$  in the prefix  $S' = (v_1, \dots, v_{i-1})$ . Thus by induction the local root of  $v_k$  in  $S$*   
 1481 *is the local root of  $v_k$  in  $(v_1, \dots, v_k)$ .*

1482 **Proof.** From the definition,  $sg_\ell(S')$  is an induced subgraph of  $sg_\ell(S)$ . We just have to show  
 1483 that if there exists a path  $P$  from  $j$  to  $k$  in  $sg_\ell(S)$ , then there exists also a path in  $sg_\ell(S')$ .  
 1484 Let  $P$  be a shortest path from  $j$  to  $k$  in  $sg_\ell(S)$ . If  $P$  does not go through  $i$ , we are done. If  $P$   
 1485 goes through  $i$ , by Lemma 29 the two neighbors of  $i$  in  $P$  are joined by an edge, contradicting  
 1486 the minimality of  $P$ . ◀

1487 Note that by the definition of  $\text{sg}_\ell$ , if  $S'$  is a subtuple of  $S$ , the graph  $\text{sg}_\ell(S')$  is a supergraph  
 1488 of the induced restriction of  $\text{sg}_\ell(S)$  to the indices of  $S'$ . Indeed, an entry  $v_k$  with index  $k$  of  
 1489 the tuple  $S$  which appears in  $S'$  has an index  $k' \leq k$  in  $S'$ . Hence if  $j \leq k$  is connected to  $k$   
 1490 in  $\text{sg}_\ell(S)$  and  $v_j$  appears in  $S'$  with index  $j'$ , we have the edge  $j'k'$  since  $3^{\ell-k'} \geq 3^{\ell-k}$ . In  
 1491 particular, if  $S'$  corresponds to a connected component of  $\text{sg}_\ell(S)$ , the sequence graph  $\text{sg}_\ell(S')$   
 1492 is also connected.

1493 When the sequence graph  $\text{sg}_\ell(S)$  is connected, we say that  $S$  is a *connected tuple rooted*  
 1494 *at*  $X_1$  (see Figure 8). Given a part  $X$  of  $\mathcal{P}$ , a *morphism-tree in*  $(G, \mathcal{P}, X)$  is a morphism tree  
 1495  $(T, m)$  in  $(G, \mathcal{P})$  such that every current path  $(x_1, \dots, x_i)$  satisfies that  $(m(x_1), \dots, m(x_i))$  is  
 1496 a connected tuple rooted at  $X$ . In particular, all nodes  $x$  at depth 1 satisfy  $m(x) \in X$ . Given  
 1497 a morphism-tree  $(T, m)$  in  $(G, \mathcal{P})$  and a part  $X$  of  $\mathcal{P}$ , we denote by  $(T, m)_X$  the subtree of  
 1498  $(T, m)$  which consists of the root  $\varepsilon$  and all the nodes  $x_i$  of  $T$  whose current path  $(x_1, \dots, x_i)$   
 1499 satisfies that  $(m(x_1), \dots, m(x_i))$  is a connected tuple rooted at  $X$ . The fact that this subset  
 1500 of nodes forms indeed a subtree follows from the fact that connected tuples are closed by  
 1501 prefix (by Lemma 30), and hence by the parent relation. We denote by  $MT_\ell(G, \mathcal{P}, X)$  the  
 1502 subtree  $MT_\ell(G, \mathcal{P})_X$ . We finally denote by  $MT'_\ell(G, \mathcal{P}, X)$  any reduct of  $MT_\ell(G, \mathcal{P}, X)$ . The  
 1503 allowed reductions follow the same rules as in  $MT_\ell(G, \mathcal{P})$  since the additional  $X$  does not  
 1504 play any role in the automorphisms.

1505 ► **Lemma 31.** *If  $(T, m)$  is a morphism-tree in  $(G, \mathcal{P})$  and  $X$  is part of  $\mathcal{P}$ , then for any*  
 1506 *reduction  $(T^r, m^r)$  of  $(T, m)$  in  $(G, \mathcal{P})$ , we have that  $(T^r, m^r)_X$  is a reduction of  $(T, m)_X$ .*

1507 **Proof.** It suffices to consider the case of  $(T^r, m^r)$  being an  $x, x'$ -reduction. Let  $f$  be an  
 1508 automorphism of  $(T, m)$  which swaps the equivalent nodes  $x, x'$  and is the identity outside of  
 1509 their descendants. Since  $f$  preserves  $\mathcal{P}$ , it maps the set of nodes corresponding to connected  
 1510 tuple rooted at  $X$  to itself. Hence the restriction of  $f$  to  $(T, m)_X$  is an automorphism and  
 1511 thus  $(T^r, m^r)_X$  is the  $x, x'$ -reduction of  $(T, m)_X$  if  $x, x' \in (T, m)_X$ , and is equal to  $(T, m)_X$   
 1512 if  $x, x' \notin (T, m)_X$ . ◀

1513 Let  $X_1, \dots, X_p$  be a set of distinct parts of  $\mathcal{P}$ , and  $(T_1, m_1), \dots, (T_p, m_p)$  be a set of  
 1514 morphism-trees, each  $(T_i, m_i)$  being in  $(G, \mathcal{P}, X_i)$ , respectively. We define the *pruned shuffle*  
 1515 of the  $(T_i, m_i)$ 's as their usual shuffle  $(T, m)$  in which some nodes are deleted or *pruned*. To  
 1516 decide if a node  $(x_1, \dots, x_i)$  of  $T$  is pruned, we consider its current graph, that is the tuple  
 1517 graph induced by  $G$  on the tuple of vertices  $(v_1, \dots, v_i)$ , where each  $v_j$  is  $m(x_1, x_2, \dots, x_j)$   
 1518 for  $j \in [i]$ . For every  $j$ , let  $k$  be the (unique) index such that  $x_j \in V(T_k)$ . If the local root  
 1519 of  $v_j$  in  $(v_1, \dots, v_i)$  is different from  $X_k$  we say that  $x_j$  is *irrelevant*. By extension, a node  
 1520  $(x_1, \dots, x_i)$  which has an irrelevant entry  $x_j$  is also *irrelevant*. We prune off all the irrelevant  
 1521 nodes of  $(T, m)$  to form the pruned shuffle. The pruned  $\ell$ -shuffle is defined analogously from  
 1522 the  $\ell$ -shuffle.

1523 A node  $x$  of  $T_k$  has local root  $X_k$  since its current path is a connected tuple rooted in  $X_k$ .  
 1524 Informally speaking, we insist that every node  $(x_1, \dots, x_i)$  of the pruned shuffle with  $x_i = x$   
 1525 still has local root  $X_k$ . Crucially the pruned shuffle commutes with reductions, and the next  
 1526 lemma is the cornerstone of the whole section.

1527 ► **Lemma 32.** *With the previous notations, if  $(T_1^r, m_1^r)$  is a reduction in  $(G, \mathcal{P})$  of  $(T_1, m_1)$ ,*  
 1528 *then the pruned shuffle  $(T^r, m^r)$  of  $(T_1^r, m_1^r), (T_2, m_2), \dots, (T_p, m_p)$  is a reduction of the*  
 1529 *pruned shuffle  $(T, m)$  of  $(T_1, m_1), \dots, (T_p, m_p)$ .*

1530 **Proof.** It suffices to consider the case of  $(T_1^r, m_1^r)$  being an  $x, x'$ -reduction of  $(T_1, m_1)$ . Let  $f$   
 1531 be an automorphism of  $(T_1, m_1)$  which swaps the equivalent nodes  $x, x'$  and is the identity  
 1532 outside of their descendants.

1533 Consider the mapping  $g$  from  $V(T)$  into itself which preserves the root  $\varepsilon$  and maps  
 1534 every node  $Z = (z_1, \dots, z_k)$  to  $Z' = (\tilde{f}(z_1), \dots, \tilde{f}(z_k))$  where  $\tilde{f}(z_i) = f(z_i)$  if  $z_i \in T_1^*$  and  
 1535  $\tilde{f}(z_i) = z_i$  if  $z_i \notin T_1^*$ . We also define  $\tilde{m}(z_i) = m_j(z_i)$  if  $z_i \in T_j^*$ . Note that the current graph  
 1536 of  $Z$  is the tuple graph induced by  $G$  on the tuple of vertices  $(\tilde{m}(z_1), \dots, \tilde{m}(z_k))$ .

1537 As we have seen in the proof of Lemma 26,  $g$  is an automorphism of the tree  $T$ . Moreover  
 1538  $m(Z) = \tilde{m}(z_k)$  and  $m(g(Z)) = \tilde{m}(\tilde{f}(z_k))$  belong to the same part of  $\mathcal{P}$  since  $f$  respects the  
 1539 partition  $\mathcal{P}$ . However,  $g$  does not necessarily respect  $m$ . For instance we could have  $z_k = x$   
 1540 and  $z_1 \in T_2^*$ , with  $m_1(x)m_2(z_1) \in E(G)$  while  $m_1(x')m_2(z_1) \notin E(G)$ . This can happen since  
 1541  $X_1$  and  $X_2$  need *not* be homogeneous. However observe that in this case,  $X_1X_2$  is an edge in  
 1542  $G_{\mathcal{P}}$ , and therefore the local root of  $\tilde{m}(z_k)$  would be the same as the one of  $\tilde{m}(z_1)$ . But if  $Z$  is  
 1543 not a pruned node, the local root of  $\tilde{m}(z_k)$  must be  $X_1$ , and the one of  $\tilde{m}(z_1)$  is  $X_2$ . So this  
 1544 potential problematic node  $Z$  in fact disappears thanks to the pruning. We now formally  
 1545 prove it.

1546 Note that if a node  $Z = (z_1, \dots, z_i)$  is pruned, it has an entry  $z_j \in T_k^*$  such that the local  
 1547 root  $X$  of  $\tilde{m}(z_j)$  in the tuple  $(\tilde{m}(z_1), \dots, \tilde{m}(z_i))$  is not  $X_k$ . By construction  $\tilde{f}(z_j) \in T_k^*$ , and  
 1548 the local root of  $m(\tilde{f}(z_j))$  in the tuple  $(\tilde{m}(\tilde{f}(z_1)), \dots, \tilde{m}(\tilde{f}(z_i)))$  is also  $X$ . Thus the pruned  
 1549 nodes of  $T$  are mapped by  $g$  to pruned nodes of  $T$ , so  $g$  is bijective on the pruned shuffle  
 1550 tree  $(T, m)$ . Consequently, to show that  $g$  is an automorphism of the pruned shuffle  $(T, m)$ ,  
 1551 we just have to show that it respects edges and equalities.

1552 Consider a node  $Z_1 = (z_1, \dots, z_i)$  of  $T$  and a descendant  $Z_2 = (z_1, \dots, z_i, z_{i+1}, \dots, z_k)$  of  
 1553  $Z_1$ , we have:

- 1554 ■ If  $m(Z_1) = m(Z_2)$ , we have four cases:
- 1555 ■ If  $z_i, z_k \in T_1^*$ , we have  $m_1(z_i) = m_1(z_k)$  and thus  $m_1(f(z_i)) = m_1(f(z_k))$  which implies  
 1556  $m(g(Z_1)) = m_1(f(z_i)) = m_1(f(z_k)) = m(g(Z_2))$ .
  - 1557 ■ If  $z_i, z_k \in T_j^*$  with  $j > 1$ , we have  $m_j(z_i) = m_j(z_k)$  which implies  $m(g(Z_1)) = m_j(z_i) =$   
 1558  $m_j(z_k) = m(g(Z_2))$ .
  - 1559 ■ If  $z_i \in T_1$  and  $z_k \in T_j$  with  $j > 1$ , we have  $m(g(Z_2)) = m(Z_2) = m_j(z_k)$  which belongs  
 1560 to some part  $X$  of  $\mathcal{P}$ . Moreover, both  $m(g(Z_1))$  and  $m(Z_1)$  belong to the part  $Y$   
 1561 containing  $m_1(z_i)$  (and also  $m_1(f(z_i))$ ). In particular, since  $m(Z_1) = m(Z_2)$ , we have  
 1562  $X = Y$ . Therefore, in the  $\ell$ -sequence graph of  $(\tilde{m}(z_1), \dots, \tilde{m}(z_k))$  we have an edge  $ik$   
 1563 since  $\tilde{m}(z_i) = m(Z_1) = m(Z_2) = \tilde{m}(z_k)$ , and thus the local root of  $\tilde{m}(z_i)$  and  $\tilde{m}(z_k)$   
 1564 are the same. But this is a contradiction since by the fact that  $Z_2$  is not pruned, the  
 1565 local root of  $\tilde{m}(z_k)$  is  $X_j$  and the local root of  $\tilde{m}(z_i)$  is  $X_1$ .
  - 1566 ■ The last case  $z_j \in T_1$  and  $z_i \in T_j$  is equivalent to the third.
- 1567 ■ When  $m(Z_1)m(Z_2)$  is an edge of  $G$ , we have four cases:
- 1568 ■ If  $z_i, z_k \in T_1$ , since  $f$  respects edges,  $m_1(f(z_i))m_1(f(z_k)) = m(g(Z_1))m(g(Z_2))$  is an  
 1569 edge of  $G$ .
  - 1570 ■ If  $z_i, z_k \notin T_1$ , by definition of  $g$ , we have  $m(g(Z_1)) = m(Z_1)$  and  $m(g(Z_2)) = m(Z_2)$ ,  
 1571 and thus  $m(g(Z_1))m(g(Z_2))$  is an edge of  $G$ .
  - 1572 ■ If  $z_i \in T_1$  and  $z_k \in T_j$  with  $j > 1$ , we have  $m(g(Z_2)) = m(Z_2) = m_j(z_k)$  which belongs  
 1573 to the part  $X$  of  $\mathcal{P}$ , and both  $m(g(Z_1))$  and  $m(Z_1)$  belong to the part  $Y$  containing  
 1574  $m_1(z_i)$ . The crucial fact is that the local root of  $\tilde{m}(z_k)$  in  $(\tilde{m}(z_1), \dots, \tilde{m}(z_k))$  is  $X_j$   
 1575 (since  $Z_2$  is not pruned and  $z_k \in T_j$ ) and the local root of  $\tilde{m}(z_1)$  is  $X_1$ . Thus  $X, Y$  is  
 1576 a homogeneous pair since otherwise  $ik$  would be an edge of the  $\ell$ -sequence graph of  
 1577  $(\tilde{m}(z_1), \dots, \tilde{m}(z_k))$ , and therefore  $\tilde{m}(z_k)$  and  $\tilde{m}(z_1)$  would have the same local root.  
 1578 Therefore by homogeneity and the fact that  $m(Z_1)m(Z_2)$  is an edge, we have all edges  
 1579 between  $X$  and  $Y$ , and in particular  $m(g(Z_1))m(g(Z_2))$  is an edge of  $G$ .

1580     – The last case  $z_j \in T_1$  and  $z_i \in T_j$  is equivalent to the third.

1581     Note that  $m(g(Z_1)) = m(g(Z_2)) \Rightarrow m(Z_1) = m(Z_2)$  since  $g$  is an automorphism and  
 1582     therefore by iterating  $g$ , we can map  $g(Z_1), g(Z_2)$  to  $Z_1, Z_2$ . The same argument shows  
 1583     that if  $m(g(Z_1))m(g(Z_2))$  is an edge, then  $m(Z_1)m(Z_2)$  is also an edge.

1584     Finally, consider any node  $Z = (z_1, \dots, z_k)$  of  $(T, m)$  such that  $z_k = x$ . By definition  
 1585     of the shuffle and the fact that  $x, x'$  are siblings, there is a node  $Z' = (z_1, \dots, z_{k-1}, x')$  in  
 1586      $(T, m)$ . By construction, we have  $g(Z) = Z'$  and  $g(Z') = Z$  and thus  $Z, Z'$  are equivalent in  
 1587      $(T, m)$ . Therefore we can reduce all such pairs  $Z, Z'$  in  $(T, m)$  in order to find a reduction in  
 1588     which all elements of the subtree of  $x'$  in  $T_1$  are deleted. This is exactly the pruned shuffle  
 1589      $(T^r, m^r)$ . ◀

1590     Again the previous lemma readily works with pruned  $\ell$ -shuffles. The pruned shuffle  
 1591     operation is the crux of the construction of  $MT_\ell(G, \mathcal{P})$  using only local information.

1592     ► **Lemma 33.** *Let  $(G, \mathcal{P})$  be a partitioned graph. Then the pruned  $\ell$ -shuffle  $(T, m)$  of all*  
 1593      *$MT_\ell(G, \mathcal{P}, X)$  where  $X$  ranges over the parts of  $\mathcal{P}$  is exactly  $MT_\ell(G, \mathcal{P})$ .*

1594     **Proof.** We just have to prove that every tuple  $S = (v_1, \dots, v_i)$  of nodes of  $G$  appears exactly  
 1595     once as a node of  $T$ . Consider a subtuple  $S'$  of  $S$  corresponding to a component of  $\text{sg}_\ell(S)$ .  
 1596     Recall that  $\text{sg}_\ell(S')$  is connected. Moreover, if we denote by  $X_{S'}$  the part of  $\mathcal{P}$  which contains  
 1597     the first entry of  $S'$ , we have that  $S'$  is a connected tuple rooted at  $X_{S'}$ . Thus  $S'$  is a node of  
 1598      $MT_\ell(G, \mathcal{P}, X_{S'})$  and thus  $S$  appears in the pruned shuffle as the shuffle of all its components.  
 1599     Moreover  $S$  appears exactly once in the shuffle since any entry  $v_j$  in the subtuple  $S'$  must  
 1600     come from  $MT_\ell(G, \mathcal{P}, X_{S'})$ , otherwise the pruning would have deleted it. ◀

1601     We now state the central result of this section, directly following from Lemmas 32 and 33.

1602     ► **Lemma 34.** *Let  $(G, \mathcal{P})$  be a partitioned graph. Then the pruned  $\ell$ -shuffle of the reducts*  
 1603      *$MT'_\ell(G, \mathcal{P}, X)$ , where  $X$  ranges over the parts of  $\mathcal{P}$ , is a reduction of  $MT_\ell(G, \mathcal{P})$ .*

1604     We can now finish the proof by showing how our dynamic programming works.

1605     ► **Theorem 35.** *Let  $\mathcal{P}_{i+1}$  and  $\mathcal{P}_i$  be two  $d$ -partitions of a graph  $G$  where  $\mathcal{P}_i$  is obtained by*  
 1606     *merging the parts  $X_1, X_2$  of  $\mathcal{P}_{i+1}$ . Given a family of reducts  $MT'_\ell(G, \mathcal{P}_{i+1}, X)$  for all parts*  
 1607      *$X$  in  $\mathcal{P}_{i+1}$ , we can compute a family of reducts  $MT'_\ell(G, \mathcal{P}_i, Y)$  for all parts  $Y$  in  $\mathcal{P}_i$  in time*  
 1608     *only depending on  $\ell$  and  $d$ .*

1609     **Proof.** The first observation is that we only need to update a bounded number of reducts.  
 1610     Indeed for every part  $X$  which is at distance more than  $3^\ell$  from  $X_1 \cup X_2$  in the graph  $G_{\mathcal{P}_i}$ ,  
 1611     we just set  $MT'_\ell(G, \mathcal{P}_i, X) = MT'_\ell(G, \mathcal{P}_{i+1}, X)$  since connected tuples of vertices rooted at  $X$   
 1612     do not involve parts with distance more than  $3^\ell$  from  $X$ . Since  $G_{\mathcal{P}_i}$  has degree at most  $d$ ,  
 1613     the number of parts at distance at most  $3^\ell$  is at most  $d^{3^\ell+1}$ .

1614     Let us start with a time-inefficient method to compute  $MT'_\ell(G, \mathcal{P}_i, X)$  for all  $X \in \mathcal{P}_i$ .  
 1615     We form the pruned  $\ell$ -shuffle  $(T, m)$  of all  $MT'_\ell(G, \mathcal{P}_{i+1}, X)$  where  $X$  ranges over the parts  
 1616     of  $\mathcal{P}_{i+1}$ . By Lemma 34,  $(T, m)$  is a reduction of  $MT_\ell(G, \mathcal{P}_{i+1})$ , hence it is also a reduction  
 1617     of  $MT_\ell(G, \mathcal{P}_i)$  since  $\mathcal{P}_i$  is coarser. Now for every part  $X$  in  $\mathcal{P}_i$ , by Lemma 31, we have  
 1618     that  $(T, m)_X$  is a reduction of  $MT_\ell(G, \mathcal{P}_i, X)$ . Note that  $(T, m)_X$  has size bounded by a  
 1619     function of  $\ell$  and  $d$  since its nodes are  $\ell$ -shuffles of nodes of the set of at most  $d^{3^\ell+1}$  trees  
 1620      $MT'_\ell(G, \mathcal{P}_{i+1}, Y)$ , where the distance of  $Y$  to  $X$  in  $G_{\mathcal{P}_i}$  is at most  $3^\ell$ . So we can construct  
 1621      $MT'_\ell(G, \mathcal{P}_i, X)$  by reducing further  $(T, m)_X$  by any method.

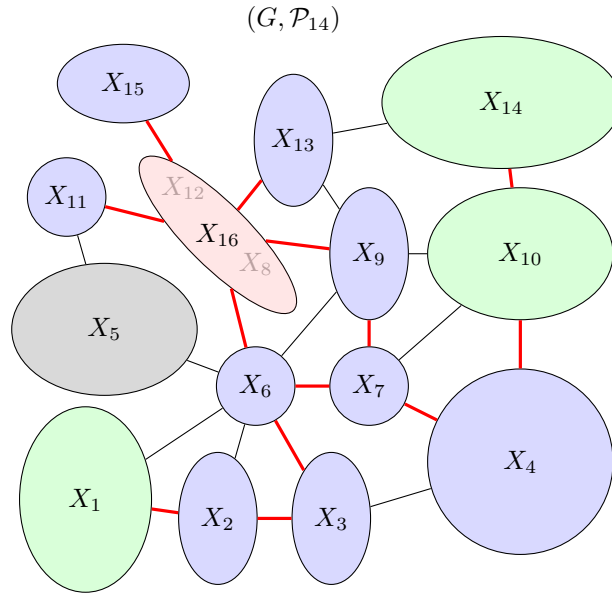

■ **Figure 9** Dynamic programming update (with the not-so-interesting  $\ell = 1$  so that the important threshold  $3^\ell$  is manageably small). Right after the contraction of  $X_8$  and  $X_{12}$  into  $X_{16}$  in  $(G, \mathcal{P}_{15})$ , we want to maintain the new  $MT'_\ell(G, \mathcal{P}_{14}, X)$  for all  $X \in \mathcal{P}_{14}$ . The parts  $X_i$  which are not  $X_{16}$  (red) nor blue are far enough from  $X_{16}$  (distance in  $G_{\mathcal{P}_{14}} > 3^\ell$ ), so that  $MT'_\ell(G, \mathcal{P}_{14}, X_i) := MT_\ell(G, \mathcal{P}_{15}, X_i)$  does not need an update. For the red and blue parts  $X_i$ , we compute  $(T, m)$  the pruned shuffle of  $MT'_\ell(G, \mathcal{P}_{15}, Y)$  where  $Y$  runs through  $\{\text{blue and green parts}\} \cup \{X_8, X_{12}\}$  (distance to  $X_{16}$  in  $G_{\mathcal{P}_{14}} \leq 2 \cdot 3^\ell$ ). We then set  $MT'_\ell(G, \mathcal{P}_{14}, X_i) := \text{reduct}((T, m)_{X_i})$ .

1622 The above method is inefficient in that it involves the computation of  $(T, m)$ , but this is  
 1623 easily turned into an efficient method as we only need to compute the pruned  $\ell$ -shuffle  $(T', m')$   
 1624 of all  $MT'_\ell(G, \mathcal{P}_{i+1}, Y)$  where  $Y$  ranges over  $X_1, X_2$ , and any part which is at distance at  
 1625 most  $2 \cdot 3^\ell$  from  $X_1 \cup X_2$  in  $G_{\mathcal{P}_i}$ . Indeed, any part  $X$  of  $\mathcal{P}_i$  which is at distance at most  $3^\ell$  from  
 1626  $X_1 \cup X_2$  satisfies that  $(T', m')_X = (T, m)_X$  and we can therefore compute  $MT'_\ell(G, \mathcal{P}_i, X)$   
 1627 for these parts  $X$  in time only depending on  $\ell$  and  $d$ . See Figure 9 for an illustration. ◀

1628 Finally we can prove Theorem 25.

1629 **Proof.** We are given a sequence of  $d$ -partitions  $\mathcal{P}_n, \dots, \mathcal{P}_1$  where  $\mathcal{P}_n$  is the finest partition,  $\mathcal{P}_1$   
 1630 is the coarsest partition, and every  $\mathcal{P}_i$  is obtained by a single contraction of  $\mathcal{P}_{i+1}$ . We compute  
 1631  $MT'_\ell(G, \mathcal{P}_i, X)$  for all  $i$  and for all parts  $X$  of  $\mathcal{P}_i$ . We initialize  $MT'_\ell(G, \mathcal{P}_n, \{v\}) := MT_\ell(\{v\})$   
 1632 for all  $v$  in  $V(G)$ . By Theorem 35, we can apply dynamic programming and compute in  
 1633 linear FPT time  $MT'_\ell(G, \mathcal{P}_1, V(G))$  which is exactly  $MT'_\ell(G)$ , on which any depth- $\ell$  prenex  
 1634 formula can be checked in time  $h(\ell)$ , by Lemma 24. ◀

1635 As a direct corollary, we get the following.

1636 **► Corollary 36.** MAX INDEPENDENT SET, MAX CLIQUE, MIN VERTEX COVER, MIN  
 1637 DOMINATING SET, SUBGRAPH ISOMORPHISM are solvable in time  $f(k, d) \cdot n$ , where  $k$  is the  
 1638 solution size, on  $d$ -collapsible  $n$ -vertex graphs provided the  $d$ -sequence is given.

1639 This result also has interesting consequences for polynomial-time solvable problems, such  
 1640 as CONSTANT DIAMETER. The fact that a graph  $G$  has diameter  $k$  can be written as a  
 1641 first-order formula of size function of  $k$ . Besides, in graphs with only  $n \log^{O(1)} n$  edges,

1642 truly subquadratic algorithms deciding whether the diameter is 2 or 3 would contradict the  
 1643 Exponential-Time Hypothesis [29]. One can obtain a significant improvement on graphs  
 1644 of bounded twin-width, provided the contraction sequence is either given or can be itself  
 1645 computed in linear time.

1646 ► **Corollary 37.** *Deciding if the diameter of an  $n$ -vertex graph is  $k$  can be done in time*  
 1647  *$f(k, d) \cdot n$ , on  $d$ -collapsible graphs provided the  $d$ -sequence is given.*

1648 We finally observe that our FO model checking readily works for (general) binary structures  
 1649 of bounded twin-width. The only notion that should be revised is the homogeneity. For a  
 1650 binary structure with binary relations  $E^1, \dots, E^h$ , we now say that  $X$  and  $Y$  are *homogeneous*  
 1651 if for all  $i \in [h]$ , the existence of a pair  $u, v \in X \times Y$  such that  $(u, v) \in E^i$  implies that for  
 1652 every  $x, y \in X \times Y$ ,  $(x, y) \in E^i$ . In particular this handles the case of bounded twin-width  
 1653 digraphs (and posets encoded as digraphs).

## 1654 8 Stability under FO interpretations and transductions

1655 The question we address here is how twin-width can increase when we construct a graph  $H$   
 1656 from a graph  $G$ . For instance, it is clear that twin-width is invariant when taking complement  
 1657 (exchanging edges and non-edges). But for other types of constructions, such as taking the  
 1658 square (joining two vertices if their distance is at most two) the answer is far less clear.  
 1659 A typical question in this context consists of asking if the square of a planar graph has  
 1660 bounded twin-width. To put this in a general framework, we consider interpretations of  
 1661 graphs via first-order formulas. Our central result is that bounded twin-width is invariant  
 1662 under first-order interpretations.

The results in this section could as well be expressed in the language of directed graphs,  
 or matrices, but for the sake of simplicity, we will stick to undirected graphs. Let  $\phi(x, y)$  be  
 a prenex first-order graph formula of depth  $\ell$  with two free variables  $x, y$ . More explicitly,

$$\phi(x, y) = Q_1 x_1 Q_2 x_2 \dots Q_\ell x_\ell \phi^*$$

1663 where for each  $i \in [\ell]$ , the variable  $x_i$  ranges over  $V(G)$ ,  $Q_i \in \{\forall, \exists\}$ , while  $\phi^*$  is a Boolean  
 1664 combination in atoms of the form  $u = v$  and  $E(u, v)$  where  $u, v$  are chosen in  $\{x_1, \dots, x_\ell, x, y\}$ .

1665 Given a graph  $G$ , the graph  $\phi(G)$  has vertex-set  $V(G)$  and edge-set all the pairs  $uv$  for  
 1666 which  $G \models \phi(u, v) \wedge \phi(v, u)$ . It is called the *interpretation* of  $G$  by  $\phi$ . We choose here to  
 1667 make a symmetric version of the interpretation, but we can also define the directed version.  
 1668 Adding the directed edge  $uv$  when  $G \models \phi(u, v)$ . This will not play an important role in our  
 1669 argument.

1670 By extension, given a graph class  $\mathcal{G}$  (i.e., closed under induced subgraphs),  $\phi(\mathcal{G})$  is the  
 1671 class of all induced subgraphs of some  $\phi(G)$ , for  $G \in \mathcal{G}$ . Let us illustrate this notion with a  
 1672 striking conjecture of Gajarský et al. [16]. A class  $\mathcal{G}$  is *universal* if there exists some formula  
 1673  $\phi$  such that  $\phi(\mathcal{G})$  is the class of all graphs.

1674 ► **Conjecture 38 ([16]).** FO model checking is FPT on the class  $\mathcal{G}$  if and only if  $\mathcal{G}$  is not  
 1675 universal.

1676 In their paper, Gajarský et al. only state the backward implication. The forward  
 1677 implication holds, provided  $\text{FPT} \neq \text{AW}[*]$ .

1678 A simple example of a graph class wherein FO model checking is  $W[1]$ -hard is provided by  
 1679 interval graphs. This illustrates the previous conjecture since one can obtain every graph as  
 1680 first-order interpretation of interval graphs. To draw a comparison with another complexity



1681 measure, note that interval graphs have Vapnik-Chervonenkis dimension at most two (i.e.,  
 1682 the neighborhood hypergraph has VC-dimension at most two). This shows in particular that  
 1683 bounded VC-dimension is *not* stable under first-order interpretations. The main result of  
 1684 this section, supporting that twin-width is a natural and robust notion of complexity is the  
 1685 following.

1686 ► **Theorem 39.** *Any  $(\phi, \gamma, h)$ -transduction of a graph with twin-width at most  $d$  has twin-*  
 1687 *width bounded by a function of  $|\phi|$ ,  $\gamma$ ,  $h$ , and  $d$ .*

1688 As a direct consequence, map graphs have bounded twin-width since they can be obtained  
 1689 by FO transductions of planar graphs (which have bounded twin-width). One can also  
 1690 use Theorem 39 to show that  $k$ -planar graphs and bounded-degree string graphs have bounded  
 1691 twin-width. We first handle the expansion and the copy operations of the transduction.

1692 We recall that augmented binary structures are binary structures augmented by a constant  
 1693 number of unary relations. The definition of twin-width for augmented binary relations is  
 1694 presented in Section 5.1. We remind the reader that contraction sequences for augmented  
 1695 binary structures forbid to contract two vertices not contained in the same unary relations.

1696 ► **Lemma 40.** *For every binary structure  $G$  of twin-width at most  $d$ , and non-negative*  
 1697 *integers  $\gamma$  and  $h$ , every augmented binary structure of  $\gamma_{\text{op}} \circ h_{\text{op}}(G)$  has twin-width at most*  
 1698  *$2^{\gamma+h}(d+2\gamma)$ , where  $h_{\text{op}}$  is the  $h$ -expansion, and  $\gamma_{\text{op}}$  is the  $\gamma$ -copy operation.*

1699 **Proof.** We first argue that the introduction of the binary relation  $\sim$  of  $\gamma_{\text{op}}$  preserves bounded  
 1700 twin-width. Let  $G = G_n, \dots, G_1 = K_1$  be a  $d$ -sequence  $\mathcal{S}$  of  $G$ , where  $G_i$  is obtained from  
 1701  $G_{i+1}$  by contracting  $u_i$  and  $v_i$  into a new vertex  $z_i$ . Let  $\{(v, j) \mid v \in V(G)\}$  be the vertex-set  
 1702 of the  $j$ -th copy  $G^j$  of  $G$ . Let  $G'$  be the binary relation obtained from  $\gamma_{\text{op}}(G)$  by discarding  
 1703 its unary relations. We suggest the following contraction sequence for  $G'$ . First we contract  
 1704  $(u_{n-1}, j)$  and  $(v_{n-1}, j)$  for  $j$  going from 1 to  $\gamma$ . Basically we perform the first contraction  
 1705 of  $\mathcal{S}$  in every copy of  $G'$ . Then we contract  $(u_{n-2}, j)$  and  $(v_{n-2}, j)$  for  $j$  going from 1 to  $\gamma$   
 1706 (second contraction of  $\mathcal{S}$ ). We continue similarly up to the contractions  $(u_1, j)$  and  $(v_1, j)$   
 1707 for  $j$  going from 1 to  $\gamma$ . At this point the resulting graph of  $G'$  has only  $\gamma$  vertices, and we  
 1708 finish the contraction sequence arbitrarily. We note that, throughout this process, the red  
 1709 degree is bounded by  $d + 2\gamma$ .

1710 Now every graph  $H \in \gamma_{\text{op}} \circ h_{\text{op}}(G)$  can be obtained by adding  $\gamma + h$  unary relations to  
 1711 the binary structure  $G'$ . By Lemma 7 (whose proof follows Theorem 2 without the apex), the  
 1712 augmented binary structure  $H$  has a contraction sequence (respecting the unary relations)  
 1713 with red degree at most  $2^{\gamma+h} \text{tw}(G') \leq 2^{\gamma+h}(d+2\gamma)$ . Let us recall that this sequence mostly  
 1714 follows what we described in the previous paragraph but skips the contraction of two vertices  
 1715 not satisfying the same subset of unary relations. As a contraction sequence of an augmented  
 1716 binary structure, it ends with at most  $2^{\gamma+h}$  vertices (since the number of unary relations is  
 1717  $\gamma + h$ ). ◀

1718 To show Theorem 39 we shall now only prove that FO interpretations preserve bounded  
 1719 twin-width.

1720 ► **Theorem 41.** *For every prenex first-order formula with two free variables  $\phi(x, y)$  and*  
 1721 *every bounded-twin-width class  $\mathcal{G}$  of augmented binary structures,  $\phi(\mathcal{G})$  also has bounded*  
 1722 *twin-width.*

1723 The idea of the proof is simply that if  $G$  has twin-width  $d$ , then the sequence of  $d$ -partitions  
 1724 achieving the bound can be refined in a bounded way to form an  $f(d)$ -sequence for  $\phi(G)$ .  
 1725 Let us first make the following observation, similar to Lemma 24.

1726 ► **Lemma 42.** *Let  $u, v, v'$  be vertices of an augmented binary structure  $G$ . If  $(u, v)$  and*  
 1727  *$(u, v')$  are equivalent nodes in  $MT_{\ell+2}(G)$ , then for every prenex formula  $\phi(x, y)$  of depth  $\ell$*   
 1728 *we have  $G \models \phi(u, v)$  if and only if  $G \models \phi(u, v')$ .*

1729 A consequence of Lemma 42 is that if  $(u, v)$  and  $(u, v')$  are equivalent nodes in a reduction  
 1730  $(T, m)$  of  $MT_{\ell+2}(G)$ , then the same conclusion holds. And, if  $G$  has a partition  $\mathcal{P}$ , by the  
 1731 fact that reductions in  $(G, \mathcal{P})$  are reductions in  $G$ , we also have that if  $(u, v)$  and  $(u, v')$   
 1732 are equivalent nodes in a reduction  $(T, m)$  of  $MT_{\ell+2}(G, \mathcal{P})$ , then  $G \models \phi(u, v)$  if and only if  
 1733  $G \models \phi(u, v')$ .

1734 The central definition here is that given a partition  $\mathcal{P}$  of  $G$ , two vertices  $u, u'$  of  $G$  are  
 1735 said  $\ell + 2$ -indistinguishable if the nodes  $(u)$  and  $(u')$  are equivalent siblings (of  $\varepsilon$ ) in some  
 1736 reduction  $(T, m)$  of  $MT_{\ell+2}(G, \mathcal{P})$ . In particular, since an automorphism of  $(T, m)$  swap  
 1737 them, they belong to the same part of  $\mathcal{P}$ . We then form the graph  $E_{\ell+2}(G, \mathcal{P})$  on vertex-set  
 1738  $V(G)$  whose edges are all the pairs  $uu'$  of  $\ell + 2$ -indistinguishable vertices. It can be proved  
 1739 that  $E_{\ell+2}(G, \mathcal{P})$  is an equivalent relation (i.e., a disjoint union of cliques), but we will not  
 1740 need this fact. Instead we consider the partition  $I_{\ell+2}(G, \mathcal{P})$  whose parts are the connected  
 1741 components of  $E_{\ell+2}(G, \mathcal{P})$ . Note that  $I_{\ell+2}(G, \mathcal{P})$  refines  $\mathcal{P}$ , and that if  $\mathcal{P}'$  is a coarsening of  
 1742  $\mathcal{P}$  then  $I_{\ell+2}(G, \mathcal{P}')$  is also a coarsening of  $I_{\ell+2}(G, \mathcal{P})$  since every edge of  $E_{\ell+2}(G, \mathcal{P})$  is an  
 1743 edge of  $E_{\ell+2}(G, \mathcal{P}')$ . Crucially,  $I_{\ell+2}(G, \mathcal{P})$  does not refine the  $d$ -partition  $\mathcal{P}$  too much.

1744 ► **Lemma 43.** *When  $\mathcal{P}$  is a  $d$ -partition and  $X$  is a part of  $\mathcal{P}$ , the number of components of*  
 1745  *$E_{\ell+2}(G, \mathcal{P})$  inside  $X$  is at most a function of  $d$  and  $\ell$ .*

1746 **Proof.** Let us consider any reduct  $(T, m)$  of  $MT_{\ell+2}(G, \mathcal{P}, X)$ . Observe first that every  
 1747 current graph of  $(T, m)$  consists of vertices which belong to parts  $Y$  such that the distance in  
 1748  $G_{\mathcal{P}}$  from  $X$  to  $Y$  is at most  $3^{\ell+2}$ . We denote this set of parts  $Y$  by  $\mathcal{P}'$ . In particular  $(T, m)$   
 1749 is a morphism-tree in  $(G', \mathcal{P}')$ , where  $G'$  is the induced restriction of  $G$  to the vertices of  $\mathcal{P}'$ .  
 1750 Note that the number of parts of  $\mathcal{P}'$  is bounded in terms of  $d$  and  $\ell$ , hence  $(G', \mathcal{P}')$  is a graph  
 1751 which is partitioned into a bounded number of parts. Therefore the analogue of Lemma 23  
 1752 for partitioned graphs implies that  $(T, m)$  has size bounded in  $d$  and  $\ell$ .

1753 Now consider the graph  $H$  on  $X$  whose edges are all pairs  $v, v'$  such that a  $(v), (v')$ -  
 1754 reduction is performed while reducing  $MT_{\ell+2}(G, \mathcal{P}, X)$  into  $(T, m)$ . The number of connected  
 1755 components of  $H$  is exactly the number of nodes of depth 1 in  $(T, m)$  (and furthermore every  
 1756 component of  $H$  is a tree, but we do not use this).

1757 Now we just have to show that every edge of  $H$  is also an edge in  $E_{\ell+2}(G, \mathcal{P})$ . This follows  
 1758 from the fact that the pruned shuffle  $(T', m')$  of  $(T, m)$  and all  $MT_{\ell+2}(G, \mathcal{P}, Y)$  where  $Y \neq X$   
 1759 is a reduction of  $MT_{\ell+2}(G, \mathcal{P})$ , since reduction commutes with pruned shuffle (Lemma 32).  
 1760 In particular, for every edge  $vv'$  of  $H$ , there exists a  $(v), (v')$ -reduction among the reductions  
 1761 performed to reduce  $MT_{\ell+2}(G, \mathcal{P})$  to  $(T', m')$ . Thus  $vv'$  is an edge of  $E_{\ell+2}(G, \mathcal{P})$ . Therefore  
 1762 the number of components of  $E_{\ell+2}(G, \mathcal{P})$  in  $X$  is at most the number of components of  $H$ . ◀

1763 ► **Lemma 44.** *Let  $\phi(x, y)$  be a prenex formula of depth  $\ell$ . Let  $\mathcal{P}$  be a  $d$ -partition of an*  
 1764 *augmented binary structure  $G$  and  $X, Y$  be two parts of  $\mathcal{P}$  with pairwise distance at least  $3^\ell$*   
 1765 *in  $G_{\mathcal{P}}$ . Let  $X', Y'$  be two parts of  $I_{\ell+2}(G, \mathcal{P})$  respectively in  $X$  and  $Y$ . Then if  $u \in X'$  and*  
 1766  *$v, v' \in Y'$ , we have  $G \models \phi(u, v)$  if and only if  $G \models \phi(u, v')$ .*

1767 **Proof.** We just have to prove it when  $vv'$  is an edge of  $E_{\ell+2}(G, \mathcal{P})$  since the property will  
 1768 propagate to the whole component. We can therefore assume that there is a reduction  $(T, m)$   
 1769 of  $MT_{\ell+2}(G, \mathcal{P})$  in which  $(v)$  and  $(v')$  are equivalent nodes. By Lemma 31,  $(v)$  and  $(v')$  are  
 1770 equivalent nodes in  $(T, m)_Y$ , which is a reduction of  $MT_{\ell+2}(G, \mathcal{P}, Y)$  since reductions preserve  
 1771 connected tuples rooted at  $Y$ . Now consider the pruned  $(\ell + 2)$ -shuffle  $(T', m')$  of  $(T, m)_Y$

1772 and all  $MT_{\ell+2}(G, \mathcal{P}, Z)$  with  $Z \neq Y$ . Note that  $(T', m')$  is a reduction of  $MT_{\ell+2}(G, \mathcal{P})$ .  
 1773 Moreover it contains the two nodes  $(u, v)$  and  $(u, v')$  which are equivalent by the fact that  
 1774  $(v), (v')$  are equivalent in  $(T, m)_Y$ . Indeed, as usual, we just consider the automorphism  $f$   
 1775 of  $(T, m)_Y$  which swaps  $(v), (v')$ , and extend it by identity to an automorphism  $g$  of the  
 1776 pruned shuffle. Finally,  $(u, v)$  and  $(u, v')$  are equivalent in a reduction of  $MT_{\ell+2}(G, \mathcal{P})$ , so  
 1777  $G \models \phi(u, v)$  if and only if  $G \models \phi(u, v')$ . ◀

1778 Note that by symmetry, the previous result implies that for every  $u, u' \in X'$  and  $v, v' \in Y'$ ,  
 1779 we have  $G \models \phi(u, v)$  if and only if  $G \models \phi(u', v')$ . In particular,  $X', Y'$  is homogeneous in  
 1780  $\phi(G)$ . We can now prove Theorem 41.

1781 **Proof.** We need to show that given  $G$  with twin-width  $d$  and a formula  $\phi(x, y)$ , the twin-  
 1782 width of  $\phi(G)$  is at most a function of  $d$  and  $\ell$ , the depth of  $\phi$ . To show this, we consider a  
 1783 sequence of  $d$ -partitions  $(\mathcal{P}_i)_{i \in [n]}$  of  $G$ . We now refine it further by considering the sequence  
 1784 of partitions  $I_i := I_{\ell+2}(G, \mathcal{P}_i)$ , for all  $i \in [n]$ . As we have seen,  $I_i$  is coarser than  $I_{i+1}$ , and  
 1785 furthermore each part of  $I_i$  contains a bounded (in  $d$ , and  $\ell$ ) number of parts of  $I_{i+1}$ . Indeed  
 1786 a part of  $I_i$  is contained in a part of  $\mathcal{P}_i$  which contains at most two parts of  $\mathcal{P}_{i+1}$ , each  
 1787 containing a bounded number (in  $d$  and  $\ell$ ) of parts of  $I_{i+1}$  by Lemma 43.

1788 At last, by Lemma 44, if two parts of  $I_i$  belong respectively to two parts of  $\mathcal{P}_i$  which are  
 1789 further than  $3^{\ell+2}$  in  $G_{\mathcal{P}_i}$ , then they are homogeneous in  $\phi(G)$ . Hence  $(I_i)_{i \in [n]}$  is a nested  
 1790 sequence of  $h(d, \ell)$ -partitions of  $G$  where each  $I_i$  is a bounded refinement of  $I_{i+1}$ , so we can  
 1791 extend  $(I_i)_{i \in [n]}$  to a  $h'(d, \ell)$ -sequence of  $\phi(G)$ , by Lemma 8. ◀

## 1792 9 Conclusion

1793 We have introduced the notion of twin-width. We have shown how to compute contraction  
 1794 sequences on several classes with bounded twin-width, and how to then decide first-order  
 1795 formulas on these classes in linear FPT time.

1796 **Computing twin-width.** The most natural open question concerns the complexity of  
 1797 computing the twin-width and contraction sequences on general graphs. We do not expect  
 1798 that computing exactly the twin-width is tractable. However any approximation with a ratio  
 1799 only function of twin-width would be good enough. Formally, is there a polynomial-time  
 1800 algorithm that outputs an  $f(d)$ -contraction sequence or correctly reports that the twin-width  
 1801 is at least  $d$ ? This raises the perhaps more general question of a weak dual for twin-width.  
 1802 For treewidth, brambles provide an exact dual. How to certify that the twin-width is at least  
 1803  $d$ ? The best we can say so far is that if for all the vertex-orderings the adjacency matrix  
 1804 admits a  $(2d + 2)$ -mixed minor, then the twin-width exceeds  $d$ . A satisfactory certificate  
 1805 would get rid of the universal quantification over the orderings of the vertex-set.

1806 **Full characterization of “tractable” classes.** We have made some progress on getting  
 1807 the full picture of which classes admit an FPT algorithm for FO model checking. Let us  
 1808 call them here *tractable classes*. Resolving Gajarský et al.’s conjecture (see Conjecture 38)  
 1809 will most likely require in particular to tackle the task of the previous paragraph. Bounded  
 1810 twin-width classes are not universal, which supports a bit more the truth of the conjecture.  
 1811 Currently almost all the knowledge on tractable classes is subsumed by two algorithms:  
 1812 Grohe et al.’s algorithm on nowhere dense graphs [21] and our algorithm on bounded twin-  
 1813 width classes. As formulated in the introduction, these results, as well as their (possible)  
 1814 extension to FO interpretations and transductions, are incomparable. Is there a “natural”  
 1815 class which sits above nowhere dense and bounded twin-width classes, and would unify and  
 1816 generalize these algorithms by being itself tractable? Is there an algorithmically-workable

1817 characterization of tractable or non-universal classes? Even a tractable generalization of  
 1818 bounded degree and bounded twin-width is unclear. For instance, making the union of the  
 1819 edge-sets of a bounded-degree graph with a bounded twin-width graph on the same vertex-set  
 1820 does not yield a tractable class. Indeed, the bounded twin-width graph can be a disjoint  
 1821 union of stars, the bounded-degree graph can be a perfect matching over the set of leaves,  
 1822 and the union can then be the 2-subdivision of any graph.

1823 As a complexity measure, twin-width can be investigated in various directions. We list a  
 1824 brief collection of potentially fruitful lines of research.

1825 **Structured matrices.** The definition of a  $k$ -mixed minor in a matrix  $M$  is a division of  
 1826 rows and columns where every zone is mixed. If we use a 1,2-matrix instead of a 0,1-matrix  
 1827 to code the adjacency matrix of a graph, the property of being mixed is equivalent to having  
 1828 rank strictly greater than 1. Let us say that a matrix  $M$  has  $r$ -twin-width at most  $d$ , if  
 1829 there is an ordering of its rows and columns such that every  $(d, d)$ -division has at least one  
 1830 zone with rank at most  $r$ . By Marcus-Tardos theorem a matrix with bounded 0-twin-width  
 1831 has only linearly many non zero entries. For adjacency matrices coded by 1 (edge) and 2  
 1832 (non-edge), bounded 1-twin-width is exactly bounded twin-width of the corresponding graph.  
 1833 Can we say something about matrices with bounded 2-twin-width?

1834 **Expanders.** Surprisingly, bounded-degree expanders can have bounded twin-width, hence  
 1835 cubic graphs with bounded twin-width do not necessarily have sublinear balanced separators.  
 1836 We will show that there are cubic expanders with twin-width 6 [4]. However, random cubic  
 1837 graphs have unbounded twin-width. Does the dichotomy of having bounded or unbounded  
 1838 twin-width tell us something meaningful on expander classes?

1839 **Small classes.** In an upcoming work [4], we show that the class of graphs with twin-width  
 1840 at most  $d$  is a small class, that is, the number of such graphs on the vertex-set  $[n]$  is bounded  
 1841 by  $n!f(d)^n$  for some function  $f$ . Is the converse true? That is, for every (hereditary) small  
 1842 class of graphs is there a constant bound on the twin-width of its members? The same  
 1843 question can be asked for monotone classes only.

1844 **Polynomial expansion.** Do polynomial expansion classes have bounded twin-width? If  
 1845 yes, can we efficiently compute contraction sequences on these classes? We will show that  
 1846  $t$ -subdivisions of  $n$ -cliques have bounded twin-width if and only if  $t = \Omega(\log n)$  [4]. This is a  
 1847 first step in answering the initial question.

1848 **Bounded twin-width of finitely generated groups.** Given a (countably infinite) group  
 1849  $\Gamma$  generated by a finite set  $S$ , we can associate its Cayley graph  $G$ , whose vertices are  
 1850 the elements of  $\Gamma$  and edges are all pairs  $\{x, x \cdot s\}$  where  $s \in S$ . For instance, infinite  
 1851  $d$ -dimensional grids are such Cayley graphs. As a far-reaching generalization of the case  
 1852 of grids, we conjecture that the class of all finite induced subgraphs of  $G$  has bounded  
 1853 twin-width. We observe that this does not depend on the generating set  $S$  since all choices  
 1854 of  $S$  are equivalent modulo first-order interpretation. Hence bounded twin-width is indeed  
 1855 a group invariant. One evidence supporting that finitely generated groups have bounded  
 1856 twin-width is based on the notion of small classes and will be further developed in [4].

1857 **Additive combinatorics.** To any finite subset  $S$  of non-negative integers, we can associate  
 1858 a Cayley graph  $G$  by picking some (prime) number  $p$  (much) larger than the maximum of  $S$ ,  
 1859 and having edges  $xy$  if  $x - y$  or  $y - x$  is in  $S$  modulo  $p$ . Is the twin-width of  $G$  a relevant  
 1860 complexity measure for  $S$ ?

1861 **Approximation algorithms.** Last but not least, we should ask more algorithmic applica-  
 1862 tions from twin-width. It is noteworthy that, in all the particular classes of bounded  
 1863 twin-width presented in the paper, most optimization problems admit good approxima-  
 1864 tion ratios, or even exact polytime algorithms. What is the approximability status of, say,

1865 MAXIMUM INDEPENDENT SET on graphs of twin-width at most  $d$ ?

1866 ——— **References** ———

- 1867 1 Rémy Belmonte and Martin Vatshelle. Graph classes with structured neighborhoods and  
 1868 algorithmic applications. *Theor. Comput. Sci.*, 511:54–65, 2013. URL: [https://doi.org/10.](https://doi.org/10.1016/j.tcs.2013.01.011)  
 1869 [1016/j.tcs.2013.01.011](https://doi.org/10.1016/j.tcs.2013.01.011), doi:10.1016/j.tcs.2013.01.011.
- 1870 2 Achim Blumensath and Bruno Courcelle. On the monadic second-order transduction hierarchy.  
 1871 *Logical Methods in Computer Science*, 6(2), 2010. URL: [https://doi.org/10.2168/LMCS-6\(2:](https://doi.org/10.2168/LMCS-6(2:2)2010)  
 1872 [2\)2010](https://doi.org/10.2168/LMCS-6(2:2)2010), doi:10.2168/LMCS-6(2:2)2010.
- 1873 3 Hans L. Bodlaender, Rodney G. Downey, Michael R. Fellows, and Danny Hermelin. On  
 1874 problems without polynomial kernels. *J. Comput. Syst. Sci.*, 75(8):423–434, 2009. URL:  
 1875 <https://doi.org/10.1016/j.jcss.2009.04.001>, doi:10.1016/j.jcss.2009.04.001.
- 1876 4 Édouard Bonnet, Colin Geniet, Eun Jung Kim, Stéphan Thomassé, and Rémi Watrigant.  
 1877 Twin-width II: small classes. *Manuscript*, 2020.
- 1878 5 Simone Bova, Robert Ganian, and Stefan Szeider. Model checking existential logic on  
 1879 partially ordered sets. *ACM Trans. Comput. Log.*, 17(2):10:1–10:35, 2016. URL: [https:](https://doi.org/10.1145/2814937)  
 1880 [//doi.org/10.1145/2814937](https://doi.org/10.1145/2814937), doi:10.1145/2814937.
- 1881 6 Josef Cibulka and Jan Kyncl. Füredi-hajnal limits are typically subexponential. *CoRR*,  
 1882 [abs/1607.07491](http://arxiv.org/abs/1607.07491), 2016. URL: <http://arxiv.org/abs/1607.07491>, arXiv:1607.07491.
- 1883 7 Bruno Courcelle, Johann A. Makowsky, and Udi Rotics. Linear time solvable optimization  
 1884 problems on graphs of bounded clique-width. *Theory Comput. Syst.*, 33(2):125–150, 2000.  
 1885 URL: <https://doi.org/10.1007/s002249910009>, doi:10.1007/s002249910009.
- 1886 8 Anuj Dawar, Martin Grohe, and Stephan Kreutzer. Locally excluding a minor. In *22nd*  
 1887 *IEEE Symposium on Logic in Computer Science (LICS 2007), 10-12 July 2007, Wroclaw,*  
 1888 *Poland, Proceedings*, pages 270–279, 2007. URL: <https://doi.org/10.1109/LICS.2007.31>,  
 1889 doi:10.1109/LICS.2007.31.
- 1890 9 Zdenek Dvorák, Daniel Král, and Robin Thomas. Testing first-order properties for subclasses  
 1891 of sparse graphs. *J. ACM*, 60(5):36:1–36:24, 2013. URL: <https://doi.org/10.1145/2499483>,  
 1892 doi:10.1145/2499483.
- 1893 10 Kord Eickmeyer and Ken-ichi Kawarabayashi. FO model checking on map graphs. In  
 1894 *Fundamentals of Computation Theory - 21st International Symposium, FCT 2017, Bordeaux,*  
 1895 *France, September 11-13, 2017, Proceedings*, pages 204–216, 2017. URL: [https://doi.org/](https://doi.org/10.1007/978-3-662-55751-8_17)  
 1896 [10.1007/978-3-662-55751-8\\_17](https://doi.org/10.1007/978-3-662-55751-8_17), doi:10.1007/978-3-662-55751-8\_17.
- 1897 11 Jörg Flum and Martin Grohe. Fixed-parameter tractability, definability, and model-  
 1898 checking. *SIAM J. Comput.*, 31(1):113–145, 2001. URL: [https://doi.org/10.1137/](https://doi.org/10.1137/S0097539799360768)  
 1899 [S0097539799360768](https://doi.org/10.1137/S0097539799360768), doi:10.1137/S0097539799360768.
- 1900 12 Jacob Fox. Stanley-wilf limits are typically exponential. *CoRR*, [abs/1310.8378](http://arxiv.org/abs/1310.8378), 2013. URL:  
 1901 <http://arxiv.org/abs/1310.8378>, arXiv:1310.8378.
- 1902 13 Markus Frick and Martin Grohe. Deciding first-order properties of locally tree-decomposable  
 1903 structures. *J. ACM*, 48(6):1184–1206, 2001. URL: <https://doi.org/10.1145/504794.504798>,  
 1904 doi:10.1145/504794.504798.
- 1905 14 Markus Frick and Martin Grohe. The complexity of first-order and monadic second-order  
 1906 logic revisited. *Ann. Pure Appl. Log.*, 130(1-3):3–31, 2004. URL: [https://doi.org/10.1016/](https://doi.org/10.1016/j.apal.2004.01.007)  
 1907 [j.apal.2004.01.007](https://doi.org/10.1016/j.apal.2004.01.007), doi:10.1016/j.apal.2004.01.007.
- 1908 15 Jakub Gajarský, Petr Hlinený, Daniel Lokshantov, Jan Obdržálek, Sebastian Ordyniak, M. S.  
 1909 Ramanujan, and Saket Saurabh. FO model checking on posets of bounded width. In *IEEE 56th*  
 1910 *Annual Symposium on Foundations of Computer Science, FOCS 2015, Berkeley, CA, USA,*  
 1911 *17-20 October, 2015*, pages 963–974, 2015. URL: <https://doi.org/10.1109/FOCS.2015.63>,  
 1912 doi:10.1109/FOCS.2015.63.
- 1913 16 Jakub Gajarský, Petr Hlinený, Jan Obdržálek, Daniel Lokshantov, and M. S. Ramanujan.  
 1914 A new perspective on FO model checking of dense graph classes. In *Proceedings of the 31st*  
 1915 *Annual ACM/IEEE Symposium on Logic in Computer Science, LICS '16, New York, NY, USA,*

- 1916 July 5-8, 2016, pages 176–184, 2016. URL: <https://doi.org/10.1145/2933575.2935314>,  
1917 doi:10.1145/2933575.2935314.
- 1918 **17** Jakub Gajarský, Petr Hlinený, Jan Obdržálek, and Sebastian Ordyniak. Faster existential  
1919 FO model checking on posets. *Logical Methods in Computer Science*, 11(4), 2015. URL:  
1920 [https://doi.org/10.2168/LMCS-11\(4:8\)2015](https://doi.org/10.2168/LMCS-11(4:8)2015), doi:10.2168/LMCS-11(4:8)2015.
- 1921 **18** Jakub Gajarský and Stephan Kreutzer. Computing shrub-depth decompositions. In Christophe  
1922 Paul and Markus Bläser, editors, *37th International Symposium on Theoretical Aspects of*  
1923 *Computer Science, STACS 2020, March 10-13, 2020, Montpellier, France*, volume 154 of  
1924 *LIPICs*, pages 56:1–56:17. Schloss Dagstuhl - Leibniz-Zentrum für Informatik, 2020. URL:  
1925 <https://doi.org/10.4230/LIPICs.STACS.2020.56>, doi:10.4230/LIPICs.STACS.2020.56.
- 1926 **19** Jakub Gajarský, Stephan Kreutzer, Jaroslav Nesetril, Patrice Ossona de Mendez, Michal Pilip-  
1927 czuk, Sebastian Siebertz, and Szymon Toruńczyk. First-order interpretations of bounded ex-  
1928 pansion classes. In *45th International Colloquium on Automata, Languages, and Programming,*  
1929 *ICALP 2018, July 9-13, 2018, Prague, Czech Republic*, pages 126:1–126:14, 2018. URL: <https://doi.org/10.4230/LIPICs.ICALP.2018.126>, doi:10.4230/LIPICs.ICALP.2018.126.
- 1930 **20** Robert Ganian, Petr Hlinený, Daniel Král, Jan Obdržálek, Jarett Schwartz, and Jakub Teska.  
1931 FO model checking of interval graphs. *Logical Methods in Computer Science*, 11(4), 2015.  
1932 URL: [https://doi.org/10.2168/LMCS-11\(4:11\)2015](https://doi.org/10.2168/LMCS-11(4:11)2015), doi:10.2168/LMCS-11(4:11)2015.
- 1933 **21** Martin Grohe, Stephan Kreutzer, and Sebastian Siebertz. Deciding first-order properties of  
1934 nowhere dense graphs. *J. ACM*, 64(3):17:1–17:32, 2017. URL: <https://doi.org/10.1145/3051095>,  
1935 doi:10.1145/3051095.
- 1936 **22** Sylvain Guillemot and Dániel Marx. Finding small patterns in permutations in linear time.  
1937 In *Proceedings of the Twenty-Fifth Annual ACM-SIAM Symposium on Discrete Algorithms,*  
1938 *SODA 2014, Portland, Oregon, USA, January 5-7, 2014*, pages 82–101, 2014. URL: <https://doi.org/10.1137/1.9781611973402.7>,  
1939 doi:10.1137/1.9781611973402.7.
- 1940 **23** Petr Hlinený, Filip Pokrývka, and Bodhayan Roy. FO model checking on geometric graphs.  
1941 *Comput. Geom.*, 78:1–19, 2019. URL: <https://doi.org/10.1016/j.comgeo.2018.10.001>,  
1942 doi:10.1016/j.comgeo.2018.10.001.
- 1943 **24** Stephan Kreutzer and Anuj Dawar. Parameterized complexity of first-order logic. *Electronic*  
1944 *Colloquium on Computational Complexity (ECCC)*, 16:131, 2009. URL: [http://eccc.hpi-web.](http://eccc.hpi-web.de/report/2009/131)  
1945 [de/report/2009/131](http://eccc.hpi-web.de/report/2009/131).
- 1946 **25** Michael Lampis. Algorithmic meta-theorems for restrictions of treewidth. *Algorithmica*,  
1947 64(1):19–37, 2012. URL: <https://doi.org/10.1007/s00453-011-9554-x>, doi:10.1007/  
1948 s00453-011-9554-x.
- 1949 **26** Adam Marcus and Gábor Tardos. Excluded permutation matrices and the stanley-wilf  
1950 conjecture. *J. Comb. Theory, Ser. A*, 107(1):153–160, 2004. URL: <https://doi.org/10.1016/j.jcta.2004.04.002>,  
1951 doi:10.1016/j.jcta.2004.04.002.
- 1952 **27** Jaroslav Nesetril and Patrice Ossona de Mendez. *Sparsity - Graphs, Structures, and Algorithms*,  
1953 volume 28 of *Algorithms and combinatorics*. Springer, 2012. URL: [https://doi.org/10.1007/](https://doi.org/10.1007/978-3-642-27875-4)  
1954 [978-3-642-27875-4](https://doi.org/10.1007/978-3-642-27875-4), doi:10.1007/978-3-642-27875-4.
- 1955 **28** Oleg Pikhurko and Oleg Verbitsky. Logical complexity of graphs: a survey. *Model theoretic*  
1956 *methods in finite combinatorics*, 558:129–179, 2011.
- 1957 **29** Liam Roditty and Virginia Vassilevska Williams. Fast approximation algorithms for the  
1958 diameter and radius of sparse graphs. In *Symposium on Theory of Computing Conference,*  
1959 *STOC'13, Palo Alto, CA, USA, June 1-4, 2013*, pages 515–524, 2013. URL: [https://doi.](https://doi.org/10.1145/2488608.2488673)  
1960 [org/10.1145/2488608.2488673](https://doi.org/10.1145/2488608.2488673), doi:10.1145/2488608.2488673.
- 1961 **30** Detlef Seese. Linear time computable problems and first-order descriptions. *Mathematical*  
1962 *Structures in Computer Science*, 6(6):505–526, 1996.
- 1963 **31** Martin Vatshelle. New width parameters of graphs. 2012.
- 1964