



**HAL**  
open science

## Green mobile networks for 5G and beyond

Meysam Masoudi, Mohammad Galal Khafagy, Alberto Conte, Ali El-Amine, Brian Francoise, Chayan Nadjahi, Fatma Ezzahra Salem, Wael Labidi, Altug Sural, Azeddine Gati, et al.

► **To cite this version:**

Meysam Masoudi, Mohammad Galal Khafagy, Alberto Conte, Ali El-Amine, Brian Francoise, et al.. Green mobile networks for 5G and beyond. IEEE Access, 2019, 7, pp.107270-107299. 10.1109/ACCESS.2019.2932777 . hal-03107206

**HAL Id: hal-03107206**

**<https://hal.science/hal-03107206v1>**

Submitted on 29 May 2024

**HAL** is a multi-disciplinary open access archive for the deposit and dissemination of scientific research documents, whether they are published or not. The documents may come from teaching and research institutions in France or abroad, or from public or private research centers.

L'archive ouverte pluridisciplinaire **HAL**, est destinée au dépôt et à la diffusion de documents scientifiques de niveau recherche, publiés ou non, émanant des établissements d'enseignement et de recherche français ou étrangers, des laboratoires publics ou privés.



Distributed under a Creative Commons Attribution 4.0 International License

Received July 24, 2019, accepted July 26, 2019, date of publication August 2, 2019, date of current version August 19, 2019.

Digital Object Identifier 10.1109/ACCESS.2019.2932777

# Green Mobile Networks for 5G and Beyond

**MEYSAM MASOUDI<sup>1</sup>**, (Student Member, IEEE),  
**MOHAMMAD GALAL KHAFAGY<sup>1</sup>**, (Senior Member, IEEE),  
**ALBERTO CONTE<sup>2</sup>**, (Member, IEEE), **ALI EL-AMINE<sup>3</sup>**, (Student Member, IEEE),  
**BRIAN FRANÇOISE<sup>4</sup>**, **CHAYAN NADJAH<sup>5</sup>**, **FATMA EZZAHRA SALEM<sup>4</sup>**, **WAEEL LABIDI<sup>6</sup>**,  
**ALTUĞ SÜRAL<sup>7</sup>**, **AZEDDINE GATI<sup>4</sup>**, **DOMINIQUE BODÉRÉ<sup>4</sup>**, **ERDAL ARIKAN<sup>7</sup>**, (Fellow, IEEE),  
**FRED AKLAMANU<sup>2</sup>**, **HASNA LOUAHLIA-GUALOUS<sup>5</sup>**, **JULIEN LALLET<sup>2</sup>**, **KULDEEP PAREEK<sup>8</sup>**,  
**LOUTFI NUAYMI<sup>3</sup>**, (Senior Member, IEEE), **LUC MEUNIER<sup>9</sup>**, **PAULO SILVA<sup>10</sup>**,  
**NUNO T. ALMEIDA<sup>10</sup>**, **TIJANI CHAHED<sup>6</sup>**, **TORD SJÖLUND<sup>8</sup>**, AND **CICEK CAVDAR<sup>1</sup>**

<sup>1</sup>KTH Royal Institute of Technology, 164 40 Kista, Sweden

<sup>2</sup>Nokia Bell Labs, 91620 Nozay, France

<sup>3</sup>Departement Système Réseaux, Cybersécurité et Droit du numérique (SRCD), IMT Atlantique, CS 17607 35576 Cesson-Sévigné, France

<sup>4</sup>Orange Gardens, 92320 Châtillon, France

<sup>5</sup>LUSAC, UNICAEN, Normandie University, 14000 Caen, France

<sup>6</sup>Institut Polytechnique Paris, Telecom SudParis, UMR CNRS Samovar, 91011 Evry, France

<sup>7</sup>Polaran Ltd, 06800 Ankara, Turkey

<sup>8</sup>MIC Nordic AB, 164 32 Kista, Sweden

<sup>9</sup>Tele2, Sverige AB, 164 94 Kista, Sweden

<sup>10</sup>INESC TEC and Faculty of Engineering, University of Porto, 4200-465 Porto, Portugal

Corresponding author: Mohammad Galal Khafagy (khafagy@kth.se)

This work was supported by EU Celtic Plus Projects, mainly by SooGREEN: Service-Oriented Optimization of Green Mobile Networks and in part by AI4Green: Artificial Intelligence for Green Mobile Networks.

**ABSTRACT** The heated 5G network deployment race has already begun with the rapid progress in standardization efforts, backed by the current market availability of 5G-enabled network equipment, ongoing 5G spectrum auctions, early launching of non-standalone 5G network services in a few countries, among others. In this paper, we study current and future wireless networks from the viewpoint of energy efficiency (EE) and sustainability to meet the planned network and service evolution toward, along, and beyond 5G, as also inspired by the findings of the EU Celtic-Plus SooGREEN Project. We highlight the opportunities seized by the project efforts to enable and enrich this green nature of the network as compared to existing technologies. In specific, we present innovative means proposed in SooGREEN to monitor and evaluate EE in 5G networks and beyond. Further solutions are presented to reduce energy consumption and carbon footprint in the different network segments. The latter spans proposed virtualized/cloud architectures, efficient polar coding for fronthauling, mobile network powering via renewable energy and smart grid integration, passive cooling, smart sleeping modes in indoor systems, among others. Finally, we shed light on the open opportunities yet to be investigated and leveraged in future developments.

**INDEX TERMS** CRAN, DAS, energy efficiency, monitoring, storage, green mobile networks, passive cooling, renewable energy, sleep modes, smart grid, virtualization, Wi-Fi.

## I. INTRODUCTION

Unlike earlier generations, 5G and beyond networks are required to simultaneously support a multitude of services that have very diverse trade-offs in their requested service levels. Specifically, a consensus has been reached now to categorize such services into three main categories, namely, 1) enhanced mobile broadband (eMBB),

The associate editor coordinating the review of this manuscript and approving it for publication was Derek Abbott.

2) massive machine-type communication (mMTC), also known as massive Internet of things (mIoT), and 3) ultra-reliable low-latency communication (URLLC) [1]. The set of service requirements for each category is remarkably different from the other in terms of reliability, network availability, latency, data rate, number of connected devices, among others. The possibility and operational sustainability of such a diverse service support reckons on underlying network architecture and enabling technologies that possess a green nature, captured in their capability to well adapt their energy

consumption to actual network traffic; for instance via smart and agile traffic offloading accompanied by network component sleeping/shutdown, and even further to enable end-user incentivization via proper cost modeling in rush hours when necessary. In this regard, traffic intermittency and burstiness need to be reflected on the actual network energy consumption, with minimal effects on the network availability to the connected/idle users to maintain their quality-of-service (QoS) requirements. Also, pricing of the offered services should fairly reflect their actual cost of occupancy and/or consumption of the network infrastructure/resources. Energy consumption of currently employed technologies, however, is either mostly load-independent or requires significant network management effort to manually switch on and off underutilized network components. This approach cannot be further extended to future networks due to their much higher density and complexity, while the need for energy saving continues to vastly grow.

#### A. PAST EFFORTS ON NETWORK ENERGY EFFICIENCY

In the past few years, to address such a sustainability goal, several projects focused on EE in mobile networks, for instance, EARTH [2], GreenTouch [3], OPERA-Net, OPERA-Net 2 [4], and 5GrEEEn [5]. The overall target of the EARTH project was to reduce the power consumption of mobile networks with preserved QoS [2]. It contributed to the understanding of the energy consumption break-down in wireless access networks by answering the key question: “how much energy is needed to run a wireless network?” [6]. It was one of the first joint efforts by large telecommunication vendors and operators to make consensus on the possible strategies to improve existing networks efficiency in terms of energy consumption forming the grounds for extensive amount of research which will follow up under green mobile networks. GreenTouch followed EARTH as a very large network of industrial and academic forces and was dedicated to reduce the carbon footprint of information and communication technology (ICT) devices, platforms and networks. Their mission was to deliver the architecture, specifications, and roadmap, and had ambition to increase the network EE by a factor of 1000 compared to 2010 levels [3]. Most projects and efforts have been working under the assumption that “mobile networks are deployed for peak traffic requirements therefore resources are always overly provisioned”. Taking this observation as a reference point, the focus has been mainly to shut down unnecessarily excessive resources to avoid the waste of energy. Celtic-Plus OPERA-Net 2 (2011-2015) studied energy-efficient wireless networks with an exhaustive approach covering different topics including radio resource management algorithms, components, life cycle assessment, and new cooling systems [4]. 5GrEEEn targeted the EE aspects of 5G mobile networks, and hence contributed to the important design target of low energy consumption in mobile networks [5]. Instead of starting from an over-provisioned network deployment, the effort was to design 5G mobile networks in such a way that it is energy-efficient from

the beginning. This project presented load-adaptive massive multiple-input multiple-output (MIMO) solutions [7], addressed the importance of backhaul on the mobile network energy consumption and proposed green mobile backhauling solutions [8], [9]. 5GrEEEn also focused on the decoupling of data plane from the control plane [10] together with GreenTouch. Although these projects were focusing on the load-adaptive network operations and technologies coming with 5G, none of them considered service-level granularity and optimization as well as joint consideration of power systems following a demand-response approach.

#### B. SOOGREEN: A CLOSER LOOK ON SERVICE ENERGY CONSUMPTION

An industry-driven EU Celtic-Plus project was launched in 2015 under the name *service-oriented optimization for green mobile networks (SooGREEN)*. SooGREEN embraces the wide range of competencies covered by its consortium, which gives it a holistic view on energy issues in mobile networks and allows conducting high-impact multi-disciplinary research. Unlike its preceding EE projects, SooGREEN focused on analyzing the very distinctive nature of each service demand along with its implications on the growing network complexity as well as sustainability. Several objectives were defined in this project that span both access and core network segments, including modeling of the end-to-end energy consumption per service, definition of EE metrics and key performance indicators (KPIs), studying different energy-efficient network architectures and service-specific offloading solutions, optimization of energy storage systems, and proposition of passive cooling solutions for data centers, to name a few. In particular, SooGREEN was built around the requirement of reducing the energy consumption of services and brought together both industry and academia to closely collaborate on not only saving the energy consumption of networks but also to alleviate the carbon footprint of mobile networks in the ICT sector globally. Having said that, the SooGREEN project proposes a new paradigm for addressing the EE, moving from an infrastructure vision to the service-oriented network. The traffic is no longer addressed as a bulk, but decomposed into different specific categories (streaming, browsing, IoT,...etc) that allow proposing dedicated solutions. This new way of thinking should allow for a real assessment of service energy consumption and design enablers that help alleviating the service impact on the content-specific technology and QoS requirements.

#### C. GREENNESS EVALUATION IN CURRENT NETWORKS

Mobile networks are a major energy consumer accounting for 1-2% of the global energy consumption. However, in existing studies, the assessment of power consumption does not reveal the exact consumption figures per service. In fact, there are few studies where the power consumption of services provided by networks has been investigated. If modeling the energy consumption of network elements is important for

ecological and economic reasons, assessment of energy consumption of services is not less important. Indeed, knowing the energy consumed by services should help in cost sharing model design. For example, network operators can design better pricing schemes for the end-users, or eventually service providers, based on the energy consumed by their services. Based on this analysis, a methodology for sharing responsibilities (and eventually carbon taxes) between the different service delivery actors is possible with the right modeling. Furthermore, knowing the energy consumed by services can help introducing green performance indicators for end-users or service providers in order to design energy-aware services, encourage eco-design, and incite end-users to be greener through incentive mechanisms. Given the urgent need for a robust and service-oriented approach to this problem, SooGREEN contributes to the modeling, measurement and reporting of energy consumption of services in mobile networks. The energy consumption model and the KPI proposed by SooGREEN can be used to simulate mobile network optimization techniques to assess their theoretical performance, and therefore give insight into their environmental impact based on their energy consumption levels. In other words, our results enable realistic design of energy reduction schemes, be it on the access network or on the hardware level. Furthermore, the results are useful for knowledge sharing and standardization in the community, e.g., to be used as inputs to allow standardization for implementation of power optimization in industrial equipment.

#### D. GREEN NETWORK OPTIMIZATION

For a network to be green, network designers need to consider sustainability along a very broad range of prospects. One aspect is to investigate whether the underlying network architecture and the deployed equipment enable efficient power saving based on the varying traffic load. Recent network deployments constitute heterogeneous cell coverages (macro, micro, pico, femto) that overlap on one another to support high traffic loads per unit area when they exist. From an EE point of view, it needs hence to be ensured that at any given time such a capacity enhancement is autonomously enabled only when needed. Also, optimizing the placement of computational and communication resources over the underlying infrastructure can be a major player in the overall network energy consumption, that will also eventually affect the placement of powering and cooling facilities, and the transport link capacities between the different serving nodes, among others. In the rest of this section, we will briefly highlight some of these seen prospects for green network optimization, and the potential solutions provided in SooGREEN. Details of such contributions are then explained in the following sections.

Nowadays, radio access networks (RANs) are facing a rapid increase in traffic demand, due to the increasing number of devices connected to the network, along with the higher quality of service requested by the users. Network operators must be able to provide the required capacity to fulfill such demand. To solve this issue, centralized

RAN (CRAN) has been recently proposed as a promising architecture to increase the network capacity, while improving EE, and providing scalability and flexibility [11]. In a traditional distributed RAN (DRAN), the components constituting the base station (BS) are located at the cell site, and are divided into a radio unit (RU) for the transmission and reception of analog/radio signals, and a baseband unit (BBU) for digital baseband signal processing. The main idea of CRAN is to centralize all BBUs, sometimes also called digital units (DUs), in a shared location responsible for coordinated signal processing and management, which is called BBU hotel, while connecting to the RUs at the cell sites, now also called remote radio heads (RRHs), using optical fiber links. Such a centralization allows to share maintenance costs and energy consumption among several BBUs. Cloud-RAN represents one further development to CRAN where the processing load of several RRHs can be multiplexed into fewer number of BBUs via pooling and virtualization, now with the BBU hotel turned into a *BBU pool*. Specifically, the digital baseband processing of each RRH is performed through a virtual machine (VM), while several VMs can be accommodated on the same general purpose processor (GPP) at the BBU pool. This idea can offer further energy savings and better network scalability.

Despite its appealing EE and cost reduction features, additional network challenges are introduced by CRAN though. Specifically, since fully-processed high-bandwidth radio-over-fiber (RoF) signals are now sent from the BBU pool to the intended RUs, the transmission delay and fronthaul capacity between the centralized cloud (CC) (which hosts the BBU pool) and RUs become a transmission bottleneck, especially as the number and data rates of users served by the associated RU increase. Hybrid CRAN (H-CRAN) is proposed in SooGREEN to alleviate the CRAN limitations due to delay and fronthaul capacity. In H-CRAN, another computing layer is added to the architecture to offload a burden of the processing via functional splitting. In other words, the processing burden is shared between the CC and an edge cloud (EC). H-CRAN leverages the previous CC/EC structure with functional splitting in a three-layer architecture to share the processing tasks between CC and ECs.

Another research direction for improving EE and reducing carbon footprint in SooGREEN is to consider green powering and cooling of mobile networks. For instance, in order to reduce mobile network contribution to the global carbon footprint, one may not only focus on reducing network power consumption, but also to lower the original need to generate such needed power from fossil fuel. It becomes hence extremely important to explore how clean energy sources can be seamlessly integrated into mobile networks without degrading their offered service quality. Since known clean renewable energy (RE) sources possess an intermittent availability, research efforts should then be exerted on efficient energy storage systems that can store excess RE over its times of abundance, and consume it when it is later needed. Also,

**TABLE 1. EU Celtic-Plus SooGREEN project contributions.**

FOCUS AREAS	CONTRIBUTIONS	REF.
Energy Efficiency Evaluation and Monitoring	New Energy Efficiency KPI	[12]
	Service Energy Consumption	
	Energy Monitoring in CRAN	
Green Network Designs	<b>Virtualized/Cloud Architectures</b> Virtualized and Hybrid C-RAN Efficient FEC for Fronthauling Edge Hardware Accelerators	[13]–[22]
	<b>Network Powering and Cooling</b> RE/Smart Grid Integration Energy Storage Systems Passive Cooling in Central Offices	[23]–[30]
	<b>Green Indoor Systems</b> Indoor WiFi Solutions Energy-Efficient DAS for Tunnels	[31], [32]

means to boost the conversion efficiency, for instance, need to be carefully studied.

### E. OUTLINE

In the rest of this article, we discuss the requirements and opportunities to turn current networks into green networks as inspired by the undergone SooGREEN project efforts. The first part of the contributions is concerned with the evaluation and monitoring of network EE, also per offered service. In particular, in section II, a new KPI is proposed to evaluate the EE of current networks. Moreover, the amount of energy consumption per each offered service is analyzed based on real operator data. Furthermore, an energy-monitoring solution is proposed for Cloud-RAN networks. The second part studies different network aspects that can further boost the EE or decrease the entailed carbon footprint, with this part divided into three sections. First, section III discusses architectural aspects of the network that can affect its EE and overall performance, followed by a proposed network architecture that can offer a decent trade-off between EE, scalability, and fronthaul bandwidth occupancy. Further supporting solutions to this proposed architecture are presented afterwards in the same section, namely, bandwidth-efficient forward error correction (FEC) using polar coding for efficient fronthauling, and hardware acceleration to optimize function-specific computations at the ECs. In section IV, green mobile network powering using RE sources is also discussed, with contributions on their integration to future smart grids and efficient energy storage systems. Passive cooling solutions for central offices are also proposed in section IV, which can remarkably cut down their thermal management bill. At the end of this second part, power saving mechanisms for indoor networks are proposed in section V, focusing on case studies that report power consumption measurements for both Wi-Fi networks and distributed antenna systems (DASs) for train and road tunnels. Finally, the article discusses in section VI further potential research studies, open research directions, and recommendations for beyond 5G networks, while general conclusions are drawn in section VII. Table 1 summarizes the key focus areas and contributions of SooGREEN that will be discussed in detail along this article, divided into two main viewpoints of EE in telecom networks; 1) evaluation and

monitoring, and 2) green network optimization. Also, a list of the abbreviations used throughout the article is included in Table 2.

## II. ENERGY EFFICIENCY MONITORING AND EVALUATION

In this section, we address the EE quantification and measurement methodology extended to ICT services. It is fair to say that a significant set of KPIs have been developed during this last decade addressing a large variety of ICT sectors from the access to core networks including data centers. Those KPIs are mainly focused on hardware and infrastructure, and they helped all the green community to enforce the efforts towards lower consumption and higher efficiency. However, the major traffic transported by networks ( $\approx 80\%$ ) is mainly generated by service providers like over-the-top (OTT) companies or GAFA (Google, Apple, Facebook and Amazon). We observe a clear shift of operator's role from simply connecting people to providing a service allowing customers to access a specific content. Hence, optimizing the efficiency of hardware should take into account the service delivered by hardware. For this manner, the first subsection will address the EE KPI as standardized for hardware. The second subsection will focus on how service energy consumption could be evaluated and the last subsection will address the monitoring issue which is the fundamental condition for service energy evaluation applied to the case of Cloud-RAN.

### A. KPI FOR SERVICE ENERGY CONSUMPTION

ETSI defined a KPI, called "RUN", as the ratio of carried traffic to the corresponding consumed energy without a given boundary [33]. This indicator allows to evaluate the performance of the BSs but does not have any efficiency classification. In order to have a workable and useful operation classification, we propose to study two data sets from two different countries corresponding to 140 sites (2G, 3G and 4G sites) under operation. The traffic volume and the corresponding energy consumption are harvested using embedded probes directly connected to BSs in operating networks. The data volume (in bits) and the energy consumption (in joules) are hourly probed at each BS, for each technology.

The studied data sets contain 1) the data category, e.g., streaming, download, voice, etc, 2) traffic load and, 3) energy consumption. These data sets are obtained from an online monitoring tool in a real European network. Figure 3 shows an example of data and corresponding energy consumption in the network. Figure 4 depicts the traffic share of each service category in the network obtained from the operating network. It is worth mentioning that the data is hourly collected from monitoring real BSs in 140 sites in two countries over the period of two years.

Following our data, we propose the classification shown in Figure 1 for this indicator. This classification is still under work and should be harmonized with other major operators. The classification can be enhanced and updated following new services to be delivered, traffic increase, new measurements and novel network site management.

TABLE 2. List of abbreviations.

AI	artificial intelligence
AP	access point
ASIC	application-specific integrated circuit
BBU	baseband unit
BER	bit error rate
BIU	base station interface unit
BMS	battery management system
BS	base station
CAPEX	capital expenditure
CC	centralized cloud
CoMP	coordinated multipoint
CP	cell processing
CPU	central processing unit
CRAN	centralized RAN
DAS	distributed antenna system
DRAN	distributed RAN
DU	digital unit
EC	edge cloud
eMBB	enhanced mobile broadband
EE	energy efficiency
FEC	forward error correction
FFT	Fast Fourier Transform
FOI	fiber optic interface
FPGA	field-programmable gate array
GPP	general purpose processor
GPU	graphics processing unit
HW	hardware
H-CRAN	Hybrid CRAN
ICT	information and communication technology
IT	information technology
ITN	information technology network
JT	joint transmission
KPI	key performance indicator
LDPC	low-density parity-check
LFP	Lithium Fer Phosphate
MIMO	multiple-input multiple-output
mIoT	massive Internet of things
MJL	majority logic
mMTC	massive machine-type communication
MNO	mobile network operator
NGCO	next-generation central office
OTT	over-the-top
OPEX	operational expenditure
PON	passive optical network
PV	photovoltaic
QoS	quality-of-service
RAN	radio access network
RE	renewable energy
RU	radio unit
RRH	remote radio head
RoF	radio-over-fiber
SC	successive cancellation
SoC	state of charge
SoH	state of health
STA	station
TCO	total cost of ownership
TTI	transmission time interval
TWDM	time-wavelength division multiplexing
UE	user equipment
UP	user processing
URLLC	ultra-reliable low-latency communication
VM	virtual machine
VNF	virtual network function
WLAN	wireless local area network

Class	KPI RUN (bit/J)
AA	KPI >1Mbit/J
A	100 kbit/J < KPI < 1 Mbit/J
B	10 kbit/J < KPI < 100 kbit/J
C	1 kbit/J < KPI < 10 kbit/J
D	100 bit/J < KPI < 1 kbit/J
E	10 bit/J < KPI < 100 bit/J
F	KPI < 10 bit/J

FIGURE 1. Empirical EE classification proposal.

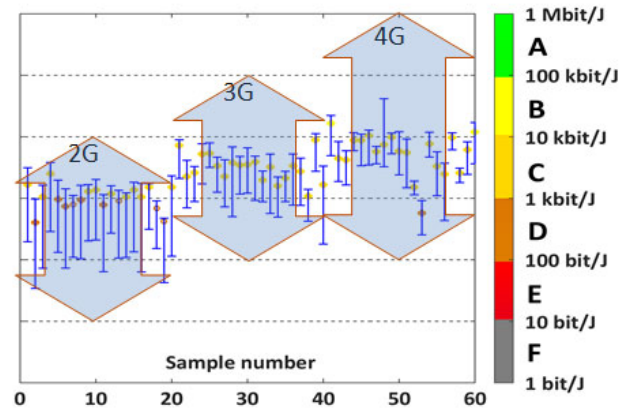

FIGURE 2. 2G/3G/4G EE classes for sample data set (20 sites).

Figure 2 shows the daily variation of the given indicator for different technologies (2G, 3G and 4G) from our case study. This workable KPI can be calculated in real time when monitoring is available and should help operators manage and operate the network. We also developed a demonstrator showing the hourly EE variation for each BS coupled to each geographical position. Figure 3 shows the hourly EE variation for a typical European wireless network. Each marker presents a BS, and to see the variation for one BS, we need just to click on the BS marker to obtain all variations during the day.

Future work shall be on the use of this KPI and monitoring methodology for the operator to benchmark its network, especially on the access segment, for different technologies. On a longer term, this proposal can be applied to detect network faults (BSs with low EE) and making an action plan for their improvement.

**B. ANALYSIS OF ENERGY CONSUMPTION PER SERVICE**

Energy consumption of a network equipment can be decomposed in two parts; 1) a fixed component, consumed by the equipment irrespective of traffic, even at zero load, to ensure that the network is operational and fulfilling coverage for instance, and 2) a variable component which is related to the transport of traffic and proportionally scales with it.

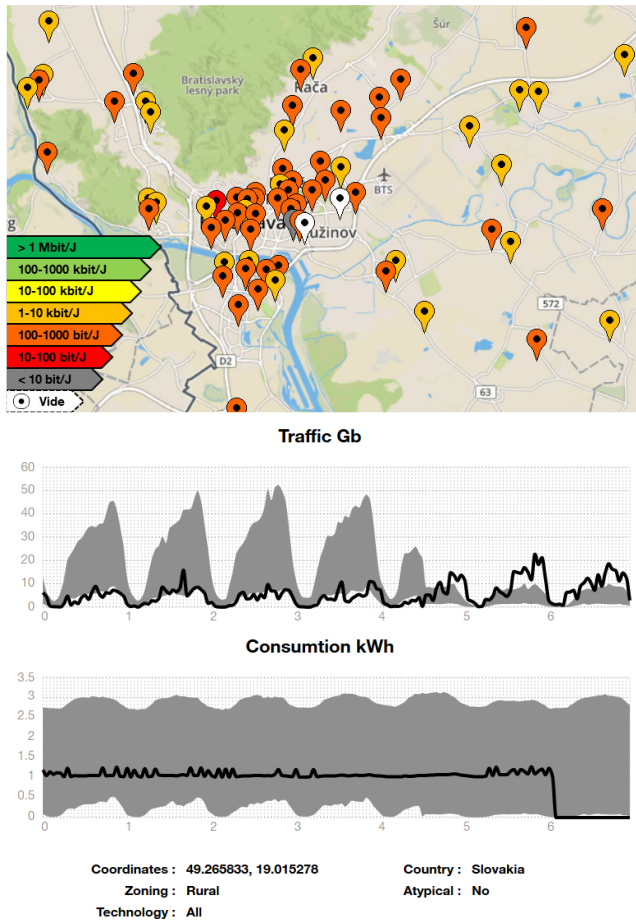
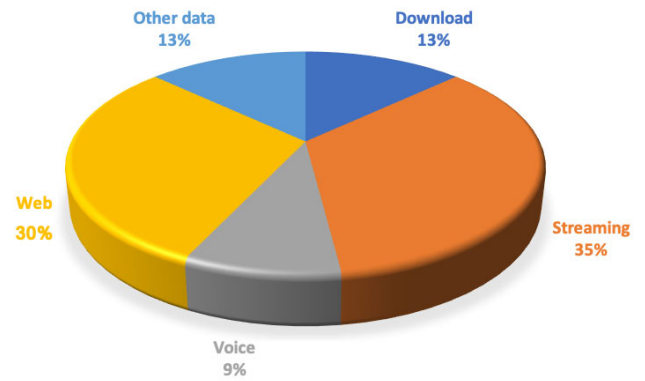

**FIGURE 3. Demonstrator for KPI visualization showing a typical European network consumption.**

From another viewpoint, a network typically transports several services which can be classified into categories. The latter may refer for instance to the type of traffic, such as streaming or web, or the type of application, Facebook or Google, or any other categorization.

Our aim in this work is to share the energy responsibility between the different service categories. We do so by first quantifying the amount of traffic produced by each service category and then sharing the energy consumption between them. This sharing is however different when it refers to variable versus fixed components of consumed energy. The variable part, since it is load dependent, is proportionally shared among service categories according to their traffic loads. If the same proportional sharing is done for the fixed component, however, we would be penalizing services with high loads which are major driving forces for network operation and revenue. Equal sharing of the fixed component among the service categories can be problematic too, since we would introduce a non-affordable cost burden to services with small loads which might be essential, such as voice, or yet newly introduced ones.

To strike an efficient yet fair sharing point, we propose to share the fixed energy component between service categories



**FIGURE 4. Traffic proportions of different service categories.**

based on a cooperative game-theoretic concept; the Shapley value. In this approach, service categories are considered as players of a cooperative game which would assign to each player its share of the fixed energy component. We chose a cooperative setting since it enables players to reach higher social welfare. As of the Shapley value, it yields consumption shares that are proportional to the marginal contribution brought by each player to the total welfare. In other words, it indicates how important each player is to the grand coalition of all players. In our setting, we have big players with high data volume and small ones with low data volume. The former ones are important to the grand coalition because they act as major driving force to the operation and evolution of the network. The latter players may present vital services, e.g. voice, or newly introduced services which would have low data volumes at the early stages of deployment and which need to be encouraged and protected. The Shapley value yields a smaller share for large service categories than proportional sharing and a smaller share for small service categories than equal sharing.

To illustrate the point, Figure 4 shows load proportions for traffic categories as measured on a real European network. We can distinguish: Streaming, Web, Downloads, Other data services and Voice. Figure 5 shows the sharing of the fixed energy component among them based on proportional sharing, equal sharing and Shapley value. One can observe the balance stated above between efficiency and fairness. As stated earlier, this sharing can also be applied to other service categorizations, such as applications, as shown in Figure 6.

We see two major follow-ups for our work: the first one is on designing incentive mechanisms in order to incite end-users and service providers to adopt a greener behavior so as to reduce environmental and operational costs of networks. This can be achieved using our model for computing and sharing the responsibility of end-users and service providers in the energy consumption of networks, shown above. The second perspective is designing fair pricing schemes, in the context of marketplace platforms, where we can tailor for instance an auction mechanism taking into account the energy cost of the services expected to be provided.

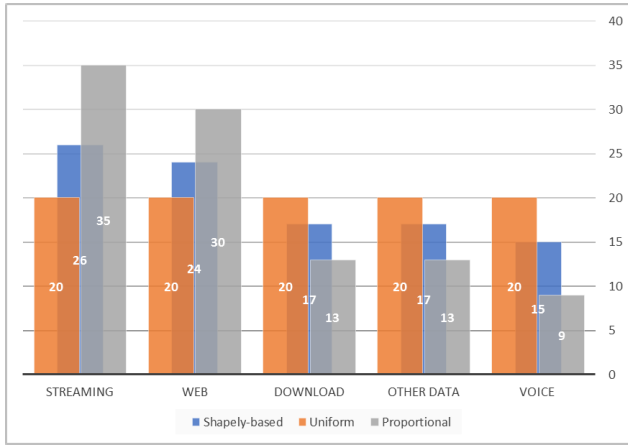

FIGURE 5. Sharing of fixed energy consumption between service categories.

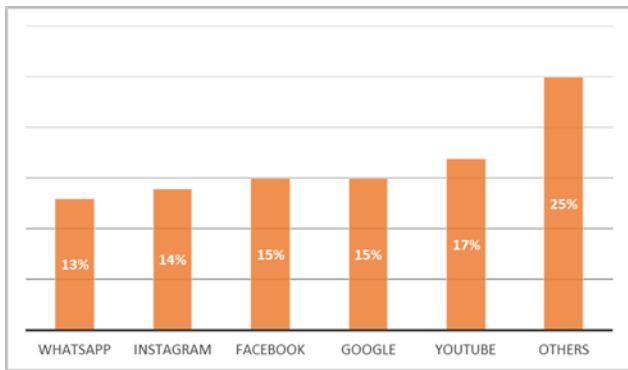

FIGURE 6. Sharing of fixed energy consumption between applications.

C. ENERGY ASSESSMENT AND MONITORING IN CLOUD-RAN

The cloud revolution that mobile networks are undergoing requires an equivalent evolution on the way the energy efficiency is assessed and the consumption is monitored.

SooGREEN contributed to standardization (ETSI) with a set of definitions and principles for assessing the energy efficiency (EE) of Cloud-RAN networks. The accepted proposition, integrated in ETSI ES 203.228 [12] as an informative annex, is summarized in Figure 7. The Cloud-RAN is decomposed into three segments:

- Radio Access (RA), consisting of the Remote Access Points (RAP) performing real-time BS tasks and typically including the radio, baseband and optical transport equipment.
- Edge Cloud (EC), representing small data centers dedicated to telecom functions, typically performing non-real time BS tasks.
- Central Cloud (CC), which consists of multi-server data centers including Central Servers (CS), Switching Equipment (SE) and (optional) other Telco Equipment (TE).

The Energy Efficiency ( $EE_{CRAN}$ ) of the system is given by the ratio of Data Volume ( $DV_{CRAN}$ ) over Energy

Consumption ( $EC_{CRAN}$ ).  $DV_{CRAN}$  is the sum of uplink (DV-UL) and downlink (DV-DL) data volumes, flowing through each of the Radio Access Points.  $EC_{CRAN}$  is obtained by summing the contributions of the three segments: Radio Access, Edge Cloud and Central Cloud, each weighted by its specific Site Energy Efficiency (SEE). SEE, defined as the inverse of the Power Usage Effectiveness (PUE), which accounts for the specific energy characteristic of the equipment used in the segment. Typical values are 90% for the Radio Access Points ( $SEERAP$ ), 75% for the Edge Cloud ( $SEE_{EC}$ ) and 65% for the Central Cloud ( $SEE_{CC}$ ), due to the necessity of active cooling.

Concerning the energy monitoring aspects, the undergoing network architecture evolution offers a unique possibility to integrate them from the beginning, enabling a native view of the energy consumption dynamics. Through data analytics, it allows deriving useful insights and correlations between telecom events (e.g. traffic load variations, new user connection), IT events (CPU, memory, net usage) and energy consumption. Moreover, an integrated monitoring solution allows service orchestrators to take decisions in line with minimal energy consumption targets.

SooGREEN defined and experimentally validated a novel cloud-native energy monitoring solution, capable to work at micro-service level. The proposed solution exploits lightweight software power meters, based on the Power-API tool [34], that can be deployed on the different servers. Unlike current state-of-the-art technology, these probes do not require any external device to estimate the energy consumption of the different micro-services executing on the machine [35]. The estimation is part of a two-step process:

- 1) The probe performs raw metrics acquisition on a monitored server (eg. hardware counters on central processing unit (CPU) and memory) and stores them in a database.
- 2) The backend accesses the raw information to compute per-micro-service (or per VM) real-time energy consumption estimation.

The software power meters do not require any complex and cumbersome calibration phase: after an offline configuration phase, the probes can be deployed on the server, ready to work. This is a fundamental aspect for an industrial utilization, where the servers are already deployed and cannot undergo a calibration phase which disrupts their operation.

The overall energy-monitoring solution proposed and experimented in SooGREEN integrates both server-level monitoring (based on physical power meters) and micro-service level monitoring (based on software probes) into a complete cloud-native approach (Figure 8): while the physical power meter is statically installed, the software probes (and related backend) can be deployed as micro-services at system start-time or at runtime, on demand. This allows the necessary flexibility to respond to different needs, such as an end-to-end always-on monitoring set-up, or the ability to



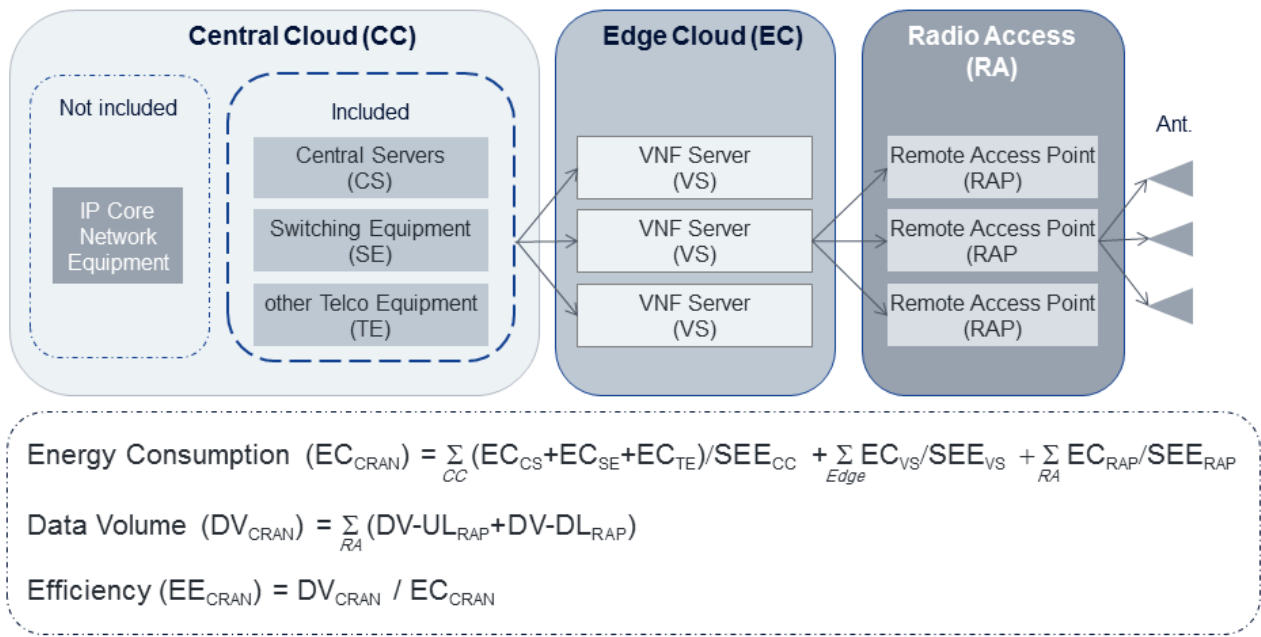

FIGURE 7. CRAN Energy Efficiency assessment model as introduced in ETSI ES 203.228.

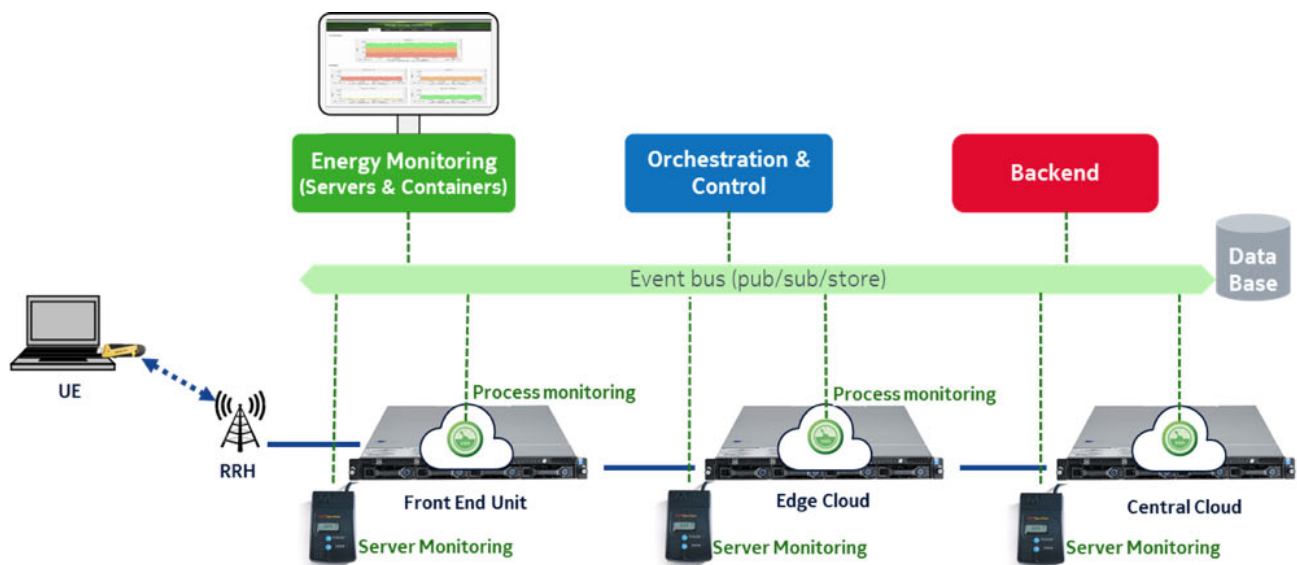

FIGURE 8. Cloud-native energy monitoring solution in a simplified example.

schedule time-limited sessions, on selected data-centers or machines.

The proposed energy monitoring solution is a first step towards efficient cloud networks. Several research topics are still open. On the energy monitoring side, end-to-end energy consumption estimation (for services or slices) is still an open challenge, mainly in the case of virtual network function (VNF) shared among different service or slices. To move toward minimized energy consumption, energy-aware/efficient orchestration algorithms still have to be defined.

### III. FUTURE MOBILE NETWORK ARCHITECTURES: CLOUDIFICATION AND VIRTUALIZATION

The evolution towards 5G is massively impacting the mobile network architecture, with the adoption of virtualization and cloudification paradigms; classic network functions become software applications, known as VNFs, executing over data centers. To achieve the flexibility required by future networks and services, the current trend is to further decompose such monolithic VNFs into smaller and distributed pieces, called micro-services, that are dynamically chained to perform complex functions and provide specific end-to-end services.

That results in highly distributed architectures deployed over cloud infrastructures, both private and public.

To optimally exploit the flexibility offered by this (r)evolution, an equivalent evolution is required in the way the network functions, now virtualized, are deployed, monitored and operated. This section focuses on some of SooGREEN contributions to address such revolution challenges.

#### A. HYBRID/VIRTUALIZED CRAN

Network infrastructure scalability is amongst the main challenges facing 5G deployments. For instance, in order to scale up network capacity per unit area as per the imposed demands, and to further utilize arising high-rate yet short-range technologies like mmWave, the underlying radio access network needs to be massively densified compared to the current deployments. Such a densification is challenging from several perspectives, including but not limited to energy consumption, cost, operation and maintenance, delay, handovers, among others. While such densification is inevitable, centralization and virtualization of resources can still offer very decent solutions, keeping all to-be-distributed nodes as simple, cost-effective, and energy-efficient as possible, especially if further equipped with smart energy-saving/sleeping features. Specifically, the rapid advancements and availability of energy-efficient and powerful centralized computation through the proliferation of data center technology can help if computation clusters are formed on the access side. This is exactly the reason that significant research efforts have been recently focused on CRAN technology. The main idea of CRAN is, for the sake of cost and energy consumption reduction, to centralize all functionalities pertaining to digital baseband computation and cooling at certain cluster centers, only leaving behind RF and analog processing at the cell sites. On top of the aforementioned benefits, this centralization can also be an enabler for coordinated multipoint (CoMP) technology, allowing for more rapid inter-cell coordination on the millisecond scale, hence better resource utilization and EE, especially for cell-edge users.

##### 1) HANDOVER REDUCTION AND VIRTUALIZED RESOURCE ALLOCATION IN V-CRAN WITH COMP

A direct consequence of cell densification in 5G networks is an elevated number of handovers for mobile users, and more frequently incurred delays due to the repeated handover process. To have a better understanding of the handover delay, it is important to mention that a typical handover process between a serving BS and a target BS consists of three phases; preparation, execution, and completion, and each involves handshaking steps and their entailed delays. Handover preparation is triggered when the reported signal strength measurement falls below a certain threshold, with a series of signaling messages performed between the two BSs and the mobile user. In the handover execution step, the mobile terminal first detaches itself from the serving BS then synchronizes with the target one. This break-before-make procedure incurs a delay between 10-12.5 msec. Another series of signaling

messages take place in the completion step for switching the path and bearer of data flow from control nodes in the evolved packet core, causing additional interruption and delay. Clearly, the adverse effect of this interruption becomes much more significant when 5G cell densification is considered, and with 5G low-latency services in mind.

To support the ongoing densification while keeping a low number of BS handovers for mobile users, a virtualized CRAN (V-CRAN) architecture was proposed in SooGREEN in [13], [14]. In this architecture, CRAN is proposed to be deployed side-by-side with a virtualized time-wavelength division multiplexing (TWDM)-passive optical network (PON) fronthaul. Specifically, the centralized node, which accommodates the BBU pool, is connected to the RUs through a software-defined reconfigurable high-speed TDWM-PON fronthaul. Depending on the assigned wavelengths to each RU via the WDM multiplexer, virtualized PONs (V-PONs) and virtualized BSs (V-BSs) can be formed per each served user. A V-BS is defined here as the formed subset of RUs which belong to the same central node and responsible for serving a certain mobile user. CoMP-joint transmission (JT) is deployed within each V-BS, remarkably diminishing the need for hard handovers at RU cell edges. With this proposition, each mobile user is now served with a V-BS whose virtualized coverage area is expanded to be the union of all cooperating RUs. As shown in Figure 11, V-CRAN outperforms DRAN and CRAN in terms of the incurred number of handovers, handover delay, and handover failure rate.

Another byproduct of the proposed V-CRAN is the throughput improvement for cell-edge users due to enabling CoMP-JT. However, in order to reap the real CoMP benefits, CoMP cooperation sets need to be optimally designed, given both the available radio resources and existing physical optical connections between BBU pools and RUs at cell sites. In [14], a constraint programming problem is formulated and solved to maximize the total throughput in the network via the allocation optimization of optical and radio resources, and the optimal formation of V-PONs. A comparison between DRAN, CRAN and V-CRAN is depicted in Figure 12 as reported in [14] in terms of the resulting throughput for cell-average and cell-edge users, resource usage, and the entailed EE. As shown, jointly optimized V-CRAN is capable of attaining higher cell-edge and cell-average throughput than CRAN and DRAN, much better spectral and DU utilization, as well as in terms of energy efficiency.

##### 2) FUNCTIONAL SPLITTING AND H-CRAN

Although the CRAN idea remains promising, several challenges remain to be tackled to practically apply it side-by-side with the arising technologies. Congestion of fronthaul links, connecting centralized nodes to distributed ones, is one consequence of the sharp functional splitting suggested in CRAN. Compared to its preceding DRAN architecture, full centralization of physical-layer processing, including channel coding, modulation, and Fast Fourier Transform (FFT),

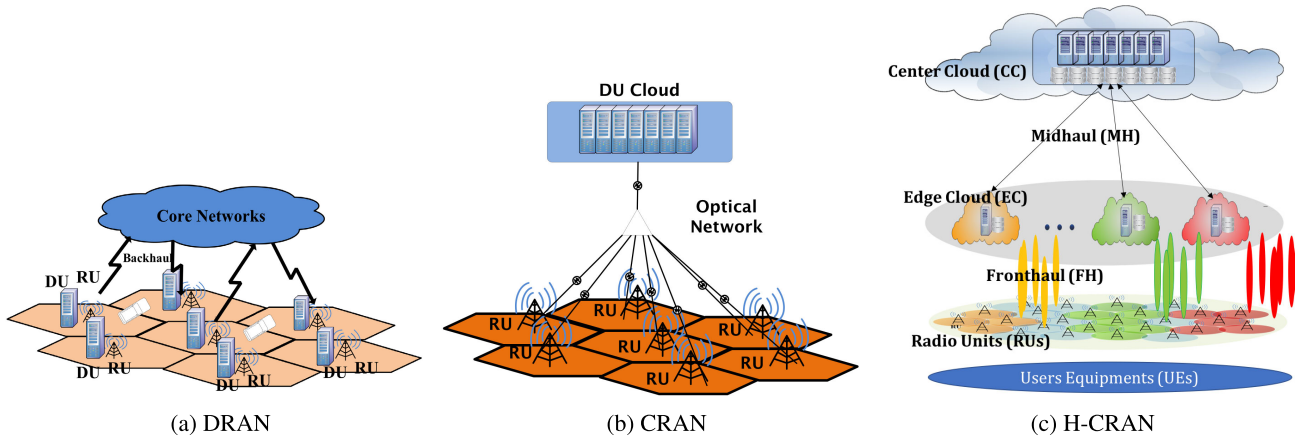

FIGURE 9. Evolution of RAN (DRAN/CRAN/H-CRAN).

can significantly upscale the fronthaul signal bandwidth in several orders of magnitude, especially as the number of serving antennas and the number of spatial streams grow larger. That is, such an effect can become much more limiting when technologies like massive MIMO are employed. This challenge also exists in uplink and downlink directions alike. For instance, the fronthaul bandwidth also scales up when higher signal resolution (finer quantization) is required in uplink multi-user detection scenarios, like in CoMP joint reception. Therefore, more convenient, and potentially flexible, intermediate functional splits need to be further studied to both keep the scalability benefits of CRAN while resolving the bandwidth congestion and allowing for effective CoMP coordination for cell-edge users. We call this flexible semi-centralized architecture herein as H-CRAN as proposed in SooGREEN in [16], [17], [19].

In the context of realizing a practical CRAN, several research efforts have been exerted, which can be classified as follows. Energy and cost studies of fronthaul, processing allocation, and processing split [36]–[38]. Others have investigated the design of a fronthaul protocol to deliver synchronized control and user data information (which enables processing at two sites) from a central site holding the BBU pool to RUs [39], [40]. Analytical studies, including market sharing (bids and asks), on techniques to enhance overall CRAN system’s capacity (radio and processing) can be found in [41]–[44]. None of the earlier work has evaluated the trade-off between the mobile network’s energy and bandwidth consumption via considering the impact of the optimal functional splits.

In the literature, the architectures with EC and CC have been proposed in a different context, such as disaster recovery to provide connectivity for public safety applications focusing on delay and resilience. In [45], the authors propose such a three-layer architecture with UAV-assisted EC layer which is a temporary layer providing edge computing and connectivity during disasters. In H-CRAN, we designed the network for permanent broadband services while minimizing the energy consumption of the network. In order to deal with

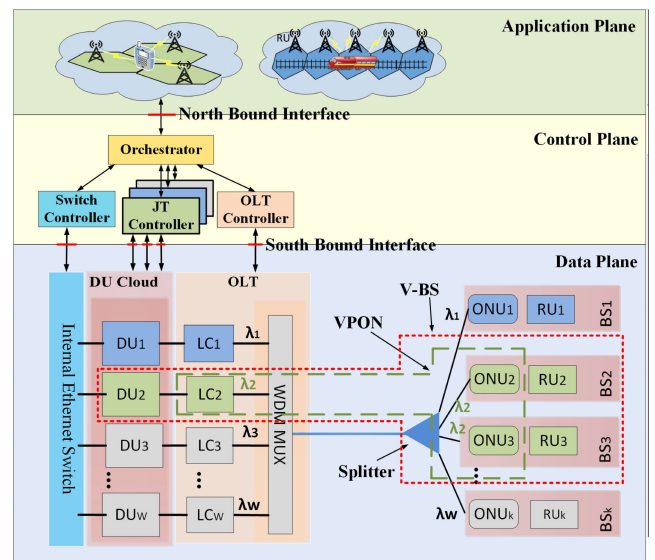

FIGURE 10. V-CRAN proposed in [13], [14].

the delay issue, we considered TWDM-PON network which is a promising architecture to support low latency services with quite low energy consumption. Since we have a processing layer closer to the users, delay sensitive services can be served at the EC, while delay-tolerant applications are served at the CC to benefit from energy saving features of the cloud. We further distribute the processing functions to tackle the problem of capacity limitation in the fronthaul considering the delay constraints.

Figure 9(c) shows the H-CRAN architecture proposed in SooGREEN in [16], [17], [19]. H-CRAN consists of three layers namely, cell layer, EC layer, and CC layer. The cell layer includes RUs that are being densified, each serving several user equipments (UEs). The RUs are connected to the ECs. In fact, an EC mainly acts as an aggregation point where the data of a group of RUs is collected at this point. The fronthaul between the RUs and ECs is assumed to be mmWave links. Furthermore, the ECs transmit the aggregated data to

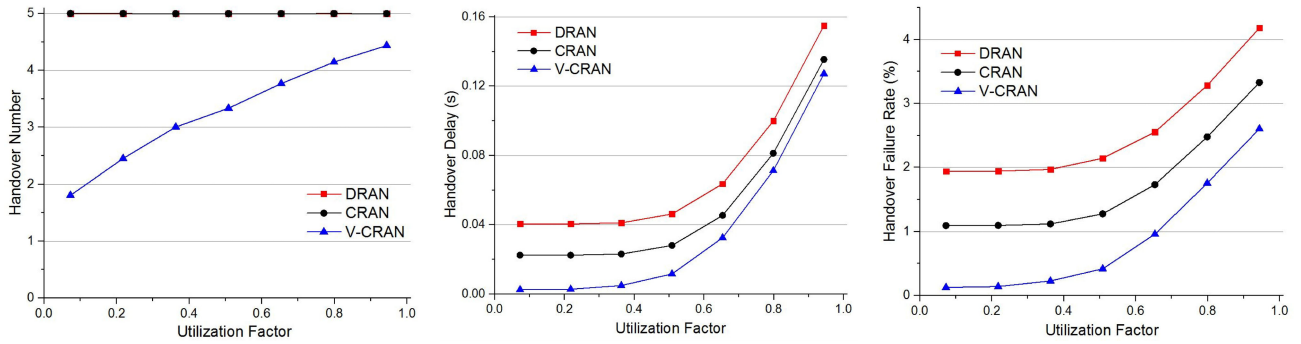

FIGURE 11. HO performance in V-CRAN as proposed in [13].

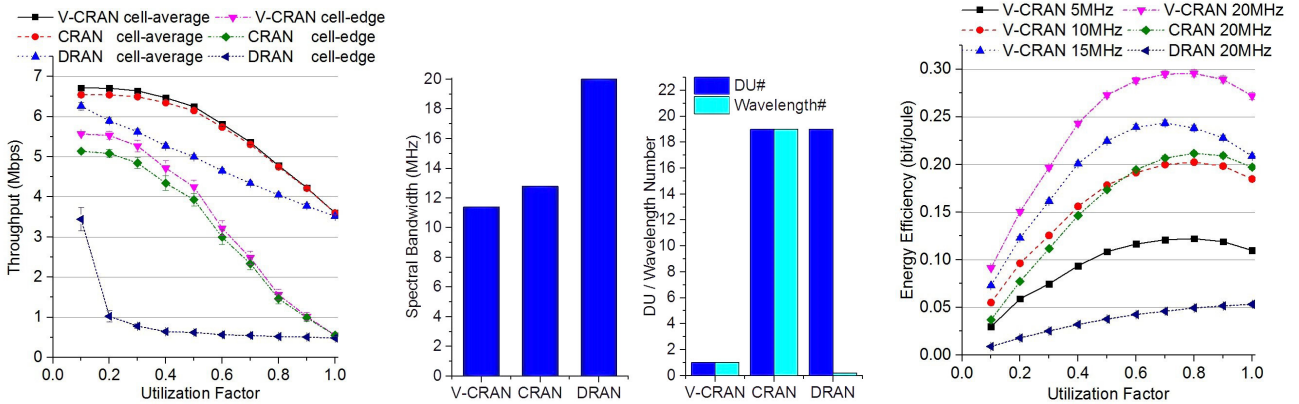

FIGURE 12. Joint optimization of optical and radio resources in V-CRAN as proposed in [14].

the CC via midhaul. Midhaul links are implemented using cost-efficient TWDM-PON. In this architecture, the CC and ECs are equipped with DUs which are able to perform function processing of requested content. Therefore, these DUs can serve any connected RUs by sharing their computational resources. For instance, in upstream, traffic from cells can be partially processed at the EC so that bandwidth requirement can be relaxed for midhaul links, then the remaining processing will be conducted at the CC. However, the EC is usually less energy-efficient than the CC, because the number of DUs at the CC is larger than that in each EC. Hence, sharing infrastructure equipment offers a multiplexing gain that results in higher energy saving at the CC. The trade-off becomes whether to save midhaul bandwidth with improved delay performance by distributing functions at the ECs or to gain from power saving which is an intrinsic feature of centralizing all functions at CC.

To study the distribution of function processing between EC and CC, we model the functional splitting of baseband processing chain for cells and users, as shown in Figure 13. The baseband processing functions can be classified as cell processing (CP) and user processing (UP) functions. The CP includes the functions within the physical layer that are responsible for the signal processing associated with the cell. Few examples of CP functions include serial-to-parallel encoding, FFT, cyclic prefix, and resource mapping. Simi-

larly, the UP includes a set of functions that are related to the physical layer and some upper layer functions that are responsible for signal processing of each user in a cell. Few examples of UP functions include antenna mapping and forward error correction. According to Figure 13, the functional split can either happen before Split 1 or after Split 7 or in between. When split happens at Split 1, then all the functions are centralized at the CC resulting in CRAN. When split happens after Split 7, all the functions are centralized at EC resulting in DRAN. When Split happens in between, the functions above the split are placed at the CC and functions below the split are placed at the EC.

In the proposed architecture, we enabled several functionalities that improve both power and midhaul bandwidth savings depending on the system load.

- We enable DUs at the EC to shut down when users' processing load at the remote site is low enough, i.e., users associated with the remote site can be processed by a fewer number of DUs, compared with maximum load. This feature is also enabled for the DUs at the CC.
- Shutting down the cooling equipment is also enabled at ECs or CC given that no DU is active at that site.
- We also enable shutting down midhaul, fronthaul, and radio access components at very low load where some remote sites do not have any active user.

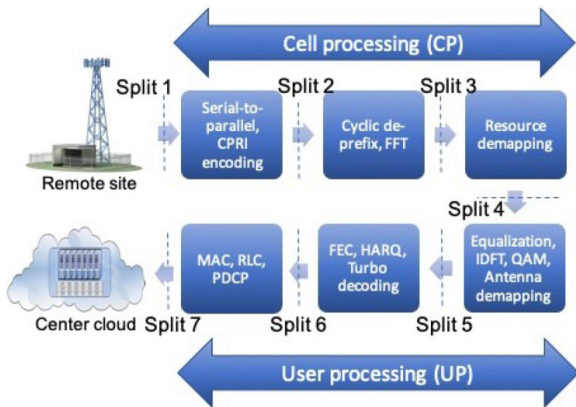

FIGURE 13. Different possible functional splits.

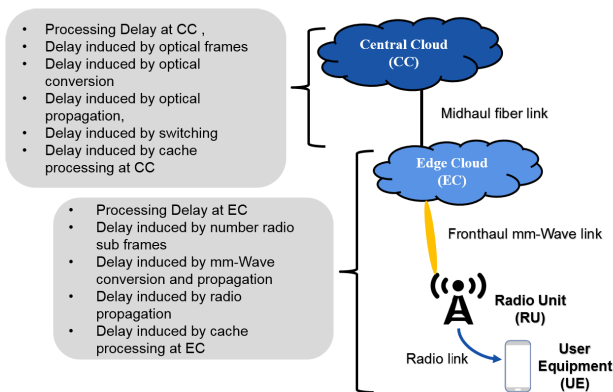

FIGURE 14. Proposed delay model for the H-CRAN architecture.

- An entire wavelength can be also shut down, given that the associated cells do not have any active user, i.e., this remote site does not consume any midhaul bandwidth. This feature can be triggered when the number of cells per remote site is low, or the system load is very low. Hence, it is possible to shut down the whole wavelength of that specific remote site.

We also proposed an end-to-end delay model in [17] per user’s request that utilizes the H-CRAN architecture and the function split model to evaluate the delay performance of each individual content request. Our delay model, as shown in Figure 14, considers all the delays induced by the network components from CC to EC to RU, then to the UE. Depending on the function processing place, different delay components contribute to the end to end delay. If the decision is full or partial function processing at the CC, then the delay model incorporates the following delay components:

- Function processing at the CC where the amount of processing is function of the split point.
- Function processing at the CC where the amount of processing is function of the split point.
- Optical propagation, conversion and processing devices.
- Optical and Ethernet switches at the data center and area nodes.

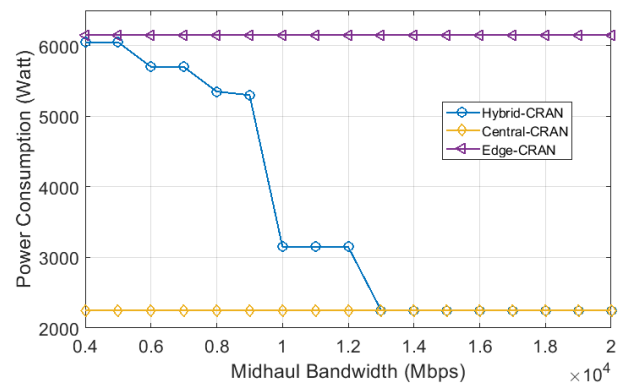

FIGURE 15. Energy/bandwidth tradeoff in H-CRAN as reported in [19].

In case of full or partial function processing at the EC, the delay model incorporates the following delay components:

- Function processing at the EC.
- Data encapsulation.
- Mm-wave conversion and propagation delay.

The last delay component from RU to UE is induced from mm-wave conversion delay, access node delay, propagation delay, and the user’s processing delay.

It is worth mentioning that the delay due to function processing is function of two factors: 1) the required amount of function processing measured in Giga operation per second (GOPS) and 2) the equipment’s processing speed. In [17], the digital subcomponents that contribute to the delay and the required GOPS per subcomponent is defined and calculated. The detail of each delay model’s term is provided in [17].

In our studies, we proposed interesting technical research directions to incorporate our function split based delay model in several optimization problems, e.g., energy and midhaul’s bandwidth minimization problems, content placement.

*Fronthaul bandwidth-energy consumption trade-off:* Deciding the optimal functional split is still an open problem, which profoundly depends on the objective to be optimized. Intuitively, if more functions are centralized at CC, as in CRAN, higher energy saving can be achieved, whereas, midhaul bandwidth consumption will increase. On the contrary, placing more processing functions at the EC may lead to higher power consumption but lower midhaul bandwidth consumption. Hence, a trade-off between placing the functions at the CC or at the ECs should be investigated. Our proposed optimization framework can decide the functional split and DU assignment for each user. Numerical results showed that when power consumption is more valued, as more transport bandwidth is available, more functions are placed at CC to save power. Also, the interplay of power and bandwidth consumptions is significant, and there exists a balanced point for joint minimization of them. Figure 15 shows a comparison between fully-centralized, fully-distributed and optimized H-CRAN in terms of energy consumption as a function of the allowed midhaul bandwidth.

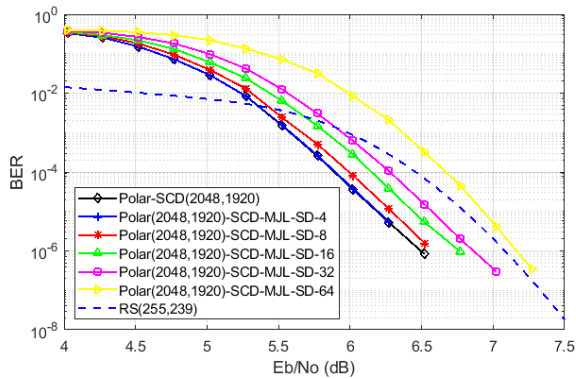

**FIGURE 16.** Performance of polar codes developed in SooGREEN compared to baseline RS codes.

### B. EFFICIENT FRONTHAUL/MIDHAUL POLAR CODING

In the SooGREEN project, we developed polar coding techniques that can operate at 100+ Gb/s and can achieve competitive performance with the other state-of-the-art codes (such as low-density parity-check (LDPC) codes) at bit error rates (BERs) as low as  $1E-15$ . The work carried out in SooGREEN on polar coding aimed at developing a FEC scheme for a hypothetical optical link for fronthauling in the CRAN/VRAN architecture. To that end, the design study was focused on developing a polar coding solution that can reach 100 Gb/s throughput with a limited energy budget, on the order of 10-40 pJ/b and a latency of 500 ns. The targets were set to be competitive with the other state-of-the-art solutions, known generally as 3rd generation FEC schemes for optical transport, and with the CRAN/VRAN latency requirements.

The main novelty of the polar code design in SooGREEN was the use of a hybrid decoding algorithm that combined successive cancellation (SC) decoding with majority logic (MJL) decoding. The hybrid method struck a balance between the low-complexity nature of SC decoding and the extreme speed of MJL decoding. The result was a soft IP core that was able to exceed 100 Gb/s throughput on an field-programmable gate array (FPGA) test platform.

Figure 16 shows the performance of some of the polar coding schemes that have been implemented in SooGREEN. The figure also shows the performance of Reed-Solomon RS(255,239) code, which has been used as a benchmark. The acronyms HD and SD stand for hard-decision and soft-decision processing of channel outputs. In HD, the channel output is quantized to 1 bit, while the channel output is quantized to 5 bits in SD. A critical design parameter is to choose the block-length at which MJL decoding is applied. The figure shows that with MJL decoding being used over 64-bit blocks, there is significant performance degradation. However, when MJL is applied over 4-bit blocks, the performance loss relative to standard SC decoding becomes negligible. In SooGREEN, MJL was applied over 8-bit blocks so as to achieve sufficient amount of speed-up while retaining acceptable coding gain.

The designs in SooGREEN were validated on FPGA demo boards. The same techniques are now being transferred to an application-specific integrated circuit (ASIC) design. Terabit per second data rates are important in beyond 5G wireless systems that are planned to exploit the vast spectrum beyond 90 GHz. The extreme area and energy constraints that we placed on the polar decoder design in SooGREEN have proven invaluable in going to even higher speeds for beyond 5G. At present, we have ASIC designs at 16nm achieving 1 Tb/s throughput using a chip area of 10 mm<sup>2</sup> and EE of 0.4 pJ/b. The latency is under 100 ns. All these figures meet and go well beyond the present 5G requirements. SooGREEN project has been instrumental in achieving this goal.

### C. ACCELERATED CLOUD

A fundamental aspect of virtualization and cloudification is the migration of telecom functions execution from dedicated equipment to commoditized information technology (IT) servers. This enables flexibility and agility in deployment, operation, and service creation while ensuring substantial cost savings. However, some specific processing-intensive functions, such as signal processing, may still require the use of hardware accelerators (like graphics processing units (GPUs) or FPGAs) to achieve their performance targets. The integration of hardware acceleration into cloud architectures is setting new challenges, for example in terms of development tools, workload orchestration and optimal usage practices. In this project, we analyzed and compared different open source development tools and hardware (HW) acceleration solutions.

Concerning the development tools, in addition to vendor-proprietary solutions such as Vivado (Xilinx) or Quartus (Intel), a bunch of open source high-level programming tools is emerging. These tools assist the developers in the HW accelerator programming task. We investigated the usability and the performance of two of them, Open Computing Language (OpenCL) [46], [47] and Heterogeneous System Architecture (HSA) [48]. The results showed that OpenCL is a mature solution providing code portability across different platforms (“write once, compile for different targets”) and offering simplicity in code generation. Performance is acceptable but does not match available target-specific libraries. On the other hand, HSA is an interesting tool but not enough mature yet for product development. However, its fast evolution calls for attentive monitoring for future usage.

On the HW accelerator side, we conducted extensive experimental studies on two different options, GPUs and FPGAs. More precisely, we compared the performance of specific signal processing functions (FFT and channel decoder) when executed on a CPU vs. when offloaded to a HW accelerator. We assessed execution time, linked to the overall end-to-end communication latency and energy consumption.

Overall, FPGAs proved to be a better option for signal processing compared to GPUs. Measurement results for processing time (a) and energy consumption (b) are shown in Figure 17. The use of FPGA can reduce the overall

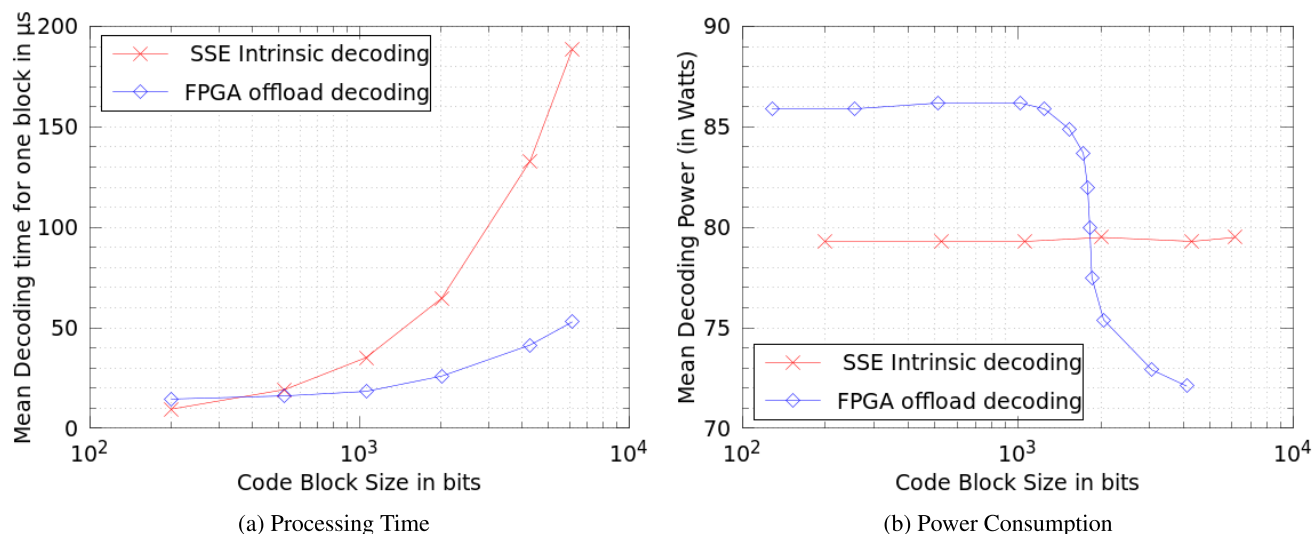

FIGURE 17. CPU/SSE vs. FPGA performance comparison on (a) processing time and (b) power consumption.

processing time and energy consumption (up to 10%) for processing intensive functions (e.g. turbo decoding of large block code sizes). However, in some conditions, the latency penalty introduced by the transfer of data between CPU and HW accelerator discourages the offloading choice. The latency introduced by data transfer comes from two main factors. The first is the fact that, at runtime, the data to be processed (e.g. the received I/Q samples in case of uplink iFFT) is in general stored in low-level processor cache (L1-cache), whom access is extremely fast from the CPU. However, to make the data available to the HW Acceleration, the data must be moved into the much slower RAM before mem-copying it to the HW-Accelerator, introducing substantial delay. The second factor, that sums to the first, is the relatively low-speed (compared to processing speed) of the CPU-FPGA (or CPU-GPU) transfer link, usually based on PCIe bus.

To conclude, we found that offloading efficacy increases when the ratio between HW-accelerated processing time and data-transfer time increases. In other terms, offloading is efficient for processing-intensive operations on large amount of data. This advocates for a careful definition of offloading orchestration strategies based on the analysis of function processing needs and CPU-FPGA interconnection performance. Further research and development efforts are necessary for a smooth integration of HW acceleration into the cloud infrastructure, especially for making their usage transparent to VNF developers. This requires improving the orchestrators, to be able to handle these specific resources (thus taking into account other metrics than CPU load), and the modeling and development tools. On the architectural standpoint, a promising approach could be to avoid offloading from CPU to HW Accelerator, and instead favour the flow of data directly into HW-Acceleration board (e.g. FPGA), through the Network Interface Card (NIC) and before flowing into the CPU. That would eliminate the data-transfer penalty

issue, reducing the overall processing time, and thus the end-to-end communication latency, helping at satisfying the stringent latency requirements of 5G networks.

#### IV. NETWORK POWERING AND COOLING AS SERVICES

Currently, mobile network operators (MNOs) are continuously interested in developing short and long term strategies to decrease their energy consumption bills and carbon footprint. Powering mobile BSs with RE naturally pops into the picture as one key approach to bring green wireless networks into reality and reduce their operational cost. Meanwhile, the power grid is evolving into a smarter one, which will fortunately allow an easier integration of distributed RE sources and open the way for a direct interaction between the smart grid and the green-powered mobile networks. Smart grids are intelligent electricity networks which govern electricity flows between production and consumption points using ICT solutions, e.g., smart meters and appliances, to maintain a reliable, secure and efficient electricity infrastructure. The main objective of a smart grid is to have a global power grid, which accommodates all electric power appliances, being either suppliers or consumers, large (factories, power plants, transmission networks, etc.) or small (home appliances, chargers, etc.) and allows seamless bidirectional communication between all of them. In contrast to the conventional power grid, the smart grid makes it possible for distributed and intermittent energy sources (such as renewables) to be easily attached to the backbone grid and fuse with the conventional fossil fuel sources. Thus, a widely distributed and automated energy delivery network is created [49]. Such an integration of mobile network powering and the smart grid is currently envisioned to play an essential role in enhancing the EE, reliability and reducing carbon emissions of mobile networks.

Although the idea of RE-powered mobile networks appears to be highly promising, the actual situation is also not

less challenging. Specifically, the power output of such RE sources experiences large time variations depending on weather conditions. Such a high fluctuation of RE supply calls for efficient local energy storage systems at the RE generation sites in order to constantly adhere to the instantaneous load requirements. The introduction of RE-powered BSs with local energy storage systems motivates further development of common policies between MNOs and the smart grid to increase their mutual benefit, possibly offloading and selling excess RE generation back to the grid. In fact, understanding and coordinating timely and optimal interactions between such local energy storage systems and the future smart grid becomes essential at this point. This new integration suggests a new concept: grid-aware greening of mobile networks. Consequently, MNOs become not only concerned with energy consumption reduction, or increasing the utilization of the RE they produce for their own sole benefit, but also consider more complex interactions with the smart grid. A proper reaction of the green-powered MNO to the smart grid demands allows, in addition to the fulfillment of these demands, a possible reduction in its mobile network operational cost due to utility exchange even with the huge increase of traffic. Structural changes in the energy industry are hence likely to be encountered since the smart grid enables current players to expand their roles. This can dramatically reshape the business models and the value proposition among energy, service, and product providers, as well as customers of these enterprises and the value model of the industry as a whole. They mark also the entry of powerful new players. Firms are moving up the value chain to higher margin activities through both vertical integration and horizontal concentration, establishing numerous partnerships and cross investments. Indeed, even as competition increases between the companies and utilities involved in the smart grid, cooperation will also increase in order to provide the best service and product offerings to customers.

Electric energy suppliers are classically regarded as suppliers of MNOs in the sense that they sell them the energy needed for operating their networks. This new situation is expected to create a more complex customer-supplier relationship where MNOs and energy suppliers play different roles depending on the grid situation, the geographical position, the network composition, etc. On one hand, the dependency of MNOs with regards to energy suppliers may decrease as MNOs deploy RE sources on their BS sites. On the other hand, the integration of BS sites in the smart grid is foreseen to increase the interaction between MNOs and energy suppliers. For instance, the excess local generated RE can be fed back to the smart grid, making the MNO an energy supplier within the smart grid. Storage capacities in BSs could also be used for storing the excess energy generated in the smart grid and vice versa, i.e., nearby energy storage capabilities of the smart grids may be used as an alternative energy storage way for small cell sites. In summary, the integration of MNOs to smart grids would help regulating the demand on the grid and reducing thus the risk of blackout.

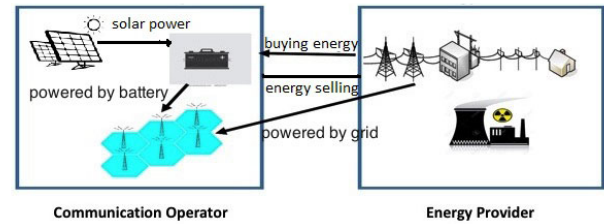

FIGURE 18. MNO acting as a prosumer in the grid.

In the following, we start by the SooGREEN contributions to the integration of green-powered networks and the smart grid, followed by further contributions to energy storage systems for mobile networks.

#### A. RENEWABLE ENERGY AND SMART GRID INTEGRATION

In order to cater for the vision of green 5G communication systems, a lot of studies have investigated the use of RE in wireless cellular networks as an economic and ecological friendly technique, where clean and cheap RE can be harvested from ambient surrounding (see [23] and the references therein). In [24], the authors exploited the impact of partially equipping some sites of a cellular network with RE sources. Energy and cost savings are analyzed for different sizes of RE sources, batteries, and energy management strategies, showing significant energy savings for up to 70%. Enabling energy cooperation between BSs equipped with RE to maximize the network EE is addressed in [50]. Under the smart grid infrastructure, the authors showed that by exchanging the harvested energy between BSs, more improvement in the network energy savings is achieved. In [25], a variant adaptation of the KPIs is considered that includes the use of RE. By putting forward each service contribution to energy consumption, an energy management strategy is proposed achieving around 11.5% enhancement to the proposed KPIs. Studies related to battery cautions utilization to prevent it from fast degradations due to irreversible aging mechanisms have also been studied in [51] and [26]. Results show that up to 30% of the battery lifespan can be saved each year.

In SooGREEN, we aim at reducing the total cost of ownership (TCO) of a network where the BSs are equipped with an RE source, a battery, and operated by a smart grid, whether reliable or not. TCO is the sum of operational expenditure (OPEX) and capital expenditure (CAPEX). Figure 18 shows the possible interactions between the energy provider and the MNO when the latter acts as a prosumer in the grid.

In SooGREEN, we considered studying both long-term and short-term technical and economical settings. The former enables us to make semestral-based investment decisions for RE source and battery dimensioning, battery long-term cycling considering equipment performance degradation, and predictions on user traffic growth and electricity market evolution over a long period of time counted in years. The MNO may also decide if it should invest in a DC/AC converter which can allow it to further act as a supplier in the grid,



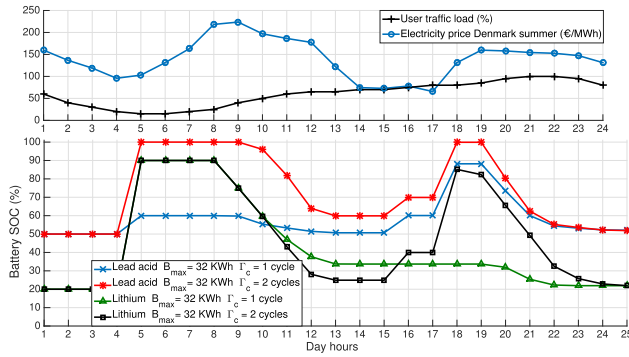

FIGURE 19. Average battery SoC daily evolution.

selling excess power to energy providers over the grid. The latter helps the operator to set, on a daily basis, an optimal battery management strategy by performing electricity arbitrage or trading that takes advantage of the electricity hourly price fluctuations and battery usage constraints [28]. The MNO in this scenario, decides on an hourly basis, if it should be powered by the grid or by its own battery and the amounts of energy to be charged or discharged from its battery ensuring that all user traffic requests are satisfied and that the battery will not perform more than a fixed number of cycles per day in order to extend its lifetime and maintain its performance. These short-term battery management strategy and long-term investment were devised using linear [52] and dynamic programming [53] techniques by iteratively solving Bellman optimality equations.

In the case of developed countries, based on long-term predictions of the user traffic growth and electricity market evolution, our results showed a financial gain evaluated at 35% of the electricity daily bill and 12% of the whole TCO on a period of 10 years for each eNB site. The cost evaluation was conducted for many scenarios considering different electricity pricing models (Denmark and EPEX zone in Europe) varying the traffic growth models (exponential and incremental) and using the test results on both lead-acid and lithium batteries. In Figure 19, we plot the average battery SoC daily evolution during a typical week day in Denmark for an MNO performing electricity arbitrage under different constraints on the number of battery cycles to be performed per day. In Table 3, we present the optimal battery dimensioning plan for an MNO that is unable to sell electricity back to the grid for both lithium and lead-acid batteries. The TCO is evaluated over 10 years and compared to the case when the operator is exclusively powered by the grid along the entire optimization period. This saving is calculated when the deployed battery will only serve as a tool for electricity arbitrage and when a portion of it (50% of lead-acid battery capacity and 20% of lithium battery capacity) will be used also for ensuring backup in case of power failure in the grid.

Contrary to the European case, the African Sub-Saharan case involves either a non-reliable grid or no grid at all. In this case, the operator would deploy a diesel engine to generate its own energy, in addition to PV panels and battery.

TABLE 3. TCO evaluation under different scenarios when selling is not allowed in Denmark.

Battery	Exponential Traffic	Incremental Traffic
Lead acid (160 €/KWh)	Decision: Install a battery of 80 KWh in winter of the 4th year and use it until the end of its cycle life. The battery does not reach its calendar life. TCO (arbitrage only) = 167 770 € Savings = 2.71% TCO (arbitrage+backup) = 161 370 € Savings = 6.42%	Decision: Install a battery of 80 KWh in winter of the 5th year and use it until the end of its cycle life. The battery does not reach its calendar life. TCO (arbitrage only) = 193 260 € Savings = 2.66% TCO (arbitrage+backup) = 186 860 € Savings = 5.88%
Lithium (350 €/KWh)	Decision: Install a battery of 64 KWh in winter of the 4th year and use it until the end of its cycle life. The battery does not reach its calendar life. TCO (arbitrage only) = 161 830 € Savings = 6.15% TCO (arbitrage+Backup) = 159 782 € Savings = 7.34%	Decision: Install a battery of 64 KWh in winter of the 3rd year and use it until the end of its cycle life. The battery does not reach its calendar life. TCO (arbitrage only) = 184 820 € Savings = 6.91% TCO (arbitrage+Backup) = 182 772 € Savings = 7.94%

The battery is only used to store excess solar energy and power the network when the grid is not available, but it does not sell energy back to the grid. This usage will make it perform only one charging/discharging cycle per day and so extends its lifetime. After evaluating the MNO OPEX taking into account the traffic increase and the electricity market evolution (prices, grid reliability) over the years, we define on semestral basis an optimal equipment dimensioning strategy that sets a tradeoff between the capacity of the battery and the surface of photovoltaic (PV) panels deployed on site. An optimal dimensioning ensures the MNO self autonomy with the least possible TCO by taking advantage of the abundant solar power to reduce the usage of the costly diesel generator.

We would like to promote for such a techno-economic study to be part of the site planning criteria in 5G networks in both developed and developing countries. The MNO has to decide about the optimal sizing of its backup battery and the optimal use of it as an alternative power source during time periods with high electricity prices when connected to the smart grid and during low-power RE production periods when connected to a non-reliable grid.

**B. EFFICIENT, AFFORDABLE, LONG-LIFE AND EASY-TO-OPERATE ENERGY STORAGE SYSTEMS**

As discussed earlier, MNOs plan to increase their use of RE for improving the environmental impact and resilience of mobile networks. Most RE is intermittent though, calling for efficient, affordable, long-life, and easy-to-operate energy storage systems. High variations do not only exist on the

RE production side, but also on the energy consumption side in future communication networks. In particular, new 5G applications can introduce very dynamic and/or critical traffic, e.g., autonomous vehicles, industry 4.0,...etc. Such a traffic burstiness, especially when 5G network equipment adopt advanced sleep modes for improving EE, can cause much higher energy demand variations than in 4G.

To tackle such challenges, future green networks should consider the development of efficient energy storage solutions with better performance of EE, charge/discharge cycling, and high power rate, compared to today's lead-acid batteries. They shall also accept partial state of charge (PSoC), wide operating temperature range for reducing cooling requirements, and offer a high safety level. As investment and running costs remain key issues, the solution is likely to be a trade-off between performance and cost. In addition to their benefit in powering their own mobile networks, such storage systems may also represent an asset for MNOs to supply the national smart-grid with their excess energy production.

New lithium battery technologies provide an interesting solution with an efficiency improvement from 10% to 20% compared to traditional lead-acid or nickel-cadmium solutions. SooGREEN results on lithium battery tests confirm the high interest of Lithium technology in telecom and IT networks. In particular, Lithium Fer Phosphate (LFP) chemistry is found to offer the best trade-off between performance, safety, and cost. As presented in [54], LFP has assets for 5G powering such as 97% EE, sufficient energy density for stationary use, i.e., in the case of rooftop or mast installation since it is 2 to 3 times lighter than a lead-acid battery, ability to PSoC and high recharge/discharge rate for enabling demand/response, peak shaving and better intermittent RE integration in networks. Moreover, LFP is the safest lithium chemistry that does not use cobalt. As for all lithium chemistries, an electronic battery management system (BMS) is still mandatory for optimal cell safety and charge balancing management.

In order to preserve natural resources and to optimize the system lifetime, an innovative BMS design has been specified in SooGREEN as shown in Figure 20, and the potential of such an advanced BMS has been demonstrated in [54]. Using such a BMS design, battery performance is preserved even with weak cells, and weak cells can be replaced individually instead of the costly replacement of the whole 48V pack. This feature improves the reliability by short-time reparability and interoperability. Figure 21 shows that the balancing maintains a minimum performance at battery level (90Ah nominal capacity) even with a weak cell (28% less state of health (SoH)). Furthermore, OPEX could be reduced by using accurate and remote monitoring with data provided by the BMS as inputs for smart predictive maintenance management. In order to reduce deployment time and improve resilience of new powering solutions in operational field, e.g., for 5G sites back-up, power peak shaving or use in hybrid diesel battery power system new methodology for battery

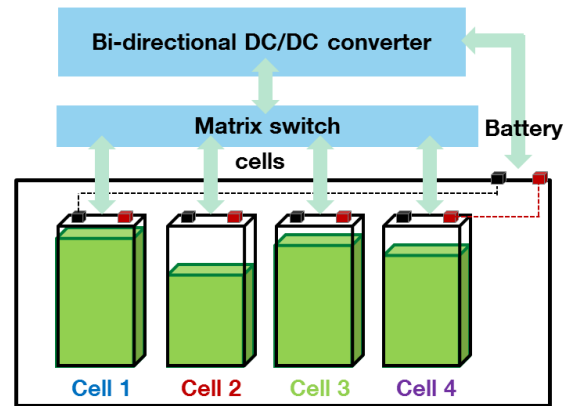

FIGURE 20. BMS architecture.

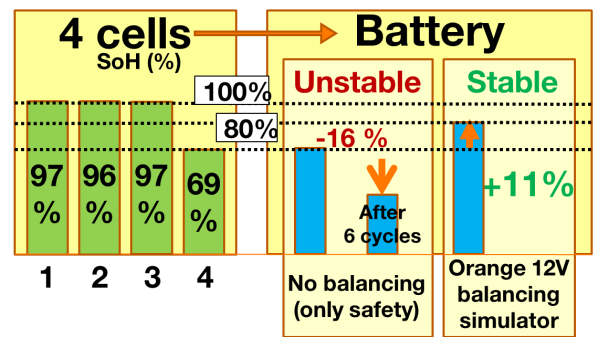

FIGURE 21. Summary of results and capacity evolution over cycle from [54].

technology selection, test and optimization for a defined use case based on some learning of the Soogreen general approach is presented in [55].

The current energy storage market is experiencing an intense evolution, with a lot of innovative solutions that are mostly proposed for a specific application. Due to the abundance of newly arising applications, there exists more room that highly encourages more research efforts. The aforementioned SooGREEN results are disseminated as a reference in ETSI and ITU-T standardizations about energy storage. These standards are also used in several other standards related to energy storage in new power architecture, i.e., energy storage at remote powering cluster sites level



FIGURE 22. Experimental setup.

in [56] and 400V DC energy storage for local and remote powering or next-generation central office (NGCO) in [57]. A new standard [58] under study is defining a sustainable powering architecture for 5G based on the innovations presented in [56] and [57]. LFP batteries could be one of the solutions to replace deep discharge cycling lead-acid batteries in some cases to avoid grid oversizing induced by high peak power observed on first 5G BS either on local grid connection or in the cluster remote powering site.

### C. GREEN COOLING IN CENTRAL OFFICES

The worldwide electricity usage of datacom has increased between 2000 and 2005 from 71 to 152 billion kWh per

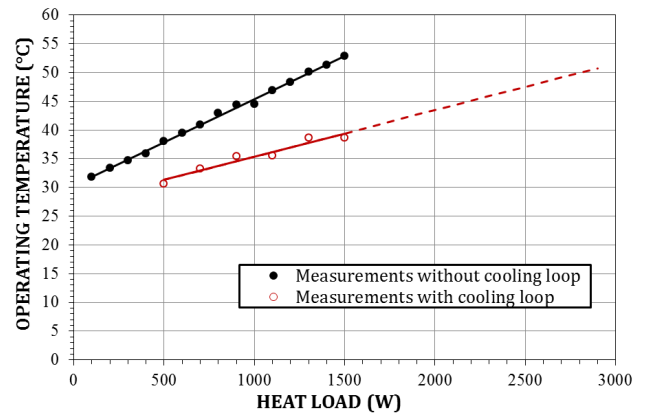

FIGURE 23. Cooling with 0 energy consumption.

year [59]. This growth of the electricity consumption represents approximately 10% per year. According to the Japanese Ministry of Economy, this consumption will be five times greater in 2025 [60]. This strong electricity usage particularly in cooling, has placed EE at the top of the agenda for both datacom businesses and policy makers [61]. The power utilization effectiveness (PUE) has been defined by the Green Grid initiative [62] as the fraction of total power required for cooling and distribution over the one used by the equipment. It is used as an (inverse) index of EE: the lower is the PUE, the higher is the EE. The reduction in PUE value depends strongly on the cooling design and its effectiveness. PUE could be reduced by 50% using liquid cooling (passive or active) instead of a traditional raised floor [61]. The reduction of PUE leads to increase the power per cabinet by 400% [63]. The Netherlands claims a reduction of PUE using tri-generation chillers and geothermal energy [64]. A vast study conducted by Lawrence Berkeley National Labs, benchmarking 22 data centers, showed a set of best practice technologies for reducing the PUE value, including the use of evaporative liquid cooling and energy optimization of the cooling infrastructure [65]. Within a central office, 50% of the electricity is consumed by the IT equipment, 33% is used by the thermal management infrastructure and 17% for electrical power distribution. The fraction of electrical power required for cooling and power distribution systems is close to the proportion of the power used by the IT equipment. With the proliferation of central offices, this issue is likely to get worse. The central office cooling system consumes a large amount of energy due to a high-energy consumption of cold source for vapor compression system, a lot of energy needed for pumps and fans and a mixing of cold and hot air leading to a decrease of the cooling efficiency. Savings in the power used for cooling can be achieved by incorporating alternative solutions like two-phase evaporative passive cooling system.

The proposed solution in SooGREEN is to develop a data center passive cooling loop. The principle is based on the use of two heat exchangers where the heat can be transferred from one to the other for longer distances and without mechanical components. The use of evaporative cooling systems

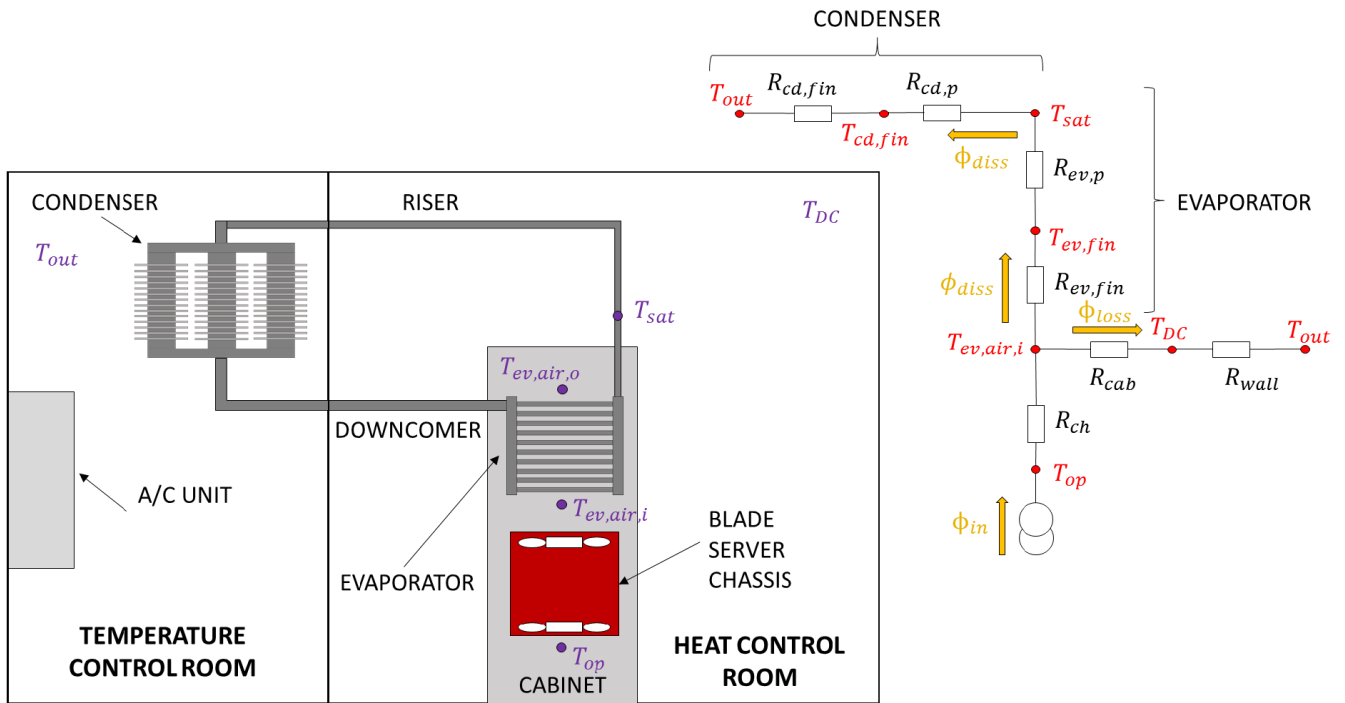

FIGURE 24. Analytical model scheme.

with zero electrical consumption can be considered as an innovative way to reduce the global electricity consumption. An experimental setup designed in the laboratory is divided into two test rooms as shown in Figure 22: a heat control room, simulating the data center building, and a temperature control room, simulating the climatic environment. The evaporators are located within the rack containing two blade servers. Heat generated inside the rack is removed by liquid vaporization in the evaporator by absorbing heat. In the condenser, vapor turns into liquid by releasing heat to the outside central offices.

The experimental results (Figure 23) showed that with no passive cooling loop, the maximum operating temperature (40°C) is reached for a dissipated heat of 640 W per rack. Using the passive cooling loop, the cooling loop heat capacity is extended to 1600 W. An analytical model (Figure 24) has been built to optimize various parameters of the cooling loop such as refrigerant charge, heat exchangers size and cooling loop capacity. It shows that the rise of the condenser heat exchange area increases the dissipated power from up to 3200 W per rack for outside ambient temperature of 22°C.

1) CHALLENGES AND FUTURE WORK

The cooling loop capacity is estimated by the model throughout one year. As seen (Figure 25), the cooling loop capacity is more relevant in cold seasons because of the low values of the outside air temperature. However, in hot periods, the cooling capacity decreases by nearly 36%. The figure shows, although the loop thermosyphon designed in the laboratory does not contain any electronic components, the heat removal

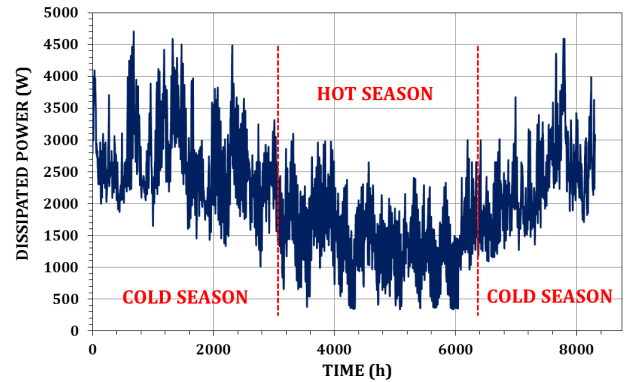

FIGURE 25. The cooling loop capacity per one rack throughout the year.

from each rack is not efficient enough in hot seasons. One of the possible solutions is to improve heat transfer in hot season using the innovative architectural design of heat exchangers.

V. GREEN INDOOR SYSTEMS

A. ENERGY-EFFICIENT SOLUTIONS FOR WI-FI NETWORKS

Wi-Fi networks, besides the aforementioned mobile networks, play a pivotal role in today’s network energy consumption. According to [66], 80% of all wireless traffic is generated or terminated indoor, where Wi-Fi is the dominant access network technology. The increasing demand on utilizing the wireless access has led to the deployment of more access points (APs) which makes the wireless local area network (WLAN) extremely dense. Such a dense deployment induces a considerable increase in global energy consump-

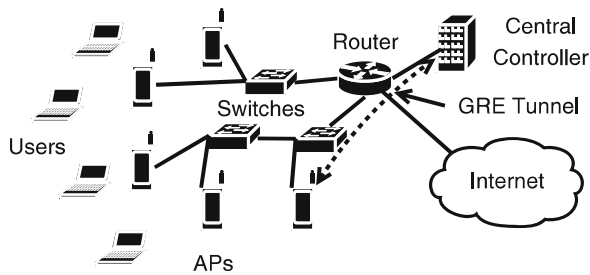

FIGURE 26. Enterprise WLAN infrastructure [68].

tion, despite the fact that the majority of APs have peak traffic demands only over short periods of time during a day. This observation motivated us to study the energy consumption of indoor networks and make effort to improve the energy-efficiency of the network.

Different energy saving techniques are proposed for Wi-Fi networks in [67]. One approach is to enable switching APs on and off according to demand. Another approach is to form clusters of APs and decide whether to turn on or off the APs. The main drawbacks of these solutions are 1) the difficulty of implementation, 2) the use of vendor-specific frameworks, 3) the amount of required processing power, 4) the ignorance of the APs boot-up time, and 5) the high number of handovers imposed on the stations (STAs), due to frequent topology changes.

#### 1) THE ENERGY CONSUMPTION MANAGEMENT ALGORITHM

In SooGREEN, we have proposed a novel algorithm called, Energy Consumption Management Algorithm (ECMA), to address the problem of energy wastage in current Wi-Fi APs. ECMA can serve both normal and dense Wi-Fi networks. An example of a dense Wi-Fi network can be an enterprise building, or a university campus, with a large number of APs distributed along the site. Figure 26 shows one possible network infrastructure that the ECMA algorithm is intended to address. The ECMA algorithm adopts a different behavior depending on operating in either online or offline modes. An online period is a period of time that normal users are active while an offline one is when very few or no users are active in the network. The duty cycle of a WLAN is defined as a relation between the online and offline periods.

Figure 27 represents the main building blocks of the ECMA algorithm. Different from the state-of-the-art, the ECMA algorithm includes the following phases:

- **Prediction of network traffic pattern based on the prior traffic analysis:** In this phase, ECMA collects the network data over a certain period of time to learn the utilization patterns of the network. This data includes parameters such as number of users associated to each AP, the transmitted/received traffic over the radio interfaces, and APs channel utilization.
- **Detecting and reacting to traffic pattern changes, by providing network resources on demand:** This

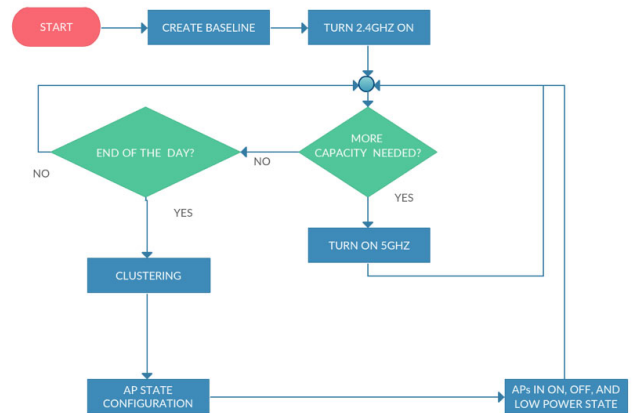

FIGURE 27. ECMA algorithm flowchart.

phase is responsible for the radio interfaces management, during the network online period. Normally, the 2.4 GHz radio interfaces are ON, unless the traffic is above a given threshold. The central controller, where the ECMA is running, checks the channel utilization and decides if 5 GHz radio interfaces must remain off or be turned on in order to add an extra capacity layer to the wireless network. When the baseline data indicates the network is entering in the offline period, and there are no users associated to the APs, the controller begins the next phase of the algorithm, that is, to form clusters of APs.

- **Creating clusters of APs for maximum energy savings during network offline periods:** The main idea is to form clusters of APs, where each cluster is composed of a set of APs adequately close to each other [68]. The clustering algorithm provides a hierarchy of APs which makes it possible to integrate the management of APs. Once the topology of each cluster is formed, an AP State configuration mechanism defines the state of each AP as is depicted in Figure 28. Within each cluster, the cluster-head AP is always in ON state. The second AP in the hierarchy is a backup AP, however, its radio interfaces are switched off (LOW POWER state). All other APs in the cluster are in the OFF state thus consuming no energy. LOW POWER state is necessary since the power up time may take 5 to 6 minutes and it affects the reaction time of the network. To enable a quick response time (few seconds), in case of unexpected traffic, and to guarantee QoS on the network, one AP is always set into a LOW POWER state. When the offline period ends, the clusters are dismantled and all APs switch on their 2.4 GHz radio interfaces again, starting a new online period.

#### 2) WI-FI ENERGY SAVING EVALUATION

To evaluate the energy saving performance of the ECMA algorithm, we used the IEEE 802.11n standard [69]. Based on the collected logs from real enterprise networks, typical online and offline periods can be found. In our study,  $\theta$  is

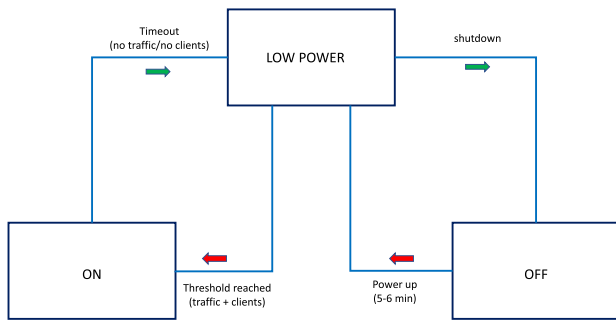

FIGURE 28. AP State configuration.

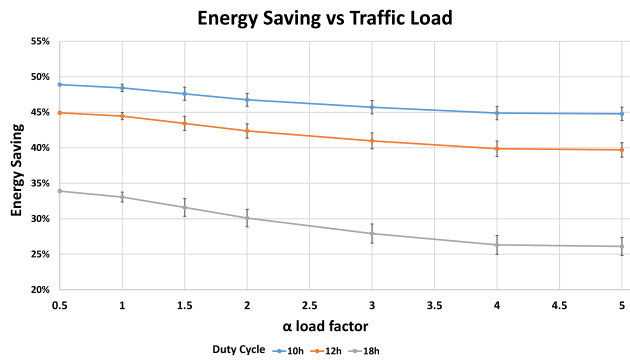

FIGURE 29. Energy saving percentages, obtained for a 4-AP cluster, as a function of the offered load ( $\alpha = 1$  corresponds to traffic between 1 and 4 Mbps per STA).

the duty cycle of an enterprise WLAN defined as the number of hours per day with users associated to the network e.g.,  $\theta = 10, 12$  and 18 hours. Parameter  $\alpha$  is the STAs offered load factor ( $\alpha = 0.5, 1, 1.5, 2, 3, 4, 5$ ), with each spanning a range of traffic rates between 1 and 4 Mbps per STA. A broad range of traffic intensities is hence allowed, multiplying the load factor by the aforementioned range of traffic rates, corresponding to data rates between 0.5 and 20 Mbps per terminal.

Figure 29 illustrates the energy saving percentages of a 4-AP cluster, as a function of the traffic load and the duty cycle of a network. The saving percentages are calculated by comparing the energy consumption while adopting the ECMA algorithm, with that incurred in current APs deployment without ECMA. The energy saving is approximately between 25% and 50% depending on the load factor and the duty cycle. In fact, an enterprise whose network is online for a longer period will have lower energy savings, since the algorithm will keep the radio interfaces switched on until there are no users generating traffic.

Figure 30 depicts the impact of cluster size on the energy savings with  $\alpha = 1$ . As the cluster size increases, the amount of energy saving also increases, e.g., 45% in case of a 4-AP cluster. Clearly, with more number of APs in a cluster, the AP State configuration mechanism can switch off a higher numbers of radio interfaces.

To further evaluate the ECMA algorithm, we investigate the performance of the network in terms of packets

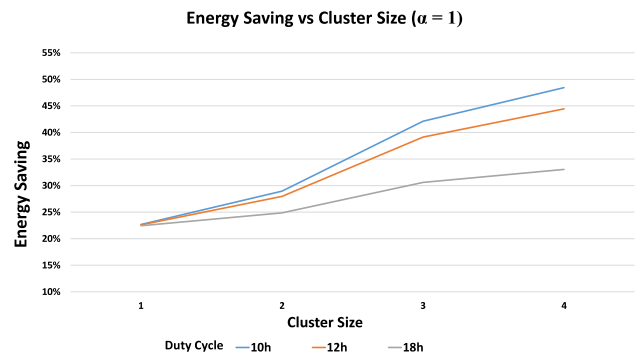

FIGURE 30. Energy savings according to cluster size ( $\alpha = 1$  corresponds to traffic between 1 and 4 Mbps per STA).

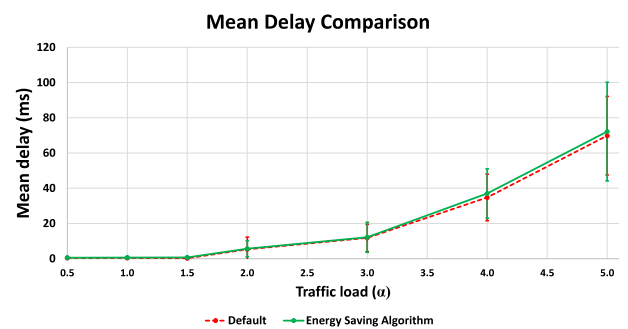

FIGURE 31. Mean delay: Comparison between current scenario and the scenario where the ECMA algorithm is used.

mean delay. We considered a scenario with the same network topology in the offline period and with the occurrence of unexpected traffic. The main objective was to determine the trade-off between energy saving and mean delay. We compared the solutions of ECMA algorithm with the default case, i.e., today's Wi-Fi networks having all APs on. The AP State configuration mechanism is constantly running having the cluster-head AP always switched on, and a second AP configured in LOW POWER state, ready to deploy its SSID. Figure 31 depicts the mean delay of the proposed ECMA algorithm compared with no energy saving mechanisms, i.e., current Wi-Fi networks. Figure 31 reveals that, on average, the network performance degradation introduced by ECMA is practically negligible, since the energy saving solution has ways to react to unpredicted traffic.

As a conclusion, the obtained results stress out the significant achievable energy savings when applying the proposed ECMA algorithm. Indeed, in part of SooGREEN project work, the developed ECMA mechanism can constitute a pretty valuable contribution to global energy savings when applied to present and especially future dense Wi-Fi networks.

### B. ENERGY-SAVING DAS IN ROAD AND TRAIN TUNNELS

DAS is a promising solution to provide high data rate services into the closed environments such as buildings and tunnels. The aim of DAS is to shorten the transmission distance.

In conventional antenna systems, the antennas are centrally collocated, whereas in DAS the remote antennas are distributed over the cell. In DAS, the cell is divided into multiple sectors and the remote antennas are connected to the BS via optical fiber or cable [70].

DAS systems are categorized into three classes namely, active, passive, and hybrid DAS. Passive DAS utilizes only passive components such as coaxial cables, splitters, combiners, and filters. These systems are easy to design and is resistant in harsh environments. The main disadvantage of passive DAS is the high loss in transmission. Therefore, a high-power BS is required to feed a system of coaxial cables and hence high noise level exists in the uplink. Unlike the passive DAS where only passive components are used, in active DAS active components such as optical fiber, master unit, and remote unit to transmit signal from BS to the antenna network are used. In active DAS, the total RF loss is much lower than that of passive DAS. As a chain of RF to optical interfaces and optical to RF interfaces are used to propagate the RF signal over long distances using fiber instead of coaxial cables, the uplink and downlink RF amplifiers are located after the optical to RF interface and closer to the antenna because of which transmission power required from the amplifiers is much lower. Furthermore, active DAS is more flexible to change of design after the initial installation. Hybrid DAS works similar to active DAS. It inherits the advantages of both passive and active DAS. It uses fibers but still relies on passive coaxial cables for signal distribution. Hybrid DAS could be a potential solution for medium-sized buildings, tunnels, or areas, where multiple passive DASs can be linked by fiber cables. In the current DAS equipment design, there is no transmission time interval (TTI) or symbol-level sleeping features. However, utilizing energy saving features such as power control, excess layer shut down, and antenna sleeping can save significant energy in the network.

In SooGREEN, we studied multi-vendor multi-band indoor mobile coverage systems that use fiber DAS consisting of master unit, RU, antenna network and operator-controlled BSs. We consider a tunnel scenario in which leaky feeder cables are used instead of antennas. To assess the energy saving benefit/potential of such features, we implemented the setup in two tunnels, a road tunnel and a train tunnel, in Stockholm, Sweden. In these two case studies, we explore the power saving opportunities using time-domain sleeping and layer shut down during the low traffic hours. In order to investigate the power consumption of the system, 47 RUs and 2 master units have been measured along a duration of two weeks.

### 1) ROAD TUNNEL

In this case study, we consider a 10-km long road-tunnel with five sectors where we use the same leaky feeder for downlink and uplink. In each sector, one leaky cable is connected to all the RUs of different bands of different operators. In total, there are 16 BSs that belong to three different operators. In this network, operators are providing 2G, 3G, and 4G

TABLE 4. DAS Case study I: Road tunnel.

#### (a) Studied Parameters

Parameter	Value
Length	10 km
Number of operators	3
Number of sectors	5
Number of BSs	16
Number of base station interface units (BIUs)	30
Number of fiber optic interfaces (FOIs)	16
Number of RUs	30
Length of leaky feeder	10 km

#### (b) Measured Power Consumption

	Power consumption (kW)		
	2G	3G	4G
BSs	3.12	3.37	4.6
RUs	4.2	5.7	
BIU	0.45		
FOI	0.24		
Total	21.67		

services. Both GSM (2G) and 3G are for voice traffic in the tunnel which is required to operate with full functionality during the rush hours. Otherwise, GSM RUs can be turned off when the traffic is not very high. As a part of this study, the power consumption of all active components was studied for a time duration of two weeks. More details of the tunnel and installed equipment are also listed in Table 4a and the corresponding measurement of energy consumption is reported in Table 4b.

By turning off the RUs, 4.2 kW power saving is reported which corresponds to decreasing the overall energy consumption of the entire tunnel network by 19.3%. Additional energy savings can be achieved by also turning off the GSM BS, thus resulting in an additional 3.12 kW power saving, leading to a total of 33.7% energy saving during low traffic hours.

### 2) TRAIN TUNNEL

In this case study, we investigate an 8.7 km train tunnel with separate leaky feeder for downlink and uplink. These types of tunnels are slightly different when compared to road tunnels since there exists no traffic in between the trains passing the tunnel. As per the information provided by the transport agency, there are maximum 10 trains per hour in 2016 at peak times. Considering a train travelling at 200 km/h, it takes around 2.5 minutes to cross the tunnel. Hence, the tunnel has traffic only 41% of the time. The details of the tunnel and installed equipment have been listed in Table 5a and the corresponding measurement of energy consumption has been reported in Table 5b. This means that if appropriate schemes can be devised, the power consumption can be reduced to half (12.5 kW) when all the layers can be shut down or sent to deep sleep mode when there is no passing train. This yields 64.600 kWh of energy saving per year. There are currently around 150 long railway tunnels (> 5km) in Europe [71].

**TABLE 5. DAS case study II: Train tunnel.**

(a) Studied Parameters

Parameter	Value
Length	8.7 km
Frequency of trains	10 trains/h
Speed of trains	140-200 km/h
Number of sectors	3
Number of operators	5
Number of BSs	11
Number of BIU	33
Number of RUs	63
Number of FOI	63
Length of leaky feeder	17.4 km

(b) Measured Power Consumption

	Power consumption (kW)		
	2G	3G	4G
BSs	2.6	2.38	4.75
RUs	5.88	7.94	
BIU	0.5		
FOI	0.32	0.32	0.32
Total	24.988		

Assuming similar settings and equipment, the savings could amount up to 9.690 MWh per year. For a European home which uses 175 kWh/m<sup>2</sup> heating energies per year [72], this energy could heat close to 700 homes with a size of 80 m<sup>2</sup>.

The analysis of this study revealed the overall power consumption of a DAS in road and train tunnels and helps us identify that the remote units have a major share of power consumption in the network and that the power consumption of the remote units can depend on the coverage area and number of operators in a network. Furthermore, this study showed that there are considerable energy saving opportunities in such indoor networks, since the traffic in road and train tunnels is intermittent and hence the demand for coverage may go down to zero over some periods of time.

## VI. CHALLENGES, FUTURE TRENDS, AND RECOMMENDATIONS

Research and collaborative projects targeting green wireless networks are paving all sectors including mobile, fixed and backbone networks. The purpose of this article is to present what is a green mobile network and what are the current trends in this field. Different degrees of freedom have been emphasized to highlight the enablers for a green wireless access network and to tackle with the ICT sector commitment in terms of energy and environmental impact. This article also has the ambition to clarify research trends and KPIs in radio and of mobile network deployments. We have addressed existing and emerging technologies, and the convergence of the different network facilities towards greener resource consumption. However, device evolution has not been considered and should be addressed in dedicated research efforts. The article is also intended to foster discussions within the different stakeholders involved in the subject across organizations and activities especially operators. The main part of

the mobile network consumption is in the radio access and a lot of efforts (like RE, sleep-mode and passive cooling) are performed at this stage. However, other effects on the mobile core network and its backhaul shall not be neglected especially when new architectures are considered.

### A. GREEN MOBILE NETWORKS

Mobile networks are today responsible for about 20 - 25% of the aggregate information technology network (ITN) consumption including the data center, and will dramatically increase in the next decade due to new networks deployments and traffic demand exponential increase (about 30 to 40% per year).

In a short-term view, trends are moving towards making energy consumption more traffic load dependent. Actual macro BS is highly consuming even for low traffic load. A special care should be maintained for site-sharing initiatives (including outsourcing towards Tower Companies) to maintain assets in the green field. The technical environment (cooling, energy backup) shall not be neglected as they are highly consuming. Ventilation should be stated as a default installation configuration rather than active cooling. Passive (free) cooling can reduce the site cooling energy consumption by a factor of 8-10.

In a long-term vision, a global top-down approach is fundamental to balance the energy consumption regarding the traffic evolution in the next decade. A global approach allows to sustainably manage the evolution of our networks taking into account environmental impacts. Trends are towards new architectures that allow:

- Connecting large number of various devices and objects including critical ones.
- Geographical and social inclusion.
- Deployment everywhere.
- Efficient energy and natural resource usage.
- Trust and security.
- Collecting, processing and transporting a huge amount of data.

Those attractive concepts should be carefully studied mainly to avoid rebound effect on the backhaul and the core networks. Furthermore, hybrid energy renewable sources (PV, wind, batteries) should be optimized for diet-radio BSs especially for AMEA (Asia, Middle East and Africa) in accordance with natural energy assets in those countries.

Globally, the question of energy-free objects and network massive densification managed and orchestrated using artificial intelligence (AI) shall be the main driver for future networks. There is no magic response that should be applicable for any situation. This important question shall be considered regarding future disruptive services and corresponding networks urbanism regarding social acceptability and ethics. Indeed, we strongly believe that the future progress in mobile networks will face the question of privacy and security as a main driver.

Finally, intensive involvement in the standardization of green networks is the key to guarantee that green solutions



will be inter-operable, cost-efficient and ready in time. This requires more coordination efforts and a large consensus among the major stakeholders.

### B. FUTURE NETWORK ARCHITECTURES

The undergoing virtualization of mobile networks has not yet delivered the full promises on TCO gains and energy savings. In addition to normal transformation and learning curve, this can be explained by the lack of openness in the currently proposed architecture/solutions, resulting in heavy integration processes and limited interoperability.

To achieve the promise of becoming the ubiquitous fabric for universal connectivity, with ultra-dynamic slicing capabilities, future mobile networks will have to evolve towards far more open architectures, fully adopting the cloud-native principles, refactoring current VNFs into smaller pieces (micro-services), easily deployable and composable on Platforms (as a Service, PaaS) by highly-automated service/slice orchestrators. Substantial energy gains will be achievable only if such micro-services will have a sufficient granularity to allow very dynamic creation/scaling/deletion as function of e.g. service demand, traffic load, number of connected IoT objects,...etc. However, some critical challenges to such evolution still necessitate suitable solutions.

Full decomposition into fine-grained microservices of RAN functions, in particular those related to real-time PHY and MAC processing, is still to come. So far such functions are distributed as single applications, or at best packaged into two containers, grouping lower and higher layer functions. This considerably limits the flexibility gains of cloudification: by occupying fixed amount of resources (CPU, memory...), dimensioned at peak hour, this approach prevents the adoption of more energy-efficient scale-to-load solutions. However, moving into finer granularity requires to deal with specific hard constraints, in both processing time and inter-process delay, with available budget under the  $\mu$ sec scale. Microservice-RAN necessitates new inter-process communication means, as well as a smoother and cheaper integration of hardware accelerators.

Additional challenges come from the necessity of dealing with legacy network functions to ensure coexistence, interworking, refactoring and a smooth migration. Standardization fora, such as 3GPP, will have to integrate solutions from open-source communities, especially from the IT sector. Even if more political than technological, this remains as a major challenge to be tackled in the future.

### C. SMART GRIDS AND RENEWABLE ENERGY

5G networks go far beyond previous standards in data rates, diversity and other performance indicators, including EE which is the present focus of this work. In this paper, we analyzed how smart grids, RE sources and modern batteries such as Lithium along with suitable energy efficiency oriented KPIs allow significant energy savings and sustainability. This trend shall continue and even get amplified, thanks to the technological advances on one side, notably in terms of RE

production and storage, but also public awareness on the need to consume in a smarter and greener manner. Based on this, new proposals will always be needed not only to operate future networks in the most energy economical ways, but also to be able to produce and store "clean" energy.

If smart grids and RE can help improving energy efficiency towards and along 5G, 5G networks can conversely play a key role in the undergoing evolution of electrical grids. The electrical grid is getting smarter and more flexible giving access to new players to be part of the electricity supply chain in order to ensure an efficient balancing between supply and demand and optimize the transmission and the distribution of the electricity. This results in complex grids with high adaptation dynamics. The monitoring and the management of such smart grid networks will require a huge number of connections (wired and wireless) between customers and energy aggregators. Such high dynamics will require low latency in order to allow fast adaptation of the grid. In this context, thanks to the network slicing concept, mobile networks (5G and beyond) will play a key role to provide the required connectivity. The mobile operators are working on the definition of the dedicated network slices for the smart grid network carrying this massive M2M communications. These slices will need to be dynamically created and configured in order to respond to the smart grid service requirements enabling the aggregation of many players and many sensors for better centralized view on the grid and better power management.

### D. INDOOR SYSTEMS

In global wireless access over the upcoming years, the number of Wi-Fi indoor systems will continue to maintain and grow its strategic importance. In fact, according to Cisco Visual Networking Index [73], by 2021, Wi-Fi will account for 45.5% of global IP traffic, against 37.1% for wired and 17.4% for cellular. Therefore, in Wi-Fi, the need for energy efficient mechanisms remains to be a very relevant issue. For indoor systems, a significant improvement will arrive with the new Wi-Fi 6 (IEEE 802.11ax) standard. This standard is intended to achieve a closer interaction with cellular technologies, namely 5G, as both technologies are expanding their capabilities and will be able to take advantage of one another. In the same way as 5G, Wi-Fi 6 targets dense environments, such as stadiums, airports, and college campuses, along with a focus on IoT scenarios. Technologies such as Wi-Fi Offloading, Multipath TCP, Target Wake Time mechanism and SIM authentication with Passpoint, are a set of different ways in which 5G and Wi-Fi networks can provide better services to users and, simultaneously, to empower the development of advanced energy efficient systems.

Another emerging communication technology for indoor deployments is Light Communication, whom adoption curve is exiting the exploratory phase to enter the pre-industrialization phase, with a growing ecosystem (e.g. Light Communication Alliance) and some solid industrial use cases and deployments (for example for communication

inside airplanes). This technology, specific to indoor communications, provides very high data rates in short-range conditions. In addition, its low power consumption, coupled with strong resistance to interference, makes it a strong candidate to improve energy efficiency in indoor communications. A smooth integration of these new technologies with cellular networks, for example as additional supported radio interfaces, is a challenging yet highly promising opportunity for improving the overall energy efficiency of wireless communications.

Actually, regardless of the wireless technology used, an indoor network has a growth margin for more efficiency, both in spectrum and energy resources. In view of that, Automation and AI frameworks are now valuable emerging tools that will help the achievement of superior link performance and network energy efficiency. With these tools, new and intelligent green mechanisms can be designed, maximizing spectrum efficiency and network capacity during periods of peak usage, while offloading and providing minimum resources during periods of low usage. AI/ML-based algorithms are also expected to help in improving location of user, which in turns enable precise and dynamic activation/deactivation of radio links, a further opportunity for energy reduction. However all these techniques must consider the additional costs of training and using AI-models, and attentive studies must prove the expected energy gains.

#### E. USE OF ARTIFICIAL INTELLIGENCE

To capitalize on the long exerted efforts in SooGREEN summarized in this article, another EU Celtic-Plus project has been approved and started this year focusing to further employ the recent AI advances for greener networks. The envisioned efforts in the new project, entitled AI for Green Networks or AI4Green for short, target core and access network segments alike. We briefly highlight in the following some directions where AI is seen to offer remarkable savings and smarter control of network energy consumption.

The main objective of the AI4Green project is to leverage the available huge datasets of network measurements at the different network operators and equipment vendors, along with the rich literature and powerful tools of machine learning, big data and AI to optimally provision, operate, and maintain mobile networks. One direction is to perform techno-economic studies that investigate potential benefits of operators to reduce their energy consumption using marketplaces. Another direction is AI-based network planning and modeling of uncertain environments that cannot be analyzed otherwise using tractable analytical models. In this context, AI-based techniques prove to be efficient in learning them and drawing meaningful conclusions and recommendations. A third direction is to employ AI-based techniques for data-driven estimation and optimization of service energy consumption, power flow management, AI-based control of powering and cooling facilities, managing real-time

data transmission and processing, site analysis, the joint planning of computational and communication resources, among others.

#### VII. CONCLUSION

In this article, ongoing efforts and future challenges on turning current mobile networks into green networks are discussed, with emphasis on those exerted and lessons learned in the recently concluded EU Celtic-Plus SooGREEN project. The discussions and contributions spanned a wide range of network segments and services, including means to monitor and evaluate the energy efficiency of networks, and several innovative solutions to reduce energy consumption. Proposed solutions for 5G networks and beyond included virtualized architectures for densified infrastructure, efficient polar coding for fronthauling, new designs for edge hardware accelerators, use of RE in mobile networks with local storage and smart grid integration, passive cooling for central offices, and enabling smart sleep modes for indoor WiFi networks and DAS systems. The efforts did not only include technical recommendations for network evolution, but also techno-economic studies for the migration of networks to these proposed solutions. Such studies are aimed to foster further technical discussions of the different stakeholders in the ICT sector, unifying academic and industrial expertise, to offer more attainable sustainability and cost efficiency in the currently fast growing and massively densified networks. Future trends are further emphasized, discussing the promising potential of AI in offering such a network smart agility to control real-time network monitoring and enable traffic-dependent network utilization.

#### ACKNOWLEDGMENT

The authors would like to thank Abdulrahman Alabbasi, Didier Marquet, Mamdouh El-Tabach, Mats Nilsson, Wilfried Yoro and Xinbo Wang for their contributions and active participation in the EU Celtic-Plus SooGREEN Project and its associated publication, dissemination and standardization efforts. Authors P. Silva and N. T. Almeida would like to address a special thank to Dr. Rui Campos, from INESC TEC, for his inestimable and continuous contribution to the developed work as well as to Tiago Oliveira and Saravanan Kandasamy for their valuable participation in the initial phase of the project. They also would like to thank Pedro Rodrigues, José Fonseca, and Diogo Costa, all from Eurico Ferreira, for the helpful discussions and accomplished collaborations along the realization of this work.

#### REFERENCES

- [1] *3rd Generation Partnership Project; Technical Specification Group Services and System Aspects; Release 15 Description; Summary of Rel-15 Work Items (Release 15)*, document TR 21.915 V0.6.0, 3GPP, Feb. 2019.
- [2] M. Olsson, Ed., "Deliverable 6.4: Final integrated concept," EARTH, Tech. Rep. INFSO-ICT-247733, 2012.
- [3] Green Touch Foundation, "GreenTouch final results from Green Meter research study," GreenTouch Found., Wakefield, MA, USA, White Paper V1.0, Jun. 2015. [Online]. Available: <https://pdfs.semanticscholar.org/5343/fbf14ad7c4affe56166ad9f0cd54681d64d.pdf>

- [4] M. Aubree, D. Marquet, S. Le Masson, H. Louahlia, A. Chehade, J. David, and F. Van Goethem, "OPERA-Net 2 project—An environmental global approach for radio access networks—achievements for off-grid systems," in *Proc. IEEE 36th Int. Telecommun. Energy Conf. (INTELEC)*, Sep./Oct. 2014, pp. 1–7.
- [5] M. Olsson, C. Cavdar, P. Frenger, S. Tombaz, D. Sabella, and R. Jantti, "5GrEEen: Towards green 5G mobile networks," in *Proc. IEEE 9th Int. Conf. Wireless Mobile Comput., Netw. Commun. (WiMob)*, Oct. 2013, pp. 212–216.
- [6] G. Auer, V. Giannini, C. Desset, I. Godor, P. Skillermark, M. Olsson, M. A. Imran, D. Sabella, M. J. Gonzalez, O. Blume, and A. Fehske, "How much energy is needed to run a wireless network?" *IEEE Trans. Wireless Commun.*, vol. 18, no. 5, pp. 40–49, Oct. 2011.
- [7] M. M. A. Hossain, R. Jantti, and C. Cavdar, "Dimensioning of PA for massive MIMO system with load adaptive number of antennas," in *Proc. IEEE Globecom Workshops (GC Wkshps)*, Dec. 2014, pp. 1102–1108.
- [8] A. A. W. Ahmed, J. Markendahl, C. Cavdar, and A. Ghanbari, "Study on the effects of backhaul solutions on indoor mobile deployment 'macrocell vs. femtocell'," in *Proc. IEEE PIMRC*, Sep. 2013, pp. 2444–2448.
- [9] A. A. W. Ahmed, J. Markendahl, and C. Cavdar, "Interplay between cost, capacity and power consumption in heterogeneous mobile networks," in *Proc. 21st Int. Conf. Telecommun. (ICT)*, May 2014, pp. 98–102.
- [10] P. Frenger, M. Olsson, and E. Eriksson, "A clean slate radio network designed for maximum energy performance," in *Proc. IEEE PIMRC*, Sep. 2014, pp. 1300–1304.
- [11] China Mobile, "C-RAN: The road towards green RAN," China Mobile Res. Inst. White Paper, Version 2.5, Oct. 2011, vol. 2, pp. 1–10. [Online]. Available: <https://pdfs.semanticscholar.org/ea3/ca62c9d5653e4f2318aed9ddb8992a505d3c.pdf>
- [12] *Environmental Engineering (EE): Assessment of Mobile Network Energy Efficiency—Annex B: Cloud RAN Energy Efficiency*, Standard ETSI ES 203 228 V1.2.1, Apr. 2017.
- [13] X. Wang, L. Wang, C. Cavdar, M. Tornatore, G. B. Figueiredo, H. S. Chung, H. H. Lee, S. Park, and B. Mukherjee, "Handover reduction in virtualized cloud radio access networks using TWDM-PON fronthaul," *IEEE/OSA J. Opt. Commun. Netw.*, vol. 8, no. 12, pp. B124–B134, Dec. 2016.
- [14] X. Wang, C. Cavdar, L. Wang, M. Tornatore, Y. Zhao, H. S. Chung, H. H. Lee, S. Park, and B. Mukherjee, "Joint allocation of radio and optical resources in virtualized cloud RAN with CoMP," in *Proc. IEEE GLOBECOM*, Dec. 2016, pp. 1–6.
- [15] X. Wang, L. Wang, S. E. Elayoubi, A. Conte, B. Mukherjee, and C. Cavdar, "Centralize or distribute? A techno-economic study to design a low-cost cloud radio access network," in *Proc. IEEE ICC*, May 2017, pp. 1–7.
- [16] X. Wang, A. Alabbasi, and C. Cavdar, "Interplay of energy and bandwidth consumption in CRAN with optimal function split," in *Proc. IEEE ICC*, May 2017, pp. 1–6.
- [17] A. Alabbasi and C. Cavdar, "Delay-aware green hybrid CRAN," in *Proc. 15th Int. Symp. Modeling Optim. Mobile, Ad Hoc, Wireless Netw. (WiOpt)*, May 2017, pp. 1–7.
- [18] X. Wang, C. Cavdar, L. Wang, M. Tornatore, H. S. Chung, H. H. Lee, S. M. Park, and B. Mukherjee, "Virtualized cloud radio access network for 5G transport," *IEEE Commun. Mag.*, vol. 55, no. 9, pp. 202–209, Sep. 2017.
- [19] A. Alabbasi, X. Wang, and C. Cavdar, "Optimal processing allocation to minimize energy and bandwidth consumption in hybrid CRAN," *IEEE Trans. Green Commun. Netw.*, vol. 2, no. 2, pp. 545–555, Jun. 2018.
- [20] M. Masoudi, B. Khamidehi, and C. Cavdar, "Green cloud computing for multi cell networks," in *Proc. IEEE Wireless Commun. Netw. Conf. (WCNC)*, Mar. 2017, pp. 1–6.
- [21] M. Masoudi and C. Cavdar, "Device vs edge computing for mobile services: Delay-aware decision making to minimize power consumption," 2017, *arXiv:1711.03771*. [Online]. Available: <https://arxiv.org/abs/1711.03771>
- [22] A. Sriram, M. Masoudi, A. Alabbasi, and C. Cavdar, "Joint functional splitting and content placement for green hybrid CRAN," in *Proc. IEEE 30th Annu. Int. Symp. Pers., Indoor Mobile Radio Commun. (PIMRC)*, Istanbul, Turkey, 2019, pp. 1–7.
- [23] H. A. H. Hassan, L. Nuaymi, and A. Pelov, "Renewable energy in cellular networks: A survey," in *Proc. IEEE Online Conf. Green Commun. (OnlineGreenComm)*, Oct. 2013, pp. 1–7.
- [24] A. El-Amine, H. A. H. Hassan, and L. Nuaymi, "Analysis of energy and cost savings in hybrid base stations power configurations," in *Proc. IEEE 87th Veh. Technol. Conf. (VTC Spring)*, Jun. 2018, pp. 1–7.
- [25] A. El-Amine, H. A. H. Hassan, and L. Nuaymi, "Services KPI-based energy management strategies for green wireless networks," in *Proc. IEEE 29th Annu. Int. Symp. Pers., Indoor Mobile Radio Commun. (PIMRC)*, Sep. 2018, pp. 1–7.
- [26] A. El-Amine, H. A. H. Hassan, and L. Nuaymi, "Energy and resource allocations for battery aging-aware green cellular networks," in *Proc. IEEE Global Commun. Conf. (GLOBECOM)*, Dec. 2018, pp. 1–7.
- [27] W. Labidi, T. Chahed, and S.-E. Elayoubi, "Battery management for demand-response in mobile networks powered by a smart grid," in *Proc. IEEE 29th Annu. Int. Symp. Pers., Indoor Mobile Radio Commun. (PIMRC)*, Sep. 2018, pp. 1–7.
- [28] W. Labidi, T. Chahed, and S. E. Elayoubi, "Optimal battery management strategies in mobile networks powered by a smart grid," *IEEE Trans. Green Commun. Netw.*, vol. 2, no. 3, pp. 859–867, Sep. 2018.
- [29] C. Nadjahi, H. Louahlia, A. Conte, and S. Le Masson, "Passive cooling and thermal management in data centers," in *Proc. IEEE Int. Telecommun. Energy Conf. (INTELEC)*, Oct. 2017, pp. 85–90.
- [30] C. Nadjahi, H. Louahlia, and S. Lemasson, "A review of thermal management and innovative cooling strategies for data center," *Sustain. Comput., Inform. Syst.*, vol. 19, pp. 14–28, Sep. 2018.
- [31] H. Rocha, T. Caçoilo, P. Rodrigues, S. Kandasamy, and R. Campos, "Wi-Green: Optimization of the power consumption of Wi-Fi networks sensitive to traffic patterns invited paper," in *Proc. 15th Int. Symp. Modeling Optim. Mobile, Ad Hoc, Wireless Netw. (WiOpt)*, May 2017, pp. 1–5.
- [32] P. Silva, N. T. Almeida, and R. Campos, "Energy consumption management for dense Wi-Fi networks," in *Proc. 11th Annu. Wireless Days Conf.*, Manchester, U.K., Apr. 2019, pp. 1–8.
- [33] *Environmental Engineering (EE): Metrics and Measurement Method for Energy Efficiency of Wireless Access Network Equipment*, Standard ETSI ES 202 706-1 V1.5.0, Oct. 2016.
- [34] A. Bourdon, A. Noureddine, R. Rouvoy, and L. Seinturier, "PowerAPI: A software library to monitor the energy consumed at the process-level," in *ERCIM News* (Special Theme: Smart Energy Systems), vol. 92, ERCIM, Jan. 2013, pp. 43–44. [Online]. Available: <https://hal.inria.fr/hal-00772454>
- [35] A. Noureddine, R. Rouvoy, and L. Seinturier, "A review of energy measurement approaches," *SIGOPS Oper. Syst. Rev.*, vol. 47, no. 3, pp. 42–49, Nov. 2013. doi: [10.1145/2553070.2553077](https://doi.org/10.1145/2553070.2553077).
- [36] A. Maeder, M. Lalam, A. De Domenico, E. Pateromichelakis, D. Wübben, J. Bartelt, R. Fritzsche, and P. Rost, "Towards a flexible functional split for cloud-RAN networks," in *Proc. Eur. Conf. Netw. Commun. (EuCNC)*, Jun. 2014, pp. 1–5.
- [37] J. Liu, S. Zhou, J. Gong, Z. Niu, and S. Xu, "Graph-based framework for flexible baseband function splitting and placement in C-RAN," in *Proc. ICC*, London, U.K., Jun. 2015, pp. 1958–1963.
- [38] A. Checko, A. P. Avramova, M. S. Berger, and H. L. Christiansen, "Evaluating C-RAN fronthaul functional splits in terms of network level energy and cost savings," *J. Commun. Netw.*, vol. 18, no. 2, pp. 162–172, Apr. 2016.
- [39] J. Liu, S. Xu, S. Zhou, and Z. Niu, "Redesigning fronthaul for next-generation networks: Beyond baseband samples and point-to-point links," *IEEE Wireless Commun.*, vol. 22, no. 5, pp. 90–97, Oct. 2015.
- [40] A. Checko, A. C. Juul, H. L. Christiansen, and M. S. Berger, "Synchronization challenges in packet-based cloud-RAN fronthaul for mobile networks," in *Proc. ICCW*, London, U.K., Jun. 2015, pp. 2721–2726.
- [41] M. Vincenzi, A. Antonopoulos, E. Kartsakli, J. Vardakas, L. Alonso, and C. Verikoukis, "Cooperation incentives for multi-operator C-RAN energy efficient sharing," in *Proc. ICC*, Paris, France, May 2017, pp. 1–6.
- [42] G. Tseliou, F. Adelantado, and C. Verikoukis, "Scalable RAN virtualization in multitenant LTE-A heterogeneous networks," *IEEE Trans. Veh. Technol.*, vol. 65, no. 8, pp. 6651–6664, Sep. 2016.
- [43] H. Beyranvand, M. Lévesque, M. Maier, J. A. Salehi, C. Verikoukis, and D. Tipper, "Toward 5G: FiWi enhanced LTE-A HetNets with reliable low-latency fiber backhaul sharing and WiFi offloading," *IEEE/ACM Trans. Netw.*, vol. 25, no. 2, pp. 690–707, Apr. 2017.
- [44] A. Bousia, E. Kartsakli, A. Antonopoulos, L. Alonso, and C. Verikoukis, "Multiobjective auction-based switching-off scheme in heterogeneous networks: To bid or not to bid?" *IEEE Trans. Veh. Technol.*, vol. 65, no. 11, pp. 9168–9180, Nov. 2016.
- [45] Z. Kaleem, M. Yousaf, A. Qamar, A. Ahmad, T. Q. Duong, W. Choi, and A. Jamalipour, "UAV-empowered disaster-resilient edge architecture for delay-sensitive communication," *IEEE Netw.*, to be published.

- [46] OpenCL. *Open Computing Language*. Accessed: 2016. [Online]. Available: <https://www.khronos.org/ocl/>
- [47] T. S. Czajkowski, U. Aydonat, D. Denisenko, J. Freeman, M. Kinsner, D. Neto, J. Wong, P. Yiannacouras, and D. P. Singh, "From openCL to high-performance hardware on FPGAS," in *Proc. 22nd Int. Conf. Field Program. Logic Appl. (FPL)*, Aug. 2012, pp. 531–534.
- [48] HSA Foundation. Accessed: 2016. [Online]. Available: [www.hsafoundation.com/](http://www.hsafoundation.com/)
- [49] J. Cao and M. Yang, "Energy Internet—Towards smart grid 2.0," in *Proc. 4th Int. Conf. Netw. Distrib. Comput.*, Dec. 2013, pp. 105–110.
- [50] R. Ramamonjison and V. K. Bhargava, "Energy allocation and cooperation for energy-efficient wireless two-tier networks," *IEEE Trans. Wireless Commun.*, vol. 15, no. 9, pp. 6434–6448, Sep. 2016.
- [51] M. Mendil, A. De Domenico, V. Heiries, R. Caire, and N. Hadjsaid, "Battery-aware optimization of green small cells: Sizing and energy management," *IEEE Trans. Green Commun. Netw.*, vol. 2, no. 3, pp. 635–651, Sep. 2018.
- [52] E. Altman, *Constrained Markov Decision Processes*, vol. 7. Boca Raton, FL, USA: CRC Press, 1999.
- [53] D. P. Bertsekas, *Dynamic Programming and Optimal Control*, 4th ed. Belmont, MA, USA: Athena Scientific, 2005.
- [54] D. Marquet, B. Françoise, O. Foucault, S. Vaija, E. Philipot, and C. Campion, "How to transform innovative battery opportunities in field operational solutions for telecom/IT," in *Proc. IEEE Int. Telecommun. Energy Conf. (INTELEC)*, Oct. 2018, pp. 1–8.
- [55] *Innovative Energy Storage Technology for Stationary Use—Part 1: Overview of Energy Storage*, document Rec. ITU-T L.1220, Aug. 2017.
- [56] *Environmental Engineering (EE); Powering of Equipment in Access Network*, Standard ETSI EN 302 099 V2.1.0, Jun. 2014.
- [57] *Progressive Migration of a Telecommunication/Information and Communication Technology Site to 400 VDC Sources and Distribution*, document Rec. ITU-T L.1207, May 2018.
- [58] *Sustainable Power Feeding Solutions for 5G Network*, document ITU-T L.5G, 2019.
- [59] J. G. Koomey, "Worldwide electricity used in data centers," *Environ. Res. Lett.*, vol. 3, no. 3, 2008, Art. no. 034008.
- [60] *Electricity Information*, Int. Energy Agency, Paris, France, 2010.
- [61] S. V. Garimella, L.-T. Yeh, and T. Persoons, "Thermal management challenges in telecommunication systems and data centers," *IEEE Trans. Compon., Packag., Manuf. Technol.*, vol. 2, no. 8, pp. 1307–1316, Aug. 2012.
- [62] C. Belady, A. Rawson, J. Pflueger, and T. Cader, "Green grid data center power efficiency metrics: PUE and DCIE," Green Grid, Beaverton, OR, USA, White Paper WP #6, 2008.
- [63] D. Redford, "Thermal management supporting networks in transition," in *Proc. Workshop Therm. Manag. Telecommun. Syst. Data Centers*, 2010, pp. 25–26.
- [64] *Hitachi Europe*, Press Release, Amsterdam, The Netherlands, Sep. 2010.
- [65] S. Greenberg, E. Mills, B. Tschudi, and P. Rumsey, "Myatt. Best practices for data centers: Results from benchmarking 22 datacenters," in *Proc. ACEEE Summer Study Energy Efficiency Buildings*, vol. 16, 2006.
- [66] ABI Research. (2015). *In-Building Mobile Data Traffic Forecast*. Austin, TX, USA. [Online]. Available: <https://www.abiresearch.com/marketresearch/product/1023888-in-building-mobile-data-traffic-forecast/>
- [67] L. M. Hilty, V. Coroama, M. O. de Eicker, T. F. Ruddy, and E. Müller, "The role of ICT in energy consumption and energy efficiency," Rep. Eur. Commission, DG INFSO, Project ICT ENSURE, Eur. ICT Environ. Sustainability Res., Graz Univ., Graz, Austria, Tech. Rep., 2009, vol. 1, pp. 1–60.
- [68] A. P. Jardosh, K. Papagiannaki, E. M. Belding, K. C. Almeroth, G. Iannaccone, and B. Vinnakota, "Green WLANs: On-demand WLAN infrastructures," *Mobile Netw. Appl.*, vol. 14, pp. 798–814, Dec. 2009.
- [69] *IEEE Standard for Information Technology—Telecommunications and Information Exchange Between Systems Local and Metropolitan Area Networks—Specific Requirements—Part 11: Wireless LAN Medium Access Control (MAC) and Physical Layer (PHY) Specifications*, IEEE Standard 802.11-2016 (Revision of IEEE Std 802.11-2012), Dec. 2016, pp. 1–3534.
- [70] J. Wang, H. Zhu, and N. J. Gomes, "Distributed antenna systems for mobile communications in high speed trains," *IEEE J. Sel. Areas Commun.*, vol. 30, no. 4, pp. 675–683, May 2012.
- [71] E. F. J. de Mulder, C. C. D. F. van Ree, and H. R. G. K. Hack, "Geo-environmental aspects of European underground infrastructure," in *Environmental Security of the European Cross-Border Energy Supply Infrastructure*. Dordrecht, The Netherlands: Springer, 2015, pp. 133–153.
- [72] OVO Energy. *How Much Energy Do You Use to Heat Your Home?* [Online]. Available: <https://www.ovoenergy.com/guides/energy-guides/how-muchheating-energy-do-you-use.html>
- [73] *Cisco Global Cloud Index: Forecast and Methodology, 2016–2021*, Cisco, San Jose, CA, USA, 2016.



**MEYSAM MASOUDI** (S'16) received the B.Sc. and M.Sc. degrees in electrical engineering from the Amirkabir University of Technology, Iran, in 2013 and 2016, respectively. He is currently pursuing the Ph.D. degree with the Department of Communication Systems, KTH Royal Institute of Technology, Sweden. His research interests include mobile cloud computing, 5G network architectures, and optimization.



**MOHAMMAD GALAL KHAFAGY** (S'06–M'15–SM'17) received the B.Sc. degree in electrical engineering from the Faculty of Engineering, Alexandria University, Egypt, in 2009, the M.Sc. degree in wireless communications from the School of Communication and Information Technology, Nile University, Egypt, in 2011, and the Ph.D. degree from the King Abdullah University of Science and Technology (KAUST), Thuwal, Makh, Saudi Arabia, in 2016. From 2016 to 2018,

he was a Postdoctoral Researcher at Qatar University, Doha, Qatar. He joined the Wireless Intelligent Networks Center (WINC), Nile University, Egypt, as a Graduate Research Assistant, in 2009. He is currently a Postdoctoral Fellow with the Division of Communication Systems, School of Electrical Engineering and Computer Science (EECS), KTH Royal Institute of Technology, Stockholm, Sweden. His research interests include multiple-antenna techniques, relay-aided communication, performance analysis and protocol design over fading channels, buffer-aided cooperation, and statistical signal processing for communications.



**ALBERTO CONTE** (M'10) received the M.S. degree in corporate communications and telecommunication engineering from the Institut Eurécom, France, in 1996, and the Politecnico di Torino, Italy, in 1997. He joined the Software Department of Bell Labs, initially working on embedded systems and VoIP. He then shifted his research interests to wireless/mobile technologies for both enterprises (Wi-Fi) and public/operated cellular systems. He and his team pioneered the definition of 4G end-to-end mobile networks and delivered solutions for improving their energy efficiency. He is currently the Head of the Cloud-Native Telecom Platforms Automation Department at Nokia Bell Labs, France. He participates in several collaborative EU projects and is an Active Lecturer in LTE technology with Telecom ParisTech, INSA-Lyon and Supelec. He has authored several publications and patents. His current research interests focus on 5G networks with the application of software defined networking (SDN), cloudification, and machine learning.



**ALI EL-AMINE** (S'16) received the B.E. degree in electrical engineering and the M.S. degree in computer engineering from Lebanese American University (LAU), in 2013 and 2016, respectively. He is currently pursuing the Ph.D. degree in computer and networking with IMT Atlantique (formerly Telecom Bretagne), Rennes, France. His research interests focus on green wireless communication, cellular networks, energy efficiency, and machine learning.



**BRIAN FRANÇOISE** received the Diploma degree in electrical engineering from the ESME Sudria School, Paris, France, in 2015. He joined Sofrecom (Orange Gardens) as an Energy and Green ITN Consultant, in 2016, where he involved in the Orange Smart Metering project and is currently a Technical Expert with Orange Labs working on R&D projects. His fields of interests are sustainable power feeding solutions for telecommunication networks, energy storage, renewable energy, and energy efficiency.



**CHAYAN NADJAHİ** received the engineering degree from the École Nationale Supérieure d'Electricité et de Mécanique, Nancy, France, in 2014, the master's degree in research from the University of Lorraine, Nancy, in 2014, the Ph.D. degree from the Normandy University, Saint-Lô, France, in 2018, where he is currently a Researcher. His research study focuses on the passive cooling of data centers.



**FATMA EZZAHRA SALEM** received the engineering degree from the Higher School of Communications of Tunis (Sup'Com), Tunisia, and the master's research degree in wireless communications from CentraleSupélec, France, in 2015. She is currently pursuing the Ph.D. degree with Orange Gardens and Telecom SudParis, France. Her research focuses on green wireless networks, especially the management of advanced sleep modes for 5G networks.



**WAEŁ LABIDI** received the engineering degree from École Supérieure des Communications de Tunis (Sup'Com), Tunisia, in 2013. He is currently pursuing the Ph.D. degree with Institut Mines-Telecom, Telecom SudParis, France. He was a Research Engineer with Commissariat de l'Énergie Atomique, France, from 2014 to 2015, specializing on resource allocation in wireless networks. His current work is on optimization of energy planning for mobile operator empowered

by smart grid, both technical and economical.



**ALTUĞ SÜRAL** was born in Ankara, Turkey, in 1990. He received the B.S. and M.S. degrees from the Electrical and Electronics Engineering Department, Bilkent University, where he is currently pursuing the Ph.D. degree. He is also an R&D Engineer with Polaran Ltd. His research interests include error-correcting codes, hardware architecture design and optimization, and VLSI implementation of polar codes.



**AZEDDINE GATI** received the Ph.D. degree from the University of Pierre and Marie Curie (Paris VI), Paris, France, in 2000. Since 2001, he has been with Orange Gardens, France, where he has been involved in research in the fields of applied electromagnetic for telecommunications systems. He is also an Engineer in telecommunication and signal processing. From 1997 to 2001, he was engaged in studying circuit optimization and electromagnetic (EM) computational methods. In 2001, he has been involved in research on radio planning. In 2007, he leads research projects on sustainable development, including EMF, body area networks, wireless network planning tools, and energy in information, communication technology, and service solutions (ICT). Since 2011, he has been leading a research program dedicated to energy efficiency of wireless and fixed telecom systems and is currently responsible of a department dedicated to wireless networks in Orange Labs. He is currently involved in Celtic plus SooGreen Project and the French research project AN spatial modulation. He has coauthored more than 30 papers and 100 international conferences. Dr. Gati is a member of the Union Radio Scientifique International, France. He is a Senior Member of SEE. He has been involved in European Celtic plus OPERA-Net 1 & 2 projects and the Vice-Chair of the wireless group in GreenTouch ([www.greentouch.org](http://www.greentouch.org)). He is currently involved in Celtic OPERA-Net 1 & 2 and SooGreen projects and was elected as Vice-Chair of the technical committee leading the GreenTouch project ([www.greentouch.org](http://www.greentouch.org)).



**DOMINIQUE BODÉRÉ** received the engineering degree in IT systems integration from the Conservatoire National des Arts et Métiers, in 1995. He is currently a Soogreen Project Coordinator and an ITN Energy Optimization & Eco-efficiency Project Manager with Orange Labs. After the degree, he joined Orange (previously France Télécom R&D) and the Fixed Access Networks Department of Orange Labs, initially working on access networks development for Orange group. He then shifted to green transformation, data knowledge, traffic & resources modeling division of Orange Labs. His team's current study focuses on ITN Energy Optimization & Eco-efficiency. He participates in several collaborative EU projects.



**ERDAL ARIKAN** (S'84-M'89-SM'94-F'11) received the B.S. degree in electrical engineering from the California Institute of Technology, Pasadena, CA, USA, in 1981, and the M.S. and Ph.D. degrees in electrical engineering from the Massachusetts Institute of Technology, Cambridge, MA, USA, in 1982 and 1985, respectively. Since 1987, he has been with the Electrical-Electronics Engineering Department, Bilkent University, Ankara, Turkey, where he is a Professor. He is also the Founder of Polaran Ltd, a company specializing in polar coding products. He was a recipient of the 2010 IEEE Information Theory Society Paper Award, the 2013 IEEE W.R.G. Baker Award, the 2018 IEEE Hamming Medal, and the 2019 Claude E. Shannon Award.



**FRED AKLAMANU** received the B.Sc. degree in telecommunications engineering from the Ghana Technology University College, Ghana, in 2012, and the M.Sc. degree in computer science for communication networks from Télécom SudParis, France, in 2016. He is currently pursuing the Ph.D. degree in telecom engineering with Nokia Bell Labs and Télécom SudParis, France. He joined Huawei Technologies, Ghana, as a Radio Network Optimization Engineer, from 2012 to 2014.

He joined Akka Technologies, France, briefly after his master's degree, as a software developer. His research interests include 5G networks, intent-based networking, software defined networks (SDN), and network function virtualization (NFV).



**LOUTFI NUAYMI** (S'97–M'01–SM'14) received the Diploma degree in telecommunication engineering from Saint Joseph University, Beirut, Lebanon, in 1993 and the Ph.D. degree in telecommunication from the École Nationale Supérieure des Télécommunications (ENST), now Telecom Paris Tech, Paris, France, in 2001. He is currently a Full Professor at IMT Atlantique (previously Telecom Bretagne and ENST Bretagne), Rennes, France. He has authored WiMAX, published by

(Wiley, in 2007) and many journal and conference papers. His fields of interest are radio resource management, energy-efficiency, and machines cellular coverage in wireless networks.



**HASNA LOUAHLIA-GUALOUS** received the Ph.D. degree in two-phase flow from the University of Franche-Comté and the HDR diploma degree from Belfort Montbéliard University. She is currently a Full Professor in heat and mass transfer with the UNICAEN, Normandie University. She has published more than 100 international journals and conference papers and supervised 20 Ph.D. students. Her research interests include fuel cell, microfluidics, and passive cooling.



**LUC MEUNIER** received the Diploma degree in industrial engineering from INPG - Grenoble, France. He started working in the telecom sector, in 1998, optimizing the network resources and is currently with at Tele2, Sweden, involved in the Business Sustainable Development and Energy Efficiency. His research study focuses on how to serve telecom customers in the best way with the least impact on the planet.



**JULIEN LALLET** received the Ph.D. degree in electrical engineering from the University of Rennes, in 2008. He joined the company Alcatel-Lucent, in 2011. He was a Postdoctoral Fellow with the University of Bielefeld, Germany, from 2009 to 2010. He has been a Research Engineer at Nokia Bell-Labs, since 2016. His research interests include efficient processing in the context of cloud computing and hardware acceleration on FPGA. He has published papers in computing

architectures and FPGA systems.



**PAULO SILVA** received the M.Sc. degree in electric and computers engineering from the University of Porto, in 2017. He is currently a Researcher with INESC TEC, Porto, Portugal, in the area of wireless communications. His research interests include IEEE 802.11 and computer networks, being involved in projects related with energy efficiency in Wi-Fi networks, the IoT reference architectures, and the NB-IoT SLAs.



**KULDEEP PAREEK** received the joint master's degree in internet technology and architecture from UPMC, Paris and Telecom Paritech and the master's degree in communication system design from KTH, Stockholm. He is an experienced RF expert with a demonstrated history of working in the telecommunications industry, involved in many key projects in Sweden which include European Spallation Source and many underground tunnels. He is currently with MIC Nordic AB,

Kista, Sweden. He skilled in 3G, LTE, RF planning, universal mobile telecommunications systems (UMTS), and radio frequency (RF).



**NUNO T. ALMEIDA** received the degree in electrical and telecommunications engineering, and the Ph.D. degree in electrical and computer engineering from the University of Porto. He is currently a Professor with the Electrical and Computer Engineering Department, Faculty of Engineering, University of Porto, and a Senior Researcher at the Institute for Systems and Computer Engineering (INESC TEC), Porto, Portugal. Since the early 90's, he has been involved in

several European and national research projects, being his main research interests related to wireless LAN communications, particularly the aspects associated to error control and energy efficiency in dense environment WLANs.



**TIJANI CHAHED** received the B.S. and M.S. degrees in electrical and electronics engineering from Bilkent University, Turkey, and the Ph.D. and Habilitation a Diriger des Recherches (HDR) degrees in computer science from the University of Versailles and the University of Paris 6, France, respectively. He is currently a Professor with the Networks and Services Department, Telecom SudParis, France. His research interests include resource allocation and quality of service, notably in wireless networks.



**TORD SJÖLUND** received the master's degree in computer science from LuTH and has prolonged experience with the wireless telecommunications industry. Since 2005, he has been with IBS (In-Building Solutions), and has together with colleagues and partners developed the In-Building Wireless business with a focus on energy-saving and a reduced impact on carbon dioxide in these systems. He is currently with MIC Nordic AB, Kista, Sweden.



**CICEK CAVDAR** received the Ph.D. degree in computer science from the University of California at Davis and Istanbul Technical University, Turkey, in 2009. She is currently an Assistant Professor with the Division of Communication Systems, KTH Royal Institute of Technology. She has been leading the Intelligent Network Systems Research Group with the Radio Systems Laboratory focusing on design and planning of intelligent network architectures, direct air to ground communications and Internet of Things. After her Ph.D., she was an Assistant Professor with the Computer Engineering Department, Istanbul Technical University. She served as the Chair of the Green Communication Systems and Networks Symposium in ICC 2017, Paris. She has been chairing several workshops on the green mobile broadband technologies and Green 5G Mobile Networks last few years co-located with IEEE ICC and GLOBECOM. At Wireless@KTH research center, she has been leading EU EIT Digital projects such as 5GrEEn: Towards Green 5G Mobile Networks and ICARO-EU: Seamless Direct Air to Ground Communications in Europe. She is serving as the Leader of Swedish cluster for the EU Celtic-Plus project SooGREEN—Service Oriented Optimization of Green Mobile Networks and AI4Green —Artificial Intelligence for Green Mobile Networks.

...