



**HAL**  
open science

## Contrasting pelagic ecosystem functioning in eastern and western Baffin Bay revealed by trophic network modeling

Blanche Saint-Béat, Brian D Fath, Cyril Aubry, Jonathan Colombet, Julie Dinasquet, Louis Fortier, Virginie Galindo, Pierre-Luc Grondin, Fabien Joux, Catherine Lalande, et al.

### ► To cite this version:

Blanche Saint-Béat, Brian D Fath, Cyril Aubry, Jonathan Colombet, Julie Dinasquet, et al.. Contrasting pelagic ecosystem functioning in eastern and western Baffin Bay revealed by trophic network modeling. *Elementa: Science of the Anthropocene*, 2020, 8, 10.1525/elementa.397 . hal-03095448

**HAL Id: hal-03095448**

**<https://hal.science/hal-03095448>**

Submitted on 4 Jan 2021

**HAL** is a multi-disciplinary open access archive for the deposit and dissemination of scientific research documents, whether they are published or not. The documents may come from teaching and research institutions in France or abroad, or from public or private research centers.

L'archive ouverte pluridisciplinaire **HAL**, est destinée au dépôt et à la diffusion de documents scientifiques de niveau recherche, publiés ou non, émanant des établissements d'enseignement et de recherche français ou étrangers, des laboratoires publics ou privés.

## RESEARCH ARTICLE

# Contrasting pelagic ecosystem functioning in eastern and western Baffin Bay revealed by trophic network modeling

Blanche Saint-Béat\*, Brian D. Fath<sup>†,‡</sup>, Cyril Aubry\*, Jonathan Colombet<sup>§</sup>, Julie Dinasquet<sup>||</sup>, Louis Fortier\*, Virginie Galindo<sup>¶</sup>, Pierre-Luc Grondin\*, Fabien Joux<sup>||</sup>, Catherine Lalande\*, Mathieu LeBlanc\*, Patrick Raimbault\*\*, Télésphore Sime-Ngando<sup>§</sup>, Jean-Eric Tremblay\*, Daniel Vulot<sup>††,‡‡</sup>, Frédéric Maps\* and Marcel Babin\*

Baffin Bay, located at the Arctic Ocean's 'doorstep', is a heterogeneous environment where a warm and salty eastern current flows northwards in the opposite direction of a cold and relatively fresh Arctic current flowing along the west coast of the bay. This circulation affects the physical and biogeochemical environment on both sides of the bay. The phytoplanktonic species composition is driven by its environment and, in turn, shapes carbon transfer through the planktonic food web. This study aims at determining the effects of such contrasting environments on ecosystem structure and functioning and the consequences for the carbon cycle. Ecological indices calculated from food web flow values provide ecosystem properties that are not accessible by direct in situ measurement. From new biological data gathered during the Green Edge project, we built a planktonic food web model for each side of Baffin Bay, considering several biological processes involved in the carbon cycle, notably in the gravitational, lipid, and microbial carbon pumps. Missing flow values were estimated by linear inverse modeling. Calculated ecological network analysis indices revealed significant differences in the functioning of each ecosystem. The eastern Baffin Bay food web presents a more specialized food web that constrains carbon through specific and efficient pathways, leading to segregation of the microbial loop from the classical grazing chain. In contrast, the western food web showed redundant and shorter pathways that caused a higher carbon export, especially via lipid and microbial pumps, and thus promoted carbon sequestration. Moreover, indirect effects resulting from bottom-up and top-down control impacted pairwise relations between species differently and led to the dominance of mutualism in the eastern food web. These differences in pairwise relations affect the dynamics and evolution of each food web and thus might lead to contrasting responses to ongoing climate change.

**Keywords:** Food web modeling; Network analysis; Carbon cycle; Ecosystem functioning; Baffin bay; Arctic ocean

## Introduction

The planktonic marine ecosystem is involved in the carbon cycle through several biological processes. An important element of the carbon cycle is the fixation of CO<sub>2</sub> by phytoplankton in the surface ocean to produce particulate

organic carbon (POC), a portion of which sinks to the deep ocean by several processes grouped as the "biological pump". Among them, the gravitational pump involves the i) passively sinking POC and ii) fast sinking fecal pellets from zooplankton grazing on primary producers.

\* Takuvik Joint International Laboratory, Université Laval (Canada) – CNRS (France), Département de biologie et Québec-Océan, Université Laval, Québec, CA

<sup>†</sup> Towson University, Department of Biological Sciences, Towson University, Towson, MD, US

<sup>‡</sup> Advanced Systems Analysis Program, International Institute for Applied Systems Analysis, Laxenburg, AT

<sup>§</sup> LMGE, Laboratoire Microorganismes: Génome et Environnement, Clermont Université, Université Clermont-Auvergne, Aubière Cedex, FR

<sup>||</sup> Sorbonne Université, CNRS, Laboratoire d'Océanographie

Microbienne (LOMIC), Observatoire Océanologique de Banyuls, FR

<sup>¶</sup> Centre for Earth Observation Science, Faculty of Environment, Earth and Resources, University of Manitoba, Winnipeg, CA

\*\* Mediterranean Institute of Oceanography, Aix-Marseille Université, CNRS/INSU, Université de Toulon, FR

<sup>††</sup> Sorbonne Université, CNRS, Station Biologique de Roscoff, Roscoff, FR

<sup>‡‡</sup> Asian School of the Environment, Nanyang Technological University, SG

Corresponding author: Blanche Saint-Béat (blanche.saint-beat@takuvik.ulaval.ca)

An attenuation of the carbon exported during passive sinking can occur due to the remineralization of organic detritus via bacterial degradation (e.g., Kellogg et al., 2011; Le Moigne et al., 2013). Zooplankton are also involved in an active transport of carbon, with very limited attenuation, below the sequestration depth (Visser et al., 2017; Jónasdóttir et al., 2019). The large copepods of the genus *Calanus*, dominating the Arctic Ocean (e.g., Auel and Hagen, 2002; Darnis et al., 2008), evolved their life-cycle strategy (Maps et al., 2014) in order to survive the winter. In spring–summer, *Calanus* converts assimilated food into lipid stores (Hagen and Auel, 2001). Once stores are full, *Calanus* migrates downwards to depths of 600–1400 m where they begin diapause, by reducing their metabolism and consuming their lipid stores during overwintering. By this trait, copepods contribute to the “lipid pump” and allow the sequestration of a similar quantity of carbon to the biological pump (Jónasdóttir et al., 2015). An additional process, the “microbial carbon pump”, involves Bacteria, Archaea, and viruses (Jiao et al., 2010) and refers to microbial processes that transform labile dissolved organic carbon (DOC) into refractory DOC, which is resistant to microbial use and can persist in the water column for thousands of years (Jiao et al., 2010). Three main mechanisms for production of labile DOC have been described: i) direct exudation during growth, ii) release of cell macromolecules during viral lysis, and iii) degradation of particulate organic matter. Thus, the multiple processes occurring within the planktonic marine ecosystem represent key elements in the fate of carbon and its potential sequestration.

Planktonic marine ecosystems are supported at their base by phytoplankton that are strongly affected by their surrounding environment. Primary producers are especially sensitive to the fluctuating light and nutrient conditions that directly control their growth. Because each phytoplankton taxonomic group has developed specific strategies to thrive in the nutrient and light regime to which they have adapted, the phytoplankton community composition and the biogeography of species are largely driven by the physical and biogeochemical oceanographic conditions (Falkowski et al., 2004; Boyd et al., 2010). The phytoplanktonic communities exhibit a set of traits, each having a specific and distinct role in the biogeochemical cycle (Le Quééré et al., 2005). Phytoplankton at the very base of marine ecosystems drive the fate of carbon fixed through photosynthesis by favoring some carbon-flow pathways over others. As a result, phytoplankton communities shape the functioning of marine ecosystems and the carbon cycle. However, an accurate understanding of the complex processes occurring within planktonic communities that define the functioning of the planktonic ecosystem is still missing.

Baffin Bay, the southernmost gateway of the Arctic Ocean, connects the Atlantic and Arctic oceans, forming contrasting physical environments for planktonic communities. The northward West Greenland current originates from the merging of North Atlantic waters and the Irminger current and carries warm and salty water masses along the Greenland west coast (Tang et al., 2004). On the other side and in the opposite direction, the colder

and fresher Baffin Island current flows outwards from the Canadian Archipelago, following Baffin Island shores. An east vs. west contrast in sea-ice freeze-up and melt timing is usually observed, with an early melt in the eastern region (Tang et al., 2004). As a result, the eastern and western sides of Baffin Bay have differing environments that extend northwards to the North Water, between Greenland and Ellesmere Island, where they shape distinct microbial and phytoplanktonic communities (Joli et al., 2018). This complex environment was sampled during the Green Edge project during the spring-to-summer transition. The *CCGS Amundsen* icebreaker sampled several east–west transects by following the sea-ice retreat. Simultaneously, a survey was performed at an ice camp site based on the west coast of Baffin Bay in order to catch the initial phases of the spring phytoplankton bloom. These efforts gathered large and diverse data sets that were used in the present study to build food web models integrating the three carbon pumps and representing the western and the eastern Baffin Bay.

This paper aims to elucidate how contrasting environments impact the internal flows of carbon, and how they influence, in turn, planktonic ecosystem functioning and carbon sequestration. To build complete food web models, we used linear inverse modelling (LIM) to estimate unmeasured flow values. The application of ecological network analysis (ENA – see Fath and Patten, 1998) provided emergent properties, which cannot be revealed otherwise from simple measurement (Fath et al., 2007). ENA is a powerful tool to reveal and discriminate the functioning of various ecosystems. The combination of both tools (LIM and ENA) revealed major differences in the functioning of both food webs, especially in the fate of carbon fixed by primary producers.

## Material and methods

### Study area

Baffin Bay is a semi-enclosed sea located at the southern edge of the Arctic Ocean system. It is oriented in the north–south direction with a length of about 1400 km and a maximum width of 553 km, bounded by Greenland in the east and Baffin Island in the west. A central abyssal basin deeper than 2300 m is surrounded by a wider continental shelf on its eastern side, compared to its western side. Baffin Bay acts as an important gateway to the North Atlantic. The large opening on the North Atlantic in the south through Davis Strait contrasts with the three narrow and shallow connections to the Arctic Ocean in the north (Jones Sound, Nares Strait and Lancaster Sound). Its northern end shelters the important North Water polynya, an ecologically productive area that remains mostly free of any sea-ice cover even in the midst of winter (Deming et al., 2002). Baffin Bay is a critical transition zone between both oceans where very different water masses coexist before mixing. The northward West Greenland current originates from the merging of North Atlantic waters and the Irminger current that carries warm and salty water masses along the west coast of Greenland (Tang et al., 2004). On the other side and in the opposite direction, colder and fresher outflows from the Canadian Archipelago follow the shores of Baffin Island.

Baffin Bay is ice-free in September, whereas melt begins as early as April along its Greenland side in the east. In July, more than one-half of the bay is already ice-free. Ice freeze-up starts in the northern open water in October and continues southwards until its maximal extent in March. The ice cover is always reduced in the eastern part of the Bay, due to the warmer West Greenland current. Interannual variations in sea ice extent are mainly due to winter atmospheric temperature (Tang et al., 2004; Barber et al., 2015).

### Food web linear inverse modeling

#### Principle

This study aimed at constructing the planktonic food web of each side of Baffin Bay in order to determine if the contrasting environments shaped different ecosystem structures and functioning. Both food webs were reconstructed by linear inverse modeling (Vézina and Platt, 1988). The inverse method assimilates all available in situ data as a linear equation and inequality to solve missing flow values. Unmeasured flows are estimated from the combination of three elements: i) the food web topology representing the map of flows, ii) the mass balances assuming a null sum of inflows (flows received by a compartment) and outflows (flows generated by a compartment), and iii) a set of biological parameters, including, for instance, primary production, respiration rates, and bacterial production, each of which is integrated into the model as a fixed value (referred to as an “equality” hereafter) or as a range of values (referred to as an “inequality” hereafter). The set of equalities and inequalities constitutes constraints that delimit a solution space randomly explored to propose a set of possible solutions that fulfill all constraints. The “mirror” algorithm described by Van den Meersche et al. (2009) and available in the R *limSolve* package as function *xsample*, randomly samples the solution space considering inequalities as reflecting planes, which ensures that proposed solutions are within the solution space. The entire coverage of the solution space is guaranteed by the choice of the jump length and the number of iterations. The convergence of solutions was checked visually as the achievement of the steady state of both the mean and standard deviation of flow values (Niquil et al., 2011). In our case, solution convergence was obtained for a jump equal to 20 mg C m<sup>-2</sup> and 20,000 iterations.

#### Model topology and constraints

Both Baffin Bay food web models represented trophic interactions and biological processes occurring within the euphotic zone during a summer period (June–July). All flows were expressed in g C m<sup>-2</sup> over the whole period considered. This section only describes how in situ data were integrated into the food web models, whereas methods used for field measurements are described briefly in the supplemental material (Text S1). The food web models were informed by data gathered during (i) an oceanographic campaign aboard the Canadian scientific icebreaker *Amundsen*, and (ii) an expedition on landfast ice off Qikiqtarjuaq in the spring–summer of 2016, both coordinated by the Green Edge Project ([www.greenedgeproject.info](http://www.greenedgeproject.info)). The oceanographic campaign surveyed seven

east–west transects across Baffin Bay over which a total of >200 stations were each sampled once. During the landfast-ice expedition, a single station where the ocean depth was nearly 400 m was sampled three times a week during more than three months. We focused on the data covering the period from 9 June to 9 July 2016 for both datasets. The oceanographic campaign data were split into two sets (**Figure 1**), one for the eastern and one for the western region of Baffin Bay, based on the proportion of Pacific Water found between 0 and 50 m in the bay, determined according to Bergeron and Tremblay (2014). The western side presented at least 25% of Pacific Water, whereas eastern Baffin Bay contained less than 20% of Pacific Water. The vertical profile of each biological variable considered in the model was integrated over the depth of the euphotic zone using the trapezoidal method and then multiplied by 30 to obtain a monthly estimate. The 5<sup>th</sup> and 95<sup>th</sup> percentile of each variable distribution, except net primary production (NPP), was used in the models as lower and upper limits. The landfast-ice data were integrated over the euphotic zone and then simply interpolated linearly on a daily basis and integrated over the monthly period considered. For NPP in equations, mean values of 14.210, 8.462, and 8.770 g C m<sup>-2</sup> month<sup>-1</sup> were used for phytoplankton (PHY) in the east, PHY in the west, and sea-ice algae (SIA) in the west, respectively. As previously mentioned, the ice camp data were relevant for the western Baffin Bay food web model only. The eastern food web model only integrated data from the oceanographic campaign. The list of model constraints is provided in **Table 1**.

#### Primary producers

Over the considered period (9 June to 9 July 2016), western Baffin Bay (WBB) was still ice-covered, whereas eastern Baffin Bay (EBB) was already free of sea ice. Thus, the WBB food web model considered two primary producers: sea-ice algae (SIA) and phytoplankton (PHY), and their associated production. This consideration was the only difference between model topologies.

In summer, despite the strong grazing pressure by zooplankton, a portion of the primary producers is assumed to sink. Using data from the sediment traps deployed at 25 m (drifting trap data and both drifting and short-term trap data in the east and in the west, respectively), the relative proportion of the stock of chlorophyll a (Chla) sinking to the bottom was calculated. Then this proportion was applied to the 5<sup>th</sup> and 95<sup>th</sup> percentiles of Chla concentration values found in the euphotic zone in each Baffin Bay region, thus effectively bounding phytoplankton sinking by lower and upper values. The sinking rate of sea-ice algae was estimated using data from long-term sediment traps deployed at 25 m, considering the diatom *Nitzschia frigida* as an indicator of the presence of sea-ice algae. The relative contribution of *N. frigida* to the pool of total diatoms in the drifting trap was used as minimal constraint of sea-ice algae sinking relative to phytoplankton sinking.

#### Bacteria

Bacterial production was assumed to be fully consumed over the summer period, thus no export to the following season was integrated into the model. Our model also

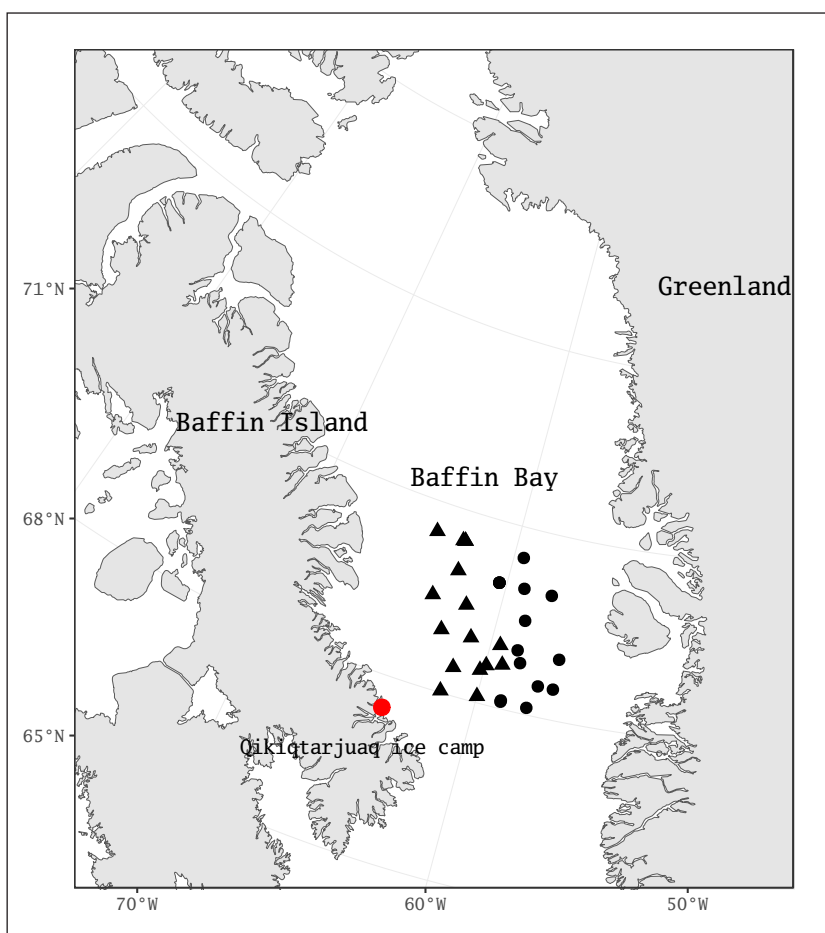

**Figure 1: Map of the sampling stations.** The red circle shows the location of the Qikiqtarjuaq ice camp, and the black circles and triangles indicate the location of stations in the eastern and western region of Baffin Bay, respectively, where data were collected during the cruise onboard the *CCGS Amundsen*. DOI: <https://doi.org/10.1525/elementa.397.f1>

**Table 1:** List of constraints applied to the food web models for inequalities. DOI: <https://doi.org/10.1525/elementa.397.t1>

Compartment	Process <sup>a</sup>	Min <sup>b</sup>	Max <sup>b</sup>	References	
Sea-ice algae (SIA)	Respiration	0.05*GPP <sup>c</sup>	0.3*GPP	Vézina and Platt (1988)	
	Exudation	0.08*GPP	0.82*GPP	Gosselin et al. (1997); Klein et al. (2002)	
	Grazing by <i>Calanus</i>	– <sup>d</sup> flow (siaT0omn)			Koski et al. (2017)
		– flow (phyT0cal)			Soreide et al. (2008)
	Sinking	0.02*flow (phyT0sed <sup>e</sup> )	–	This study	
Phytoplankton (PHY)	Respiration	0.05*GPP	0.3*GPP	Vézina and Platt (1988)	
	Exudation	0.08*GPP	0.82*GPP	Gosselin et al. (1997) Klein et al. (2002)	
	Sinking in west	0.02	0.467	This study	
	Sinking in east	0.11	0.586	This study	
Bacteria (BAC)	Production in west	0.149	0.334	This study	
	Production in east	0.175	0.865	This study	
	Bacterial growth efficiency in west (%)	na <sup>f</sup>	2.76	This study	
	Bacterial growth efficiency in east (%)	na	2.26	This study	

(Contd.)

Compartment	Process <sup>a</sup>	Min <sup>b</sup>	Max <sup>b</sup>	References
	Respiration	0.2*DOC Uptake	na	Vézina and Pace (1994)
	Respiration in west	na	26.6	Moloney and Field (1989) <sup>e</sup>
	Respiration in east	na	29.8	Moloney and Field (1989) <sup>e</sup>
	DOC uptake in west	na	55.6	Moloney and Field (1989) <sup>e</sup>
	DOC uptake in east	na	63	Moloney and Field (1989) <sup>e</sup>
	Viral lysis in west	0.007	–	This study
	Viral lysis in east	0.020	–	This study
	Flow(bacTDoc)	–	0.25*(bacTOres <sup>g</sup> ) + (bacTomic)	Suttle (1994, 2005)
Microzooplankton (MIC)	Assimilation	0.50*Ing <sup>h</sup>	0.9*Ing	Vézina and Platt (1988)
	Exudation	0.33*Res <sup>i</sup>	Res	Vézina and Platt (1988)
	Respiration	0.20*Ing	–	Vézina and Pace (1994)
	Production	0.10*Ing	0.4*Ing	Straile (1997)
	Production in west	0.028	na	Hirst and Bunker (2003) <sup>j</sup>
	Production in east	0.073	na	Hirst and Bunker (2003) <sup>j</sup>
	Respiration in west	na	9.07	Moloney and Field (1989)
	Respiration in east	na	11.9	Moloney and Field (1989)
	Consumption in west	na	40.58	Moloney and Field (1989)
	Consumption in east	na	53.7	Moloney and Field (1989)
Mesozooplankton (MES)	Assimilation	0.50*Ing	0.9*Ing	Daly (1997); Frangoulis et al. (2010)
	Exudation	0.33*Res	Res	Vézina and Platt (1988)
	Respiration	0.20*Ing	–	Vézina and Pace (1994)
	Production	0.10*Ing	0.4*Ing	Frangoulis et al. (2010); Straile (1997)
<i>Calanus</i> (CAL)	Respiration in west	1.72	3.48	Moloney and Field (1989)
	Respiration in east	1.19	3.53	Moloney and Field (1989)
	Consumption in west	7.72	15.6	Moloney and Field (1989)
	Consumption in east	5.34	15.9	Moloney and Field (1989)
	Production in west	3.95	na	Hirst and Bunker (2003)
	Production in east	3.55	na	Hirst and Bunker (2003)
	Reserve accumulation in west	2.46	3.81	Maps et al. (2014)
	Reserve accumulation in east	1.08	1.96	Maps et al. (2014)
Omnivorous mesozooplankton (OMN)	Respiration in west	2.86	3.84	Moloney and Field (1989)
	Respiration in east	0.75	17.5	Moloney and Field (1989)
	Consumption in west	5.41	31.2	Moloney and Field (1989)
	Consumption in east	3.35	78.8	Moloney and Field (1989)
	Production in west	1.69	na	Hirst and Bunker (2003)
	Production in east	0.51	na	Hirst and Bunker (2003)
Carnivorous mesozooplankton (CAR)	Respiration in west	0.44	1.73	Moloney and Field (1989)
	Respiration in east	0.24	0.84	Moloney and Field (1989)
	Consumption in west	1.99	7.78	Moloney and Field (1989)
	Consumption in east	1.03	3.72	Moloney and Field (1989)

(Contd.)

Compartment	Process <sup>a</sup>	Min <sup>b</sup>	Max <sup>b</sup>	References
Arctic cod larvae (BSL)	Respiration in west	na	0.003	Hop and Graham (1995)
	Respiration in east	na	0.002	Hop and Graham (1995); Hop et al. (1997)
	Consumption in west	na	0.034	Hop et al. (1997)
	Consumption in east	na	0.015	Hop et al. (1997)
	Production	0.30*Ing	0.70*Ing	Hop et al. (1997)
	Assimilation	0.50*Ing	0.90*Ing	Hop et al. (1997)
Particulate detritus (DET)	Sinking in west	0.20*Σ of Inf <sup>k</sup>	0.51*Σ of Inf	This study
	Sinking in east	0.32*Σ of Inf	0.79*Σ of Inf	This study
Dissolved detritus (DOC)	Export	flow (bacTODoc)	–	Jiao et al. (2011)

<sup>a</sup> All processes estimated from in situ data are expressed in g C m<sup>-2</sup> month<sup>-1</sup> except for bacterial growth efficiency expressed in %.

<sup>b</sup> Flows between compartments are written like flow (sourceTOSink).

<sup>c</sup> GPP = gross primary production.

<sup>d</sup> Hyphen = data not available.

<sup>e</sup> sed = sediments.

<sup>f</sup> na = data not applicable.

<sup>g</sup> calculated for the 95<sup>th</sup> percentile of abundance.

<sup>h</sup> Ing = ingestion.

<sup>i</sup> Res = respiration.

<sup>j</sup> only considering nauplii.

<sup>k</sup> Inf = inflows.

considered the production of dissolved organic carbon (DOC) by bacteria through two processes: i) viral lysis and ii) direct exudation. Viruses use cellular material of their host to support their own reproduction and in the end the host is lysed, releasing new viruses and host cellular material that enriches the DOC pool (Middelboe and Jorgensen, 2006). The main effect of the viral infection relevant to this study is the shunt of carbon from bacteria to higher trophic levels to the detritus pool (DET). To simplify the representation of this process in the model and avoid the explicit addition of a viral compartment, the viral infection was integrated into the model as a flow from the bacteria to DOC. During the Green Edge Project, the frequency of visibly infected cells (FVIC) was estimated to be equal to 1% of the bacterial biomass on average. From this estimate, the frequency of infected cells (FIC) was derived using the equation:

$$FIC = 9.524 FVIC - 3.256$$

described in Weinbauer et al. (2002). Then, virally induced bacterial mortality (VIBM; Binder, 1999) was estimated using:

$$VIBM = (FIC + 0.6 FIC2) / (1 - 1.2FIC).$$

As a result, the flow from bacteria to dissolved carbon was constrained by a lower limit equal to 7% of the minimal bacterial biomass observed in situ within the euphotic zone. The 5<sup>th</sup> percentile of abundance was converted into carbon considering the mean carbon content of 8.5 fg C per cell observed over the period. The maximal bacterial mortality by viral lysis was supposed to be less than the bacterivory by protists (Suttle, 1994, 2005). Moreover direct exudation by bacteria can represent up to 25% of bacterial respiration (Stoderegger and Herndl, 2001). Consequently,

the flow from bacteria to DOC was limited by the sum of maximal mortality due to viruses and maximal exudation.

#### Microzooplankton

This compartment grouped ciliates, heterotrophic flagellates, and copepod nauplii. The biomasses of ciliates and heterotrophic flagellates for each side of Baffin Bay were calculated from their mean abundance and carbon content. The latter was estimated for a specific biovolume range according to the following empirical relationship (Menden-Deuer and Lessard, 2000):

$$\text{Carbon content (in pg C cell}^{-1}\text{)} = 0.216 * (\text{Vol in } \mu\text{m}^3)^{0.939}.$$

Carbon content for each species of nauplii was determined according to the specific relationship between prosome length and carbon content (references in Bouchard et al., 2014). All were assumed to feed on phytoplankton, bacteria (Pomeroy, 1974; Turner, 2004), and detritus. As a part of their production was assumed to be consumed by predators not considered in the current model, we considered an export of carbon.

#### Mesozooplankton

Mesozooplankton included species that had at least one individual present at half of the stations sampled during the oceanographic campaign in each region of Baffin Bay (Table 2). Species known to stay deeper than 200-m depth were not considered. Furthermore, we assumed that all of the mesozooplankton biomass fed on carbon produced within the euphotic zone. Mesozooplankton species were grouped according to their diet and life-cycle traits. Thus, the *Calanus* genus deserved its own group,

**Table 2:** Species composing each mesozooplankton compartment and references used for determining carbon content. DOI: <https://doi.org/10.1525/elementa.397.t2>

Compartment	Species	References
Calanus	<i>Calanus finmarchicus</i>	Madsen et al., 2001
	<i>Calanus glacialis</i>	Forest et al., 2011
	<i>Calanus hyperboreus</i>	Forest et al., 2011
Omnivorous	<i>Boroecia maxima</i>	Appendix C in Mumm, 1991
	<i>Discoconchoecia elegans</i>	Appendix C in Mumm, 1991
	<i>Heterostylites major</i>	Appendix C in Mumm, 1991
	<i>Limacina helicina</i>	Hopcroft et al., 2005
	<i>Metridia longa</i>	Forest et al., 2011
	<i>Microcalanus</i>	Uye, 1982
	<i>Oithona similis</i>	Sabatini and Kiorboe, 1994
	<i>Oncaea notopus/parila</i>	Hopcroft et al., 2005
	Polychaete larva	Uye, 1982
	<i>Pseudocalanus spp.</i>	Liu and Hopcroft, 2008
	<i>Spinocalanus longicornis</i>	Uye, 1982
	<i>Triconia borealis</i>	Sabatini and Kiorboe, 1994
	Carnivorous	<i>Aglantha digitale</i>
<i>Eukrohnia hamata</i>		Hopcroft et al., 2005
<i>Gaetanus tenuispinus</i>		Appendix C in Mumm, 1991
<i>Heterorhabdus norvegicus</i>		Appendix C in Mumm, 1991
<i>Paraeuchaeta spp.</i>		Appendix C in Mumm, 1991
	<i>Themisto abyssorum</i>	Hopcroft et al., 2005

while the other species were split into omnivorous mesozooplankton and carnivorous mesozooplankton (Table 2). For each group, the mean abundance of each species was resolved at the developmental stage when applicable, for each region of Baffin Bay. Then ranges of biomasses (for each stage) were estimated through body length to carbon content relationships (Table 2) based on the minimal and maximal size ranges observed in situ.

*Calanus* species group together owing to their particular and similar life-cycle traits. These species are able to limit their metabolic costs in winter in order to survive their unfavorable surroundings (Hagen and Auel, 2001). They accumulate energy-rich compounds (lipids) that form up to 70% of their body mass (e.g., Falk-Petersen et al., 1990; Maps et al., 2014), which allows them to be auto-sufficient during the lean season. By this life trait, they transfer the carbon produced by primary producers during the short summer period to higher trophic levels during the rest of the year. The reserve accumulation in the models ranged between 70% of the minimal and maximal biomass of stages above copepodite IV. *Calanus* was assumed to feed on primary producers (i.e., phytoplankton and sea-ice algae; (e.g., Søreide et al., 2010), detritus and microzooplankton (Calbet and Saiz, 2005) including nauplii (Dufour et al., 2016). In contrast to the *Calanus* group, omnivorous and carnivorous mesozooplankton

feed all year around and do not accumulate significant reserves during summer (e.g., Blachowiak-Samolyk et al., 2007). Omnivores feed on primary producers, detritus, bacteria and protists (e.g., Stevens et al., 2004; Turner, 2004), whereas carnivores consume micro- and mesozooplankton (e.g., Blachowiak-Samolyk et al., 2007). The grazing on sea-ice algae by the *Calanus* group was considered to be lower than its grazing on phytoplankton (Søreide et al., 2008) and lower compared to the grazing by omnivorous mesozooplankton (Koski et al., 2017). For these three mesozooplankton groups, we considered an export of carbon corresponding to their production consumed by compartments not incorporated into the model.

#### Arctic cod larvae

Arctic cod (*Boreogadus saida*) larvae that correspond to the young-of-the-year feed on all micro- and mesozooplankton groups (Bouchard et al., 2014). Their production was totally exported in our model, because none of their predators was considered in it. An upper limit of respiration was estimated from experimental respiration rates under satiated feeding conditions (Hop and Graham, 1995). The experimental respiration rates were adapted to the weight of fishes measured in situ according to the empirical relationship given in the same paper. Maximal consumption was constrained using an allometric relationship defined



by Hop et al. (1997). Consumption was first converted to kilojoules using the mean energy content of prey consumed by the Arctic cod in the experiments of Hop et al. (1997), then converted to carbon using the conversion factor of 45.7 J mg C<sup>-1</sup> (Brey, 2001).

#### Detritus

Two groups of detritus, particulate detritus (DET) and DOC, were considered in the models. The sinking of particulate detritus was estimated as the difference between particulate organic carbon (POC) and Chl<sub>a</sub> (representing living POC) found in the sediment traps, using a C:Chl<sub>a</sub> conversion factor of 50. The relative proportion of the POC stock that sunk was applied to the sum of inflows to DET in order to constrain the flow from DET to sediment. The DOC produced by bacteria was considered as refractory (Jiao et al., 2010, 2011). To simulate this process, we considered that the DOC excreted by bacteria was exported.

#### Ecological network analysis

Once all the flow values were estimated, we performed a network analysis in order to characterize several attributes of the food web and describe the structure and functioning of both Baffin Bay food webs. Ecological network analysis (ENA) revealed emergent properties of the ecosystem via the analysis of the distribution of carbon throughout the various possible pathways. First, the activity of each compartment described by their total inflows assessed the importance of each compartment in the transfer of carbon. A compartment receiving a small amount of carbon contributes little to the transfer of carbon to higher trophic levels. Then, the contribution of each prey to the total inflows of each compartment was analyzed to detect possible differences in the diet composition of each compartment according to the east vs. west side of the Bay.

While the prey contribution to the diet of their predators involved only direct flow (i.e., length pathway equal to 1), a complementary approach considering both direct and indirect pathways (i.e., pathways longer than 2) describes the dependency of each compartment on one another (Szyrmer and Ulanowicz, 1987). This approach tracks the origin of carbon ingested by consumers. In order to determine the impact of the microbial food web on the carbon ingested by higher trophic levels, we focused only on the dependency on bacteria and on the direct bacterial consumers: microzooplankton and omnivorous mesozooplankton. These attributes of the food webs were calculated for the mean flow values by the R package NetIndices (Kones et al., 2009).

We further synthesized the information retrieved from our ensemble modeling approach by using the Lindeman aggregation routine to compute the carbon transfer between integer trophic levels. The Lindeman Spine projects the complex network into a linear food chain composed of discrete trophic levels. Nodes of the food web are apportioned into integer trophic levels according to their diet (Ulanowicz and Kemp, 1979). The spine represents the transfer of carbon received from the previous trophic level and from imports (if applicable), the loss of carbon both by respiration and exports. The cycle of detritus is also represented. The Lindeman routine was performed for the mean value of the 20,000 possible solutions for each flow by the R *enaR* package (Borrett and Lau, 2014).

Some ENA indices reveal the food web architecture (**Table 3**). Each index and its interpretation are presented in **Table 3**. This set of indices was calculated for the 20,000 sets of solution proposed by the *limSolve* R package in order to assess the uncertainty associated with each index. We used the *NetIndices* R-package (Kones et

**Table 3:** Ecological network analysis indices describing structure and functioning of the food web. DOI: <https://doi.org/10.1525/elementa.397.t3>

Index name	Abbreviation	Meaning	Reference
Total system throughput	T.	Activity of the entire food web; corresponds to the sum of all flows	Fath et al., 2013
Average mutual information	AMI	Specialization of flows; constraints imposed to a carbon atom; the higher the AMI, the more constrained and specialized the carbon in the food web	Ulanowicz, 1986
Ascendency	ASC	Organization of the system; represents efficient part of the food web	Ulanowicz, 1986, 1997
Relative Ascendency	A/C	Level of organization reached; the higher the A/C, the closer to the maximal ascendency level	Ulanowicz, 1986, 1997
Overhead	(none)	Reserves of the ecosystem limiting ASC; higher overheads associate with lower A/C; overheads have distinct origins: dissipation, export, or redundancy	Ulanowicz, 1986, 1997
Finn cycling index	FCI	Carbon recycling; quantity of carbon involved in a loop	Finn, 1976, 1980
Average path length	APL	Carbon retention; number of compartments visited by an atom of carbon between its entry and its exit	Kay et al., 1989
Compartmentalization	Cbar	Strength of subsystems; 0 indicating the inexistence of any subsystem and 1, a strong compartmentalization	Pimm and Lawton, 1980; Latham, 2006

al., 2009) based on the algorithm development by Latham et al. (2006).

Finally, we performed a utility analysis that determined the effects of the network on each pairwise relation. This approach assumes that a compartment is part of two environments: one that drives a given compartment and corresponds to flows received (inflows), and the other that is impacted by and thus refers to the flows originating from the compartment (outflows). Utility analysis captures both top-down (inflows) and bottom-up (outflows) processes (Patten, 1991, 1992). It highlights pairwise relations generated by direct interactions. Direct interactions refer to physical exchanges of carbon between two compartments. Utility analysis also considers the effects of indirect flows on pairwise relations. In this context, indirect flows correspond to interactions between compartments not connected physically, meaning separated by a length pathway equal or greater than 2 (Fath and Patten, 1998). We performed this utility analysis on the mean values of the flows with the R *enaR* package (Borrett and Lau, 2014).

### Results

Some differences in the activity of each compartment, defined as the sum of inflows to each compartment, were observed (Figure 2). The Arctic cod larvae showed the lowest activity in both food webs considered. Activities of some compartments were lower in the eastern food web while others presented higher activity, i.e., bacteria, DOC, phytoplankton and carnivorous mesozooplankton (see flow values in Table S1).

The differences in the activity of some compartments can be related to changes in the relative contribution of

the available resources (Figure 3). The western Baffin Bay food web had a supplemental resource (SIA) compared to that from eastern Baffin Bay. In both food webs, compartments fed on the same resources, but their relative contributions changed, except for Arctic cod larvae. Bacteria contributed a greater proportion of the diet of both the microzooplankton and omnivorous groups in the eastern Baffin Bay, which was associated with a decrease in the contribution of primary producers (Figure 3). The contribution of both DET and microzooplankton to the *Calanus* diet in eastern Baffin Bay was lower than in the west. Carnivorous mesozooplankton fed almost exclusively on *Calanus* in the eastern food web, whereas in western Baffin Bay *Calanus* comprised about 63% of their diet, with the remaining 37% being microzooplankton and omnivorous mesozooplankton (Figure 3). The sources of DOC and DET differed between both Baffin Bay regions. The main contributors to the DOC pool were the primary producers in both food webs, but their relative contribution was higher in the eastern part (48% versus 38%). Omnivorous mesozooplankton contributed 9% to the DOC inflows in the eastern Baffin Bay, while they represented 22% of the total inflows in the west (Figure 3). The contribution of bacteria and microzooplankton to the DOC inflows was higher in the western Baffin Bay compared to the eastern food web. *Calanus* and carnivorous mesozooplankton contributions remained similar in both food webs. The degradation of DET to DOC was six times higher in the eastern Baffin Bay than in the west. The contribution of carnivorous mesozooplankton to the DET pool was double in the eastern Baffin Bay, diminishing the contributions from microzooplankton and *Calanus*. The latter remained the main contributor of DET in both food webs.

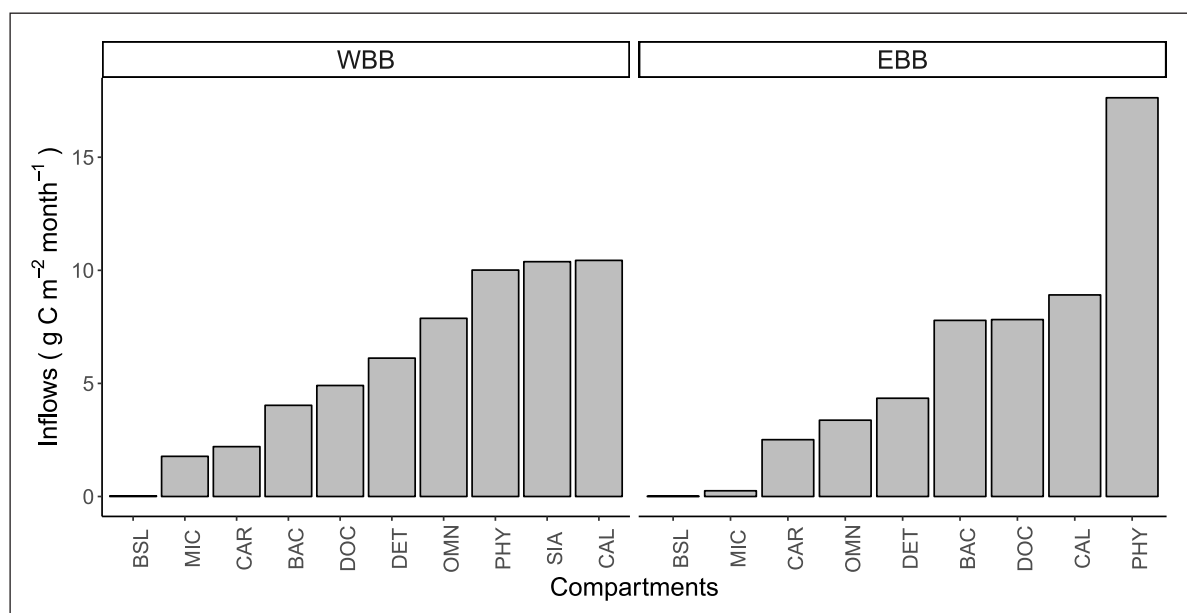

**Figure 2: Total inflows for each model compartment in both Baffin Bay food webs.** Total inflow was calculated as the sum of mean values of flows received by a compartment and expressed in  $\text{g C m}^{-2} \text{ month}^{-1}$  for western (WBB) and eastern (EBB) Baffin Bay. Compartments are bacteria (BAC), Arctic cod (*Boreogadus saida*) larvae (BSL), *Calanus* (CAL), carnivorous mesozooplankton (CAR), omnivorous mesozooplankton (OMN), microzooplankton (MIC), phytoplankton (PHY), dissolved organic carbon (DOC), detrital particulate carbon (DET), and, for WBB only, sea-ice algae (SIA). DOI: <https://doi.org/10.1525/elementa.397.f2>

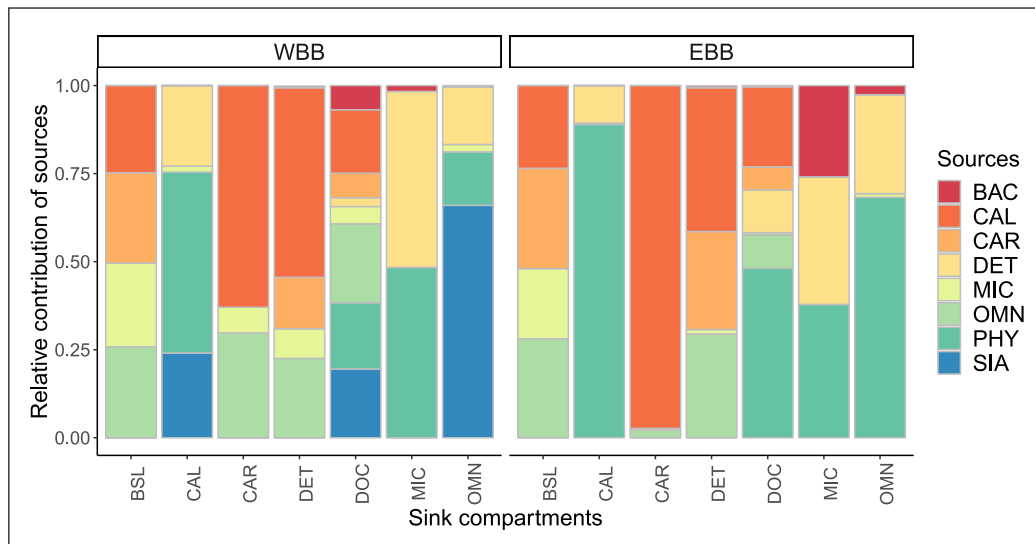
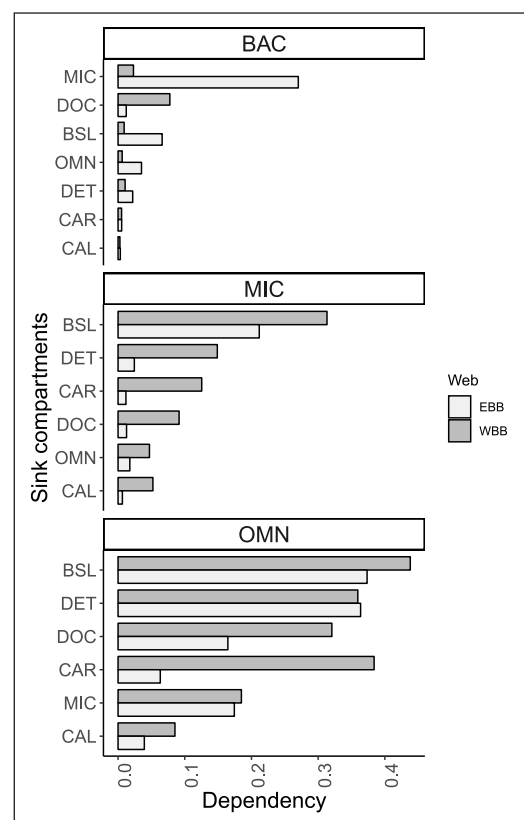

**Figure 3: Relative contribution of each carbon source to living and detrital compartments in both food webs.**

Sources and sink compartments for the western Baffin Bay (WBB) and eastern Baffin Bay (EBB) food webs are bacteria (BAC), Arctic cod larvae (BSL), *Calanus* (CAL), carnivorous mesozooplankton (CAR), omnivorous mesozooplankton (OMN), microzooplankton (MIC), phytoplankton (PHY), detrital particulate carbon (DET), and dissolved organic carbon (DOC). Sea-ice algae (SIA) were present only in WBB. DOI: <https://doi.org/10.1525/elementa.397.f3>

The relative contribution of the various sources to the diet/inflows of each compartment provides information on the direct flows between the components, whereas dependency considers both the direct and indirect flows (Figure 4). The dependency of consumers and non-living compartments on both bacteria and direct bacterial consumers was relatively low (less than 50%) for both food webs (Figure 4). The compartment most dependent on bacteria was the DOC in the western food web, whereas the microzooplankton compartment was most dependent on bacteria in the eastern food web. The most dependent on direct consumers of bacteria (microzooplankton and omnivorous mesozooplankton) were Arctic cod larvae in both regions of the Baffin Bay. However, a higher dependency on bacteria was observed in the eastern food web for Arctic cod larvae, microzooplankton, and omnivorous mesozooplankton. The dependency of other compartments on microzooplankton and omnivorous mesozooplankton was thus lower in the eastern food web.

The Lindeman Spine (Figure 5) summarizes the food web interactions using linear food chains containing integer trophic levels. The transfer efficiency at each trophic level decreased linearly in western Baffin Bay, whereas transfer efficiency increased at level IV in eastern Baffin Bay (Figure 5). The transfer efficiency of the primary producers (Level I) refers to the proportion of the total inflows to both Level I and DET that is transferred to the following level. The efficiency at this level was similar in both food webs, but the contribution of Level I compared to that of DET differed. Indeed, the grazing on primary producers was very close to the detritivory in eastern Baffin Bay and was associated with a higher loss of carbon fixed by primary producers to detritus ( $3.76 \text{ g C m}^{-2} \text{ month}^{-1}$  versus  $1.88 \text{ g C m}^{-2} \text{ month}^{-1}$ ). A lower loss to detritus ( $5.61 \text{ g C m}^{-2} \text{ month}^{-1}$  versus  $7.63 \text{ g C m}^{-2} \text{ month}^{-1}$ ) and lower exports ( $1.60 \text{ g C m}^{-2} \text{ month}^{-1}$  versus  $4.45 \text{ g C m}^{-2} \text{ month}^{-1}$ ) in eastern Baffin Bay led to



**Figure 4: Dependency of compartments on bacteria and direct consumers of bacteria in both food webs.**

The dependency for the eastern (EBB, light grey) and the western (WBB, dark grey) Baffin Bay food webs was calculated for the mean values of flows. Sink compartments are bacteria (BAC), Arctic cod larvae (BSL), *Calanus* (CAL), carnivorous mesozooplankton (CAR), omnivorous mesozooplankton (OMN), microzooplankton (MIC), dissolved organic carbon (D)C, and detrital particulate carbon (DET). DOI: <https://doi.org/10.1525/elementa.397.f4>

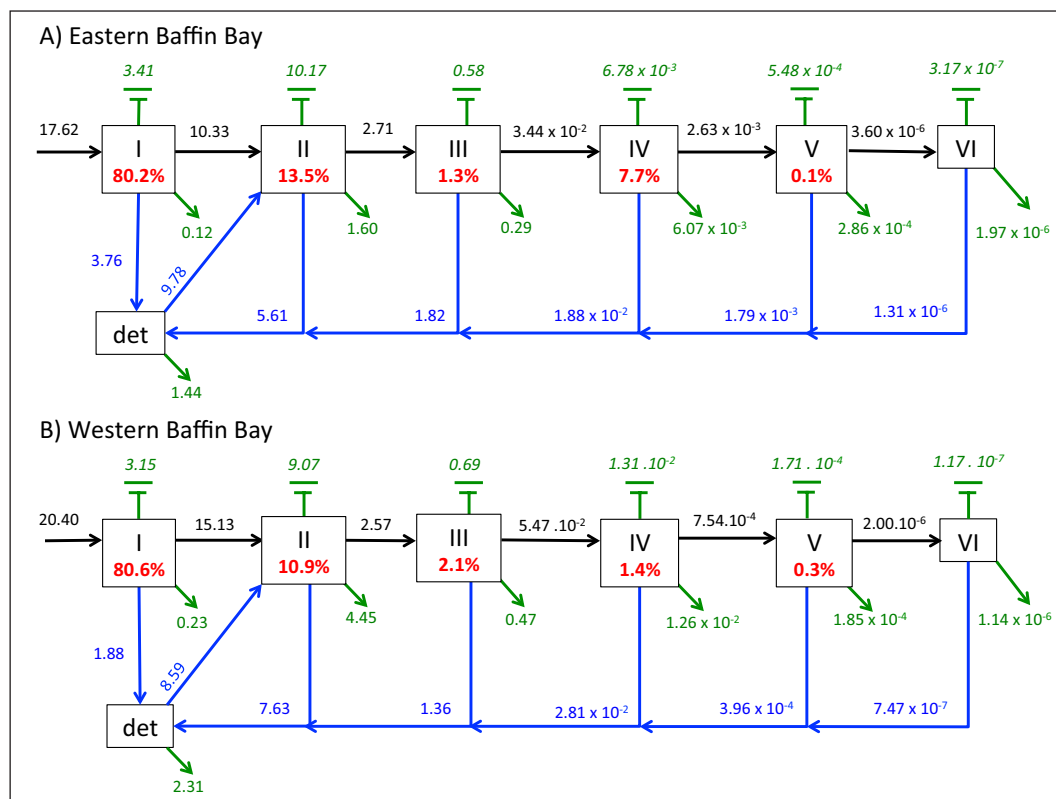

**Figure 5: Lindeman Spine of carbon transfer in both Baffin Bay food webs.** All values for **A)** eastern Baffin Bay and **B)** western Baffin Bay are in  $\text{g C m}^{-2} \text{ month}^{-1}$ . Green symbols represent loss at each integer level (arrows for export and ground symbol for respiration). Black and blue arrows refer to the grazing chain and the flows to/from detritus (det; i.e., particulate and dissolved), respectively. Transfer efficiencies corresponding to the proportion of inflows to one level that flows to the next level are given by bold red numbers at each trophic level. Food web components are distributed through the integer trophic levels according to their diets. Level I is composed of primary producers; level II represents bacteria, microzooplankton, *Calanus* and omnivorous mesozooplankton; level III refers to every zooplankton group and Arctic cod larvae; level IV excludes microzooplankton; and level V integrates carnivorous mesozooplankton and Arctic cod larvae, which is the lone constituent of level VI. DOI: <https://doi.org/10.1525/elementa.397.f5>

a higher transfer efficiency in Level II. The lower losses to detritus, respiration and export led to an approximate 6-fold greater transfer efficiency at Level IV in eastern Baffin Bay than that observed in western Baffin Bay. Higher exports from detritus were observed in the western food web.

The emergent properties revealing characteristics of the architecture of the entire food web showed some differences between the two regions of Baffin Bay. Despite the slightly higher specialization of flows (higher average mutual information, AMI; **Figure 6**), the ascendancy (**Table 3**) of the eastern food web was lower compared to the western food web due to the lower activity of the entire system (total system throughput, T.). However, the relative ascendancy (A/C; **Table 3**) was higher in eastern Baffin Bay (**Figure 7**). The inefficient/unorganized part of the system (1 minus A/C) was higher in the western food web. The uncertainty responsible for the inefficient/unorganized part of the system (overheads; **Table 3**) can originate from different sources. For both food webs, the uncertainty was dominated by the redundancy of internal flows (excluding respiration and export flows). The uncertainty associated with the dissipation and external overheads was higher in the western food web (**Figure 7**).

The Finn cycling index (FCI; **Table 3**) was low in both food webs considered (**Figure 6**). However, the western food web tended to present a higher FCI index value, ranging from 5 to 15%. The average path length (APL; **Table 3**) followed a different tendency, being slightly higher in the eastern food web (**Figure 6**). The compartmentalization index (Cbar), measuring the strength of the subsystems within the ecosystem, was higher in eastern Baffin Bay (**Figure 6**).

The direct relations were the same in both food webs, but the western food web included 10 additional relations owing to the presence of the supplementary compartment for sea-ice algae. The relations between the compartments (**Table 4**) differed when considering both direct and indirect flows. The neutralism (0,0) found only for direct relations changed in most instances to indirect mutualism (+,+), which is a beneficial relation for both compartments involved. Some direct predation relations (+,-) were pushed towards another kind of relation (mostly mutualism) when both direct and indirect flows were considered (integral columns in **Table 4**). This shift represented 26% and 14% of the predation relations for the eastern and western Baffin Bay food webs, respectively. Some of these transformations were similar

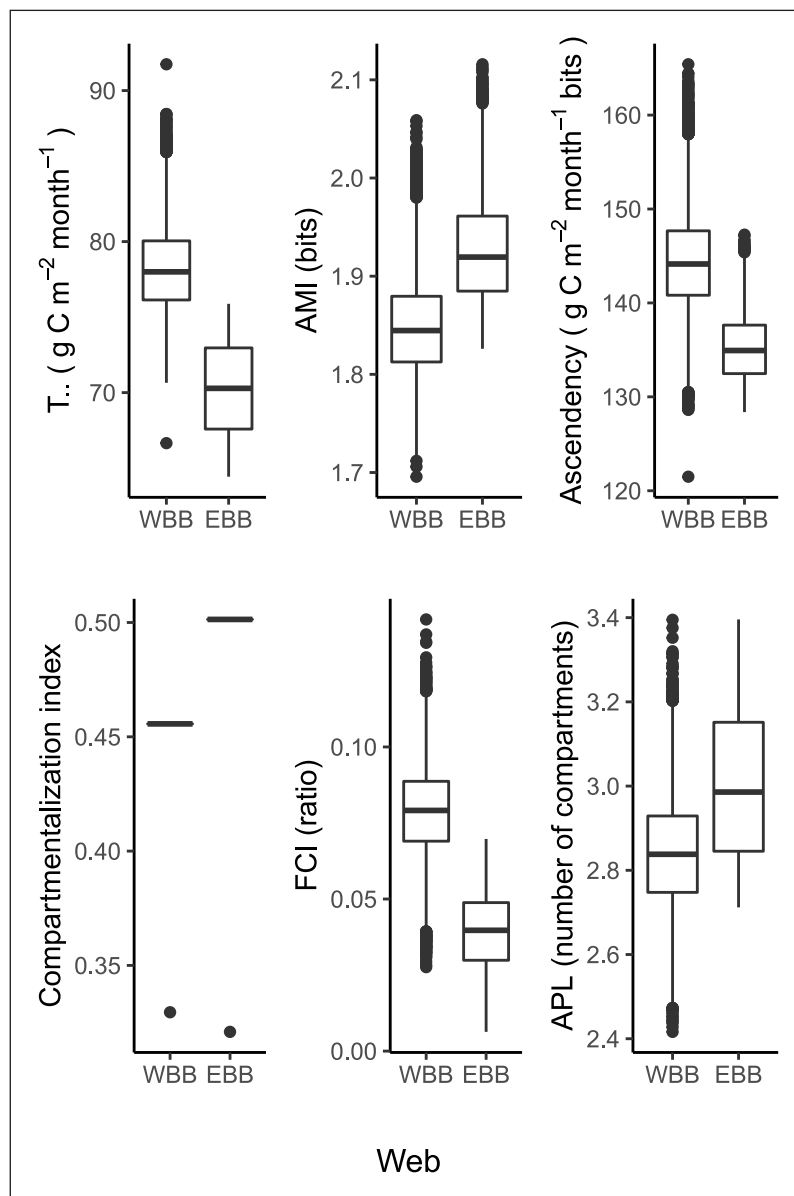

**Figure 6: Ecological network analysis indices describing the architecture of both Baffin Bay food webs.** For the food webs in both the eastern Baffin Bay (EBB) and western Baffin Bay (WBB), total throughput (T.), average mutual information (AMI), ascendancy, compartmentalization index, Finn cycling index (FCI), and average path length (APL) were calculated from the set of 20,000 random solutions calculated by LIM-MCMC. Box plots present five statistics: the median, corresponding to the horizontal line inside each box; the first and third percentiles as lower and upper boundaries of the box, respectively; and the values within 1.5 times the interquartile range above the 75% percentile or above the 25% percentile, shown as whiskers. Values outside this frame are represented individually as points along the vertical line. Note that the boxplot for the compartmentalization index presents only the median and one outside value. DOI: <https://doi.org/10.1525/elementa.397.f6>

in both food webs: mutualism for the relation between bacteria and omnivorous group (relation 23 in **Table 4**), and competition between microzooplankton and *Calanus* (relation 29 in **Table 4**). A few others were food web specific. For the eastern Baffin Bay food web, indirect mutualism appeared between microzooplankton and both carnivorous mesozooplankton and DOC (relations 31 and 34 in **Table 4**) and between bacteria and DET (relation 26). Indirect mutualism emerged between bacteria and microzooplankton (relation 21) and between omnivorous mesozooplankton and DET (relation 44) in the western

Baffin Bay food web. The network of the eastern region changed the direct exploitation of *Calanus* by both Arctic cod larvae and DET into indirect mutualism (relations 38 and 39 in **Table 4**). Moreover, the relation between omnivorous and carnivorous mesozooplankton completely flipped from predation to altruism in the eastern food web. The direct exploitation between sea-ice algae and both primary consumers and DOC was not affected by the network, whereas neutralism was changed into indirect mutualism (relations 3, 7, and 8), indirect competition (relation 2), predation (relation 9) or indirect altruism

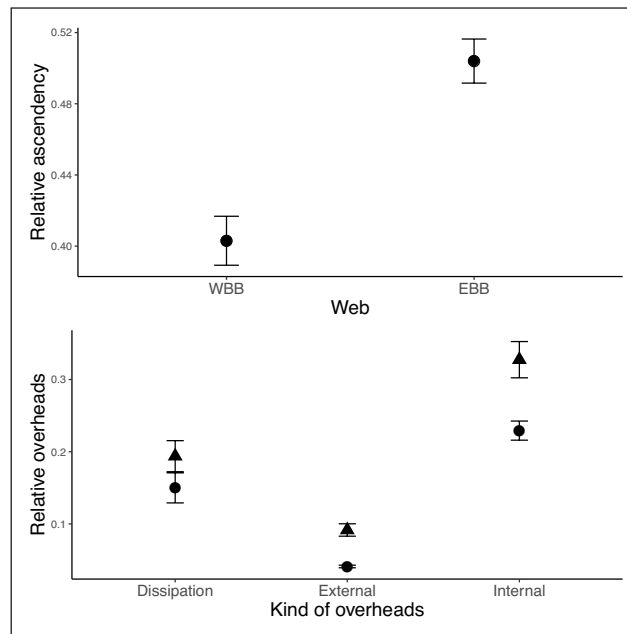

**Figure 7: Relative ascendancy and reserves associated with each kind of overheads for both food webs.** Relative ascendancy (upper panel) and relative reserves or overheads (lower panel) for both the western Baffin Bay (WBB) food web (triangles) and eastern Baffin Bay (EBB) food web (circles). Relative overheads correspond to overheads scaled by the maximal possible ascendancy. Each symbol represents the mean value with its standard deviation calculated from the set of 20,000 random flows solutions. DOI: <https://doi.org/10.1525/elementa.397.f7>

**Table 4:** Synthesis of pairwise relations within the eastern and western food webs. DOI: <https://doi.org/10.1525/elementa.397.t4>

Relation <sup>a</sup>	From <sup>b</sup>	To <sup>b</sup>	Direct	WBB-Integral <sup>c</sup>	EBB-Integral <sup>c</sup>
1	SIA	SIA	(0,0)	(+,+)	na <sup>d</sup>
2	SIA	PHY	(0,0)	(-,-) C*	na
3	SIA	BAC	(0,0)	(+,+) M*	na
4	SIA	MIC	(0,0)	(-,-) A*	na
5	SIA	CAL	(+,-)	(+,-)	na
6	SIA	OMN	(+,-)	(+,-)	na
7	SIA	CAR	(0,0)	(+,+) M*	na
8	SIA	BSL	(0,0)	(+,+) M*	na
9	SIA	DET	(0,0)	(+,-) P*	na
10	SIA	DOC	(+,-)	(+,-)	na
11	PHY	PHY	(0,0)	(+,+)	(+,+)
12	PHY	BAC	(0,0)	(+,+)*	(+,+)*
13	PHY	MIC	(+,-)	(+,-)	(+,-)
14	PHY	CAL	(+,-)	(+,-)	(+,-)
15	PHY	OMN	(+,-)	(+,-)	(+,-)
16	PHY	CAR	(0,0)	(+,+)*	(+,+)
17	PHY	BSL	(0,0)	(+,+)	(+,+)
18	PHY	DET	(0,0)	(+,-)	(+,-)
19	PHY	DOC	(+,-)	(+,-)	(+,-)
20	BAC	BAC	(0,0)	(+,+)	(+,+)

(Contd.)

Relation <sup>a</sup>	From <sup>b</sup>	To <sup>b</sup>	Direct	WBB-Integral <sup>c</sup>	EBB-Integral <sup>c</sup>
21	BAC	MIC	(+,-)	(+,+) M*	(+,-) P
22	BAC	CAL	(0,0)	(+,+)*	(+,+)*
23	BAC	OMN	(+,-)	(+,+)*	(+,+)*
24	BAC	CAR	(0,0)	(+,+)*	(+,+)*
25	BAC	BSL	(0,0)	(+,-) P*	(+,+) M*
26	BAC	DET	(+,-)	(+,-) P	(+,+) M*
27	BAC	DOC	(-,+)	(-,+)	(-,+)
28	MIC	MIC	(0,0)	(+,+)	(+,+)
29	MIC	CAL	(+,-)	(-,)*	(-,)*
30	MIC	OMN	(+,-)	(+,-)	(+,-)
31	MIC	CAR	(+,-)	(+,-) P	(+,+) M*
32	MIC	BSL	(+,-)	(+,-)	(+,-)
33	MIC	DET	(-,+)	(-,+)	(-,+)
34	MIC	DOC	(+,-)	(+,-) P	(+,+) M*
35	CAL	CAL	(0,0)	(+,+)	(+,+)
36	CAL	OMN	(0,0)	(-,)*	(-,)*
37	CAL	CAR	(+,-)	(+,-)	(+,-)
38	CAL	BSL	(+,-)	(+,-) P	(+,+) M*
39	CAL	DET	(+,-)	(+,-) P	(+,+) M*
40	CAL	DOC	(+,-)	(+,-)	(+,-)
41	OMN	OMN	(0,0)	(+,+)	(+,+)
42	OMN	CAR	(+,-)	(+,-) P	(-,+) A*
43	OMN	BSL	(+,-)	(+,-)	(+,-)
44	OMN	DET	(+,-)	(+,+) M*	(+,-) P
45	OMN	DOC	(+,-)	(+,-)	(+,-)
46	CAR	CAR	(0,0)	(+,+)	(+,+)
47	CAR	BSL	(+,-)	(+,-)	(+,-)
48	CAR	DET	(+,-)	(+,-)	(+,-)
49	CAR	DOC	(+,-)	(+,-)	(+,-)
50	BSL	BSL	(0,0)	(+,+)	(+,+)
51	BSL	DET	(+,-)	(+,-)	(+,-)
52	BSL	DOC	(0,0)	(-,)*	(-,)*
53	DET	DET	(0,0)	(+,+)	(+,+)
54	DET	DOC	(+,-)	(+,-)	(+,-)
55	DOC	DOC	(0,0)	(+,+)	(+,+)

<sup>a</sup> Pairwise relations were obtained by utility analysis.

<sup>b</sup> Abbreviations for compartments as in Table 1.

<sup>c</sup> Asterisks indicate direct relations that changed in western Baffin Bay (WBB) and eastern Baffin Bay (EBB) when both direct and indirect (integral) flows were considered; relations indicated are mutualism (M), predation (P), competition (C), and altruism (A).

<sup>d</sup> Not applicable (na), as sea-ice algae (SIA) were not present in eastern Baffin Bay.

(relation 4) (Table 4). In conclusion, the eastern food web showed a higher proportion of mutualism (about 46%) compared to the western food web (36%) at the expense of predation.

## Discussion

This study represents the first one to couple food web modeling and network analysis tools to analyze the distribution of carbon through the various pathways of a

trophic network (all values of flows in Table S1) in order to reveal the mechanisms structuring Arctic planktonic food webs and characterize the properties of carbon transfer within those food webs. Applying this approach to the contrasting environments of Baffin Bay revealed distinct features in the respective functioning of the eastern and western food webs that affect carbon sequestration through three carbon pumps: gravitational, lipid and microbial.

#### **Explanation of model results by field observations**

The difference in food web architecture and functioning in the eastern and western regions of Baffin Bay rested mainly on the distinct fate of primary production. In the eastern food web, twice as much carbon was released as exudate by primary producers, enriching the DOC pool (**Figure 5**). This higher exudation sustained the higher eastern bacterial production associated with the lower bacterial growth efficiency observed *in situ*. Some *in situ* observations in eastern Baffin Bay help to explain model outputs. First, at the time of sampling, the number of days of open water was higher in eastern than western Baffin Bay (Randelhoff et al., 2019). Therefore, the period of the phytoplankton bloom captured was not the same; in the east the bloom was more advanced than in the west where it has just begun. As observed during the post-bloom phase, the simulated eastern food web showed high exudation by phytoplankton, due to nutrient stress (Gosselin et al., 1997; Fragoso et al., 2016) associated with higher bacterial production (Nielsen and Hansen, 1995). On the other hand, the comparison of POC export, which was similar between regions excluding the sinking of sea-ice algae, suggests that the eastern food web was in a transitional state. The community composition was changing from diatoms, understood to be the main player in POC fluxes (Boyd and Newton, 1999), to *Phaeocystis pouchetii* (mean abundance  $2.8 \cdot 10^6$  cell L<sup>-1</sup> versus  $4.5 \cdot 10^5$  cell L<sup>-1</sup> for the eastern and western food webs, respectively), which form large colonies that do not sink systematically as their sinking depends on physical characteristics of the surrounding environment (Wassmann, 1994). This species is well known to exude a large amount of dissolved organic matter at each stage of its growth (Alderkamp et al., 2007) as well as transparent exopolymer particles (Engel et al., 2017). Furthermore, despite some controversies regarding the grazing of *Phaeocystis* by copepods (Schoemann et al., 2005), large *Calanus spp.* can feed on *P. pouchetii* colonies (Estep et al., 1990; Søreide et al., 2008), while smaller copepods cannot (Nejstgaard et al., 2007). Being even smaller, copepod nauplii and microzooplankton cannot feed on these colonies (Irigoien et al., 2003), but they can ingest free-living cells as *Phaeocystis* colonies break down (Dutz and Koski, 2006; Nejstgaard et al., 2007). The presence of *Phaeocystis pouchetii* in the eastern region of Baffin Bay could explain the model-simulated difference in the fate of primary production; i.e., twice as much exudate, ingestion mainly by *Calanus spp.*, and only a limited quantity of carbon flowing to microzooplankton and omnivorous mesozooplankton.

#### **Phenological connection or spatial decoupling?**

The eastern and western Baffin Bay food web models simulate two distinct phases of the phytoplankton bloom. We thus consider whether the differences observed in food web structure and functioning can be attributed to bloom phenology instead of the contrasting spatial environments, as originally posed, by focusing on the probability of *Phaeocystis pouchetii* developing in the western part of the bay. First, colonies of *P. pouchetii* have been observed previously in the Arctic (Vogt et al., 2012), in the subarctic Labrador Sea (Fragoso et al., 2016), in the Barents Sea (Schoemann et al., 2005), and in Disko Bay on the western coast of Greenland (i.e., eastern Baffin Bay, Thøisen et al., 2015), but they have not been observed in western Baffin Bay. Because the temperature niches of *P. pouchetii* and diatoms are clearly distinct (Brun et al., 2015) and the extent of *P. pouchetii* blooms is associated with northward advection of Atlantic water into the Arctic (Engel et al., 2017), the observation of *P. pouchetii* blooms in western Baffin Bay under the influence of colder Pacific/Arctic waters is unlikely. Second, both regions of the Bay differed by the reconstituted winter stock of nutrients and ratio of elements, which influence the abundance of *Phaeocystis* and diatoms (Jiang et al., 2014). Eastern Baffin Bay was dominated by Atlantic water with a nitrate stock of about  $10 \mu\text{mol L}^{-1}$ , while the nitrate concentration in the west reached only  $5 \mu\text{mol L}^{-1}$  (Randelhoff et al., 2019). An opposite trend was observed for both phosphate and silicate, with deficits in the Atlantic water masses. Because the nutrient winter stock was depleted in silicate in the east, diatom growth was limited, leading to development of *P. pouchetii* colonies in this relatively warm water. The depletion of silicate is not necessary for *Phaeocystis* blooms, however, as *P. pouchetii* can dominate or co-dominate in cases where silicate is not limiting. Jiang et al. (2014) showed that a high, pre-bloom nitrate concentration can give the slower growing *P. pouchetii* enough time to develop before diatoms deplete the nitrate. In contrast, a more nitrate-limited environment, such as western Baffin Bay, favors diatom growth. Moreover, *Phaeocystis*, which has a higher ammonium uptake capacity, outcompetes diatoms in a rich ammonium environment (Tungaraza et al., 2003). Eastern Baffin Bay with its higher concentration of ammonium in summer compared to western Baffin Bay (Varela et al., 2013) would thus favor the *P. pouchetii* bloom. Based on these arguments and observations, the probability of the functioning of the western food web evolving towards the eastern food web seems very low.

#### **Contrasting eastern and western Baffin Bay food webs**

The carbon fixed by primary producers in the eastern and western regions of Baffin Bay was distributed very differently throughout the pathways of the two trophic networks. More than 25% of the eastern net production (i.e.,  $3.76 \text{ g C m}^{-2} \text{ month}^{-1}$ ; **Figure 5**) was transferred to the DOC pool to which it contributed 48% (**Figure 3**). In the contrasting western food web, the exudation of DOC by primary producers represented only 10% of the primary production and contributed to the DOC pool in lower proportion (36%; **Figure 3**). The rest of the primary



production was distributed between *Calanus*, microzooplankton, and omnivorous mesozooplankton in the west, whereas it was almost totally transferred to the sole *Calanus* compartment in eastern Baffin Bay. As a result, the activity of microzooplankton and omnivorous mesozooplankton was lower (**Figure 2**) in the eastern food web, where microzooplankton diets were more sustained by bacteria and omnivores by both bacteria and DET. This well-defined microbial loop was confirmed by the much higher dependency on bacteria observed in the eastern region (**Figure 4**) and the higher transfer efficiency between levels II and III (**Figure 5**). Interestingly, we could also trace a higher dependency on bacteria up to the Arctic cod larvae level, which suggests that a significant fraction of the carbon ingested by Arctic cod larvae had transited through the bacteria compartment in eastern Baffin Bay. Conversely, the overall lower dependency of higher level predators on microzooplankton led to a higher compartmentalization of the eastern food web (**Figure 6**), characterized by a relative dissociation of the microbial food web from the classical food chain of phytoplankton to *Calanus spp.* to carnivorous organisms.

The major difference in the distribution of primary production in the eastern and western regions led to a higher specialization of trophic pathways in the eastern food web. The flow of carbon was more constrained through specific pathways, thus minimizing the losses caused by the dispersion of carbon through multiple parallel pathways, considered as redundant. In this case, direct trophic pathways linking a predator with its main prey were preferred (for example, *Calanus spp.* with phytoplankton, and carnivorous mesozooplankton with *Calanus spp.*; **Figure 3**), and accessory prey were neglected favoring higher transfer efficiency. The observed higher relative ascendancy value showed that the eastern Baffin Bay reached a higher level of both organization and efficiency compared to the western food web (**Figure 7A**). Indeed, eastern primary production was channeled towards dissolved carbon and *Calanus* in order to support the large needs of *Calanus* and bacteria. The other compartments fed on the latter two according to their preferences, leading to the channeling of carbon through some dominant pathways and thus to an increase of the organization and transfer efficiency within the system.

Some required components of food webs reduce ascendancy and constitute the reserves of the system (overheads; **Figure 7B**), bringing flexibility to it. These reserves have several origins and are invested within the following processes: export, dissipation and redundancy of trophic pathways. The proportions of redundancy and overhead due to both dissipation and export were higher in the western Baffin Bay, which also experienced a loss of information corresponding to these flows. This loss implies that the food web is not getting the full benefit from the carbon before it is being released by dissipation or export. Indeed, the flow values confirm that the higher activity of western compartments (**Figure 2**) associated with a lower transfer efficiency, compared to the east (i.e., the logarithmic mean of transfer efficiencies at each level, corresponding to red numbers in **Figure 5**,

was 4.7 in the west versus 5.6 in the east), led to a higher proportion of carbon leaving the system. This effect was observed especially at level II (composed mainly of bacteria and herbivorous micro- and mesozooplankton) for which export was about three times higher in the western food web (**Figure 5**). At this level of the trophic network, exports refer to the production available for predators not considered in this model, as well as to the lipid storage accumulated by *Calanus*, which is a very particular feature of Arctic marine ecosystems. From this point of view, western Baffin Bay seemed to act according to the classical view of Arctic marine ecosystems which are sustained by the large lipid reserves of *Calanus* and transfer carbon efficiently towards higher trophic levels like fish and marine mammals (not considered in the models). The higher redundancy in the organization of the western trophic network also indicates that carbon flowed through alternate trophic pathways that favored omnivory, as a consumer can feed on the same prey directly and indirectly (Williams and Martinez, 2004). For example, *Calanus* fed directly on phytoplankton, while a second pathway indirectly linked *Calanus* to phytoplankton via the microzooplankton.

#### Interactions between trophic groups

In a network, species interact with each other in various ways: directly by trophic exchange between a prey and its predator, but also indirectly through at least one more compartment to mediate the transfer of carbon (Wootton, 1994). As the indirect effects are often dominant in an ecological network (Higashi and Patten, 1986, 1989), they affect the nature of direct relations between species (Ulanowicz and Puccia, 1990; Bondavalli and Ulanowicz, 1999). For instance, due to the effect of indirect flows, a predator could be beneficial for its prey if it feeds on other predators of this prey (e.g., Bondavalli and Ulanowicz, 1999).

In both Baffin Bay food webs, the network affected similarly the nature of most direct pairwise relations. Direct neutralism (0,0) (i.e., no direct relation between compartments) or direct predation was transformed into indirect mutualism (mutually beneficial pairwise relations) most of the time. Thus, positive relations became dominant when the direct and indirect interactions were considered, as usually emerges in ecological networks (Fath and Patten, 1998). Indirect mutualism can occur via various processes (Wootton, 1994); we identified at least two kinds of indirect mutualism. The first derived from the trophic cascade that involved consumer-resource interactions: the sink compartment in the relation (e.g., carnivorous zooplankton) benefits from the source compartment (e.g., phytoplankton) as it feeds indirectly on it, while feeding directly on the predators of the source compartment, in turn limiting the predation pressure and being beneficial for the source compartment. The same mechanism was identified for pairwise relations between primary producers or bacteria with trophic levels higher than *Calanus* (relations 7, 8, 16, 17, 22–24 in **Table 4**). The second indirect mutualism involved apparent competition mediated by a common predator, like phytoplankton/sea-ice algae and bacteria pairwise relations. In this case, the primary

producers exuded DOC that was mandatory for bacterial growth and bacteria were an alternative resource for grazers. Moreover, some direct relations were changed into either i) indirect exploitative competition when the compartments involved in the relation exploited the same resources (Wootton, 1994), as Arctic cod larvae and DOC (relation 52 in **Table 4**), which exploited micro- and mesozooplankton or ii) apparent competition characterized by a common predator (Wootton, 1994). In the latter, a species impacts another one through its influence on the abundance of their shared predator (Stige et al., 2018). These two kinds of competition are not always easily distinguished. For example, in this study the indirect competition between *Calanus* and omnivorous mesozooplankton, as well as between microzooplankton and *Calanus*, can be due to the sharing of either a common predator (carnivorous mesozooplankton or Arctic cod larvae) or the same resource (phytoplankton and microzooplankton or phytoplankton alone, respectively). In this case, further studies could reveal which of the top-down or bottom-up effects dominated and led to an indirect competition. One approach could consider the network motifs (e.g., Holt et al., 1994; Holt and Polis, 1997; Baiser et al., 2016; Klaise and Johnson, 2017), but the challenge is to do so in the context of the overall network such that indirect interactions are included. Both networks considered in this study obeyed the same processes and thus led to similar pairwise relations in the majority of cases.

Differences observed in food web functioning in both Baffin Bay regions were associated with changes in nine pairwise relations that almost all concerned the compartments directly involved in the microbial loop, e.g., DET, bacteria, microzooplankton and omnivorous mesozooplankton. The relations between omnivorous and carnivorous mesozooplankton were opposite between both food webs: beneficial for the carnivores, as expected, in the western food web, while omnivores exploited carnivores in the eastern food web (relation 43 in **Table 4**). As carnivores contributed in higher proportion (**Figure 3**) to the detritus that was in turn consumed in higher proportion by omnivores, the carnivores became more beneficial than detrimental for omnivores in the eastern Baffin Bay. The stimulation of the microbial loop in the eastern region caused indirect mutualism between microzooplankton and DOC and between bacteria and Arctic cod due to the higher dependency of microzooplankton on bacteria (**Figure 4**) and the consumption of this main bacterial predator by Arctic cod larvae, respectively. Moreover, changes in the origin of detritus were involved, with higher contribution of carnivores to DET at the expense of *Calanus* contribution causing indirect mutualism between carnivores and microzooplankton as well as between *Calanus* and DET. Finally, higher degradation of DET to DOC led to indirect mutualism between bacteria and DET in the eastern region. These differences led to more indirect mutualistic relations at the expense of predation in the eastern food web. Such differences observed in the nature of pairwise relations could affect the dynamics of each food web, as well as their responses to environmental perturbations.

Describing and understanding interactions between species are key elements in determining the dynamics and fate of an ecosystem confronted with environmental perturbation such as invasion, climate change, or extinction. Indeed, extinctions rapidly affect ecosystem functions and can be involved in later species extinction (Valiente-Banuet et al., 2015). Because of the dominating nature of indirect interactions (Higashi and Patten, 1986, 1989), using an ecosystem approach that includes the entire food web is critical. This whole system approach can determine the crucial role of species in the response to perturbations (Wootton, 2002). Moreover, the nature of the indirect interaction affects the behavior of the ecosystem (Schmitz et al., 2004). The dominance of indirect mutualism over competition decreases the risk of secondary extinction (Vandermeer, 2004). Finally, interaction strengths also have an impact on the coexistence of species (Borrett et al., 2010). A combination of strong and weak interactions dampens resource-predator oscillations and thus insures the stability of the ecosystem (McCann et al., 1998; McCann, 2000). In the case of eastern and western Baffin Bay, the differences observed in the integral relations (direct and indirect) let us assume that each region will have a distinct fate in the face of climate change. How each region of the bay will evolve and which region presents the most robust network remain open questions.

#### **Insights on the carbon cycle in the Baffin Bay**

Trophic network organization and functioning play a role in the biogeochemistry of Arctic marine ecosystems. Our network analysis revealed key information on the behavior of the biological pump, especially on carbon cycling within the food web. In the network analysis framework, cycling refers to the quantity of organic carbon involved in loops. Recycling values of less than 15% in both regions of Baffin Bay were low compared to the value of 25% estimated by network analysis for spring–summer in the Amundsen Gulf (Saint-Béat et al., 2018). Bacteria play a major role in carbon cycling (Johnson et al., 2009), and bacterial processes greatly impact the values of recycling estimated by the Finn cycling index (Saint-Béat et al., 2018). Thus, the overall low bacterial production and low growth efficiency (<2.5%) observed in Baffin Bay contributed to the low recycling. The low growth efficiency meant re-mineralization of a considerable proportion of the DOC uptake that could not be used for the synthesis of particulate bacterial carbon and thus was considered a loss to the food web. Detritivory by zooplankton also plays a significant role in carbon cycling, and clear differences were observed between the two regions. In the eastern food web, 70% of the detrital carbon was transferred to bacteria as DOC, with only 17% consumed by zooplankton, whereas 40% of the detrital pool was transferred to zooplankton in the western food web. The higher detritivory contributed to the higher carbon recycling observed in the western food web, as revealed by the higher FCI values (**Figure 6**).

The origin of the detritus shed new light on the length of loops in the food webs (i.e., number of compartments involved), and regional differences occurred in the origin

of the detrital pools. In western Baffin Bay, about 90% of the detritus consumed by level II (e.g., bacteria, *Calanus*, microzooplankton and omnivorous mesozooplankton) appeared to be returned to the detrital pool (**Figure 3**; higher flow from level II to detritus in **Figure 5**), while in the east only about one half returned to detritus. This difference suggested shorter cycles in western Baffin Bay, which was confirmed by the slightly lower value of APL, an measure that provides complementary information on the retention of carbon within the system. Generally, the APL value has the same tendency as the FCI index, and thus higher APL is expected in a system with high recycling (Baird et al., 1991). This tendency was not the case in Baffin Bay. The larger proportion of recycled carbon observed in western Baffin Bay was consumed less by the higher trophic levels (i.e., higher FCI, lower APL) and confirmed the presence of shorter cycles. In contrast, the low quantity of recycled carbon in the east was transferred up to Arctic cod larvae due to higher bacterivory by micro- and omnivorous mesozooplankton, as shown by the higher dependency of these compartments on bacteria (**Figure 4**) and the greater transfer efficiency at level IV (**Figure 5**).

Organic carbon can leave the food web by two processes: dissipation and export. In both food webs, carbon mainly exited by dissipation as confirmed by the higher dissipative overheads (**Figure 7**). More carbon was exported out of the western Baffin Bay food web (**Figure 7**) and constituted 37% of the carbon exit from this system, whereas carbon export represented only 19% in the eastern food web. In the food web models, exports referred to several biological processes: i) sinking of both primary producers and particulate detritus (DET), ii) accumulation of reserves by *Calanus* to deal with the winter season, iii) the generation of refractory DOC by bacteria, and iv) consumption of carbon by higher trophic levels not considered in these models. From a biogeochemical point of view, these exports do not have the same respective impacts on the carbon cycle. In the last case, carbon exported towards higher trophic levels not considered in the model remains within the euphotic zone where it could be re-mineralized. The three other processes are involved in the possible sequestration of carbon. As a result, in terms of biogeochemical cycles, the western food web exported twice as much carbon out of the euphotic zone as the eastern food web. Even though the sinking of phytoplankton and DET was similar, the presence of sea-ice algae and their sinking stimulated the gravitational pump, as shown in other studies (Lalande et al., 2013). The microbial and lipid pump were more active in the western food web, being twelve times and two times higher, respectively, compared to the east. These results show that a consideration of the coupling of the three pumps involving planktonic components is essential to developing a more realistic view of potential carbon sequestration. As a consequence, the in situ quantification of lipid storage by *Calanus* spp. and DOC production by bacteria, via viral lysis and exudation, and the regulation of these biological processes by environmental factors, represent important challenges for future research.

## Conclusion

The combination of ecological tools applied in this study revealed the impact of contrasting environments on the functioning of planktonic Arctic food webs. The western and eastern Baffin Bay under Arctic and Atlantic influence, respectively, showed a distinct summer food web functioning. Eastern primary production was more exudative and supported a stimulated microbial loop. The rest of the carbon fixed by primary producers was transferred efficiently through the grazing chain via *Calanus* spp. In the western food web, primary production was consumed evenly by the different grazers, which were the main contributors to the DOC pool. The architecture of the food webs differed, leading to two distinct biogeochemical functionings. In the eastern region, carbon flowed through a more complex network (higher relative ascendancy) that favored direct transfer and the segregation of the microbial loop. This network channeled carbon throughout longer trophic pathways, revealing stimulation of the microbial loop and an efficient transfer towards the highest trophic levels, associated with a direct, classical grazing chain. In contrast, in the west, organic carbon flowed through short and redundant pathways and was more actively exported through both the lipid and microbial pumps. Moreover the distinct food web architecture was coupled to the change of some pairwise relations considering both direct and indirect pathways, leading to more mutualism in the eastern food web. All of these elements suggest distinct ecosystem dynamics and responses to ongoing and expected climate change in the Arctic Ocean. Models covering a longer temporal scale (seasonal or yearly) need to be developed, however, to further explore the stability properties and response of these food webs under both very strong anthropogenic and climatic pressures.

## Data accessibility statement

All data are available at <https://doi.org/10.17882/59892> (Massicotte et al., 2019).

## Supplemental files

The supplemental files for this article can be found as follows:

- **Text S1.** Protocols for in situ measurements to obtain the data used in the Baffin Bay food web models. DOI: <https://doi.org/10.1525/elementa.397.s1>
- **Table S1.** Values of flows (mean and 90% confidence intervals) in  $\text{g C m}^{-2} \text{ month}^{-1}$ . DOI: <https://doi.org/10.1525/elementa.397.s2>

## Acknowledgements

The Green Edge ice camp would not have been possible without the support of the Hamlet of Qikiqtarjuaq and the members of the community as well as the Inuksuit School and its Principal, Jacqueline Arseneault. We wish to thank officers and crew of *CCGS Amundsen*. The project is conducted under the scientific coordination of the Canada Excellence Research Chair on Remote Sensing of Canada's new Arctic Frontier and the CNRS and Université Laval Takuvik Joint International Laboratory (UMI3376). The

field campaign was successful thanks to the contributions of J. Ferland, G. Bécu, C. Marec, J. Lagunas, F. Bruyant, J. Larivière, E. Rehm, S. Lambert-Girard, C. Aubry, C. Lalande, A. LeBaron, C. Marty, J. Sansoulet, D. Christiansen-Stowe, A. Wells, M. Benoît-Gagné, E. Devred and M.-H. Forget from the Takuvik laboratory, C.J. Mundy and V. Galindo from University of Manitoba, J. Bourdon and M. Picheral from CNRS, and F. Pinczon du Sel and E. Brossier from Vagabond. We also thank Michel Gosselin, Québec-Océan and the Polar Continental Shelf Program for their in-kind contribution in terms of polar logistics and scientific equipment.

### Funding information

The Green Edge project is funded by the following French and Canadian programs and agencies: ANR (Contract #111112), ArcticNet, CERC on Remote sensing of Canada's new Arctic frontier, CNES (project #131425), French Arctic Initiative, Fondation Total, CSA, LEFE and IPEV (project #1164). The sea campaign was conducted using the Canadian research icebreaker *CCGS Amundsen* with the support of the Amundsen Science program funded by the Canada Foundation for Innovation (CFI) Major Science Initiatives (MSI) Fund. BSB benefited from a postdoctoral fellowship funded by Sentinelle Nord, a Canada First Research Excellence grant awarded to Université Laval, the Canada Excellence Research Chair on Remote Sensing of Canada's new Arctic Frontier led by MB and an NSERC Discovery Grant (05433-2014) awarded to FM.

### Competing interests

The authors have no competing interests to declare.

### Authors contributions

BSB, FM and MB designed the study. CA, JC, JD, LF, VG, PLG, FJ, CL, ML, PR, TSN, JET and DV contributed to the acquisition and curation of the original data collected during the international Green Edge project. BSB assembled the data and performed the numerical modelling. BSB analysed the output with significant contribution from BDF. BSB led the drafting of the manuscript. All co-authors contributed substantially to the discussion of the results and the preparation of the submitted manuscript.

### References

- Alderkamp, A-C, Buma, AG and van Rijssel, M.** 2007. The carbohydrates of *Phaeocystis* and their degradation in the microbial food web. *Biogeochemistry* **83**(1–3): 99–118. DOI: <https://doi.org/10.1007/s10533-007-9078-2>
- Auel, H and Hagen, W.** 2002. Mesozooplankton community structure, abundance and biomass in the central Arctic Ocean. *Mar Biol* **140**(5): 1013–1021. DOI: <https://doi.org/10.1007/s00227-001-0775-4>
- Baird, D, McGlade, JM and Ulanowicz, RE.** 1991. The comparative ecology of six marine ecosystems. *Philos T Roy Soc B* **333**(1266): 15–29. DOI: <https://doi.org/10.1098/rstb.1991.0058>
- Baiser, B, Elhesha, R and Kahveci, T.** 2016. Motifs in the assembly of food web networks. *Oikos* **125**(4): 480–491. DOI: <https://doi.org/10.1111/oik.02532>
- Barber, DG, Hop, H, Mundy, CJ, Else, B, Dmitrenko, IA, Tremblay, J-E, Ehn, JK, Assmy, P, Daase, M and Candlish, LM.** 2015. Selected physical, biological and biogeochemical implications of a rapidly changing Arctic Marginal Ice Zone. *Progr Oceanogr* **139**: 122–150. DOI: <https://doi.org/10.1016/j.pocean.2015.09.003>
- Bergeron, M and Tremblay, JÉ.** 2014. Shifts in biological productivity inferred from nutrient drawdown in the southern Beaufort Sea (2003–2011) and northern Baffin Bay (1997–2011), Canadian Arctic. *Geophys Res Lett* **41**(11): 3979–3987. DOI: <https://doi.org/10.1002/2014GL059649>
- Binder, B.** 1999. Reconsidering the relationship between virally induced bacterial mortality and frequency of infected cells. *Aquat Microb Ecol* **18**(3): 207–215. DOI: <https://doi.org/10.3354/ame018207>
- Blachowiak-Samolyk, K, Kwasniewski, S, Dmoch, K, Hop, H and Falk-Petersen, S.** 2007. Trophic structure of zooplankton in the Fram Strait in spring and autumn 2003. *Deep Sea Res Pt II* **54**(23): 2716–2728. DOI: <https://doi.org/10.1016/j.dsr2.2007.08.004>
- Bondavalli, C and Ulanowicz, RE.** 1999. Unexpected effects of predators upon their prey: the case of the American alligator. *Ecosystems* **2**(1): 49–63. DOI: <https://doi.org/10.1007/s100219900057>
- Borrett, SR and Lau, MK.** 2014. enaR: an R package for ecosystem network analysis. *Methods Ecol Evol* **5**(11): 1206–1213. DOI: <https://doi.org/10.1111/2041-210X.12282>
- Borrett, SR, Whipple, SJ and Patten, BC.** 2010. Rapid development of indirect effects in ecological networks. *Oikos* **119**(7): 1136–1148. DOI: <https://doi.org/10.1111/j.1600-0706.2009.18104.x>
- Bouchard, C, Mollard, S, Suzuki, K, Robert, D and Fortier, L.** 2014. Contrasting the early life histories of sympatric Arctic gadids *Boreogadus saida* and *Arctogadus glacialis* in the Canadian Beaufort Sea. *Polar Biol* **39**(6): 1005–1022. DOI: <https://doi.org/10.1007/s00300-014-1617-4>
- Boyd, P and Newton, P.** 1999. Does planktonic community structure determine downward particulate organic carbon flux in different oceanic provinces? *Deep Sea Res Pt I* **46**(1): 63–91. DOI: [https://doi.org/10.1016/S0967-0637\(98\)00066-1](https://doi.org/10.1016/S0967-0637(98)00066-1)
- Boyd, PW, Strzepek, R, Fu, F and Hutchins, DA.** 2010. Environmental control of open-ocean phytoplankton groups: Now and in the future. *Limnol Oceanogr* **55**(3): 1353–1376. DOI: <https://doi.org/10.4319/lo.2010.55.3.1353>
- Brey, T.** 2001. Population dynamics in benthic invertebrates. A virtual handbook. <http://www.awi-bremerhavende/Benthic/Ecosystem/FoodWeb/Handbook/main.html>. Germany: Alfred Wegener Institute for Polar and Marine Research.
- Brun, P, Vogt, M, Payne, MR, Gruber, N, O'brien, CJ, Buitenhuis, ET, Le Quééré, C, Leblanc, K and Luo, Y-W.** 2015. Ecological niches of open ocean phytoplankton taxa. *Limnol Oceanogr* **60**(3): 1020–1038. DOI: <https://doi.org/10.1002/lno.10074>

- Calbet, A and Saiz, E.** 2005. The ciliate-copepod link in marine ecosystems. *Aquat Microb Ecol* **38**(2): 157–167. DOI: <https://doi.org/10.3354/ame038157>
- Daly, KL.** 1997. Flux of particulate matter through copepods in the Northeast water polynya. *J Marine Syst* **10**(1): 319–342. DOI: [https://doi.org/10.1016/S0924-7963\(96\)00062-0](https://doi.org/10.1016/S0924-7963(96)00062-0)
- Darnis, G, Barber, DG and Fortier, L.** 2008. Sea ice and the onshore–offshore gradient in pre-winter zooplankton assemblages in southeastern Beaufort Sea. *J Marine Syst* **74**(3–4): 994–1011. DOI: <https://doi.org/10.1016/j.jmarsys.2007.09.003>
- Deming, JW, Fortier, L and Fukuchi, M.** 2002. The international North Water polynya study (NOW): a brief overview. *Deep-Sea Res Pt II* **22**(49): 4887–4892. DOI: [https://doi.org/10.1016/S0967-0645\(02\)00168-6](https://doi.org/10.1016/S0967-0645(02)00168-6)
- Dufour, K, Maps, F, Plourde, S, Joly, P and Cyr, F.** 2016. Impacts of intraguild predation on Arctic copepod communities. *Front Mar Sci* **3**: 185. DOI: <https://doi.org/10.3389/fmars.2016.00185>
- Dutz, J and Koski, M.** 2006. Trophic significance of solitary cells of the prymnesiophyte *Phaeocystis globosa* depends on cell type. *Limnol Oceanogr* **51**(3): 1230–1238. DOI: <https://doi.org/10.4319/lo.2006.51.3.1230>
- Engel, A, Piontek, J, Metfies, K, Endres, S, Sprong, P, Peeken, I, Gäbler-Schwarz, S and Nöthig, E-M.** 2017. Inter-annual variability of transparent exopolymer particles in the Arctic Ocean reveals high sensitivity to ecosystem changes. *Sci Rep-UK* **7**(1): 4129–4129. DOI: <https://doi.org/10.1038/s41598-017-04106-9>
- Estep, KW, Nejstgaard, JC, Skjoldal, HR and Rey, F.** 1990. Predation by copepods upon natural populations of *Phaeocystis pouchetii* as a function of the physiological state of the prey. *Mar Ecol Progr Ser* **67**: 235–249. DOI: <https://doi.org/10.3354/meps067235>
- Falkowski, PG, Katz, ME, Knoll, AH, Quigg, A, Raven, JA, Schofield, O and Taylor, FJR.** 2004. The evolution of modern eukaryotic phytoplankton. *Science* **305**(5682): 354–360. DOI: <https://doi.org/10.1126/science.1095964>
- Falk-Petersen, S, Hopkins, C and Sargent, J.** 1990. Trophic relationships in the pelagic, Arctic food web. In Barnes, M and Gibson, RN (eds.), *Trophic relationships in the marine environment*, 315–333. Aberdeen: Aberdeen University Press.
- Fath, BD and Patten, BC.** 1998. Network synergism: emergence of positive relations in ecological systems. *Ecol Model* **107**(2–3): 127–143. DOI: [https://doi.org/10.1016/S0304-3800\(97\)00213-5](https://doi.org/10.1016/S0304-3800(97)00213-5)
- Fath, BD, Scharler, UM and Baird, D.** 2013. Dependence of network metrics on model aggregation and throughflow calculations: demonstration using the Sylt–Rømø Bight Ecosystem. *Ecol Model* **252**: 214–219. DOI: <https://doi.org/10.1016/j.ecolmodel.2012.06.010>
- Fath, BD, Scharler, UM, Ulanowicz, RE and Hannon, B.** 2007. Ecological network analysis: network construction. *Ecol Model* **208**(1): 49–55. DOI: <https://doi.org/10.1016/j.ecolmodel.2007.04.029>
- Forest, A, Galindo, V, Darnis, G, Pineault, S, Lalonde, C, Tremblay, J-E and Fortier, L.** 2011. Carbon biomass, elemental ratios (C:N) and stable isotopic composition ( $^{13}\text{C}$ ,  $^{15}\text{N}$ ) of dominant calanoid copepods during the winter-to-summer transition in the Amundsen Gulf (Arctic Ocean). *J Plankton Res* **33**(1): 161–178. DOI: <https://doi.org/10.1093/plankt/fbq103>
- Fragoso, GM, Poulton, AJ, Yashayaev, IM, Head, EJH, Stinchcombe, MC and Purdie, DA.** 2016. Biogeographical patterns and environmental controls of phytoplankton communities from contrasting hydrographical zones of the Labrador Sea. *Progr Oceanogr* **141**: 212–226. DOI: <https://doi.org/10.1016/j.pocean.2015.12.007>
- Frangoulis, C, Carlotti, F, Eisenhauer, L and Zervoudaki, S.** 2010. Converting copepod vital rates into units appropriate for biogeochemical models. *Progr Oceanogr* **84**(1–2): 43–51. DOI: <https://doi.org/10.1016/j.pocean.2009.09.005>
- Gosselin, M, Lvasseur, M, Wheeler, PA, Horner, RA and Booth, BC.** 1997. New measurements of phytoplankton and ice algal production in the Arctic Ocean. *Deep Sea Res Pt II* **44**(8): 1623–1644. DOI: [https://doi.org/10.1016/S0967-0645\(97\)00054-4](https://doi.org/10.1016/S0967-0645(97)00054-4)
- Hagen, W and Auel, H.** 2001. Seasonal adaptations and the role of lipids in oceanic zooplankton 1. *Zoology* **104**(3–4): 313–326. DOI: <https://doi.org/10.1078/0944-2006-00037>
- Higashi, M and Patten, BC.** 1986. Further aspects of the analysis of indirect effects in ecosystems. *Ecol Model* **31**(1–4): 69–77. DOI: [https://doi.org/10.1016/0304-3800\(86\)90056-6](https://doi.org/10.1016/0304-3800(86)90056-6)
- Higashi, M and Patten, BC.** 1989. Dominance of indirect causality in ecosystems. *AmNat* **133**(2): 288–302. DOI: <https://doi.org/10.1086/284919>
- Hirst, A and Bunker, A.** 2003. Growth of marine planktonic copepods: global rates and patterns in relation to chlorophyll a, temperature, and body weight. *Limnol Oceanogr* **48**(5): 1988–2010. DOI: <https://doi.org/10.4319/lo.2003.48.5.1988>
- Holt, RD, Grover, J and Tilman, D.** 1994. Simple rules for interspecific dominance in systems with exploitative and apparent competition. *Am Nat* **144**(5): 741–771. DOI: <https://doi.org/10.1086/285705>
- Holt, RD and Polis, GA.** 1997. A theoretical framework for intraguild predation. *Am Nat* **149**(4): 745–764. DOI: <https://doi.org/10.1086/286018>
- Hop, H and Graham, M.** 1995. Respiration of juvenile Arctic cod (*Boreogadus saida*): effects of acclimation, temperature, and food intake. *Polar Biol* **15**(5): 359–367. DOI: <https://doi.org/10.1007/BF00238487>
- Hop, H, Tonn, WM and Welch, HE.** 1997. Bioenergetics of Arctic cod (*Boreogadus saida*) at low temperatures.

- Can J Fish Aquat Sci* **54**(8): 1772–1784. DOI: <https://doi.org/10.1139/f97-086>
- Hopcroft, RR, Clarke, C, Nelson, RJ and Raskoff, KA.** 2005. Zooplankton communities of the Arctic's Canada Basin: the contribution by smaller taxa. *Polar Biol* **28**(3): 198–206. DOI: <https://doi.org/10.1007/s00300-004-0680-7>
- Irigoien, X, Titelman, J, Harris, RP, Harbour, D and Castellani, C.** 2003. Feeding of *Calanus finmarchicus* nauplii in the Irminger Sea. *Mar Ecol Progr Ser* **262**: 193–200. DOI: <https://doi.org/10.3354/meps262193>
- Jiang, M, Borkman, DG, Libby, PS, Townsend, DW and Zhou, M.** 2014. Nutrient input and the competition between *Phaeocystis pouchetii* and diatoms in Massachusetts Bay spring bloom. *J Marine Syst* **134**: 29–44. DOI: <https://doi.org/10.1016/j.jmarsys.2014.02.011>
- Jiao, N, Herndl, GJ, Hansell, DA, Benner, R, Kattner, G, Wilhelm, SW, Kirchman, DL, Weinbauer, MG, Luo, T, Chen, F and Azam, F.** 2010. Microbial production of recalcitrant dissolved organic matter: long-term carbon storage in the global ocean. *Nature Reviews Microbiology* **8**: 593. DOI: <https://doi.org/10.1038/nrmicro2386>
- Jiao, N, Herndl, GJ, Hansell, DA, Benner, R, Kattner, G, Wilhelm, SW, Kirchman, DL, Weinbauer, MG, Luo, T, Chen, F and Azam, F.** 2011. The microbial carbon pump and the oceanic recalcitrant dissolved organic matter pool. *Nat Revs Microbiol* **9**: 555. DOI: <https://doi.org/10.1038/nrmicro2386-c5>
- Johnson, GA, Niquil, N, Asmus, H, Bacher, C, Asmus, R and Baird, D.** 2009. The effects of aggregation on the performance of the inverse method and indicators of network analysis. *Ecol Model* **220**(23): 3448–3464. DOI: <https://doi.org/10.1016/j.ecolmodel.2009.08.003>
- Joli, N, Gosselin, M, Ardyna, M, Babin, M, Onda, DF, Tremblay, J-É and Lovejoy, C.** 2018. Need for focus on microbial species following ice melt and changing freshwater regimes in a Janus Arctic Gateway. *Sci Rep-UK* **8**(1): 9405. DOI: <https://doi.org/10.1038/s41598-018-27705-6>
- Jónasdóttir, SH, Visser, AW, Richardson, K and Heath, MR.** 2015. Seasonal copepod lipid pump promotes carbon sequestration in the deep North Atlantic. *P Natl Acad Sci USA* **112**(39): 12122–12126. DOI: <https://doi.org/10.1073/pnas.1512110112>
- Jónasdóttir, SH, Wilson, RJ, Gislason, A and Heath, MR.** 2019. Lipid content in overwintering *Calanus finmarchicus* across the Eastern Subpolar North Atlantic Ocean. *Limnol Oceanogr* **64**(5): 2029–2043. DOI: <https://doi.org/10.1002/lno.11167>
- Kay, JJ, Graham, LA and Ulanowicz, RE.** 1989. A detailed guide to network analysis. In Wulf, F, et al. (eds.), *Network Analysis in Marine Ecology*, 15–61. Springer, Berlin. DOI: [https://doi.org/10.1007/978-3-642-75017-5\\_2](https://doi.org/10.1007/978-3-642-75017-5_2)
- Kellogg, CTE, Carpenter, SD, Renfro, AA, Sallon, A, Michel, C, Cochran, JK and Deming, JW.** 2011. Evidence for microbial attenuation of particle flux in the Amundsen Gulf and Beaufort Sea: elevated hydrolytic enzyme activity on sinking aggregates. *Polar Biol* **34**(12): 2007–2023. DOI: <https://doi.org/10.1007/s00300-011-1015-0>
- Klause, J and Johnson, S.** 2017. The origin of motif families in food webs. *Sci Rep-UK* **7**(1): 16197. DOI: <https://doi.org/10.1038/s41598-017-15496-1>
- Klein, B, LeBlanc, B, Mei, Z-P, Beret, R, Michaud, J, Mundy, CJ, von Quillfeldt, CH, Garneau, M-È, Roy, S, Gratton, Y, Cochran, JK, Bélanger, S, Larouche, P, Pakulski, JD, Rivkin, RB and Legendre, L.** 2002. Phytoplankton biomass, production and potential export in the North Water. *Deep Sea Res Pt II* **49**(22): 4983–5002. DOI: [https://doi.org/10.1016/S0967-0645\(02\)00174-1](https://doi.org/10.1016/S0967-0645(02)00174-1)
- Kones, JK, Soetaert, K, van Oevelen, D and Owino, JO.** 2009. Are network indices robust indicators of food web functioning? A Monte Carlo approach. *Ecol Model* **220**(3): 370–382. DOI: <https://doi.org/10.1016/j.ecolmodel.2008.10.012>
- Koski, M, Boutorh, J and de la Rocha, C.** 2017. Feeding on dispersed vs. aggregated particles: The effect of zooplankton feeding behavior on vertical flux. *PLoS one* **12**(5): e0177958. DOI: <https://doi.org/10.1371/journal.pone.0177958>
- Lalande, C, Bauerfeind, E, Nöthig, E-M and Beszczynska-Möller, A.** 2013. Impact of a warm anomaly on export fluxes of biogenic matter in the eastern Fram Strait. *Progr Oceanogr* **109**: 70–77. DOI: <https://doi.org/10.1016/j.pocean.2012.09.006>
- Latham, LG.** 2006. Network flow analysis algorithms. *Ecol Model* **192**(3–4): 586–600. DOI: <https://doi.org/10.1016/j.ecolmodel.2005.07.029>
- Le Moigne, FAC, Henson, SA, Sanders, RJ and Madsen, E.** 2013. Global database of surface ocean particulate organic carbon export fluxes diagnosed from the <sup>234</sup>Th technique. *Earth Syst Sci Data* **5**(2): 295–304. DOI: <https://doi.org/10.5194/essd-5-295-2013>
- Le Quéré, C, Harrison, SP, Colin Prentice, I, Buitenhuis, ET, Aumont, O, Bopp, L, Claustre, H, Cotrim Da Cunha, L, Geider, R and Giraud, X.** 2005. Ecosystem dynamics based on plankton functional types for global ocean biogeochemistry models. *Glob Change Biol* **11**(11): 2016–2040.
- Maps, F, Record, NR and Pershing, AJ.** 2014. A metabolic approach to dormancy in pelagic copepods helps explaining inter- and intra-specific variability in life-history strategies. *J Plankton Res* **36**: 18–30. DOI: <https://doi.org/10.1093/plankt/fbt100>
- Massicotte, P, Amiraux, R, Amyot, M-P, Archambault, P, Ardyna, M, Arnaud, L, Artigue, L, Aubry, C, Ayotte, P, Bécu, G, Bélanger, S, Benner, R, Bittig, HC, Bricaud, A, Brossier, É, Bruyant, F, Chauvaud, L, Christiansen-Stowe, D, Claustre, H, Cornet-Barthaux, V, Coupel, P, Cox, C, Delaforge, A, Dezutter, T, Dimier, C, Dominé, F, Dufour, F,**

- Dufresne, C, Dumont, D, Ehn, J, Else, B, Ferland, J, Forget, M-H, Fortier, L, Galí, M, Galindo, V, Gallinari, M, Garcia, N, Gérikas-Ribeiro, C, Gourdal, M, Gourvil, P, Goyens, C, Grondin, P-L, Guillot, P, Guilmette, C, Houssais, M-N, Joux, F, Lacour, L, Lacour, T, Lafond, A, Lagunas, J, Lalande, C, Laliberté, J, Lambert-Girard, S, Larivière, J, Lavaud, J, Lebaron, A, Leblanc, K, Le Gall, F, Legras, J, Lemire, M, Levasseur, M, Leymarie, E, Leynaert, A, Lopes Dos Santos, A, Lourenço, A, Mah, D, Marec, C, Marie, D, Martin, N, Marty, C, Marty, S, Massé, G, Matsuoka, A, Matthes, L, Moriceau, B, Muller, P-E, Mundy, CJ, Neukermans, G, Oziel, L, Panagiotopoulos, C, Pangazi, J-J, Picard, G, Picheral, M, Pinczon Du Sel, F, Pogorzelec, N, Probert, I, Queguiner, B, Raimbault, P, Ras, J, Rehm, E, Reimer, E, Rontani, J-F, Rysgaard, S, Saint-Béat, B, Sampei, M, Sansoulet, J, Schmidt, S, Sempéré, R, Sévigny, C, Shen, Y, Tragin, M, Tremblay, J-É, Vaulot, D, Verin, G, Vivier, F, Vladoiu, A, Whitehead, J and Babin, M. 2019. The Green Edge initiative: understanding the processes controlling the under-ice Arctic phytoplankton spring bloom. *SEANOE*. DOI: <https://doi.org/10.17882/59892>
- McCann, K, Hastings, A and Huxel, GR. 1998. Weak trophic interactions and the balance of nature. *Nature* **395**(6704): 794. DOI: <https://doi.org/10.1038/27427>
- McCann, KS. 2000. The diversity–stability debate. *Nature* **405**(6783): 228. DOI: <https://doi.org/10.1038/35012234>
- Menden-Deuer, S and Lessard, EJ. 2000. Carbon to volume relationships for dinoflagellates, diatoms, and other protist plankton. *Limnol Oceanogr* **45**(3): 569–579. DOI: <https://doi.org/10.4319/lo.2000.45.3.0569>
- Middelboe, M and Jørgensen, NO. 2006. Viral lysis of bacteria: an important source of dissolved amino acids and cell wall compounds. *Journal of the Marine Biological Association of the United Kingdom* **86**(3): 605–612. DOI: <https://doi.org/10.1017/S0025315406013518>
- Moloney, CL and Field, JG. 1989. General allometric equations for rates of nutrient uptake, ingestion, and respiration in plankton organisms. *Limnol Oceanogr* **34**(7): 1290–1299. DOI: <https://doi.org/10.4319/lo.1989.34.7.1290>
- Nejstgaard, JC, Tang, KW, Steinke, M, Dutz, J, Koski, M, Antajan, E and Long, JD. 2007. Zooplankton grazing on *Phaeocystis*: a quantitative review and future challenges. *Biogeochemistry* **83**(1–3): 147–172. DOI: <https://doi.org/10.1007/s10533-007-9098-y>
- Nielsen, TG and Hansen, B. 1995. Plankton community structure and carbon cycling on the western coast of Greenland during and after the sedimentation of a diatom bloom. *Mar Ecol Progr Ser* **125**: 239–257. DOI: <https://doi.org/10.3354/meps125239>
- Patten, BC. 1991. Network ecology: indirect determination of the life-environment relationship in ecosystems. In Higashi, M and Burns, T (eds.), *Theoretical studies of ecosystems: the network perspective*, 288–351. New York: Cambridge University Press.
- Patten, BC. 1992. Energy, emergy and environs. *Ecol Model* **62**(1–3): 29–69. DOI: [https://doi.org/10.1016/0304-3800\(92\)90081-0](https://doi.org/10.1016/0304-3800(92)90081-0)
- Pimm, SL and Lawton, JH. 1980. Are food webs divided into compartments? *J Anim Ecol*, 879–898. DOI: <https://doi.org/10.2307/4233>
- Pomeroy, LR. 1974. The ocean's food web, a changing paradigm. *Bioscience* **24**(9): 499–504. DOI: <https://doi.org/10.2307/1296885>
- Randelhoff, A, Oziel, L, Massicotte, P, Bécu, G, Galí, M, Lacour, L, Dumont, D, Vladoiu, A, Marec, C and Bruyant, F. 2019. The evolution of light and vertical mixing across a phytoplankton ice-edge bloom. *Elem Sci Anth* **7**(1). DOI: <https://doi.org/10.1525/elementa.357>
- Sabatini, M and Kiørboe, T. 1994. Egg production, growth and development of the cyclopoid copepod *Oithona similis*. *J Plankton Res* **16**(10): 1329–1351. DOI: <https://doi.org/10.1093/plankt/16.10.1329>
- Saint-Béat, B, Maps, F and Babin, M. 2018. Unraveling the intricate dynamics of planktonic Arctic marine food webs. A sensitivity analysis of a well-documented food web model. *Progr Oceanogr*. DOI: <https://doi.org/10.1016/j.pocean.2018.01.003>
- Schmitz, OJ, Krivan, V and Ovadia, O. 2004. Trophic cascades: the primacy of trait-mediated indirect interactions. *Ecol Lett* **7**(2): 153–163. DOI: <https://doi.org/10.1111/j.1461-0248.2003.00560.x>
- Schoemann, V, Becquevort, S, Stefels, J, Rousseau, V and Lancelot, C. 2005. *Phaeocystis* blooms in the global ocean and their controlling mechanisms: a review. *J Sea Res* **53**(1–2): 43–66. DOI: <https://doi.org/10.1016/j.seares.2004.01.008>
- Søreide, JE, Falk-Petersen, S, Hegseth, EN, Hop, H, Carroll, ML, Hobson, KA and Blachowiak-Samolyk, K. 2008. Seasonal feeding strategies of *Calanus* in the high-Arctic Svalbard region. *Deep Sea Res Pt II* **55**(20): 2225–2244. DOI: <https://doi.org/10.1016/j.dsr2.2008.05.024>
- Søreide, JE, Leu, EVA, Berge, J, Graeve, M and Falk-Petersen, S. 2010. Timing of blooms, algal food quality and *Calanus glacialis* reproduction and growth in a changing Arctic. *Glob Change Biol*. DOI: <https://doi.org/10.1111/j.1365-2486.2010.02175.x>
- Stevens, C, Deibel, D and Parrish, C. 2004. Species-specific differences in lipid composition and omnivory indices in Arctic copepods collected in deep water during autumn (North Water Polynya). *Mar Biol* **144**(5): 905–915. DOI: <https://doi.org/10.1007/s00227-003-1259-5>
- Stige, LC, Kvile, KØ, Bogstad, B and Langangen, Ø. 2018. Predator-prey interactions cause apparent competition between marine zooplankton groups. *Ecology* **99**(3): 632–641. DOI: <https://doi.org/10.1002/ecy.2126>

- Stoderegger, KE and Herndl, GJ.** 2001. Visualization of the exopolysaccharide bacterial capsule and its distribution in oceanic environments. *Aquat Microb Ecol* **26**(2): 195–199. DOI: <https://doi.org/10.3354/ame026195>
- Straile, D.** 1997. Gross growth efficiencies of protozoan and metazoan zooplankton and their dependence on food concentration, predator-prey weight ratio, and taxonomic group. *Limnol Oceanogr* **42**(6): 1375–1385. DOI: <https://doi.org/10.4319/lo.1997.42.6.1375>
- Suttle, CA.** 1994. The significance of viruses to mortality in aquatic microbial communities. *Microb Ecol* **28**(2): 237–243. DOI: <https://doi.org/10.1007/BF00166813>
- Suttle, CA.** 2005. Viruses in the sea. *Nature* **437**(7057): 356. DOI: <https://doi.org/10.1038/nature04160>
- Szyrmer, J and Ulanowicz, RE.** 1987. Total flows in ecosystems. *Ecol Model* **35**(1–2): 123–136. DOI: [https://doi.org/10.1016/0304-3800\(87\)90094-9](https://doi.org/10.1016/0304-3800(87)90094-9)
- Tang, CCL, Ross, CK, Yao, T, Petrie, B, DeTracey, BM and Dunlap, E.** 2004. The circulation, water masses and sea-ice of Baffin Bay. *Progr Oceanogr* **63**(4): 183–228. DOI: <https://doi.org/10.1016/j.pocean.2004.09.005>
- Thoisen, C, Riisgaard, K, Lundholm, N, Nielsen, TG and Hansen, PJ.** 2015. Effect of acidification on an Arctic phytoplankton community from Disko Bay, West Greenland. *Mar Ecol Progr Ser* **520**: 21–34. DOI: <https://doi.org/10.3354/meps11123>
- Tungaraza, C, Rousseau, V, Brion, N, Lancelot, C, Gichuki, J, Baeyens, W and Goeyens, L.** 2003. Contrasting nitrogen uptake by diatom and *Phaeocystis*-dominated phytoplankton assemblages in the North Sea. *J Exp Mar Biol Ecol* **292**(1): 19–41. DOI: [https://doi.org/10.1016/S0022-0981\(03\)00145-X](https://doi.org/10.1016/S0022-0981(03)00145-X)
- Turner, JT.** 2004. The importance of small planktonic copepods and their roles in pelagic marine food webs. *Zoological studies* **43**(2): 255–266.
- Ulanowicz, RE.** 1986. *Growth and Development: Ecosystems Phenomenology*. Springer: New York. DOI: <https://doi.org/10.1007/978-1-4612-4916-0>
- Ulanowicz, RE.** 1997. *Ecology, the ascendent perspective*. Columbia University Press.
- Ulanowicz, RE and Kemp, WM.** 1979. Toward canonical trophic aggregations. *Am Nat* **114**(6): 871–883. DOI: <https://doi.org/10.1086/283534>
- Ulanowicz, R and Puccia, C.** 1990. Mixed trophic impacts in ecosystems. *Coenoses* **5**(3): 7–16.
- Uye, S-i.** 1982. Length-weight relationships of important zooplankton from the Inland Sea of Japan. *Journal of the Oceanographical Society of Japan* **38**: 149–158. DOI: <https://doi.org/10.1007/BF02110286>
- Valiente-Banuet, A, Aizen, MA, Alcántara, JM, Arroyo, J, Cocucci, A, Galetti, M, García, MB, García, D, Gómez, JM and Jordano, P.** 2015. Beyond species loss: the extinction of ecological interactions in a changing world. *Funct Ecol* **29**(3): 299–307. DOI: <https://doi.org/10.1111/1365-2435.12356>
- Van den Meersche, K, Soetaert, K and Van Oevelen, D.** 2009. xsample (): an R function for sampling linear inverse problems. *J Stat Softw* **30**: Code Snippet 1. DOI: <https://doi.org/10.18637/jss.v030.c01>
- Vandermeer, J.** 2004. Coupled oscillations in food webs: balancing competition and mutualism in simple ecological models. *Am Nat* **163**(6): 857–867. DOI: <https://doi.org/10.1086/420776>
- Varela, DE, Crawford, DW, Wrohan, IA, Wyatt, SN and Carmack, EC.** 2013. Pelagic primary productivity and upper ocean nutrient dynamics across Subarctic and Arctic Seas. *J Geophys Res-Oceans* **118**(12): 7132–7152. DOI: <https://doi.org/10.1002/2013JC009211>
- Vézina, AF and Pace, ML.** 1994. An inverse model analysis of planktonic food webs in experimental lakes. *Can J Fish Aquat Sci* **51**(9): 2034–2044. DOI: <https://doi.org/10.1139/f94-206>
- Vézina, AF and Platt, T.** 1988. Food web dynamics in the ocean. 1. Best-estimates of flow networks using inverse methods. *Mar Ecol Progr Ser* **42**(3): 269–287. DOI: <https://doi.org/10.3354/meps042269>
- Visser, AW, Grønning, J and Jónasdóttir, SH.** 2017. *Calanus hyperboreus* and the lipid pump. *Limnol Oceanogr* **62**(3): 1155–1165. DOI: <https://doi.org/10.1002/lno.10492>
- Vogt, M, O'Brien, C, Peloquin, J, Schoemann, V, Breton, E, Estrada, M, Gibson, J, Karentz, D, Van Leeuwe, MA and Stefels, J.** 2012. Global marine plankton functional type biomass distributions: *Phaeocystis* spp. *Earth Syst Sci Data* **4**(1): 107–120. DOI: <https://doi.org/10.5194/essd-4-107-2012>
- Wassmann, P.** 1994. Significance of sedimentation for the termination of *Phaeocystis* blooms. *J Marine Syst* **5**(1): 81–100. DOI: [https://doi.org/10.1016/0924-7963\(94\)90018-3](https://doi.org/10.1016/0924-7963(94)90018-3)
- Weinbauer, MG, Winter, C and Höfle, MG.** 2002. Reconsidering transmission electron microscopy based estimates of viral infection of bacterio-plankton using conversion factors derived from natural communities. *Aquat Microb Ecol* **27**(2): 103–110. DOI: <https://doi.org/10.3354/ame027103>
- Williams, RJ and Martinez, ND.** 2004. Limits to trophic levels and omnivory in complex food webs: theory and data. *Am Nat* **163**(3): 458–468. DOI: <https://doi.org/10.1086/381964>
- Wootton, JT.** 1994. The nature and consequences of indirect effects in ecological communities. *Annu Rev Ecol Syst* **25**(1): 443–466. DOI: <https://doi.org/10.1146/annurev.es.25.110194.002303>
- Wootton, JT.** 2002. Indirect effects in complex ecosystems: recent progress and future challenges. *J Sea Res* **48**(2): 157–172. DOI: [https://doi.org/10.1016/S1385-1101\(02\)00149-1](https://doi.org/10.1016/S1385-1101(02)00149-1)



**How to cite this article:** Saint-Béat, B, Fath, BD, Aubry, C, Colombet, J, Dinasquet, J, Fortier, L, Galindo, V, Grondin, P-L, Joux, F, Lalande, C, LeBlanc, M, Raimbault, P, Sime-Ngando, T, Tremblay, J-E, Vaulot, D, Maps, F and Babin, M. 2020. Contrasting pelagic ecosystem functioning in eastern and western Baffin Bay revealed by trophic network modeling. *Elem Sci Anth*, 8: 1. DOI: <https://doi.org/10.1525/elementa.397>

**Domain Editor-in-Chief:** Jody W. Deming, School of Oceanography, University of Washington, US

**Associate Editor:** Jeff Bowman, University of California San Diego Scripps Institution of Oceanography, US

**Knowledge Domain:** Ocean Science

**Part of an *Elementa* Special Feature:** Green Edge

**Submitted:** 04 June 2019

**Accepted:** 27 November 2019

**Published:** 06 January 2020

**Copyright:** © 2020 The Author(s). This is an open-access article distributed under the terms of the Creative Commons Attribution 4.0 International License (CC-BY 4.0), which permits unrestricted use, distribution, and reproduction in any medium, provided the original author and source are credited. See <http://creativecommons.org/licenses/by/4.0/>.



*Elem Sci Anth* is a peer-reviewed open access journal published by University of California Press.

**OPEN ACCESS** The Open Access icon, which is a stylized 'A' inside a circle.