



HAL
open science

A Reconfigurable Coil grid for Receiver Localization in Wireless Power Transfer and Magnetic Field Steering

Jaafar Al Sinayyid, Hakim Takhedmit, Patrick Poulichet, Marjorie Grzeskowiak, Antoine Diet, Gaelle Bazin Lissorgues

► **To cite this version:**

Jaafar Al Sinayyid, Hakim Takhedmit, Patrick Poulichet, Marjorie Grzeskowiak, Antoine Diet, et al.. A Reconfigurable Coil grid for Receiver Localization in Wireless Power Transfer and Magnetic Field Steering. IEEE Journal of Radio Frequency Identification, 2021, 5 (2), pp.128-138. 10.1109/JR-FID.2020.3046677 . hal-03091040

HAL Id: hal-03091040

<https://hal.science/hal-03091040>

Submitted on 9 Jun 2021

HAL is a multi-disciplinary open access archive for the deposit and dissemination of scientific research documents, whether they are published or not. The documents may come from teaching and research institutions in France or abroad, or from public or private research centers.

L'archive ouverte pluridisciplinaire **HAL**, est destinée au dépôt et à la diffusion de documents scientifiques de niveau recherche, publiés ou non, émanant des établissements d'enseignement et de recherche français ou étrangers, des laboratoires publics ou privés.



Open Archive Toulouse Archive Ouverte (OATAO)

OATAO is an open access repository that collects the work of some Toulouse researchers and makes it freely available over the web where possible.

This is an author's version published in: <https://oatao.univ-toulouse.fr/27285>

Official URL : <https://doi.org/10.1109/JRFID.2020.3046677>

To cite this version :

Al Sinayyid, Jaafar and Takhedmit, Hakim and Poulichet, Patrick and Grzeskowiak, Marjorie and Diet, Antoine and Lissorgues, Gaëlle A Reconfigurable Coil grid for Receiver Localization in Wireless Power Transfer and Magnetic Field Steering. (2021) IEEE Journal of Radio Frequency Identification, 5 (2). 128-138. ISSN 2469-7281

Any correspondence concerning this service should be sent to the repository administrator:

tech-oatao@listes-diff.inp-toulouse.fr

A Reconfigurable Coil Grid for Receiver Localization in Wireless Power Transfer and Magnetic Field Steering

Jaafar Al Sinayyid, Hakim Takhedmit¹, Patrick Poulichet, Marjorie Grzeskowiak, Antoine Diet²,
and Gaëlle Lissorgues³

Abstract—The main purpose of Inductive Power Transmission (IPT) is efficient power transfer. Yet the ability to localize the receiver is itself an interesting goal. In Qi standards for wireless power transfer, the localization is performed by using a coils array. The resolution of localization is equal to the diameter of the coils in the transmitter array. Decreasing the diameter of coils in transmitters increases the resolution of localization but also reduces the range of power transfer. IPT is used in inductive RFID (Radio Frequency Identification) where a trade-off between resolution of localization and range of tag detection arises. This article proposes an original system making it possible to modify the resolution and the distance of operation independently. Calculations and simulations are implemented in MATLAB software. Experiments in low frequency validate the method and show the system capability to localize the receiver with good accuracy, with mean absolute error of 4 mm for localizing a receiver coil of 1 cm radius positioned in a box with dimensions 20*20*10 cm. Transmitter is a grid of 9 coils of 3.3 cm radius. After localization, the magnetic field is steered in the direction of the receiver to obtain a more efficient power transfer.

Index Terms—Reconfigurable transmitter antenna, inductive beamforming, magnetic coupling, near field localization.

I. INTRODUCTION

ONE OF the most promising WPT (Wireless Power Transfer) method in the near field is inductive power transfer (IPT). Regarding IPT, in this work two problems are addressed.

The first problem is the low mutual inductance due to misalignment and non-optimized orientation which impacts

directly the power-transfer efficiency. The second problem is the localization ability.

When the receiver coil is in a random position or orientation in respect to the transmitter coil, the mutual inductance between them is calculated using Neumann formula, Eq. (1) [1].

$$M = \frac{\mu_0}{4\pi} \oint_{c_1} \oint_{c_2} \frac{dl_1 \cdot dl_2}{R_{12}} \quad (1)$$

where M is the mutual inductance between the two loops, dl_1 is the differential length along the electrical path for the current I_1 in first coil and dl_2 is the differential length along the electrical path for the current I_2 in second coil. C_1 and C_2 represent the first coil and the second coil, respectively. R_{12} is the distance between each differential length dl_1 and dl_2 .

According to this formula the mutual inductance depends strongly on the relative position and the orientation between the transmitter and the receiver. For certain positions and orientations there can be essentially zero coupling. Those are called null areas. If the receiver is in a null area, due to very low mutual inductance, there would be not enough power transfer between the transmitter and the receiver. For example, in RFID (Radio Frequency Identification) systems based on induction, the tag will not be detected because the minimum required power is not reached. This is the first problem. Some solutions based on reducing the probability that a receiver is in such null areas are proposed in the literature [2]–[5].

The second problem is the localization of the receiver which is useful in many applications. It has recently gained interests because of the wide range of possible needs for IoT (Internet of Things). Different technologies and algorithms that have been used in general to accomplish the localization task are in far field. The most used are: Received Signal Strength (RSS), Angle of Arrival (AoA), Return Time of Flight (RTof) and Time of Flight (ToF) [6]–[12] but they are not applicable directly in near field region.

Recently, a broad variety of methods has been studied for localization techniques applicable in near field. These solutions in general are based on a coils grid as a transmitter. Localization is performed by detecting which single coil or coils are more affected by the presence of the receiver due to the reflected impedance. In general, the receiver (or the tag in RFID case) causes higher reflected impedances in

Jaafar Al Sinayyid, Hakim Takhedmit, Patrick Poulichet, and Gaëlle Lissorgues are with Gustave Eiffel University, ESYCOM, UMR 9007 CNRS, ESIEE-Paris, CNAM, 77454 Marne-la-Vallée, France (e-mail: jaafar.alsinayyid@edu.esiee.fr; hakim.takhedmit@u-pem.fr; p.poulichet@esiee.fr; gaelle.lissorgues@esiee.fr).

Marjorie Grzeskowiak is with ISAE Supaero, Université de Toulouse, 31055 Toulouse, France (e-mail: marjorie.grzeskowiak@isae-supero.fr).

Antoine Diet is with Université Paris-Saclay, CentraleSupélec, CNRS, Laboratoire de Génie Electrique et Electronique de Paris, 91192 Gif-sur-Yvette, France, and also with Sorbonne Université, CNRS, Laboratoire de Génie Electrique et Electronique de Paris, 75252 Paris, France (e-mail: antoine.diet@geeps.centralesupelec.fr).

Digital Object Identifier 10.1109/JRFID.2020.3046677

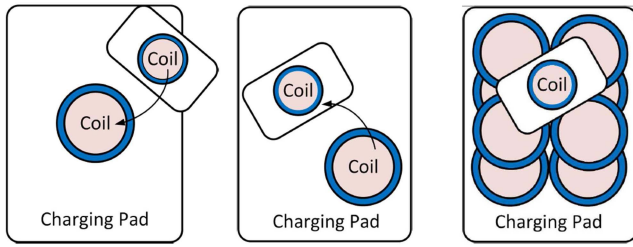

Fig. 1. Qi wireless charging standards propose three models of wireless charging system. Guided positioning by magnetic attraction (left), free positioning by moving Coil (middle) and free positioning by coil array (right). Localization is performed in the Coil Array model. The figure is reproduced from [13].

the transmitter coil which is closer to it than other coils of transmitter. Then the location of the coil with higher reflected impedance is used to estimate the location of receiver. These methods are in accordance with Qi standards which propose several models of wireless charging system [13].

One of the models explained by Qi standard is Free-positioning model in which localization is done based on reflected impedance as mentioned above, Fig. 1. In Qi standards for wireless power transfer, localization is performed implicitly by an array of coils. The device to be charged is freely positioned above this coils array and it changes only the reflected impedance of a coil right below it. Then power transfer is performed by exciting the coil underneath the device.

The resolution of localization therefore is equal to the diameter of the coils in the array. Decreasing the diameter of each coil increases the resolution of localization but also reduces the range of power transfer. IPT also is used in inductive RFID (Radio Frequency Identification) where a trade-off between resolution of localization and range of tag detection arises.

In recent years different methods in the frame work of coils grid and reflected impedance have been proposed to enhance the accuracy of localization.

For example, in [14] the proposed system will choose a coil from the TX coil matrix as the signal emitting antenna and it will choose another coil beside as the receiving antenna. Whenever the RX coil covers a signal antenna, the receiving antenna will return a signal that is determined by the relative position between the RX and TX coils. This method is not suitable for small size RX.

In [15] another method for localization in near field suitable for movable transmitter is proposed. This method depends on fixed reference receivers placed in known positions (or reference tags in RFID case). In RFID application of this method the transmitter reads the closest tags and from the data base containing the position of each tag, the position of the transmitter is deduced.

In [9] for increasing the accuracy of localization of a movable reader, it proposes a new design of transmitter antenna that divides the reading area of the transmitter into several parts. Other enhancement techniques for localization were proposed in [16]–[22].

Most of these mentioned methods have two properties in common:

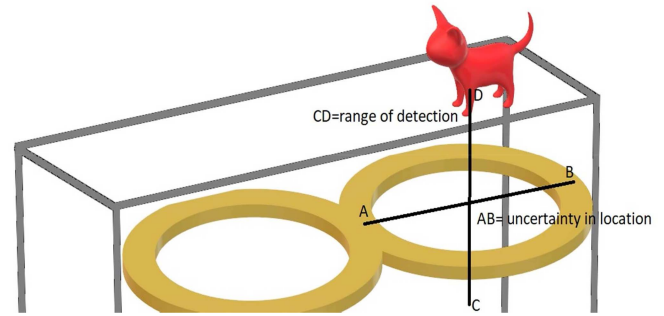

Fig. 2. Range of detection is approximately equal to the inaccuracy in location. If the current method is applied in natural habitat of animals, one should increase the diameter of transmitter coil and that will increase the inaccuracy in the detection of the animal position.

1) The resolution of these methods is equal to the diameter of coils constituting the array transmitter. So, it is possible to increase the accuracy of localization by reducing the diameter of the transmitter coils. However, it is known [23]–[24] that the effective power transfer takes place within the separation between transmitter and receiver which is not larger than the diameter of the transmitter coil. Therefore, decreasing the diameter of each coil although increases the resolution of localization but also reduces the range of effective power transfer. So, there is a trade-off between resolution of localization and maximum permitted distance between transmitter and receiver. In RFID applications for localization, this problem shows up as a trade-off between resolution of localization and range of tag detection.

To give an example, consider using this method with inductive RFID for indoor tracking of small animals [25]. In such cases, a grid of transmitter antenna is placed directly underneath the cage of the small animal to be studied. However, if one wants to apply this setup to free living animals, it is not always possible to place the transmitter coils close enough below the animals. It is then desirable to increase the range of detection above the transmitter coil. One option is to increase the diameter of the transmitter coil. But the above-mentioned trade-off between accuracy and range of detection will show up again. Fig. 2 illustrates an example of this problem. Assume the practical constraints do not allow us to place a transmitter coil directly underneath the animal carrying a tag and the transmitter is positioned at a certain distance underneath the animal. In Fig. 2 the line segment CD shows this distance between the transmitter coil and the tag carried by the animal. As it was mentioned earlier, increasing the range of detection in RFID requires increasing the diameter of the transmitter coil, represented by the line segment AB in Fig. 2, to be equal to the line segment CD. In this example when the tag is detected by the transmitter, it can be anywhere along AB line segment and it is not possible to determine the location of the tag with a higher accuracy.

2) The earlier proposed solutions for overcoming this trade-off and increasing the accuracy involve additional complementary devices to be added to the system which increases the complexity and cost of the transmitter or the reader in RFID case. For example, for the method used in [15], to

TABLE I
COMPARATIVE STUDY OF DIFFERENT LOCALIZATION TECHNIQUES IN NEAR FIELD RFID AND WPT

METHOD / WORK	ADVANTAGE	DISADAVANTAGE	FREQUENCY BAND	PARAMETERS OF TX AND RX	ERROR*
Magnetic attraction (Qi standard)	Low cost	Unable to localize	-	-	-
Movable primary coil (Qi standard)	Efficient power transfer	Mechanically moving parts high cost	-	-	-
Jianchao Li [14]	No need for reference tags	Range of detection decrease by increasing the accuracy of localization, not suitable for small size RX	HF	TX= 7 turns spiral coils Inner radius of TX = 10 mm, Outer radius of TX = 50 mm RX= 7 turns spiral coils Inner radius of RX = 80 mm, Outer radius of RX = 120 mm	1.22 cm
M. Y. Ahmad [15]	Suitable for tracking movable reader	Need for reference tags. Increasing accuracy of detection needs more tag	HF	TX= triangular-loop-bridge reader using multiple triangular loops RX= standard commercially available passive tags	4.05 cm
D. Fortin-Simard [16]	No need for reference tags	Without modification could not address of three-dimensional localization.	HF	TX= commercially available reader A-PATCH-0025 RX= standard commercially available passive tags	14.1 cm
Lei Yang [17]	Suitable for tracking movable reader	Need for reference tags	HF	TX= commercially available reader RX= standard commercially available passive tags	18.6 cm
Proposed solution	Range of detection is independent of accuracy of localization. no need for reference tags.	Needs higher memory	LF	TX= 6 turns coil of radius 3.3 cm. RX=1 turn coil of radius 1 cm	4 mm

* ERROR is the maximum difference between the actual position of RX and the determined position of RX

increase the accuracy of localization of movable reader it is necessary to increase the number of reference tags and use a denser grid of reference tags.

In this work a new solution is proposed to address these two properties and associated issues.

Namely first we propose a method that makes it possible to modify the resolution and the distance of operation independently and achieve better localization accuracy.

Secondly, we offer to do so not by adding additional complementary devices (for example by increasing the required coils or reference tags) but rather by proposing a new algorithm based on a data base stored in the memory of the control module of the transmitter.

Table I shows a brief comparison between the method proposed in this work and other methods proposed by Qi standards and solutions that try to enhance the localization in the framework of Qi standards.

After localization is done then, it's possible to use the obtained information about the location of the receiver to solve the classic problem of coils misalignment. Indeed, the transmitter antenna is excited in a way that generates a magnetic field which can guarantee that the receiver is not in the null detection area. So, the proposed system is a reconfigurable transmitter antenna that localizes the receiver and then enhances the power transfer performance by beamforming according to the detected position of the receiver.

This method could be useful for example in applications such as charging table or the detection and data exchange with medical implants (in-body).

All the calculations, simulations and the algorithm in this work were performed in MATLAB software. Furthermore, experimentations are presented to validate the proposed method.

II. RECONFIGURABLE TRANSMITTER MULTI-COILS ANTENNA

The transmitter antenna is a 2D planar grid of circular coils. This grid is used for both localization and power transfer. It is reconfigurable because all coils are connected by switches and these switches make it possible to either connect or disconnect each coil from the whole structure of the transmitter, or inverting the current direction in each coil. The number of circular coils and their diameter depend on the target volume where the receiver to localize is.

The volume in which the receiver coil is to be localized is referred to as the volume of interest. It is assumed that the volume of interest is pre-given. The method of detection explained here is based on measuring the coupling between the receiver and the transmitter. To ensure that the coupling coefficient "k" is not too small, the number and the diameter of each coil should be chosen in a way that regardless of the position

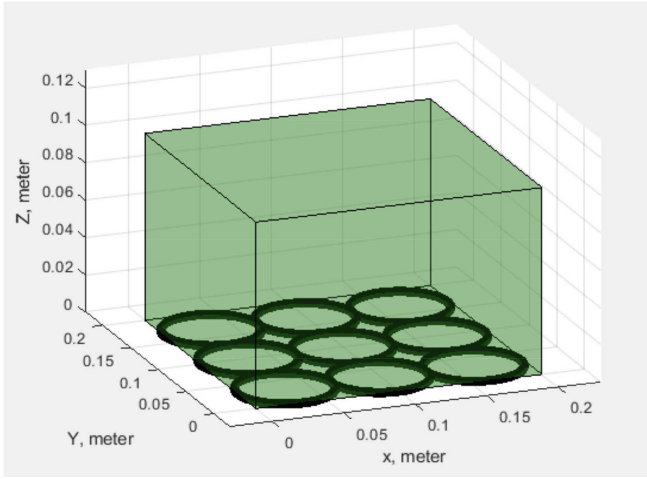

Fig. 3. The transmitter antenna consists of a grid of 9 circular coils connected through switches. The volume of interest in which the transmitter could localize the receiver is a green box above the transmitter ($20 \times 20 \times 10 \text{ cm}^3$).

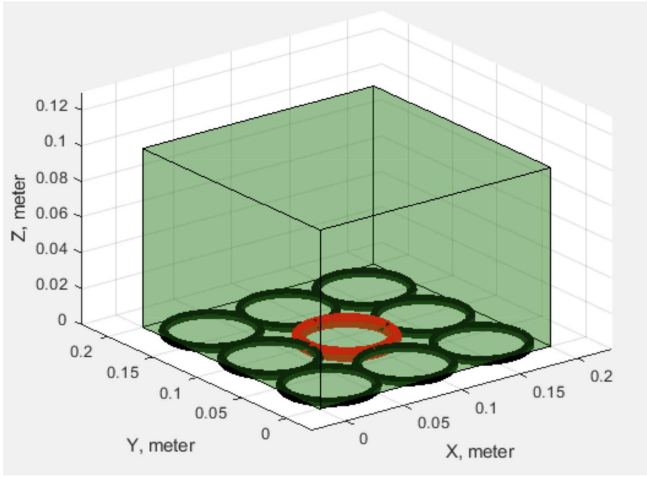

Fig. 4. One possible configuration in which 8 of the coils are disconnected from the sender antenna (black-color coils) and the antenna consists of only one coil (red-color coil).

of the receiver in the volume of interest, there is always a number of transmitter coils that are close enough to the receiver to have mutual inductance strong enough to be measured. For this study, the volume to be covered is a box of the dimensions: $x = 20 \text{ cm}$, $y = 20 \text{ cm}$ and $z = 10 \text{ cm}$. To make sure that regardless of the position of the receiver there is a number of transmitter coils close to it, a reconfigurable structure consisting of 9 coils of radius 3.3 cm arranged in a way shown in Fig. 3 is chosen. The volume of interest in this study is chosen arbitrary just to validate the idea. The switches between coils allow connecting and disconnecting each coil of the transmitter leading to different substructures. Fig. 4 shows one possible substructure which consists only of one coil and all other coils are turned off. Different substructures are considered as different configurations of the transmitter.

III. LOCALIZATION METHOD IN NEAR FIELD

The method proposed in this article starts with the observation that the coupling between the transmitter and the receiver

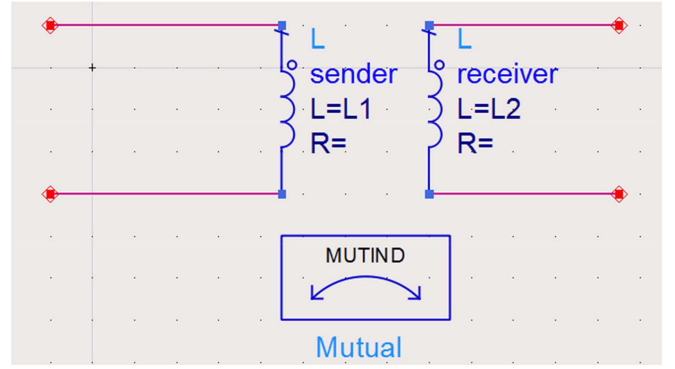

Fig. 5. The circuit model of the transmitter-receiver as a two-port network.

is a result of the geometries, and also relative orientation and position of receiver and transmitter. For many applications it is reasonable to assume that the shapes and self-inductances of receiver and transmitter do not change, therefore the coupling coefficient only depends on their relative orientation and positions. This suggests that by measuring the coupling between them, it is possible to deduce their relative orientation and position. It is assumed that the receiver is a small circular coil and its position means the coordinate of its center. When the coupling coefficient is obtained, the mutual inductance could be determined according to Eq. (2):

$$M = k \sqrt{L1 L2} \quad (2)$$

In which $L1$ is the self-inductance of the transmitter, $L2$ is the self-inductance of the receiver, k the coupling coefficient between them and M is the mutual inductance between transmitter and the receiver, Fig. 5.

It is this obtained value of mutual inductance between transmitter and the receiver that will be used for localization. However, it should be noticed that as the shape of the transmitter is circular symmetric, the value of mutual inductance between the transmitter and receiver coils could not be mapped in one step to a unique position of the receiver. Indeed, it could be mapped to a set of positions of the receiver that all could yield the same mutual inductance value if the receiver was at any of those positions (Fig. 6). Though the value of mutual inductance does not lead to a unique position, it leads to a smaller subset of positions in the volume of interest which fits the obtained value of mutual inductance and eliminating other positions which do not fit the measured value of coupling. Indeed, instead of directly finding the right position of the receiver, the positions of the receiver that are not consistent with the obtained value of mutual inductance are eliminated.

The localization procedure starts by switching on the first coil in the transmitter grid while other coils are switched off and the mutual inductance between the first coil of transmitter grid and the receiver is measured. From this measured mutual inductance, by a method explained later, all possible positions of the receiver are calculated. To reduce this set of all possible positions of the receiver to its real position, the first coil is switched off and a second coil is activated, by measuring the coupling between the second coil transmitter and the receiver and following the same principle described above, it is possible

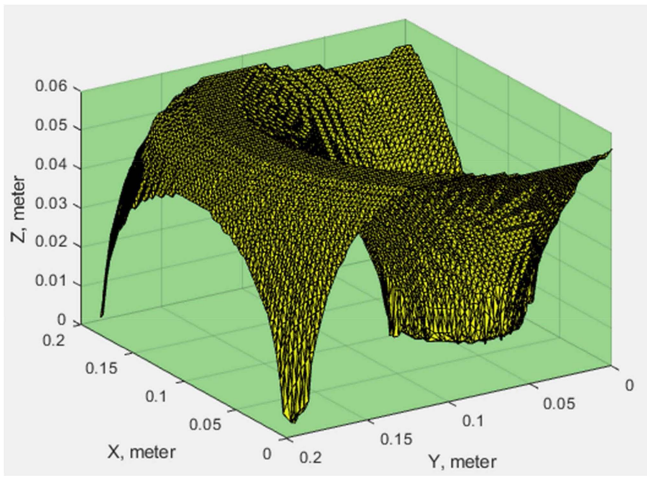

Fig. 6. Due of the symmetry of the transmitter coils, a certain value of mutual inductance or its corresponding coupling factor could be a result of large different number of positions of receiver. In this figure the green box is the volume of interest. The transmitter coil of diameter 3.3 cm is placed at $(x = 0.1, y = 0.03)$, and the receiver coil is of diameter 2 cm. All the yellow points show the positions of the receiver which yield in same coupling (coupling factor $K = 5\%$ is arbitrary chosen for the sake of demonstration).

to find another subset of positions which fits the obtained value of mutual inductance between the second transmitter and the receiver.

Because the real position of the receiver should at the same time belong to both subsets of possible positions, the intersection of these two subsets should be taken as a new and more reduced subset of possible positions of the receiver. Therefore, the positions that do not match the two measured values of coupling at the same time, are ruled out. Then an iterative approach is launched for third coil, fourth coil... and so on. At the end of this iteration a position or a small set of very concentrated points for the position of the center of the receiver are obtained and the localization is finished. Chart I summarize this procedure.

To demonstrate this method in practice all that should be done is:

- 1) Having a grid of transmitter coils that could be activated and deactivated separately.
- 2) Being able to measure the coupling between the activated coil and the receiver.
- 3) Having a tool to map the measured coupling to all possible positions of the receiver corresponding to the obtained mutual inductance.

This approach consists of a measurement of mutual inductance between the transmitter coil and the receiver coil, then this measured value is imported to a MATLAB code for processing it and calculating the location of the receiver.

Below this approach is explained in more detailed steps. For the sake of simplicity, the receiver antenna is chosen to be a simple circular coil of 1 cm radius with one turn. The goal is to find the location of the receiver coil center.

The circuit shown in Fig. 7 is used to model the system. It consists of a transmitter with its self-inductance $L1$, a receiver with its self-inductance $L2$ and a load ZL connected to the receiver. All these parameters which are independent from the

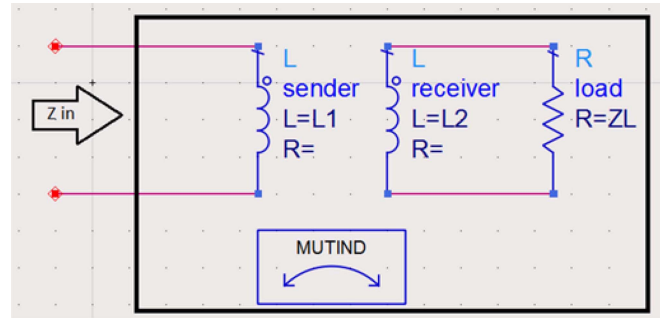

Fig. 7. The circuit model of the transmitter-receiver as a one-port network. By measuring Z_{in} , it is possible to deduce the mutual inductance between the transmitter and the receiver.

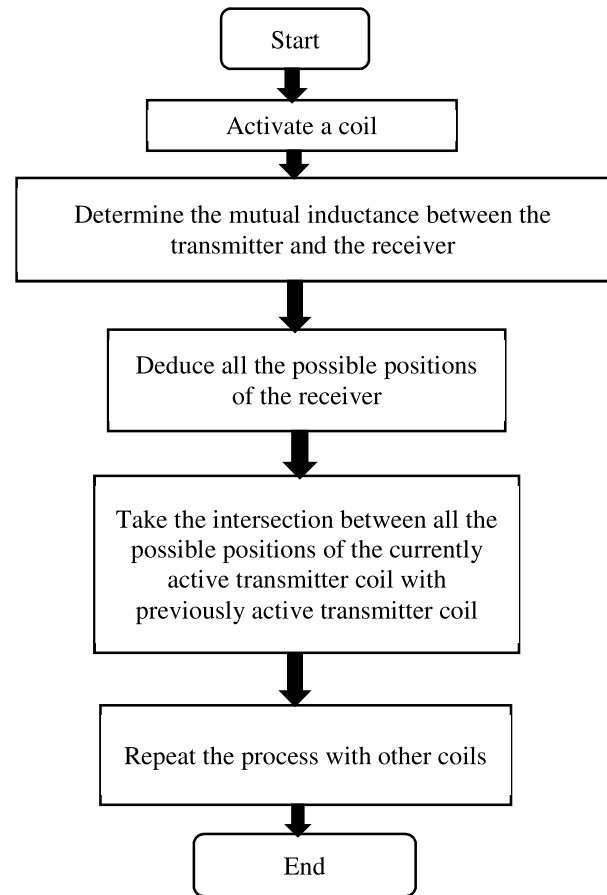

Chart I procedure of localization

relative positions between the transmitter and the receiver, are known. What is unknown is the mutual inductance between the receiver and the transmitter, which depends on the position of the receiver. By measuring the input impedance of the transmitter shown in Fig. 7 and according to the relation, Eq (3), the mutual inductance is deduced. In Eq (3), Z_{in} is the measured input impedance of the transmitter and ω the angular frequency of operation. In practice the circuit would have more elements like compensation capacitors and internal resistance of coils, but they are neglected in this schematic. The main point here is to show that by measuring the input impedance one can deduce the mutual inductance value M

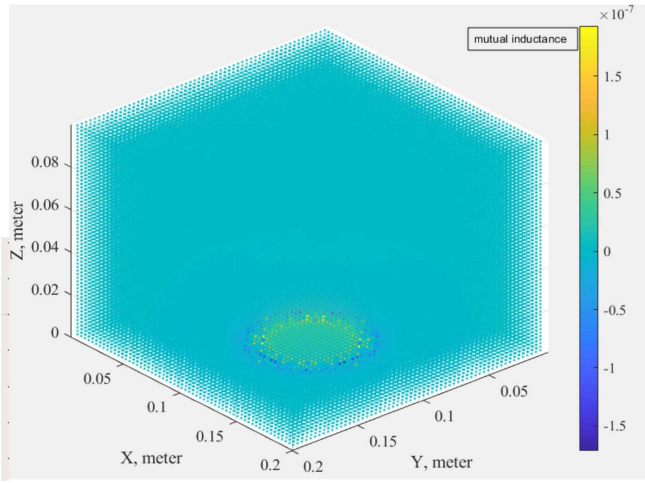

Fig. 8. The mutual inductance between the transmitter and the receiver as a function of locations in the volume of interest. These locations are distinct points. Each point represents one location at which the center of the receiver could be. The color of that point shows the value of mutual inductance. The positive and negative values refer to the direction of magnetic field passing through the receiver coil.

between the receiver and the transmitter by.

$$M = \text{Imaginary part} \left[\frac{\sqrt{(Z_{in} - j\omega L_1)(Z_L + j\omega L_2)}}{\omega} \right] \quad (3)$$

The volume of interest is divided into a 3D grid of points, each point represents one possible location of the receiver. The distance between the points will be the limit of accuracy of the localization method. This 3D grid will be stored in the controlling circuitry of the transmitter. The size of storage required for restoring this grid will be proportional to the cube number of points. In this study the volume of interest is a box of the dimensions: $x = 20$ cm, $y = 20$ cm and $z = 10$ cm and the spacing between the points of the 3D grid is 1 mm along each axis. In a real practical system, the required precision of localization and available data storage capability will determine the maximum spacing between the points of the grid

Prior to starting localization process, the mutual inductance between the transmitter and the receiver is precalculated as if the receiver center was to be at any of the points of the 3D grid mentioned above. This yields into a 3D matrix. This 3D matrix assigns to each point of the 3D volume of interest a mutual inductance value between the transmitter and the receiver (if the center of the receiver coil was at that point). For each different configurations of the transmitter there is one such pre-computed matrix. Fig. (8) illustrates graphically such a matrix for the configuration shown in the Fig. 4.

It is assumed in a first approach that the receiver coil is included in a plane parallel to the transmitter. If one would like to localize a receiver with an arbitrary orientation, the same logic still holds but one will have to count for two possible orthogonal angles of the receiver that specify its orientation at each point of the volume of interest and that will lead to a 5D matrix.

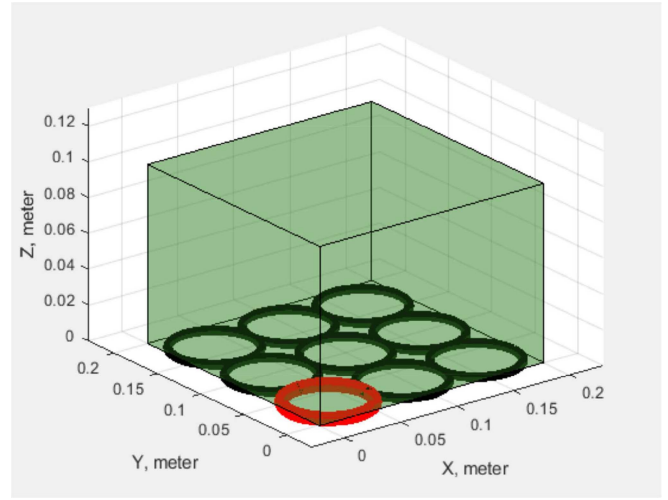

Fig. 9. First step of localization. A configuration in which only one coil (red coil) is chosen and connected to the excitation input. The other coils at this step are disconnected from transmitter and are turned off (black coils). In next steps to follow this coil will be turned off and another coil will turn on. In total there will be 9 steps, in each of them only one coil is turned on and others are turned off.

The localization process is initiated by choosing a configuration of the transmitter in a way that all the coils are disconnected and only one coil is connected, Fig. 9.

The input impedance of the transmitter antenna is measured at the frequency of operation and then the mutual inductance between the receiver and the transmitter is determined according to Eq. (3).

The value of this mutual inductance is compared with the precomputed mutual inductance matrix of the considered configuration.

This comparison gives all possible positions of the receiver that would lead to the same measured mutual inductance in the volume of interest (Fig. 10).

As there are huge numbers of possible positions that will create the same mutual inductance between the receiver and the transmitter, to reduce the number of possible positions and find the real position of the receiver, the configuration of the transmitter is changed by switching off coil 1 and switching on coil 2.

The steps (6-9) are repeated for coil 2 to find all possible positions of receiver according to the measured mutual inductance between this coil, namely coil 2, and the receiver, (Fig. 11-a).

Based on the possible positions of the receiver due to the first and the second coil the answer which fulfills both constraints is retained. It represents their intersections. With such intersections the number of possible positions of the receiver is reduced as shown in Fig. 11-b.

For furthermore reducing the set of possible positions of the receiver, the configuration of antenna is changed again by switching on the third coil.

Following the same procedure, the number of possible solutions in each step is reduced again. Switching on/off all other coils is continued in sequence until a unique position is found. At this point the localization is performed with a defined accuracy depending on the volume grid.

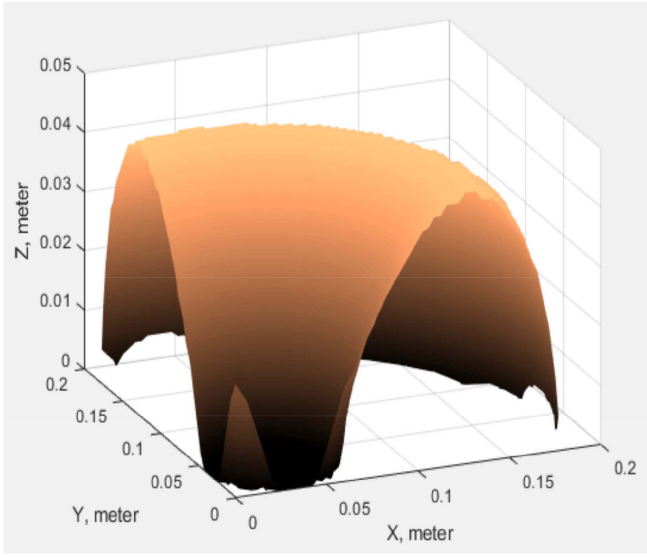

Fig. 10. The surface is the set of all possible locations of the center of the receiver which produces the measured mutual inductance between the receiver and the transmitter (for the sake of demonstration $M = 1$ nH is chosen) when the transmitter is consisting of coil number 1. There is an infinite number of positions (all points on the yellow-brown surface) which result in the same mutual inductance.

IV. EXPERIMENTAL RESULTS FOR LOCALIZATION

The volume of interest ($x = 20$ cm, $y = 20$ cm, $z = 10$ cm) is divided in a grid of points which are spaced by 1 mm each from other (1 mm³ precision in a volume of 4106 mm³). The mutual inductance between each transmitter coil and the receiver is predetermined if the receiver center was to be placed at any of these points. The receiver is a circular coil with 10 mm radius and 1 turn. The whole transmitter consists of 9 circular coils. Each coil is of 33 mm radius and 6 turns. The number of coils and the number of turns in each coil depend on the volume of interest to be covered and the expected accuracy to measure the input impedance of the transmitter. For example, it is necessary to make sure that the mutual inductance is high enough to be measured even if the receiver is situated at the frontier of the volume of interest. By increasing the number of turns, one actually increases the value of the mutual inductance leading to measurable values within the sensitivity of the measuring equipment. The coils are interconnected through switches. These experiments are a proof of concept showing the feasibility of the system rather than building a complete real system. Therefore, the choice was made to connect or disconnect the coils manually for each desired configuration. Table II shows the self-inductances and quality factors of the transmitter and the receiver, measured at 100 kHz (to avoid inter-turns capacitance influence at this step of the work).

The Unloaded Quality factor is defined as Eq. (4):

$$Q = \frac{\omega L}{R} \quad (4)$$

where Q is Unloaded Quality factor of coil, L is its self-inductance, R is its resistance and ω is the angular frequency of operation.

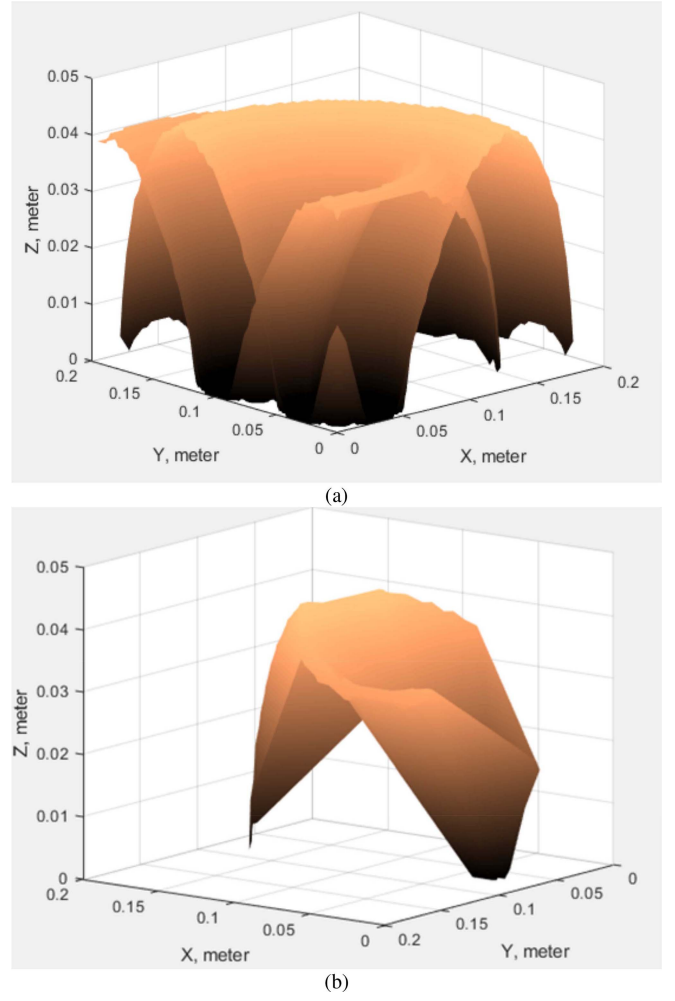

Fig. 11. (a) Two surfaces show all possible positions of receiver according to coil 1 and all possible positions of receiver according to coil 2. The real position of the receiver should belong to both these surfaces or their intersection. (b). Intersection of surfaces in (a). this new surface reduces highly the set of available positions in which the receiver really locates, but the answer still may not be unique.

TABLE II
SELF-INDUCTANCES AND QUALITY FACTORS OF THE TRANSMITTER AND THE RECEIVER

Symbol	Quantity	Value in SI
L1	Self-Inductance of 6 turns coil of radius 3.3 cm (TX)	4.58 uH
Q1	Unloaded Quality factor of TX at 100 kHz	29.39
L2	Self-Inductance of 1 turn coil of radius 1 cm (RX)	59.65 nH
Q2	Unloaded Quality factor of RX at 100 kHz	3.75

The input power level is fixed to 10 dBm. It is assumed that the time scale required to measure the input impedance of the transmitter in each configuration is much shorter than the time scale of the movement of the transmitter. The switching between different configurations and the measurement of

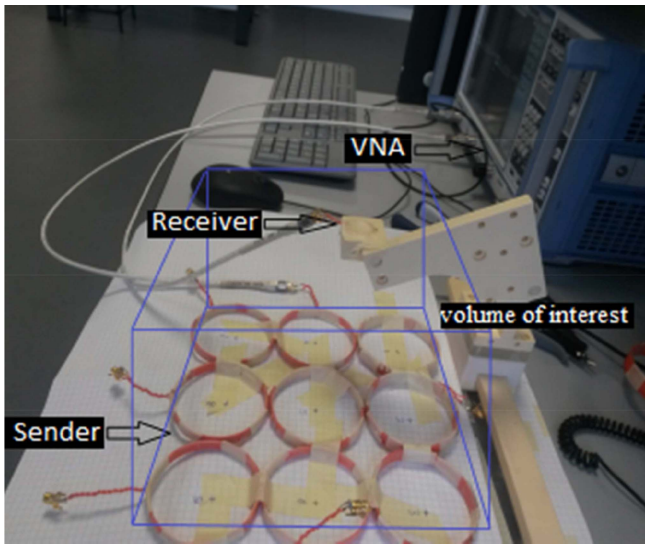

Fig. 12. The experimental setup for measurements. The imaginary blue box indicates the volume of interest.

input impedance in final design will be done electronically on a milliseconds scale which is much higher than general speed of the receiver in most application, like tags in RFID.

The receiver is placed in different positions into the volume of interest. Then the goal is to deduce its location depending on the measurement of the input impedance of the different coils of the transmitter. For experiments, a ROHDE & SCHWARZ ZNB 8 Vector Network Analyzer (VNA) is used to measure the scattering parameters. The measurement was always done at 100 kHz to avoid considering parasitic capacitance. The measured data were transferred to a computer running the MATLAB algorithm described earlier, then the deduced locations based on measured input impedances of the transmitter were compared to the real positions of the receiver to validate the proposed technique of localization. Fig. 12 shows the experimental setup used for measurements. The blue box in Fig. 12, indicates the volume of interest.

Table III shows the experimental results for three different locations of the receiver in the volume of interest. The origin ($x = 0, y = 0, z = 0$) is assigned to the lower left corner of the volume of interest. As one can see the results are very close to the real positions. For estimating the error, the mean absolute error (MAE) is used [26] according to equation (5):

$$MAE = \frac{\sum_{i=1}^n |y_i - x_i|}{n} \quad (5)$$

where the y_i is the measured value for position, x_i the real value for position and n is the number of samples. Depending on the precision of the grid in which the volume of interest is divided, the algorithm will take different time to accomplish it. In the experiments, the algorithm took between 2 and 6 seconds to accomplish all computations, which can be considered as real time system. A computer with 64 GB RAM and a CPU of 3.2 GHz was used. It should be mentioned that the accuracy of the measured input impedance plays an important role in the precision of the localization; the more accurate one could measure the input impedance the more precise one could localize. In addition, this method needs little data storing

TABLE III
EXPERIMENTAL RESULTS FOR THREE DIFFERENT LOCATIONS OF THE RECEIVERS IN THE VOLUME OF INTEREST

	The real position of the receiver	The deduced position of the receiver	MAE
Experiment 1	X=12 cm, Y=12 cm, Z= 4 cm	X= 11.97 cm, Y=12.06 cm, Z= 3.97 cm	4 mm
Experiment 2	X=6 cm, Y=5 cm, Z= 5 cm	X=5.9 cm, Y=5.07 cm, Z= 5 cm	3 mm
Experiment 3	X =3 cm, Y =14 cm, Z = 9 cm	X =2.9 cm, Y =13.9 cm, Z = 8.9 cm	1 mm

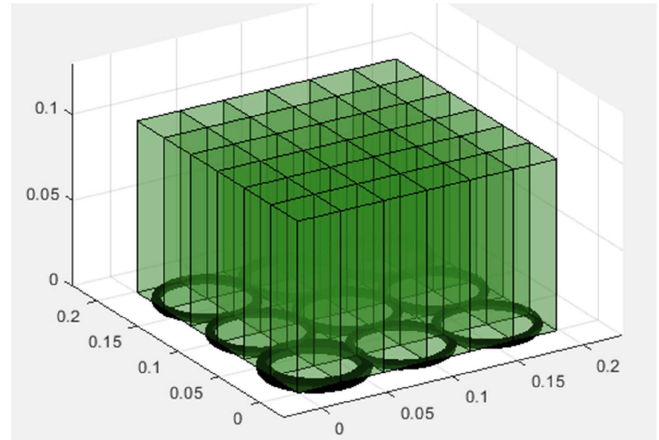

Fig. 13. The volume of interest is divided into sub volumes (green voxels). Depending on the result of localization of the receiver, a configuration of transmitter is selected corresponding to the magnetic fields that add constructively in a sub volume in which the receiver was found.

capability, because the data to be stored (which depends on the size of the volume of interest and the choice of spacing of points in 3D pre-computed matrix) for the practical system need not to be very large. In this study it was only 9 MB. The time necessary to localize the receiver coil also depends on the above parameters and for a practical system it could be short time. In this study it was a few seconds.

The algorithm cannot predict how many coils are necessary to determine uniquely the position of the receiver. However, it starts by taking the intersection between 2 coils, if the algorithm finds more than one position, it takes the intersection between 3 coils, and continuing until the detected position is unique. In present experimental work, if the intersection between all of the 9 coils is performed and the position is still not unique, the algorithm cannot localize the receiver. However, in the experiments, we never faced such situation, and 4 or 5 coils were always enough for tag localization.

V. REDIRECTING THE MAGNETIC FIELD BY CHANGING THE CONFIGURATION OF THE TRANSMITTER BASED ON THE LOCALIZED RECEIVER AND EXPERIMENTAL RESULTS

After performing localization, the obtained information about the position of the receiver could be used to enhance the performances of IPT systems by beamforming. Each coil of the grid of the transmitter could be excited individually by:

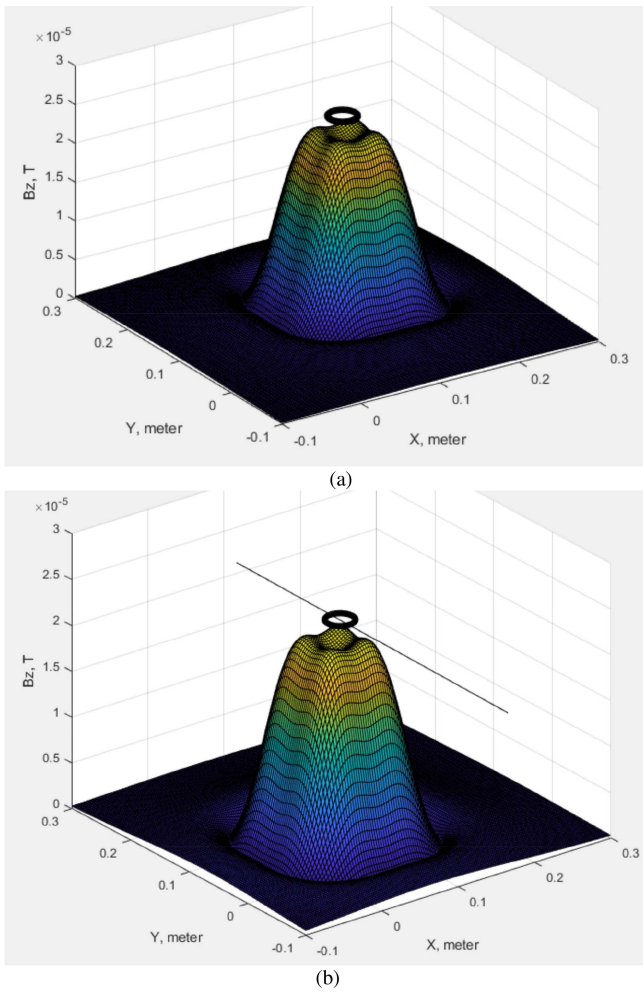

Fig. 14. Calculation for z component of the magnetic for two different configuration of the transmitter suitable for (a) when the receiver is at the position $X = 12\text{cm}$, $Y = 12\text{cm}$, $Z = 4\text{cm}$ and (b) when the receiver is at the position $X = 6\text{cm}$ and $Y = 5\text{cm}$, $Z = 4\text{cm}$. The maximum of the generated field (z component) takes place at the position of the receiver. The black line in (b) is used to indicate the path along which later measurement will be performed to compare the experimental results to the calculated results are performed.

- (1) applying current into them in clockwise direction.
- (2) applying current into them in anticlockwise direction.
- (3) they could be simply disconnected.

Those are the three possible excitations of each coil and if the grid of transmitter has N coils, the grid could be excited in 3^N different ways and each of these 3^N different excitations will create a different magnetic field pattern in the volume of interest. To choose one configuration amongst these 3^N possibilities, one easy way is to divide the volume of interest into a set of sub volumes as shown in Fig. 13.

The localization of the receiver performed previously helps to choose the configuration maximizing the magnetic flux in a sub volume in which the receiver is identified to be.

The proper excitation of the grid of transmitters that gives rise to an optimal magnetic field for each sub volume is pre-determined and stored in a table in the controlling system of the transmitter. Based on the result of the localization, now the transmitter knows in which sub volume the receiver is,

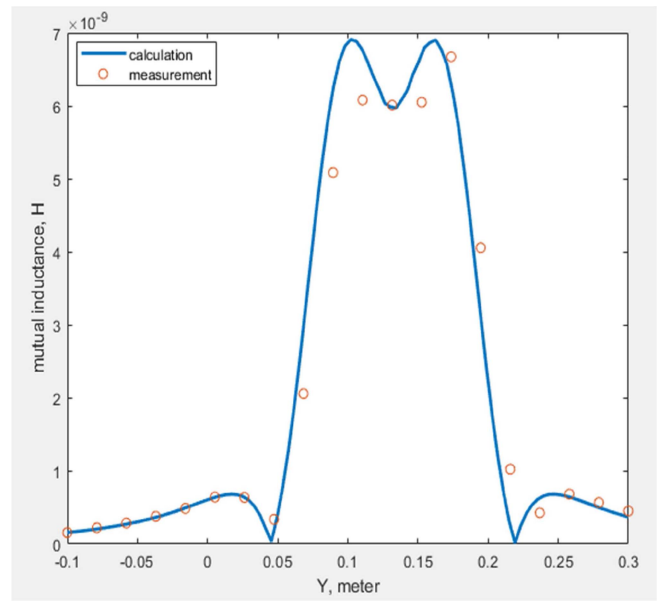

Fig. 15. Mutual inductance along the black line shown in Fig. (12-b). The mutual inductance increases where the receiver is positioned and falls down in other locations.

and from the stored table it can choose the configuration that creates the most suitable magnetic field.

Thus, the complete process for enhancing the magnetic coupling starts by the receiver being in localization mode. After the receiver is localized as explained in Section III, a configuration for exciting the transmitter grid is chosen which is suitable for the sub volume in which the receiver is found. Then the transmitter goes to power transferring mode.

For the experimental demonstration, the receiver was placed at different arbitrary positions. The goal is to control the direction of the magnetic field generated by the transmitter to add constructively in the position of the receiver. In one instance of previous section tests for localization, the receiver was at the position ($X = 12\text{ cm}$, $Y = 12\text{ cm}$, $Z = 4\text{ cm}$), with the system localizing it to be at the position ($X = 11.97\text{ cm}$, $Y = 12.06\text{ cm}$, $Z = 3.97\text{ cm}$), and in another instance, the receiver was at ($X = 6\text{ cm}$, $Y = 5\text{ cm}$, $Z = 5\text{ cm}$), with the system localizing it to be at the location ($X = 5.9\text{ cm}$, $Y = 5.07\text{ cm}$, $Z = 5\text{ cm}$).

For testing the beamforming performance of the system, these two points are chosen as the position of the receiver and the goal is to produce a magnetic field which is suitable for them by disconnecting the coils which are far away from the receiver and it just activates the coils close to the receiver with a current direction adapted to generate the appropriate magnetic field. For the moment the interest is just in the z component of the field because of the assumption that the receiver is in xy horizontal plane and only the z component contributes to the mutual inductance. Fig. 14 shows the calculation of the perpendicular z-component of magnetic field, for two different configurations, each one is suitable to one of the locations of the receiver, explained above. The configuration of the transmitter is different depending on the location of the receiver, in a way that it guarantees there is a sufficient mutual inductance between the transmitter and the receiver. It shows

that for two different positions of the receiver the peak of the field tracks the position of the receiver.

Fig. 15 shows the measured values for the mutual inductance for a configuration of transmitter compatible with the receiver located in ($X = 6$ cm, $Y = 5$ cm, $Z = 4$ cm). As one can see, the calculated and the measured values are close enough (the errors vary from 10 % at its maximum to a negligible value at its minimum) to show the applicability of the methodology for positioning and redirecting the magnetic field.

VI. CONCLUSION

In this work a new algorithm, to the best knowledge of the authors, was investigated for localization in near field suitable for inductive power transfer or other applications which are using IPT (like LF and HF RFID and NFC). Simulations were done by using a specific MATLAB code and its applicability was demonstrated by running a set of experiments.

The experimental results show that the algorithm operates as expected and it is possible to localize the receiver depending on its magnetic mutual coupling with the transmitter. If the same procedure is performed continuously, one could track dynamically the movement of the receiver. It was assumed that the receiver is in an unknown position but always parallel to the transmitter. This assumption was made for the sake of simplicity and does not affect the algorithm principle and utility. The algorithm could be modified for localizing a receiver in a more general situation in which the receiver could have any arbitrary orientation, and this modification will be addressed in the continuation of this work. After localization also it was shown how the knowledge about the receiver location could be used to enhance the magnetic coupling between the transmitter and the receiver: by means of a switchable grid of coils to steer the magnetic field properly towards the receiver. This beamforming approach allows to increase the mutual inductance between the transmitter and the receiver and to increase the efficiency of such inductive power transfer systems. The algorithm in its current state is capable of localizing one receiver in the volume of interest and could be improved to localize more than one receiver as another perspective of this work.

At the end, it should be mentioned that the aim of this work is to show the feasibility of the idea of using different mutual inductance between the receiver and different coils of transmitter for localization of the receiver. Measurements of the input impedances were completed by using an external VNA, having access to both the transmitter and the receiver as a two-port network. However, this is not a realistic scenario and in real world applications there is no access to the receiver. The next step of our work is to adapt the current algorithm to measure the mutual inductance between the transmitter and the receiver only by having access to the transmitter, which is the case in practice. In such one port- network configuration the resistance of the transmitter coil cannot be neglected as it was in the current two-port network study and it is currently being considered and tested again in this new configuration.

REFERENCES

- [1] C. R. Paul. (2010). *Inductance Loop and Partial*. [Online]. Available: <https://onlinelibrary.wiley.com/doi/book/10.1002/9780470561232>
- [2] M. Benamara *et al.*, "A twisted loop antenna to enhance HF RFID detection for different tag positioning," in *Proc. 10th Eur. Conf. Antennas Propag. (EuCAP)*, 2016, pp. 1–5.
- [3] J. Al Sinayyid *et al.*, "A reconfigurable antenna for enhancing the magnetic coupling in WPT," in *Proc. IEEE Wireless Power Transfer Conf.*, London, U.K., Jun. 2019, pp. 1–4.
- [4] M. Grzeskowiak *et al.*, "Distributed diameter subcoil twisted loop antenna in nonradiative WPT," *IEEE Antennas Wireless Propag. Lett.*, vol. 17, no. 1, pp. 4–7, Jan. 2018.
- [5] M. Grzeskowiak *et al.*, "Sub-coil in reader antenna for HF RFID volume detection improvement," in *Proc. IEEE Int. Conf. RFID Technol. Appl. (RFID-TA)*, Warsaw, Poland, 2017, pp. 134–139.
- [6] G. Deak, K. Curran, and J. Condell, "Review: A survey of active and passive indoor localisation systems," *Comput. Commun.*, vol. 35, no. 16, pp. 1939–1954, 2012, doi: [10.1016/j.comcom.2012.06.004](https://doi.org/10.1016/j.comcom.2012.06.004).
- [7] J. Mi and T. Yasutake, "Design of an HF-band RFID system with multiple readers and passive tags for indoor mobile robot self-localization," *Sensors*, vol. 16, no. 8, p. 1200, 2016.
- [8] P. Jankowski-Mihulowicz and M. Węglarski, "Interrogation zone determination in HF RFID systems with multiplexed antennas," *Archives Elect. Eng.*, vol. 64, no. 3, pp. 459–470, 2015, doi: [10.2478/ae-2015-0035](https://doi.org/10.2478/ae-2015-0035).
- [9] M. Y. Ahmad and A. S. Mohan, "Multiple-bridge-loop reader antenna for improved positioning and localisation," *Electron. Lett.*, vol. 48, no. 16, pp. 979–980, Aug. 2012.
- [10] M. Y. Ahmad and A. S. Mohan, "Novel bridge-loop reader for positioning with HF RFID under sparse tag grid," *IEEE Trans. Ind. Electron.*, vol. 61, no. 1, pp. 555–566, Jan. 2014.
- [11] J. Xiao, Z. Zhou, Y. Yi, and L. M. Ni, "A survey on wireless indoor localization from the device perspective," *ACM Comput. Surveys*, vol. 49, no. 2, 2016, Art. no. 25, doi: [10.1145/2933232](https://doi.org/10.1145/2933232).
- [12] K. Al Nuaimi and H. Kamel, "A survey of indoor positioning systems and algorithms," in *Proc. Int. Conf. Innov. Inf. Technol.*, Abu Dhabi, UAE, 2011, pp. 185–190.
- [13] X. Lu, P. Wang, D. Niyato, D. I. Kim, and Z. Han, "Wireless charging technologies: Fundamentals, standards, and network applications," *IEEE Commun. Surveys Tuts.*, vol. 18, no. 2, pp. 1413–1452, 2nd Quart., 2016, doi: [10.1109/COMST.2015.2499783](https://doi.org/10.1109/COMST.2015.2499783).
- [14] J. Li, F. Yin, L. Wang, B. Cui, and D. Yang, "Electromagnetic induction position sensor applied to anti-misalignment ireless charging for UAVs," *IEEE Sensors J.*, vol. 20, no. 1, pp. 515–524, Jan. 2020.
- [15] M. Y. Ahmad and A. S. Mohan, "Novel bridge-loop reader for positioning with HF RFID under sparse tag grid," *IEEE Trans. Ind. Electron.*, vol. 61, no. 1, pp. 555–566, Jan. 2014, doi: [10.1109/TIE.2013.2245617](https://doi.org/10.1109/TIE.2013.2245617).
- [16] D. Fortin-Simard, K. Bouchard, S. Gaboury, B. Bouchard, and A. Bouzouane, "Accurate passive RFID localization system for smart homes," in *Proc. IEEE 3rd Int. Conf. Netw. Embedded Syst. Every Appl. (NESEA)*, 2012, pp. 1–8, doi: [10.1109/NESEA.2012.6474010](https://doi.org/10.1109/NESEA.2012.6474010).
- [17] L. Yang, J. Cao, W. Zhu, and S. Tang, "Accurate and efficient object tracking based on passive RFID," *IEEE Trans. Mobile Comput.*, vol. 14, no. 11, pp. 2188–2200, Nov. 2015, doi: [10.1109/TMC.2014.2381232](https://doi.org/10.1109/TMC.2014.2381232).
- [18] B. Hou, B. Zhou, M. Song, Z. Lin, and R. Zhang, "A novel single-excitation capacitive angular position sensor design," *Sensors*, vol. 16, no. 8, p. 1196, 2016, doi: [10.3390/s16081196](https://doi.org/10.3390/s16081196).
- [19] K. Hwang, D. Kim, D. Har, and S. Ahn, "Pickup coil counter for detecting the presence of trains operated by wireless power transfer," *IEEE Sensors J.*, vol. 17, no. 22, pp. 7526–7532, Nov. 2017, doi: [10.1109/JSEN.2017.2754509](https://doi.org/10.1109/JSEN.2017.2754509).
- [20] G. Yang, M. R. V. Moghadam, and R. Zhang, "Magnetic beamforming for wireless power transfer," in *Proc. (ICASSP)*, 2016, pp. 3936–3940, doi: [10.1109/ICASSP.2016.7472415](https://doi.org/10.1109/ICASSP.2016.7472415).
- [21] S. Kisseleff, I. F. Akyildiz, and W. Gerstacker, "Beamforming for magnetic induction based wireless power transfer systems with multiple receivers," in *Proc. GLOBECOM*, 2015, pp. 1–7, doi: [10.1109/GLOCOM.2015.7417006](https://doi.org/10.1109/GLOCOM.2015.7417006).
- [22] A. P. Sample, D. T. Meyer, and J. R. Smith, "Analysis, experimental results, and range adaptation of magnetically coupled resonators for wireless power transfer," *IEEE Trans. Ind. Electron.*, vol. 58, no. 2, pp. 544–554, Feb. 2011, doi: [10.1109/TIE.2010.2046002](https://doi.org/10.1109/TIE.2010.2046002).
- [23] Y. Zhao, B. Mahoney, and J. R. Smith, "Analysis of a near field communication wireless power system," in *Proc. WPTC*, 2016, pp. 1–4, doi: [10.1109/WPTC.2016.7498827](https://doi.org/10.1109/WPTC.2016.7498827).

- [24] L. Catarinucci *et al.*, “Smart RFID antenna system for indoor tracking and behavior analysis of small animals in colony cages,” *IEEE Sensors J.*, vol. 14, no. 4, pp. 1198–1206, Apr. 2014, doi: [10.1109/JSEN.2013.2293594](https://doi.org/10.1109/JSEN.2013.2293594).
- [25] C. J. Willmott and K. Matsuura, “Advantages of the mean absolute error (MAE) over the root mean square error (RMSE) in assessing average model performance,” *Climate Res.*, vol. 30, no. 1, pp. 79–82, 2005, doi: [10.3354/cr030079](https://doi.org/10.3354/cr030079).
- [26] T. Lee, S. Huang, C. Tai, R. Chen, and B. Jiang, “Design of wireless power transfer for dynamic power transmission with position-detection mechanism,” in *Proc. IEEE Int. Conf. Ind. Technol. (ICIT)*, Seville, Spain, 2015, pp. 976–981.



Jaafar Al Sinayyid received the B.Sc. degree in computer communication engineering from Al-Mansour University, Baghdad, Iraq, and the M.Sc. degree in electronics engineering from ESIEE, Paris, France. He is currently pursuing the Ph.D. degree with the ESYCOM Laboratory, CNRS UMR 9007, University Gustave Eiffel, France. His research focuses on the wireless power transfer in near-field and RFID systems.



Hakim Takhedmit received the state engineering degree in electronics from the Ecole Nationale Polytechnique d’Alger, Algeria, in 2005, and the Ph.D. degree in electrical engineering from the Ecole Centrale de Lyon, France, in 2010. His Ph.D. dissertation dealt with the design and 3-D modeling by the finite-difference time-domain method of circuits and devices for wireless power transfer (WPT). He joined the ESYCOM Laboratory, CNRS UMR 9007, in 2010 and worked as a Research Assistant until 2013. He is currently an Associate Professor with

University Gustave Eiffel, France. His research focuses on the design, the modeling, and the experiments of antennas and circuits for RFID, energy harvesting, and WPT in near-field and far-field. He is also working on the power optimization of waveforms for the WPT but also for simultaneous wireless information and power transfer systems.



Patrick Poulichet received the degree in electrical engineering from CNAM, Paris, in 1998, and the Ph.D. degree in electrical engineering from the École Normale Supérieure de Cachan (SATIE CNRS UMR 8029) in 2001 for the simulation, design, and realization of a current sensor for power applications. In 1995, he joined the Electronic Department, ESIEE, Paris, as an Associate Professor, where he has been with the Department of Health, Energy, and Environment since 2018. He is a member of the ESYCOM Laboratory, CNRS UMR 9007,

University Gustave Eiffel, France. His research concerns portable NMR, integrated electronic for MEMS, dielectric absorption in microfluidic, RFID, WPT, and EMC.



Marjorie Grzeskowiak received the Ph.D. degrees in electronics and in microelectronics engineering from the Université des Sciences et Technologies de Lille, France, in 1999. In 2000, she joined the Electronic, Communication, Systems and Microsystems Laboratory, Université Paris-Est Marne-la-Vallée as an Associate Professor. Her research interests include antenna conception, millimeter-wave transmission lines and filters, and inductive coupling especially in applications to healthcare (ingestible capsule, surgical instrument traceability, and retinal implant). Since 2018, she has been an Associate Professor with the Institut Supérieur de l’Aéronautique et de l’Espace (ISAE-Supaero) and her research topics concern the interactions between plasma and microwave circuits to realize a plasma source by miniature inductive coupling and the design of antennas by additive fabrication for unmanned aircraft systems and drones.



Antoine Diet graduated in engineering from ESIEE Paris in 2001. He received the Ph.D. degree from the Université de Marne la Vallée (UMLV, Paris-Est), France, in 2005 in the domain of radio-electronics and telecommunications systems. He is currently an Associate Professor with Université Paris Saclay (past Univ. Paris Sud, IUT de Cachan, GEII) and performed his research from 2005 to 2014 in the Laboratoire des Signaux et Systèmes (L2S UMR8506) and since 2015 in the Groupe de recherche en genie électrique et électronique de Paris Saclay (GeePs UMR8507), where he is in charge of RFID/NFC activities. His research topics concern digital wireless architectures and antennas for wide-band/multiband communications, and magnetic coupling for RFID remote supplying and communication. He currently focuses on RFID/NFC applications in various environments, in near-field (LF and HF) and wireless sensors networks for biomedical applications.



Gaëlle Lissorgues received the degree in applied physics from the Ecole Normale Supérieure de Cachan, France, and the Ph.D. degree in electronics from University Paris VI in 1997, on laser range finding techniques. She gained expertise in MEMS, sensors, and microtechnology for telecommunications and RF applications while working as an Associate Professor with the ESIEE Paris Engineering School, Telecommunication Department from 1997 to 2006, and a member of the ESYCOM Laboratory. She prepared her

habilitation for Research (HDR), defended in 2006 from University Paris Est, and she joined the Electronics Department, ESIEE Paris in 2007 as a Full Professor. She created the Department of Health, Energy and Environment in 2012 at ESIEE Paris for engineering majors in energy efficiency and renewable energy on the one hand, biotechnology and e-health on the other hand. After 2007, she oriented her research activities toward MEMS for biomedical applications in the ESYCOM Team “Sensors for Health and Bio-interfaces” dedicated to MEMS for environment qualification (VOC detection, air quality, and e-nose approaches), MEMS for healthcare monitoring (innovative wearable physiological sensors), and implants for neurosciences (microelectrode arrays and retinal implants). She joined a team developing new sensor materials, including soft polymers, piezoelectric thin films, or diamond-based materials. She is involved in many EU and national funded projects related to smart integrated microsensors. She has supervised a large number of Ph.D. students and postdoctoral fellows (more than 20). She is the co-inventor of ten patents in the area of sensors, implantable medical devices, and microtechnology process. She was appointed as the Local Scientific Chair of the Eurosensors 2017 edition in Paris. She has been the Director of the Doctoral School MSTIC (Mathematics, Communication, and Computer Sciences), University Paris Est since January 2019.