



**HAL**  
open science

## **Cumulative effects of marine renewable energy and climate change on ecosystem properties: sensitivity of ecological network analysis**

Quentin Nogues, Aurore Raoux, Emma Araignous, Aurélie Chaalali, Tarek Hattab, Boris Leroy, Frida Ben Rais Lasram, Valérie David, François Le Loc'H, Jean-Claude Dauvin, et al.

### ► To cite this version:

Quentin Nogues, Aurore Raoux, Emma Araignous, Aurélie Chaalali, Tarek Hattab, et al.. Cumulative effects of marine renewable energy and climate change on ecosystem properties: sensitivity of ecological network analysis. *Ecological Indicators*, 2021, 121, pp.107128. 10.1016/j.ecolind.2020.107128 . hal-03070300

**HAL Id: hal-03070300**

**<https://hal.science/hal-03070300v1>**

Submitted on 15 Dec 2020

**HAL** is a multi-disciplinary open access archive for the deposit and dissemination of scientific research documents, whether they are published or not. The documents may come from teaching and research institutions in France or abroad, or from public or private research centers.

L'archive ouverte pluridisciplinaire **HAL**, est destinée au dépôt et à la diffusion de documents scientifiques de niveau recherche, publiés ou non, émanant des établissements d'enseignement et de recherche français ou étrangers, des laboratoires publics ou privés.

1 **Cumulative Effects of Marine Renewable Energy and Climate Change on Ecosystem**  
2 **Properties: Sensitivity of Ecological Network Analysis**

3  
4 Quentin Nogues<sup>1</sup>, Aurore Raoux<sup>1,2</sup>, Emma Araignous<sup>1,3</sup>, Aurélie Chaalali<sup>1</sup>, Tarek Hattab<sup>4,5</sup>, Boris  
5 Leroy<sup>6</sup>, Frida Ben Rais Lasram<sup>4</sup>, Valérie David<sup>7</sup>, François Le Loc'h<sup>8</sup>, Jean-Claude Dauvin<sup>2</sup>, Nathalie  
6 Niquil<sup>1</sup>.

7  
8 <sup>1</sup>Normandie Université, UNICAEN, Laboratoire Biologie des ORganismes et Ecosystèmes Aquatiques,  
9 FRE 2030 BOREA (MNHN, UPMC, UCBN, CNRS, IRD-207) CS 14032, 14000 Caen, France.

10 <sup>2</sup>Normandie Université, UNICAEN, UNIROUEN, Laboratoire Morphodynamique Continentale et  
11 Côtière, CNRS UMR 6143 M2C, 24 rue des Tilleuls, 14000 Caen, France.

12 <sup>3</sup>France Energies Marines ITE-EMR, 525 avenue Alexis de Rochon, 29280 Plouzané, France.

13 <sup>4</sup>Univ. Littoral Côte d'Opale, Univ. Lille, CNRS, UMR 8187 LOG, Laboratoire d'Océanologie et de  
14 Géosciences, F 62930 Wimereux, France.

15 <sup>5</sup>MARBEC, Université Montpellier, CNRS, Ifremer, IRD, Avenue Jean Monnet CS 30171, Sète 34203,  
16 France.

17 <sup>6</sup>Sorbonne Université, Laboratoire Biologie des ORganismes et Ecosystèmes Aquatiques, FRE 2030  
18 BOREA (MNHN, UPMC, UCBN, CNRS, IRD-207), 43 Rue Cuvier, CP26, 75005 Paris, France.

19 <sup>7</sup>Université de Bordeaux, CNRS, UMR 5805 EPOC, 2 Rue du Professeur Jolyet, 33120 Arcachon, France

20 <sup>8</sup>IRD, Univ Brest, CNRS, Ifremer, UMR 6536 LEMAR, F-29280 Plouzane, France.

21 \* Corresponding author: [quentin.nogues33@gmail.com](mailto:quentin.nogues33@gmail.com)

22 For submission to the journal: Ecological Indicators

23

24 **Abstract:**

25 In an increasingly anthropogenic world, the scientific community and managers have to take  
26 interactions between the drivers of ecosystems into consideration. Tools like ecological network  
27 analysis (ENA) indices offer the opportunity to study those interactions at the ecosystem level.  
28 However, ENA indices have never been used to test the incidence of cumulative drivers. The present  
29 study uses models combining the effects of (i) the reef caused by the future offshore wind farm of  
30 Courseulles-sur-Mer and (ii) climate change on species distribution, to test the response of multiple  
31 ENA indices. ENA indices proved sensitive to this cumulative impact, displaying a wide variety of  
32 cumulative effects. They were also very powerful to characterize the role of the cumulative impact  
33 on ecosystem functioning. These results demonstrate the capacity of ENA indices to describe and  
34 understand cumulative effects at the ecosystem scale. Using a sensitivity analysis approach, this  
35 study shows that ENA indices could be viable tools for managers. To help them in their tasks, the  
36 next step could be to link ecosystem services to ENA indices for a more practical use.

37 **Key words:** Cumulative impact, Linear inverse modeling, Marine Renewable Energies, Ecological  
38 Network Analysis, ENA food web.

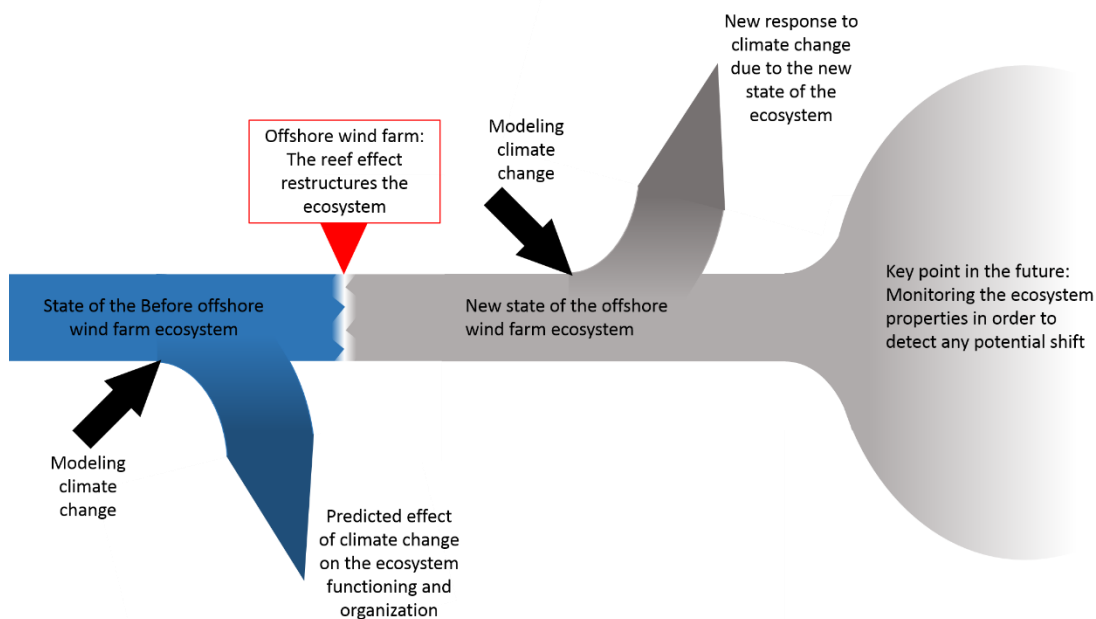

39

40 **Graphical abstract**

41 **1. Introduction**

42 The world is in constant evolution, and human activities have deeply changed the rate of this  
43 evolution (Halpern et al., 2008b). Due to constant human activity, ecosystem functioning can no  
44 longer be dissociated from the dynamics of anthropogenic activities (Vitousek et al., 1997). Although  
45 coastal ecosystems are already heavily stressed, they are going to be increasingly exploited owing to  
46 the ever-increasing human population and demand for resources (Halpern et al., 2015). The English  
47 Channel – an epicontinental sea – is considered as one of the most anthropized marine ecosystems in  
48 the world (Halpern et al., 2008b; Dauvin, 2019). It is subjected to multiple anthropogenic drivers such  
49 as marine transport, fishing, sediment dredging and aggregate extraction (Dauvin et al., 2004;  
50 Dauvin, 2019). It is also a hotspot for the future development of an offshore wind farm (OWF) in  
51 France (Pezy et al., 2020; Raoux et al., 2017). The effects of OWFs on ecosystems are divided in two  
52 phases: (i) the construction phase and (ii) the operational phase. The construction phase is  
53 characterized by short-lasting heavy disturbance (extreme noise from pile driving and vessels, cable-  
54 trenching disturbance), while the operational phase is associated to long-lasting effects on the  
55 environment (Hammar et al., 2014). One of the long-lasting effects of OWFs is the creation of new  
56 habitats and shelters for benthic and demersal species through the introduction of hard substrates in  
57 the surrounding soft substrate habitats (Wilhelmsson and Malm, 2008). The increased habitat  
58 heterogeneity can lead to changes in the abundance, biomass, and species richness of benthos and  
59 fish (Coates et al., 2014; Wilhelmsson et al., 2006), known as the reef effect. This reef effect is likely  
60 to be the main ecosystem effect of OWFs during the exploitation phase and can potentially affect the  
61 whole food web (Bergström et al., 2013). Only the exploitation phase is considered in this study, and  
62 the construction phase is ignored (De Mesel et al., 2015; Langhamer, 2012; Petersen and Malm,  
63 2006).

64 To help managers and decision-makers in their sustainable development mission, it is a priority to  
65 understand how OWFs act on ecosystem dynamics, which is mainly driven by trophic interactions  
66 between species. Trophic network modeling can help to study those interactions. In a network, a  
67 stimulus on one part of the model can cascade throughout the network. Trophic network modeling is  
68 therefore an interesting tool to understand how drivers act on the whole ecosystem.

69 To analyze how food webs are affected by drivers, Ulanowicz (1997, 2004) used ecological network  
70 analysis (ENA) indices. ENA indices can assess properties like the size, function or organization of a  
71 network through multiple metrics related to ecological processes, such as omnivory, recycling,  
72 overhead of flows (Borrett and Scharler, 2019; Heymans and Tomczak, 2016; Niquil et al., 2012a;  
73 Ulanowicz, 1986). These indices have been considered to be good potential indicators of the  
74 ecosystem health status and were thus cited by the OSPAR convention as promising indicators (Niquil

75 et al., 2014; De la Vega et al., 2018; Safi et al., 2019). They were subsequently employed to  
76 understand the effects of human activities (e.g., the extension of a harbor) on ecosystems (Tecchio et  
77 al., 2016), or even to develop different management scenarios (Heymans and Tomczak, 2016;  
78 Tomczak et al., 2013).

79 Raoux et al. (2017) explored a new way to look at the potential effects of OWFs through food web  
80 models and flow analysis. These authors implemented the Ecopath with Ecosim (EwE) approach  
81 (Christensen and Walters, 2004; Heymans et al., 2011; Polovina, 1984) to model the food web at a  
82 planned OWF (Courseulles-sur-mer, Bay of Seine, English Channel, France). One of their main results  
83 was that the total ecosystem activity, recycling, and the ecosystem maturity increased after OWF  
84 construction, due to the reef effect (Raoux et al., 2017, 2019). Results also indicated an anticipated  
85 increase in detritivory flows and an increased benthic fish biomass after OWF construction.

86 However, one of the main weaknesses of impact studies is that they focus on a single ecosystemic  
87 driver (Raoux et al., 2018), and ignore the other drivers of disturbance with long-lasting effects such  
88 as climate change (Hoegh-Guldberg and Bruno, 2010). The main issue when ignoring combined  
89 drivers is to miss cumulative effects that may alter the magnitude or direction of predicted changes  
90 (Breitburg et al., 1998; Vinebrooke et al., 2004; Fu et al., 2018; Planque et al., 2010). Hence,  
91 irrelevant or misleading recommendations can be issued when cumulative effects are not included  
92 (Halpern et al., 2008).

93 We propose to investigate the cumulative effects of climate change and one OWF using ecological  
94 network analysis on a food web model. To do so, we transformed the Raoux et al. (2017) Ecopath  
95 model of the future Courseulles-sur-Mer OWF into a Linear inverse model (LIM). We coupled this  
96 OWF LIM model with niche models of the Courseulles-sur-Mer ecosystem (Ben Rais Lasram et al.,  
97 2020) to study the effects of climate change on species. Several representative concentration  
98 pathway (IPCC 2014) scenarios were used to simulate changes in the bioclimatic niches of 72  
99 macrofauna species with dominant biomass within the trophic compartments of the food web.

100 We used those scenarios combining the effects of climate change and the OWF to compute a series  
101 of ENA indices to study the effects of each driver separately and then of the combined drivers on the  
102 food web of Courseulles-sur-Mer. We explored the capacities of ENA indices to study cumulative  
103 effects. Finally, we discussed the advantages and weaknesses of a framework based on ENA indices  
104 to investigate cumulative impacts and provide management recommendations.

105 **2. Materials and methods**

106 **2.1 Study area**

107 This study is focused on the area of the future OWF of Courseulles-sur-Mer (Normandy, France), that  
108 will be located in the lower middle part of the Bay of Seine (Figure 1). The bay opens onto the English  
109 Channel in its northern part, its depth is relatively shallow with a mean of 30 m at the future OWF  
110 location. The OWF area will cover 50 km<sup>2</sup>, and 64 offshore wind turbines are planned. The OWF will  
111 be built on coarse sand and sandy gravels harboring benthic communities of the Bay of Seine  
112 (Baffreau et al., 2017).

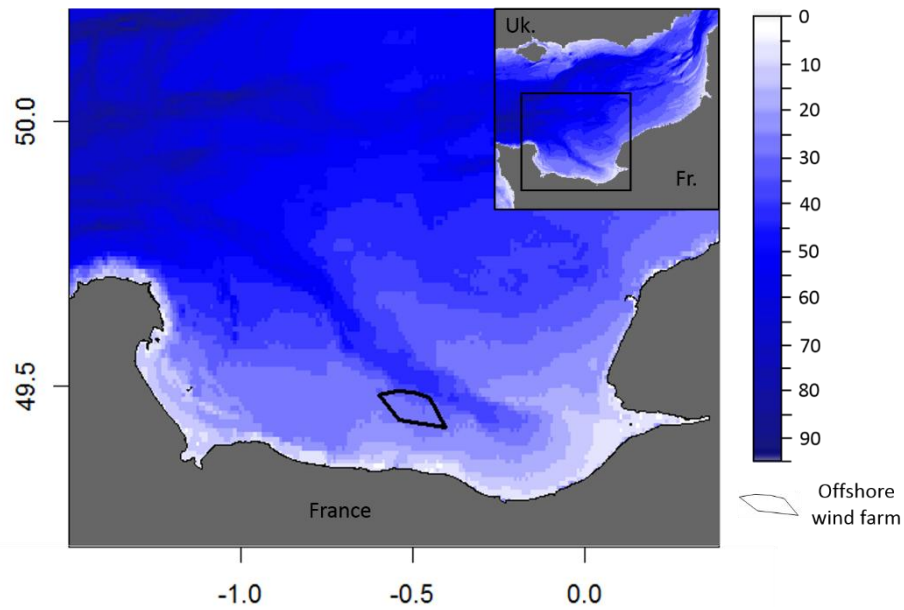

113

114 **Figure 1:** Localization of the future offshore wind farm of Courseulles-sur-Mer in the Bay of Seine.

115

## 116 2.2 Cumulative impact models

117 In order to test ENA indices in cumulative impact scenarios, we created trophic models based on two  
118 studies: (i) a trophic modeling of the expected reef effect caused by the future Courseulles-sur-Mer  
119 OWF (Raoux et al., 2017), and (ii) results from niche models simulating climate change (Ben Rais  
120 Lasram et al., 2020).

121

### 122 2.2.1 Wind farm effect on the food web

123 The construction of turbines and their associated scour protection creates new hard-substrate  
124 habitats and shelters such as artificial reefs. These new hard-substrate habitats increase habitat  
125 heterogeneity, leading to increased abundance, biomass, and species richness of the benthic  
126 macrofauna (e.g., the mussel (*Mytilus edulis*)) and of demersal fish (e.g., the pouting (*Trisopterus*  
127 *luscus*)) (Coates et al., 2014; Raoux et al., 2017; Wilhelmsson et al., 2006).

128 The reef effect of the future Courseulles-sur-Mer OWF was modeled using trophic network models  
129 quantifying the flows of energy between organisms, as described in Raoux et al. (2017). This trophic  
130 model was based on the Ecopath with Ecosim approach (Christensen and Walters, 2004; Polovina,  
131 1984). A first Ecopath model was built to model the ecosystem before the establishment of the OWF.  
132 Ecopath is a mass balance model, meaning that the sums of the inflows and outflows of the system  
133 are equal. It was used as a basis for an Ecosim model. Ecosim is a time dynamic model based on the  
134 mass balance Ecopath model (Pauly et al., 2000). It was used to model the reef effect of the future  
135 Courseulles-sur-Mer OWF and to create an Ecopath model 30 years from the OWF construction. Two  
136 Ecopath models were thus created: a baseline Ecopath model called BOWF (before offshore wind  
137 farm), and a model called REEF, based on the reef effect demonstrated to be the main long-term  
138 effect of the farm (Raoux et al., 2017). Both models were composed of the same 37 compartments of  
139 species, with similar trophic interactions (Leguerrier et al., 2003).

140 While the Ecopath approach is a well acknowledged mass balance approach, it can be criticized for its  
141 limitations in the modeling of low-trophic-level compartments – which are often subjected to high  
142 inter and intra year biomass variability – and because the method is based on a manual balancing  
143 procedure, which is not based on uncertainty evaluation of the input parameters. In order to take  
144 into account the uncertainty in the input parameters but also to define uncertainty in the outputs  
145 (flow values or ENA indices), another mass balance modeling approach is more suitable, i.e., the LIM  
146 linear inverse models, Monte Carlo Markov Chain or LIM-MCMC (N. Niquil et al., 2012; van Oevelen  
147 et al., 2010a). Linear inverse modeling relies on a set of linear equalities and inequalities to estimate  
148 unknown flows in food webs. The equalities set the mass balance of the model, while the inequalities

149 correspond to the confidence intervals of the measured flows. The Monte Carlo method is a sampling  
 150 procedure used to determine the complete coverage of the range of possible solutions. Which means  
 151 that while Ecopath only considers one value for each parameter/flow, LIM-MCMC integrates a range  
 152 of values to represent the variability of living organisms (Meersche et al., 2009; Niquil et al., 2012;  
 153 van Oevelen et al., 2010). This variability is also very useful to compare models statistically.

154 We thus used the BOWF and REEF Ecopath models of Raoux et al. (2017) and transformed them into  
 155 linear inverse models (LIMs). Four steps are necessary to create a LIM model, in which we  
 156 determined:

- 157 - The topology of the network based on the possible flows
- 158 - The mass balance equations
- 159 - The constraints of the model
- 160 - The computing parameters (jump and iterations).

161 Because the two Ecopath models used the same topology, we based our topology on them.  
 162 However, we had to reduce the number of biological compartments to shorten the computation  
 163 time. The number of compartments decreased from 37 to 19 (Figure 2, Table A.1), and aggregation  
 164 was based on the diet of each Ecopath compartment (Table A.1, A.3 & A.4; Leguerrier et al., 2003).  
 165 Keeping the same topology between the LIM BOWF model and the LIM REEF model allowed us to  
 166 compare the results of the two models free of any structural bias (Table A.3 & A.4).

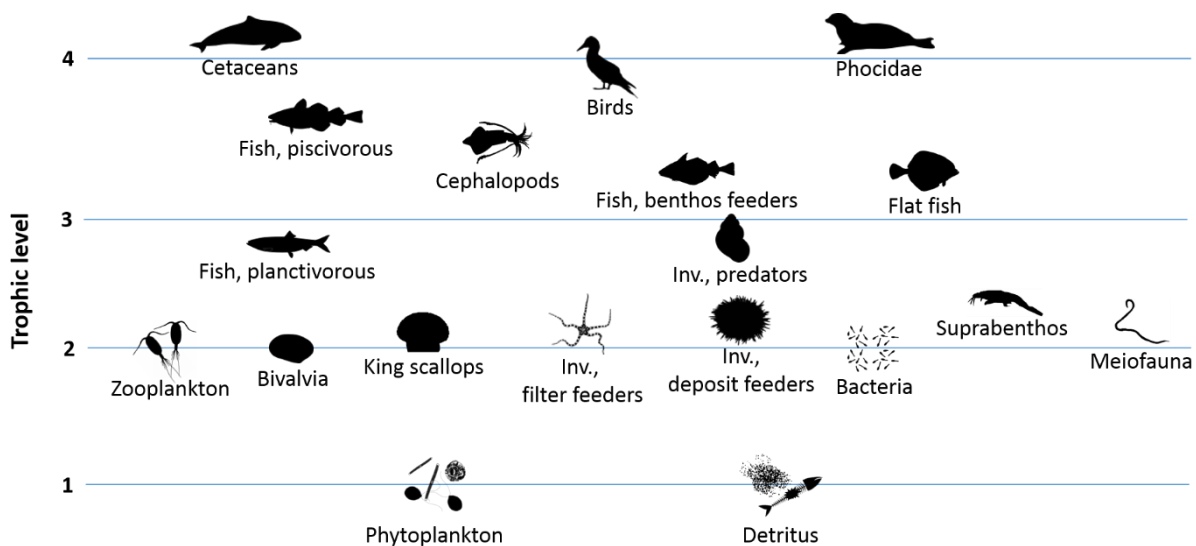

167  
 168 **Figure 2:** Functional compartments of the Courseulles-sur-Mer ecosystem model organized according  
 169 to their trophic level, based on the BOWF trophic levels.

170 We defined the mass balance equation for each compartment. In a mass balance equation, the input  
 171 of a compartment is equal to its output. The input is the consumption of the compartment, while the



172 output is the excretion, the respiration and the production of the compartment available for the  
173 system (predation).

174  $\text{Production (P)} = \text{consumption (Q)} - \text{excretion (U)} - \text{respiration (R)}$

175 Regarding the constraints of the model, we set minimum and maximum values for parameters such  
176 as the production to biomass ratio (P/B), the production to consumption ratio (P/Q), the respiration  
177 to consumption ratio (R/Q), and the excretion to consumption ratio (U/Q) (Table A.2). We used  
178 constraint values from the literature for some compartments, while others were computed with the  
179 Ecopath values and pedigrees. Pedigrees were used to define the uncertainty around the Ecopath  
180 values to determine minimum and maximum values (Table A.2). When the Ecopath values were  
181 considered very reliable ('Fish, planktivorous', 'Fish, benthos feeders', 'Fish, piscivorous' and 'Flat  
182 fish'), the uncertainty around the P/B, P/Q and U/Q values was set to 10 %. The diet constraints were  
183 calculated with the same method for all compartments of the models (BOWF and REEF). Finally, we  
184 added primary production values to drive the two LIM models: while the Ecopath model does not  
185 consider primary production values, the LIM model needs minimum and maximum values of  
186 potential primary production (Behrenfeld and Falkowski, 1997; Napoléon and Claquin, 2012).

187 The `xsample` function from the LIM package was used to compute the LIM models (van den  
188 Meersche et al., 2009). The LIM-MCMC model depends on two parameters for its computing: the  
189 jump and the number of iterations. With the equations and the constraints, the LIM MCMC model  
190 creates a polytope of solution that includes all the possible values for each flow of the system. The  
191 number of iterations indicates the number of solutions sampled in the space of solution. The mean  
192 distance between iterations is the jump. If the sampling goes outside the space of solution, it will  
193 bounce back (mirror technique) inside the space. A jump of  $0.05 \text{ gC.m}^{-2}$  and 500,000 iterations was  
194 chosen after testing the mean shifting value/variability of the biggest flows in order to properly  
195 sample solutions.

196

### 197 *2.2.2 Climate change simulation*

198 In order to assess cumulative impacts through a trophic modeling approach, we had to integrate the  
199 climate change effect in both LIM trophic models. To evaluate the effect of climate change, we used  
200 results from the niche models published in Ben Rais Lasram et al. (2020). Niche model algorithms are  
201 correlative approaches aimed at identifying the potential species niches by correlating species  
202 occurrences to environmental variables such as temperature, salinity or other parameters. Niche  
203 models were built with an ensemble modeling procedure combining different modeling techniques.

204 Future climate change projections for 72 species of the Bay of Seine were based on the “business as  
205 usual” representative concentration pathway scenarios (Intergovernmental Panel on Climate Change,  
206 RCP 8.5) at the 2091-2100 time steps (Ben Rais Lasram et al., 2020).

207 The compartments of the LIM trophic model were not all simulated in the niche model approach.  
208 Consequently, we focused on integrating the niche model results of the commercially exploited  
209 compartments, which included 4 fish compartments – Fish, benthos feeders (FBF); Flat Fish (FFI);  
210 Fish, Piscivorous (FPI); Fish, Planktivorous (FPL) – and 2 mollusk compartments – Cephalopods (CEP);  
211 King Scallop (KSC). Those compartments represented the compartments impacted by climate change.

212 To integrate the results of the niche models into the trophic models, we linked the evolution of the  
213 suitability index of the niche models to biomass according to Chaalali et al. (2016). We used the  
214 evolution of the suitability index C to multiply the biomass of the species by (1-C) to reflect the  
215 biomass changes:

$$C = \frac{P_{ref} - P_{rcp}}{P_{ref}}$$

216 where  $P_{ref}$  is the suitability index of the species in the current niche model and  $P_{rcp}$  the suitability  
217 index of the species in RCP 8.5.

218 As the production to biomass ratio (P/B) of fish is based on temperature (Lassalle et al., 2011), the  
219 P/B ratios of all the fish compartments impacted by climate change were modified following the  
220 temperature values of the RCP 8.5 scenarios (Table A.6). We used the temperature values  
221 corresponding to the habitats of each compartment (surface temperature for the pelagic  
222 compartments, sub-surface temperature for the benthopelagic compartments, and bottom  
223 temperature for the benthic and demersal compartments). In a mass balanced condition, the P/B  
224 ratio of fish species is considered to be equal to the instantaneous coefficient of total mortality (Z)  
225 (Figure 3):

$$Z = M + F$$

226 where M is natural mortality and F is fishing mortality, and M is calculated from the empirical  
227 equation:

$$M = K^{0.65} \times L_{\infty}^{-0.279} \times T^{0.463}$$

228 where K is the curvature parameter of the von Bertalanffy growth function (VBGF), while  $L_{\infty}$  is the  
229 asymptotic length and T the mean environmental temperature in °C depending of the depth.

230 We computed new P/B ratios by changing the temperature in the natural mortality equation (M)  
231 without changing fishing mortality (F) so as to be coherent. The evolution of natural mortality was

232 then applied to the P/B ratio of each fish compartment. If natural mortality increased by 10 % for a  
 233 fish species owing to the new temperature, we increased the P/B ratio of the species by 10 % in the  
 234 climate change scenario.

235 We had to use different methods for the Mollusk compartments. There was no equation connecting  
 236 the P/B ratio with temperature for cephalopods. We therefore used the cephalopod feeding rate  
 237 equation because of its link to temperature (O’Dor and Wells, 1987):

238

$$Feeding\ rate = 0.058 \times W^{0.79} \times 1.082^T$$

239

240 where W is the body mass in g and T is temperature in degrees Celsius.

241 We computed a new feeding rate for cephalopods with the niche model. The evolution of the  
 242 feeding rate between the current and the future RCP 8.5 temperatures allowed us to estimate the  
 243 P/B ratio of the cephalopod compartment. We used a food conversion rate of 30 % for cephalopods  
 244 (Boyle and Rodhouse, 2005).

245 For king scallops, we used the growth rate equation (Laing, 1999). The equation was verified by  
 246 comparing the temperature estimated from the RCP 8.5 scenarios with the temperature ranges  
 247 applied in growth experiments (Chauvaud et al., 2012; Laing, 2000). The temperature estimated with  
 248 the RCP model was sustainable by *Pecten maximus in situ* and *ex situ* (15.3°C), and resulted in  
 249 increased production:

$$Growth\ rate = 0.0199 \times T - 0.081$$

250 We thus changed the P/B ratio of the king scallop compartment according to the evolution of its  
 251 growth rate between the current temperature and the future temperature under the RCP 8.5  
 252 scenario.

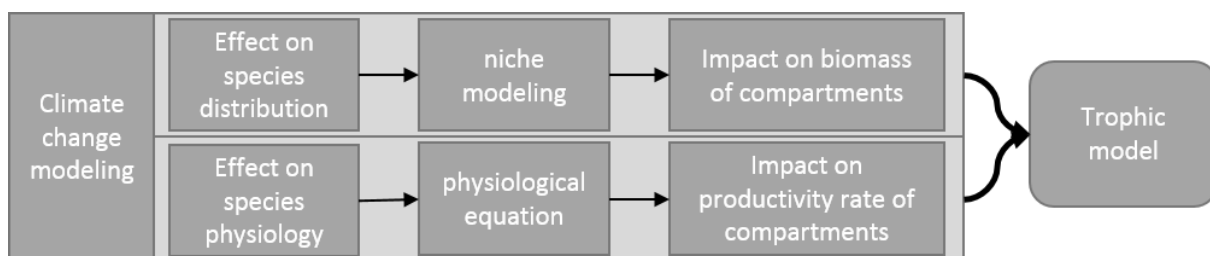

253

254 **Figure 3:** Schematic representation of the climate change modeling approach.

255 2.2.3 Ecological network analysis

256 With their 19 compartments each, the LIM models contained a flow matrix of 144 flows. We  
257 computed multiple metrics to analyze the ecological properties of each model. We first computed  
258 the throughflow/activity of (i) each compartment (sum of all the inflows/outflows) (Table A.1), (ii) the  
259 import (IMP), and (iii) respiration (RES) to understand the effects of the climate change and of the  
260 OWF at the flow matrix level. We also computed ENA indices (Table 1). ENA indices summarize the  
261 emergent properties of the ecosystem. A range of indices was chosen according to previous  
262 recommendations about their use by ecosystem managers (Fath et al., 2019; Safi et al., 2019).

263

264 **Table 1:** ENA indices computed with the LIM models results.

| Name  | Objective  | Calculation   | References   |
|---|--|---|--|
| Total activity of the system or Total System Throughput (T..) | The total system throughput is equal to the sum of all the flows in the system. It is a network level indicator of the size and activity of the system.              | $T_{..} = \sum_{i,j=1}^n T_{ij}$ <p>where <math>T_{ij}</math> is the flow between compartments <math>j</math> and <math>i</math>.</p>                                   | (Finn, 1976; Ulanowicz and Norden, 1990).            |
| Average Mutual Information (AMI)                              | Average mutual information measures the organization of a network, the more web-like the system is, the lower the AMI should be.                                     | $AMI = k \sum_{i=1}^{n+2} \sum_{j=0}^n \frac{T_{ij}}{T_{..}} \log_2 \frac{T_{ij} T_{..}}{T_i T_j}$  | (Gallager, 1968; Latham, 2006)                       |
| Ascendency (A)  | Ascendency is a measurement of the growth of the system, integrating its size (T..) and its organization (AMI).  | $A = \sum_{i=1}^{n+2} \sum_{j=0}^n T_{ij} \log_2 \frac{T_{ij} T_{..}}{T_i T_j}$ $A = AMI \times T_{..}$   | (Ulanowicz, 1980, 1986; Latham, 2006)                |
| Development capacity (DC)                                     | The total development capacity is the upper limit of ascendency, it represents the maximum development of the system.  | $DC = \sum_{i=1}^{n+2} \sum_{j=0}^n T_{ij} \log_2 \frac{T_{ij}}{T_{..}}$  | (Latham, 2006)                                       |
| Overhead (R)  | The overhead is the “reserve” of the system information and refers to the extent of parallel flows in the system   | $R = DC - A$  | (Ulanowicz et al., 2009; Ulanowicz and Norden, 1990) |
| Detritivory to herbivory ratio (D/H)                          | The detritivory to herbivory ratio is the ratio of detritus consumption (Detritivory) compared to the consumption of primary producers (Herbivory) in the ecosystem. | $D/H = \frac{(\sum DET)}{(\sum PP)}$ <p>where <math>DET</math> is the flow of detritus consumption and <math>PP</math> the flow of consumption by primary producers</p> | (Latham, 2006)                                       |

|   |  |  |                   |
|---|--|--|-------------------|
| System omnivory (SOI)                       | The system omnivory index quantifies the distribution of trophic interactions among different trophic levels.  | $OI_i = \sum_{j=1}^n [TL_j - (TL_i - 1)]^2 \times DC_{ij}$ $SOI = \frac{\sum_{i=1}^n [OI_i \times \log(Q_i)]}{\sum_{i=1}^n \log(Q_i)}$ <p>where TL is the trophic level of i or j.</p> | (Libralato, 2013) |
| Recycling index or Finn Cycling Index (FCI) | The recycling index is the fraction of energy recycled in the system.  | $FCI = \frac{TST_c}{TST}$ <p>where <i>TST</i> is the total system throughflow and <i>TST<sub>c</sub></i> the cycled total system throughflow.</p>                                      | (Odum, 1985)      |
| Mean Trophic Level (MTL)                    | The mean trophic level is the mean trophic level of the network's compartments. It is based on the compartments' trophic levels. Its values can be 1 (primary producers and detritus), 2 (all consumers), and can reach > 4 (top predators). | $MTL = \frac{\sum_i TL_i \times B_i}{\sum_i B_i}$ <p>where B is the biomass of i or j.</p>   | (Latham, 2006)    |

265

266 2.2.4 The different types of cumulative effects

267 Sixteen models were computed to test ENA indices in multiple scenarios. The models included:

- 268 - The reference BOWF model
- 269 - The REEF model
- 270 - The climate-change-only scenarios, based on the LIM BOWF model, with each of the selected
- 271 compartments impacted by the climate change effect and an extra model (BOWFTOT)
- 272 combining all the compartments impacted at once
- 273 - The cumulative impact scenarios, based on the LIM REEF model, with each of the selected
- 274 compartments impacted by the climate change effect and an extra model (REEFTOT)
- 275 combining all the compartments impacted at once.

276 Each model was named according to its initial model (BOWF or REEF) and to the name of the

277 impacted compartment if impacted by climate change (Figure 4).

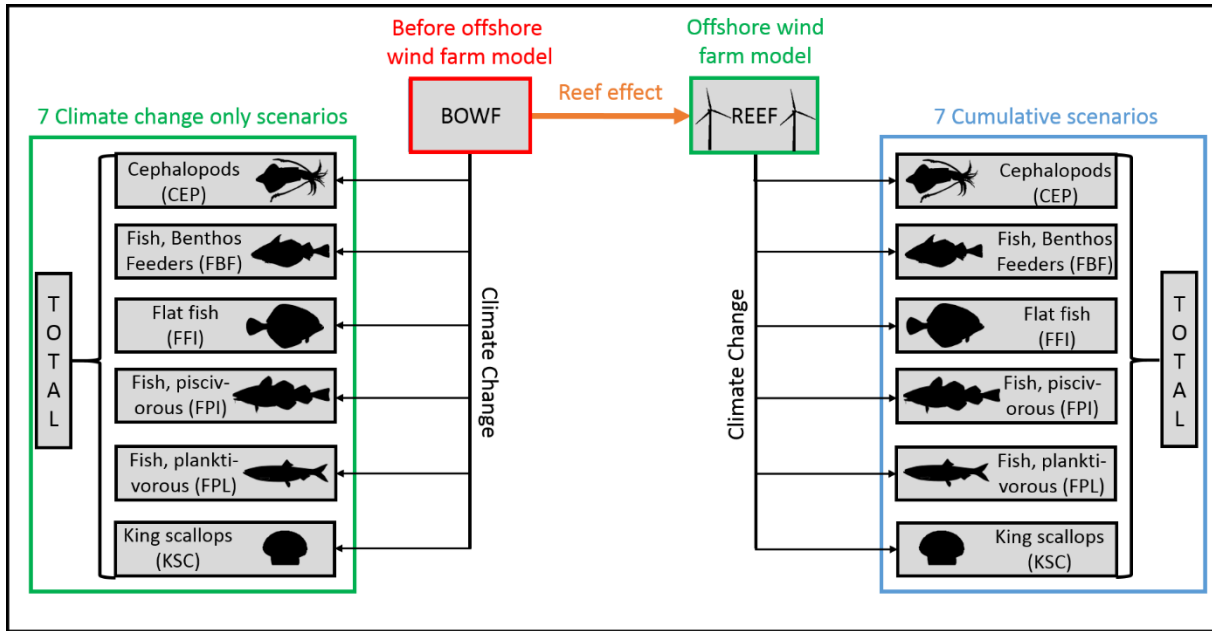

278

279 **Figure 4:** Modeling framework of the sixteen models all represented by gray boxes, with the initial  
 280 BOWF model, single effect models including seven climate change scenarios and the REEF model, and  
 281 the combined models including seven cumulative scenarios.

282 We followed this framework (Figure 4) to analyze the combined effects of climate change and of the  
 283 reef effect depending on the impacted compartment. We used the same methodology as Fu et al.  
 284 (2018) to characterize the combined effect on each ENA index and for each scenario.

285 First, we computed the relative index variation between the reference BOWF model and a single  
 286 effect model (reef effect only or climate change only) for each ENA:

$$\Delta I_k^{sep} = \frac{I_k - I_c}{I_c}$$

287 where  $I_c$  is the index value of the reference model and  $I_k$  the index value of a single-effect model (reef  
 288 only or CC only).

289 Then, we summed the variation ( $\Delta I_k^{sep}$ ) of each single effect in a same scenario to get the reef +  
 290 climate change additive effect:

$$\sum \Delta I_k^{sep}$$

291 We also computed the cumulative effect as the variation between the initial BOWF model and the  
 292 cumulative impact scenario (reef effect and climate change effect) for each ENA ( $\Delta I_k^{cum}$ ):

$$\Delta I_k^{cum} = \frac{I_k - I_c}{I_c}$$

293 To determine the combined effect, we compared the additive effect variation with the cumulative  
 294 effect variation. If the two variations were equal, the effect was considered additive:

$$\Delta I_k^{cum} = \sum \Delta I_k^{sep}$$

295 If the additive effect variation was lower than the cumulative effect variation and both variations  
 296 were positive or negative, the response was synergistic positive or negative:

297 Synergistic positive:  $\Delta I_k^{cum} > \sum \Delta I_k^{sep} > 0$

298 Synergistic negative:  $\Delta I_k^{cum} < \sum \Delta I_k^{sep} < 0$

299 If the additive effect variation was higher than the cumulative effect variation while both variations  
 300 were positive or negative, the response was dampened positive or negative.

301 If the additive effect variation was opposite to the cumulative effect variation, the response was  
 302 antagonistic. When the combined effect variation was positive, it was a positive antagonism, and *vice*  
 303 *versa* for negative antagonism (Figure 5).

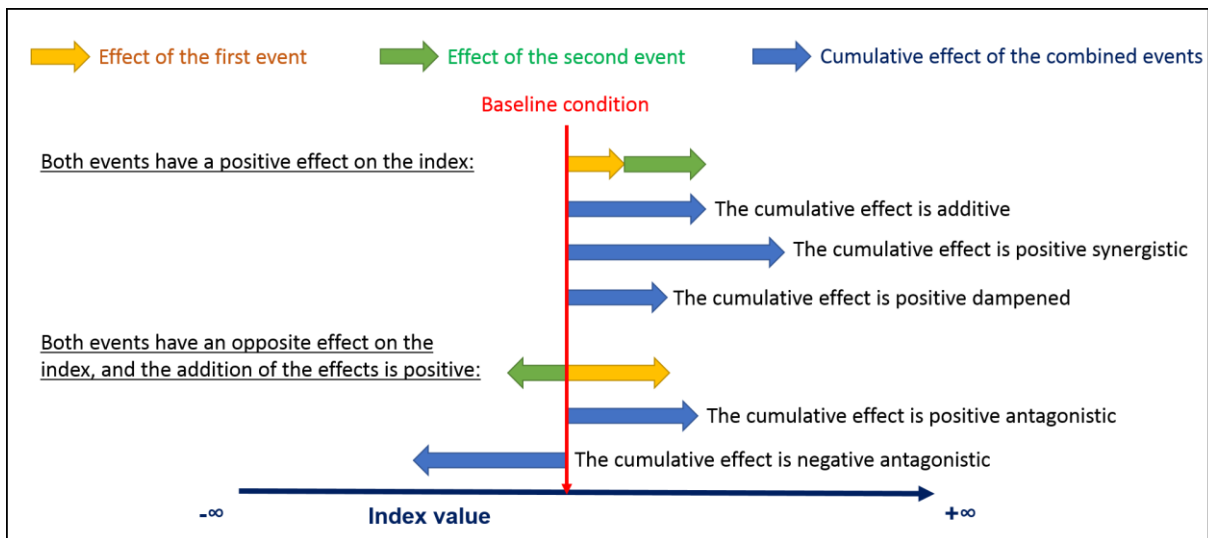

304  
 305 **Figure 5:** Different types of cumulative effects on the different index values (e.g., ENA index).

306 2.2.5. Statistical comparison

307 Indices were calculated for each solution of the LIM models (500,000 solutions quantifying each flow  
 308 for each model). A previous study showed that parametric tests like Student’s T-tests could identify  
 309 differences even for tiny effects (Tecchio et al., 2016). The non-parametric Cliff delta (Cliff, 1993) was  
 310 chosen for its better suitability (Valérie Girardin & Justine Lequesne, pers. com., Laboratoire de  
 311 Mathématiques Nicolas Oresme, Tecchio et al., 2016). The same threshold as Romano et al. (2006)



312 and MacBeth et al. (2012) was used considering the differences between the datasets: negligible if  
313 the Cliff delta ( $|\partial\text{Cliff}|$ ) was  $< 0.147$ , low if  $< 0.33$ , medium if  $< 0.474$ , or strong if  $> 0.474$ .

314 The Cliff delta was used to compare single effect models (“reef only” and “climate change only”  
315 scenarios) to the initial reference BOWF model and to compare the REEF model with the cumulative  
316 impact scenarios (reef effect + climate change effect). This was applied to the throughflow/activity  
317 (input/output) of each compartment as well as on the ENA. The delta also allowed us to compare the  
318 additive effect variation ( $\Delta I_k^{sep}$ ) with the cumulative effect variation ( $\Delta I_k^{cum}$ ). If the difference was  
319 considered medium ( $|\partial\text{Cliff}| < 0.33$ ), the cumulative effect was considered different than the  
320 additive effect. We determined the cumulative effect depending on the difference between the  
321 additive effect variation and the cumulative effect variation (Figure 5).

322 To reduce the number of models when describing the ENA indices, we used an average unweighted  
323 pair group method with arithmetic mean (UPGMA) based on Euclidean distance. The UPGMA  
324 compared all the different models according to their mean ENA values.

325

### 326 **3. Results**

327

#### 328 *3.1. Reef effect on the food web*

329 When the reef effect of the offshore wind farm was modeled in the LIM model, it resulted in an  
330 increased activity of the benthic compartment and in a decreased activity of the pelagic  
331 compartment. The reef effect also resulted in increased detritus consumption, increased  
332 phytoplankton activity and increased import (Figure 6).

#### 333 *3.2. Effects of climate change on the food webs before offshore wind farm construction*

334 When the BOWF models were impacted by the climate change scenarios, three compartments  
335 displayed a strong increase in activity and 11 displayed a strong decrease in activity. Throughout the  
336 compartments and scenarios, climate change had mainly a negative effect on compartment activity.  
337 Negative effects on activity can be divided into two types: (i) the direct effect of climate change on  
338 the targeted compartment (for instance, lower biomass of the cephalopod compartment in the  
339 cephalopod scenario leading to lower cephalopod activity), and (ii) the indirect / cascading effect of  
340 climate change on activity (lower biomass of the cephalopod compartment in the cephalopod  
341 scenario leading to lower cetaceous activity) (Figure 6).

#### 342 *3.3. Combined effects of climate change and of an offshore wind farm on the food web*

343 When the offshore wind farm (REEF) models were impacted by the climate change scenarios, 8  
344 compartments showed a strong increase in activity and 13 a strong decrease in activity. The REEF  
345 scenarios displayed greater changes due to climate change than the BOWF scenarios (38 strong  
346 variations in total for the REEF scenarios *versus* 30 for the BOWF scenarios), with a relatively more  
347 positive effect on activity. Similarly to the BOWF scenarios, the negative effects on activity were of  
348 two types: (i) the direct effects, and (ii) the indirect / cascading effects. While the direct effects of  
349 climate change appeared to be similar in the BOWF and REEF scenarios, the indirect / cascading  
350 effects were mostly different. There were four similarities between the BOWF and REEF models  
351 among the twenty indirect effects of climate change: (i) the indirect increase in invertebrate predator  
352 activity in the total scenario and the “fish, benthos feeders” scenario, (ii) the indirect decrease in  
353 phocidae activity in the total scenario and in the “fish, piscivorous” scenario, (iii) the indirect  
354 decrease in cetaceous activity in the total scenario and in the “fish, piscivorous” scenario, and (iv) the  
355 indirect decrease in import in the total scenario and the “fish, benthos feeders” scenario (Figure 6).

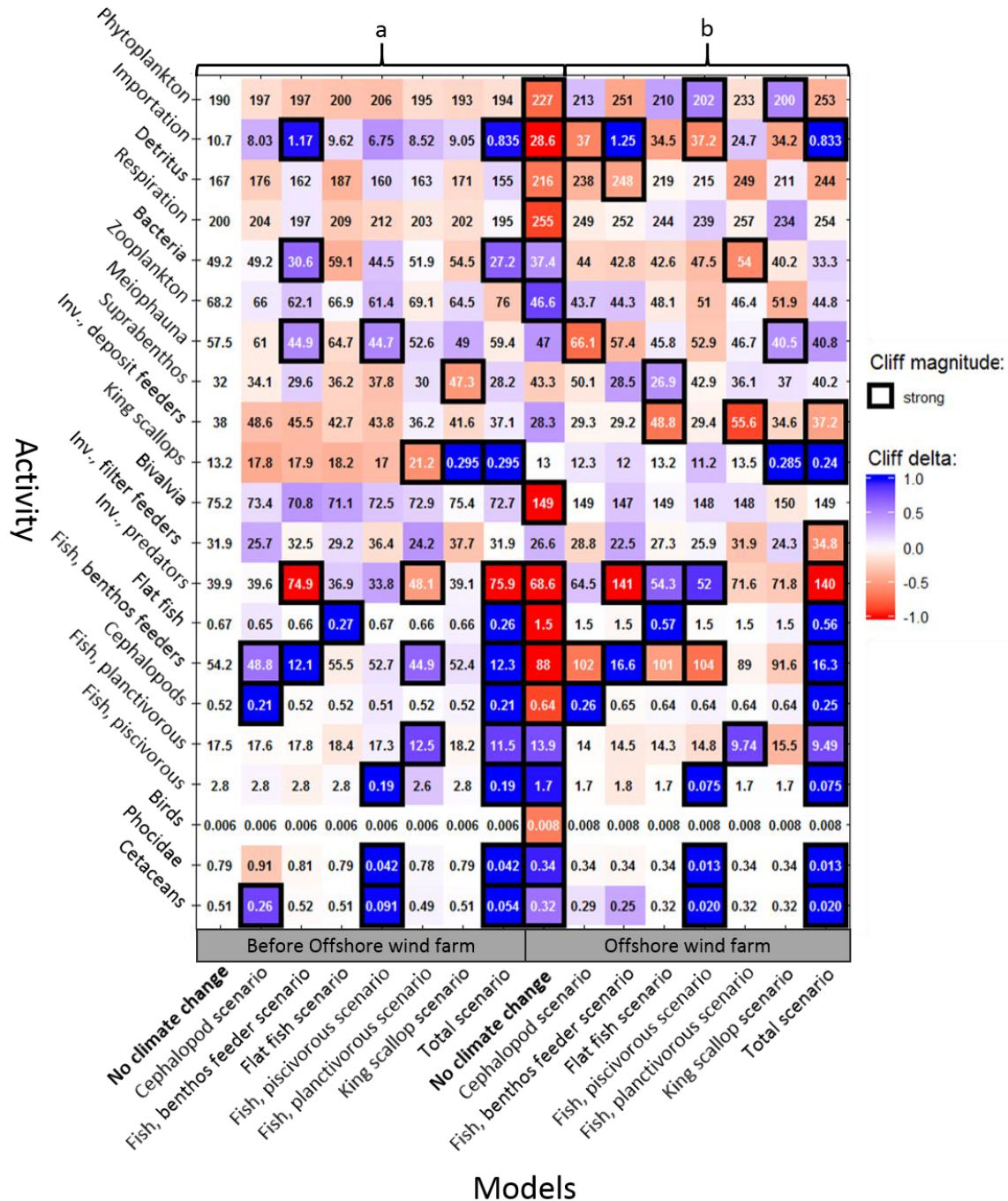

356

357 **Figure 6:** Variation of all the throughflow/activity (input/output) in gC.m<sup>2</sup> between: the BOWF model  
 358 and the single effect models (reef effect or climate change effect, a group on the left), and between  
 359 the REEF model and the cumulative models (reef effect + climate change effect, b group on the  
 360 right). Red, increased activity; blue, decreased activity; bold-bordered square, strong variation  
 361 according to the cliff delta ( $|\partial \text{Cliff}| < 0.474$ ).

362

363 3.4. Changes in the structure and functioning of the food web

364 The flow matrices were used to compute the ENA indices. The UPGMA discriminated five groups of  
 365 models. The models including the sole climate change effect and the BOWF model formed three  
 366 groups (with two groups composed of only one model). The models including the reef + climate  
 367 change effect formed two groups (Figure 7, A).

368 In both the BOWF and REEF scenarios, the “fish, benthos feeders” (FBF) scenario and the total (TOT)  
 369 scenario showed differences with the rest of the climate change scenarios (Figure 7, B). Those  
 370 models showed a greater number of strong differences ( $|\Delta\text{Cliff}| > 0,474$ ) with their respective  
 371 reference model compared to the other scenarios. Four strong differences were observed under the  
 372 BOWFTOT model compared to BOWF, six under BOWFFBF compared to BOWF, and three under  
 373 REEFTOT and REEFFBF compared to REEF.

374 The climate change effects on the “fish, benthos feeders” (FBF) scenario and the total (TOT) scenario  
 375 appeared as structuring as the REEF effect itself (Figure 7, A & B). The climate change effect strongly  
 376 impacted ( $|\Delta\text{Cliff}| > 0.474$ ) four indices of the total scenario and six of the “fish, benthos feeders”  
 377 scenario, while the reef effect strongly impacted six indices. The remaining climate change scenarios  
 378 had little effect on the system (Figure 7, B).

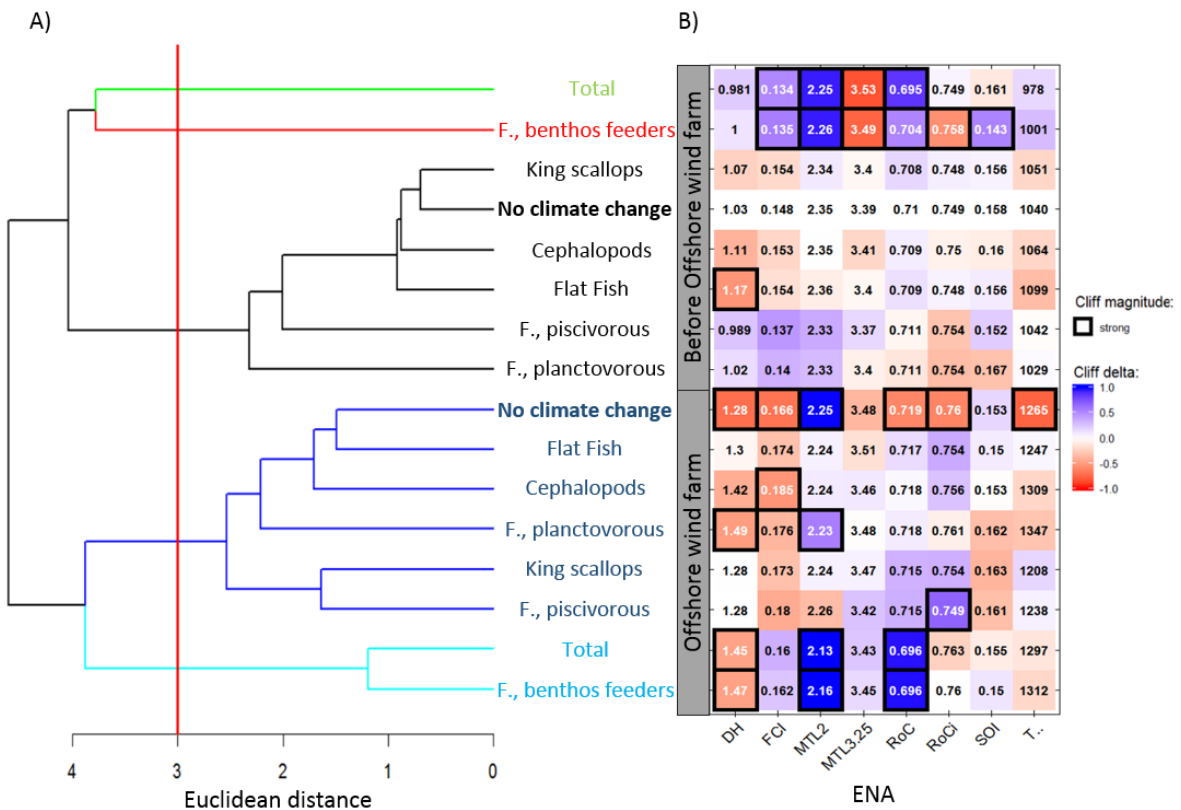

379

380 **Figure 7:** A) Following UPGMA to determine different groups of models, 5 groups were selected. B)  
 381 The Cliff delta was used to compare the ENA results of: the BOWF model and the single effect models  
 382 (reef effect or climate change effect), and between the REEF model and the cumulative models (reef  
 383 effect + climate change effect).

384

385 *6.3. Cumulative effects on ENA indices*

386 The cumulative impact assessment showed a wide variety of cumulative effects – additional,  
 387 synergetic, dampened, and antagonistic. Six of the seven scenarios showed at least one cumulative  
 388 effect on their ENA ( $0.33 < |\Delta\text{Cliff}|$ ). As for ENA indices, seven out of eight indices in total showed at  
 389 least one cumulative effect ( $\Delta\text{Iksep} \neq \Delta\text{Ikcum}$ ) (Figure 8).

390

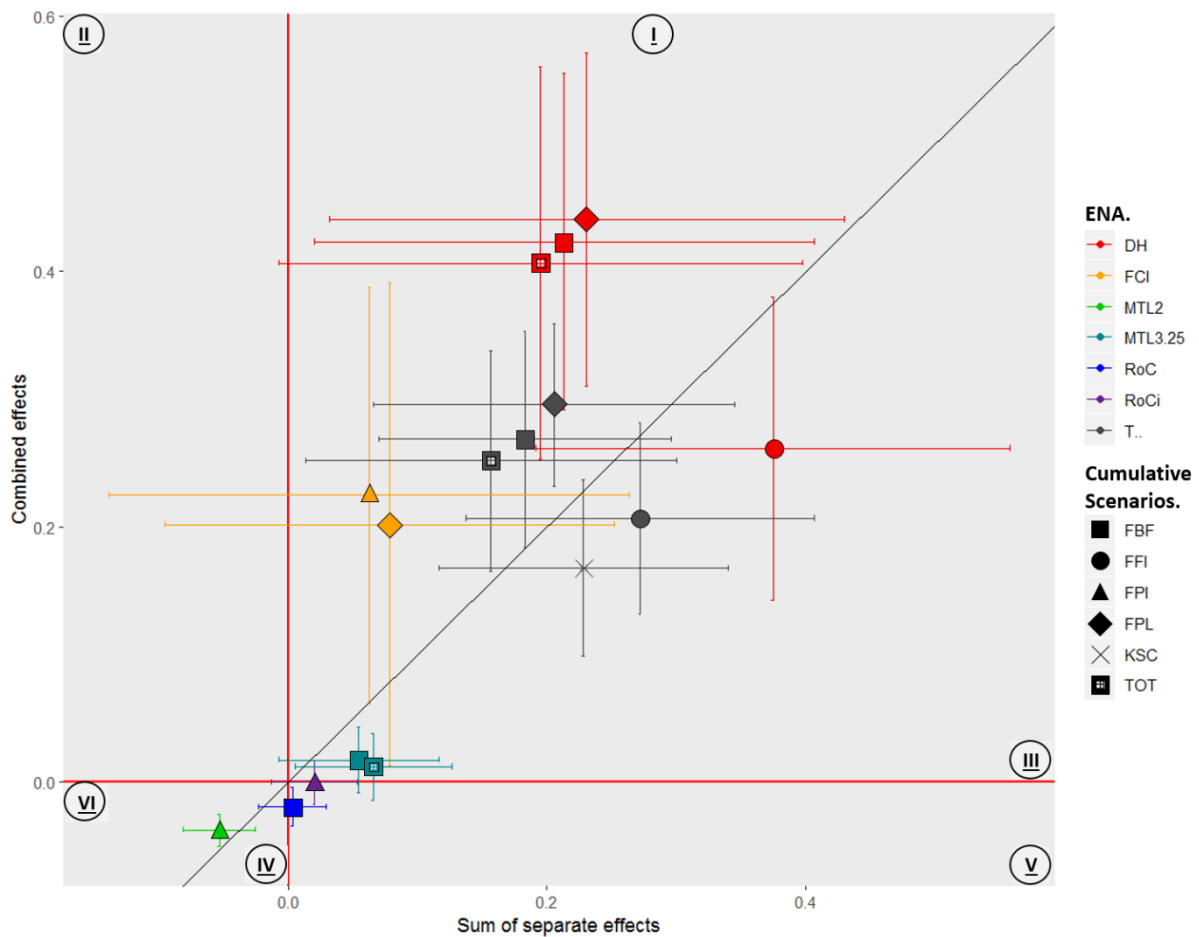

391

392 **Figure 8:** Cumulative effects of the different scenarios on multiple ENA indices (+/- SD). Each  
 393 cumulative effect is represented in a zone. Zone I, positive synergistic effect; zone II, positive

394 antagonistic effect; zone III, positive dampened effect; zone IV, negative synergistic effect; zone V,  
395 negative antagonistic effect; and zone VI, negative dampened effect.

396 Most of the cumulative effects were additive ( $\Delta I_{ksep} = \Delta I_{kcum}$ ) for all the results (all ENA indices for  
397 all models). Sixteen percent of the models showed a cumulative effect ( $\Delta I_{ksep}$  different from  $\Delta I_{kcum}$   
398 with  $|\partial Cliff| > 0.33$ ).

399

#### 400 **4. Discussion**

401 This study assesses the cumulative impacts of climate change and an OWF on the Bay of the Seine  
402 food web, based on LIM models. Because of the complexity of modeling climate change in its full  
403 extent (Larocque et al., 2011), this work was focused on the effect of climate change on the  
404 indigenous species of the bay, more particularly on commercially exploited species. That is why it is a  
405 sensitivity analysis of these cumulative impacts on ENA indices. First, our sensitivity analysis revealed  
406 that each effect taken separately had an impact on the functioning and organization of the  
407 ecosystem. The “fish, benthos feeders” compartment appeared particularly sensitive to the two  
408 single effects. When the effects were combined, we observed significant cumulative effects on  
409 multiple ENA indices for multiple scenarios. Those significant cumulative effects led to unexpected  
410 effects on the ecosystem. Overall, ENA indices appeared sensitive to the cumulative impact.

411

##### 412 *4.1. The structuring role of the reef effect*

413 The results of the REEF model seem to suggest a regime shifting towards a new stable state. An  
414 ecosystem shift is documented as a change at several trophic levels leading to ecosystem  
415 restructuring (Andersen et al., 2009; Lees et al., 2006). The restructuring of the system should be  
416 visible on the ecosystem structure but also on its functioning. The restructuring due to the reef effect  
417 was already predicted by Raoux et al. (2017; 2019) based on the evolution of the mean trophic level  
418 (MTL 2). We modeled a similar decrease in MTL 2 between the BOWF and REEF models. A decline in  
419 MTL 2 would explain a transition in the food web from long-lived high-trophic-level organisms like  
420 piscivorous fish towards short-lived low-trophic-level organisms such as invertebrates and  
421 planktivorous fish (Pauly et al., 1998). In the reef effect case, the biomass of the higher trophic level  
422 was not reduced, whereas the biomass of low-trophic-level organisms increased. Like Raoux et al.  
423 (2017; 2019), we consider this change as a restructuring of the community towards a new stable  
424 state rather than an unsustainable alteration of the ecosystem (Holling, 1996). We improved over  
425 Raoux et al. (2017; 2019) by also observing a change in the ecosystem’s functioning. This change was

426 noticeable through the different responses of the BOWF and REEF models to climate change. When  
427 we impacted the two models with the climate change scenarios, very few similarities between the  
428 BOWF response and the REEF response emerged. The differences in the cascading responses to  
429 climate change between the BOWF and REEF models may be explained by a shift in the system  
430 (Andersen et al., 2009; Lees et al., 2006). Our ENA results reflect a shift from a benthic-pelagic system  
431 towards a more benthic system. The system appeared more active with lower-trophic-level species  
432 relying less on herbivory and more on detritivory and recycling. Alongside the increase in redundant  
433 pathways, the system appeared more resistant to changes.

434 The ENA variations that we predicted between the BOWF model and the REEF model described a  
435 more resistant OWF system. Resistance is defined as the ability of a system to maintain its original  
436 state in a disturbed context as described by Holling (1996), and in accordance with 'ecological  
437 resilience' as described by Harrison (1979). Many ENA indices have been related to the notion of  
438 resistance. Lassalle et al. (2011) hypothesized that an increase in the detritivory to herbivory (D/H)  
439 rate was associated with a system more resistant to primary production variation. Recycling (FCI)  
440 may act as a buffer during disturbances and increase the resistance of the system (Saint-Béat et al.,  
441 2015). The overhead/redundancy of the flow (RoC and RoCi) may also act as a buffer during  
442 disturbances to maintain the system and thus increase its resistance (Ulanowicz and Norden, 1990).  
443 We predicted an increase of each of those indices (D/H, FCI, RoCi). Our results are less conflicting  
444 than the ones observed by Raoux et al. (2019) and describe a more coherent picture of the system,  
445 with benthic compartments playing a key role in the resistance of ecosystems (Norling and Kautsky,  
446 2007; Dame and Christian, 2007; Raoux et al. 2019; Wang et al. 2019).

447 The effect of climate change on the system also appeared to validate the more resistant state of the  
448 REEF model, especially on the "fish, benthos feeders" scenario (FBF). The BOWF model led to more  
449 changes in ENA indices than the REEF model: Its lower omnivory level (SOI) revealed a less complex  
450 system evolving from a web-like system towards a more linear system (Libralato, 2013). As the  
451 complexity of a system is an indicator of flexibility (Fagan, 1997; Lobry et al., 2008), we can expect a  
452 less stable and more vulnerable system. We also predicted that the system would lose part of its  
453 recycling capacity (FCI) and be less mature due to the lower redundancy of internal flows (RoCi)  
454 (Christensen, 1995; Odum, 1969; Ulanowicz, 2009; Ulanowicz and Norden, 1990). On the other hand,  
455 the only modeled effect of climate change on the "fish, benthos feeders" scenario of the REEF model  
456 was a higher detritivory to herbivory rate (D/H) of the system. As such, the reef effect seemed to  
457 increase the resistance of the system to climate change. However, one must not forget that these  
458 results depend on the way the climate change effect was modeled. The reef effect could also

459 promote other effects of climate change, like the establishment of invasive species (Langhamer,  
460 2012), but their study would need specific field experiments.

461

#### 462 *4.2. Role of the compartment impacted by climate change in the response of the ecosystem*

463 Our analysis of the different ENA responses showed a pattern segregating the responses of the  
464 scenarios depending on the compartment impacted by climate change. The “fish, benthos feeders”  
465 (FBF) and the total (TOT) climate change scenarios showed important estimated changes in their  
466 structure and functioning, while the other climate change scenarios seemed close to their reference  
467 model. This happened in both the BOWF and REEF models. In both cases, the “fish, benthos feeders”  
468 (FBF) and the total (TOT) climate change scenarios impacted the “fish, benthos feeders”  
469 compartment (FBF). This leads us to think that the importance of the “fish, benthos feeders”  
470 compartment isn’t defined by the aggregating role of the reef effect (Reubens et al., 2011), but  
471 rather by its position in the food web and thus its keystone-ness. The keystone-ness of a species  
472 defines its structuring role (Power et al., 1996; Libralato, 2019) and is not an intrinsic property of any  
473 given species (Fauth, 1999). The fact that the “fish, benthos feeders” compartment maintained its  
474 role despite the shift in the regime of the system might be due to the central position of its trophic  
475 niche in both systems.

476 The “fish, benthos feeders” (FBF) compartment seemed to play two roles in both models: first, it  
477 regulated the “invertebrates, benthic predators” compartment (IPR), and second, it ramified the  
478 system through its high omnivory. This was predicted when the “fish, benthos feeders” were  
479 impacted by the climate change effect (Figure 7). The trophic niche of the “fish, benthos feeders”  
480 was thus claimed by the “invertebrate, benthic predators”, and consequently changed the  
481 functioning of the food web. This result was different when considering the ecosystem shift caused  
482 by the reef effect: the “invertebrate, benthic predators” seemed more capable to replace the “fish,  
483 benthos feeders” in their niche. This replacement seemed to be facilitated by the shift of the  
484 ecosystem towards a more benthic system, in which the invertebrate benthic predators might be  
485 more successful in filling the same trophic role as the fish benthos feeders. As such, the system  
486 seemed less altered by the effect of climate change on the “fish, benthos feeders” scenario in the  
487 offshore wind farm system. However, we should remain careful because changing communities can  
488 have wider effects on the ecosystem likely to go undetected by trophic modeling approaches  
489 (Fontaine et al., 2011; Kéfi et al., 2015, 2012). As such, it is necessary to monitor such keystone  
490 species to maintain the ecosystem properties before, during and after the exploitation of the



491 offshore wind farm. Previous studies have indeed already highlighted the advantages of monitoring  
492 keystone species (Payton et al., 2002; Libralato et al., 2006; Gelcich et al., 2010).

#### 493 *4.3. Understanding the mechanism behind the unexpected effect of the cumulative impact*

494 Our scenarios show a wide variety of cumulative impacts, in line with previous studies that consider  
495 the additive effect to be the main type of combined effect in marine ecosystems, with a significant  
496 role of the cumulative impact on ecosystems (Crain et al., 2008). We evidenced synergetic and  
497 antagonistic effects, which proved the ability of ENA indices to reflect unexpected effects visible only  
498 when studying cumulative impacts (Jackson et al., 2001; Przeslawski et al., 2005). Cumulative impacts  
499 are often studied using community or population level metrics (Crain et al., 2008). By observing the  
500 same type of response with ENA, we demonstrate that cumulative effects are also significant at the  
501 functional level of the ecosystem. This is useful as it allows us to follow the properties of the  
502 ecosystem and its state in relation to the cumulated impact. Using functional metrics like ENA  
503 indicators might also help us better understand cumulative effects. This strengthens the importance  
504 of incorporating multiple scenarios of events in future ecological network analysis.

505 The strongest synergetic effect was predicted on the detritivory to herbivory (D/H) index of the “fish,  
506 benthos feeders” scenario (FBF). This synergistic effect seems to result from the shifting regime of  
507 the Courseulles-sur-Mer ecosystem. As the system shifted from a benthopelagic system to a more  
508 benthic system, the effect of climate change on the ecosystem functioning seemed to change (Figure  
509 7). In the BOWF model, the climate change effect on the fish benthos feeders resulted in an  
510 increased activity of the invertebrate benthic predators. This higher invertebrate benthic predator  
511 activity did not lead to an increase in detritivory because the system was not producing enough  
512 benthic detritus. Yet, this changed with the reef effect. As a system becomes more benthic, it  
513 produces more benthic detritus (Norling and Kautsky, 2008, 2007; Raoux et al., 2017). This increase  
514 in benthic detritus became available to the invertebrate benthic predators, and increased the  
515 detritivory to herbivory rate of the system. Many invertebrate benthic predators are indeed also  
516 scavengers. This changing response of the ecosystem to climate change due to the regime shift  
517 induced this unexpected effect on the detritivory to herbivory rate. This higher detritus consumption  
518 with the higher detritivory to herbivory rate of the OWF ecosystem resulted in a synergistic effect, as  
519 predicted by the “fish, benthos feeders” scenario (Table 2). An interaction between effects has  
520 already been shown to modify the effect of one or multiple events, e.g., in chemical reactions  
521 (Pelletier et al., 2006) and physiological/ecological reactions (Przeslawski et al., 2005; Christensen et  
522 al., 2006). We observed it at the functional level of the ecosystem. Integrating the evolving  
523 interactions between effects in a shifting ecosystem could help us better anticipate these effects. For

524 us to detect those shifts, monitoring the entire ecosystem using ecological network analysis is  
525 needed, using local and relevant data on all trophic levels (Araignous et al., 2019).

526 While two effects can interact with each other toward a synergistic effect, they may also interact  
527 negatively, with a resulting antagonistic or dampened effect. This was mainly modelled for the  
528 detritivory to herbivory rate of the “flat fish” scenario (Table 2). When considered independently, the  
529 climate change effect and the reef effect increased the detritivory to herbivory rate. However, when  
530 the effects were combined, the cumulative effect on the detritivory to herbivory rate was dampened.  
531 This could be explained by the fact that the regime shift made the ecosystem impervious to the  
532 climate change effect. This mechanism of resistance has already been acknowledged at the  
533 physiological level or at the population level (Vinebrooke et al., 2004). ENA proved able to do the  
534 same at the functional level of the ecosystem.

535 The regime shift due to the reef effect seemed to explain multiple cumulative effects. However,  
536 sometimes it was uncertain whether the cumulated effect resulted from the model structure or not.  
537 This was visible on the total overhead of the “fish, benthos feeders” scenarios. In this case, the  
538 dominating effect of climate change overcame the cumulative effect (Table 2). With the “fish,  
539 benthos feeders” compartment relying significantly on imports (like cetaceous, seals and birds), a  
540 reduction of its biomass will lower the import overhead. As the import overhead is a part of the total  
541 overhead (Ulanowicz and Norden, 1990), the total overhead will decrease even though the internal  
542 overhead remains unchanged. This could be the result of the model structure itself, as the  
543 dependency of the “fish, benthos feeders” compartment to import is mainly due to the reduced scale  
544 of the trophic model. Moreover, ENA indices are known to be potentially highly influenced by the  
545 model structure (Baird et al., 2009; Johnson et al., 2009). The lower import overhead could also be  
546 the sign of a more isolated system compared to the rest of the English Channel ecosystem (Baird and  
547 Ulanowicz, 1993).

548

549

550 **Table 2:** Representation of the different mechanisms of the cumulative effects based on the LIM  
 551 model results.

| Scenario                    | ENA index                         | Climate change effect alone | Reef effect alone | Combined effects | Type of cumulative effect | Mechanism   |
|-----------------------------|-----------------------------------|-----------------------------|-------------------|------------------|---------------------------|---|
| Fish, benthos feeders (FBF) | Detritivory to herbivory (D/H)    | +                           | +                 | ++++             | Positive synergistic      | <b>Interaction</b> between the two effects due to the <b>regime shift</b> caused by the reef effect.                      |
| Fish, piscivorous (FPI)     | Internal relative overhead (RoCi) | +                           | +                 | -                | Negative antagonistic     | <b>Interaction</b> between the two effects due to the <b>regime shift</b> caused by the reef effect.                      |
| Flat fish (FFI)             | Detritivory to herbivory (D/H)    | +                           | +                 | +                | Positive dampened         | <b>Resilience</b> of the ecosystem to the climate change effect due to the <b>regime shift</b> caused by the reef effect. |
| Fish, benthos feeders (FBF) | Relative overhead (RoC)           | -                           | ++                | --               | Negative antagonistic     | The climate change effect <b>overpowers</b> the reef effect.  |

552

553 *4.4. Ecological network analysis indices: sensitive tools to manage the cumulative impact of the*  
 554 *REEF and climate change effects.*

555 Using a single ENA index to describe a changing system is not suitable to describe a changing  
 556 ecosystem; a larger pool of indices is more adapted to reach an overall picture of the ecosystem  
 557 organization and functioning (de la Vega et al., 2018). The same is true for combined impacts, which  
 558 make it possible to predict different types of cumulative effects for different parameters of the  
 559 ecosystem. While an index can describe a synergetic effect of the combined reef and climate change  
 560 effects, another index may describe an antagonistic effect. This point should be emphasized when  
 561 working on a limited number of indices, as multiple indices can be impacted differently. Interactions  
 562 between events thus appear to be radiative – not unidirectional –, i.e., different properties of an  
 563 ecosystem can evolve in different ways. This emphasizes the need for complementary indices to  
 564 provide a holistic view of the ecosystem (Fath et al., 2019; Safi et al., 2019), especially while  
 565 addressing the effect of cumulative impacts.

566 Ecological network analysis indices seem to be suitable for addressing a wide range of cumulative  
567 effects. Along with an integrative approach, this ability to study cumulative impacts in their overall  
568 diversity makes ENA indices the ideal ecological indicators necessary for the future of ecological  
569 science and management (de la Vega et al., 2018; Fath et al., 2019; Safi et al., 2019). It is now time to  
570 implement those indices in more complex cumulative impact scenarios to describe the mechanisms  
571 behind cumulative impacts.

572

### 573 **Acknowledgements**

574 This work was funded by the Normandy Region (RIN Trophi-Service project), and was part of the  
575 TROPHIK project, which benefited from France Energies Marines and State financing managed by the  
576 National Research Agency under the Investments for the Future program (reference ANR/FEM EMR-  
577 ITE ANR-10-IED-0006-12). NN, EA, FBRL and FFL are also supported by the APPEAL project (ANR- 10-  
578 IED-0006-25). We also thank for their help in compiling the datasets and for giving expert advice  
579 Jeremy Lobry, Géraldine Lassalle, Mathilda Haraldsson and Maud Thermes and all the partners and  
580 collaborators of the TROPHIK project for their help in compiling the datasets and for giving expert  
581 advice. We thank Annie Buchwalter for English correction.

582

583

584 **References**

- 585 Andersen, T., Carstensen, J., Hernández-García, E., Duarte, C.M., 2009. Ecological thresholds and  
586 regime shifts: approaches to identification. *Trends Ecol. Evol.* 24, 49–57.  
587 <https://doi.org/10.1016/j.tree.2008.07.014>
- 588 Araignous, E., Beaugrand, G., Ben Rais Lasram, F., Bourdaud, P., Champagnat, J., Dauvin, J.-C.,  
589 Grangeré, K., Halouani, G., Haraldsson, M., Hattab, T., Le Loc'h, F., Leroy, B., Lejart, M., Niquil,  
590 N., Nogues, Q., Pagot, J.-P., Raoux, A., Safi, G., Villanueva, C., 2019. Recommandations pour une  
591 approche écosystémique des aires d'implantation d'énergies marines renouvelables : Cas  
592 d'étude du parc éolien offshore de Courseulles-sur-mer. Plouzané.
- 593 Baffreau, A., Pezy, J.-P., Dancie, C., Chouquet, B., Hacquebart, P., Poisson, E., Foveau, A., Joncourt, Y.,  
594 Duhamel, S., Navon, M., Marmin, S., Dauvin, J.-C., 2017. Mapping benthic communities: An  
595 indispensable tool for the preservation and management of the eco-socio-system in the Bay of  
596 Seine. *Reg. Stud. Mar. Sci.* 9, 162–173. <https://doi.org/10.1016/j.rsma.2016.12.005>
- 597 Baird, D., Fath, B.D., Ulanowicz, R.E., Asmus, H., Asmus, R., 2009. On the consequences of  
598 aggregation and balancing of networks on system properties derived from ecological network  
599 analysis. *Ecol. Modell.* 220, 3465–3471. <https://doi.org/10.1016/j.ecolmodel.2009.09.008>
- 600 Baird, D., Ulanowicz, R.E., 1993. Comparative study on the trophic structure, cycling and ecosystem  
601 properties of four tidal estuaries. *Mar. Ecol. Prog. Ser.* 99, 221–237.  
602 <https://doi.org/10.3354/meps099221>
- 603 Behrenfeld, M.J., Falkowski, P.G., 1997. Photosynthetic rates derived from satellite-based chlorophyll  
604 concentration. *Limnol. Oceanogr.* 42, 1–20. <https://doi.org/10.4319/lo.1997.42.1.0001>
- 605 Ben Rais Lasram, F., Hattab, T., Noguès, Q., Beaugrand, G., Dauvin, J., Halouani, G., Le Loc'h, F.,  
606 Niquil, N., Leroy, B., 2020. An open-source framework to model present and future marine  
607 species distributions at local scale. *Ecol. Inform.* 101130.  
608 <https://doi.org/10.1016/j.ecoinf.2020.101130>
- 609 Bergström, L., Sundqvist, F., Bergström, U., 2013. Effects of an offshore wind farm on temporal and  
610 spatial patterns in the demersal fish community. *Mar. Ecol. Prog. Ser.* 485, 199–210.  
611 <https://doi.org/10.3354/meps10344>
- 612 Borrett, S.R., Scharler, U.M., 2019. Walk partitions of flow in Ecological Network Analysis: Review and  
613 synthesis of methods and indicators. *Ecol. Indic.* 106, 105451.  
614 <https://doi.org/10.1016/j.ecolind.2019.105451>
- 615 Boyle, P., Rodhouse, P., 2005. *Cephalopods: Ecology and Fisheries*. Wiley.  
616 <https://doi.org/10.1002/9780470995310>
- 617 Breitburg, D.L., Baxter, J.W., Hatfield, C.A., Howarth, R.W., Jones, C.G., Lovett, G.M., Wigand, C.,  
618 1998. Understanding Effects of Multiple Stressors: Ideas and Challenges. *Successes, Limitations,*  
619 *Front. Ecosyst. Sci.* 416–431. [https://doi.org/10.1007/978-1-4612-1724-4\\_17](https://doi.org/10.1007/978-1-4612-1724-4_17)
- 620 Chaalali, A., Beaugrand, G., Raybaud, V., Lassalle, G., Saint-Béat, B., Le Loc'h, F., Bopp, L., Tecchio, S.,  
621 Safi, G., Chifflet, M., Lobry, J., Niquil, N., 2016. From species distributions to ecosystem  
622 structure and function: A methodological perspective. *Ecol. Modell.* 334, 78–90.  
623 <https://doi.org/10.1016/j.ecolmodel.2016.04.022>
- 624 Chauvaud, L., Patry, Y., Jolivet, A., Cam, E., Le Goff, C., Strand, Ø., Charrier, G., Thébault, J., Lazure, P.,  
625 Gotthard, K., Clavier, J., 2012. Variation in size and growth of the Great Scallop *Pecten maximus*  
626 along a latitudinal gradient. *PLoS One* 7, 6–15. <https://doi.org/10.1371/journal.pone.0037717>

- 627 Christensen, M.R., Graham, M.D., Vinebrooke, R.D., Findlay, D.L., Paterson, M.J., Turner, M.A., 2006.  
628 Multiple anthropogenic stressors cause ecological surprises in boreal lakes. *Glob. Chang. Biol.*  
629 12, 2316–2322. <https://doi.org/10.1111/j.1365-2486.2006.01257.x>
- 630 Christensen, V., 1995. Ecosystem maturity — towards quantification. *Ecol. Modell.* 77, 3–32.  
631 [https://doi.org/10.1016/0304-3800\(93\)E0073-C](https://doi.org/10.1016/0304-3800(93)E0073-C)
- 632 Christensen, V., Walters, C.J., 2004. Ecopath with Ecosim: Methods, capabilities and limitations. *Ecol.*  
633 *Modell.* 172, 109–139. <https://doi.org/10.1016/j.ecolmodel.2003.09.003>
- 634 Cliff, N., 1993. Dominance statistics: Ordinal analyses to answer ordinal questions. *Psychol. Bull.* 114,  
635 494–509. <https://doi.org/10.1037/0033-2909.114.3.494>
- 636 Coates, D.A., Deschutter, Y., Vincx, M., Vanaverbeke, J., 2014. Enrichment and shifts in macrobenthic  
637 assemblages in an offshore wind farm area in the Belgian part of the North Sea. *Mar. Environ.*  
638 *Res.* 95, 1–12. <https://doi.org/10.1016/j.marenvres.2013.12.008>
- 639 Crain, C.M., Kroeker, K., Halpern, B.S., 2008a. Interactive and cumulative effects of multiple human  
640 stressors in marine systems. *Ecol. Lett.* 11, 1304–1315. [https://doi.org/10.1111/j.1461-](https://doi.org/10.1111/j.1461-0248.2008.01253.x)  
641 [0248.2008.01253.x](https://doi.org/10.1111/j.1461-0248.2008.01253.x)
- 642 Crain, C.M., Kroeker, K., Halpern, B.S., 2008b. Interactive and cumulative effects of multiple human  
643 stressors in marine systems. *Ecol. Lett.* 11, 1304–1315. [https://doi.org/10.1111/j.1461-](https://doi.org/10.1111/j.1461-0248.2008.01253.x)  
644 [0248.2008.01253.x](https://doi.org/10.1111/j.1461-0248.2008.01253.x)
- 645 Dame, J.K., Christian, R.R., 2007. A Statistical Test of Network Analysis: Can it Detect Differences in  
646 Food Web Properties? *Ecosystems* 10, 906–923. <https://doi.org/10.1007/s10021-007-9068-1>
- 647 Dauvin, J.-C., 2019. Chapter 6: The English Channel: La Manche. *World Seas: An Environmental*  
648 *Evaluation*, , 2nd ed.vol. 1. Elsevier Academic Press, pp. 153–188.
- 649 de la Vega, C., Schückel, U., Horn, S., Kröncke, I., Asmus, R., Asmus, H., 2018. How to include  
650 ecological network analysis results in management? A case study of three tidal basins of the  
651 Wadden Sea, south-eastern North Sea. *Ocean Coast. Manag.* 163, 401–416.  
652 <https://doi.org/10.1016/j.ocecoaman.2018.07.019>
- 653 De Mesel, I., Kerckhof, F., Norro, A., Rumes, B., Degraer, S., 2015. Succession and seasonal dynamics  
654 of the epifauna community on offshore wind farm foundations and their role as stepping stones  
655 for non-indigenous species. *Hydrobiologia* 756, 37–50. [https://doi.org/10.1007/s10750-014-](https://doi.org/10.1007/s10750-014-2157-1)  
656 [2157-1](https://doi.org/10.1007/s10750-014-2157-1)
- 657 Fagan, W.F., 1997. Omnivory as a Stabilizing Feature of Natural Communities. *Am. Nat.* 150, 554–567.  
658 <https://doi.org/10.1086/286081>
- 659 Fath, B.D., Asmus, H., Asmus, R., Baird, D., Borrett, S.R., de Jonge, V.N., Ludovisi, A., Niquil, N.,  
660 Scharler, U.M., Schückel, U., Wolff, M., 2019. Ecological network analysis metrics: The need for  
661 an entire ecosystem approach in management and policy. *Ocean Coast. Manag.* 174, 1–14.  
662 <https://doi.org/10.1016/j.ocecoaman.2019.03.007>
- 663 Fauth, J.E., 1999. Identifying potential keystone species from field data - An example from temporary  
664 ponds. *Ecol. Lett.* 2, 36–43. <https://doi.org/10.1046/j.1461-0248.1999.21046.x>
- 665 Finn, J.T., 1976. Measures of ecosystem structure and function derived from analysis of flows. *J.*  
666 *Theor. Biol.* 56, 363–380. [https://doi.org/10.1016/S0022-5193\(76\)80080-X](https://doi.org/10.1016/S0022-5193(76)80080-X)
- 667 Fontaine, C., Guimarães, P.R., Kéfi, S., Loeuille, N., Memmott, J., van der Putten, W.H., van Veen,  
668 F.J.F., Thébault, E., 2011. The ecological and evolutionary implications of merging different  
669 types of networks. *Ecol. Lett.* 14, 1170–1181. <https://doi.org/10.1111/j.1461->

670 0248.2011.01688.x

671 Fu, C., Travers-Trolet, M., Velez, L., Grüss, A., Bundy, A., Shannon, L.J., Fulton, E.A., Akoglu, E., Houle,  
672 J.E., Coll, M., Verley, P., Heymans, J.J., John, E., Shin, Y.J., 2018. Risky business: The combined  
673 effects of fishing and changes in primary productivity on fish communities. *Ecol. Modell.* 368,  
674 265–276. <https://doi.org/10.1016/j.ecolmodel.2017.12.003>

675 Gallager, R.G., 1968. *Information Theory and Reliable Communication*, Wiley. ed. New York, NY.

676 Gelcich, S., Hughes, T.P., Olsson, P., Folke, C., Defeo, O., Fernández, M., Foale, S., Gunderson, L.H.,  
677 Rodríguez-Sickert, C., Scheffer, M., Steneck, R.S., Castilla, J.C., 2010. Navigating transformations  
678 in governance of Chilean marine coastal resources. *Proc. Natl. Acad. Sci. U. S. A.* 107, 16794–  
679 16799. <https://doi.org/10.1073/pnas.1012021107>

680 Halpern, B.S., Frazier, M., Potapenko, J., Casey, K.S., Koenig, K., Longo, C., Lowndes, J.S., Rockwood,  
681 R.C., Selig, E.R., Selkoe, K.A., Walbridge, S., 2015. Spatial and temporal changes in cumulative  
682 human impacts on the world’s ocean. *Nat. Commun.* 6, 1–7.  
683 <https://doi.org/10.1038/ncomms8615>

684 Halpern, B.S., McLeod, K.L., Rosenberg, A.A., Crowder, L.B., 2008a. Managing for cumulative impacts  
685 in ecosystem-based management through ocean zoning. *Ocean Coast. Manag.* 51, 203–211.  
686 <https://doi.org/10.1016/J.OCECOAMAN.2007.08.002>

687 Halpern, B.S., Walbridge, S., Selkoe, K.A., Kappel, C. V., Micheli, F., D’Agrosa, C., Bruno, J.F., Casey,  
688 K.S., Ebert, C., Fox, H.E., Fujita, R., Heinemann, D., Lenihan, H.S., Madin, E.M.P., Perry, M.T.,  
689 Selig, E.R., Spalding, M., Steneck, R., Watson, R., 2008b. A Global Map of Human Impact on  
690 Marine Ecosystems. *Science (80- )*. 319, 948–952. <https://doi.org/10.1126/science.1149345>

691 Hammar, L., Wikström, A., Molander, S., 2014. Assessing ecological risks of offshore wind power on  
692 Kattegat cod. *Renew. Energy* 66, 414–424. <https://doi.org/10.1016/j.renene.2013.12.024>

693 Harrison, G.W., 1979. Stability under Environmental Stress: Resistance, Resilience, Persistence, and  
694 Variability. *Am. Nat.* 113, 659–669. <https://doi.org/10.1086/283424>

695 Heymans, J.J., Coll, M., Libralato, S., Christensen, V., 2011. Ecopath Theory, Modeling, and  
696 Application to Coastal Ecosystems. *Treatise Estuar. Coast. Sci.* 93–113.  
697 <https://doi.org/10.1016/B978-0-12-374711-2.00905-0>

698 Heymans, J.J., Tomczak, M.T., 2016. Regime shifts in the Northern Benguela ecosystem: Challenges  
699 for management. *Ecol. Modell.* 331, 151–159. <https://doi.org/10.1016/j.ecolmodel.2015.10.027>

700 Hoegh-Guldberg, O., Bruno, J.F., 2010. The impact of climate change on the world’s marine  
701 ecosystems. *Science (80- )*. 328, 1523–1528. <https://doi.org/10.1126/science.1189930>

702 Holling, C.S., 1996. Engineering resilience versus ecological resilience. *Eng. within Ecol. constraints*  
703 31–43.

704 Jackson, J.B.C., Kirby, M.X., Berger, W.H., Bjorndal, K.A., Botsford, L.W., Bourque, B.J., Bradbury, R.H.,  
705 Cooke, R., Erlandson, J., Estes, J.A., Hughes, T.P., Kidwell, S., Lange, C.B., Lenihan, H.S., Pandolfi,  
706 J.M., Peterson, C.H., Steneck, R.S., Tegner, M.J., Warner, R.R., 2001. Historical overfishing and  
707 the recent collapse of coastal ecosystems. *Science (80- )*. 293, 629–637.  
708 <https://doi.org/10.1126/science.1059199>

709 Johnson, G.A., Niquil, N., Asmus, H., Bacher, C., Asmus, R., Baird, D., 2009. The effects of aggregation  
710 on the performance of the inverse method and indicators of network analysis. *Ecol. Modell.*  
711 220, 3448–3464. <https://doi.org/10.1016/j.ecolmodel.2009.08.003>

712 Kéfi, S., Berlow, E.L., Wieters, E.A., Joppa, L.N., Wood, S.A., Brose, U., Navarrete, S.A., 2015. Network

- 713 structure beyond food webs: Mapping non-trophic and trophic interactions on Chilean rocky  
714 shores. *Ecology* 96, 291–303. <https://doi.org/10.1890/13-1424.1>
- 715 Kéfi, S., Berlow, E.L., Wieters, E.A., Navarrete, S.A., Petchey, O.L., Wood, S.A., Boit, A., Joppa, L.N.,  
716 Lafferty, K.D., Williams, R.J., Martinez, N.D., Menge, B.A., Blanchette, C.A., Iles, A.C., Brose, U.,  
717 2012. More than a meal... integrating non-feeding interactions into food webs. *Ecol. Lett.* 15,  
718 291–300. <https://doi.org/10.1111/j.1461-0248.2011.01732.x>
- 719 Laing, I., 2000. Effect of temperature and ration on growth and condition of king scallop (*Pecten*  
720 *maximus*) spat. *Aquaculture* 183, 325–334. [https://doi.org/10.1016/S0044-8486\(99\)00262-8](https://doi.org/10.1016/S0044-8486(99)00262-8)
- 721 Langhamer, O., 2012. Artificial reef effect in relation to offshore renewable energy conversion: State  
722 of the art. *Sci. World J.* 2012. <https://doi.org/10.1100/2012/386713>
- 723 Larocque, G.R., Maily, D., Yue, T.X., Anand, M., Peng, C., Kazanci, C., Etterson, M., Goethals, P.,  
724 Jørgensen, S.E., Schramski, J.R., McIntire, E.J.B., Marceau, D.J., Chen, B., Chen, G.Q., Yang, Z.F.,  
725 Novotna, B., Luckai, N., Bhatti, J.S., Liu, J., Munson, A., Gordon, A.M., Ascough, J.C., 2011.  
726 Common challenges for ecological modelling: Synthesis of facilitated discussions held at the  
727 symposia organized for the 2009 conference of the International Society for Ecological  
728 Modelling in Quebec City, Canada, (October 6-9, 2009). *Ecol. Modell.* 222, 2456–2468.  
729 <https://doi.org/10.1016/j.ecolmodel.2010.12.017>
- 730 Lassalle, G., Lobry, J., Le Loc'h, F., Bustamante, P., Certain, G., Delmas, D., Dupuy, C., Hily, C., Labry,  
731 C., Le Pape, O., Marquis, E., Petitgas, P., Pusineri, C., Ridoux, V., Spitz, J., Niquil, N., 2011. Lower  
732 trophic levels and detrital biomass control the Bay of Biscay continental shelf food web:  
733 Implications for ecosystem management. *Prog. Oceanogr.* 91, 561–575.  
734 <https://doi.org/10.1016/j.pocean.2011.09.002>
- 735 Latham, L.G., 2006. Network flow analysis algorithms. *Ecol. Modell.* 192, 586–600.  
736 <https://doi.org/10.1016/j.ecolmodel.2005.07.029>
- 737 Lees, K., Pitois, S., Scott, C., Frid, C., MacKinson, S., 2006. Characterizing regime shifts in the marine  
738 environment. *Fish Fish.* 7, 104–127. <https://doi.org/10.1111/j.1467-2979.2006.00215.x>
- 739 Leguerrier, D., Niquil, N., Boileau, N., Rzeznik, J., Sauriau, P., Le Moine, O., Bacher, C., 2003.  
740 Numerical analysis of the food web of an intertidal mudflat ecosystem on the Atlantic coast of  
741 France. *Mar. Ecol. Prog. Ser.* 246, 17–37. <https://doi.org/10.3354/meps246017>
- 742 Libralato, S., 2019. Keystone Species and Keystoneness. *Encycl. Ecol.* 3, 451–456.  
743 <https://doi.org/10.1016/b978-0-12-409548-9.10570-6>
- 744 Libralato, S., 2013. System Omnivory Index, in: *Encyclopedia of Ecology*. Elsevier, pp. 481–486.  
745 <https://doi.org/10.1016/B978-0-12-409548-9.00605-9>
- 746 Libralato, S., Christensen, V., Pauly, D., 2006. A method for identifying keystone species in food web  
747 models. *Ecol. Modell.* 195, 153–171. <https://doi.org/10.1016/j.ecolmodel.2005.11.029>
- 748 Lobry, J., David, V., Pasquaud, S., Lepage, M., Sautour, B., Rochard, E., 2008. Diversity and stability of  
749 an estuarine trophic network. *Mar. Ecol. Prog. Ser.* 358, 13–25.  
750 <https://doi.org/10.3354/meps07294>
- 751 MacBeth, G., Razumiejczyk, E., Ledsema, R., 2012. Cliff 's Delta Calculator: A non-parametric effect  
752 size program for two groups of observations. *Univ. Psychol.* 10, 545–555.
- 753 Meersche, K. Van den, Soetaert, K., Oevelen, D. Van, 2009. xsample() : An R Function for Sampling  
754 Linear Inverse Problems. *J. Stat. Softw.* 30. <https://doi.org/10.18637/jss.v030.c01>
- 755 Napoléon, C., Claquin, P., 2012. Multi-parametric relationships between PAM measurements and



- 756 carbon incorporation, an in situ approach. *PLoS One* 7, 1–12.  
757 <https://doi.org/10.1371/journal.pone.0040284>
- 758 Niquil, N., Chaumillon, E., Johnson, G.A., Bertin, X., Grami, B., David, V., Bacher, C., Asmus, H., Baird,  
759 D., Asmus, R., 2012. The effect of physical drivers on ecosystem indices derived from ecological  
760 network analysis: Comparison across estuarine ecosystems. *Estuar. Coast. Shelf Sci.* 108, 132–  
761 143. <https://doi.org/10.1016/j.ecss.2011.12.031>
- 762 Niquil, N., Le Loc’h, F., Tecchio, S., Chaalali, A., Vouriot, P., Mialet, B., Fizzala, X., Féral, J.-P., Lamare,  
763 S., Dauvin, J.-C., Safi, G., 2014. Ongoing research on ecosystem health indicators for food webs  
764 in the MSFD context. *TRANS-CHANNEL FORUM Proc.* 4–7.
- 765 Niquil, N., Saint-Béat, B., Johnson, G.A., Soetaert, K., van Oevelen, D., Bacher, C., Vézina, A.F., 2012.  
766 Inverse Modeling in Modern Ecology and Application to Coastal Ecosystems. *Treatise Estuar.  
767 Coast. Sci.* 9, 115–133. <https://doi.org/10.1016/B978-0-12-374711-2.00906-2>
- 768 Norling, P., Kautsky, N., 2008. Patches of the mussel *Mytilus* sp. are islands of high biodiversity in  
769 subtidal sediment habitats in the Baltic sea. *Aquat. Biol.* 4, 75–87.  
770 <https://doi.org/10.3354/ab00096>
- 771 Norling, P., Kautsky, N., 2007. Structural and functional effects of *Mytilus edulis* on diversity of  
772 associated species and ecosystem functioning. *Mar. Ecol. Prog. Ser.* 351, 163–175.  
773 <https://doi.org/10.3354/meps07033>
- 774 O’Dor, R.K., Wells, M.J., 1987. Energy and nutrient flow. *Cephalop. Life Cycles* 109–133.
- 775 Odum, E.P., 1985. Trends Expected in Stressed Ecosystems. *Bioscience* 35, 419–422.  
776 <https://doi.org/10.2307/1310021>
- 777 Odum, E.P., 1969. The Strategy of Ecosystem Development. *Science* (80-. ). 164, 262–270.  
778 <https://doi.org/10.1126/science.164.3877.262>
- 779 Pauly, D., Christensen, V., Dalsgaard, J., Froese, R., Torres, F., 1998. Fishing down marine food webs.  
780 *Science* 279, 860–3. <https://doi.org/10.1126/SCIENCE.279.5352.860>
- 781 Pauly, D., Christensen, V., Walters, C., 2000. Ecopath, Ecosim, and Ecospace as tools for evaluating  
782 ecosystem impact of fisheries. *ICES J. Mar. Sci.* 57, 697–706.  
783 <https://doi.org/10.1006/jmsc.2000.0726>
- 784 Pelletier, É., Sargian, P., Payet, J., Demers, S., 2006. Ecotoxicological Effects of Combined UVB.  
785 *Photochem. Photobiol.* 981–993. <https://doi.org/10.1562/2005-09-18-ra-688>
- 786 Petersen, J.K., Malm, T., 2006. Offshore Windmill Farms: Threats to or Possibilities for the Marine  
787 Environment. *AMBIO A J. Hum. Environ.* 35, 75–80. [https://doi.org/10.1579/0044-7447\(2006\)35](https://doi.org/10.1579/0044-7447(2006)35)
- 788 Pezy, J.-P., Raoux, A., Dauvin, J.-C., 2020. The environmental impact from an offshore windfarm:  
789 Challenge and evaluation methodology based on an ecosystem approach. *Ecol. Indic.* 114,  
790 106302. <https://doi.org/10.1016/j.ecolind.2020.106302>
- 791 Planque, B., Fromentin, J.M., Cury, P., Drinkwater, K.F., Jennings, S., Perry, R.I., Kifani, S., 2010. How  
792 does fishing alter marine populations and ecosystems sensitivity to climate? *J. Mar. Syst.* 79,  
793 403–417. <https://doi.org/10.1016/j.jmarsys.2008.12.018>
- 794 Polovina, J.J., 1984. Model of a coral reef ecosystem - I. The ECOPATH model and its application to  
795 French Frigate Shoals. *Coral Reefs* 3, 1–11. <https://doi.org/10.1007/BF00306135>
- 796 Power, M.E., Tilman, D., Estes, J.A., Menge, B.A., Bond, W.J., Mills, L.S., Daily, G., Castilla, J.C.,  
797 Lubchenco, J., Paine, R.T., 1996. Challenges in the Quest for Keystones. *Bioscience* 46, 609–620.

798 <https://doi.org/10.2307/1312990>

799 Przeslawski, R., Davis, A.R., Benkendorff, K., 2005. Synergistic effects associated with climate change  
800 and the development of rocky shore molluscs. *Glob. Chang. Biol.* 11, 515–522.  
801 <https://doi.org/10.1111/j.1365-2486.2005.00918.x>

802 Raoux, A., Lassalle, G., Pezy, J.P., Tecchio, S., Safi, G., Ernande, B., Mazé, C., le Loc’h, F., Lequesne, J.,  
803 Girardin, V., Dauvin, J.C., Niquil, N., 2019. Measuring sensitivity of two OSPAR indicators for a  
804 coastal food web model under offshore wind farm construction. *Ecol. Indic.* 96, 728–738.  
805 <https://doi.org/10.1016/j.ecolind.2018.07.014>

806 Raoux, A., Tecchio, S., Pezy, J.-P., Lassalle, G., Degraer, S., Wilhelmsson, D., Cachera, M., Ernande, B.,  
807 Le Guen, C., Haraldsson, M., Grangeré, K., Le Loc’h, F., Dauvin, J.-C., Niquil, N., 2017. Benthic  
808 and fish aggregation inside an offshore wind farm: Which effects on the trophic web  
809 functioning? *Ecol. Indic.* 72, 33–46. <https://doi.org/10.1016/j.ecolind.2016.07.037>

810 Reubens, J.T., Degraer, S., Vincx, M., 2011. Aggregation and feeding behaviour of pouting (*Trisopterus*  
811 *luscus*) at wind turbines in the Belgian part of the North Sea. *Fish. Res.* 108, 223–227.  
812 <https://doi.org/10.1016/j.fishres.2010.11.025>

813 Romano, J., Kromrey, J.D., Coraggio, J., Skowronek, J., Devine, L., 2006. Exploring methods for  
814 evaluating group differences on the NSSE and other surveys: Are the t-test and Cohen’s d  
815 indices the most appropriate choices? *Annu. Meet. South. Assoc. Institutional Res.* 14–17.  
816 <https://doi.org/10.1017/CBO9781107415324.004>

817 Safi, G., Giebels, D., Arroyo, N.L., Heymans, J.J., Preciado, I., Raoux, A., Schückel, U., Tecchio, S., de  
818 Jonge, V.N., Niquil, N., 2019. Vitamine ENA: A framework for the development of ecosystem-  
819 based indicators for decision makers. *Ocean Coast. Manag.* 174, 116–130.  
820 <https://doi.org/10.1016/j.ocecoaman.2019.03.005>

821 Saint-Béat, B., Baird, D., Asmus, H., Asmus, R., Bacher, C., Pacella, S.R., Johnson, G.A., David, V.,  
822 Vézina, A.F., Niquil, N., 2015. Trophic networks: How do theories link ecosystem structure and  
823 functioning to stability properties? A review. *Ecol. Indic.* 52, 458–471.  
824 <https://doi.org/10.1016/j.ecolind.2014.12.017>

825 Tecchio, S., Chaalali, A., Raoux, A., Tous Rius, A., Lequesne, J., Girardin, V., Lassalle, G., Cachera, M.,  
826 Riou, P., Lobry, J., Dauvin, J.C., Niquil, N., 2016. Evaluating ecosystem-level anthropogenic  
827 impacts in a stressed transitional environment: The case of the Seine estuary. *Ecol. Indic.* 61,  
828 833–845. <https://doi.org/10.1016/j.ecolind.2015.10.036>

829 Tomczak, M.T., Heymans, J.J., Yletyinen, J., Niiranen, S., Otto, S.A., Blenckner, T., 2013. Ecological  
830 Network Indicators of Ecosystem Status and Change in the Baltic Sea 8, 1–11.  
831 <https://doi.org/10.1371/journal.pone.0075439>

832 Ulanowicz, R.E., 2009. The dual nature of ecosystem dynamics. *Ecol. Modell.* 220, 1886–1892.  
833 <https://doi.org/10.1016/j.ecolmodel.2009.04.015>

834 Ulanowicz, R.E., 2004. Quantitative methods for ecological network analysis. *Comput. Biol. Chem.* 28,  
835 321–339. <https://doi.org/10.1016/J.COMPBIOLCHEM.2004.09.001>

836 Ulanowicz, R.E., 1997. *Ecology, the ascendent perspective*. Columbia University Press.

837 Ulanowicz, R.E., 1986. *Growth and Development : Ecosystems Phenomenology*. Springer New York.

838 Ulanowicz, R.E., 1980. An hypothesis on the development of natural communities. *J. Theor. Biol.* 85,  
839 223–245. [https://doi.org/10.1016/0022-5193\(80\)90019-3](https://doi.org/10.1016/0022-5193(80)90019-3)

840 Ulanowicz, R.E., Goerner, S.J., Lietaer, B., Gomez, R., 2009. Quantifying sustainability: Resilience,

841 efficiency and the return of information theory. *Ecol. Complex.* 6, 27–36.  
842 <https://doi.org/10.1016/j.ecocom.2008.10.005>

843 Ulanowicz, R.E., Norden, J.S., 1990. Symmetrical overhead in flow networks. *Int. J. Syst. Sci.* 21, 429–  
844 437. <https://doi.org/10.1080/00207729008910372>

845 Van Den Meersche, K., Yerseke, N., Oevelen, D. Van, 2009. *xsample(): an R Function for Sampling*  
846 *Linear Inverse Problems* Karline Soetaert.

847 van Oevelen, D., Van den Meersche, K., Meysman, F.J.R., Soetaert, K., Middelburg, J.J., Vézina, A.F.,  
848 2010a. Quantifying Food Web Flows Using Linear Inverse Models. *Ecosystems* 13, 32–45.  
849 <https://doi.org/10.1007/s10021-009-9297-6>

850 van Oevelen, D., Van den Meersche, K., Meysman, F.J.R., Soetaert, K., Middelburg, J.J., Vézina, A.F.,  
851 2010b. Quantifying Food Web Flows Using Linear Inverse Models. *Ecosystems* 13, 32–45.  
852 <https://doi.org/10.1007/s10021-009-9297-6>

853 Vinebrooke, D.R., Cottingham, L.K., Norberg, J., Scheffer, M., Dodson, S. I., Maberly, S. C., Sommer,  
854 U., 2004. Impacts of multiple stressors on biodiversity and ecosystem functioning: the role of  
855 species co-tolerance. *Oikos* 104, 451–457. <https://doi.org/10.1111/j.0030-1299.2004.13255.x>

856 Vitousek, P.M., Mooney, H.A., Lubchenco, J., Melillo, J.M., 1997. Human Domination of Earth's  
857 Ecosystems, in: *Urban Ecology*. Springer US, Boston, MA, pp. 3–13.  
858 [https://doi.org/https://doi.org/10.1890/1051-0761\(1997\)007\[0737:HAOTGN\]2.0.CO;2](https://doi.org/https://doi.org/10.1890/1051-0761(1997)007[0737:HAOTGN]2.0.CO;2)

859 Wang, J., Zou, X., Yu, W., Zhang, D., Wang, T., 2019. Effects of established offshore wind farms on  
860 energy flow of coastal ecosystems: A case study of the Rudong offshore wind farms in China.  
861 *Ocean Coast. Manag.* 171, 111–118. <https://doi.org/10.1016/j.ocecoaman.2019.01.016>

862 Wilhelmsson, D., Malm, T., 2008. Fouling assemblages on offshore wind power plants and adjacent  
863 substrata. *Estuar. Coast. Shelf Sci.* 79, 459–466. <https://doi.org/10.1016/j.ecss.2008.04.020>

864 Wilhelmsson, D., Malm, T., Öhman, M., 2006. The influence of offshore windpower on demersal fish.  
865 *ICES J. Mar. Sci.* 63, 775–784. <https://doi.org/10.1016/j.icesjms.2006.02.001>

866

867 **Figure Captions**

868

869 **Figure 1:** Localization of the future offshore wind farm of Courseulles-sur-Mer in the Bay of Seine.

870 **Figure 2:** Functional compartments of the Courseulles-sur-Mer ecosystem model organized according  
871 to their trophic level, based on the BOWF trophic levels.

872 **Figure 3:** Schematic representation of the climate change modeling approach.

873 **Figure 4:** Modeling framework of the sixteen models all represented by gray boxes, with the initial  
874 BOWF model, single effect models including seven climate change scenarios and the REEF model, and  
875 the combined models including seven cumulative scenarios.

876 **Figure 5:** Different types of cumulative effects on the different index values (e.g., ENA index).

877 **Figure 6:** Variation of all the throughflow/activity (input/output) in gC.m<sup>2</sup> between: the BOWF model  
878 and the single effect models (reef effect or climate change effect, a group on the left), and between  
879 the REEF model and the cumulative models (reef effect + climate change effect, b group on the  
880 right). Red, increased activity; blue, decreased activity; bold-bordered square, strong variation  
881 according to the cliff delta ( $|\partial\text{Cliff}| < 0.474$ ).

882 **Figure 7:** A) Following UPGMA to determine different groups of models, 5 groups were selected. B)  
883 The Cliff delta was used to compare the ENA results of: the BOWF model and the single effect models  
884 (reef effect or climate change effect), and between the REEF model and the cumulative models (reef  
885 effect + climate change effect).

886 **Figure 8:** Cumulative effects of the different scenarios on multiple ENA indices. Each cumulative  
887 effect is represented in a zone. Zone I, positive synergistic effect; zone II, positive antagonistic effect;  
888 zone III, positive dampened effect; zone IV, negative synergistic effect; zone V, negative antagonistic  
889 effect; and zone VI, negative dampened effect.

890

891 **Table Captions**

892

893 **Table 1:** ENA indices computed with the LIM models results.

894 **Table 2:** Representation of the different mechanisms of the cumulative effects based on the LIM  
895 model results.

896

897

898 **Annex:**

899 **Table A.1: Ecopath groups from Raoux et al. (2017) compared to LIM groups.**

| <b>Ecopath compartments from Raoux et al. (2017)</b> | <b>LIM trophic compartments</b>   | <b>LIM Symbol</b> |
|--|-----------------------------------|-------------------|
| 1 Bottlenose dolphins                                | 1 Cetaceans                       | <b>CET</b>        |
| 2 Harbour porpoises                                  |                                   |                   |
| 3 Harbour seals                                      | 2 Phocidae                        | <b>PHO</b>        |
| 4 Grey seals   |                                   |                   |
| 5 Plunge and pursuit, diverse seabirds               | 3 Birds                           | <b>BIR</b>        |
| 6 Surface feeders, seabirds                          |                                   |                   |
| 7 Benthopelagic cephalopods                          | 4 Cephalopods                     | <b>CEP</b>        |
| 8 Benthic cephalopods                                |                                   |                   |
| 9 Fish, mackerel                                     | 5 Fish, planctivorous             | <b>FPL</b>        |
| 10 Fish, European pilchard                           |                                   |                   |
| 11 Fish, European sprat                              |                                   |                   |
| 12 Fish, planctivorous                               |                                   |                   |
| 13 Fish, atlantic horse mackerel                     |                                   |                   |
| 14 Fish, European seabass                            | 6 Fish, benthos feeders           | <b>FBF</b>        |
| 15 Fish, sharks and rays                             |                                   |                   |
| 16 Fish, gurnard                                     |                                   |                   |
| 17 Fish, pouting                                     |                                   |                   |
| 18 Fish, poor cod                                    |                                   |                   |
| 19 Fish, benthos feeders                             |                                   |                   |
| 20 Fish, sea bream                                   |                                   |                   |
| 21 Fish, Atlantic cod                                | 7 Fish, piscivorous               | <b>FPI</b>        |
| 22 Fish, whiting                                     |                                   |                   |
| 23 Fish, piscivorous                                 |                                   |                   |
| 24 Fish, sole  | 8 Fish, flat fish                 | <b>FFI</b>        |
| 25 Fish, European plaice                             |                                   |                   |
| 26 Fish, other flatfish                              |                                   |                   |
| 27 Benthic inv., predators                           | 9 Invertebrates, predators        | <b>IPR</b>        |
| 28 Benthic inv., filter feeders                      | 10 Invertebrates, filter feeders  | <b>IFF</b>        |
| 29 Benthic inv., bivalves                            | 11 Bivalvia                       | <b>BIV</b>        |
| 30 King scallop                                      | 12 King scallops                  | <b>KSC</b>        |
| 31 Benthic inv., deposit feeders                     | 13 Invertebrates, deposit feeders | <b>IDF</b>        |
| 32 Suprabenthos                                      | 14 Suprabenthos                   | <b>SUP</b>        |
| 33 Meiofauna   | 15 Meiofauna (Nematodes)          | <b>NEM</b>        |
| 34 Zooplankton                                       | 16 Zooplankton                    | <b>ZOO</b>        |
| 35 Bacteria  | 17 Bacteria                       | <b>BAC</b>        |
| 36 Phytoplankton                                     | 18 Phytoplankton                  | <b>PHY</b>        |
| 37 Detritus  | 19 Detritus                       | <b>DET</b>        |

900

901

902 **Table A.2: Parameters of the LIM model.**

| Compartment  | P/B   |       | P/Q   |       | R/Q  |     | U/Q  |      | Literature  |
|--|-------|-------|-------|-------|------|-----|------|------|---|
|  | min   | max   | min   | max   | min  | max | min  | max  |   |
| <b>CET</b> aceans  | 0.04  | 0.12  | -     | -     | -    | -   | -    | -    | Christensen et al. (2009)   |
| <b>PHO</b> cidae   | 0.075 | 0.225 | -     | -     | -    | -   | -    | -    |   |
| <b>BIR</b> ds  | 0.05  | 0.15  | 0.3   | 0.8   | -    | -   | -    | -    | Saint-Béat (2012),<br>Christensen et al. (2009)   |
| <b>CEP</b> halopods  | 1     | 3     | 0.1   | 0.4   | -    | -   | -    | -    | Christensen et al, 2009   |
| <b>F</b> ish,<br><b>PL</b> anktivorous                       | 0.486 | 1.458 | 0.047 | 0.424 | -    | -   | 0.1  | 0.5  | P/B, P/Q and U/Q<br>generated using<br>confidence intervals<br>around standard Ecopath<br>parameters (Christensen<br>and Pauly, 1993),<br>Leguerrier et al (2004) |
| <b>F</b> ish, <b>B</b> enthos<br><b>F</b> eeders             | 0.542 | 1.625 | 0.059 | 0.534 | -    | -   | 0.1  | 0.5  |   |
| <b>F</b> ish,<br><b>PI</b> scivorous                         | 0.450 | 1.349 | 0.059 | 0.534 | -    | -   | 0.1  | 0.5  |   |
| <b>F</b> ish, <b>F</b> lat <b>F</b> ish                      | 0.375 | 1.126 | 0.074 | 0.670 | -    | -   | 0.1  | 0.5  |   |
| <b>I</b> nvertebrates,<br><b>PR</b> edators                  | 1     | 5     | 0.05  | 0.3   | -    | -   | 0.12 | 0.28 | Christensen and Pauly<br>(1993), Brey (2001)  |
| <b>I</b> nvertebrates,<br><b>F</b> ilter <b>F</b> eeders     | 1     | 5     | 0.05  | 0.3   | -    | -   | 0.18 | 0.42 |   |
| <b>BIV</b> alvia   | 1     | 5     | 0.05  | 0.3   | -    | -   | 0.18 | 0.42 |   |
| <b>King SC</b> allops  | 1     | 5     | 0.05  | 0.3   | -    | -   | 0.18 | 0.42 |   |
| <b>I</b> nvertebrates,<br><b>D</b> eposit<br><b>F</b> eeders | 1     | 5     | 0.05  | 0.3   | -    | -   | 0.18 | 0.42 |   |
| <b>SUP</b> rabenthos   | 0.4   | 15    | 0.1   | 0.37  | -    | -   | 0.2  | 0.5  | Brey (2001), Lobry et al.<br>(2008), Lassalle et al.<br>(2011)  |
| <b>M</b> eiofauna<br><b>(NEM)</b>                            | 10.1  | 35    | 0.05  | 0.4   | -    | -   | 0.13 | 0.3  | Heip et al. (1990), Van<br>Oevelen et al. (2006)  |
| <b>ZOO</b> plankton  |       |       | 0.25  | 0.5   | 0.1  | 0.3 | 0.1  | 0.5  | Vezina et al. (2000),<br>Vézina and Savenkoff<br>(1999)   |
| <b>BAC</b> teria   | -     | -     | 0.11  | 0.6   | -    | -   | 0.05 | 0.35 | Del Giorgio and Cole<br>(1998), Danovaro et al.<br>(2008), Tortajada et al.<br>(2012)   |
| <b>PHY</b> toplankton  | -     | -     |       |       | 0.05 | 0.3 | 0.05 | 0.5  | Vezina et al. (2000),<br>Vézina and Platt (1988),<br>Vézina and Savenkoff<br>(1999)   |

903

904 **Table A.3: Diet matrix of the LIM before offshore wind farm model, including minimum and**  
 905 **maximum values.**

| Prey\Predator                         | CETaceans | PHOCidae | BIRds | CEPhalopods | Fish, Benthos Feeders | Fish, Planktivorous | Fish, Pliscivorous | Flat Fish | Invertebrates, PRedators | Invertebrates, Filter Feeders | BIValvia | King SCallops | Invertebrates, Deposit Feeders | SUPrabenthos | MEiofauNa | ZOOplankton | BACteria |
|---------------------------------------|-----------|----------|-------|-------------|-----------------------|---------------------|--------------------|-----------|--------------------------|-------------------------------|----------|---------------|--------------------------------|--------------|-----------|-------------|----------|
| <b>IMP</b> ort                        | 0.05      | 0.05     | 0.00  | 0.00        | 0.00                  | -                   | -                  | -         | -                        | -                             | -        | -             | -                              | -            | -         | -           | -        |
|                                       | 0.25      | 0.25     | 0.56  | 0.30        | 0.30                  | -                   | -                  | -         | -                        | -                             | -        | -             | -                              | -            | -         | -           | -        |
| <b>CEP</b> halopods                   | 0.04      | -        | -     | 0.00        | -                     | -                   | -                  | -         | -                        | -                             | -        | -             | -                              | -            | -         | -           | -        |
|                                       | 0.24      | -        | -     | 0.37        | -                     | -                   | -                  | -         | -                        | -                             | -        | -             | -                              | -            | -         | -           | -        |
| <b>Fish, Benthos Feeders</b>          | 0.25      | 0.33     | 0.00  | 0.00        | 0.00                  | -                   | 0.00               | 0.00      | -                        | -                             | -        | -             | -                              | -            | -         | -           | -        |
|                                       | 0.45      | 0.53     | 0.36  | 0.42        | 0.36                  | -                   | 0.33               | 0.31      | -                        | -                             | -        | -             | -                              | -            | -         | -           | -        |
| <b>Fish, PL</b> anktivorous           | 0.08      | 0.00     | 0.36  | 0.00        | 0.00                  | -                   | 0.50               | -         | -                        | -                             | -        | -             | -                              | -            | -         | -           | -        |
|                                       | 0.28      | 0.20     | 0.96  | 0.56        | 0.46                  | -                   | 1.00               | -         | -                        | -                             | -        | -             | -                              | -            | -         | -           | -        |
| <b>Fish, Pl</b> iscivorous            | 0.08      | 0.20     | -     | 0.00        | 0.00                  | -                   | 0.00               | -         | -                        | -                             | -        | -             | -                              | -            | -         | -           | -        |
|                                       | 0.28      | 0.40     | -     | 0.34        | 0.32                  | -                   | 0.30               | -         | -                        | -                             | -        | -             | -                              | -            | -         | -           | -        |
| <b>Flat Fish</b>                      | -         | -        | -     | 0.00        | -                     | -                   | -                  | -         | -                        | -                             | -        | -             | -                              | -            | -         | -           | -        |
|                                       | -         | -        | -     | 0.35        | -                     | -                   | -                  | -         | -                        | -                             | -        | -             | -                              | -            | -         | -           | -        |
| <b>Invertebrates, P</b> Redators      | -         | -        | 0.00  | 0.00        | 0.00                  | -                   | 0.00               | 0.00      | -                        | -                             | -        | -             | -                              | -            | -         | -           | -        |
|                                       | -         | -        | 0.32  | 0.53        | 0.63                  | -                   | 0.38               | 0.55      | -                        | -                             | -        | -             | -                              | -            | -         | -           | -        |
| <b>Invertebrates, Filter Feeders</b>  | -         | -        | -     | 0.00        | 0.00                  | -                   | 0.00               | 0.00      | 0.00                     | -                             | -        | -             | -                              | -            | -         | -           | -        |
|                                       | -         | -        | -     | 0.31        | 0.34                  | -                   | 0.31               | 0.31      | 0.50                     | -                             | -        | -             | -                              | -            | -         | -           | -        |
| <b>BIV</b> alvia                      | -         | -        | -     | 0.00        | 0.00                  | -                   | -                  | 0.00      | -                        | -                             | -        | -             | -                              | -            | -         | -           | -        |
|                                       | -         | -        | -     | 0.30        | 0.30                  | -                   | -                  | 0.44      | -                        | -                             | -        | -             | -                              | -            | -         | -           | -        |
| <b>King SC</b> allops                 | -         | -        | -     | 0.00        | 0.00                  | -                   | -                  | 0.00      | -                        | -                             | -        | -             | -                              | -            | -         | -           | -        |
|                                       | -         | -        | -     | 0.30        | 0.30                  | -                   | -                  | 0.30      | -                        | -                             | -        | -             | -                              | -            | -         | -           | -        |
| <b>Invertebrates, Deposit Feeders</b> | -         | -        | -     | 0.00        | 0.00                  | -                   | 0.00               | 0.21      | 0.00                     | -                             | -        | -             | -                              | -            | -         | -           | -        |
|                                       | -         | -        | -     | 0.41        | 0.50                  | -                   | 0.33               | 0.81      | 0.39                     | -                             | -        | -             | -                              | -            | -         | -           | -        |
| <b>SUP</b> rabenthos                  | -         | -        | -     | 0.00        | 0.00                  | -                   | 0.00               | 0.00      | 0.00                     | -                             | -        | -             | -                              | 0.00         | -         | -           | -        |
|                                       | -         | -        | -     | 0.33        | 0.48                  | -                   | 0.31               | 0.33      | 0.45                     | -                             | -        | -             | -                              | 0.35         | -         | -           | -        |
| <b>ME</b> iofauNa                     | -         | -        | -     | 0.00        | 0.00                  | -                   | -                  | 0.00      | 0.00                     | 0.00                          | -        | -             | 0.00                           | -            | -         | -           | -        |
|                                       | -         | -        | -     | 0.38        | 0.30                  | -                   | -                  | 0.35      | 0.60                     | 0.15                          | -        | -             | 0.35                           | -            | -         | -           | -        |
| <b>ZOO</b> plankton                   | -         | 0.00     | 0.00  | -           | 0.00                  | 0.50                | 0.00               | 0.00      | 0.00                     | 0.00                          | 0.00     | 0.00          | 0.00                           | 0.10         | 0.00      | 0.00        | -        |
|                                       | -         | 0.12     | 0.31  | -           | 0.30                  | 1.00                | 0.31               | 0.31      | 0.31                     | 0.20                          | 0.20     | 0.20          | 0.35                           | 0.70         | 0.35      | 0.10        | -        |
| <b>BAC</b> teria                      | -         | -        | -     | -           | -                     | -                   | -                  | -         | -                        | 0.00                          | -        | -             | 0.00                           | 0.00         | 0.00      | -           | -        |
|                                       | -         | -        | -     | -           | -                     | -                   | -                  | -         | -                        | 0.15                          | -        | -             | 0.40                           | 0.35         | 0.35      | -           | -        |
| <b>PHY</b> toplankton                 | -         | -        | -     | -           | -                     | 0.00                | -                  | -         | -                        | 0.60                          | 0.55     | 0.55          | 0.00                           | 0.05         | 0.00      | 0.83        | 0.10     |
|                                       | -         | -        | -     | -           | -                     | 0.50                | -                  | -         | -                        | 0.80                          | 0.75     | 0.75          | 0.45                           | 0.65         | 0.45      | 1.00        | 0.30     |
| <b>DET</b> ritus                      | -         | -        | -     | -           | -                     | -                   | -                  | -         | 0.00                     | 0.00                          | 0.15     | 0.15          | 0.35                           | 0.00         | 0.45      | 0.00        | 0.70     |
|                                       | -         | -        | -     | -           | -                     | -                   | -                  | -         | 0.42                     | 0.20                          | 0.35     | 0.35          | 0.95                           | 0.45         | 1.00      | 0.17        | 0.90     |

906 **Table A.4: Diet matrix of the LIM offshore wind farm model, including minimum and maximum**  
 907 **values.**

| Prey\Predator                          | <b>CET</b> aceans | <b>PHO</b> cidae | <b>BIR</b> ds | <b>CEP</b> halopods | <b>Fish, Benthos Feeders</b> | <b>Fish P</b> lanktivorous | <b>Fish, P</b> iscivorous | <b>Flat F</b> ish | <b>Invertebrates, P</b> redators | <b>Invertebrates, F</b> ilter Feeders | <b>BIV</b> alvia | <b>King S</b> callops | <b>Invertebrates, D</b> eposit Feeders | <b>SUP</b> rabenthos | <b>Meiofauna (NEM)</b> | <b>ZOO</b> plankton | <b>BAC</b> teria |
|--|-------------------|------------------|---------------|---------------------|------------------------------|----------------------------|---------------------------|-------------------|----------------------------------|---------------------------------------|------------------|-----------------------|--|----------------------|------------------------|---------------------|------------------|
| <b>IMP</b> ort                         | 0.00<br>0.19      | 0.05<br>0.25     | 0.12<br>0.72  | 0.00<br>0.34        | 0.00<br>0.45                 | -<br>-                     | -<br>-                    | -<br>-            | -<br>-                           | -<br>-                                | -<br>-           | -<br>-                | -<br>-                                 | -<br>-               | -<br>-                 | -<br>-              | -<br>-           |
| <b>CEP</b> halopods                    | 0.03<br>0.23      | -<br>-           | -<br>-        | 0.00<br>0.38        | -<br>-                       | -<br>-                     | -<br>-                    | -<br>-            | -<br>-                           | -<br>-                                | -<br>-           | -<br>-                | -<br>-                                 | -<br>-               | -<br>-                 | -<br>-              | -<br>-           |
| <b>Fish, Benthos Feeders</b>           | 0.38<br>0.46      | 0.36<br>0.56     | 0.00<br>0.34  | 0.00<br>0.49        | 0.00<br>0.38                 | -<br>-                     | 0.00<br>0.43              | 0.00<br>0.31      | -<br>-                           | -<br>-                                | -<br>-           | -<br>-                | -<br>-                                 | -<br>-               | -<br>-                 | -<br>-              | -<br>-           |
| <b>Fish, P</b> lanktivorous            | 0.00<br>0.14      | 0.00<br>0.12     | 0.23<br>0.83  | 0.00<br>0.45        | 0.00<br>0.38                 | -<br>-                     | 0.36<br>1.00              | -<br>-            | -<br>-                           | -<br>-                                | -<br>-           | -<br>-                | -<br>-                                 | -<br>-               | -<br>-                 | -<br>-              | -<br>-           |
| <b>Fish, P</b> iscivorous              | 0.16<br>0.36      | 0.26<br>0.46     | -<br>-        | 0.00<br>0.35        | -<br>-                       | -<br>-                     | 0.00<br>0.34              | -<br>-            | -<br>-                           | -<br>-                                | -<br>-           | -<br>-                | -<br>-                                 | -<br>-               | -<br>-                 | -<br>-              | -<br>-           |
| <b>Flat F</b> ish                      | -<br>-            | -<br>-           | -<br>-        | 0.00<br>0.42        | -<br>-                       | -<br>-                     | -<br>-                    | -<br>-            | -<br>-                           | -<br>-                                | -<br>-           | -<br>-                | -<br>-                                 | -<br>-               | -<br>-                 | -<br>-              | -<br>-           |
| <b>Invertebrates, P</b> redators       | -<br>-            | -<br>-           | -<br>-        | 0.00<br>0.47        | 0.00<br>0.55                 | -<br>-                     | 0.00<br>0.40              | 0.00<br>0.48      | -<br>-                           | -<br>-                                | -<br>-           | -<br>-                | -<br>-                                 | -<br>-               | -<br>-                 | -<br>-              | -<br>-           |
| <b>Invertebrates, F</b> ilter Feeders  | -<br>-            | -<br>-           | -<br>-        | 0.00<br>0.32        | 0.00<br>0.38                 | -<br>-                     | 0.00<br>0.32              | 0.00<br>0.31      | 0.00<br>0.57                     | -<br>-                                | -<br>-           | -<br>-                | -<br>-                                 | -<br>-               | -<br>-                 | -<br>-              | -<br>-           |
| <b>BIV</b> alvia                       | -<br>-            | -<br>-           | -<br>-        | 0.00<br>0.31        | 0.00<br>0.31                 | -<br>-                     | -<br>-                    | 0.08<br>0.68      | 0.00<br>0.31                     | -<br>-                                | -<br>-           | -<br>-                | -<br>-                                 | -<br>-               | -<br>-                 | -<br>-              | -<br>-           |
| <b>King S</b> callops                  | -<br>-            | -<br>-           | -<br>-        | 0.00<br>0.10        | 0.00<br>0.10                 | -<br>-                     | -<br>-                    | 0.00<br>0.30      | -<br>-                           | -<br>-                                | -<br>-           | -<br>-                | -<br>-                                 | -<br>-               | -<br>-                 | -<br>-              | -<br>-           |
| <b>Invertebrates, D</b> eposit Feeders | -<br>-            | -<br>-           | -<br>-        | 0.00<br>0.37        | 0.00<br>0.44                 | -<br>-                     | 0.00<br>0.33              | 0.03<br>0.63      | 0.00<br>0.38                     | -<br>-                                | -<br>-           | -<br>-                | -<br>-                                 | -<br>-               | -<br>-                 | -<br>-              | -<br>-           |
| <b>SUP</b> rabenthos                   | -<br>-            | -<br>-           | -<br>-        | 0.00<br>0.32        | 0.00<br>0.32                 | -<br>-                     | 0.00<br>0.31              | 0.00<br>0.32      | 0.00<br>0.40                     | -<br>-                                | -<br>-           | -<br>-                | -<br>-                                 | 0.00<br>0.31         | -<br>-                 | -<br>-              | -<br>-           |
| <b>Meiofauna (NEM)</b>                 | -<br>-            | -<br>-           | -<br>-        | 0.00<br>0.38        | -<br>-                       | -<br>-                     | -<br>-                    | 0.00<br>0.36      | 0.00<br>0.50                     | 0.00<br>0.16                          | -<br>-           | -<br>-                | 0.00<br>0.36                           | -<br>-               | -<br>-                 | -<br>-              | -<br>-           |
| <b>ZOO</b> plankton                    | -<br>-            | -<br>-           | -<br>-        | -<br>-              | -<br>-                       | 0.53<br>1.00               | 0.00<br>0.31              | 0.00<br>0.30      | 0.00<br>0.34                     | 0.00<br>0.19                          | 0.00<br>0.20     | 0.00<br>0.14          | 0.00<br>0.35                           | 0.00<br>0.59         | 0.00<br>0.35           | -<br>-              | -<br>-           |
| <b>BAC</b> teria                       | -<br>-            | -<br>-           | -<br>-        | -<br>-              | -<br>-                       | -<br>-                     | -<br>-                    | -<br>-            | -<br>-                           | 0.00<br>0.15                          | -<br>-           | -<br>-                | 0.00<br>0.40                           | 0.00<br>0.35         | 0.00<br>0.35           | -<br>-              | -<br>-           |
| <b>PHY</b> toplankton                  | -<br>-            | -<br>-           | -<br>-        | -<br>-              | -<br>-                       | 0.00<br>0.47               | -<br>-                    | -<br>-            | -<br>-                           | 0.48<br>0.68                          | 0.52<br>0.72     | 0.60<br>0.80          | 0.00<br>0.44                           | 0.04<br>0.64         | 0.00<br>0.44           | 0.78<br>1.00        | 0.09<br>0.29     |
| <b>DET</b> ritus                       | -<br>-            | -<br>-           | -<br>-        | -<br>-              | -<br>-                       | -<br>-                     | -<br>-                    | -<br>-            | 0.00<br>0.60                     | 0.12<br>0.32                          | 0.19<br>0.39     | 0.16<br>0.36          | 0.35<br>1.00                           | 0.01<br>0.61         | 0.46<br>1.00           | 0.00<br>0.22        | 0.71<br>0.91     |



908 **Table A.5: Biomass modifications caused by the climate change effect (RCP 8.5).**

| <b>Compartment \ Biomass</b> | <b>BOWF</b> | <b>REEF</b> | <b>BOWF with RCP 8.5</b> | <b>REEF with RCP 8.5</b> |
|------------------------------|-------------|-------------|--------------------------|--------------------------|
| <b>CEP</b>                   | 1.98E-02    | 2.46E-02    | 6.60E-03                 | 8.18E-03                 |
| <b>FPL</b>                   | 5.92E+00    | 4.76E+00    | 2.53E+00                 | 2.01E+00                 |
| <b>FBF</b>                   | 3.20E+00    | 6.69E+00    | 6.25E-01                 | 9.29E-01                 |
| <b>FPI</b>                   | 2.68E-01    | 1.02E-01    | 1.81E-02                 | 4.40E-03                 |
| <b>FFI</b>                   | 7.85E-02    | 1.78E-01    | 3.07E-02                 | 6.06E-02                 |
| <b>KSC</b>                   | 7.70E-01    | 7.43E-01    | 3.31E-03                 | 3.20E-03                 |

909

910

911

912 **Table A.6: P/B ratio modifications as a result of climate change effect modeled over the 2091-2100**  
 913 **period (RCP 8.5).**

| Group                 | Scientific name                 | P/B current | ecology       | T° current | Linf   | M    | F     | T° RCP 8,5 | M RCP 8,5 | P/B RCP 8,5 |
|-----------------------|---------------------------------|-------------|---------------|------------|--------|------|-------|------------|-----------|-------------|
| Fish, Benthos Feeders | <i>Mullus surmuletus</i>        | 1.42        | Demersal      | 13.01      | 46.83  | 0.20 | 1.22  | 15.30      | 0.21      | <b>1.43</b> |
|                       | <i>Mustelus mustelus</i>        | 0.37        | Demersal      | 13.01      | 175.00 | 0.12 | 0.25  | 15.30      | 0.13      | <b>0.38</b> |
|                       | <i>Labrus bergylta</i>          | 1.42        | Demersal      | 13.01      | 59.45  | 0.19 | 1.23  | 15.30      | 0.20      | <b>1.43</b> |
|                       | <i>Zeus faber</i>               | 0.86        | Benthopelagic | 13.01      | 69.30  | 0.25 | 0.61  | 15.40      | 0.26      | <b>0.87</b> |
|                       | <i>Scyliorhinus canicula</i>    | 0.44        | Demersal      | 13.01      | 81.25  | 0.22 | 0.22  | 15.30      | 0.23      | <b>0.45</b> |
|                       | <i>Trigloporus lastoviza</i>    | 0.55        | Demersal      | 13.01      | 39.50  | 0.77 | -0.22 | 15.30      | 0.82      | <b>0.60</b> |
|                       | <i>Scyliorhinus stellaris</i>   | 0.44        | Demersal      | 13.01      | -      | -    | -     | 15.30      | -         | <b>0.45</b> |
|                       | <i>Raja montagui</i>            | 0.44        | Demersal      | 13.01      | 78.02  | 0.33 | 0.11  | 15.30      | 0.35      | <b>0.46</b> |
|                       | <i>Callionymus lyra</i>         | 0.82        | Demersal      | 13.01      | 21.25  | 0.92 | -0.10 | 15.30      | 0.97      | <b>0.87</b> |
|                       | <i>Dicentrarchus labrax</i>     | 0.54        | Demersal      | 13.01      | 82.70  | 0.20 | 0.34  | 15.30      | 0.21      | <b>0.55</b> |
|                       | <i>Trisopterus luscus</i>       | 1.32        | Benthopelagic | 13.01      | 41.00  | 0.79 | 0.53  | 15.40      | 0.83      | <b>1.36</b> |
|                       | <i>Spondyliosoma cantharus</i>  | 0.58        | Demersal      | 13.01      | 42.20  | 0.36 | 0.22  | 15.30      | 0.38      | <b>0.60</b> |
|                       | <i>Trisopterus minutus</i>      | 1.50        | Benthopelagic | 13.01      | 22.00  | 0.71 | 0.79  | 15.40      | 0.75      | <b>1.54</b> |
| Fish, Piscivorous     | <i>Pollachius pollachius</i>    | 0.62        | Benthopelagic | 13.01      | 85.60  | 0.27 | 0.35  | 15.40      | 0.29      | <b>0.64</b> |
|                       | <i>Gadus morhua</i>             | 1.20        | Benthopelagic | 13.01      | 123.67 | 0.18 | 1.02  | 15.40      | 0.19      | <b>1.21</b> |
|                       | <i>Merlangius merlangus</i>     | 1.07        | Benthopelagic | 13.01      | 42.70  | 0.52 | 0.55  | 15.40      | 0.55      | <b>1.10</b> |
| Flat Fish             | <i>Limanda limanda</i>          | 1.14        | Demersal      | 13.01      | 25.60  | 0.79 | 0.35  | 15.30      | 0.84      | <b>1.19</b> |
|                       | <i>Platichthys flesus</i>       | 0.56        | Demersal      | 13.01      | 40.80  | 0.49 | 0.07  | 15.30      | 0.51      | <b>0.58</b> |
|                       | <i>Solea solea</i>              | 0.70        | Demersal      | 13.01      | 42.40  | 0.44 | 0.26  | 15.30      | 0.46      | <b>0.72</b> |
|                       | <i>Pleuronectes platessa</i>    | 0.85        | Demersal      | 13.01      | 59.40  | 0.22 | 0.63  | 15.30      | 0.23      | <b>0.86</b> |
| Fish, Planctivorous   | <i>Clupea harengus</i>          | 0.75        | Benthopelagic | 13.01      | 33.10  | 0.50 | 0.25  | 15.40      | 0.53      | <b>0.78</b> |
|                       | <i>Engraulis encrasicolus</i>   | 0.58        | Pelagic       | 13.02      | 18.60  | 0.79 | -0.21 | 15.40      | 0.84      | <b>0.63</b> |
|                       | <i>Hyperoplus lanceolatus</i>   | 1.12        | Benthopelagic | 13.01      | 29.40  | 0.64 | 0.48  | 15.40      | 0.67      | <b>1.15</b> |
|                       | <i>Ammodytes tobianus</i>       | 1.12        | Benthopelagic | 13.01      | 19.70  | 1.08 | 0.04  | 15.40      | 1.14      | <b>1.18</b> |
|                       | <i>Scomber scombrus</i>         | 0.83        | Pelagic       | 13.02      | 39.40  | 0.57 | 0.26  | 15.40      | 0.61      | <b>0.87</b> |
|                       | <i>Trachurus trachurus</i>      | 0.55        | Pelagic       | 13.02      | 40.20  | 0.37 | 0.18  | 15.40      | 0.39      | <b>0.57</b> |
|                       | <i>Chelidonichthys lucernus</i> | 0.55        | Demersal      | 13.01      | 48.40  | 0.34 | 0.21  | 15.30      | 0.36      | <b>0.57</b> |
|                       | <i>Sardina pilchardus</i>       | 0.99        | Pelagic       | 13.02      | 19.50  | 0.64 | 0.35  | 15.40      | 0.68      | <b>1.03</b> |
|                       | <i>Sprattus sprattus</i>        | 1.34        | Pelagic       | 13.02      | 17.50  | 0.59 | 0.75  | 15.40      | 0.62      | <b>1.37</b> |

914

915

916 **Table A.7: Keystoneness values for each compartment of the model as computed in Libralato et al.**  
 917 **(2006).**

| <b>Compartments</b> | <b>Mean BOWF<br/>keystoneness</b> | <b>Mean<br/>BOWF<br/>biomass</b> | <b>Mean REEF<br/>keystoneness</b> | <b>Mean<br/>REEF<br/>biomass</b> |
|---------------------|-----------------------------------|----------------------------------|-----------------------------------|----------------------------------|
| <b>FBF</b>          | 1.75E-01                          | 3.19E+00                         | 1.87E-01                          | 6.69E+00                         |
| <b>BAC</b>          | 4.48E-02                          | 7.50E-01                         | 5.26E-02                          | 7.70E-01                         |
| <b>IPR</b>          | 1.20E-02                          | 2.94E+00                         | 2.47E-02                          | 3.01E+00                         |
| <b>PHY</b>          | -1.82E-03                         | 3.24E+00                         | 4.16E-03                          | 3.24E+00                         |
| <b>FPI</b>          | -2.28E-02                         | 2.68E-01                         | -8.60E-03                         | 1.02E-01                         |
| <b>ZOO</b>          | -4.53E-02                         | 1.72E+00                         | -3.80E-02                         | 1.79E+00                         |
| <b>PHO</b>          | -1.77E-01                         | 9.41E-04                         | -1.62E-01                         | 2.76E-03                         |
| <b>NEM</b>          | -1.97E-01                         | 9.70E-01                         | -1.89E-01                         | 1.06E+00                         |
| <b>CEP</b>          | -3.06E-01                         | 1.98E-02                         | -2.94E-01                         | 2.47E-02                         |
| <b>DET</b>          | -3.62E-01                         | 1.90E+01                         | -3.57E-01                         | 1.90E+01                         |
| <b>FPL</b>          | -3.64E-01                         | 5.92E+00                         | -3.57E-01                         | 4.76E+00                         |
| <b>KSC</b>          | -3.70E-01                         | 7.70E-01                         | -3.61E-01                         | 7.43E-01                         |
| <b>FFI</b>          | -3.94E-01                         | 7.86E-02                         | -3.85E-01                         | 1.78E-01                         |
| <b>BIV</b>          | -4.11E-01                         | 1.95E+01                         | -4.53E-01                         | 4.29E+01                         |
| <b>SUP</b>          | -4.14E-01                         | 2.00E+00                         | -4.06E-01                         | 1.71E+00                         |
| <b>BIR</b>          | -4.89E-01                         | 1.70E-02                         | -4.75E-01                         | 2.25E-02                         |
| <b>IFF</b>          | -6.21E-01                         | 3.12E+00                         | -6.18E-01                         | 4.78E+00                         |
| <b>IDF</b>          | -6.21E-01                         | 3.57E+00                         | -6.16E-01                         | 2.98E+00                         |
| <b>CET</b>          | -6.61E-01                         | 4.29E-04                         | -6.47E-01                         | 1.51E-04                         |

918

919

920

921