



**HAL**  
open science

## **Extended clinical and immunological phenotype and transplant outcome in CD27 and CD70 deficiency**

Sujal Ghosh, Sevgi Köstel Bal, Emily Edwards, Bethany Pillay, Raúl Jiménez Heredia, Funda Erol Cipe, Geetha Rao, Elisabeth Salzer, Samaneh Zoghi, Hassan Abolhassani, et al.

► **To cite this version:**

Sujal Ghosh, Sevgi Köstel Bal, Emily Edwards, Bethany Pillay, Raúl Jiménez Heredia, et al.. Extended clinical and immunological phenotype and transplant outcome in CD27 and CD70 deficiency. *Blood*, 2020, 136 (23), pp.2638-2655. 10.1182/blood.2020006738 . hal-03066024

**HAL Id: hal-03066024**

**<https://hal.science/hal-03066024>**

Submitted on 15 Dec 2020

**HAL** is a multi-disciplinary open access archive for the deposit and dissemination of scientific research documents, whether they are published or not. The documents may come from teaching and research institutions in France or abroad, or from public or private research centers.

L'archive ouverte pluridisciplinaire **HAL**, est destinée au dépôt et à la diffusion de documents scientifiques de niveau recherche, publiés ou non, émanant des établissements d'enseignement et de recherche français ou étrangers, des laboratoires publics ou privés.

## Extended clinical and immunological phenotype and transplant outcome in CD27 and CD70 deficiency

Tracking no: BLD-2020-006738R1

Sujal Ghosh (Universitätsklinikum Düsseldorf, Germany) Sevgi Köstel Bal (St Anna Children's Cancer Research Institute, Austria) Emily Edwards (St Vincent's Clinical School, UNSW Sydney, Randwick, NSW, Australia, Australia) Bethany Pillay (Garvan Institute of Medical Research, Australia) Raúl Jimenez-Heredia (Ludwig Boltzmann Institute for Rare and Undiagnosed Diseases, ) Geetha Rao (Garvan Institute of Medical Research, Australia) Funda Erol Cipe (Istinye University, Department of Pediatric Allergy and Immunology, Turkey) Elisabeth Salzer (St Anna Kinderspital, Austria) Samaneh Zoghi (Ludwig Boltzmann Institute for Rare and Undiagnosed Diseases, Austria) Hassan Abolhassani (Division of Clinical Immunology, Department of Laboratory Medicine, Karolinska Institute, Sweden) Tooba Momen (Department of Allergy and Clinical Immunology, Child Growth and Development Research Center, Research Institute for Primordial Prevention of Non-Communicable Disease, Isfahan University of Medical Sciences, Iran, Islamic Republic of) Emma Gostick (Cardiff University, United Kingdom) David Price (Cardiff University School of Medicine, United Kingdom) Yu Zhang (NIAID/NIH, United States) Andrew Oler (NIAID/NIH, United States) Claudia Gonzaga-Jauregui (Regeneron Genetics Center, United States) Baran Erman (Institute of Child Health, Hacettepe University, Turkey) Ayse Metin (Ministry of Health, University of Health Sciences, Ankara City Hospital, Children's Hospital, Turkey) Inci Ilhan (University of Health Sciences, Ankara City Hospital, Children's Hospital, Division of Pediatric Oncology, Turkey) Sule Haskoğlu (Ankara University, School of Medicine, Turkey) Candan Islamoğlu (Ankara University, School of Medicine, Turkey) Kubra Baskin (Ankara University, School of Medicine, Turkey) Serdar Ceylaner (Intergen Genetic Diagnosis and Research Center, Ankara, Turkey, Turkey) Ebru Yılmaz (Department of Pediatrics, Division of Pediatric Hematology & Oncology & Molecular Biology and Genetic Department, Gevher Nesibe Genom and Stem Cell Institution, GENKOK Genome and Stem Cell Center, Erciyes University,, Turkey) Ekrem Unal (Erciyes University, Faculty of Medicine, Turkey) Musa Karakukcu (Erciyes University, Turkey) Dagmar Berghuis (Willem-Alexander Children's Hospital, Department of Pediatrics, Leiden University Medical Center,, Netherlands) Theresa Cole (The Royal Children's Hospital, ) Aditya Gupta (Department of Pediatrics , Division of Pediatric Oncology , All India Institute of Medical Sciences, India) Fabian Hauck (Dr. von Hauner Children's Hospital, Ludwig-Maximilians-University, Germany) Andy Hoepelman (University Medical Centre Utrecht, Netherlands) Safa Baris (Marmara University, Research and Training Hospital, Turkey) Elif Karakoc-Aydiner (Marmara University, Research and Training Hospital, ) Ahmet Ozen (Marmara University, School of Medicine, Turkey) Leo Kager (St. Anna Children's Hospital, Austria) Dirk Holzinger (University of Duisburg-Essen, Germany) Michael Paulussen (Witten/Herdecke University, Germany) Renate Krüger (Charité-Universitätsmedizin Berlin, Germany) Roland Meisel (Heinrich-Heine-University Duesseldorf, Germany) Prasad Oommen (Heinrich-Heine-University, Duesseldorf, Germany) Emma Morris (University College London, United Kingdom) Benedicte Neven (Hospital Necker-Enfants Malades, Assistance Publique-Hospitaux de Paris, INSERM, ) Austen Worth (Great Ormond Street Hospital, United Kingdom) Joris van Montfrans (Wilhelmina Children's Hospital, Netherlands) Pieter Fraaij (Erasmus MC, University Medical Center-Sophia, Netherlands) Sharon Choo (The Royal Children's Hospital, Australia) Figen Dogu (University of Ankara, Turkey) E Davies (Great ormond Street Hospital, United Kingdom) Siobhan Burns (Institute of Immunity and Transplantation, United Kingdom) Gregor Dueckers (Helios Kliniken Krefeld, Germany, Germany) Ruy Perez Becker (Department of Pediatrics Helios Children's Hospital, Germany) Horst von Bernuth (Charité Universitätsmedizin, Germany) Sylvain Latour (Institut IMAGINE, Hôpital Necker, France) Maura Faraci (IRCCS Istituto Giannina Gaslini, ) Marco Gattorno (G. Gaslini Scientific Institute, Italy) Helen Su (NIAID, NIH, United States) Qiang Pan-Hammarström (Karolinska Institutet, Sweden) Lennart Hammarström (Karolinska Institutet, Sweden) Michael Lenardo (National Institute of Allergy and Infectious Diseases, National Institutes of Health, United States) Cindy Ma (Garvan Institute of Medical Research, Australia) Tim Niehues (HELIOS Klinikum Krefeld, Germany) Asghar Aghamohammadi (Tehran University Medical Sciences, Iran, Islamic Republic of) Nima Rezaei (Tehran University of Medical Sciences, Iran, Islamic Republic of) Aydan Ikinciogullari (Ankara University Medical School, Turkey) Stuart Tangye (Garvan Institute of Medical Research, Australia) Arjan Lankester (Leiden University Medical Center, Netherlands) Kaan Boztug (Ludwig Boltzmann Institute for Rare and Undagnosed Diseases, Austria)

### Abstract:

Biallelic mutations in the genes encoding CD27 or its ligand CD70 underlie inborn errors of immunity characterized predominantly by EBV-associated immune dysregulation, such as chronic viremia, severe infectious mononucleosis, hemophagocytic lymphohistiocytosis (HLH), lymphoproliferation and malignancy. A comprehensive understanding of the natural history, immune characteristics and transplant outcomes has remained elusive. Here, in a multi-institutional global collaboration, we collected clinical information of 49 patients from 29 families (CD27 n=33, CD70 n=16), including 24 previously unreported individuals and identified a total of 16 distinct mutations in *CD27*, and 8 in *CD70*, respectively. The majority (90%) of patients were EBV<sup>+</sup> at diagnosis, but only ~30% presented with infectious mononucleosis. Lymphoproliferation and lymphoma were the main clinical manifestations (70% and 43%, respectively), and 9 of the CD27-deficient patients developed HLH. Twenty-one (43%) patients developed autoinflammatory features including uveitis, arthritis and periodic fever. Detailed immunological characterization revealed aberrant generation of memory B and T cells, including a paucity of EBV-specific T cells, and impaired effector function of CD8<sup>+</sup> T cells, thereby providing mechanistic insight into cellular defects underpinning the clinical features of disrupted CD27/CD70 signaling. Nineteen patients underwent allogeneic hematopoietic stem cell transplantation (HSCT) prior to adulthood predominantly because of lymphoma, with 95% survival without disease recurrence. Our data highlight the marked predisposition to lymphoma of both CD27- and CD70-deficient patients. The excellent outcome after HSCT supports the timely implementation of this treatment modality particularly in patients presenting with malignant transformation to lymphoma.

**Conflict of interest:** No COI declared

**COI notes:**

**Preprint server:** No;

**Author contributions and disclosures:** SG and SKB designed the standard questionnaires, collected and analyzed the data. EJE, BP, GR designed, performed and analyzed the experiments. RJH; BE; and SC analyzed exome sequencing data, performed the variant filtering, Sanger validation and identified the mutations in P32 and P42; P43-45; P47-49 respectively. Y.Z., A.J.O. and C.G.-J. analyzed exome sequencing data and identified CD70 mutations for patients P40 and P41. FEC, SH, AM, KB, GD, SB, HA, SC provided patient samples. TM, AM, II. SH, CI, KB, EY, EU, MM, DB, TC, AKG, AIH, SB, EKA, AO, LK, DH, MP, RK, RM, PO, EM, BN, AW, JvM, PLAF, SC, FD, EGD, SB, GD, RPB, HvB, SL, MF, MG, TN, AA, NR, AI followed the patients, provided and interpreted clinical the data. E.G. and D.A.P. provided custom-built HLA class I tetramers. CSM supervised experimental design and data interpretation. KB, AJL, SGT conceptualized, initiated and supervised the study. SG, SKB, EJE and KB, AJL, SGT wrote the manuscript, which was reviewed and approved by all the authors.

**Non-author contributions and disclosures:** No;

**Agreement to Share Publication-Related Data and Data Sharing Statement:** Previously published patients data were indicated with references

**Clinical trial registration information (if any):**

## Extended clinical and immunological phenotype and transplant outcome in CD27 and CD70 deficiency

Sujal Ghosh<sup>1\*</sup>, Sevgi Kostel Bal<sup>2,3,4\*</sup>, Emily S. J. Edwards<sup>5,6\*</sup>, Bethany Pillay<sup>5,6</sup>, Raul Jimenez Heredia<sup>2,3,4</sup>, Funda Erol Cipe<sup>7</sup>, Geetha Rao<sup>5</sup>, Elisabeth Salzer<sup>2,3,4,8</sup>, Samaneh Zoghi<sup>2,3,4,10</sup>, Hassan Abolhassani<sup>9,10</sup>, Tooba Momen<sup>11</sup>, Emma Gostick<sup>12</sup>, David A. Price<sup>12,13</sup>, Yu Zhang<sup>14,15</sup>, Andrew J. Oler<sup>15,16</sup>, Claudia Gonzaga-Jauregui<sup>17</sup>, Baran Erman<sup>18,19</sup>, Ayse Metin<sup>20</sup>, Inci Ilhan<sup>21</sup>, Sule Haskologlu<sup>22</sup>, Candan Islamoglu<sup>22</sup>, Kubra Baskin<sup>22</sup>, Serdar Ceylaner<sup>23</sup>, Ebru Yilmaz<sup>24</sup>, Ekrem Unal<sup>24</sup>, Musa Karakukcu<sup>24</sup>, Dagmar Berghuis<sup>25</sup>, Theresa Cole<sup>26</sup>, Aditya K Gupta<sup>27</sup>, Fabian Hauck<sup>28</sup>, Andy IM Hoepelman<sup>29</sup>, Safa Baris<sup>30,31,32</sup>, Elif Karakoc-Aydiner<sup>30,31,32</sup>, Ahmet Ozen<sup>30,31,32</sup>, Leo Kager<sup>8</sup>, Dirk Holzinger<sup>33</sup>, Michael Paulussen<sup>34</sup>, Renate Krüger<sup>35</sup>, Roland Meisel<sup>1</sup>, Prasad T. Oommen<sup>1</sup>, Emma Morris<sup>36</sup>, Benedicte Neven<sup>37</sup>, Austen Worth<sup>38</sup>, Joris van Montfrans<sup>39</sup>, Pieter L A Fraaij<sup>40</sup>, Sharon Choo<sup>26</sup>, Figen Dogu<sup>22</sup>, E. Graham Davies<sup>38</sup>, Siobhan Burns<sup>36,41</sup>, Gregor Dückers<sup>42</sup>, Ruy Perez Becker<sup>42</sup>, Horst von Bernuth<sup>35,43,44</sup>, Sylvian Latour<sup>45</sup>, Maura Faraci<sup>46</sup>, Marco Gattorno<sup>47</sup>, Helen C. Su<sup>14,15</sup>, Qiang Pan-Hammarström<sup>48</sup>, Lennart Hammarström<sup>9,49</sup>, Michael J. Lenardo<sup>15,50</sup>, Cindy S Ma<sup>5,6</sup>, Tim Niehues<sup>42</sup>, Asghar Aghamohammadi<sup>10,51</sup>, Nima Rezaei<sup>10,51\*\*</sup>, Aydan Ikinciogullari<sup>22\*\*</sup>, Stuart G. Tangye<sup>5,6\*\*</sup>, Arjan C. Lankester<sup>25\*\*</sup>, Kaan Boztug<sup>2,3,4,8\*\*</sup> *On behalf of the Inborn Errors Working Party of ESID and EBMT.*

### Affiliations:

- <sup>1</sup> Department of Pediatric Oncology, Hematology and Clinical Immunology, Medical Faculty, Center of Child and Adolescent Health, Heinrich-Heine-University, Düsseldorf, Germany
- <sup>2</sup> CeMM Research Center for Molecular Medicine of the Austrian Academy of Sciences, Vienna, Austria
- <sup>3</sup> St. Anna Children's Cancer Research Institute (CCRI), Vienna, Austria
- <sup>4</sup> Ludwig Boltzmann Institute for Rare and Undiagnosed Diseases, Vienna, Austria
- <sup>5</sup> Garvan Institute of Medical research, Darlinghurst, NSW, Australia
- <sup>6</sup> St Vincent's Clinical School, UNSW Sydney, Randwick, NSW, Australia
- <sup>7</sup> Istinye University, Department of Pediatric Allergy and Immunology, Istanbul, Turkey
- <sup>8</sup> St. Anna Children's Hospital, Department of Pediatrics and Adolescent Medicine, Medical University of Vienna, Vienna, Austria
- <sup>9</sup> Division of Clinical Immunology, Department of Laboratory Medicine, Karolinska University Hospital Huddinge, Karolinska Institutet, Stockholm, Sweden
- <sup>10</sup> Research Center for Immunodeficiencies, Children's Medical Center, Tehran University of Medical Sciences, Tehran, Iran
- <sup>11</sup> Department of Allergy and Clinical Immunology, Child Growth and Development Research Center, Research Institute for Primordial Prevention of Non-Communicable Disease, Isfahan University of Medical Sciences, Isfahan, Iran
- <sup>12</sup> Division of Infection and Immunity, Cardiff University School of Medicine, Cardiff, UK
- <sup>13</sup> Vaccine Research Center, National Institute of Allergy and Infectious Disease, National Institutes of Health, Bethesda, USA
- <sup>14</sup> Laboratory of Clinical Immunology and Microbiology, Division of Intramural Research, NIAID, Bethesda, Maryland, USA.
- <sup>15</sup> Clinical Genomics Program, NIAID, NIH, Bethesda, Maryland, USA

- <sup>16</sup> Bioinformatics and Computational Biosciences Branch, Office of Cyber Infrastructure and Computational Biology, National Institute of Allergy and Infectious Diseases, National Institutes of Health, Bethesda, MD 20892, USA
- <sup>17</sup> Regeneron Genetics Center, Tarrytown, New York, USA.
- <sup>18</sup> Institute of Child Health, Hacettepe University, Ankara, Turkey
- <sup>19</sup> Can Sucak Research Laboratory for Translational Immunology, Center for Genomics and Rare Diseases, Hacettepe University, Ankara, Turkey
- <sup>20</sup> University of Health Sciences, Ankara City Hospital, Children's Hospital, Division of Pediatric Allergy and Immunology, Ankara, Turkey
- <sup>21</sup> University of Health Sciences, Ankara City Hospital, Children's Hospital, Division of Pediatric Oncology, Ankara, Turkey
- <sup>22</sup> Ankara University School of Medicine, Department of Pediatric Allergy and Immunology, Ankara, Turkey
- <sup>23</sup> Intergen Genetic Diagnosis and Research Center, Ankara, Turkey
- <sup>24</sup> Department of Pediatrics, Division of Pediatric Hematology & Oncology & Molecular Biology and Genetic Department, Gevher Nesibe Genom and Stem Cell Institution, GENKOK Genome and Stem Cell Center, Erciyes University, Kayseri, Turkey
- <sup>25</sup> Willem-Alexander Children's Hospital, Department of Pediatrics, Leiden University Medical Center, Leiden, The Netherlands
- <sup>26</sup> Department of Allergy and Immunology, The Royal Children's Hospital, Melbourne, Australia.
- <sup>27</sup> Department of Pediatrics, Division of Pediatric Oncology, All India Institute of Medical Sciences, New Delhi, India
- <sup>28</sup> Dr. von Hauner Children's Hospital, University Hospital, Ludwig Maximilian University of Munich, Munich, Germany.
- <sup>29</sup> Department of Internal Medicine and Infectious Diseases, University Medical Center Utrecht, Utrecht, the Netherlands.
- <sup>30</sup> Marmara University Division of Allergy and Immunology, Istanbul, Turkey
- <sup>31</sup> The Isil Berat Barlan Center for Translational Medicine, Istanbul, Turkey
- <sup>32</sup> Istanbul Jeffrey Modell Diagnostic and Research Center for Primary Immunodeficiencies, Istanbul, Turkey
- <sup>33</sup> Department of Pediatric Hematology-Oncology, University of Duisburg-Essen, Essen, Germany.
- <sup>34</sup> Witten/Herdecke University, Vestische Kinder- und Jugendklinik, Datteln, Germany.
- <sup>35</sup> Department of Pediatric Pulmonology, Immunology, and Intensive Care Medicine, Charité-Universitätsmedizin Berlin, Berlin, Germany.
- <sup>36</sup> Institute of Immunity & Transplantation, University College London, Royal Free Hospital, London, UK
- <sup>37</sup> Unité d'Immuno-Hématologie et Rhumatologie, Département de Pédiatrie and INSERM U1163, Imagine Institute, Université de Paris, Paris, France
- <sup>38</sup> Great Ormond Street Hospital for Children NHS Foundation Trust, UCL Great Ormond Street Institute of Child Health, London, UK.
- <sup>39</sup> Department of Pediatric Immunology and Infectious Diseases, Wilhelmina Children's Hospital, UMC Utrecht, The Netherlands.
- <sup>40</sup> Department of Viroscience, Erasmus MC, Rotterdam, The Netherlands, Department of Pediatrics, Subdivision Infectious Diseases and Immunology, Erasmus MC-Sophia, Rotterdam, The Netherlands
- <sup>41</sup> Department of Immunology, Royal Free London NHS Foundation Trust, London, United Kingdom.
- <sup>42</sup> Department of Pediatrics, Helios Children's Hospital, Krefeld, Germany
- <sup>43</sup> Department of Immunology, Labor Berlin GmbH, Berlin, Germany
- <sup>44</sup> Berlin-Brandenburg Center for Regenerative Therapies, Berlin, Germany
- <sup>45</sup> Laboratory of Lymphocyte Activation and Susceptibility to EBV infection, INSERM U1163, Imagine Institute, Université de Paris, Paris, France
- <sup>46</sup> Hematopoietic Stem Cell Transplantation Unit, IRCSS Istituto Giannina Gaslini Research Institute Genova, Italy
- <sup>47</sup> Center for Autoinflammatory Diseases and Immunodeficiency, IRCCS Istituto Giannina Gaslini, Genova, Italy.
- <sup>48</sup> Department of Biosciences and Nutrition - NEO, Karolinska Institutet, Sweden.
- <sup>49</sup> BGI-Shenzhen, Shenzhen, 518083, China.
- <sup>50</sup> Molecular Development of the Immune System Section, Laboratory of Immune System Biology, National Institute of Allergy and Infectious Diseases, National Institutes of Health, Bethesda, Maryland USA

Emily S.J. Edwards is currently at the Department of Immunology and Pathology, Central Clinical School,

Monash University, Melbourne, Victoria, Australia.

\* **S.G, S.K.B and E.E contributed equally.**

\*\* **N.R., A.I., S.G.T., A.C.L. and K.B. contributed equally.**

**Corresponding authors:**

Kaan Boztug

St. Anna Children's Cancer Research Institute (CCRI) and Ludwig Boltzmann Institute for Rare and Undiagnosed Diseases (LBI-RUD)

Zimmermannplatz 10, A-1090 Vienna, Austria

Phone: +43 1-40470-4080 Fax: +43-1-40170-7280

e-mail: [kaan.boztug@ccri.at](mailto:kaan.boztug@ccri.at)

Arjan C Lankester

Willem-Alexander Children's Hospital, Dep of Pediatrics, Leiden University Medical Center, 2300 RC Leiden, The Netherlands

phone: + 31-71-5262824, fax: +31-71-5248198

Email: [a.lankester@lumc.nl](mailto:a.lankester@lumc.nl)

Stuart G Tangye

Garvan Institute of Medical Research

384 Victoria St, Darlinghurst. NSW. 2010 Australia

Phone: +61 2 9295 8455; Fax: +61 2 9295 8404

e-mail: [s.tangye@garvan.org.au](mailto:s.tangye@garvan.org.au)

**Key Points:**

- CD27/CD70 deficiencies are IELs characterized by EBV-associated immunodysregulation including HLH, lymphoproliferation and malignancy.
- The excellent outcome following HSCT in cases with CD27/CD70 deficiency supports its timely use particularly in patients with lymphoma.

**Abstract**

Biallelic mutations in the genes encoding CD27 or its ligand CD70 underlie inborn errors of immunity characterized predominantly by EBV-associated immune dysregulation, such as chronic viremia, severe infectious mononucleosis, hemophagocytic lymphohistiocytosis (HLH), lymphoproliferation and malignancy. A comprehensive understanding of the natural history, immune characteristics and transplant outcomes has remained elusive. Here, in a multi-institutional global collaboration, we collected clinical information of 49 patients from 29 families (CD27 n=33, CD70 n=16), including 24 previously unreported individuals and identified a total of 16 distinct mutations in *CD27*, and 8 in *CD70*, respectively. The majority (90%) of patients were EBV<sup>+</sup> at diagnosis, but only ~30% presented with infectious mononucleosis. Lymphoproliferation and lymphoma were the main clinical manifestations (70% and 43%, respectively), and 9 of the CD27-deficient patients developed HLH. Twenty-one (43%) patients developed autoinflammatory features including uveitis, arthritis and periodic fever. Detailed immunological characterization revealed aberrant generation of memory B and T cells, including a paucity of EBV-specific T cells, and impaired effector function of CD8<sup>+</sup> T cells, thereby providing mechanistic insight into cellular defects underpinning the clinical features of disrupted CD27/CD70 signaling. Nineteen patients underwent allogeneic hematopoietic stem cell transplantation (HSCT) prior to adulthood predominantly because of lymphoma, with 95% survival without disease recurrence. Our data highlight the marked predisposition to lymphoma of both CD27- and CD70-deficient patients. The excellent outcome after HSCT supports the timely implementation of this treatment modality particularly in patients presenting with malignant transformation to lymphoma.

**Keywords:** CD27 deficiency, CD70 deficiency, EBV lymphoproliferation, Hodgkin lymphoma, Non-Hodgkin lymphoma, hemophagocytic lymphohistiocytosis, autoinflammation, hematopoietic stem cell transplantation

## Introduction

Epstein Barr Virus (EBV) is one of nine human herpesviruses and infects up to 90% of the adult population<sup>1</sup>. Upon primary exposure, EBV infects oropharyngeal epithelial cells and B-cells, but acquires latency and persists predominantly in B-cells<sup>1-3</sup>. Host defense against EBV is largely mediated by CD8<sup>+</sup> T cells and NK cells<sup>2,4-6</sup>. In immunocompetent hosts, EBV exposure during early childhood is often asymptomatic, but causes infectious mononucleosis (IM) in ~25% of infected adolescents<sup>2,3</sup>. In contrast, EBV infection is associated with significant morbidity and mortality in immunocompromised individuals. Thus, when the host-virus balance is disrupted, a wide range of EBV-associated immunopathologic conditions may arise, including lymphoproliferative disorders (LPD), hemophagocytic lymphohistiocytosis (HLH), and chronic active EBV infection (CAEBV). Severe EBV manifestations commonly occur in acquired T-cell immunodeficiencies, such as HIV-infection or iatrogenic immunosuppression following organ or hematopoietic stem cell transplantation (HSCT)<sup>3,4,7,8</sup>. Importantly, recent discoveries of single-gene defects presenting as severe and often fatal EBV-induced disease have defined cellular networks essential for controlling acute EBV infection. For instance, patients may be highly vulnerable to the pathogenic consequences of EBV infection due to germline-inherited loss-of-function mutations in *SH2D1A*, *XIAP*, *ITK*, *MAGT1*, *CTPS1*, *CORO1A*, *RASGRP1*, *STK4*, *CARMIL2*, *TNFRSF9*, *CD27* or *CD70* (ref.<sup>5,6,9-14</sup>).

*CD27* is a member of the tumor necrosis factor receptor superfamily expressed on a broad range of human lymphocytes including naïve and central memory T ( $T_{CM}$ )-cells, germinal center and memory B-cells, plasma cells and some NK cells<sup>15</sup>. By contrast, expression of its unique ligand *CD70* is restricted to activated lymphoid and myeloid cells<sup>15</sup>. *CD27* engagement by *CD70* provides costimulatory signals that enhance T-cell activation, survival, proliferation and differentiation<sup>15</sup>. *In vivo* studies established that *CD27* enhances generation and maintenance of antigen-specific CD4<sup>+</sup> and CD8<sup>+</sup> T-cells. Furthermore, deletion of *Cd27* in mice compromises cytotoxic CD8<sup>+</sup> T-cell responses to viral and bacterial infections<sup>15-19</sup>. *CD27* also has a role on human B-cells, promoting memory cell differentiation and plasma cell survival<sup>20</sup>. The non-redundant role of the *CD27-CD70* axis in humans has been revealed by the discovery of individuals with biallelic mutations in *CD27* (ref<sup>21-25</sup>) or *CD70* (ref<sup>24,26,27</sup>), who typically present with chronic EBV viremia, severe EBV-induced HLH, EBV-associated LPD, Hodgkin (HL) and Non-Hodgkin lymphoma (NHL) and/or hypogammaglobulinemia<sup>21-27</sup>. Patients also suffer from recurrent



bacterial and other viral infections, underlining a role for CD27/CD70 interactions in host defense beyond EBV<sup>5,6,21-24,26,27</sup>.

Due to the limited numbers of CD27- and CD70-deficient patients reported to date<sup>21-27</sup>, no consensus on treatment strategies has been defined. Here, we report the largest cohort of genetically defined CD27- and CD70-deficient patients providing unprecedented insights into the immunological characteristics, mechanisms of disease pathogenesis, clinical course of individual patients undergoing various treatments, including HSCT.

## Methods

### Patients and diagnosis

We performed a retrospective analysis of CD27- and CD70-deficient patients. Centers with patients were identified through the European Society for Immunodeficiencies (ESID)/European Society for Blood and Marrow Transplantation (EBMT) registry, published case reports and communication with defined expert clinicians working in the field. Questionnaires regarding patient demographics, clinical and laboratory features, transplant characteristics, and outcome were distributed. Analysis was performed using data collected for 49 patients from 20 centers worldwide. Diagnosis of CD27 or CD70 deficiency was made based on molecular genetics, and flow cytometry or Western blot in selected cases (Suppl. Fig. 1). Patients and families provided written informed consent in accordance with the Declaration of Helsinki. Study approval was granted by the institutional review boards, including Ethics Committees of University of Duesseldorf, Germany (3208), Royal Prince Alfred Hospital, Camperdown, Australia (X16-0210/LNR/16/RPAH/257), Royal Children's Hospital, Melbourne, Australia (33146A), and Medical University of Vienna, Austria (1796/2018), and the NIAID IRB. Data from 25 patients (P1-17, P26, P31, P34-39) have been previously published<sup>21-27</sup>, with additional information including longer-term follow-up collected for this study.

### Lymphocyte phenotyping and function

Peripheral blood was collected from healthy blood donors and patients with *CD27* or *CD70* mutations (Table 1)<sup>21-23</sup>. All samples were run at one site (Garvan Institute of Medical Research, Sydney, Australia); shipping controls, heterozygous healthy family members and numerous age-matched controls were also included in the analysis. Proportions of CD3<sup>+</sup>, CD4<sup>+</sup> T (CD3<sup>+</sup>CD4<sup>+</sup>), CD8<sup>+</sup> T (CD3<sup>+</sup>CD8<sup>+</sup>), B cells (CD20<sup>+</sup>); naïve (N; CD45RA<sup>+</sup>CCR7<sup>+</sup>), central memory (T<sub>CM</sub>; CD45RA<sup>-</sup>CCR7<sup>+</sup>), effector memory (T<sub>EM</sub>; CD45RA<sup>-</sup>CCR7<sup>-</sup>), CD45RA<sup>+</sup> revertant memory (T<sub>EMRA</sub>; CD45RA<sup>+</sup>CCR7<sup>-</sup>) cells; αβ (CD3<sup>+</sup>TCRαβ<sup>+</sup>) and γδ (CD3<sup>+</sup>TCRγδ<sup>+</sup>) T-cells; mucosal-associated invariant T (MAIT; CD3<sup>+</sup>TCRVα7.2<sup>+</sup>CD161<sup>+</sup>), NK (CD3<sup>-</sup>CD56<sup>+</sup>) and invariant NKT (iNKT) cells (CD3<sup>+</sup>TCRVα24<sup>+</sup>Vβ11<sup>+</sup>); transitional (CD20<sup>+</sup>CD10<sup>+</sup>CD27<sup>-</sup>), naive (CD20<sup>+</sup>CD10<sup>-</sup>CD27<sup>-</sup>), and memory (CD20<sup>+</sup>CD10<sup>-</sup>CD27<sup>+</sup>) B-cell subsets were determined by flow cytometry<sup>26,28-31</sup>. EBV- and CMV-specific CD8<sup>+</sup> T-cells were detected using MHC class I-specific tetramers<sup>26,28</sup>. For in-depth phenotyping PBMC were further stained with mAbs against specific cell surface and intracellular molecules<sup>26,28,29,31</sup>. Data was acquired on an LSRII

SORP or LSR Fortessa (Becton Dickinson) and analyzed using FlowJo (Tree Star). PBMCs or sorted CD8<sup>+</sup> T-cell subsets were isolated and cultured *in vitro* under various conditions. Proliferation, cytokine expression and secretion, apoptosis and expression of *FASLG* were then determined<sup>26,28,29</sup>.

### **Statistical analysis**

For single comparisons of independent groups, a Mann-Whitney test was performed. For multiple comparisons, a two-way analysis of variance (ANOVA) or multiple t-tests were applied. Analyses were performed with the use of PRISM software (GraphPad Software Inc).

## Results

### Demographic characteristics of patients with inborn errors in *CD27* or *CD70*

We reviewed clinical records of 49 patients from 29 unrelated families with a history of severe EBV-related diseases. Thirty-three patients from 19 families were diagnosed with *CD27* deficiency, while *CD70* mutations were detected in 16 patients from 10 families (Table 1). Gender distribution was balanced (25 male, 24 female). Mean age of patients was 18.8 (range: 5-46 years) and 16.7 (range: 5-40 years) years for *CD27*- and *CD70*-deficient cohorts. Average age of disease manifestation was 7.3 years (8 months-22 years) for *CD27* deficiency and 3.4 years (6 months-9 years) for *CD70* deficiency (Table 1). 7 of 49 patients (*CD27*: 6/33, *CD70*: 1/16) died of lymphoproliferation (n=4, *CD27* deficiency: P9 died of diffuse large B cell lymphoma (DLBCL), P10 died of LPD (earlier interpreted as DLBCL); P15 of HL, P31 of NHL) or infection (n=3, *CD27* deficiency: P2 succumbed to gram-positive sepsis during cytopenia, retrospectively interpreted as HLH; P17 to EBV pneumonia; 1 *CD70*-deficient patient (P41) succumbed to *P. jirovecii* infection post-HSCT). Twenty allogeneic HSCT procedures were performed in 19 patients, with 95% overall survival (Table 2, Suppl. Table 1). P14 and P36 suffered from severe IM-like presentation and encephalitis respectively, but remained symptom-free thereafter. Five individuals in our cohort (P4, P19, P22, P23, P48) remained clinically asymptomatic at time of analysis (*CD27* n=4; *CD70* n=1; 5, 14, 17, 23 and 38 years of age, respectively) and were identified by familial screening after detection of an affected family member. Only 3/5 asymptomatic patients had documented antibody formation against EBV. Thus, based on this cohort, clinical penetrance of *CD27* or *CD70* deficiency is ~90%

### Genetic characteristics

Thirty-one patients from 17 families had homozygous mutations in *CD27* (11 missense, 3 nonsense, 3 frameshift). One patient had compound heterozygous (1 nonsense + 1 missense) *CD27* mutations; one further patient had only 1 identified heterozygous (1 nonsense) *CD27* mutation<sup>23</sup>. We documented 16 unique pathogenic variants in *CD27*, 10/16 were novel (Figure 1A, Table 1A). All *CD70*-deficient patients (n=16) carried homozygous mutations (10 families: 5 missense, 2 nonsense, 3 frameshift) leading to 8 different genetic lesions (4/8 novel) (Figure 1A, Table 1B). The *CD27* p.C53Y and the *CD70* p.T111M variants were found in 4 and 3 unrelated families from the same geographic region, respectively, suggesting a founder effect. All mutations led to abolished or reduced expression of *CD27* or *CD70*

protein (not shown). Twenty mutations localized to the extracellular domain of CD27 or CD70, while only 1 CD70 (p.M1T) and 3 CD27 mutations (p.W7G, p.W8\*, p.C10\*) localized to the intracellular domain (Figure 1A). The mutations impacting cysteine residues (p.Y32C, p.C53Y, p.C96Y, p.R107C, p.R94C) are detrimental to the tertiary structure of CD27, whereas the remainder of the mutations impair the CD27-CD70 protein interaction<sup>32</sup>.

### **Clinical phenotype**

Consistent with previous reports on CD27 and CD70 deficiency<sup>21-27</sup>, the most common clinical features of the patients were EBV-related: IM (37%, 18/49 patients), LPD (37%, 18/49 patients) and/or lymphoma (43%, 21/49 patients) and HLH (18%, 9/49) (Figure 1B-C; Suppl. Table 1). EBV-positivity (evidenced by viremia, serology or histology) at diagnosis was detected in 31/33 CD27-deficient and 15/16 CD70-deficient patients. EBV load was available for 46 patients (mean EBV load:  $2.0 \times 10^6$  copies/ml; range: 0 -  $4.5 \times 10^7$ ). Lymphoproliferation was the major manifestation in 71% (35/49) of the cohort; lymphoma was diagnosed in 60% (21/35) of patients by biopsy, being the initial presenting symptom in 14/49. Interestingly, two patients developed EBV<sup>-</sup> HL. Thirty-six percent (12/33) of CD27-deficient and 56% (9/16) of CD70-deficient patients developed lymphoma at a median age of 8.5 and 3 years respectively. HL was the most prevalent malignancy (16/49), followed by NHL (n=7/49 patients, 14%: 2 unclassified B-NHL, 2 Burkitt, 3 DLBCL) (Table 1, Figure 1B). Five of 16 CD70-deficient patients suffered a relapse following initial remission after first treatment of HL, prompting allogeneic HSCT (Figure 2). All patients received a genetic diagnosis prior to HSCT.

HLH occurred in 27% (9/33) of CD27-deficient patients (median age of onset: 4 years), and was the initial presenting symptom in 4 individuals (Figure 1B-C, Suppl. Table 1). Notably, HLH progressed to lymphoproliferation within 1 year in 7/9 patients (Figure 2). 3/9 CD27-deficient patients with HLH underwent HSCT, while 5/9 patients responded to conventional treatment. 8/9 patients who developed HLH are currently alive, at a median follow-up of 4 years since HLH, one patient succumbed (P2) to infection (see above) (Figure 2). Interestingly, HLH was not observed in any CD70-deficient patients.

Various autoinflammatory features were reported in a total of 21 patients (*CD27* n=15; *CD70* n=5; 43% total) including periodic fever (n=10), oral ulcers or stomatitis (n=14), uveitis (n=7), arthritis (n=6) and vasculitis (n=1), without documentation of a causative infectious agent and/or autoantibodies. In four cases (P27, P35, P39, P40) rheumatological symptoms (uveitis, arthritis) occurred initially and were

treated before an EBV predisposition syndrome was suspected (Figure 1B-C and Suppl. Table 1). The autoinflammatory complications resolved following HSCT.

### **Infectious profile**

Beyond EBV-related symptoms, recurrent infections were common in our cohort, with viral infections – cytomegalovirus (CMV), herpes simplex virus, human herpes virus 6, varicella zoster virus, coxsackie – most frequent. Two patients suffered from viral encephalitis (P24: EBV and HHV6, P36: unknown etiology), causing intellectual disability in P36. P35 had severe varicella and P42 had herpes zoster. Recurrent respiratory tract infections occurred in 56% of patients (23/49). While fungus (*Candida*, *Aspergillus*, *Rhizopus*; 4 patients) and parasites (*Toxoplasma gondii*, *Giardia lamblia*; 5 patients) were occasionally isolated, these infections were likely secondary to immunosuppressive treatment for HLH and lymphoma rather than resulting directly from CD27 or CD70 deficiency.

### **Effect of CD27- and CD70-deficiency on lymphocyte differentiation *in vivo***

To determine the impact of *CD27* and *CD70* mutations on lymphocyte differentiation *in vivo*, we performed detailed flow cytometric analysis on PBMCs from 10 CD27-deficient (average age: 13.5 years; range: 1.5-32 years) and 11 CD70-deficient (average age: 12.5 years; range: 4-36) patients. While the healthy donors were older than some of the patients studied, proportions of lymphocyte subsets in peripheral blood are relatively stable between 5 years of age and adulthood<sup>30,33-35</sup>. Proportions of T-, B- and NK-cells were unaffected by *CD27* or *CD70* mutations (Figure 3A). However, CD8<sup>+</sup> T-cells were significantly increased in CD27-deficient patients and a similar trend noted for CD70 deficiency (Figure 3A), resulting in a significantly decreased CD4/CD8 ratio in CD27-deficient individuals (Figure 3B). While proportions of CD3<sup>+</sup> T-cells were intact for both genotypes,  $\gamma\delta$  T-cells were modestly but significantly increased in CD70-deficient patients accompanied by reduced  $\alpha\beta$  T-cells (Figure 3C). Proportions of MAIT, but not iNKT, cells were reduced in CD27/CD70 deficiency without reaching statistical significance (Figure 3D,E). NK cell subsets, defined by differential expression of CD56, revealed increased proportions of CD56<sup>hi</sup> and corresponding reductions in CD56<sup>dim</sup> cells in CD27/CD70 deficiency (Figure 3F).

### **CD27/CD70 interactions are required for the generation of memory B and T cells**

CD27 expression delineates memory B-cells<sup>36,37</sup>. Although this precludes defining distinct B-cell subsets in CD27-deficiency, flow cytometry revealed significantly reduced memory B-cell proportions in CD70-deficiency (Figure 3G). CD4<sup>+</sup> and CD8<sup>+</sup> T-cell subsets can be classified into 4 distinct populations: naïve (CD45RA<sup>+</sup>CCR7<sup>+</sup>); T<sub>CM</sub> (CD45RA<sup>-</sup>CCR7<sup>+</sup>); T<sub>EM</sub> (CD45RA<sup>-</sup>CCR7<sup>-</sup>) and T<sub>EMRA</sub> (CD45RA<sup>+</sup>CCR7<sup>-</sup>)<sup>38</sup>. Proportions of naïve CD4<sup>+</sup> T-cells were significantly increased and CD4<sup>+</sup> T<sub>CM</sub>-cells corresponding reduced in CD27/CD70-deficient patients (Figure 3H). Proportions of regulatory T-cells and circulating T follicular helper cells were intact in all patients (not shown). The CD8<sup>+</sup> T-cell compartment was also altered. In CD27 deficiency, naïve CD8<sup>+</sup> T-cells were reduced and T<sub>EM</sub>-cells increased, while CD70 deficiency yielded increased naïve CD8<sup>+</sup> T-cells and fewer T<sub>EM</sub>-cells. Despite these opposing observations, T<sub>CM</sub>-cells tended to be reduced in both genotypes (Figure 3I).

### **Impaired cytokine production and cytolytic function of CD27-deficient CD8<sup>+</sup> T cells**

To identify mechanisms underlying impaired immune cell function and subsequent infectious susceptibility due to abolished CD27/CD70 signaling, we studied functional responses of CD8<sup>+</sup> T-cells from individuals with *CD27* mutations. Consistent with CD70-deficient T-cells<sup>26</sup>, proliferation of CD4<sup>+</sup> and CD8<sup>+</sup> T-cells *in vitro* was unaltered by CD27 deficiency (not shown). In contrast, expression of granzyme-A and perforin was significantly reduced in CD27-deficient CD8<sup>+</sup> T<sub>EMRA</sub>-cells, and trended to be reduced in T<sub>EM</sub> cells (Figure 4A, B). Similarly, expression of CD107A - a correlate of degranulation – and IFN<sub>γ</sub> by CD8<sup>+</sup> T-cells following *ex vivo* stimulation was reduced by *CD27* mutations (Figure 4C). To extend these findings, we examined sort-purified CD8<sup>+</sup> T-cells. Expression and/or production of cytolytic (granzyme-A and B, perforin, CD107a) and effector (IFN<sub>γ</sub>, TNF<sub>α</sub>, IL-2) molecules were reduced for T<sub>CM/EM</sub> and T<sub>EMRA</sub>-cells from CD27-deficient individuals (Figure 4D, E). Thus, production of cytokines and granzymes by, and activation of the lytic machinery in, memory CD8<sup>+</sup> T-cells are compromised by CD27 deficiency. As CD27 co-stimulation maintains effector cells, thereby providing host defense following pathogen exposure<sup>15</sup>, we determined the impact of CD27 deficiency on T-cell survival. CD27-deficient PHA blasts exhibited greater death (Figure 4F) and significantly increased expression of *FASLG* (Figure 4G) upon TCR engagement compared to healthy donors. Thus, CD27-deficient CD8<sup>+</sup> T-cells are intrinsically more susceptible to apoptosis than CD27-sufficient CD8<sup>+</sup> T-cells.

### **Altered phenotype of EBV-specific T cells in CD27-deficient individuals**

EBV poses the greatest pathogenic threat to CD27/CD70-deficient individuals (Figure 1)<sup>21-27</sup>. Our previous studies found variable proportions of EBV-specific CD8<sup>+</sup> T-cells in CD70-deficient individuals<sup>26</sup>. Furthermore, CD70-deficient memory CD8<sup>+</sup> T-cells have reduced expression of 2B4 and NKG2D<sup>26</sup>, molecules critical for regulating CD8<sup>+</sup> T- and NK-cell mediated immunity against EBV-infected B cells<sup>5,6</sup>. Hence, we used peptide/MHC class I tetramers to identify EBV-specific CD8<sup>+</sup> T-cells. Frequencies of these cells were in the normal range in 2/7 patients, but approximated levels detected in HLA-mismatched controls in 5/7 patients, suggesting EBV-specific CD8<sup>+</sup> T-cells were negligible in these individuals (Figure 5A). CMV-specific CD8<sup>+</sup> T-cells were detected at comparable frequencies in CD27-deficient individuals and healthy donors (Figure 5B). The phenotype of EBV-specific CD8<sup>+</sup> T-cells in CD27-deficient patients was generally comparable to healthy donors (Figure 5C), with a predominance of T<sub>EM</sub> cells, and the remainder being T<sub>CM</sub> and T<sub>EMRA</sub><sup>39,40</sup>. However, similar to CD70 deficiency<sup>26</sup>, expression of NKG2D and 2B4 was reduced (~50%) on EBV-specific CD8<sup>+</sup> T-cells (Figure 5D, E), but not on CMV-specific CD8<sup>+</sup> T-cells (Figure 5E), from CD27-deficient patients. Expression of granzyme B and perforin by CD27-deficient EBV-specific CD8<sup>+</sup> T-cells was also reduced (Figure 5F). Overall, our results suggest CD27 deficiency selectively impairs the generation of EBV-specific CD8<sup>+</sup> T-cells, hence the function of these cells is likely compromised by lack of expression of key cytotoxic receptors.

### **Therapeutic interventions and outcome**

Given the wide and variable phenotypic spectrum of disease, therapeutic approaches were also variable. Hypogammaglobulinemia was detected in 18/49 patients (only in P5 prior to EBV infection) and they received IgG substitution (n=18/49) and antibiotic prophylaxis (n= 17/49), while patients with HLH received HLH-2004/HLH-1994 protocol. Patients with HL or NHL were treated according to disease-specific protocols (CHOP-based [Cyclophosphamide+ Hydroxydaunorubicin +vincristine+Prednisolon]). Relapse protocols (ABVD [Doxorubicin+Bleomycin+Vinblastine+Dacarbazine] and IGEV [Ifosfamide+ Gemcitabine +Vinorelbine+Prednisolone] regimen) with consecutive treatment with anti-CD30 (Brentuximab), autologous HSCT and radiotherapy were administered to patients with relapsed HL (P4, P5, P11, P12, P40).

### **HSCT and outcome**

11/33 (33%) CD27- and 8/16 (50%) CD70-deficient patients underwent HSCT (39% total). While the median age at disease onset was 3.0 years for both the CD27- (range 1-15 years) and CD70- (range 1-



9 years) deficiency subgroups, the median age at HSCT differs between the groups (CD27 5.0 years, range 2-18 years; CD70 10.0 years, range 5-18 years). Severe infection was the HSCT indication in only one of these patients. Indications for HSCT in the remaining 18 patients were persistent EBV viremia/LPD (n=4), HL/NHL (n=9) or a combination of these disease manifestations (LPD/viremia + HLH n=2, Lymphoma + HLH n=1, Lymphoma+LPD n=2) Median follow-up time in all our patients has been 2.0 years post-HSCT (range 1 year – 9.5 years).

In total 20 allogenic HSCT (in 19 patients) procedures (Table 2) were performed, the majority of patients received unrelated donor transplants (12/19). Seven patients were transplanted with matched related donors, four with 10/10 HLA-matched unrelated donors and 8 with mismatched unrelated donors, including 3 haploidentical transplants. Three of the unrelated donations used cord blood grafts. One patient received a TCR $\alpha\beta$ /CD19-depleted graft, in two patients haploidentical HSCT was performed with post-transplant cyclophosphamide prophylaxis.

The choice of conditioning regimen largely reflects the recommendation of the ESID-EBMT guidelines for inherited immune disorders and experience of the transplant community for patients with non-malignant disorders. Most patients were treated with a fludarabine-busulfan (n=8) or fludarabine-treosulfan based reduced-toxicity, but myeloablative regimen. Fludarabine-melphalan was used in two patients, and fludarabine-cyclophosphamide was used in one case prior to second transplant (P27). In one patient (P13) conditioning was discontinued after alemtuzumab and etoposide (as part of the HLH treatment) due to systemic toxicity and invasive fungal infection. Most patients received serotherapy with anti-thymocyte globulin (ATG, n=13), or alemtuzumab (n=3). For the 3 patients with haploidentical donors, one (P18) received a TCR $\alpha\beta$ /CD19-depleted graft, and two (P34, P41) received post-transplant cyclophosphamide as GVHD prophylaxis. In other patients, GvHD prophylaxis consisted mostly of cyclosporine A (CSA) (n=17) and mycophenolate mofetil (MMF) or methotrexate

At 1-year post-transplant, donor chimerism (>90% donor in whole blood) was documented in all patients. Acute graft versus host disease (GvHD) grade I/II and grade III-IV occurred in 7/19 (37%) and 3/19 (16%) patients, respectively. Limited chronic skin GvHD was seen in 3/19 patients, and two patients (P39, P44) had chronic GvHD. One patient developed severe engraftment syndrome and two patients with acute renal failure which fully recovered in both cases. No cases of sinusoidal obstruction syndrome or other toxicity were reported, even in the transplanted patients with HLH.

We observed infectious complications in 12/19 patients post-HSCT. Viremia resulted from reactivation of

CMV (n=4, one patient treated with virus-specific T-cells at day +60), EBV (n=3), adenovirus (n=2) and HHV6 (n=2). Two patients suffered from respiratory syncytial virus (RSV) pneumonia. It remains unclear whether viral reactivations other than EBV were already present prior to HSCT. One patient (P41) succumbed to *P. jiroveci* pneumonia at day +166.

At a median follow-up time of 2 years (range: 1-9.5 years), overall survival was 95% (100% [11/11] of CD27-deficient patients and 88% [7/8] of CD70-deficient patients). Importantly, lymphoma relapse or secondary malignancies have not occurred in any transplanted patients and all remain in continuous remission. Hence, event-free survival in the combined group, including death and relapse, is also 95%. At 1-year post-HSCT 16/18 surviving patients no longer require immunosuppression (Table 2). Within the untransplanted cohort (n= 31), six patients died (at 2, 4, 10, 20, 22 and 35 years of age) – four during their first malignant event (P9 died of DLBCL, P10 of LPD; P15 of HL, P31 of NHL), and 2 due to infections .

## Discussion

Combined immunodeficiencies due to germline biallelic mutations in *CD27* (ref.<sup>21</sup>) or *CD70* (ref.<sup>24,26</sup>), characterized by increased susceptibility to bacterial and viral infections, impaired humoral immunity and hypogammaglobulinemia, were first described in 2012 and 2017, respectively. The major pathogenic threat to these patients is EBV, causing chronic viremia and severe diseases including HLH, lymphoproliferation and lymphoma. A growing number of experts emphasize the need to implement immunological and EBV screening in most cases of HL or NHL<sup>41</sup>. However, there are no current definitions or “reference values” of immunological parameters or biomarkers in patients with malignancies prior to treatment. In our study, 61% of CD27- and 81% of CD70-deficient patients presented with EBV-associated lymphoproliferation or lymphoma often at a young age (median age CD27:11 years; CD70: 3 years), suggesting the inability to control EBV infection is a strong indication to raise attention among physicians taking care of these patients.

Besides lymphoma, a high number of CD27- and CD70-deficient patients experience autoinflammatory symptoms. *In vivo* analysis of gene-targeted mice established that CD27/CD70 costimulation inhibits Th17 differentiation, dampening Th17-mediated autoimmunity and inflammation<sup>42</sup>. The accumulation of autoinflammatory symptoms suggest a regulatory effect of CD27-CD70 signaling on fine-tuning immune responses. As seen in our cohort, some patients (P39, P40) are followed as PFAPA-like disorders for several years before typical CD27-CD70 disease manifestations occur. So far, no specific disease biomarkers exist, so clinical awareness is of paramount importance in patients with signs of autoinflammation, especially with atypical presentation or unusual/lack of response where CD27/CD70 defects should be considered.

The spectrum of EBV-associated diseases in patients with inborn errors of immunity (IEIs) results from defective CD8<sup>+</sup> T-cell activation, expansion and/or cytotoxicity that compromise immune-mediated control of EBV infection<sup>5,6,9,11,12,14</sup>. Patients with *CD27* or *CD70* mutations have increased CD8<sup>+</sup> T-cells and naïve CD4<sup>+</sup> T-cells, but reduced proportions of CD4<sup>+</sup> and CD8<sup>+</sup> T<sub>CM</sub> cells, MAIT cells, memory B-cells and EBV-specific CD8<sup>+</sup> T-cells. In contrast to the initial studies of *CD27* deficiency<sup>21,22</sup>, proportions of iNKT-cells were intact in both CD27- and CD70-deficient patients. CD27-deficient memory CD8<sup>+</sup> T-cells have reduced production of cytokines and cytotoxic molecules, reduced expression of NKG2D and 2B4, and increased apoptosis *in vitro*. Similar functional defects have been reported for CD70-deficient CD8<sup>+</sup> T-cells<sup>24,26</sup>. CD27-CD70 interactions are important for expansion of EBV-specific T-cells,

evidenced by lack of expansion of CD27-deficient T-cells in response to CD70-expressing EBV<sup>+</sup> B-cells, and impaired T-cell expansion - including EBV-specific T-cells – to CD70-deficient B-cells<sup>24</sup>. Collectively, these cellular defects likely manifest as impaired cytotoxic T-cell-mediated control of EBV-infected B-cells, resulting in EBV-associated disease. These cellular and functional defects, together with a lack of detectable expression of CD27 or CD70 on patient immune cells, could be used as biomarkers for the early identification and putative diagnosis of individuals with inactivating mutations in *CD27* or *CD70*. Interestingly, the spectrum of clinical manifestations varied between patients in the same family, including identification of asymptomatic individuals with biallelic *CD27* mutations, indicating that additional mechanisms including environmental factors may contribute to the variable penetrance of this genetic disease.

CD27/CD70 signaling is unequivocally non-redundant for EBV immune surveillance. The clinical phenotype of CD27 and CD70-deficiency phenocopy each other with regards to disease presentation, yet there are notable differences. Age of onset is earlier in CD70 deficiency with greater incidence of hypogammaglobulinemia and lymphoma, whereas HLH is so far only seen in CD27 deficiency. Curiously, we recorded malignancies in 50% of family members carrying heterozygous *CD70* mutations consistent with initial findings<sup>26</sup>. However only 21% of heterozygous *CD27* mutation carriers reported malignant events. These differences might be due to relatively disproportional sizes of the two cohorts and selection bias resulting from the more recent discovery of CD70 deficiency. Targeting the CD27/CD70 pathway as a therapy for autoimmune diseases and cancers is being tested clinically<sup>43-46</sup>. It remains unclear whether CD27/CD70 have cell-intrinsic roles in tumorigenesis which may explain the difference in lymphoma occurrence<sup>47-49</sup>. Notably, CD70 ligation can induce apoptosis of EBV-transformed human B-cell lines<sup>50</sup>. This may explain the excess of malignancies associated with *CD70* mutations.

Following diagnosis, the decision on the therapeutic regimen remains a challenge. While HSCT is the only cure for individuals with refractory or relapsed malignancies, treatment strategies in less severely affected patients differ broadly. Unlike patients with classical cytotoxicity defects, most patients in our cohort with HLH developed further lymphoproliferation. Therefore, persistent EBV viremia could be a biomarker to alert clinicians to the necessity of early curative interventions<sup>41</sup>. The high mortality of CD27-deficient patients during their first malignant event, combined with excellent event-free survival post-HSCT, strongly supports consideration of curative HSCT, guided by relatively mild disease

manifestations or positive family history, as demonstrated recently for other genetic forms of HLH<sup>51</sup>. Recent studies on HSCT in IEIs have demonstrated encouraging results are not only obtained with matched but also alternative donor sources, including haploidentical<sup>29,52-54</sup>. Based on our data that heterozygous carrier status of CD27/70 deficiency may be associated with increased risk for malignancy, we would preferably recommend usage of suitable non-related donors for allogeneic HSCT, if available.

The aggressive clinical course and/or lack of a genetic diagnosis in most of these cases hindered the use of a rescue HSCT. Notably, a recent study demonstrates the feasibility and curative potential of HSCT in IEI patients with lymphoproliferative disorders even in those without complete remission at HSCT<sup>55</sup>. A restrained attitude is often observed regarding preemptive HSCT, especially in adolescent and adult patients, even following a first malignant event explainable by the usually less favorable HSCT outcomes. However, recent HSCT studies in adolescent and young adult IEI patients have demonstrated encouraging results<sup>56,57</sup>.

In conclusion, we report the heterogeneous spectrum and clinical course in a large cohort of patients with CD27 and CD70 deficiency which often manifest following EBV infection. These findings further highlight the critical role of the CD27-CD70 axis in regulating cellular immunity in humans, especially in the context of EBV control and lymphomagenesis. Importantly, this relates to both EBV<sup>+</sup> and EBV<sup>-</sup> B-cell lymphomas, revealed by the key role that CD27/CD70 interaction plays in enabling antigen-presenting B-cells to efficiently activate cytotoxic lymphocytes<sup>5,6</sup>. The excellent outcome after HSCT in CD27- or CD70-deficient patients with severe disease manifestations emphasizes that HSCT needs timely consideration as a definitive treatment, especially in patients with malignant transformation to lymphoma.

## **Acknowledgments**

The authors thank the patients and their families for participating in the study and Helen Matthews for regulatory and logistical assistance.

## **Authorship Contributions**

SG and SKB designed the standard questionnaires, collected and analyzed the data. EJE, BP, GR designed, performed and analyzed the experiments. RJH; BE; and SC analyzed exome sequencing data, performed the variant filtering, Sanger validation and identified the mutations in P32 and P42; P43-45; P47-49 respectively. Y.Z., A.J.O. and C.G.-J. analyzed exome sequencing data and identified *CD70* mutations for patients P40 and P41. FEC, SH, AM, KB, GD, SB, HA, SC provided patient samples. TM, AM, II. SH, CI, KB, EY, EU, MM, DB, TC, AKG, AIH, SB, EKA, AO, LK, DH, MP, RK, RM, PO, EM, BN, AW, JvM, PLAF, SC, FD, EGD, SB, GD, RPB, HvB, SL, MF, MG, TN, AA, NR, AI followed the patients, provided and interpreted clinical the data. E.G. and D.A.P. provided custom-designed HLA class I tetramers. CSM supervised experimental design and data interpretation. KB, AJL, SGT conceptualized, initiated, supervised and funded the study. SG, SKB, EJE and KB, AJL, SGT wrote the manuscript, which was reviewed and approved by all the authors.

## **Conflict of Interest Disclosures**

### **Funding source:**

This work was funded by the European Research Council (ERC Consolidator Grant 820074 to KB) and by the Austrian Science Fund (FWF) (Project P29951-B30 to KB) and The Susan and John Freeman Cancer Research Grant from Cancer Council NSW (Australia), and the National Health and Medical Research Council of Australia (1127157 to ST). D.A.P. was supported by a Wellcome Trust Senior Investigator Award (100326/Z/12/Z). C.S.M is supported by a Mid-Career Research Fellowship awarded by the Office of Health and Medical Research of the New South Wales Government of Australia. S.G.T was supported by a Principal Research Fellowship (104925) and a Peter Doherty Leadership Grant (176665) awarded from the NHMRC. F.H. received funding from the German Centre for Infection Research (DZIF, TTU 07.909), the Else Kröner-Fresenius Stiftung (EKFS, 2017\_A110), and the German Federal Ministry of Education and Research (BMBF, 01GM1910C). A.W and E.G.D. are supported by the UK National Institute of Health Research and the Great Ormond Street Hospital Biomedical

Research Centre. Y.Z., H.C.S., and M.J.L. are supported by funds from the Intramural Research Program of the National Institute of Allergy and Infectious Diseases, National Institutes of Health

**Declaration of interest:** None

**Figure 1: Clinical and genetic features of patients harboring mutations in *CD27* and *CD70*.** A. Identified variants in *CD27* (top) and *CD70* (bottom). Corresponding publications for previously reported mutations are indicated in brackets. B. Comparison of clinical findings and outcomes in *CD27*- and *CD70*-deficient patients. C. Clinical manifestations in *CD27* and *CD70* deficiencies. RTI: Respiratory tract infections, LPD: lymphoproliferative disease, CAEBV: Chronic active EBV, HL: Hodgkin lymphoma, NHL: Non-Hodgkin lymphoma, HLH: hemophagocytic lymphohistiocytosis, HSCT: hematopoietic stem cell transplantation, IBD: inflammatory bowel disease.

**Figure 2: Clinical course of patients having *CD27* and *CD70* mutations.** The scheme depicts the main clinical characteristics, therapeutic interventions and outcome of *CD27*- and *CD70*-deficient patients within the follow-up time of each individual patient.

**Figure 3: Impact of *CD27* and *CD70* mutations in lymphocyte differentiation in vivo.**

PBMC from healthy controls (n=18-26), *CD27*-deficient (n=10) or *CD70*-deficient (n=7-11) patients were labelled with mAbs against CD3, CD4, CD8, CD56, CD20, CD10, CD27, CD161, TCR V $\beta$ 11, TCR V $\alpha$ 7-2, TCR V $\alpha$ 24, CCR7 and CD45RA. A. Proportions of total (CD3<sup>+</sup>), CD4<sup>+</sup> (CD3<sup>+</sup>CD4<sup>+</sup>CD8<sup>-</sup>) and CD8<sup>+</sup> (CD3<sup>+</sup>CD4<sup>-</sup>CD8<sup>+</sup>) T cells, B cells (CD20<sup>+</sup>) and NK cells (CD3<sup>-</sup>CD56<sup>+</sup>) in peripheral lymphocytes of healthy donors and patients. (B) Ratio of CD4/CD8 T cells. (C) proportions of CD3<sup>+</sup> T cells expressing  $\alpha\beta$  or  $\gamma\delta$  TCR. (D, E) proportions of MAIT (D) or NKT (E) cells within the total CD3<sup>+</sup> T cell population. (F) proportions of CD56<sup>hi</sup> and CD56<sup>dim</sup> NK subsets within the total NK population. (G) proportions of transitional, naïve and memory B cells within the total B cell population. (H, I) proportion of CD4<sup>+</sup> (H) and CD8<sup>+</sup> (I) cells with a naïve, T<sub>CM</sub>, T<sub>EM</sub> or T<sub>EMRA</sub> phenotype. Statistics performed using ANOVA. \*p<0.05, \*\*p<0.01.

**Figure 4: *CD27* deficiency compromises effector function and survival of CD8<sup>+</sup> T cells**

A, B: PBMCs were stained with mAbs to CD8, CCR7, CD45RA, granzyme B and perforin. Expression levels of (A) Granzyme B or (B) by CD8<sup>+</sup> T<sub>CM</sub>, T<sub>EM</sub> and T<sub>EMRA</sub> cells were determined relative to naïve CD8<sup>+</sup> T cells (normalized to 1.0).

C: PBMCs from healthy individuals (n=5) and CD27-deficient individuals (n=5) were stimulated for 14 hours (PMA/ionomycin) in the presence of Brefeldin A and monensin. Percentage of cells expressing IFN- $\gamma$ , TNF, IL-2 or CD107a was determined by intracellular staining and flow cytometric analysis.

D, E. CD8<sup>+</sup> memory (T<sub>CM</sub>/T<sub>EM</sub>; D) and T<sub>EMRA</sub> (E) cells were sort-purified from healthy individuals (n=6) and CD27-deficient individuals (n=4) and cultured with anti-CD2/CD3/CD28 mAbs for 5 days. Proportions of cells expressing IFN $\gamma$ , CD107a or perforin were determined by intracellular staining and flow cytometry; secretion of IFN $\gamma$ , TNF $\alpha$ , IL-2, granzyme A and B were determined by cytometric bead arrays.

F, G: PHA blasts were expanded from PBMCs from healthy donors (n=5) and CD27-deficient patients (n=3). After 5-7 days the cells were restimulated with plate-bound  $\alpha$ -CD3. (F) Percentage of apoptotic cells was determined after 24 hours. (G) Relative expression of *FASLG* expression was determined after 4 hours stimulation with  $\alpha$ -CD3 mAb (normalized to PHA blasts from healthy donors).

For all graphs, values represent mean  $\pm$  SEM. Statistics performed using t tests with Mann-Whitney tests. \*P<0.05, \*\* P<0.01.

**Figure 5: Impaired generation and function of EBV-specific CD8<sup>+</sup> T cells in CD27-deficient individuals.** (A, B) PBMCs from healthy HLA mismatched, HLA matched (n=4-8), and CD27-deficient patients (n=4-7) were stained with specific EBV- or CMV-peptide-MHC class I tetramers, mAbs to CD4, CD8, CCR7, CD45RA, CD57, CD95, PD-1, 2B4 and NKG2D. EBV-specific and CMV-specific CD8<sup>+</sup> T cells quantified in HLA mismatched or matched controls and CD27-deficient patients, presented for all individuals as well as based on the specific HLA alleles (HLA-A\*0201, HLA-A\*2402 or HLA B\*0702) Statistics were performed using ANOVA; \*P<0.05. (C) Distribution of EBV-specific CD8<sup>+</sup> T cells in the naïve, T<sub>CM</sub>, T<sub>EM</sub> and T<sub>EMRA</sub> CD8<sup>+</sup> T cell populations in HLA matched controls and CD27-deficient patients. (D) Expression of 2B4 and NKG2D on EBV-specific CD8<sup>+</sup> T cells from healthy control and CD27-deficient patients. (E) Relative expression of 2B4 and NKG2D on EBV- and CMV-specific CD8<sup>+</sup> T cells from CD27-deficient patients determined by calculating fold change relative to virus-specific CD8<sup>+</sup> T cells from HLA-matched donors. (F) PBMCs were stained ex vivo with EBV-specific HLA tetramer, and mAbs



to CD8, granzyme B and perforin. Expression of granzyme B or perforin in EBV-specific CD8<sup>+</sup> T cells from CD27-deficient patients was determined relative to that in EBV-specific CD8<sup>+</sup> T cells from healthy donors.

## References

1. Zamora MR. DNA viruses (CMV, EBV, and the herpesviruses). *Semin Respir Crit Care Med*. 2011;32(4):454-470.
2. Rickinson AB, Long HM, Palendira U, Munz C, Hislop AD. Cellular immune controls over Epstein-Barr virus infection: new lessons from the clinic and the laboratory. *Trends Immunol*. 2014;35(4):159-169.
3. Thorley-Lawson DA, Gross A. Persistence of the Epstein-Barr virus and the origins of associated lymphomas. *N Engl J Med*. 2004;350(13):1328-1337.
4. Taylor GS, Long HM, Brooks JM, Rickinson AB, Hislop AD. The immunology of Epstein-Barr virus-induced disease. *Annu Rev Immunol*. 2015;33:787-821.
5. Tangye SG. Genetic susceptibility to EBV infection: insights from inborn errors of immunity. *Hum Genet*. 2020.
6. Tangye SG, Latour S. Primary immunodeficiencies reveal the molecular requirements for effective host defense against EBV infection. *Blood*. 2020;135(9):644-655.
7. Bibas M, Antinori A. EBV and HIV-Related Lymphoma. *Mediterr J Hematol Infect Dis*. 2009;1(2):e2009032.
8. Young LS, Rickinson AB. Epstein-Barr virus: 40 years on. *Nat Rev Cancer*. 2004;4(10):757-768.
9. Tangye SG. XLP: clinical features and molecular etiology due to mutations in SH2D1A encoding SAP. *J Clin Immunol*. 2014;34(7):772-779.
10. Li FY, Chaigne-Delalande B, Su H, Uzel G, Matthews H, Lenardo MJ. XMEN disease: a new primary immunodeficiency affecting Mg2+ regulation of immunity against Epstein-Barr virus. *Blood*. 2014;123(14):2148-2152.
11. Tangye SG, Palendira U, Edwards ES. Human immunity against EBV-lessons from the clinic. *J Exp Med*. 2017;214(2):269-283.
12. Latour S, Fischer A. Signaling pathways involved in the T-cell-mediated immunity against Epstein-Barr virus: Lessons from genetic diseases. *Immunol Rev*. 2019;291(1):174-189.
13. Alosaimi MF, Hoenig M, Jaber F, et al. Immunodeficiency and EBV-induced lymphoproliferation caused by 4-1BB deficiency. *J Allergy Clin Immunol*. 2019;144(2):574-583 e575.
14. Latour S, Winter S. Inherited Immunodeficiencies With High Predisposition to Epstein-Barr Virus-Driven Lymphoproliferative Diseases. *Front Immunol*. 2018;9:1103.
15. Nolte MA, van Olfen RW, van Gisbergen KP, van Lier RA. Timing and tuning of CD27-CD70 interactions: the impact of signal strength in setting the balance between adaptive responses and immunopathology. *Immunol Rev*. 2009;229(1):216-231.
16. Borst J, Hendriks J, Xiao Y. CD27 and CD70 in T cell and B cell activation. *Curr Opin Immunol*. 2005;17(3):275-281.
17. Hendriks J, Gravestain LA, Tesselaar K, van Lier RA, Schumacher TN, Borst J. CD27 is required for generation and long-term maintenance of T cell immunity. *Nat Immunol*. 2000;1(5):433-440.
18. Hendriks J, Xiao Y, Borst J. CD27 promotes survival of activated T cells and complements CD28 in generation and establishment of the effector T cell pool. *J Exp Med*. 2003;198(9):1369-1380.
19. Munitic I, Kuka M, Allam A, Scoville JP, Ashwell JD. CD70 deficiency impairs effector CD8 T cell generation and viral clearance but is dispensable for the recall response to lymphocytic choriomeningitis virus. *J Immunol*. 2013;190(3):1169-1179.
20. Avery DT, Ellyard JI, Mackay F, Corcoran LM, Hodgkin PD, Tangye SG. Increased expression of CD27 on activated human memory B cells correlates with their commitment to the plasma cell lineage. *J Immunol*. 2005;174(7):4034-4042.
21. van Montfrans JM, Hoepelman AI, Otto S, et al. CD27 deficiency is associated with combined immunodeficiency and persistent symptomatic EBV viremia. *J Allergy Clin Immunol*. 2012;129(3):787-793 e786.
22. Salzer E, Daschkey S, Choo S, et al. Combined immunodeficiency with life-threatening EBV-associated lymphoproliferative disorder in patients lacking functional CD27. *Haematologica*. 2013;98(3):473-478.
23. Alkhairy OK, Perez-Becker R, Driessen GJ, et al. Novel mutations in TNFRSF7/CD27: Clinical, immunologic, and genetic characterization of human CD27 deficiency. *J Allergy Clin Immunol*. 2015;136(3):703-712 e710.
24. Izawa K, Martin E, Soudais C, et al. Inherited CD70 deficiency in humans reveals a critical role for the CD70-CD27 pathway in immunity to Epstein-Barr virus infection. *J Exp Med*. 2017;214(1):73-89.
25. Kishore R, Gupta A, Gupta AK, Kabra SK. Novel mutation in the CD27 gene in a patient presenting with hypogammaglobulinemia, bronchiectasis and EBV-driven lymphoproliferative disease. *BMJ Case Rep*. 2020;13(2).

26. Abolhassani H, Edwards ES, Ikinciogullari A, et al. Combined immunodeficiency and Epstein-Barr virus-induced B cell malignancy in humans with inherited CD70 deficiency. *J Exp Med*. 2017;214(1):91-106.
27. Caorsi R, Rusmini M, Volpi S, et al. CD70 Deficiency due to a Novel Mutation in a Patient with Severe Chronic EBV Infection Presenting As a Periodic Fever. *Front Immunol*. 2017;8:2015.
28. Edwards ESJ, Bier J, Cole TS, et al. Activating PIK3CD mutations impair human cytotoxic lymphocyte differentiation and function and EBV immunity. *J Allergy Clin Immunol*. 2019;143(1):276-291 e276.
29. Pillay BA, Avery DT, Smart JM, et al. Hematopoietic stem cell transplant effectively rescues lymphocyte differentiation and function in DOCK8-deficient patients. *JCI Insight*. 2019;5.
30. Avery DT, Kane A, Nguyen T, et al. Germline-activating mutations in PIK3CD compromise B cell development and function. *J Exp Med*. 2018;215(8):2073-2095.
31. Payne K, Li W, Salomon R, Ma CS. OMIP-063: 28-Color Flow Cytometry Panel for Broad Human Immunophenotyping. *Cytometry A*. 2020.
32. Teplyakov A, Obmolova G, Malia TJ, Gilliland GL. Crystal structure of CD27 in complex with a neutralizing noncompeting antibody. *Acta Crystallogr F Struct Biol Commun*. 2017;73(Pt 5):294-299.
33. Tosato F, Bucciol G, Pantano G, et al. Lymphocytes subsets reference values in childhood. *Cytometry A*. 2015;87(1):81-85.
34. Schatorje EJ, Gemen EF, Driessen GJ, Leuvenink J, van Hout RW, de Vries E. Paediatric reference values for the peripheral T cell compartment. *Scand J Immunol*. 2012;75(4):436-444.
35. Garcia-Prat M, Alvarez-Sierra D, Aguilo-Cucurull A, et al. Extended immunophenotyping reference values in a healthy pediatric population. 2019;96(3):223-233.
36. Klein U, Rajewsky K, Kuppers R. Human immunoglobulin (Ig)M+IgD+ peripheral blood B cells expressing the CD27 cell surface antigen carry somatically mutated variable region genes: CD27 as a general marker for somatically mutated (memory) B cells. *J Exp Med*. 1998;188(9):1679-1689.
37. Tangye SG, Liu YJ, Aversa G, Phillips JH, de Vries JE. Identification of functional human splenic memory B cells by expression of CD148 and CD27. *J Exp Med*. 1998;188(9):1691-1703.
38. Sallusto F, Lenig D, Forster R, Lipp M, Lanzavecchia A. Two subsets of memory T lymphocytes with distinct homing potentials and effector functions. *Nature*. 1999;401(6754):708-712.
39. Callan MF, Tan L, Annels N, et al. Direct visualization of antigen-specific CD8+ T cells during the primary immune response to Epstein-Barr virus In vivo. *J Exp Med*. 1998;187(9):1395-1402.
40. Hislop AD, Annels NE, Gudgeon NH, Leese AM, Rickinson AB. Epitope-specific evolution of human CD8(+) T cell responses from primary to persistent phases of Epstein-Barr virus infection. *J Exp Med*. 2002;195(7):893-905.
41. Bomken S, van der Werff Ten Bosch J, Attarbaschi A, et al. Current Understanding and Future Research Priorities in Malignancy Associated With Inborn Errors of Immunity and DNA Repair Disorders: The Perspective of an Interdisciplinary Working Group. *Front Immunol*. 2018;9:2912.
42. Coquet JM, Middendorp S, van der Horst G, et al. The CD27 and CD70 costimulatory pathway inhibits effector function of T helper 17 cells and attenuates associated autoimmunity. *Immunity*. 2013;38(1):53-65.
43. Jacobs J, Deschoolmeester V, Zwaenepoel K, et al. CD70: An emerging target in cancer immunotherapy. *Pharmacol Ther*. 2015;155:1-10.
44. Wajant H. Therapeutic targeting of CD70 and CD27. *Expert Opin Ther Targets*. 2016;20(8):959-973.
45. Boleto G, Allanore Y, Avouac J. Targeting Costimulatory Pathways in Systemic Sclerosis. *Front Immunol*. 2018;9:2998.
46. Starzer AM, Berghoff AS. New emerging targets in cancer immunotherapy: CD27 (TNFRSF7). *ESMO Open*. 2020;4(Suppl 3).
47. de Miranda NF, Georgiou K, Chen L, et al. Exome sequencing reveals novel mutation targets in diffuse large B-cell lymphomas derived from Chinese patients. *Blood*. 2014;124(16):2544-2553.
48. Riether C, Schurch CM, Buhner ED, et al. CD70/CD27 signaling promotes blast stemness and is a viable therapeutic target in acute myeloid leukemia. *J Exp Med*. 2017;214(2):359-380.
49. Scholtysik R, Nagel I, Kreuz M, et al. Recurrent deletions of the TNFSF7 and TNFSF9 genes in 19p13.3 in diffuse large B-cell and Burkitt lymphomas. *Int J Cancer*. 2012;131(5):E830-835.
50. Park GB, Kim YS, Lee HK, et al. Endoplasmic reticulum stress-mediated apoptosis of EBV-transformed B cells by cross-linking of CD70 is dependent upon generation of reactive oxygen species and activation of p38 MAPK and JNK pathway. *J Immunol*. 2010;185(12):7274-7284.
51. Lucchini G, Marsh R, Gilmour K, et al. Treatment dilemmas in asymptomatic children with primary hemophagocytic lymphohistiocytosis. *Blood*. 2018;132(19):2088-2096.
52. Balashov D, Shcherbina A, Maschan M, et al. Single-Center Experience of Unrelated and Haploidentical Stem Cell Transplantation with TCRalpha/beta and CD19 Depletion in Children with Primary Immunodeficiency Syndromes. *Biol Blood Marrow Transplant*. 2015;21(11):1955-1962.
53. Bertaina A, Merli P, Rutella S, et al. HLA-haploidentical stem cell transplantation after removal of alpha/beta+ T and B cells in children with nonmalignant disorders. *Blood*. 2014;124(5):822-826.
54. Shah RM, Elfeky R, Nademi Z, et al. T-cell receptor alpha/beta(+) and CD19(+) cell-depleted haploidentical and mismatched hematopoietic stem cell transplantation in primary immune deficiency. *J Allergy Clin Immunol*. 2018;141(4):1417-1426 e1411.
55. Prunotto G, Offor UT, Samarasinghe S, et al. HSCT provides effective treatment for lymphoproliferative disorders in children with primary immunodeficiency. *J Allergy Clin Immunol*. 2020.

56. Fox TA, Chakraverty R, Burns S, et al. Successful outcome following allogeneic hematopoietic stem cell transplantation in adults with primary immunodeficiency. *Blood*. 2018;131(8):917-931.
57. Morris EC, Albert MH. Allogeneic HSCT in Adolescents and Young Adults With Primary Immunodeficiencies. *Front Pediatr*. 2019;7:437.

## TABLES

**Table 1. A) Clinical features and genetic variants of patients with CD27 deficiency**

	Age at onset	Age at diagnosis	Sex	Ethnicity	Consanguinity	Mutation (NM_001242.5)	Infections	EBV related symptoms	EBV load (max)	Malignancy	Other symptoms
<b>P1</b>	2	21	M	Moroccan	+	c.G24A, p.W8*	No	IM	3000`	-	
<b>P2</b>	3	PM	M	Moroccan	+	c.G24A, p.W8*	sepsis due to cytopenia	IM, possibly HLH (DD aplastic anemia)	2050	-	uveitis
<b>P3</b>	1	1	F	Turkish	+	c.G158A, p.C53Y	LRTI, sepsis, phlegmons	HLH, LPD	2000000	-	-
<b>P4</b>	NA	12	M	Turkish	+	c.G158A, p.C53Y	-	-	0	-	-
<b>P5</b>	1	0	F	Turkish	+	c.G158A, p.C53Y	phlegmons	IM	4400		arthritis
<b>P6</b>	1	4	M	Lebanese	-	c.G158A, p.C53Y	recurrent infections	LPD, HLH	5000000	-	oral ulcers
<b>P7</b>	1	1	F	Lebanese	-	c.G158A, p.C53Y	URTI	meningitis	8000000	-	oral ulcers, uveitis
<b>P8</b>	15	19	M	Lebanese	+	c.G158A, p.C53Y	-	CAEBV, LPD	25000000	-	oral ulcers, uveitis
<b>P9</b>	2	PM	F	Lebanese	+	c.G158A, p.C53Y	-	LPD	na	DLBCL (EBV+)	oral ulcers
<b>P10</b>	22	PM	F	Lebanese	+	c.G158A, p.C53Y	-	CAEBV, LPD	270000	-	
<b>P11</b>	4	9	F	German	-	het c.C30A / p.C10*	-	LPD, HLH	1000000	-	-
<b>P12</b>	13	17	F	German	-	c.G24A/ c.C319T p.W8* / p.R107C	ulcers	CAEBV	320000	mc-HL	oral ulcers, uveitis
<b>P13</b>	7	7	F	Turkish	+	c.G287A p.C96Y	LRTI	LPD, HLH	2200000	-	-
<b>P14</b>	6	13	F	Turkish	+	c.G287A p.C96Y	-	IM	0	-	-
<b>P15</b>	6	PM	F	Iranian	+	c.G287A p.C96Y	RTI, skin abscesses bronchiectasis, toxoplasmosis	IM	3700	ns-HL	recurrent fever, eczema
<b>P16</b>	8	32	M	Iranian	+	c.G287A p.C96Y	URTI	IM	930	ns-HL	
<b>P17</b>	8	PM	F	Iranian	+	c.C232T	recurrent	IM, EBV	930	-	recurrent

7						p.R78W	infections	pneumonia			fever, stomatitis recurrent fever
P18	2	2	F	Syrian	+	c.266_267del p.S89Wfs*14	-	HLH, LPD	259000	DLBCL	
P19	NA	2	M	Syrian	+	c.266_267del p.S89Wfs*14	-		626		
P20	15	20	F	Iraqi	na	c.G158A p.C53Y	-	viremia	1200	ns-HL	
P21	13	13	M	Iraqi	na	c.G158A p.C53Y	-	viremia	32195	mc-HL	
P22	NA	30	M	Bangladeshi		c.C280T p.R94C			45031		asthma, eczema
P23	NA	8	M	Bangladeshi		c.C280T p.R94C		viremia	16652		
P24	8 mo	7	M	Bangladeshi		c.C280T p.R94C	URTI	EBV encephalitis	2000000		vasculitis, arthritis,
P25	1	3	F	Turkish	+	c.G137A p.G46Q	no	viremia, LPD	665000	-	-
P26	14	14	M	English	-	c.251_252ins T p.C71fs*44		viremia	45000000	HL, DLBCL	recurrent tonsillitis
P27	5	5	F	Tunisian	-	c.G329A p.W110*	LRTI, skin infections	viremia, LPD	1000000		arthritis, uveitis
P28	5	7	M	Iranian	+	c.T94C p.Y32H	LRTI	IM, LPD, HLH	7250	-	recurrent fever, uveitis, arthritis
P29	4	5	F	Iranian	+	c.T94C p.Y32H	LRTI	IM, LPD, HLH	8220	-	recurrent fever
P30	3	4	M	Turkish	+	c.G98A p.W33*	-	-	0	HL	No
P31	3	10	F	Indian	-	c.A95G p.Y32C	LRTI	LPD	474188	B-NHL	oral ulcers, IBD
P32	8	8	F	Turkish	+	c.18 del p.W7G*44	-	-	85	mc-HL	-
P33	3	3	F	Turkish	+	c.18 del p.W7G*44	-	-	2500	ns-HL Burkitt	-

**Table 1. B) Clinical features and genetic variants of patients with CD70 deficiency**

	Age at onset	Age at diagnosis	Sex	Ethnicity	Consanguinity	Mutation (NM_001242.5)	Bacterial infections	EBV related symptoms	EBV load (max)	Malignancy	Other symptoms
P34	3	7	M	Egyptian	+	c.C535T p.R179*	no	LPD	na	ns-HL	recurrent fever
P35	5	9	F	Iranian	+	c.250delT p.S84Pfs27*	LRTI	IM	6910	ns-HL	Behce-like disease
P36	0	36	M	Iranian	+	c.250delT p.S84Pfs27*	sinusitis	encephalitis	322	-	-
P37	3	16	M	Turkish	+	c.555_557del p.F186del*	otitis, diarrhea	Cervical LAP	5620	mc-HL	recurrent fever, chronic diarrhea
P38	2	8	M	Turkish	+	c.555_557del p.F186del*	URTI	Cervical LAP	na	mc-HL	-
P39	1	6	M	Caucasian	+	c.163-2A>G p.W55Dfs*44	-	IM, LPD	27700	-	PFAPA-like period fever

P40	7	16	M	Turkish	+	c.G570A p.Trp190*	URTI	LPD	17856	HL	PFAPA like periodic fever
P41	9	11	M	Turkish	+	c.C332T p.T111M	-	lymphadenitis	411000	B-NHL	-
P42	3	7	F	Turkish	+	c.T2C p.M1T	LRTI	IM LPD	na	-	-
P43	4	6	M	Turkish	+	c.C332T p.T111M	LRTI	LPD	233	-	chronic diarrhea
P44	3	3	F	Turkish	+	c.C332T p.T111M	LRTI		309402	ns-HL	chronic diarrhea
P45	1	1	M	Turkish	+	c.C332T p.T111M	LRTI		24000	ns-HL	
P46	3	10	F	Iranian	+	c.G437T p.S146I	LRTI, URTI	IM, LPD	4310		recurrent fever
P47	1	5	F	Turkish	+	c.C332T p.T111M	URTI	LPD	67500		
P48	NA	14	M	Turkish	+	c.C332T p.T111M	-		0		
P49	6	13	M	Turkish	+	c.C332T p.T111M	-		0	Burkitt lymphoma	

CAEBV:Chronic active EBV; HLH: hemophagocytic lymphohistiocytosis; HSCT: hematopoietic stem cell transplantation; IBD: inflammatory bowel disease; IgRT: Immunoglobulin replacement therapy; LPD: Lymphoproliferative disease; RTX: rituximab; URTI: Upper respiratory tract infections; LRTI: Lower respiratory tract infections; MTX: methotrexate; LAP: lymphadenopathy; PFAPA: periodic fever, aphthous stomatitis, pharyngitis, cervical adenitis.

**Table 2. HSCT characteristics**

Clinical manifestations	Age at HSCT (yr)	HLA Match	Graft	Conditioning	Serotherapy	GvHD prophylaxis	Cell dose	ANC engraftment (day)	GvHD	Complications
HLH	2	MMUD 9 of 10	CB	Bu, Cy	ATG 3 x 30 mg/kg	CSA, Pred	0,5x10 <sup>8</sup> /kg TNC	+34	acute IV (gut 3-4)	infections, ADV, EBV, HHV6, cord colitis syndrome, poor growth
rec. URTI, skin abscesses, meningitis	2	MMUD 9 of 10	CB	Flu, Bu (MAC)	ATG 3 x 2,5 mg/kg	CSA, MMF	0,7x10 <sup>8</sup> /kg TNC	+20	acute I (skin 1-2) chronic limited skin	severe infections, CMV
CAEBV, EBV-LPD, oral ulcers, uveitis	17	MMUD 8 of 10	CB	Flu, Cy, TBI	None	CSA, MMF	n.a.	+5	acute I (skin 1-2)	HHV6 infection
recurrent pneumonia, EBV viremia, HLH	12	MRD 10 of 10	BM	Eto + Dexa (HLH protocol)	Campath 4 x 0,3 mg/kg	CSA, Pred	9,1x10 <sup>6</sup> /kg CD34	+13	acute III (liver 3)	severe infections, mucor, HLH relapse, EBV
pneumonia, EBV-HLH / LPD, DLCBL	2	Haplo 5 of 10	PB TCRab/CD19 depl.	Flu, Mel, TT	ATG 3 x 10 mg/kg	MMF	20,6x10 <sup>6</sup> /kg CD34	20	None	ADV viremia, CMV reactivation, CMV VST D+60
EBV-LPD, EBV viremia	4	MSD 10 of 10	BM	Flu, Bu (MAC)	None	CSA, MTX	8,6x10 <sup>6</sup> /kg CD34	16	None	pulmonary candidosis (cleared)
recurrent tonsillitis, EBV neg ns-HL, EBV pos NHL, DLBCL	18	MMUD 9 of 10	PB	Flu, Mel	Campath 5 x 20 mg total	CSA	6,4x10 <sup>6</sup> /kg CD34	12	acute I (skin 2) chronic limited skin	EBV, rhinovirus
rec. pneumonia, skin infections, arthritis, LPD	6	MMUD 9 of 10	PB CD45RA depl.	Flu, Bu, TT	ATG 3 x 10 mg/kg	CSA	13,2x10 <sup>6</sup> /kg CD34	none	none	graft failure
	6	same	BM	Flu, Cy	ATG 3 x 2,5 mg/kg	CSA, MMF	3,3x10 <sup>6</sup> /kg CD34	28	none	
HL	5	MUD 10 of 10	PB	Flu, Bu (MAC)	ATG 3 x 10 mg/kg	CSA, MTX	8x10 <sup>6</sup> /kg CD34	12	none	none
mc-HL	8	MRD 10 of 10	BM	Flu, Bu	ATG 3 x 10 mg/kg	CSA, MTX	2,3x10 <sup>6</sup> /kg CD34	15	none	
ns-HL	3	MRD 10 of 10	BM	Flu, Bu, TT	ATG 3 x 10 mg/kg	CSA, MTX	2,8x10 <sup>6</sup> /kg CD34	17	none	infections, hemorrhage
ns-HL stage 2, LPD, recurrent fever	10	Haplo 3 of 6	BM	Flu, Bu (MAC)	ATG 1 x 10 mg/kg, Campath 1 x 0,5 mg/kg RTX 375	CSA, MMF, Post-Cy	4,9x10 <sup>6</sup> /kg CD34	22	acute II (skin 2, gut 1) chronic limited skin	none
rec. otitis, rec. fever, chr. enteritis, mc-EBV-HL, HL relapse	18	MUD 10 of 10	PB	Flu, Treo, RTX	ATG	CSA, MMF	3,4x10 <sup>6</sup> /kg CD34	20	none	RSV pneumonia hemopericardium, acute renal failure, thrombocytopenia
URTI, IM, mc-EBV-HL, HL relapse	10	MUD 10 of 10	PB	Flu, Treo, RTX	ATG	CSA, MMF	3,7x10 <sup>6</sup> /kg CD34	20	acute II (gut 1)	acute renal failure, RSV pneumonia
LAP, rec. fever, PFAPA like, EBV PTLD, mosquito bite hypersensitivity	5	MUD 10 of 10	BM	Flu, Treo, TT	ATG 3 x 10 mg/kg	CSA, MMF, MTX		24	acute II (gut 1)	CMV reactivation
tonsillitis, URTI, EBV viremia, EBV-LPD, rec. fever	16	MSD 10 of 10	PB	Flu, Treo, RTX	no	CSA, MMF	7x10 <sup>6</sup> /kg CD34	20	acute III (gut 2-3), chronic gut	CMV infection, thrombocytopenia
LAP, EBV-B-NHL	11	Haplo 5 of 10	BM	Flu, Bu, TT	ATG	CSA, post-Cy	15,2x10 <sup>6</sup> /kg CD34	13	none	severe engraftment syndrome, day +166 PJP

rec. pneumonia, chr. enteritis, EBV LAP	7	MRD 10 of 10	PB	Flu, Treo	no	CSA, MMF	5,4X10 <sup>6</sup> /kg CD34	22	acute II (skin, liver)	none
LRTI, ns-HL	6	MRD 10 of 10	PB	Flu, Treo	no	CsA, MMF			chronic skin and liver	none

ADV: Adenovirus ;ATG: Anti-thymocyte globulin; Bu: Busulfan; CAEBV: Chronic active EBV; CB: Cord blood; CSA: Cyclosporin A; Cy: Cyclophosphamide; DLBCL: Diffuse large B cell lymphoma; Flu: Fludarabine; HHV6: Human herpesvirus 6; HLH: Hemophagocytic lymphohistiocytosis; HL: Hodgkin lymphoma; LPD: Lymphoproliferative disease; MMUD: Mismatched unrelated donor; MAC: Myeloablative conditioning; Mel: Melphalan; MMF: Mycophenolate mofetil; MRD: Matched related donor; MSD: Matched sibling donor; MUD: Matched unrelated donor; NHL: Non-Hodgkin lymphoma; RTX: Rituximab; TBI: Total body irradiation; TNC: Total nucleated cells; URTI: Upper respiratory tract infection; VST: Virus-specific T cells

Figure 1

A

**CD27**

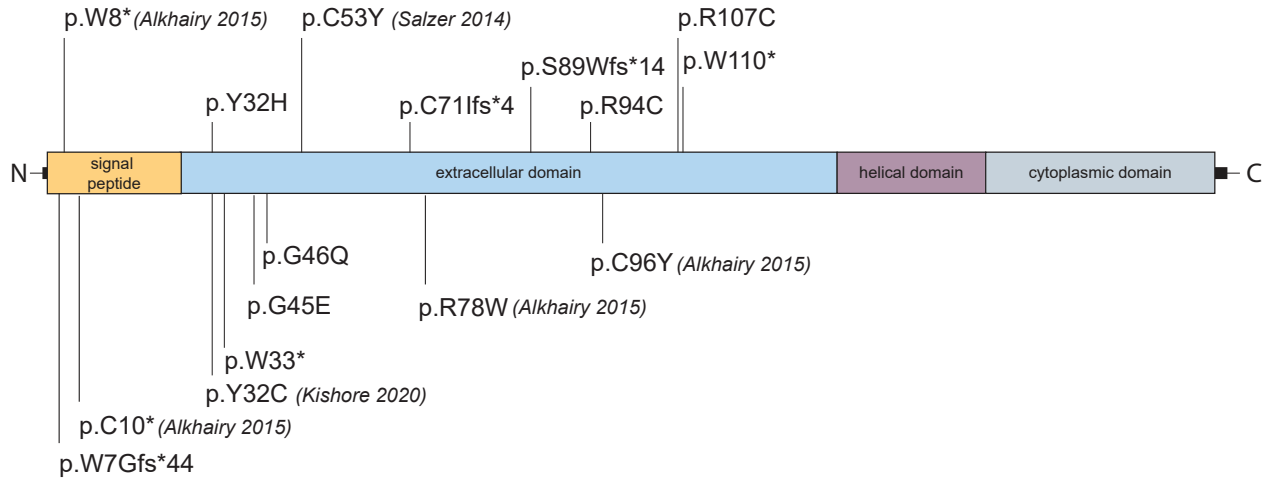

**CD70**

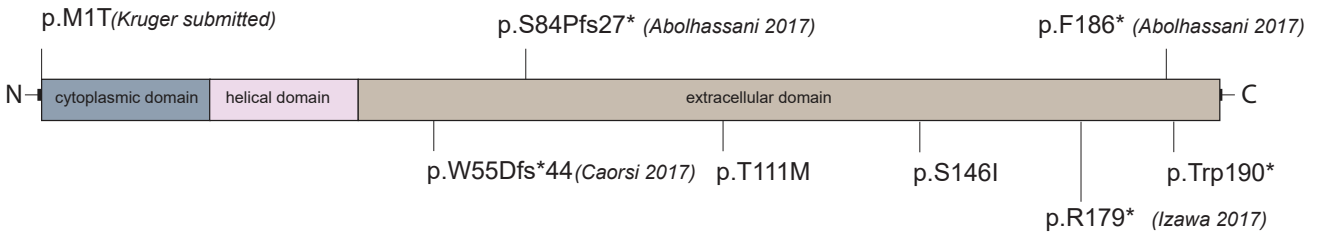

B

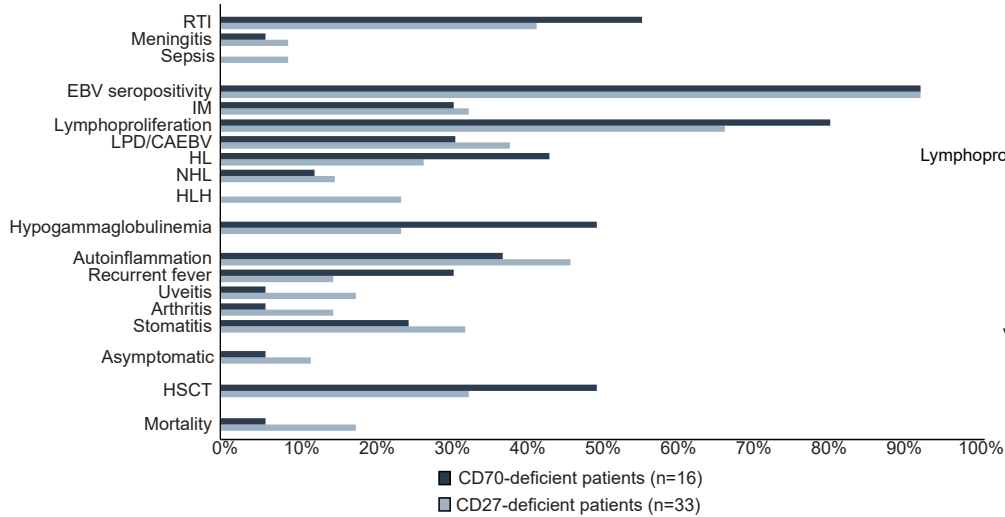

C

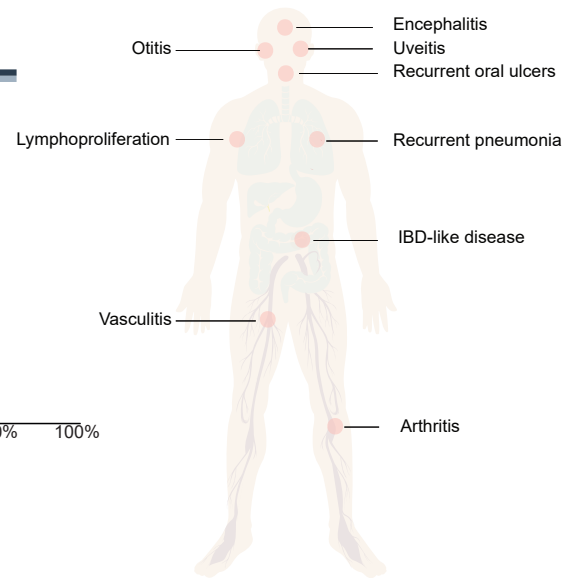



Figure 2

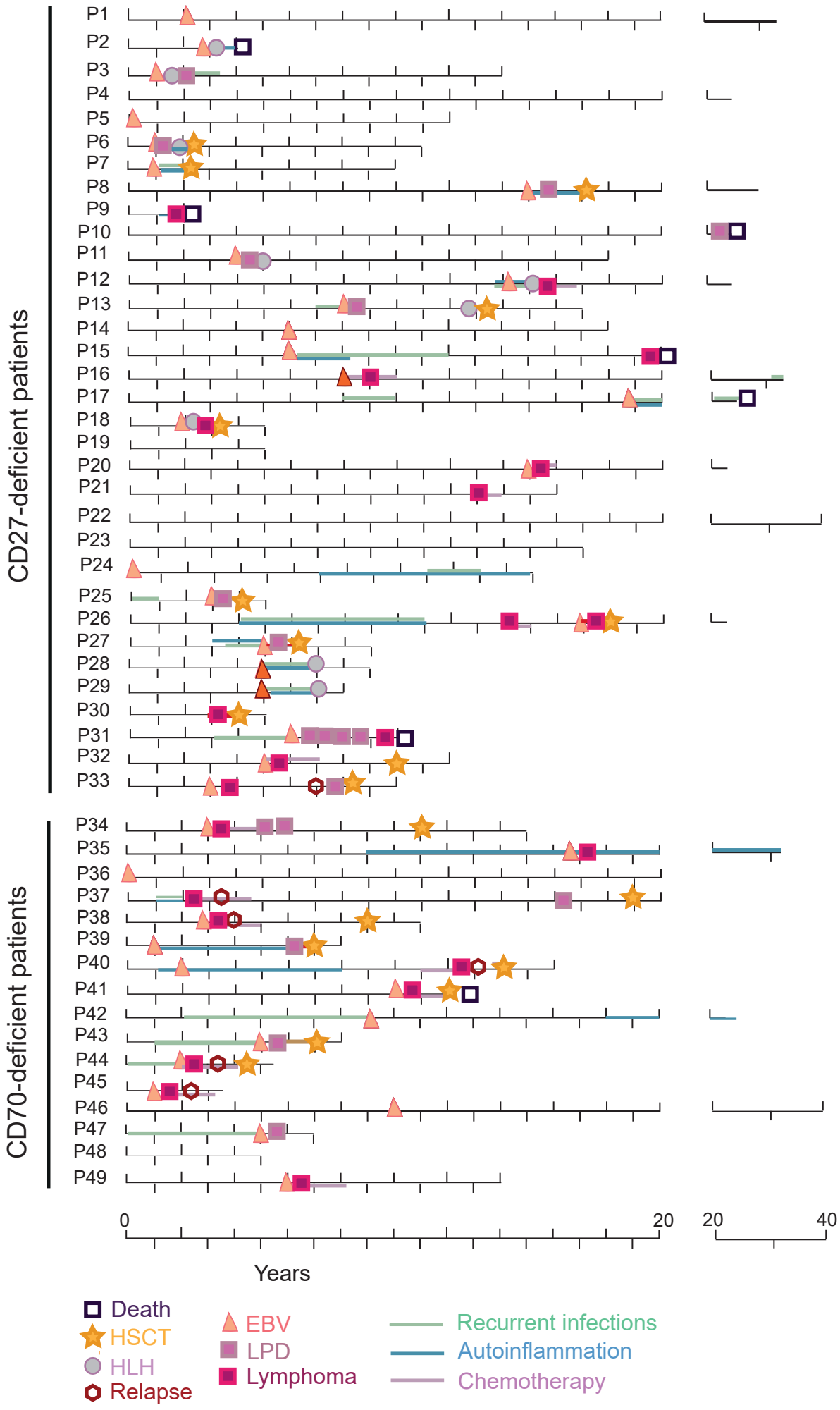
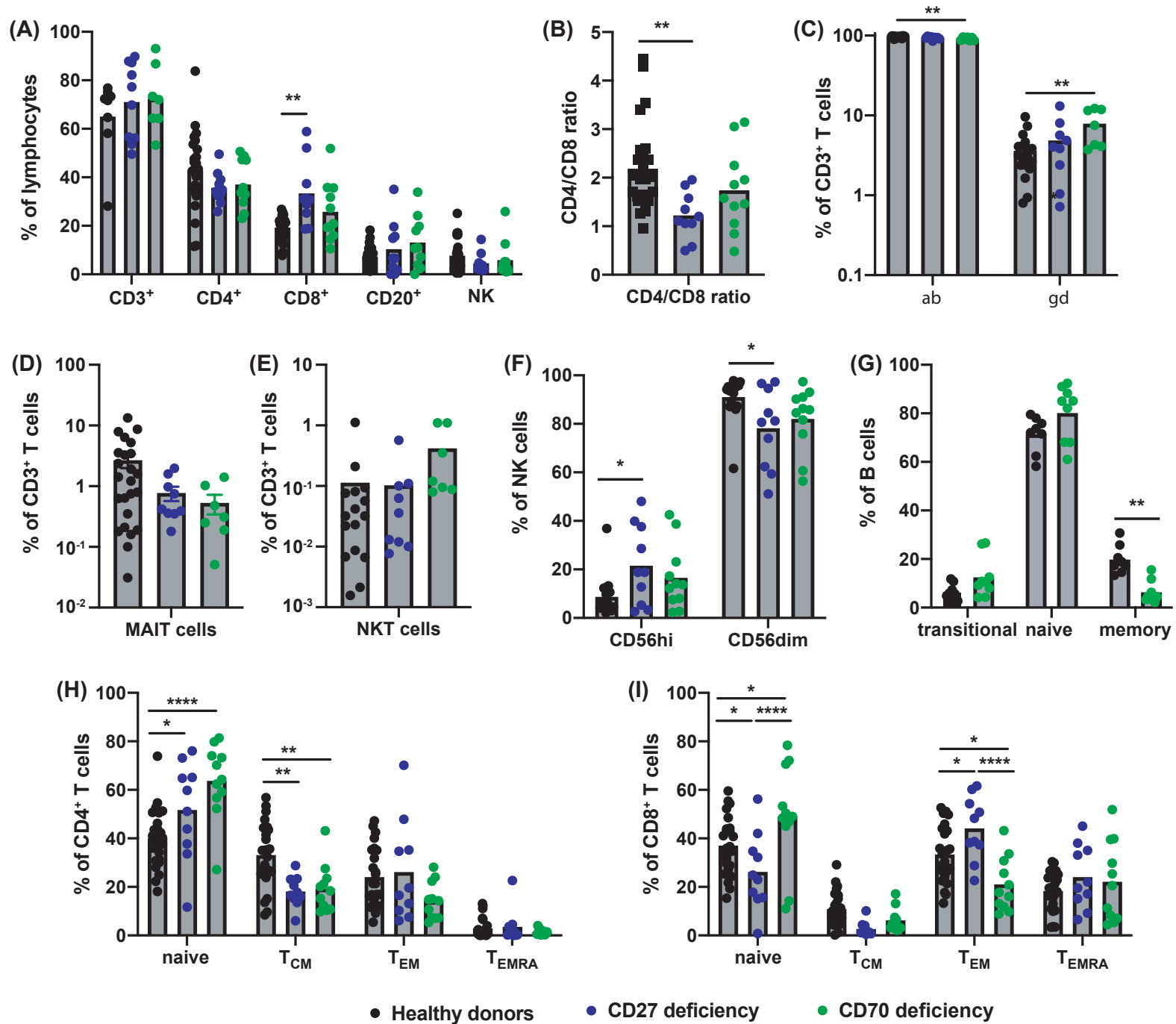
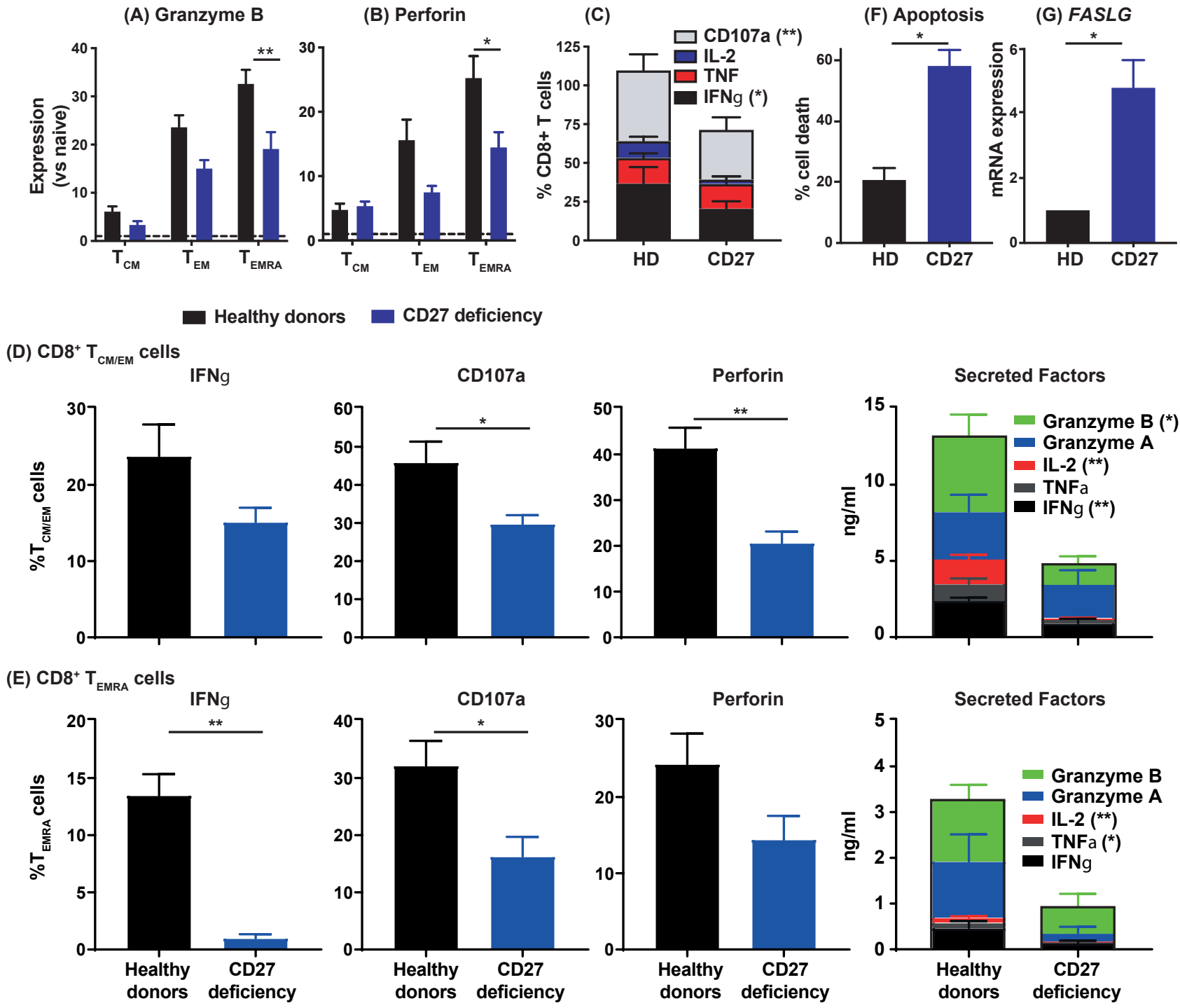

Figure 3 Lymphocytes and subsets



**Figure 4 CD8 T cell function**



**Figure 5 EBV specific CD8 T cells**

