



HAL
open science

Evaluating the explosion severity of nanopowders: International standards versus reality

Audrey Santandrea, Alexis Vignes, Arne Krietsch, David Brunello, Laurent Perrin, André Laurent, Olivier Dufaud

► **To cite this version:**

Audrey Santandrea, Alexis Vignes, Arne Krietsch, David Brunello, Laurent Perrin, et al.. Evaluating the explosion severity of nanopowders: International standards versus reality. *Process Safety and Environmental Protection*, 2020, 138, pp.279-291. 10.1016/j.psep.2020.04.011 . hal-03060213

HAL Id: hal-03060213

<https://hal.science/hal-03060213>

Submitted on 3 Aug 2021

HAL is a multi-disciplinary open access archive for the deposit and dissemination of scientific research documents, whether they are published or not. The documents may come from teaching and research institutions in France or abroad, or from public or private research centers.

L'archive ouverte pluridisciplinaire **HAL**, est destinée au dépôt et à la diffusion de documents scientifiques de niveau recherche, publiés ou non, émanant des établissements d'enseignement et de recherche français ou étrangers, des laboratoires publics ou privés.

Evaluating the explosion severity of nanopowders: international standards versus reality

Audrey Santandrea ^{1,2}, Alexis Vignes ², Arne Krietsch ³, David Brunello ¹, Laurent Perrin ¹,
André Laurent ¹, Olivier Dufaud ^{1,*}

***Corresponding author:** Olivier Dufaud (E-mail address: olivier.dufaud@univ-lorraine.fr)

¹ Laboratoire Réactions et Génie des Procédés, Université de Lorraine, CNRS, LRGP, F-54000 Nancy, France

² INERIS, Parc Technologique ALATA, BP 2, F-60550, Verneuil-en-Halatte, France

³ BAM, Bundesanstalt für Materialforschung und -prüfung (BAM), Fachbereich 2.2 Reaktionsfähige Stoffe und Stoffsysteme, Brennbare Schüttgüter und Stäube, feste Brennstoffe, Unter den Eichen 87, 12205 Berlin

Abstract:

The maximum explosion overpressure and the maximum rate of pressure rise, which characterize the dust explosion severity, are commonly measured in apparatuses and under specific conditions defined by international standards. However, those standards conditions, designed for micropowders, may not be fully adapted to nanoparticles. Investigations were conducted on different nanopowders (nanocellulose, carbon black, aluminum) to illustrate their specific behaviors and highlight the potential inadequacy of the standards. The influence of the sample preparation was explored. Various testing procedures were compared, focusing on the dust cloud turbulence and homogeneity. Dust dispersion experiments evidenced the

importance of the characterization of the dust cloud after dispersion, due to the fragmentation of agglomerates, using metrics relevant with nanoparticles reactivity (e.g. surface diameter instead of volume diameter). Moreover, the overdriving phenomenon (when the experimental results become dependent of the ignition energy), already identified for micropowders, can be exacerbated for nanoparticles due to their low minimum ignition energy and to the high energy used under standard conditions. It was evidenced that for highly sensitive nanopowders, pre-ignition phenomenon can occur. Finally, during severe explosions and due to a too long opening delay of the 'fast acting valve', the flame can go back to the dust container.

Keywords: dust explosion; nanoparticles; international standards; explosion severity; ignition

1. Introduction

The small size of nanomaterials implies that they develop a high specific surface area, increasing the material reactivity and inducing original properties (Jeevanandam et al., 2018). Therefore, although some authors already discussed the validity of the current methods to evaluate the flammability and explosivity of microparticles (Dahoe et al., 1996; Proust et al., 2007; van der Wel et al., 1992; Zhen and Leuckel, 1997), special precaution should be taken when evaluating nanoparticles explosion characteristics (Di Benedetto et al., 2019). Indeed, the very same methods established for microparticles are used to assess the explosion severity of nanoparticles, whereas their specific behavior might enhance the discrepancies already encountered when applying those methods to microparticles and might induce application limitations. Among all the standards and guidelines concerning dust explosion (Zalosh, 2019), the explosion severity is generally evaluated either in a 1 m³ vessel or in a 20-L sphere (ISO/IEC 80079-20-2, 2016) according to ASTM E1226 (2019) or more conventionally according to EN 14034 standards (EN 14034-1, 2004; EN 14034-2, 2006). These documents specify the operating conditions to apply during the test, notably the type of nozzle, the ignition delay time, the ignition source and energy, the sample preparation and the dispersion procedure. Since explosion tests are generally performed in the 20-L sphere in safety laboratories, this work mainly focuses on this apparatus, relying on the guidelines of the standard manufacturer (Cesana and Siwek, 2016). It should be underlined that testing conditions are usually different than industrial conditions (Eckhoff, 1985; Tamanini, 1990) and that the obtained values must be used as references for protection equipment design instead of absolute values necessarily reached during an accident. Once again, such discrepancies may be increased when dealing with nanopowders. In introduction, the general procedure used to determine the explosion characteristics of micropowders will be recalled

and some points requiring a thorough attention will be described, whereas the rest of this article will focus on the applicability of these test procedures to nanoparticles.

1.1. Preliminary characterization: what the standards say

The dust sample must be tested as received and European standards EN 14034 stipulate that both the moisture content and the particle size distribution ‘shall be determined for the sample as tested and given in the test report’. However, in the absence of special precaution, the moisture content of the received powder and the testing atmosphere humidity may be different than in the industrial process, which would lead to a misestimation of the explosion severity. Indeed, Traoré et al. (2009) highlighted that moisture content and atmosphere humidity can either enhance or inhibit the combustion reaction depending on the product nature, notably through possible hydrogen generation for metal dusts. Furthermore, the moisture content of the powder can also impact the agglomeration state, thus modifying the particle size distribution (PSD) of the dust.

As previously quoted, the particle size distribution of the sample should also be determined, but without any instruction on the method to apply. For instance, it can be estimated by wet dispersion, which is convenient but of limited interest when testing the explosivity of a dust cloud in air. Moreover, when testing fine powders, the PSD after dispersion may be different from the initial PSD due to the fragmentation of the agglomerates (Eckhoff, 2003). A note in international standards (EN 14034-1, 2004; EN 14034-2, 2006) specifies that, if the size of the particles can be reduced by the dispersion process and if ‘this effect may be important’, the particle size distribution after dispersion (without ignition) should be evaluated. However, no critical particle size is given to indicate when this additional characterization is required and no method is recommended to perform it, whereas each measuring procedure (wet or dry measurement, dispersing system, solvent...) develops a specific fragmentation efficiency. Although the most accurate way would be to measure the PSD after dispersion directly in the

sphere at the exact time and place of ignition (Santandrea et al., 2019a), this determination remains difficult due to the opacity of the original apparatus.

1.2. Dust dispersion: what the standards say

After being placed in a dust container, the sample is pressurized with dry air at high pressure (20 bar gauge). A valve, separating the container from the explosion chamber, is then automatically opened, dispersing the powder through a nozzle. Considering the EN 14034-1&2 standards, the valve can be either a fast acting valve activated by a blasting cap or an electro-pneumatic valve. In the first case, the valve shall be designed to be opened in less than 10 ms; in the second case, the opening time of the electrovalve shall be lower than 100 ms.

The dust disperser proposed by the EN 14034-1&2 standards is a semi-circular spray pipe fitted with 13 holes of a diameter of 6 mm. However, alternative nozzles are presented in annex: a 5 mm perforated semi-circular spray pipe, a dispersion cup and the commonly used rebound nozzle (EN 14034-1, 2004; EN 14034-2, 2006).

Several studies highlighted the influence of the nozzle on the turbulence level within the chamber and on the dust cloud homogeneity (Dahoe et al., 2001a; Murillo et al., 2018). Siwek (1988) and Dahoe et al. (2001a) proved that the dispersion dynamics and the turbulence level obtained at 60 ms, i.e. the ignition delay time recommended by international standards in the 20-L sphere, can be different when using the rebound nozzle or the perforated dispersion ring, especially for dusts showing cohesive properties (e.g. cellulose, starch). For non-spherical dusts, the dust dispersion and, especially, the spatial distribution of turbulence, can also be affected by the shape of the dust particles (Di Sarli et al., 2019). As a consequence, various authors proposed alternative dispersion nozzles designed to favor the homogeneous distribution of the diphasic flow (Dahoe et al., 2001a; Murillo et al., 2018; Wu et al., 2017; Yao et al., 2020; Zhang and Zhang, 2015). Therefore, explosion severity characteristics obtained are directly dependent on the choice of the nozzle for a specific ignition delay time.

1.3. Ignition delay time: what the standards say

As previously noted, the delay between the beginning of the dust injection and its ignition is called ignition delay time or t_v . It is one of the most important parameter to consider when evaluating the dust explosion severity, as it directly influences the initial turbulence in the vessel (Amyotte et al., 1988). Murillo et al. (2018) highlighted the existence of three stages when regarding the evolution of the turbulence with time: a high turbulence from 0 to 50 ms, a transition stage between 50 and 120 ms, and a stability stage from 120 ms. Then, it appears that the fixed ignition delay time of 60 ms is located in the transition stage, meaning a small variation in the ignition delay time can greatly impact the turbulence level, and thus the explosion severity. Indeed, some studies evidenced that the maximum rate of pressure rise decreases when increasing the ignition delay time, i.e. decreasing the turbulence level (Dahoe et al., 2001a; Santandrea et al., 2019b). A similar trend was observed by Eckhoff (1977) in the 1.2L Hartmann bomb. Furthermore, the ignition delay time in the 20-L sphere was initially set at 60 ms to obtain the same turbulence properties than in the 1 m³ with an ignition delay time of 600 ms, which is disproved by several authors (Dahoe et al., 2001b; Pu et al., 1991; van der Wel et al., 1992). As a consequence, since the commonly used cube-root law validated by Bartknecht (1989) and Siwek (1977) was based on results obtained at different turbulences and homogeneity conditions, Dahoe et al. (2001b) claim that this law should be abandoned and replaced by a more fundamental approach.

1.4. Ignition energy: what the standards say

Two chemical ignitors, 'each having an energy of 5 kJ', are used to ignite the powder. Piezoelectric sensors then record the pressure evolution with time, giving access to the overpressure P_m and rate of pressure rise $(dP/dt)_m$ for each test.

Contrary to the approach used to design the dispersion nozzles, the ignition energy of 10 kJ used in the 1 m³ was directly applied to the 20-L sphere without any adjustment. This

excessive amount of energy often impacts the flame propagation in the 20-L sphere, due to its small size with regard to the 1 m³ vessel. This phenomenon, called ‘overdriving’, leads to the overestimation of the overpressure (Going et al., 2000; Zhen and Leuckel, 1997). In addition, it should be noticed that a so-called ‘underdriving’ phenomenon can also be observed in the 20-L sphere due to walls effects, which tends to decrease the flame temperature, and thus the overpressure and rate of pressure rise values (Dastidar, 2019).

1.5. Specific standards for nanopowders?

The previous considerations were done focusing on the behavior of micropowders and, at present, no standard exists describing a specific protocol for the determination of the explosion severity of nanopowders. Nevertheless, recent provisions for protocols concerning explosivity and flammability assessment for powders containing nano-objects were released in the Technical Specification CEN/TS 17274 (2018) edited by CEN TC 352/WG3/PG3. However, although these guidelines recommend special care when testing nanomaterials due to their high sensitivity, no apparatus or procedure modification is proposed. For instance, very reactive samples should be stored and transported ‘under partial vacuum conditions or under argon or any inert preferably nontoxic fluid’ and the type of package should be reported (CEN/TS 17274, 2018), but the concern of potential pre-ignition when testing those very reactive materials is not addressed. On a similar way, the guidelines specify that the particle size distribution of powders containing nanoparticles should be characterized ‘(d_{10%}, d_{50%}, d_{90%}) by any suitable method in terms of volume, number’. Thus, once again, no specific method is recommended and no mention of a characterization of the dust cloud, i.e. after dispersion, can be found. Moreover, as clearly stated by Eckhoff (2012), even if a ‘perfect dispersion’ should be achieved, the PSD of nanopowders cloud will not be unimodal and located in the nano-range due to the extremely fast agglomeration process, which would inevitably occurred within fractions of a second. Nevertheless, it should be underlined that, at

present, no measurement technique can actually determine the PSD of nanopowders and its agglomerates over a range from a few nanometers to hundreds of micrometers with a satisfactory acquisition frequency.

This work focuses on some important aspects to be considered when evaluating nanoparticles flammability and explosivity. Several examples involving different types of powder (aluminum, carbon black and nanocellulose) are then presented to highlight some testing issues and to propose possible solutions. Thus, the effects of the dispersion nozzle on the particle size distribution, the influence of the powder and atmosphere moisture content on the explosion severity and combustion gases composition, as well as the impact of turbulence of the explosion severity of nanopowders were evaluated. Moreover, the overdriving phenomenon and the observation of a ‘pre-ignition’ phenomenon in the dust container when testing aluminum powders were investigated.

2. Materials and methods

The previously mentioned parameters (turbulence, ignition energy...) can affect dust explosion severity depending on the nature of the powder and its properties. Thereby, the ‘most suitable’ operating conditions can greatly depend on the nature of the dust. Therefore, three powders, representing the most common types of combustible dust, were chosen and studied: a metal compound: aluminum, carbon black and an organic compound: nanocellulose. Although the primary particle diameter of each powder, specified by the suppliers, is in the nano-range, nanoparticles tend to agglomerate to form clusters of several micrometers diameter as presented in Figure 1. Since the dispersion procedure can partially break those agglomerates, thus modifying the actual particle size distribution within the chamber, the powder was characterized before (by sedimentation) and after dispersion in the

20-L sphere (Table 1). This characterization was performed with a laser diffraction sensor (Sympatec) measuring particle sizes from 0.5 to 175 μm up to 2 analyses per millisecond, coupled with a visualization 20-L sphere equipped with windows, described by Murillo et al. (2018). If this equipment is adapted to highlight the presence of the agglomerates and the existence of a fragmentation phenomenon, it is obviously not suitable for nanopowders observation. Nevertheless, additional tests were also carried out with the same sensor equipped with a R1 lens (0.1 - 35 μm range) and a Scanning Mobility Particle Sizer (SMPS) to identify the presence of particle with diameter lower than 500 nm in the sphere. For aluminum, carbon black and nanocellulose, these tests clearly confirm the existence of nanoparticles with dimensions ranging from 40 to 400 nm after dispersion (Santandrea et al., 2020).

As a consequence, if agglomerates of several micrometers are still present after dispersion, agglomerates and particles in the nano-range are also measured. Due to the high ratio surface/volume of nanoparticles and the combustion reaction occurring at the surface of the particles depending on the reaction regime, the surface fraction was considered instead of the usual volume fraction when analyzing the particle size distribution of nanoparticles. Moreover, when considering the volume fraction, the high volume of big agglomerates tends to occult the presence of smaller nano-agglomerates. Thus, the volume fraction measured by the apparatus was converted into a surface fraction using the equivalent volume diameter (Figure 2). It is then essential to not only characterize the particle size distribution after dispersion, but also to choose the right metrics.

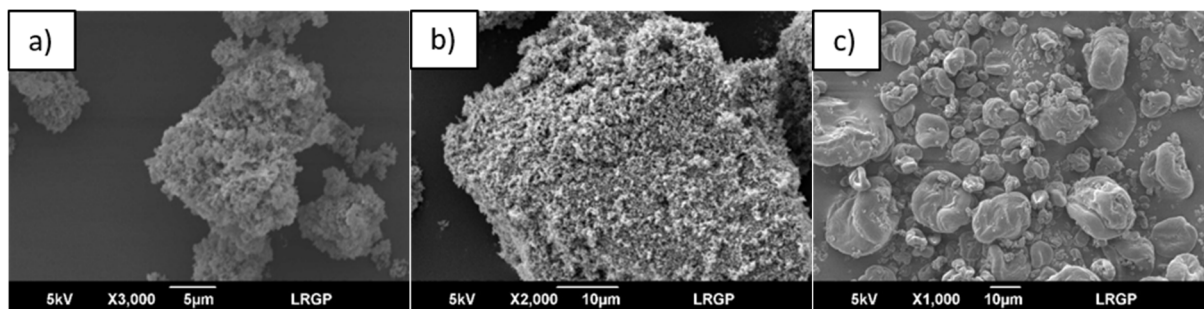

Figure 1. Powders observed by Scanning Electron Microscopy: a) Aluminum b) Carbon black
c) Nanocellulose

Table 1. Properties of the nanopowders used in this work.

Powders	Primary diameter (nm)	Specific surface area (m ² .g ⁻¹)	Mean volume diameter d ₅₀ by sedimentation (µm)	Mean volume diameter d ₅₀ after dispersion (µm)
Aluminum	40 - 60	24	28	5
Carbon black	75	40	37	4
Nanocellulose	3 nm width, 70 nm length	400*	65	12

* (CelluForce, 2016)

It appears in Table 1 that a strong fragmentation occurs during the dust injection within the 20-L sphere, decreasing the mean volume diameter d₅₀ by 80% to nearly 90%. These results confirm that the injection procedure will impact the PSD and that it is important to evaluate the particle size distribution after dispersion for a better estimation of the explosivity of nanopowders.

Explosion tests were performed in a conventional and calibrated 20-L sphere (Bartknecht, 1989) under different conditions, modifying the ignition delay time, the atmosphere humidity, the nozzle or even the dust dispersion procedure. Unless stated otherwise in the text, explosion tests were carried out with an electro-pneumatic valve and the rebound nozzle. In each case, the particle size distribution and explosion characteristics, maximum overpressure

and maximum rate of pressure rise, were systematically compared to those obtained under standard conditions.

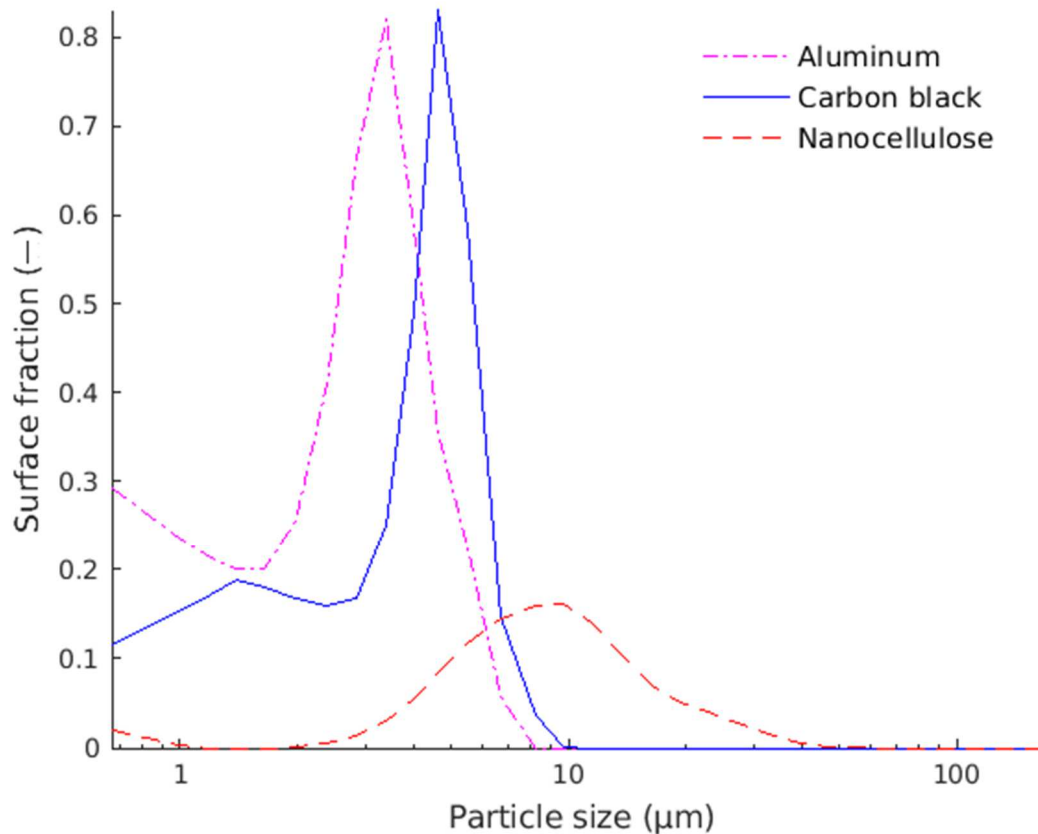

Figure 2. Particle size distribution of the powders after injection in the 20-L sphere at the moment of ignition ($t_v = 60$ ms)

3. Determination of the explosion severity of nanopowders: experimental considerations and case studies

3.1. Scattering little things: nanopowders dispersion in the 20-L sphere

‘For testing, the dust is dispersed into the sphere from a pressurized dust container via the fast acting valve and a rebound nozzle’ (EN 14034-1-2, 2004; 2006).

The influence of the dispersion system, including the outlet valve, on the PSD and homogeneity of the dust cloud greatly depends on the nature of the powders (Bagaria et al., 2016; Sanchirico et al., 2015). If this statement is true for microparticles, it is probably even more significant for nanoparticles. Indeed, due to their strong Van der Waals interactions, nanopowders exhibit agglomeration phenomenon (Eckhoff, 2012) and these structures tend to break during their dispersion, widening the particle size distribution (Bagaria et al., 2016; Bouillard et al., 2010). The inertial effects are obviously weaker on a nanoparticle than on a microparticle or an agglomerate which leads to segregation phenomenon and modifies the dispersion dynamics. Wengeler and Nirschl (2007) showed that nanoparticles and microparticles exhibit different dispersion properties and that no complete dispersion of primary particles can be achieved. They concluded that, consequently, nanopowders need a different design of dispersion processes.

First of all, tests were performed on carbon black (Table 1) to highlight the influence of both the injection procedure and the outlet valve. PSD measurement were then performed under different conditions: a standard injection with the rebound nozzle, a standard injection without nozzle, and a 'dust lifting' without nozzle. In this latter configuration, the dust is placed directly at the bottom of the sphere and does not undergo the pressurization step in the 0.6 L chamber nor the injection through the electrovalve. It appears in Figure 3 that the dispersion by dust lifting without nozzle presents fewer fine particles ($< 3 \mu\text{m}$) than the dispersion by standard injection through the electrovalve, with or without nozzle. Then, it seems that an important part of the fragmentation of the agglomerates is not related to the presence of the rebound nozzle but occurs during the injection within the sphere, which was already confirmed by Kalejaiye et al. (2010) and to a lesser extent Bagaria et al. (2016). However, the latter authors also stressed that the cloud turbulence and dispersion nozzle play a major role in particle breakage, in particular in their 36-L explosion apparatus. To sum up, it seems that the

high shear stress induced by the pressure difference between the combustion chamber and the pressurized dust container is one of the main causes of the agglomerate breakage and that the ‘standard’ rebound nozzle does not appear to play a main role in this phenomenon. However, its contribution is critical in terms of dust cloud homogeneity. Therefore, several nozzles were proposed to improve the dispersion homogeneity in the 20-L sphere (Dahoe et al., 2001b; Murillo et al., 2018). Murillo et al. (2018) notably highlighted that, even though the standard rebound nozzle leads to the most conservative results, the better cloud homogeneity obtained thanks to their symmetric nozzle leads to a better reproducibility and a better accuracy of the safety parameters.

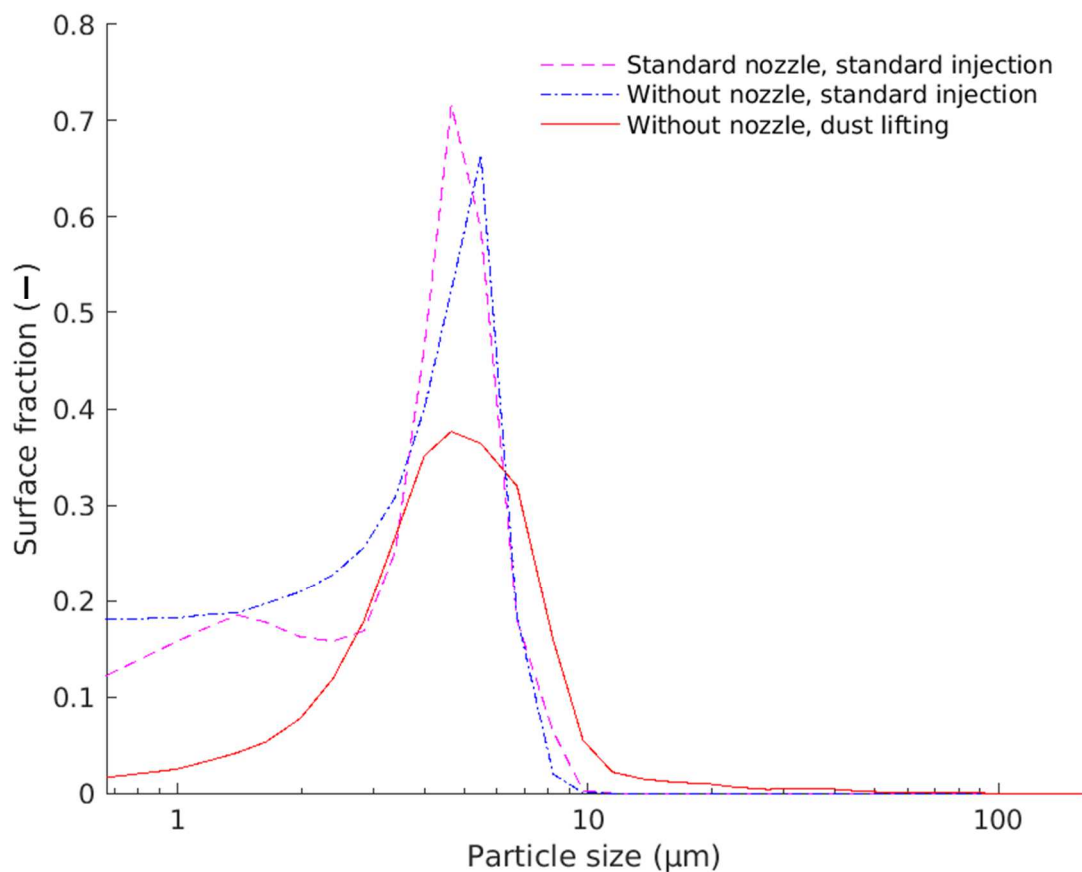

Figure 3. Effect of the injection procedure on the particle size distribution of carbon black nanoparticles at the moment of ignition ($t_v = 60$ ms)

However, such dispersion procedure is not consistent with the dispersion of powder layers by a turbulent flow or dust lifting in an enclosed conveyor, for instance. The most representative procedure would then be to place the powder directly in the explosion chamber. However, the efficiency of the dust dispersion varies with the dust density and agglomeration level, which limits the reliability of the procedure. Krietsch et al. (2013) although used this dispersion method to evaluate the explosion severity of very sensitive metallic nanopowders in the most critical conditions, i.e. minimizing the oxidation of the powder before the explosion tests. The powder was then placed in the explosion chamber to avoid pre-ignition during the pressurization and injection. To adequately disperse the dust within the vessel, a new ‘mushroom nozzle’ was designed, as a potential alternative to the standard rebound nozzle (Krietsch et al., 2013).

Although dust lifting corresponds to representative conditions in industries, other dispersion ways can be considered. In particular, a crack can appear on a pressurized pipe, thus inducing a very high shear stress which may break agglomerates. To assess the PSD modification and the explosion severity under such conditions, a new nozzle presented in Figure 4 was designed. It is constituted of a cylinder of 40 mm high and 26.7 mm diameter, that ends by a half-sphered shape equipped with a linear slot of 3 mm on 17 mm. Obviously, trying to get a homogeneous cloud in the sphere with this type of nozzle is illusory. Subsequently, a second nozzle was designed to evaluate the fragmentation of agglomerates passing through a similar nozzle with the same ejection surface more uniformly distributed. This second nozzle, represented in Figure 5, is equipped with two series of eight circular holes of 2 mm diameter, can be compared to that developed by Zhang and Zhang (2015), which leads to homogeneous dispersion in the explosion vessel.

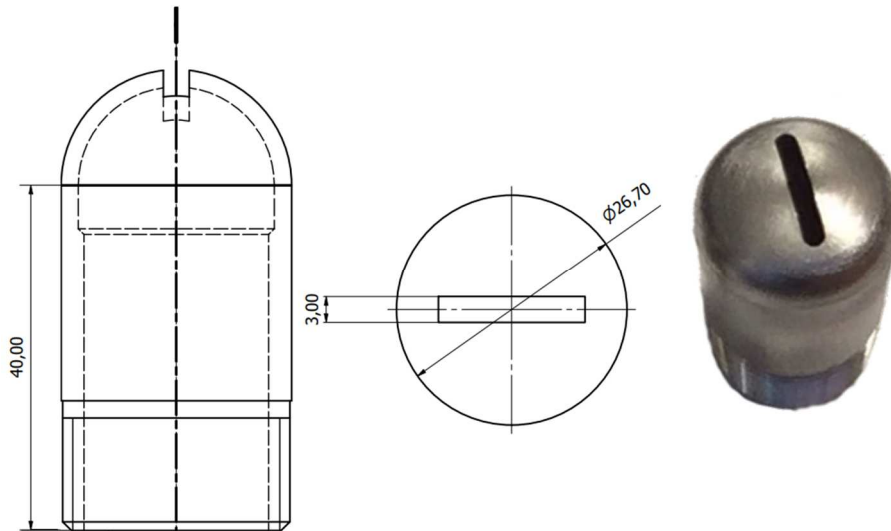

Figure 4. Representation of slotted cylindrical nozzle (dimensions in mm)

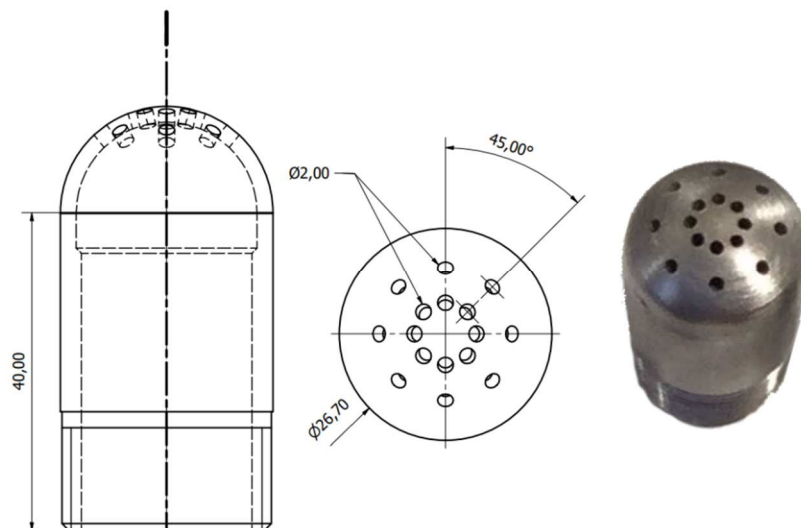

Figure 5. Representation of the perforated cylindrical nozzle (dimensions in mm)

In situ PSD measurements were performed on nanocellulose (Table 1) with the different nozzles and compared to the measurements obtained with the rebound nozzle (Figure 6). Despite a different signal intensity, the two new nozzles lead apparently to a similar particle size distribution, with a slight shift toward small particles when compared to the standard rebound nozzle. Even if it is difficult to assess without knowing the whole PSD, the fragmentation induced by the two new nozzles seems stronger than with the rebound nozzle,

although the dust cloud is less homogeneous due to the vertical shape of the new nozzles. Indeed, whereas the mean diameter d_{50} obtained with the rebound nozzle is stable a few milliseconds after dispersion, it stabilized only 80 ms after dispersion with the two other nozzles. The high turbulent kinetic energy generated by such nozzles can also be responsible of re-agglomeration after a few milliseconds as shown by the apparition of a second peak around $20 \mu\text{m}$.

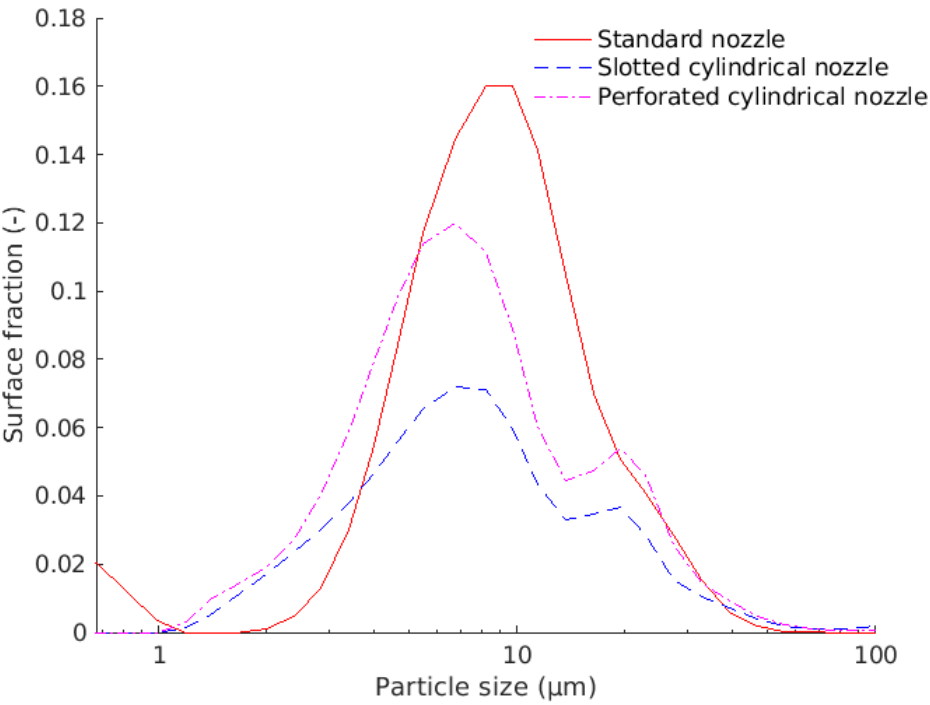

Figure 6. Effect of the nozzle on the particle size distribution of nanocellulose particles after 60 ms

Explosions tests were also performed on nanocellulose (Table 1) in standard conditions, apart from the nozzle variation. The different turbulence conditions along with the different homogeneity and PSD impact the explosion severity, as presented in Table 2. Although the number of tests performed is too small to obtain a reliable margin of error for the new nozzles, it appears that similar maximum overpressures were obtained in each case, implying

that equivalent amounts of dust reacted during the explosion. However, the maximum rate of pressure rise increases of about 37% when using these new nozzles (perforated and slotted), which traduces an impact on the reaction kinetics and flame propagation dynamics. As the impact of the new nozzles on the PSD of the dust cloud exists, but does not apparently seem to be significant, such rise of explosion severity may be attributed to an increase of the turbulence at 60 ms. Finally, the standardized procedure applied for dispersing nanopowders in the 20-L sphere does not automatically lead to conservative results.

Table 2. Influence of the nozzle on the maximum overpressure and maximum rate of pressure rise of nanocellulose ($t_v = 60$ ms)

Type of nozzle	Rebound nozzle	Perforated cylindrical nozzle	Slotted cylindrical nozzle
Maximum overpressure P_{\max} (bar)	8.35 ± 0.05	8.0	7.9
Maximum rate of pressure rise (dP/dt) $_{\max}$ (bar.s $^{-1}$)	496 ± 12	792	786

3.2. Too much is a waste: role of the ignition energy on the explosion severity of nanopowders

‘The ignition source comprises two chemical igniters each having an energy of 5 kJ.’ (EN 14034-1-2, 2004; 2006)

As previously mentioned, some nanoparticles exhibit very low ignition energy, sometimes even lower than 1 mJ (Wu et al., 2010). However, even for such powders, the standard ignition energy needed to perform explosion tests in the 20-L sphere is 10 kJ (EN 14034-1, 2004; EN 14034-2, 2006). This large difference of energy can lead to an overdriving phenomenon, which is already known to occur for microparticles and artificially increases the

explosion severity (Going et al., 2000; Zhen and Leuckel, 1997). Since nanoparticles are generally more ignition sensitive than microparticles (Bouillard et al., 2010; Holbrow et al., 2010), this phenomenon can be enhanced when evaluating nanoparticles explosion severity.

In order to estimate which ignition energy would be suitable to avoid overdriving, experiments were conducted with nanocellulose (Table 1) using different ignition energies, knowing that the minimum ignition energy of this powder in the dried form is 5 mJ (Santandrea et al., 2019b). Two pyrotechnical igniters of 5 kJ were used, according to international standards, as well as one igniter of 100J, which is the lowest energy proposed by Fr. Sobbe GmbH for chemical igniters. The ignition energy was further reduced by using an ignition source composed of two tungsten electrodes connected to a KSEP 320 system (Kühner AG - 15 kV / 15 mA, i.e. 225 W) which generates a permanent spark whose energy can be varied through spark duration. An alternative solution to Kühner software (KSEP7) has been developed in order to accurately control the ignition delay time when using the permanent spark. Since a huge amount of powder on the electrodes would inhibit the spark, explosion tests were performed at 500 g.m^{-3} , which is much greater than the minimum explosive concentration MEC (125 g.m^{-3}) and just below the experimental concentration corresponding to maximum explosion severity (750 g.m^{-3}).

Table 3 shows the maximum overpressure and rate of pressure rise obtained at this concentration for each ignition energy. It appears that, with regard to the experimental reproducibility, similar values were reached when using an electrical spark delivering 10J and chemical igniters of 100J, meaning that no overdriving phenomenon occurred at these low energies. However, when compared to the values obtained with lowest energies, the use of 10kJ chemical igniters increases the overpressure of around 20% and the rate of pressure rise of 40%. The contribution of ignition energy to the explosion severity through the modification of the flame propagation can thus lead to a misestimation of the explosion severity, since the

flame kernel growth is directly affected by the ignition source. A solution may be to set a maximum difference between the minimum ignition energy of the powder and the actual ignition energy used in explosion tests to limit this phenomenon. An alternative solution will be to better assess the explosion severity increase, especially the maximum explosion pressure, due to overdriving in order to withdraw it numerically from the experimental results.

Table 3. Explosion characteristics of 500 g.m⁻³ of nanocellulose as a function of ignition energy (values from KSEP 7.1)

Ignition energy	10 J (electrical spark)	100 J (chemical igniter)	10 kJ (chemical igniters)
Overpressure P _m (bar)	6.5 ± 0.3	6.1 ± 0.3	7.8 ± 0.4
Rate of pressure rise (dP/dt) _m (bar.s ⁻¹)	210 ± 25	200 ± 24	345 ± 41

3.3. Too sensitive or too violent: some considerations on pre-ignition.

‘If other dust dispersing systems than those described in this standard are used, a propagation of the explosion from the explosion vessel into the dust container, cannot be excluded’. (EN 14034-1-2, 2004; 2006)

On the one hand, metallic nanoparticles are generally recognized to be very ignition sensitive (Martin et al., 2018; Wu et al., 2010) and can spontaneously ignite when exposed to air (Krietsch et al., 2015; Mohan et al., 2012; Wu et al., 2010) or when injected in an experimental setup. On the other hand, some organic nanomaterials are considered to be very sensitive to electrostatic ignition as their MIE is lower than 10 mJ, e.g. the nanocellulose powder with a MIE of 5 mJ (Santandrea et al., 2019b). In both cases, the release of such powders through a small opening and under a large pressure difference can cause the

generation of a highly concentrated dust cloud of nanoparticles and agglomerates, as for instance during the accidental leakage of a pneumatic conveyor (Le, 2018). The rapid ignition of such a cloud by an electrostatic discharge generated by triboelectric or frictional charging or by the simple contact with oxygen from the ambient atmosphere, can be considered as a 'pre-ignition' of the dust cloud.

More specifically, during explosion tests when a powder ignites before the ignition source has been triggered, this phenomenon will be called 'pre-ignition'. Various authors have already encountered it when testing titanium (Boilard et al., 2013) and aluminum (Santandrea et al., 2019a). Thus, some modifications in the 20-L sphere were proposed in order to avoid this drawback (Krietsch et al., 2013; Santandrea et al., 2019a, 2019b). However, such changes require an accurate understanding of the pre-ignition phenomenon and further investigations were especially performed on an aluminum nanopowder, with primary diameter of 40-60 nm, whose characteristics are presented in Table 1. This powder was stored under argon and exposed to oxygen only a few minutes before performing the experiments, but no pyrophoric behavior was observed, i.e. no spontaneous ignition occurred during the samples preparation. Standards tests were carried out according to EN 14034-1-2 (2004; 2006), and lead to the observation of alumina in the dust container for concentrations of 500, 750 and 1000 g.m⁻³ (Figure 7). This observation implies that Al combustion occurred at least partially in the dust container, thus leading to a signal transmitted by the pressure sensors which does not correspond to the pressure evolution in the 20-L sphere. In Figure 7, it should be noticed that the presence of alumina in the container is only observed for concentrations corresponding theoretically to the maximum explosion severity. After such phenomenon, it is essential to clean the dispersion system carefully as the presence of alumina stuck to the dust container walls and the valve can modify the dust injection dynamics.

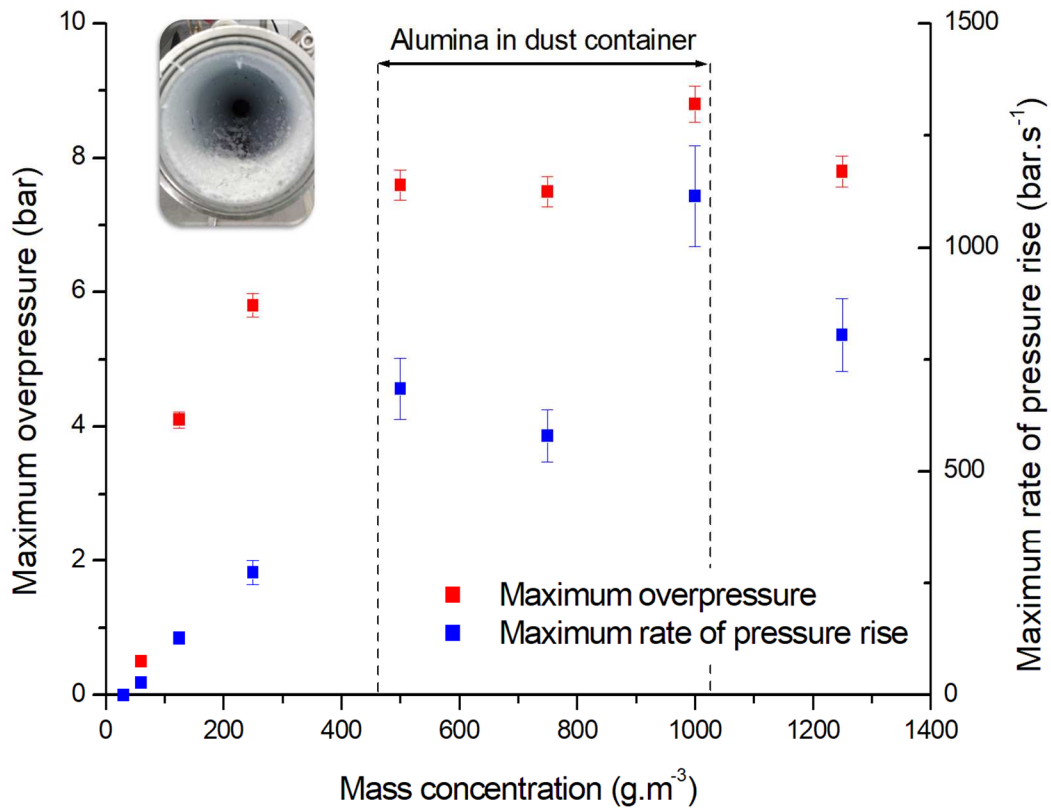

Figure 7. Evolution of explosion characteristics of aluminum nanopowder in standard conditions (10 kJ - 60 ms).

One possible adjustment of the operating conditions consists in removing the oxygen from the dust container and injecting the powder with pure nitrogen. The sphere is then enriched with oxygen after vacuuming to obtain atmospheric composition after powder injection, at the time of the explosion. However, for concentrations greater than 250 g.m⁻³, explosion started long before the activation of the ignitors, about 15 ms after the beginning of the dust injection, meaning the aluminum spontaneously ignited when in contact with the oxygen enriched atmosphere. The final pressure, obtained after total cooling of the sphere using the double jacket, is recorded when stabilized. It appears that the final pressure is always lower than the atmospheric pressure (Figure 8). Indeed, the combustion of aluminum mainly consists in the production of solid alumina generated from the reaction between solid aluminum and gaseous

oxygen, thus decreasing the global pressure in the vessel due to oxygen consumption. Therefore, by assuming that nitrogen is inert and that all the oxygen from air was consumed, a final pressure of around 0.8 bara should be obtained in the case of a total reaction. However, when using nitrogen injection, it appears that the final pressure is below this value for concentrations of 500 and 750 $\text{g}\cdot\text{m}^{-3}$, reaching respectively 0.73 and 0.74 bara. This observation implies that a nitridation reaction, possible at high pressure and temperature (2800K) (Kwon et al., 2003; Loryan and Borovinskaya, 2003), certainly occurs and generates aluminum nitrides. AlN cannot be oxidized due to the lack of oxygen, already partially consumed, and to kinetic limitation caused by rapid condensation and encapsulation of gaseous AlN (Kwon et al., 2003). Such phenomenon is certainly also observable for Al microparticles, but is promoted for nanopowders due to their high surface area and increased reactivity.

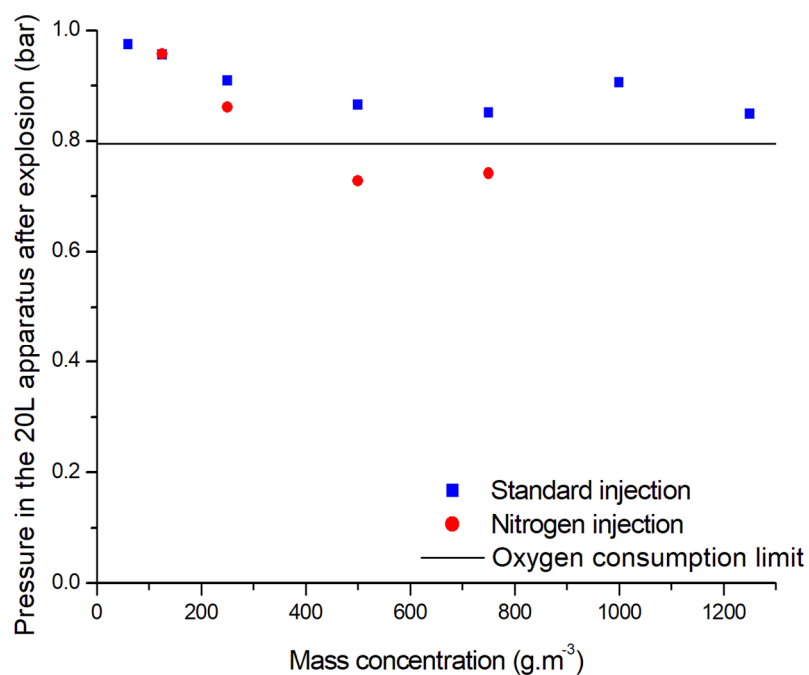

Figure 8. Pressure after explosion and cooling of the sphere at different aluminum nanopowder concentrations for standard injection and nitrogen injection.

So, for concentrations corresponding to the maximum explosion severity, for instance at 750 g.m^{-3} , alumina was observed in the dust container both for air or pure nitrogen injection. However, when analyzing the pressure-time evolution for both injection types, it appears that different pressure profiles are observable (Figure 9). During a standard air injection, a ‘normal’ pressure-time graph is obtained (Figure 9a); whereas an early explosion clearly occurs a few milliseconds after the beginning of the dust injection when using nitrogen injection. In the latter case, the explosion takes place as soon as Al is in contact with the oxygen enriched atmosphere and long before the activation of the ignitors (Figure 9b). A rather similar trace was obtained by Boilard et al. (2013) with nano-Ti injected under air. It then appears that, in our case, the presence of alumina in the dust container during standard injection cannot be explained by a ‘pre-ignition’ phenomenon since the explosion occurred only after the ignitors activation. To confirm this interpretation, injections of 750 g.m^{-3} of aluminum nanopowders were performed without activating the chemical ignitors in the sphere and, as expected, no explosion occurred.

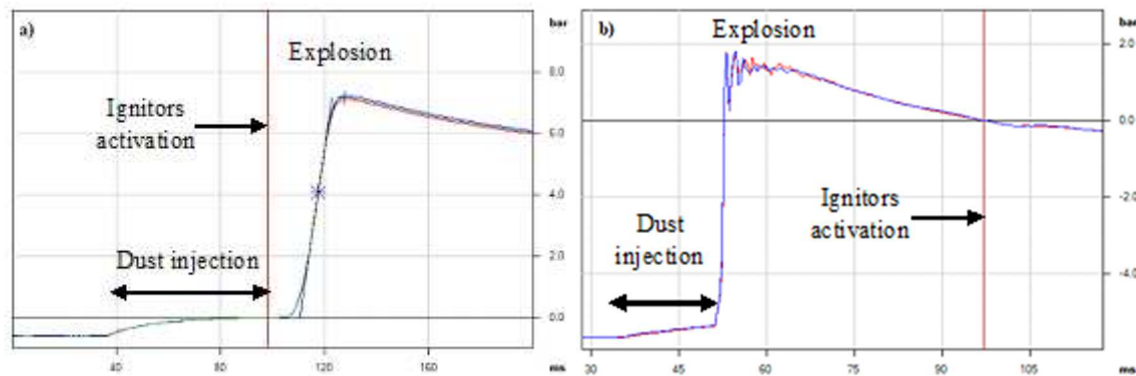

Figure 9. Pressure-time evolution of an aluminum explosion at 750 g.m^{-3} with a) air injection
b) nitrogen injection.

To clarify what happened in the dust container and explain the presence of alumina even with air injection, measurements were performed using an oscilloscope to estimate the closing delay of the electrovalve, for ignition delays of 60 ms and 120 ms. It appears in Figure 10a

that, for an ignition delay of 60 ms, the ignition starts before the electrovalve begins to close, enabling the flame to possibly go back to the dust container. Figure 10b shows that the opening delay of the electrovalve is independent of the ignition delay. At this point, it should be underlined that EN 14034-2 (2006) standard specifies that the electrovalve should open in less than 10 ms but no clear instructions on the closing time are provided. Nevertheless, this text notably proposes an alternative to the fast-acting valve, provided that its opening time is lower than 100 ms, which is significantly greater than 60 ms. It should also be added that the 20-L sphere manual (Cesana and Siwek, 2016) specifies that the time between the valve activation and the beginning of the pressure rise in the 20-L apparatus should be between 30 and 50 ms, otherwise the dispersion system (valve, nozzle...) is assumed to be dirty. This point has been checked for the tests considered in Figure 10.

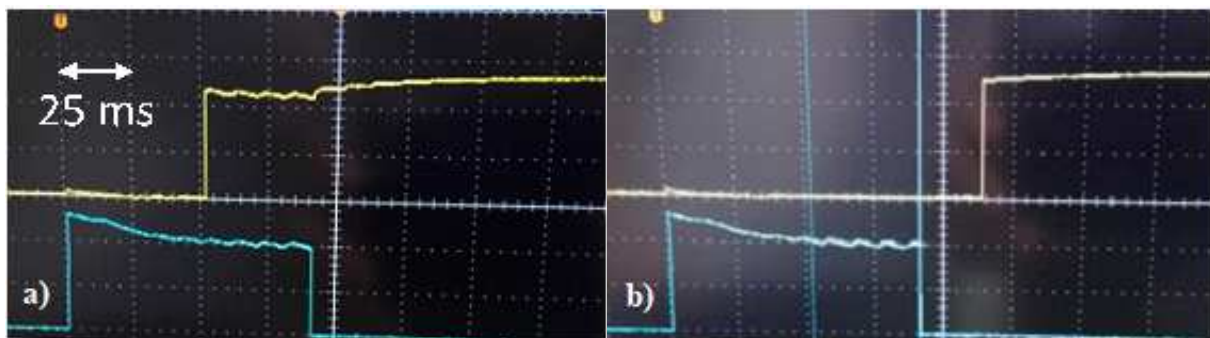

Figure 10. Electrical signal of the electrovalve (blue lower curve) and of the ignition (yellow upper curve) for ignition delay times of a) 60 ms and b) 120 ms

From this knowledge, since explosions involving metallic nanoparticles demonstrates a high severity and a fast flame propagation, the assumption of an explosion occurring in the sphere and reaching back the dust container seems more likely than that of a pre-ignition during the powder injection. To confirm this hypothesis, standard experiments with an ignition delay

time of 70 ms instead of 60 ms were performed, which allows the electrovalve to close before the flame reaches the bottom of the sphere. It should be added that such tv variation has only a small influence on the turbulence and will not sensitively impacts the flame propagation speed.

After the tests, no alumina was observed in the dust container, consolidating the hypothesis of the flame coming back to the dust container. Thus, to accurately evaluate the explosion severity of very explosive powders, especially metal nanopowders, it appears essential that the electrovalve closes well before the activation of the ignitors, by modifying its actuation parameters or by increasing the ignition delay time of several milliseconds. Nevertheless, a too large increase of tv may change the dust cloud turbulence and may probably reduce the explosion severity.

3.4. Punctuality is the politeness of kings: influence of the ignition delay time

‘Therefore, for dust testing, the ignition delay time, t_d , has been standardized for the 20-L sphere to $t_d = 60 \pm 5$ ms’ (ASTM E1226-12A, 2019). ‘The delay [... tv] shall be $(0.6 \pm 0.01$ s)’ (EN 14034-2, 2006).

The initial turbulence of the dust cloud has a great impact on the explosion severity, as highlighted through the variation of the ignition delay time (Amyotte et al., 1988; Santandrea et al., 2019b; Skjold, 2003). Several experimental and numerical studies notably demonstrated that the turbulence level of the dust cloud decreases with time after dispersion, and evolves in three phases (Dahoe, 2000; Murillo et al., 2018). The standard value of ignition delay time of 60 ms is then located in the second phase, which is the transition phase characterized by a significant decrease of the velocity fluctuations. However, if the dependency of turbulence on the ignition delay time is long proven and admitted, its impact on the particle size distribution

(PSD) is still to evaluate quantitatively, especially for nanopowders. Indeed, as a function of the particle nature and size, a high turbulence level can either induce a shear stress causing deagglomeration in the dust cloud or increase the number of contacts between particles, thus causing agglomeration. Moreover, when performing experiments with long ignition delay time, the influence of agglomerates settling can modify significantly the amount of dust that reacts during the explosion. Furthermore, decreasing the ignition delay time below 60 ms also modifies the injection dynamic to reach the atmospheric pressure before ignition. Thus, whereas dust injection is generally performed in 60 ms, a lower ignition delay time induces a faster dispersion, possibly modifying the PSD along with the turbulence.

Figure 11 presents PSD measurements of nanocellulose (Table 1) conducted at different ignition delay times and plotted at the moment of ignition for each. Then, it appears that variations in the ignition delay time between 20 and 120 ms do not significantly impact the PSD of nanocellulose after dispersion, in the measuring range of the apparatus. Though the whole range of particle size should be measured to draw an accurate conclusion, it seems that variations of ignition delay times will impact mainly turbulence and only slightly the PSD. It can be concluded then that slight modifications of ignition delay time will impact explosion severity mainly through turbulence modifications and not much by PSD variation.

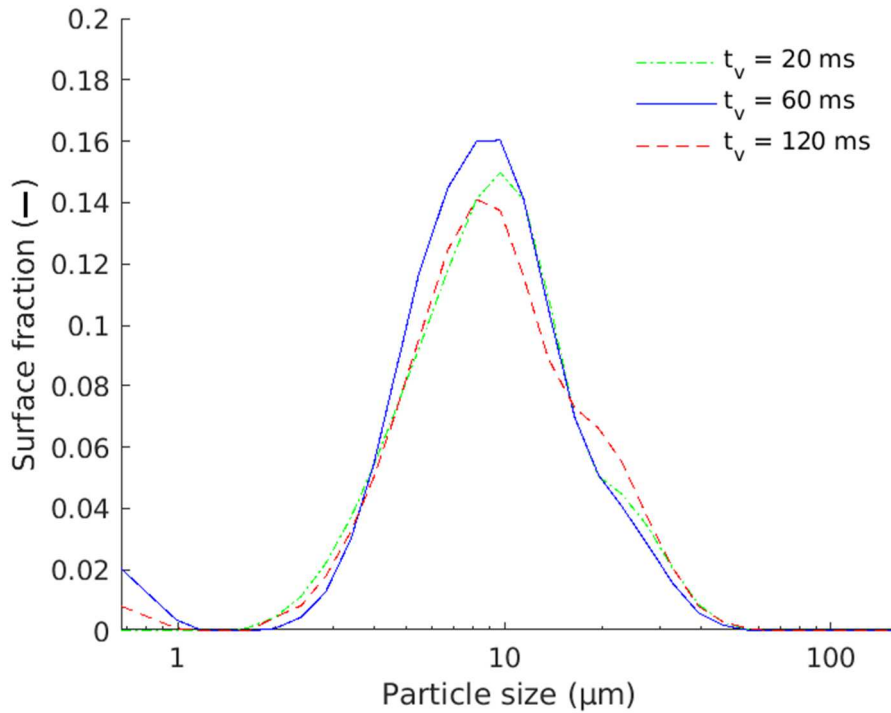

Figure 11. Particle size distribution of nanocellulose at the moment of ignition for different ignition delay times

Explosion tests with ignition delay time variation were also performed on nanocellulose and carbon black (Table 1), with concentrations of 750 g.m^{-3} and 250 g.m^{-3} respectively, which are the concentrations leading to the most severe explosions in standard conditions. To evaluate directly the influence of the turbulence level on explosion severity characteristics, the values of maximum overpressure and maximum rate of pressure rise presented in Figure 12 are plotted against the root-mean square velocity, using the relation between ignition delay time and root-mean square velocity proposed by Dahoe et al. (2001b). Ignition delay times from 20 ms to 200 ms were tested, which corresponds to root-mean square velocities from 15 m.s^{-1} to 0.5 m.s^{-1} (Dahoe et al., 2001b).

In Figure 12a, it appears that the maximum overpressure increases for both powders when slightly increasing the initial turbulence level in the combustion chamber, until reaching

maximum values of 7.0 ± 0.2 bar at 3.5 m.s^{-1} i.e. 60 ms, for the carbon black and of 8.4 ± 0.3 bar at 1.5 m.s^{-1} i.e. 100 ms, for the nanocellulose. This increase is due to the promoting effect of a moderate turbulence, which tends to improve the mass transfer by increasing the flame stretching and thus enhancing the flame propagation. It should be added that, at very low turbulence levels, the influence of the sedimentation of bigger particles or agglomerates should be taken into account as it can induce a more heterogeneous distribution of powders in the sphere. Conversely, at high turbulence, an intense flame stretching occurs. It improves the mass transfer and has a positive impact on the combustion kinetics, which is clearly visible in Figure 12b. Indeed, although diffusional limitation is unlikely to be observed when testing nanoparticles, such limitation is expected for organic micro-agglomerate (Dufaud et al., 2012). Finally, it should be kept in mind that a too high turbulence level can also lead to micro-scale flame quenching.

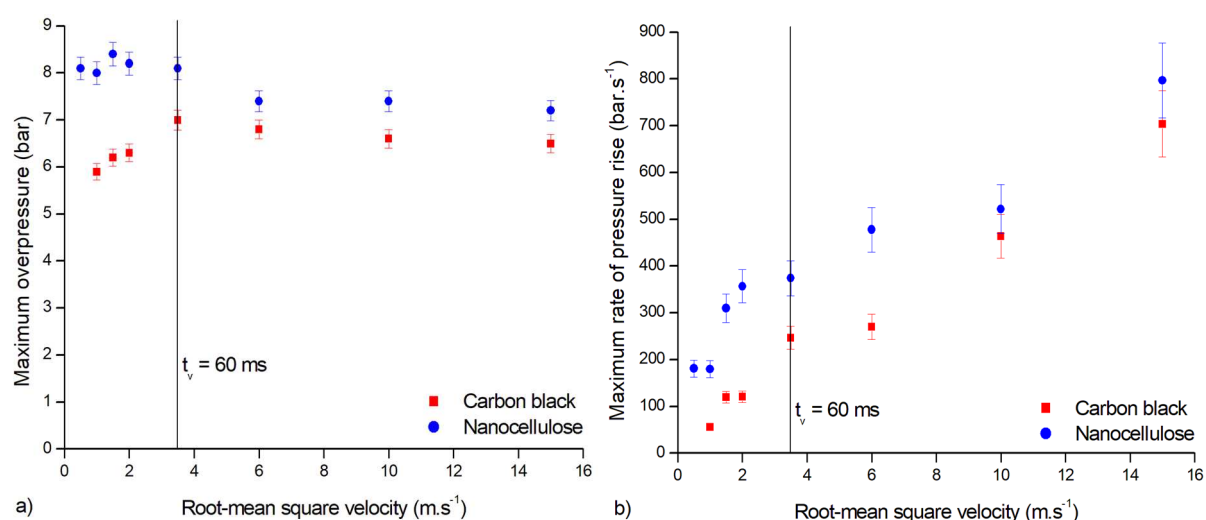

Figure 12. Evolution of a) the maximum overpressure and b) the maximum rate of pressure rise with the root-mean square velocity in the 20-L sphere

Combustion gases were collected and analyzed by gas chromatography, studying specifically the ratio CO/CO_2 (Figure 13). This ratio is higher than unity for ignition delay times lower than 100 ms, i.e. root-mean square velocities higher than 1.5 m.s^{-1} , and decreases for higher

ignition delay times for both powders. Although this ratio does not significantly vary for nanocellulose, a significant decrease is observed for carbon black, from 5.7 at 15 m.s⁻¹ to 0.6 at 1 m.s⁻¹. This evolution notably reflects the quenching occurring at high turbulence identified when studying the maximum overpressure (Figure 12). Furthermore, it shows that, nanoparticles being tracers of the gas flow, the turbulence level of the dust cloud can impact the maximum overpressure through a modification of oxidation products and mechanisms by quenching effects. Torrado (2017) notably noticed a premature extinction of the flame when studying hybrid mixtures from around 6 m.s⁻¹. The initial turbulence level also influences the maximum rate of pressure rise through turbulence/combustion interactions.

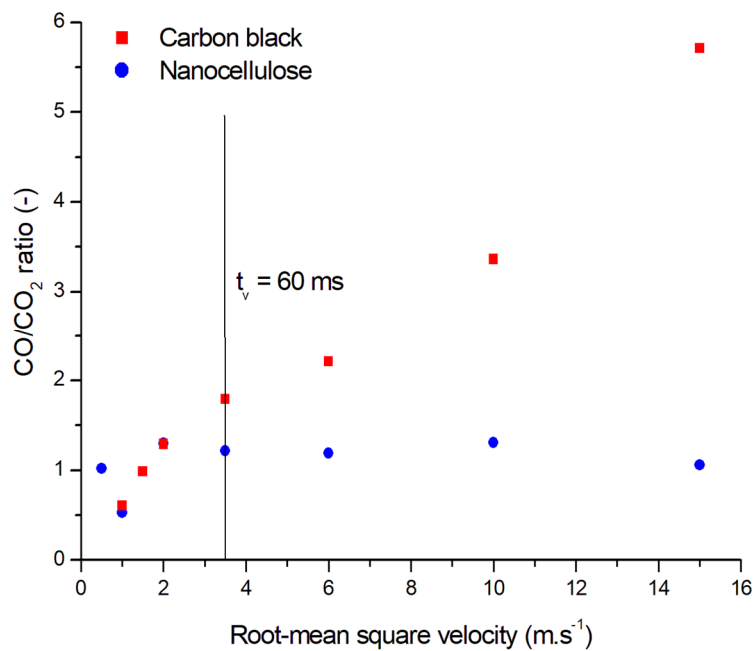

Figure 13. Evolution of the CO/CO₂ ratio with the root-mean square velocities for nanocellulose (at 750 g.m⁻³) and carbon black (at 250 g.m⁻³)

3.5. To the last drop: influence of humidity of the explosion severity of nanopowders

‘The maximum explosion pressure increases with decreasing moisture content. Therefore the moisture content shall be determined for the sample as tested and given in the test report.’

(EN 14034-1-2, 2004; 2006)

Humidity can greatly influence the explosive behavior of micropowders (Traoré et al., 2009; Yuan et al., 2014). It should be reminded that, when dealing with metal powders, the explosion severity can be increased by the dust moisture because of water reduction onto the particle surface and hydrogen generation occurring at high temperatures. For organic nanoparticles, such phenomenon will not take place, but other effects of the presence of water have to be considered.

Santandrea et al. (2019a) showed that a long storage of carbon nanoparticles under undried air increases their moisture content and leads to agglomeration due to strong capillary forces. As such agglomerates are incompletely broken during the injection process, the explosion severity can be reduced. Specific attention must therefore be paid when storing nanoparticles before testing them.

Drying the powder before testing can be a solution. However, the water sorption kinetics should also be considered. Tests were performed with carbon black nanopowders (Table 1) to determine their water activity A_w , before and after drying under vacuum at 100°C. Before drying, the water activity reaches 0.4, whereas immediately after drying, this parameter drops down to 0.03. However, by waiting 1 or 15 minutes before measuring the water activity, A_w increases and reaches respectively 0.11 and 0.22. Because of the high specific surface area, nanoparticles are prone to adsorb vapors and especially water, as a function of their chemical nature, which impacts their explosive behavior.

Explosion tests were carried out on raw and dried nanocellulose (Table 1). It should be recalled that the powders are introduced in the 20-L sphere by using synthetic -dry- air. In order to highlight the potential influence of the relative humidity of the air remaining in the sphere after vacuuming it at 0.4 bara, experiments were performed by flushing it several times with synthetic air before starting the test procedure. By adopting this procedure, the water content in the sphere before dust injection decreases from 0.4% to less than 0.1%. Figure 14

shows the maximum explosion pressure remains unchanged whatever the powder treatment or the test procedure. In addition, the maximum rate of pressure rise obtained with the dried powder is, as expected, significantly greater than with the raw powder. However, the explosion severity of nanocellulose is even lower when fully performing the test with synthetic air, which can be explained by analyzing the gases generated during the explosion.

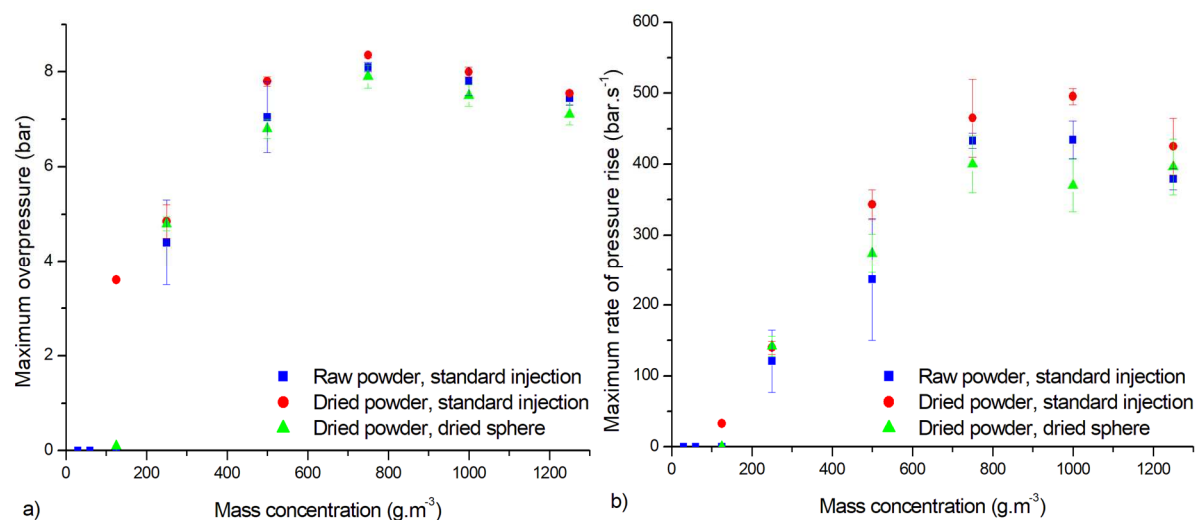

Figure 14. Explosion severity a) maximum overpressure and b) maximum rate of pressure rise of raw or dried nanocellulose as a function of the relative humidity in the 20-L sphere

The same trends observed in Figure 14 were obtained for carbon nanopowders. Figure 15 shows the evolution of the hydrogen content collected after combustion of carbon nanopowders in the explosion sphere. The presence of hydrogen, at concentration lower than 1%, can be explained by considering the reaction between carbon monoxide and water at high temperature, leading to the generation of carbon dioxide and hydrogen (Santandrea et al., 2019a). In Figure 15, the hydrogen content is always greater when using the standard procedure, which highlights the influence of the air relative humidity on the combustion mechanisms taking place during an explosion. These examples show that variations (in

storage time, relative humidity, water activity) that may seem insignificant have a significant impact when it comes to the explosion severity of nanoparticles.

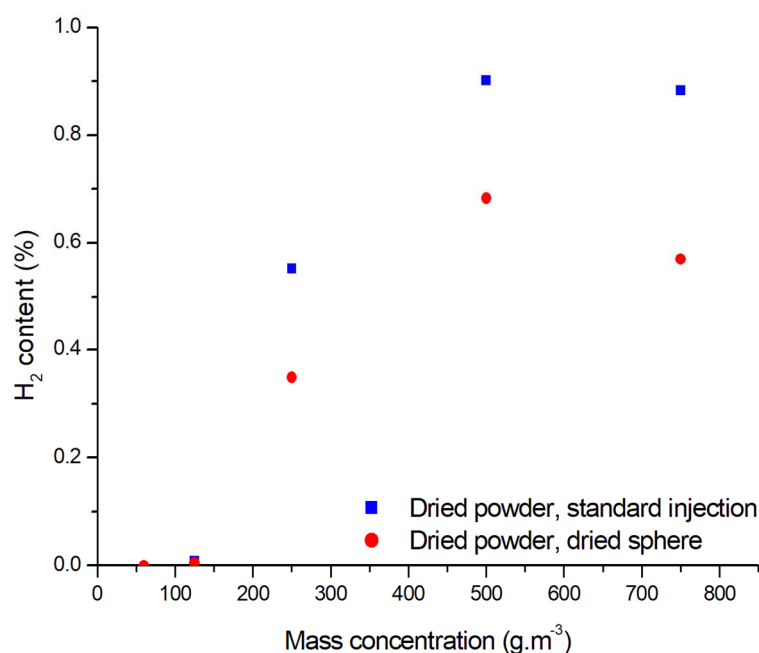

Figure 15. Hydrogen content in the burnt gases after carbon nanopowder explosion in the 20-L sphere using standard or modified injection procedure.

4. Conclusions

Nanopowders specificities (e.g. low sedimentation rate, agglomeration, high surface area, high sensitivity to ignition, etc.) induce explosive behaviors that are sometimes different from that observed for micropowders or, more generally, lead to exacerbated trends. As a consequence, in addition to safety issues inherent in handling nanopowders, standards should be adapted or cautious approaches should be taken when performing the tests in order to obtain reproducible and conservative results. For instance, the following improvements or advices can be suggested:

- i) It should be kept in mind that the particle size distribution of nanopowders will be modified by deagglomeration during their dispersion, even if standard PSD analyses cannot identify such a shift. Surface PSD will be preferred to volume-based distribution.
- ii) Alternative nozzles allow to reach higher explosion severities. Since standards objective is not to reproduce the exact industrial conditions, priority should focus on the reliability of the results by choosing nozzles providing a better cloud homogeneity.
- iii) The ignition source should be adapted to the low minimum ignition energy of the nanopowders in order to avoid overdriving or, at least, this phenomenon should be better considered by assessing the additional energy given to the dust cloud.
- iv) Pre-ignition of very sensitive nanopowders in the dust container can be avoided by injecting them under nitrogen (but spontaneous ignition still can occur in the sphere) or by using dust lifting as for MIE determination. However, as a result of their high flame speed propagation, the opening time of the electrovalve should be reduced to avoid a 'backfire' in the container or the delay tv should be adapted.
- v) Variations of the ignition delay time can be helpful to obtain the most conservative results. However, a too low turbulence level (e.g. $< 2 \text{ m.s}^{-1}$) can lead to agglomerate sedimentation, whereas a too high turbulence level (e.g. $> 6 \text{ m.s}^{-1}$) can induce alternative combustion mechanisms.
- vi) Special attention must be paid to the nanopowders storage conditions, to the samples preparation before testing (e.g. transition from an inert atmosphere to air, representativeness of the samples) and to the humidity of the ambient and injection air.

Finally, the results obtained must be transposed on an industrial scale, with the same limitations inherent to the cube-root law as those encountered for micropowders. An alternative approach, whose feasibility has been demonstrated for nanocellulose (Santandrea et al., 2020), would be to use the advantages of nanopowders, in particular their low

sedimentation rate, to determine their laminar flame velocity, which is an intrinsic parameter that can be used as an input for CFD simulations.

Acknowledgments

The authors would like to acknowledge Charly Koenig and Christian Blanchard (LRGP CNRS-UL) for their contributions in experimental setup design and Jean-François Rémy (LRGP CNRS-UL) for Scanning Electron Microscopy measurements. This work was supported financially by the French Ministry for the Ecological and Solidary Transition and The French Ministry for Higher Education and Research.

References

- Amyotte, P.R., Chippett, S., Pegg, M.J., 1988. Effects of turbulence on dust explosions. *Prog. Energy Combust. Sci.* 14, 293–310. [https://doi.org/10.1016/0360-1285\(88\)90016-0](https://doi.org/10.1016/0360-1285(88)90016-0)
- ASTM E1226-19, 2019. Standard Test Method for Explosibility of Dust Clouds, ASTM International, West Conshohocken, PA.
- Bagaria, P., Zhang, J., Yang, E., Dastidar, A., Mashuga, C., 2016. Effect of dust dispersion on particle integrity and explosion hazards. *J. Loss Prev. Process Ind.* 44, 424–432. <https://doi.org/10.1016/j.jlp.2016.11.001>
- Bartknecht, W., 1989. Dust-explosions: course, prevention, protection. Springer-Verlag.
- Boilard, S.P., Amyotte, P.R., Khan, F.I., Dastidar, A.G., Eckhoff, R.K., 2013. Explosibility of micron- and nano-size titanium powders. *J. Loss Prev. Process Ind.* 26, 1646–1654. <https://doi.org/10.1016/j.jlp.2013.06.003>

- Bouillard, J., Vignes, A., Dufaud, O., Perrin, L., Thomas, D., 2010. Ignition and explosion risks of nanopowders. *J. Hazard. Mater.* 181, 873–880.
<https://doi.org/10.1016/j.jhazmat.2010.05.094>
- CelluForce, 2016. Product Specification of CelluForce NCV100.
- CEN/TS 17274, 2018. Nanotechnologies - Guidelines for determining protocols for the explosivity and flammability of powders containing nano-objects (for transport, handling and storage).
- Cesana, C., Siwek, R., 2016. Manual for 20-l-Apparatus.
- Dahoe, A.E., Zevenbergen, J.F., Lemkowitz, S.M., Scarlett, B., 1996. Dust explosions in spherical vessels: The role of flame thickness in the validity of the ‘cube-root law.’ *J. Loss Prev. Process Ind.* 9, 33–44. [https://doi.org/10.1016/0950-4230\(95\)00054-2](https://doi.org/10.1016/0950-4230(95)00054-2)
- Dahoe, A.E., 2000. Dust explosions: a Study of Flame Propagation (PhD Thesis). Delft University, Delft.
- Dahoe, A. E., Cant, R.S., Pegg, M.J., Scarlett, B., 2001a. On the transient flow in the 20-liter explosion sphere. *J. Loss Prev. Process Ind.* 14, 475–487.
[https://doi.org/10.1016/S0950-4230\(01\)00052-3](https://doi.org/10.1016/S0950-4230(01)00052-3)
- Dahoe, A.E., Cant, R.S., Scarlett, B., 2001b. On the Decay of Turbulence in the 20-Liter Explosion Sphere. *Flow Turbul. Combust.* 67, 159–184.
<https://doi.org/10.1023/A:1015099110942>
- Dastidar, A., 2019. Dust explosions: Test methods, in: *Methods in Chemical Process Safety*. Elsevier, pp. 71–122. <https://doi.org/10.1016/bs.mcps.2019.04.002>
- Di Benedetto, A., Sanchirico, R., Di Sarli, V., 2019. Dust explosions: Emerging/unique scenarios, in: *Methods in Chemical Process Safety*. Elsevier, 283–316.
<https://doi.org/10.1016/bs.mcps.2019.02.002>

- Di Sarli, V., Danzi, E., Marmo, L., Sanchirico, R., Benedetto, A.D, 2019. Issues of “Standard” explosion tests for non-spherical dusts. *Chemical Engineering Transactions*, 77, 691-696. <https://doi.org/10.3303/CET1977116>.
- Dufaud, O., Khalili, I., Cuervo-Rodriguez, N., Olcese, R.N., Dufour, A., Perrin, L., Laurent, A., 2012. Highlighting the Importance of the Pyrolysis Step on Dusts Explosions. *Chem. Eng. Trans.* 26, 369–374.
- Eckhoff, R.K., 1977. The use of the Hartmann bomb for determining Kst values of explosible dust clouds. *Staub-Reinhaltung der Luft*, 21(3), 110-112.
- Eckhoff, R.K., 1985. Use of closed-bomb tests for predicting violence of accidental dust explosions in industrial plants. *Fire Saf. J.* 8, 159–168. [https://doi.org/10.1016/0379-7112\(85\)90053-0](https://doi.org/10.1016/0379-7112(85)90053-0)
- Eckhoff, R.K., 2012. Does the dust explosion risk increase when moving from μm -particle powders to powders of nm-particles?, *Journal of loss prevention in the process industries*, 25, 448-459.
- Eckhoff, R.K., 2003. *Dust Explosions in the Process Industries: Identification, Assessment and Control of Dust Hazards*. Third Edition, Chapter 3, Gulf Professional Publishing, Elsevier.
- EN 14034-1, 2004. Determination of explosion characteristics of dust clouds — Part 1: Determination of the maximum explosion pressure P_{max} of dust clouds.
- EN 14034-2, 2006. Determination of explosion characteristics of dust clouds — Part 2: Determination of the maximum rate of explosion pressure rise $(dp/dt)_{\text{max}}$ of dust clouds.
- Going, J.E., Chatrathi, K., Cashdollar, K.L., 2000. Flammability limit measurements for dusts in 20-L and 1-m³ vessels. *J. Loss Prev. Process Ind.* 13, 209–219. [https://doi.org/10.1016/S0950-4230\(99\)00043-1](https://doi.org/10.1016/S0950-4230(99)00043-1)

- Holbrow, P., Wall, M., Sanderson, E., Bennett, D., Rattigan, W., Bettis, R., Gregory, D., 2010. Fire and explosion properties of nanopowders.
- ISO/IEC 80079-20-2, 2016. Explosive atmospheres — Part 20-2: Material characteristics — Combustible dusts test methods.
- Jeevanandam, J., Barhoum, A., Chan, Y.S., Dufresne, A., Danquah, M.K., 2018. Review on nanoparticles and nanostructured materials: history, sources, toxicity and regulations. *Beilstein J. Nanotechnol.* 9, 1050–1074. <https://doi.org/10.3762/bjnano.9.98>
- Kalejaiye, O., Amyotte, P.R., Pegg, M.J., Cashdollar, K.L., 2010. Effectiveness of dust dispersion in the 20-L Siwek chamber. *J. Loss Prev. Process Ind.* 23, 46–59. <https://doi.org/10.1016/j.jlp.2009.05.008>
- Krietsch, A., Romahn, T.-M., Scheid, M., Krause, U., 2013. Modified setup of 20-l-sphere for the determination of safety characteristics of nano powders. *Chem. Eng. Trans.* 805–810. <https://doi.org/10.3303/CET1331135>
- Krietsch, A., Scheid, M., Schmidt, M., Krause, U., 2015. Explosion behaviour of metallic nano powders. *J. Loss Prev. Process Ind.* 36, 237–243. <https://doi.org/10.1016/j.jlp.2015.03.016>
- Kwon, Y.-S., Gromov, A.A., Ilyin, A.P., Popenko, E.M., Rim, G.-H., 2003. The mechanism of combustion of superfine aluminum powders. *Combust. Flame* 133, 385–391. [https://doi.org/10.1016/S0010-2180\(03\)00024-5](https://doi.org/10.1016/S0010-2180(03)00024-5)
- Le, H.D., 2018. Modelling of nanoparticles-laden jet from a conveying pipe leakage (PhD Thesis). Université de Toulouse, France
- Loryan, V.É., Borovinskaya, I.P., 2003. Aluminum Combustion in Nitrogen. *Combust. Explos. Shock Waves* 39, 525–533. <https://doi.org/10.1023/A:1026105600954>

- Martin, C., Comet, M., Schnell, F., Berthe, J.-E., Spitzer, D., 2018. Aluminum nanopowder: A substance to be handled with care. *J. Hazard. Mater.* 342, 347–352. <https://doi.org/10.1016/j.jhazmat.2017.08.018>
- Mohan, S., Ermoline, A., Dreizin, E.L., 2012. Pyrophoricity of nano-sized aluminum particles. *J. Nanoparticle Res.* 14, 723. <https://doi.org/10.1007/s11051-012-0723-x>
- Murillo, C., Amín, M., Bardin-Monnier, N., Muñoz, F., Pinilla, A., Ratkovich, N., Torrado, D., Vizcaya, D., Dufaud, O., 2018. Proposal of a new injection nozzle to improve the experimental reproducibility of dust explosion tests. *Powder Technol.* 328, 54–74. <https://doi.org/10.1016/j.powtec.2017.12.096>
- Proust, Ch., Accorsi, A., Dupont, L., 2007. Measuring the violence of dust explosions with the “20L sphere” and with the standard “ISO 1m³ vessel”: Systematic comparison and analysis of the discrepancies. *J. Loss Prev. Process Ind., Selected Papers Presented at the Sixth International Symposium on Hazards, Prevention and Mitigation of Industrial Explosions* 20, 599–606. <https://doi.org/10.1016/j.jlp.2007.04.032>
- Pu, Y.K., Jarosinski, J., Johnson, V.G., Kauffman, C.W., 1991. Turbulence effects on dust explosions in the 20-liter spherical vessel. *Symp. Int. Combust., Twenty-Third Symposium (International) on Combustion* 23, 843–849. [https://doi.org/10.1016/S0082-0784\(06\)80338-3](https://doi.org/10.1016/S0082-0784(06)80338-3)
- Sanchirico, R., Di Sarli, V., Russo, P., Di Benedetto, A., 2015. Effect of the nozzle type on the integrity of dust particles in standard explosion tests. *Powder Technol.* 279, 203–208. <https://doi.org/10.1016/j.powtec.2015.04.003>
- Santandrea, A., Pacault, S., Perrin, L., Vignes, A., Dufaud, O., 2019a. Nanopowders explosion: Influence of the dispersion characteristics. *J. Loss Prev. Process Ind.*, 62, 103942. <https://doi.org/10.1016/j.jlp.2019.103942>

- Santandrea, A., Vignes, A., Krietsch, A., Perrin, L., Laurent, A., Dufaud, O., 2019b. Some Key Considerations when Evaluating Explosion Severity of Nanopowders. *Chem. Eng. Trans.* 77, 235–240. <https://doi.org/10.3303/CET1977040>
- Santandrea, A., Gavard, M., Pacault, S., Vignes, A., Perrin, L., Dufaud, O., 2020. ‘Knock on nanocellulose’: Approaching the laminar burning velocity of powder-air flames. *Process Safety and Environmental Protection*, 134, 247-259. doi:10.1016/j.psep.2019.12.018
- Siwek, R., 1988. Reliable determination of the safety characteristics in 20-l apparatus. *Proc. Conf. Flammable Dust Explos.* 529–573.
- Siwek, R., 1977. 20-l Laborapparatur für die Bestimmung der Explosionskenngrößen brennbarer Stäube (PhD Thesis). Technical University of Winterthur, Winterthur, Switzerland.
- Skjold, T., 2003. Selected aspects of turbulence and combustion in 20-Litre explosion vessel (Master thesis). University of Bergen, Norway.
- Tamanini, F., 1990. Turbulence effects on dust explosion venting. *PlantOperations Prog.* 9, 52–60. <https://doi.org/10.1002/prsb.720090111>
- Torrado, D., 2017. Effect of carbon black nanoparticles on the explosion severity of gas mixtures (PhD Thesis). Université de Lorraine, France.
- Traoré, M., Dufaud, O., Perrin, L., Chazelet, S., Thomas, D., 2009. Dust explosions: How should the influence of humidity be taken into account? *Process Saf. Environ. Prot.*, 12th International Symposium of Loss Prevention and Safety Promotion in the Process Industries 87, 14–20. <https://doi.org/10.1016/j.psep.2008.08.001>
- van der Wel, P.G.J., van Veen, J.P.W., Lemkowitz, S.M., Scarlett, B., van Wingerden, C.J.M., 1992. An interpretation of dust explosion phenomena on the basis of time scales. *Powder Technol.* 71, 207–215. [https://doi.org/10.1016/0032-5910\(92\)80010-T](https://doi.org/10.1016/0032-5910(92)80010-T)

- Wengeler, R., Nirschl, H., 2007. Turbulent hydrodynamic stress induced dispersion and fragmentation of nanoscale agglomerates. *J. Colloid Interface Sci.* 306, 262–273. <https://doi.org/10.1016/j.jcis.2006.10.065>
- Wu, H.-C., Ou, H.-J., Hsiao, H.-C., Shih, T.-S., 2010. Explosion Characteristics of Aluminum Nanopowders. *Aerosol Air Qual. Res.* 10, 38–42. <https://doi.org/10.4209/aaqr.2009.06.0043>
- Wu, W., Liu, L., Zhang, Q., 2017. A new 20 L experimental vessel for dust explosion and measurement of local concentration. *Journal of Loss Prevention in the Process Industries*, 49, 299-309. <https://doi.org/10.1016/j.jlp.2017.07.012>
- Yao, N., Wang, L., Bai, C., Liu, N., Zhang, B., 2020. Analysis of dispersion behavior of aluminum powder in a 20 L chamber with two symmetric nozzles. *Process Saf. Prog.* 39(1). <https://doi.org/10.1002/prs.12097>
- Yuan, J., Wei, W., Huang, W., Du, B., Liu, L., Zhu, J., 2014. Experimental investigations on the roles of moisture in coal dust explosion. *J. Taiwan Inst. Chem. Eng.* 45, 2325–2333. <https://doi.org/10.1016/j.jtice.2014.05.022>
- Zalosh, R., 2019. Dust explosions: Regulations, standards, and guidelines, in: *Methods in Chemical Process Safety*. Elsevier, pp. 229–282. <https://doi.org/10.1016/bs.mcps.2019.03.003>
- Zhang, Q., Zhang, B., 2015. Effect of ignition delay on explosion parameters of corn dust/air in confined chamber. *J. Loss Prev. Process Ind.* 33, 23–28. <https://doi.org/10.1016/j.jlp.2014.11.009>
- Zhen, G., Leuckel, W., 1997. Effects of ignitors and turbulence on dust explosions. *J. Loss Prev. Process Ind.* 10, 317–324. [https://doi.org/10.1016/S0950-4230\(97\)00021-1](https://doi.org/10.1016/S0950-4230(97)00021-1)