



HAL
open science

Two Improvements to Gardner's Method of Measuring the Hydraulic Conductivity of Non-saturated Media: Accounting for Impedance Effects and Non-constant Imposed Suction Increment

Filip Stanić, Pierre Delage, Yu-Jun Cui, Emmanuel de Laure, Pierre-Antoine Versini, Daniel Schertzer, Ioulia Tchiguirinskaia

► To cite this version:

Filip Stanić, Pierre Delage, Yu-Jun Cui, Emmanuel de Laure, Pierre-Antoine Versini, et al.. Two Improvements to Gardner's Method of Measuring the Hydraulic Conductivity of Non-saturated Media: Accounting for Impedance Effects and Non-constant Imposed Suction Increment. *Water Resources Research*, 2020, 56 (1), pp.e2019WR026098. 10.1029/2019WR026098 . hal-03058516

HAL Id: hal-03058516

<https://hal.science/hal-03058516v1>

Submitted on 7 Jul 2023

HAL is a multi-disciplinary open access archive for the deposit and dissemination of scientific research documents, whether they are published or not. The documents may come from teaching and research institutions in France or abroad, or from public or private research centers.

L'archive ouverte pluridisciplinaire **HAL**, est destinée au dépôt et à la diffusion de documents scientifiques de niveau recherche, publiés ou non, émanant des établissements d'enseignement et de recherche français ou étrangers, des laboratoires publics ou privés.

1 Two improvements to Gardner's method of measuring the
2 hydraulic conductivity of non-saturated media: accounting for
3 impedance effects and non-constant imposed suction increment

4

5 Filip STANIĆ^{1,2}, Pierre DELAGE¹, Yu-Jun CUI¹, Emmanuel DE LAURE¹, Pierre-Antoine
6 VERSINI², Daniel SCHERTZER², Ioulia TCHIGUIRINSKAIA²

7

8 ¹ Ecole des Ponts ParisTech, Navier/CERMES, Marne la Vallée, France

9 ² Ecole des Ponts ParisTech, HM&Co, Marne la Vallée, France

10

11

12

13

14

15

16 Corresponding author:
17 Filip Stanic
18 Ecole des Ponts ParisTech
19 6-8 av. Blaise Pascal, Cité Descartes, Champs-sur-Marne
20 77455 Marne-la-Vallée cedex 2
21 France

22

23 Email: filip.stanic@enpc.fr
24 Orcid: 0000-0003-0271-5993

25

26

27

28 **Abstract:**

29 Gardner (1956)'s transient method of measuring the hydraulic conductivity function of
30 unsaturated media has been largely used, together with the improved graphical method proposed
31 by Kunze and Kirkham (1962) to account for the impedance effect resulting from using a low
32 permeability ceramic disk in porous plate testing. These methods are nowadays seldom used,
33 since they have been replaced by numerical back analysis approaches and parameter optimisation
34 algorithms methods. Based on tests carried out on a specific device allowing to determine the
35 water retention and transport properties of water in a coarse granular media at low suctions (up to
36 50 kPa), it was found necessary to account i) for impedance effects and ii) for the effects of non-
37 constant suction increments, as is often the case when using the hanging column technique. A
38 new method is proposed to account for impedance effects, based on an analytical solution of the
39 equations governing water transfers. The validity of this method is tested by considering
40 experimental data from three distinct materials: a coarse green roof volcanic substrate, poorly
41 graded sand and undisturbed silty clay. Compared to the graphical method Kunze and Kikham's
42 method, it is less operator dependent and hence more objective. It is also simpler than numerical
43 analysis methods, since it does not require any use of numerical code or parameter optimisation
44 algorithm, providing a more direct and reliable access to the investigated parameter. An
45 analytical solution is also proposed to solve the problem resulting from the application of a non-
46 constant suction increment.

47

48 Key words: hydraulic conductivity; Gardner's method; impedance effect; non-constant suction
49 increment; Kunze & Kirkham; green roof

50 Introduction

51 Gardner's method (Gardner, 1956) was the first analytical method of calculating the hydraulic
52 conductivity of unsaturated porous media by measuring, in the pressure plate apparatus, the
53 transient outflow resulting from an increase in suction, applied to the unsaturated specimen
54 through an increase in air pressure. This method is based on various assumptions, including the
55 linearity of the water retention curve (WRC) and a constant value of the diffusivity D over the
56 suction increment applied (both hypotheses are better fulfilled with small suction increments).
57 Gardner's method doesn't account for the impedance effects of the plate (made up of a high air
58 entry value saturated ceramic porous disk) that may have a significantly lower permeability than
59 that of the saturated specimen. This impedance effect was considered for first time by Miller and
60 Elrick (1958), who proposed an analytical method to account for the flow resistance exerted by
61 the disk, provided the disk permeability was known and the contact specimen/disk was perfect.
62 Rijtema (1959) improved the method by developing a solution based on the permeability ratio
63 between the soil and the disk, valid regardless of the quality of the specimen/disk contact.
64 Finally, Kunze and Kirkham (1962) developed a graphical method based on Miller and Elrick's
65 method, in which particular attention was focused on the accurate determination of initial
66 outflow values, believed to be particularly important with respect to impedance effects.
67 However, this method, based on fitting experimental data against normalized charts to obtain
68 some parameters required to calculate the HCF, obviously presents some degree of subjectivity
69 and operator dependency. More recently, Valiantzas (1990) proposed an analytical method that
70 was not based on the assumption of constant diffusivity. The method was applied on single-step
71 outflow measurements (Doering, 1965) by using an iterative algorithm to determine the
72 relationship between the diffusivity and the water content. The main disadvantage of this method

73 is that the water retention curve, necessary to make the calculations, has to be determined
74 independently of the hydraulic conductivity function (HCF).

75 In the past decades, numerical back analysis methods have been preferred to determine the HCF
76 of unsaturated soils, through the simulation of water flow in unsaturated media by numerically
77 solving Richard's equation (Richards, 1931). They account for impedance effects by simulating
78 transient water outflows from two-layered specimens (soil specimen and ceramic disk) submitted
79 to suction increments (Eching and Hopmans, 1993; Eching et al., 1994; van Dam et al., 1994;
80 Durner and Iden, 2011; Schelle et al., 2011; Nasta et al., 2011; Wayllace and Lu, 2011). In these
81 calculations, some pedotransfer functions (Pachepsky and van Genuchten, 2011) are used to
82 describe the hydraulic properties of the soils. By using different optimization algorithms
83 minimizing the deviation between measured and simulated outflows (Duan et al., 1992; Šimunek
84 et al., 2008), an optimal set of parameters of the pedotransfer functions used was obtained. Since
85 the WRC of the investigated materials cannot be always reliably interpreted with pedotransfer
86 functions that depend either on one (Brooks & Corey, 1964) or several semi-empirical
87 parameters (van Genuchten, 1980; Fredlund & Xing, 1994; etc.), the HCF derived through
88 Mualem's approach (1976) does not necessarily provide realistic results (e.g. Khaleel and
89 Relyea, 1995). Moreover, Mualem's model depends on a parameter that accounts for the
90 influences of the pore interconnectivity and of the tortuosity of the medium (Yates et al., 1992;
91 Schaap and Leij, 2000; Peters et al., 2011), a parameter difficult to determine and often excluded
92 from optimization processes. Also, the well-known problem occurring when many parameters
93 are involved in an optimization algorithm is that the solution is not unique, with various
94 convenient parameter combinations.

95 Given the advantages and drawbacks of existing methods, a new and simple analytical approach
96 to account for impedance effects in the determination of the HCF of unsaturated soils is proposed
97 in this paper, together with an approach to account for non-constant imposed suction increment.
98 The validation of the method is carried out based on experimental data from three different
99 materials, i.e. a coarse material used as substrate in an urban green roof located in the Paris area
100 and called the “Green Wave” because of its wavy shape (Versini et al. 2018, Stanic et al. 2019),
101 a poorly graded sand and an undisturbed silty clay (Wayllace and Lu 2011). This analytical
102 method is simpler than numerical back analysis methods since it does not require the use of any
103 numerical code and optimization process. It is also not affected either by any subjective
104 graphical method like in the traditional Kunze and Kirkham’s method.

105 **Experimental investigations**

106 This work was initially developed when investigating the water retention and transfer properties
107 of a volcanic coarse substrate used in an urban green roof in the Paris area, detailed in Stanic et
108 al. (2019). The device, material and data of this work will be recalled and considered in more
109 details. The validity of the method will then be further established by also considering the
110 experimental data obtained on two quite different materials (a poorly graded sand and an
111 undisturbed silty clay) published by Wayllace and Lu (2011).

112 **Stanic et al. (2019)’s data**

113 The device developed by Stanic et al. (2019), presented in Figure 1, consists of a metal cell
114 (inner diameter 7×10^{-2} m, height 5×10^{-2} m, cross sectional area $A = 3.848 \times 10^{-3}$ m²) in which
115 a 2.4×10^{-2} m height specimen is placed on a high air entry value (HAEV) ceramic porous disk
116 of thickness $\Delta z_d = 5 \times 10^{-3}$ m. The air entry value of the disk is 50 kPa and its saturated

117 permeability $K_d = 4.02 \times 10^{-8}$ m/s. The porous disk is connected to a thin flexible tube (5×10^{-3}
118 m inner diameter) connected, through a valve V1, to a mobile device aimed at accurately
119 imposing, at the other extremity of the flexible tube, a water level lower than that of the
120 specimen top. This hanging column device allows, through the HAEV ceramic porous disk, to
121 apply a suction measured by the difference in height (h_k) between the controlled lower level
122 (left), and that of the specimen top (right). The maximum height allowed by the system is equal
123 to 5 m, corresponding to a maximum suction of 50 kPa. Figure 1 shows the two options
124 permitted by the device. In the case of large water exchanges with the specimen, like those
125 occurring close to full saturation, the configuration described in a), in which a constant level is
126 imposed in the inner tube by an overflow system, is used. The larger excess of water extracted is
127 collected in an outer tube of larger inner diameter (1.5×10^{-2} m). When less water is extracted, a
128 more accurate monitoring - described in b) - is allowed by following the change in level of the
129 extracted water in the inner tube (5×10^{-3} m inner diameter, 8×10^{-3} m outer diameter). In this
130 case, lowering the mobile device to a fixed position results in applying a non-constant suction at
131 the specimen, since the water extracted progressively refills the inner tube.

132 The Figure also shows that the thin tube is connected, through valve V2, to a high precision (0.1
133 mm) differential pressure transducer, that gives the difference in pressure between the thin tube
134 and a reference constant water height, previously adjusted at optimum level. In the configuration
135 at constant imposed suction, valve V3 is opened and V2 closed, and the pressure transducer
136 measures the change in hydrostatic pressure resulting from the increase in water level in the
137 outer tube. Alternatively, when valve V3 is closed and V2 open, the transducer measures the
138 pressure corresponding to the changing height in the inner tube.

139 The material investigated is the volcanic substrate used for covering the “Green Wave” in the
140 city of Champs-sur-Marne in France (Versini et al., 2018). From a hydrological point of view,
141 the water retention and transfer properties of this substrate are necessary to investigate the
142 mitigation and delay of the runoff peak on the green roof (Stovin et al., 2015), especially in the
143 near saturated zone (Vogel et al., 2001). The substrate used is a coarse granular material with 4
144 % of organic matter, an average grain density of 2.35 Mg/m^3 and a density of 1.4 Mg/m^3 , with
145 $D_{50} = 1.5 \text{ mm}$, 15% particles smaller than $80 \text{ }\mu\text{m}$ and a curvature coefficient ($D_{30}^2/(D_{10} D_{60})$) of
146 1.95. The saturated hydraulic conductivity of the substrate is $K_s = 8.11 \times 10^{-6} \text{ m/s}$, and its water
147 retention curve is given in Figure 2 (Stanic et al., 2019).

148 **Wayllace and Lu (2011)’s data**

149 Wayllace and Lu (2011) developed a transient water release and imbibition (TWRI) method for
150 determining the WRC and HCF of two materials along the drying and wetting paths, by
151 imposing, through the axis translation method, two suction increments for draining water from
152 the soil specimen, followed by a suction decrease allowing subsequent water imbibition. The
153 TWRI apparatus consisted of i) a flowcell accommodating a soil specimen of 6.07 cm diameter
154 placed on 300 kPa HAEV ceramic disk (saturated permeability $K_d = 2.5 \times 10^{-9} \text{ m/s}$, thickness Δz_d
155 $= 3.2 \times 10^{-3} \text{ m}$, area $A = 2.894 \times 10^{-3} \text{ m}^2$), ii) a pressure regulator connected to cell top and iii) a
156 water jar placed on a weight scale connected to cell bottom to collect the drained outflow (more
157 details in Wayllace and Lu, 2011).

158

159 During drainage, a first imposed suction increment was fixed (3 kPa for sand and 5 kPa for silty
160 clay), just above the specimen air entry values, small enough to just initiate the outflow from the
161 specimen, while the second step was significantly larger (about 300 kPa).

162 Wayllace and Lu investigated two different soils: a remoulded poorly graded sand compacted to
163 a porosity of 0.39 and an undisturbed silty clay with a porosity 0.44. The values of the saturated
164 hydraulic conductivities of these soils are $K_s = 2.1 \times 10^{-6}$ m/s and 1.1×10^{-7} m/s, respectively.
165 The significantly lower saturated permeability of the ceramic disk clearly indicates that
166 impedance effects have to be accounted for when analysing the outflow data.

167 **Analytical methods of determining the hydraulic conductivity of** 168 **unsaturated materials**

169 The two most used analytical methods of determining the hydraulic conductivity of unsaturated
170 materials are Gardner's method (with no impedance effect) and Kunze and Kirkham's method, in
171 which impedance effects are accounted for. The assumptions made in Gardner's method
172 (linearity of the water retention curve and constant diffusivity along the small suction step
173 applied) allow to transform Richard's equation (Richards, 1931) into an equation similar to
174 Fourier's heat equation, comparable to the Terzaghi-Fröhlich equation (Terzaghi & Fröhlich,
175 1936) that governs the consolidation of saturated soils. The analytical solution using Fourier's
176 series can then be used. When using Stanic et al. (2019)'s device, it was preferred to express
177 suction and water pressures in terms of water height $h_k(z, t)$ [L], as the sum of the initial suction
178 $h_k(z, 0)$ and the time depending change of suction $\Delta h_k(z, t)$. Given that the imposed suction
179 increment Δh_i (index i for "imposed") is immediately transferred to the bottom of the specimen
180 ($\Delta h_k(z=0, t) = \Delta h_i = const.$), the ratio $\Delta h_k(z, t) / \Delta h_i$ is analog to the degree of consolidation in
181 Terzaghi-Fröhlich's theory, expressed using Fourier's series as follows:

$$182 \Delta h_k(z, t) = \Delta h_i \left(1 - \frac{4}{\pi} \sum_{n=1,3,5,\dots}^{\infty} \frac{1}{n} e^{-(n\pi/2)^2 tD(h_k)/H_s^2} \sin \frac{n\pi z}{2H_s} \right) \quad (1)$$

183 in which H_s is the specimen thickness [L], and $D(h_k) = K(h_k)/C(h_k)$ is the (constant) diffusivity
 184 value [L^2/T] at suction h_k , which is equal to the ratio between the hydraulic conductivity value
 185 $K(h_k)$ [L/T] and the slope of the water retention curve along the applied suction step $C(h_k)$ [L^{-1}].

186 Since the first derivative at the specimen bottom $\left. \frac{\partial h_k(z,t)}{\partial x} \right|_{z=0} = \left. \frac{\partial \Delta h_k(z,t)}{\partial x} \right|_{z=0}$ governs the drained
 187 outflow, assuming a linear water retention curve and integrating the flux in time, the total water
 188 content at time t can be obtained. The changes in water volume are finally expressed as:

$$189 \quad V(t) = V_\infty \left(1 - \frac{8}{\pi^2} \sum_{n=1,3,5,\dots}^{\infty} \frac{1}{n^2} e^{-(n\pi/2)^2 t D(h_k)/H_s^2} \right) \quad (2)$$

190 in which V_∞ is the total volume [L^3] of the outflow drained from the soil specimen after imposing
 191 Δh_i . The total extracted volume is given by: $V_\infty = \frac{H_s \Delta h_i K(h_k) A}{D(h_k)} = H_s \Delta \theta A$ ($\Delta \theta$ is the change of the
 192 water content [-] and A is the cross-sectional area of the specimen [L^2]).

193 Without considering the outflow at very small t , Gardner provided a convenient relation by
 194 keeping only the first term of Fourier series:

$$195 \quad \ln(V_\infty - V(t)) = \ln\left(\frac{8V_\infty}{\pi^2}\right) - \left(\frac{\pi}{2H_s}\right)^2 D(h_k)t \quad (3)$$

196 Indeed, Gardner's experimental data showed that the changes in the first term with respect to
 197 time become linear after some time period (see Stanic et al., 2019), providing a reliable
 198 estimation of the diffusivity $D(h_k)$ from the slope of the $\ln(V_\infty - V)$ curve. The estimation is more
 199 accurate with small imposed suction increments, since $D(h_k)$ is the average diffusivity value
 200 along it. The hydraulic conductivity $K(h_k)$ at suction h_k is derived by using the water retention
 201 properties parameter $C(h_k)$.

202 When the hydraulic conductivity of the HAEV disk is significantly smaller than that of the
 203 specimen, the suction increment Δh_i imposed at the bottom of the porous disk is not immediately
 204 transferred to the specimen due to impedance effects. To cope with this issue, Kunze and

205 Kirkham (1962) proposed a graphical method based on the solution of Miller and Elrick (1958).
206 The solution is graphically presented through various curves showing the changes in $V(t)/V_\infty$ with
207 respect to the variable $\lambda_1^2 D(h_k)t/H_s^2$, in which parameter λ_1 is the first solution of the equation
208 $a\lambda_n = \cot(\lambda_n)$ (a is the ratio between the impedance of the ceramic disk and that of the sample).
209 The various curves correspond to various values of parameter a . By shifting the chosen
210 theoretical curve along the $\lambda_1^2 D(h_k)t/H_s^2$ axis, the best agreement with experimental data
211 (presented in the form $V(t) / V_\infty$ versus t) is obtained and a reference time t_{RP} is graphically
212 determined for $\lambda_1^2 D t / H_{soil}^2 = 1$. Kunze and Kirkham (1962) remarked that only a portion of the
213 experimental data corresponded to the theoretical curves, so they recommended to rather fit the
214 curves at small times, for which more accurate values of λ_1^2 are obtained. Finally, the diffusion
215 coefficient is calculated as $D(h_k) = H_s^2 / \lambda_1^2 t_{RP}$ and the hydraulic conductivity as $K(h_k) = D(h_k)$
216 $\Delta\theta/\Delta h_k$.
217 As commented in the Introduction, this graphical method is nowadays rarely used and has been
218 replaced by numerical back analysis of water outflow under imposed suction increments.

219 **A new method to account for impedance effects**

220 Due to the impedance effects resulting from the low permeability of the HAEV ceramic porous
221 disk, the suction increment Δh_i applied at the disk bottom at $t = 0$ is not instantaneously
222 transmitted at the top, where the initial suction is equal to the specimen suction h_k . As an
223 alternative to existing methods of accounting for impedance effects, it is proposed to first apply
224 Darcy's law to the saturated porous disk of thickness Δz_d , saturated permeability K_d and cross
225 sectional area A , similarly as in Eching et al. (1994). One obtains the following expression of the
226 drained outflow $Q(t)$ [L^3/T]:

$$227 \quad Q(t) = -K_d \frac{\Delta h_k(z=0,t) - \Delta h_i}{\Delta z_d} A = \frac{\Delta V(t)}{\Delta t} \quad (4)$$

228 where ΔV [L³] is the extracted water volume during the time interval Δt . The following relation
 229 gives the changes in the increment of suction at the specimen's bottom:

$$230 \quad \Delta h_k(z = 0, t) = \Delta h_i - \Delta z_d \frac{Q(t)}{AK_d} \quad (5)$$

231 This relation indicates that the change with respect to time of the suction applied at the specimen
 232 bottom can be derived from the monitoring of the drained outflow $Q(t)$, that depends on both the
 233 permeability of the porous disk and the combined effects of the water retention and transfer
 234 properties of the unsaturated specimen. Theoretically, the case with no impedance effect in
 235 which $\Delta h_k(z = 0, t) = \Delta h_i$ is met with porous disks of large permeability, when $K_d \gg Q(t)/A$.

236 Based on the time superposition principle (Hantush, 1964; Stanic et al., 2017 among others), it is
 237 hence proposed i) to decompose a suction increment at the specimen bottom $\Delta h_k(z = 0, t)$ as the
 238 sum of a number N_s of very small successive suction increments $\Delta h_m = \Delta h_i/N_s$, occurring at time
 239 t_m , ii) to apply the analytical solution (Eq. 1) to each suction increment and iii) to superpose in
 240 time all suction increments, giving the following expression of the suction changes:

$$241 \quad \Delta h_k(z, t) = \sum_{m=1}^{N_s} \Delta h_m \left(1 - \frac{4}{\pi} \sum_{n=1,3,5,\dots}^{\infty} \frac{1}{n} e^{-(n\pi/2)^2(t-t_m)D(h_k)/H_s^2} \sin \frac{n\pi z}{2H_s} \right) \quad (6)$$

242 resulting in the following expression of extracted volume, once integrated in z along the sample
 243 height:

$$244 \quad V(t) = \frac{V_{\infty}}{N_s} \sum_{m=1}^{N_s} \left(1 - \frac{8}{\pi^2} \sum_{n=1,3,5,\dots}^{\infty} \frac{1}{n^2} e^{-(n\pi/2)^2(t-t_m)D(h_k)/H_s^2} \right) \quad (7)$$

245 An application of this approach by using the device of *Figure 1* on the coarse substrate (Stanic et
 246 al. 2019) is given in *Figure 3*, in which the monitored changes in volume with respect to time
 247 during the application of a first suction step ($\Delta h_i = 0.185$ m) from the initial zero suction state are

248 presented. This suction increment resulted in a decrease in water content $\Delta\theta = 0.16$ from an
249 initial value at zero suction of 0.395.

250 *Figure 3a* indeed shows that, due to impedance effects, a delay of around 5 hours is needed
251 before suction at the specimen bottom $\Delta h_k(z = 0, t)$ reaches the imposed suction increment Δh_i .
252 Assuming only a single suction step ($N_s = 1$), $\Delta h_{m=1}$ is equal to Δh_i , thus Equation (7) becomes
253 identical to Gardner's method (Equation 2) – see *Figure 3b*. On the other hand, *Figure 3c*
254 illustrates the influence of non-single successive suction steps ($N_s = 3$, $\Delta h_m = \Delta h_i / 3$), where time
255 t_m are equal to the t values for which Equation (5) is identical to the sum of all previous
256 successive suction steps: $\Delta h_k(z = 0, t) = \sum_1^{m-1} \Delta h_m$ (*Figure 3d*). After determining t_m , the
257 calculation of $V(t)$ (Equation 7) can be made by using MATLAB. The correct value of diffusivity
258 is obtained the same way as with the standard Gardner's method, by fitting the theoretical results
259 with the experimental ones. From *Figure 3d*, it is obvious that, for the same diffusivity value
260 $D(h_k)$, Gardner's method significantly overestimates the measured $V(t)$ value, compared to the
261 method proposed in this study. However, it can be noticed that Equation (7) shows multiple
262 discontinuities at $t = t_m$ that are due to the additional suction steps adopted at those times. For
263 that reason, it is necessary to decompose $\Delta h_k(z=0, t)$ in very small suction steps that can secure a
264 reasonably continuous $V(t)$ function. Since the calculation method is not time consuming, it is
265 proposed to adopt $N_s = 1000$, a number large enough to satisfy continuity of $V(t)$ function for
266 various materials.

267 *Figure 4* presents a simplified scheme of the implementation of step 1 (constant imposed suction
268 increase), together with the experimental and calculated suction and volume changes with, and
269 without, impedance effects. In the top left graph are presented the changes in suction along the
270 sample's height at different times. Without any impedance effects (dotted lines), the boundary

271 suction condition at bottom is fixed and equal to Δh_i , and suction profiles are comparable to
272 typical excess pore pressure dissipation curves, as described in Terzaghi-Frölich's theory
273 (Equation 1) of consolidation of saturated soils (calculated with a fitted value $D(h_k) = 0.75 \times 10^{-7}$
274 m^2/s). In the case of impedance effects, the suction profiles (solid lines) are calculated using
275 Equation (6) with $N_s = 1000$, after fitting parameter $D(h_k)$ to a value of $1.2 \times 10^{-6} \text{ m}^2/\text{s}$. The
276 calculated changes in suction with time at specimen bottom show how the boundary conditions
277 progressively reach the Δh_i condition imposed at $t = 0$ at the bottom of the porous disk.

278 In the top right graph are presented the suction changes at specimen bottom ($\Delta h_k(z=0, t)$) with
279 respect to a logarithmic scale of time, to better observe the changes at small times when
280 impedance effects are the most significant. Connected black dots present $\Delta h_k(z=0, t)$, calculated
281 using measured volumes and Darcy's law (Equation 5), that gradually reaches Δh_i (dashed line)
282 imposed at the disk bottom. For decomposing calculated $\Delta h_k(z=0, t)$ curve, $N_s = 1000$ successive
283 suction steps are used. It can be noticed that ratio values $\Delta h_k(z=0, t) / \Delta h_i$ (x axis) for $z = 0$ at
284 different times (t_1 to t_4) correspond to ones in the middle graph (y axis) for the same t .

285 Finally, the bottom right graph presents a comparison of the calculated values of $V(t)/V_\infty$ (in a
286 time logarithmic scale) using Gardner's method, Kunze and Kirkham's method and that
287 developed in this work (Kunze and Kirkham's non-dimensional time variable $\lambda_1^2 D(h_k) t_{RP} / H_s^2$ is
288 also reported on the top x-axis of the graph). Fitting our experimental data following Kunze and
289 Kirkham's method provided $\lambda_1 = 0.097$ and $t_{RP} = 2750 \text{ s}$, with $a = 10$ (a is ratio between the disk
290 and the specimen permeability). If one follows the recommendation of the authors to fit only a
291 portion of measurements at small times with theoretical curves, the results could change
292 significantly. In case of step 1, the theoretical curves with much smaller parameter a ($a = 0.2$ or
293 0.142) provide the best agreement with measured volumes at small times, which leads to lower

294 values of $K(h_k)$. However, overall agreement is less satisfactory than for the adopted case with a
 295 $= 10$. On the contrary, adopted theoretical curve $a = 10$ and curve $a = 1000$ are rather similar,
 296 thus it is difficult to distinguish the difference between both. Since $a = 1000$ provides two orders
 297 of magnitude higher value of hydraulic conductivity (even higher than the saturated hydraulic
 298 conductivity) than $a = 10$, a value of $a = 10$ is finally adopted. The Figure shows excellent
 299 agreement between experimental data and both Kunze and Kirkham and the proposed method.
 300 Unsurprisingly, the extracted volume estimated by Gardner's method for times smaller than $1 h$
 301 is higher than the measured one and that calculated with two other methods.

302 Given that the calculation of the Fourier series of Equations (1), (2), (6) and (7) may be found
 303 somewhat tedious, one tested the approximated empirical formula proposed by Sivaram and
 304 Swamee (1977) in their simplified approach to solve Terzaghi - Fröhlich's consolidation
 305 equation, as follows:

$$306 \frac{V(t)}{V_\infty} = \left(\frac{4tD(h_k)}{\pi H_s^2} \right)^{0.5} \left(1 + \left(\frac{4tD(h_k)}{\pi H_s^2} \right)^{2.8} \right)^{-0.179} \quad (8)$$

307 Equation (8) can be substituted in all equations where Fourier series appear, changing Equation
 308 (7) to the following:

$$309 V(t) = \frac{V_\infty}{\Delta h_i} \left[\sum_{m=0}^{N_s} \Delta h_m - \sum_{m=0}^{N_s} \Delta h_m \left(1 - \left(\frac{4(t-t_m)D(h_k)}{\pi H_s^2} \right)^{0.5} \left(1 + \left(\frac{4(t-t_m)D(h_k)}{\pi H_s^2} \right)^{2.8} \right)^{-0.179} \right) \right] \quad (9)$$

310 The corresponding curve, also plotted in *Figure 4*, shows excellent comparability between this
 311 expression (9) and the calculation of Equation (7). For sake of simplicity, it is hence proposed to
 312 adopt expression (9).

313 **A new method to account for non-constant imposed suction**
314 **increment**

315 As described in *Figure 5*, the overflow system used in Stanic et al. (2019) (*Figure 1a*), that
316 imposes a constant suction, is used to measure larger water extracted volume thanks to the larger
317 diameter of the outer tube, whereas good precision is achieved for smaller extracted volumes by
318 using the smaller diameter inner tube. In such conditions, the suction increment imposed at $t = 0$
319 by moving the mobile device downwards is affected by a subsequent progressive increase in
320 water level in the tube when water is extracted from the specimen. In the test program carried out
321 on the volcanic substrate (see Stanic et al. 2019), large extracted volumes of water were observed
322 during the two first suction steps applied from the zero-suction initial state ($\Delta h_i = 0.185$ and
323 0.212 m, respectively). Starting from step 3 (initial suction 0.397 m and $\Delta h_i = 0.128$ m), it was
324 observed that *i*) extracted water volumes were too small to be measured by the outflow system
325 and *ii*) the unsaturated hydraulic conductivity of the unsaturated substrate was one order of
326 magnitude smaller than that of the ceramic porous disk ($K_d = 4.02 \times 10^{-8}$ m/s). In this context, it
327 was necessary to examine how to determine the hydraulic conductivity with a non-constant
328 suction imposed condition.

329 The progressive increase in water level causes a gradual decrease in suction $\Delta h_k(z=0, t)$ imposed
330 at the specimen bottom. Since the increase in water level is caused by the outflow drained from
331 the specimen, the water balance equation can be written in the following way:

$$332 \quad -\frac{d\Delta h_k(z=0,t)}{dt} a_{it} = Q(t) = \frac{dV(t)}{dt} \quad (10)$$

333 where a_{it} is the cross-section area [L^2] of the small inner tube in which outflow is collected.

334 Since there is no impedance effect, $V(t)$ can be substituted with Gardner's solution (Equation 2),

335 by substituting V_∞ by $\frac{H_s \Delta h_k(z=0,t) K(h_k) A}{D(h_k)}$, thus replacing the constant Δh_i by the non-constant

336 $\Delta h_k(z=0, t)$. The outflow $Q(t)$ then becomes equal to:

$$337 \quad Q(t) = \frac{dV(t)}{dt} = \frac{d\Delta h_k(z=0,t)}{dt} \frac{H_s K(h_k) A}{D(h_k)} F(t) + \frac{H_s \Delta h_k(z=0,t) K(h_k) A}{D(h_k)} F'(t) \quad (11)$$

338 where $F(t) = 1 - \frac{8}{\pi^2} \sum_{n=1,3,5,\dots}^{\infty} \frac{1}{n^2} e^{-(n\pi/2)^2 t D(h_k)/H_s^2}$ and $F'(t) = \frac{dF}{dt}$.

339 After introducing Equation (11) into Equation (10), the variables can be separated, leading to:

$$340 \quad - \int_{\Delta h_i}^{\Delta h_k(z=0,t)} \frac{d\Delta h_k(z=0,t)}{\Delta h_k(z=0,t)} = \int_0^t \frac{F'(t) \frac{H_s K(h_k) A}{D(h_k)}}{a_{it} + F(t) \frac{H_s K(h_k) A}{D(h_k)}} dt \quad (12)$$

341 After integrating both sides of Equation (12), the following obtains:

$$342 \quad \ln\left(\frac{\Delta h_i}{\Delta h_k(z=0,t)}\right) = \ln\left(1 + F(t) \frac{H_s K(h_k) A}{a_{it} D(h_k)}\right) \quad (13)$$

343 The expression of $\Delta h_k(z=0, t)$ is then derived as follows:

$$344 \quad \Delta h_k(z=0, t) = \frac{\Delta h_i}{1 + F(t) \frac{H_s K(h_k) A}{a_{it} D(h_k)}} \quad (14)$$

345 By knowing that $V(t) = a_{it}(\Delta h_i - \Delta h_k(z=0, t))$, and $V(t_\infty) = V_\infty$, the following equation can

346 be written:

$$347 \quad V_\infty = a_{it}(\Delta h_i - \Delta h_k(z=0, t_\infty)) = \frac{H_s \Delta h_k(z=0, t_\infty) K(h_k) A}{D(h_k)} \quad (15)$$

$$348 \quad \frac{H_s K(h_k) A}{a_{it} D(h_k)} = \frac{\Delta h_i}{\Delta h_k(z=0, t_\infty)} - 1 \quad (16)$$

349 After introducing the last expression into Equation (14), the final forms of $\Delta h_k(z=0, t)$ and $V(t)$

350 are obtained:

$$351 \quad \Delta h_k(z=0, t) = \frac{\Delta h_i}{1 + F(t) \left(\frac{\Delta h_i}{\Delta h_k(z=0, t_\infty)} - 1 \right)} \quad (17)$$

$$V(t) = a_{it} \Delta h_i \left(1 - \frac{1}{1 + F(t) \left(\frac{\Delta h_i}{\Delta h_k(z=0, t_\infty)} - 1 \right)} \right) \quad (18)$$

For $t = 0$, $F(t) = 0$, so $\Delta h_k(z=0, t=0) = \Delta h_i$ and $V(t) = 0$. On the contrary, for $t = t_\infty$, $F(t)=1$, leading to $\Delta h_k(z=0, t=t_\infty)$ and $V(t) = a_{it}(\Delta h_i - \Delta h_k(z = 0, t_\infty)) = V_\infty$. Please note that Fourier series $F(t)$ is identical as in Equation (2), thus it can be substituted using the empirical expression (8), as previously explained, and introduced into Equation (18) for sake of simplicity.

To calculate suction profiles, the non-constant boundary condition (Equation 17) is decomposed as in the case of the impedance effect, and Equation (6) is applied afterwards. *Figure 5* illustrates a simplified scheme of the implementation of steps 4 (a) and 11 (b) (non-constant imposed suction), together with the measured and calculated suction and volume changes when considering constant and non-constant imposed suction increments. It is indicated in the Figure that the initial suctions for steps 4 and 11 are 0.489 m and 3.227 m, respectively, while the imposed suction increments are 0.321 m and 0.822 m, with 17 % and 5 % of suction step change during the test, respectively. The top graphs present the calculated suction profiles at different times for 2 cases: i) constant suction step $\Delta h_i = \Delta h_k(z=0, t_\infty)$ described using Equation (1) and ii) non-constant suction increment $\Delta h_i = \Delta h_k(z=0, t)$ described with Equation (6). In step 4 (*Figure 5a*) the boundary condition $\Delta h_k(z=0, t)$ changes between Δh_i at $t = 0$ and $\Delta h_k(z=0, t_\infty) = 0.83\Delta h_i$ at t_∞ (solid lines), while it remains fixed at value $0.83\Delta h_i$ in the case of constant suction step. Note that suction change is less significant in step 11 (5 %) and suction profiles for two different boundary conditions are rather similar (see *Figure 5b*).

In the middle graph of *Figure 5a*, calculated changes in $\Delta h_k(z=0, t)$ (Equation 17 - solid line) are compared with measured changes in water level, while calculated (Equation 18) and measured drained volumes are compared in the bottom graph. The difference between the non-constant

374 $(\Delta h_k(z=0, t))$ and constant $(\Delta h_k(z=0, t_\infty))$ suction increment is more significant at initial time,
375 right after imposing Δh_i , while the largest difference in drained volumes between our method and
376 Gardner's method is observed after $t_2 = 25$ min. Method proposed in this work shows the best
377 agreement for $D(h_k) = 4.3 \times 10^{-8}$ m²/s (the same value is adopted for Gardner's method), while
378 Kunze & Kirkham's theoretical curve with parameters $a = 0$, $t_{RP} = 4400$ s and $\lambda_I^2 = 2.467$ also
379 shows satisfying agreement at small times.

380 All three methods show almost identical agreement with measured volumes when the overall
381 suction step change is negligible, like in step 11 (bottom graph in *Figure 5b*). Moreover, the top
382 graph in *Figure 5b* shows rather similar suction profiles for the cases with constant and non-
383 constant suction increments.

384 **Determination of hydraulic conductivity values**

385 **Green Wave substrate (Stanic et al., 2019)**

386 By analyzing the evolution of drained outflow for different suction steps, the change of hydraulic
387 conductivity with respect to increased suction is obtained. *Figure 6* shows the changes in
388 hydraulic conductivity obtained by using the three different approaches: Gardner's method
389 (triangles), Kunze & Kirkham's method (squares) and the methods proposed in this work
390 (circles). Hydraulic conductivity values are presented in logarithmic scale. All 3 methods are
391 applied on steps 1, 2, 3, 4, 8, 11 and 12, for which stable and reliable volume change
392 measurements are obtained at small times. Note that we also present in the Figure the hydraulic
393 conductivity values for steps 5, 6, 7, 9 10 and 13, that were obtained by using standard Gardner's
394 method, based on volume change measurements at larger times (Equation 3).

395 Steps 1 and 2 were constant suction steps (with the overflow system of *Figure 1a*) whereas the
396 remaining steps correspond to non-constant suction increments (see *Figure 1b*). The saturated
397 hydraulic conductivities of both the specimen (K_s) and the ceramic disk (K_d) were determined
398 using a constant head permeability test described in details in Stanic et al. (2019).

399 *Figure 6* shows that both our method and Kunze & Kirkham's one provide very similar results
400 for the first two steps where significant impedance effect occurs. In this range, Gardner's method
401 unsurprisingly provides significantly lower $K(h_k)$ values because it integrates the effect of the
402 low hydraulic conductivity of the disk. In case of steps 8, 11 and 12, where the imposed suction
403 step changes less than 5 % where no impedance effect occurs, all methods provide comparable
404 results.

405 From a hydrological point of view with respect to the functioning of the Green Wave made up of
406 the volcanic material investigated here, the values of $K(h_k)$ in the low suction regime present the
407 greatest interest, since they have the most significant influence on the hydrological responses of
408 the substrate. As shown in *Figure 6*, this zone (first 4 steps) is precisely that in which the most
409 significant differences are observed between the methods used, showing the advantage of our
410 method, that is less operator dependent compare to that of Kunze and Kirkham.

411 **Poorly graded sand and silty clay (Wayllace and Lu, 2011)**

412 Among the transient outflow data from Wayllace and Lu (2011), only the first and smaller of the
413 two applied suction steps was considered on both specimens because i) our method assumes
414 constant diffusivity, a hypothesis only acceptable for small suction increments and ii) the
415 impedance effect is more significant at initial steps, when the permeability of the soil is
416 significantly larger than that of the ceramic disk.

417 In Figure 7a-top is presented the change of $\Delta h_k(z=0, t)$ for the poorly graded sand specimen ($H_s =$
418 2.67×10^{-2} m) resulting from imposing $\Delta h_i = 0.3$ m. Figure 7a-bottom presents the corresponding
419 change in $V(t)$ (circles) drained from the specimen ($V_\infty = 4.66 \times 10^{-6}$ m³). The method proposed
420 in this work (Equations 7 and 9 – solid and dashed lines), Gardner’s (Equation 2 – dotted line)
421 and Kunze and Kirkham’s method (dash-dot line) are compared to measured outflows. The same
422 data are presented in Figure 7b for the silty clay specimen ($H_s = 2.41 \times 10^{-2}$ m), for which $\Delta h_i =$
423 0.5 m and the total drained volume $V_\infty = 1 \times 10^{-6}$ m³.

424 The bottom graphs in Figure 7a show that our method and Kunze & Kirkham’s method compare
425 quite well whereas Gardner’s method overestimates the outflow values at small times, like for the
426 Green Wave substrate (Figure 4). On the contrary, in case of the silt clay specimen (Figure 7b-
427 bottom) both Gardner’s and Kunze & Kirkham’s methods overestimate the outflows at small
428 times, whereas our method shows excellent agreement with measurements along the whole time
429 range. Due to the poor agreement at small times, Kunze & Kirkham’s analytical curve was fitted
430 with measurements at larger times (the parameters for this method are indicated in Figure 7 and
431 in Table 1).

432 Based on the adjusted $D(h_k)$ values in the case of Gardner’s and of our method, and parameters $\alpha,$
433 t_{RP} and λ_I^2 in case of Kunze & Kirkham’s method (Table 1), the values of the hydraulic
434 conductivity for the first step were determined. In case of poorly graded sand, the following
435 values were obtained: $K(h_k = 0.3 \text{ m}) = 2.01 \times 10^{-9}$ m/s (Gardner), 2.81×10^{-9} m/s (our method) and
436 4.58×10^{-9} m/s (Kunze & Kirkham). For the silty clay: $K(h_k = 0.5 \text{ m}) = 2.29 \times 10^{-9}$ m/s (Gardner),
437 4.01×10^{-9} m/s (our method) and 6.37×10^{-9} m/s (Kunze & Kirkham). Based on the data from our
438 method and Kunze & Kirkham’s method, it can be concluded that the impedance effect does
439 occur (we have $K(h_k) > K_d$ for both methods and both soils), but it is not significant, since the

440 obtained $K(h_k)$ values are the same order of magnitude as K_d ($\sim 10^{-9}$ m/s). Unsurprisingly, in the
441 case of Gardner's method, $K(h_k)$ is slightly lower than K_d for both soils.

442 **On the occurrence of impedance effects**

443 The occurrence of impedance effects can clearly be observed in Figure 5 during steps 1 to 3, by
444 comparing the data of Gardner's method with the two other ones accounting for impedance
445 effects. Unsurprisingly, the apparent HC derived from Gardner's method is significantly smaller
446 than other estimations at low suctions due to the underestimation resulting from the low
447 permeability ceramic disk. However, this difference decreases quite rapidly, since a convergence
448 of the three methods is observed at a HC of 2×10^{-8} m/s, to compare to the twice larger HC value
449 of the ceramic disk (4.02×10^{-8} m/s).

450 The most convenient way to clarify the importance of impedance effects is by analysing the
451 evolution of the ratio $\Delta h_k(z=0, t) / \Delta h_i$, calculated by using Equation (5). The faster the ratio gets
452 close to 1, the less significant impedance effects are, and vice versa. It seems reasonable in this
453 regard to define a criterion based on the relative time t / t_∞ (t_∞ is the time at which equilibrium is
454 reached) at which $\Delta h_k(z=0, t) / \Delta h_i$ gets close enough to 1 (ex. 0.95). Based on experience, we
455 believe that impedance can be ignored if $\Delta h_k(z=0, t) / \Delta h_i$ reaches 0.95 within the first 5 % of the
456 step duration, leading to a criterion $t_c / t_\infty = 0.05$. After dividing both sides of Equation (5) by Δh_i
457 and introducing the proposed criterion, the following is obtained:

$$458 \frac{V(t_c)}{t_c A} < 0.05 \frac{\Delta h_i}{\Delta z_d} K_d, \quad t_c = 0.05 t_\infty \quad (19)$$

459 Equation (19) shows that besides the specimen permeability K_d , the values of imposed suction
460 increment Δh_i and stone thickness Δz_d also affect the impedance. For the data presented in Figure
461 4 (coarse material), Figure 7a (sand) and Figure 7b (silty clay), the values of the left side of
462 Equation (19) are 1.2×10^{-6} , 6.8×10^{-8} and 9.6×10^{-8} m/s, respectively, while the values on the

463 right side are 1.5×10^{-7} , 1.17×10^{-8} and 1.95×10^{-8} m/s. Equation (19) is hence not satisfied in
464 none of the three cases, meaning that impedance effects cannot be neglected. In case of step 2 of
465 the coarse substrate, the left and right side of Equation (19) are almost identical, which is in
466 agreement with the obtained $K(h_k)$ value that is rather close to K_d (see *Figure 6*).

467 **Conclusion**

468 As initially shown by Gardner (1956), a convenient way to measure the hydraulic conductivity of
469 unsaturated media can be derived from monitoring the water outflow of an unsaturated specimen
470 submitted to a suction step. The method has been improved by Kunze and Kirkham (1962) to
471 account for the impedance effects due to the low (saturated) hydraulic conductivity of the
472 ceramic disks used in pressure plate devices. However, the graphical method that they proposed
473 at that time is no longer used nowadays, because numerical back analysis of water transfers in
474 unsaturated specimens submitted to suction step proved to be more relevant, accurate and easy to
475 use.

476 In this context, two improvements to Gardner's method were proposed in this paper i) to account
477 for impedance effect in a simpler and more objective way than in Kunze and Kirkham's
478 graphical method and ii) to account for conditions in which non-constant suction increment is
479 applied, as is often the case in hanging column techniques (e.g. Stanic et al. 2019).

480 The experimental data from various kinds of materials analysed (coarse substrate, poorly graded
481 sand and undisturbed silty clay) in this work showed that the proposed simple analytical method
482 fairly well accounts for the impedance effects of the ceramic disk. This method is considered as
483 more reliable than Kunze & Kirkham's graphical method, especially in the case of significant
484 impedance effect, because it is not dependent of the difficulty in choosing the best fitting

485 theoretical curve, among the family of curves provided by Kunze & Kirkham. The proposed
486 method, based on the analytical resolution of the water transfer equations in the different parts of
487 the system, only requires the accurate monitoring of outflow measurements, a requirement that is
488 typical for any method for determining the hydraulic conductivity of multiphase porous material.
489 The boundary condition in which a non-constant suction increment is applied, which is often the
490 case when using the hanging column technique, was also treated analytically to be applied in the
491 (larger) suction area in which no impedance effect has to be considered, with also good
492 agreement between measured and calculated values. It has also been shown, that the simplified
493 equation of Sivaram and Swamee (1977) could successfully replace the analytical solution in
494 Fourier series, which simplifies the use and improves the efficiency of the method. Compared to
495 numerical back analyses method, this method is considered simpler in the sense that it does not
496 require the use of any numerical simulations and back analysis with optimization algorithms to
497 determine the relevant parameters, since the analysis of outflow data and the derivation of
498 hydraulic conductivity value is much more straightforward.

499

500 **Acknowledgments:**

501 The authors greatly acknowledge the Inter-laboratory PhD Merit Scholarship, provided by Ecole
502 des Ponts ParisTech to the first author, which made this collaborative work possible. A partial
503 financial support by the Chair “Hydrology for resilient city” endowed by Veolia is also highly
504 acknowledged. Authors provided supporting information.

506 **References:**

507 Brooks, R.H., A. T. Corey. (1964). Hydraulic properties of porous media. *Hydrology papers*, no.
508 3, Colorado State University, Fort Collins.

509 Doering, E. J. (1965). Soil-water diffusivity by the one-step method. *Soil Science*, 99, 322-326.

510 Duan, Q., Sorooshian, S., Gupta, V. (1992). Effective and Efficient Global Optimization for
511 Conceptual Rainfall-Runoff Models. *Water Resour. Res.*, 28(4), 1015-1031.
512 DOI:10.1029/91WR02985.

513 Durner, W., and Iden, S. C. (2011). Extended multistep outflow method for the accurate
514 determination of soil hydraulic properties near water saturation. *Water Resour. Res.*, 47,
515 DOI:10.1029/2011WR010632.

516 Eching, S. O. and Hopmans J. W. (1993). Optimization of Hydraulic Functions from Transient
517 Outflow and Soil Water Pressure Data. *Soil Sci. Soc. Am. J.*, 57, 1167-1175.

518 Eching, S. O., Hopmans J. W., & Wendroth O. (1994). Unsaturated Hydraulic Conductivity from
519 Transient Multistep Outflow and Soil Water Pressure Data. *Soil Sci. Soc. Am. J.*, 58, 687-695.

520 Fredlund, D. G. and Xing, A. (1994). Equations for the soil characteristic curve. *Can. Geotech.*
521 *J.*, 31, 521-532.

522 Gardner, W. R. (1956). Calculation of Capillary Conductivity from Pressure Plate Outflow Data.
523 *Soil Science Society Proceeding*, 20, 317 - 320.

524 Hantush, M. S. (1964), Hydraulics of Wells. In *Advances in Hydroscience* (ISSN: 0065-2768,
525 Vol. 1, pp. 281-432). Socorro, New Mexico: New Mexico Institute of Mining and Technology.

526 Khaleel, R., and Relyea, J. F. (1995). Evaluation of van Genuchten-Mualem relationships to
527 estimate unsaturated hydraulic conductivity at low water contents. *Water Resour. Res.*, 31(11),
528 2659-2668.

529 Kunze, R. J., & Kirkham, D. (1962). Simplified Accounting for membrane impedance in
530 Capillary Conductivity Determinations. *Soil Sci. Soc. Am. Proc.*, 26, 421-426.

531 Miller, E., & Elrick, D. (1958). Dynamic determination of capillary conductivity extended for
532 non-negligible membrane impedance. *Soil Sci. Soc. Am. Proc.*, 22, 483-486.

533 Mualem, Y. (1976). A New Model for Predicting the Hydraulic Conductivity of Unsaturated
534 Porous Media. *Water Resources Research*, 12(3), 513-522, DOI:10.1029/WR012i003p00513.

535 Nasta, P., Huynh, S., Hopmans, J. W. (2011). Simplified Multistep Outflow Method to Estimate
536 Unsaturated Hydraulic Function for Coarse Textured Soils. *Soil Sci. Soc. Am. J.*, 75, 418-425.

537 Pachepsky, Y., and van Genuchten, M. Th. (2011). Pedotransfer Functions. In Glinski, J.,
538 Horabik, J., Lipiec, J. (Eds.), *Image Analysis in Agrophysics* (pp. 556-561). Springer. DOI:
539 10.1007/978-90-481-3585-1_109.

540 Peters, A., Durner, W., Wessolek, G. (2011). Consistent parameter constraints for soil hydraulic
541 functions. *Advances in Water Resources*, 34, 1352-1365, DOI:10.1016/j.advwatres.2011.07.006.

542 Richards, L. A. (1931). Capillary conduction of liquids through porous media. *Physics*, 1, 318-
543 333.

544 Rijtema, P. E. (1959). Calculation of capillary conductivity from pressure plate outflow data with
545 non-negligible membrane impedance. *Netherlands Journal of Agricultural Science*, 7(3), 209-
546 215.

547 Schaap M. G., and Leij F. J. (2000). Improved prediction of unsaturated hydraulic conductivity

548 with the Mualem–van Genuchten model. *Soil Sci. Soc. Am. J.*, 64:843–51.

549 Schelle, H., Iden, S. C., Durner, W. (2011). Combined Transient Method for Determining Soil
550 Hydraulic Properties in a Wide Pressure Head Range. *Soil Sci. Soc. Am. J.*, 75, 1681-1693.

551 Sivaram, B., & Swamee, P. (1977). A Computational Method for Consolidation Coefficient.
552 *Soils Found. Tokyo*, 17(2), 48–52.

553 Stanić, F., Jaćimović, N., Ranđelović, A., & Despotović, J. (2017). Laboratory investigation of
554 hydraulic characteristics of fly ash as a fill material from the aspects of pollutant transport. *Water
555 Science and Technology*, 76(4), 976–982.

556 Stanić, F., Cui. Y.-J., Delage, P., De Laure, E., Versini, P.-A., Schertzer, D., & Tchiguirinskaia,
557 I. (2019). A device for the simultaneous determination of the water retention properties and the
558 hydraulic conductivity function of an unsaturated coarse material; application to a green-roof
559 volcanic substrate. *Geotechnical Testing Journal*, DOI: 10.1520/GTJ20170443.

560 Stovin, V., Poë, S., De-Ville, S., & Berretta, C. (2015). The influence of substrate and vegetation
561 configuration on green roof hydrological performance. *Ecological Engineering*, 85, 159-172.

562 Šimunek, J., van Genuchten, M. Th., Šejna, M. (2008). Development and Applications of the
563 HYDRUS and STANMOD Software Packages and Related Codes. *Vadose Zone Journal*, 7, 587-
564 600, DOI:10.2136/vzj2007.0077

565 Terzaghi, K., & Fröhlich, O. K. (1936). *Theorie der Setzung von Tonschichten*. Wien, Franz
566 Deuticke: Leipzig.

567 Valiantzas, J. D. (1989). A Simple Approximate Equation to Calculate Diffusivities from One-
568 Step Outflow Experiments. *Soil Sci. Soc. Am. J.*, 53, 342–349.

569 Valiantzas, J. D. (1990). Analysis of Outflow Experiments Subject to Significant Plate
570 Impedance. *Water Resources Research*, 26(12), 2921–2929.

571 van Dam, J. C., Stricker, J. N. M., Droogers, P. (1994). Inverse Method to Determine Soil
572 Hydraulic Functions from Multistep Outflow Experiments. *Soil Sci. Soc. Am. J.*, 58, 647-652.

573 van Genuchten, M. Th. (1980). A Closed-form Equation for Predicting the Hydraulic
574 Conductivity of Unsaturated Soils. *Soil Sci. Soc. Am. J.*, 44, 892-898.

575 Versini, P.A., Gires, A., Fitton, G., Tchiguirinskaia, I., & Schertzer, D. (2018). Toward an
576 assessment of the hydrological components variability in green infrastructures: Pilot site of the
577 Green Wave (Champs-sur-Marne). *La Houille Blanche*, 4, 34-42

578 Vogel, T., van Genuchten, M. Th., & Cislérova, M. (2001). Effect of the shape of the soil
579 hydraulic functions near saturation on variably-saturated flow predictions. *Advances in Water*
580 *Resources*, 24, 133-144.

581 Wayllace, A. and Lu, N. (2011). A transient Water Release and Imbibitions Method for Rapidly
582 Measuring Wetting and Drying Soil Water Retention and Hydraulic Conductivity Functions.
583 *Geotechnical Testing Journal*, 35(1), 1-15.

584 Yates, S. R., van Genuchten, M. Th., Warrick, A. W., Leij, F. J. (1992). Analysis of measured,
585 predicted, and estimated hydraulic conductivity using the RETC computer program. *Soil Sci.*
586 *Soc. Am. J.* 56, 347–354, DOI:10.2136/sssaj1992.03615995005600020003x.

587

588 **List of Tables:**

589 *Table 1. Parameters used and permeability values obtained for Gardner’s method, our method*
590 *and Kunze & Kirkham’s method for the poorly graded sand and the undisturbed silt clay*
591 *investigated in Wayllace and Lu (2011)*

592
593 **List of Figures:**

594 *Figure 1. Experimental setup that secures: a) constant imposed suction increment (overflow*
595 *system); b) non-constant imposed suction increment (After Stanic et al. 2019)*

596 *Figure 2. Experimentally determined WRC of the coarse substrate*

597 *Figure 3. Simulated evolution of drained volumes (b, d, f) using calculated $\Delta h_k (z = 0, t)$ curve*
598 *decomposed with $N_s = 1(a), 3(c)$ and $500(e)$ successive suction increments, respectively.*
599 *Data from coarse substrate.*

600 *Figure 4. Detailed scheme of implementation of step 1 using the overflow method (constant*
601 *imposed suction step). Data from coarse substrate.*

602 *Figure 5. Detailed scheme of implementation of steps 4 (a) and 11 (b) when imposing non-*
603 *constant suction increment. Data from coarse substrate.*

604 *Figure 6. Change of hydraulic conductivity of the coarse substrate with respect to increased*
605 *suction obtained using 3 different methods: Kunze & Kirkham’s method (squares),*
606 *Gardner’s method (triangles) and methods developed in this work (circles). Hydraulic*
607 *conductivity values obtained by analyzing volume change measurements at larger times*
608 *(Equation 3) are presented with blue symbols*

609 *Figure 7. (a) Poorly graded sand (data from Wayllace and Lu 2011); top - Suction change at*
610 *specimen bottom, at contact with ceramic disk, bottom – measured outflow (circles)*
611 *compared with calculated values from different methods (indicated on the figure);*
612

613

614

615

616

617

618

619

620

621

622 *Table 1. Parameters used and permeability values obtained for Gardner's method, our method*
 623 *and Kunze & Kirkham's method for the poorly graded sand and the undisturbed silt clay*
 624 *investigated in Wayllace and Lu (2011)*

	<i>Gardner</i>		<i>This Work</i>		<i>Kunze & Kirkham</i>			
	D [m ² /s]	K [m/s]	D [m ² /s]	K [m/s]	a [-]	t_{RP} [s]	λ_i^2 [-]	K [m/s]
Poorly graded sand	1x10 ⁻⁸	2.01x10 ⁻⁹	1.4x10 ⁻⁸	2.81x10 ⁻⁹	0.389	23700	1.3228	4.58x10 ⁻⁹
Undisturbed silty clay	8x10 ⁻⁸	2.29x10 ⁻⁹	1.4x10 ⁻⁷	4.01x10 ⁻⁹	0.5	2300	1.1596	6.37x10 ⁻⁹

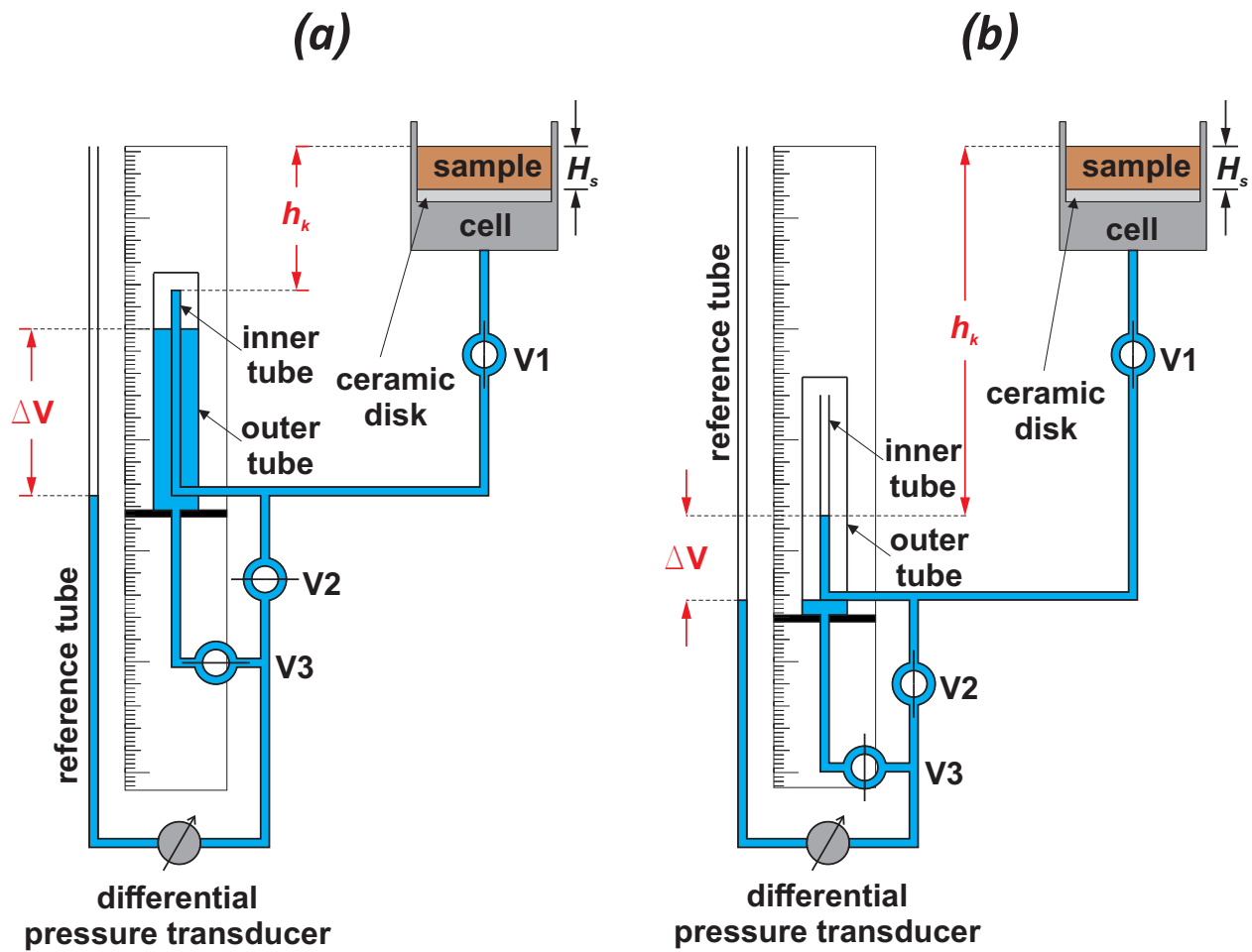

625

626

627

Figure 1. Experimental setup that secures: a) constant imposed suction increment (overflow system); b) non-constant imposed suction increment (After Stanic et al. 2019)

628

629

630

631

632

633

634

635

636

637

638

639

640

641

642

643

644

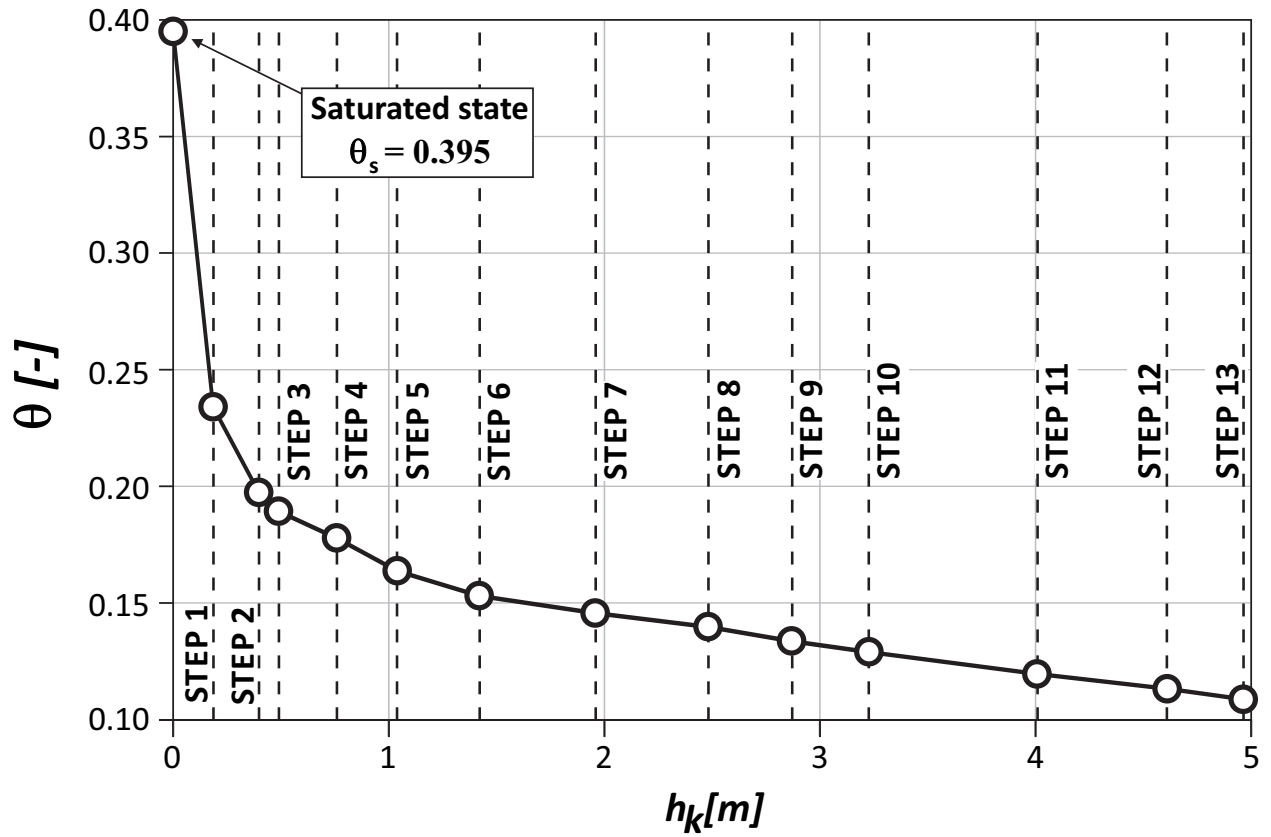

645

646 *Figure 2. Experimentally determined WRC of the coarse substrate (After Stanic et al., 2019)*

647

648

649

650

651

652

653

654

655

656

657

658

659

660

661

662

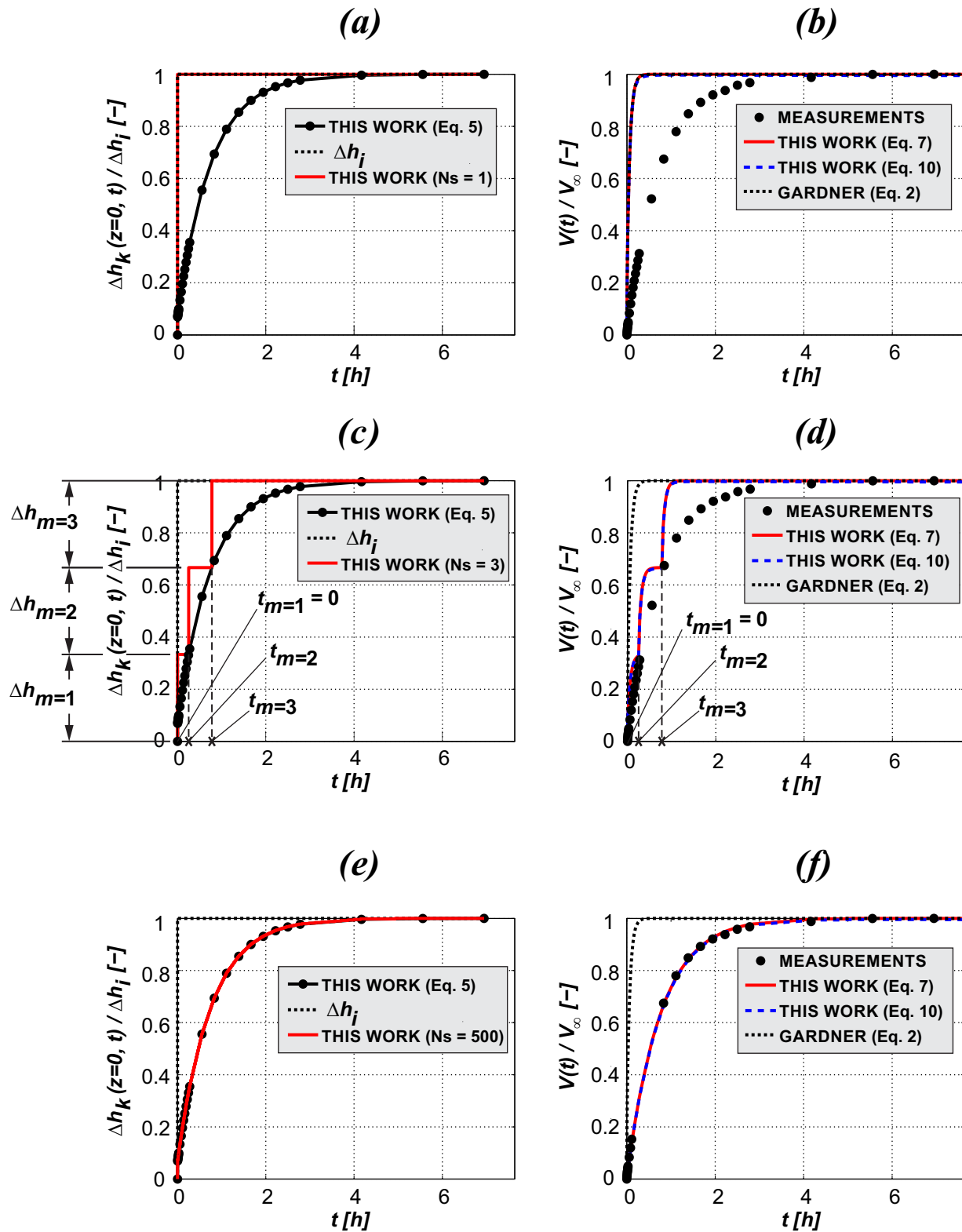

663

664 *Figure 3. Simulated evolution of drained volumes (b, d, f) using calculated $\Delta h_k(z = 0, t)$ curve*
 665 *decomposed with $N_s = 1(a), 3(c)$ and $500(e)$ successive suction increments, respectively. Data*
 666 *from coarse substrate.*

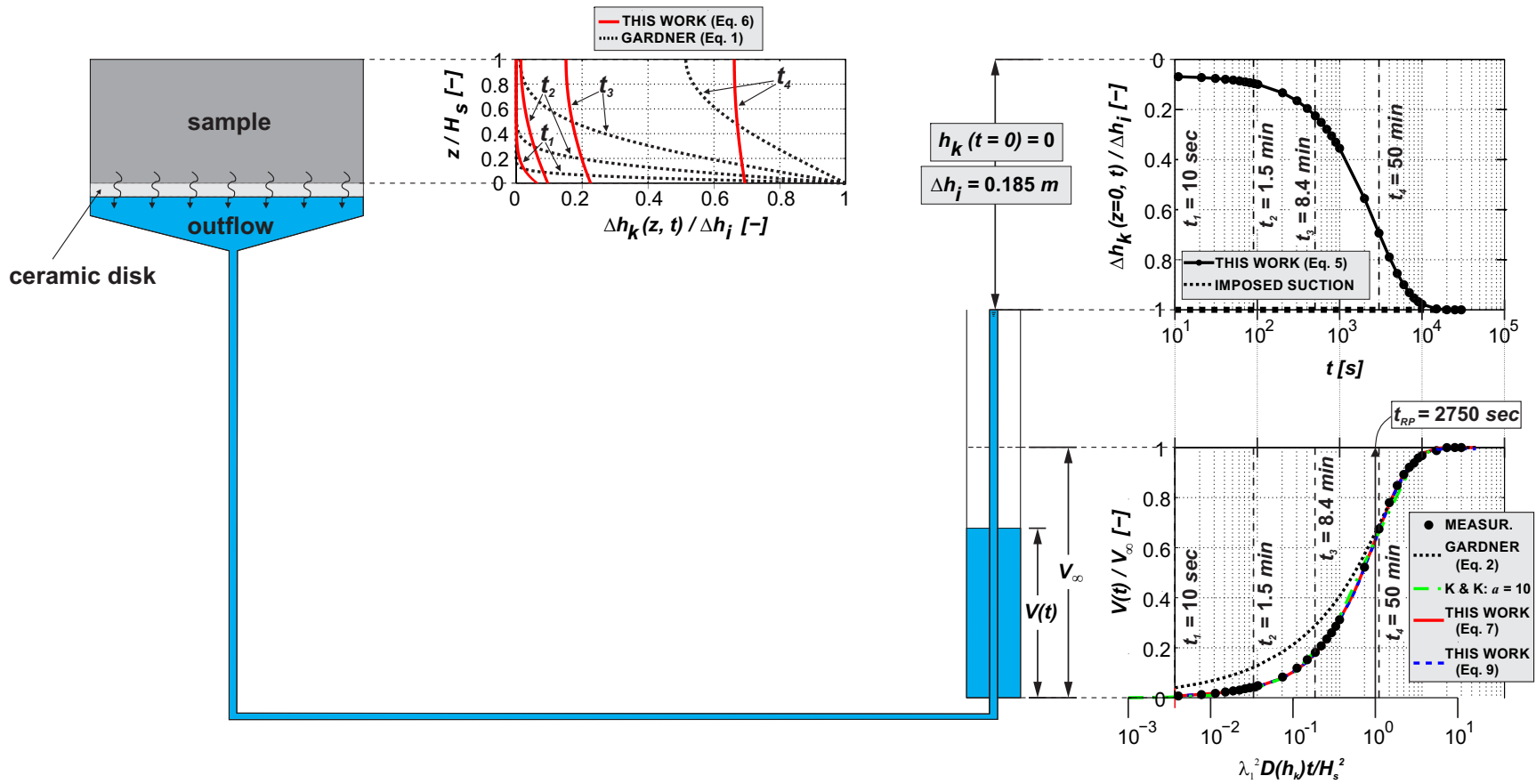

667

668 Figure 4. Detailed scheme of implementation of step 1 using the overflow method (constant imposed suction step). Data from coarse
 669 substrate.

670

671

672

673

674

675

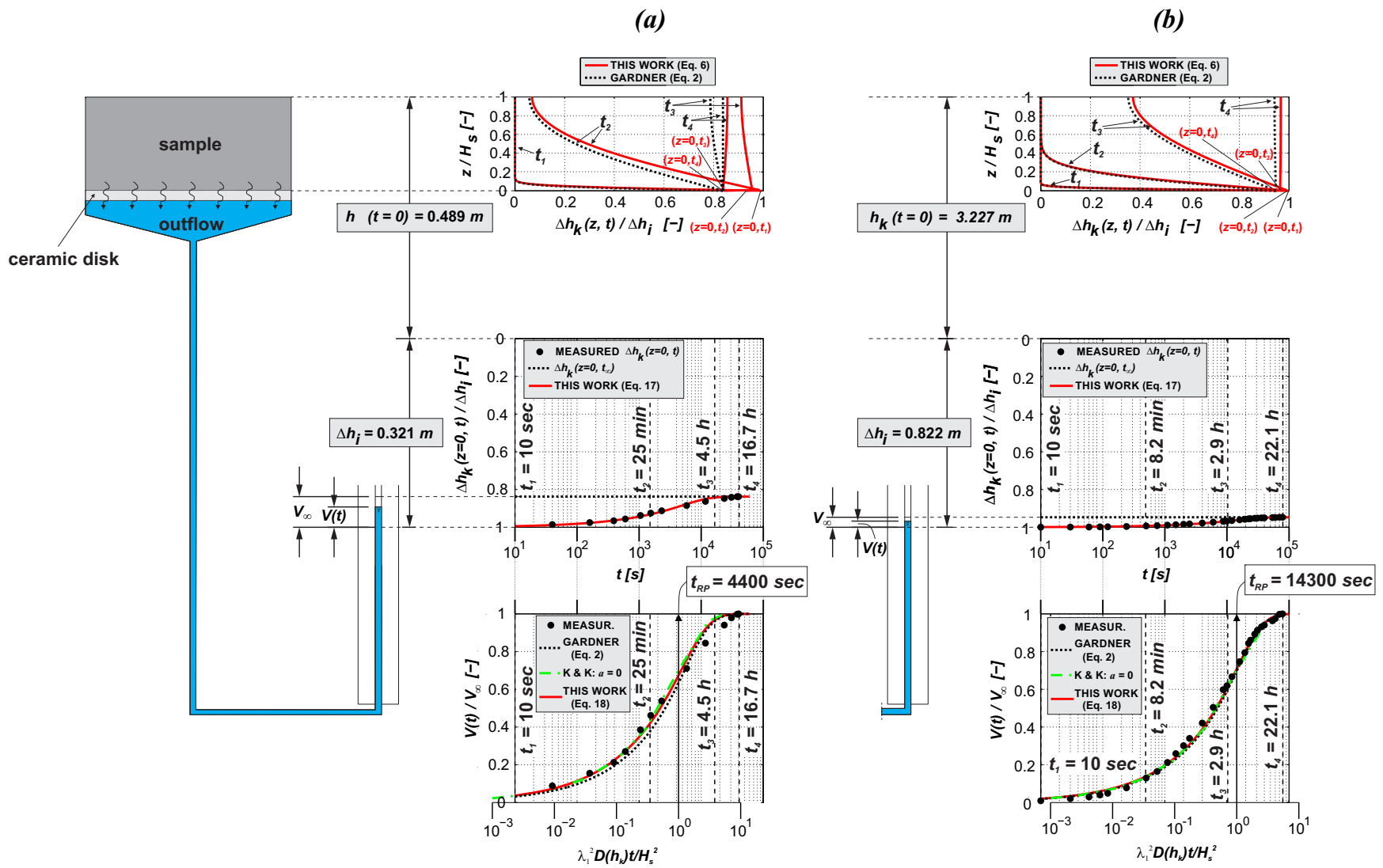

676

677

678

Figure 5. Detailed scheme of implementation of steps 4 (a) and 11 (b) when imposing non-constant suction increment. Data from coarse substrate.

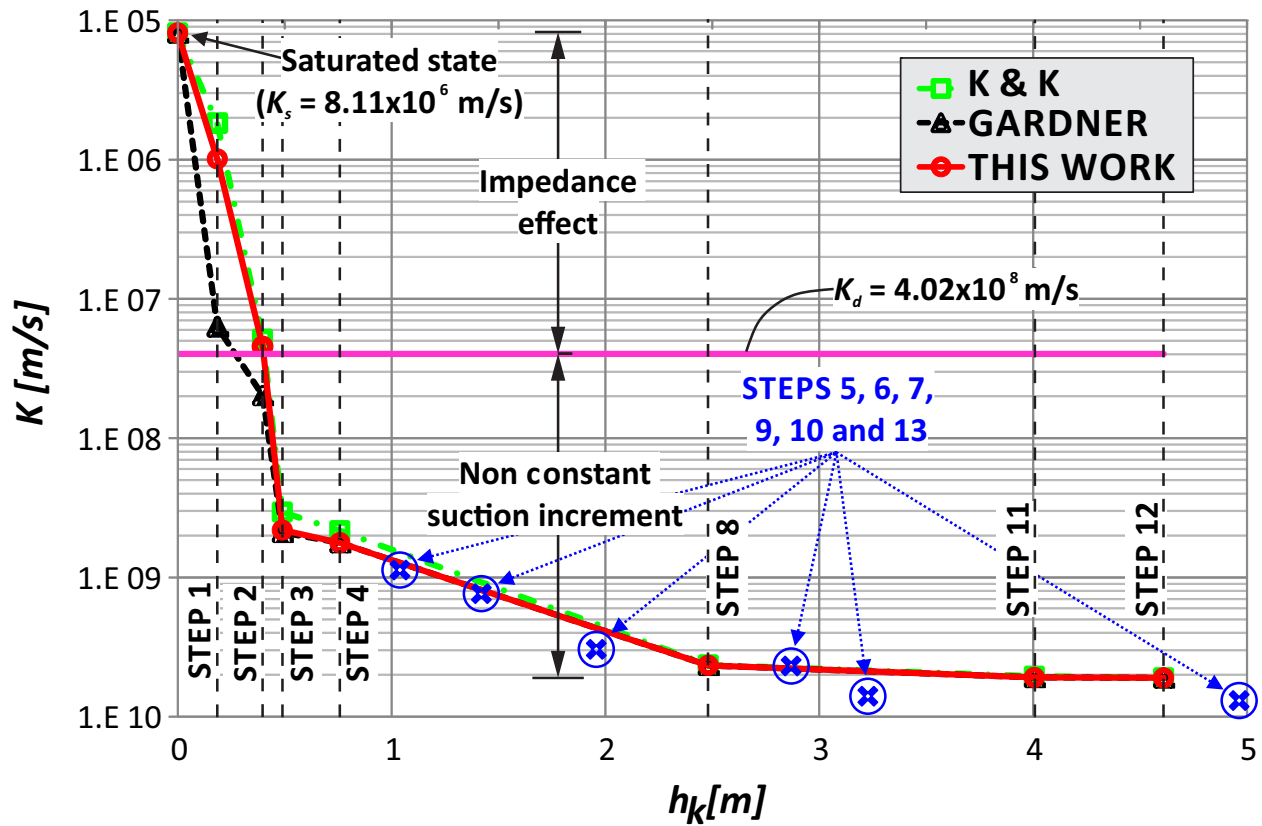

679

680 *Figure 6. Change of hydraulic conductivity of the coarse substrate with respect to increased*
 681 *suction obtained using 3 different methods: Kunze & Kirkham's method (squares), Gardner's*
 682 *method (triangles) and methods developed in this work (circles). Hydraulic conductivity values*
 683 *obtained by analyzing volume change measurements at larger times (Equation 3) are presented*
 684 *with blue symbols*

685

686

687

688

689

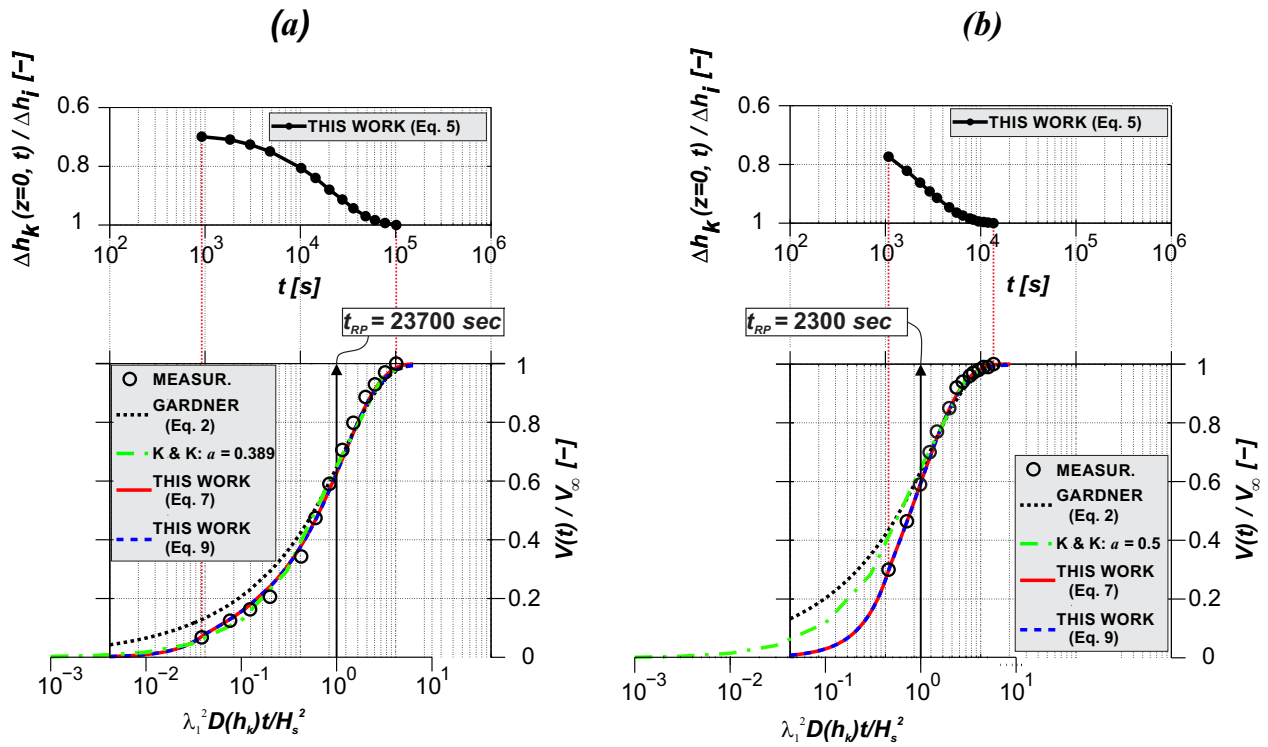

690

691 *Figure 7. (a) Poorly graded sand (data from Wayllace and Lu 2011); top - Suction change at*
 692 *specimen bottom, at contact with ceramic disk, bottom – measured outflow (circles) compared*
 693 *with calculated values from different methods (indicated on the figure);*
 694 *(b) Undisturbed silty clay (data from Wayllace and Lu 2011): same as in (a)*