

Polarization Q/I

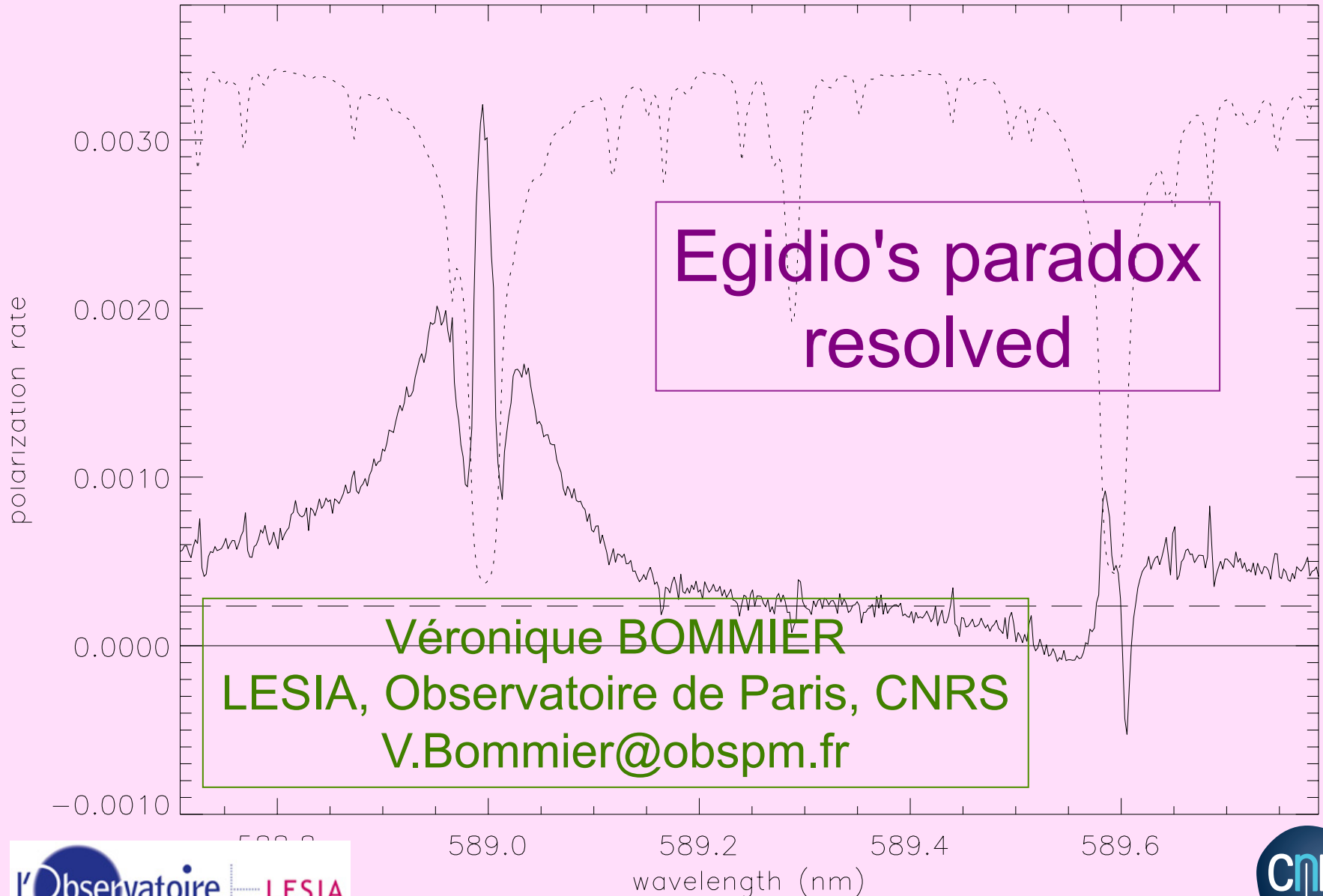

UNPHYSICAL LINE POLARIZATIONS

Markov approximation (1st non-zero order: order-2)

theory with guessed line profiles: Landi Degl'Innocenti, Solar Phys., 1983, 85, 3 & 1984, 91, 1

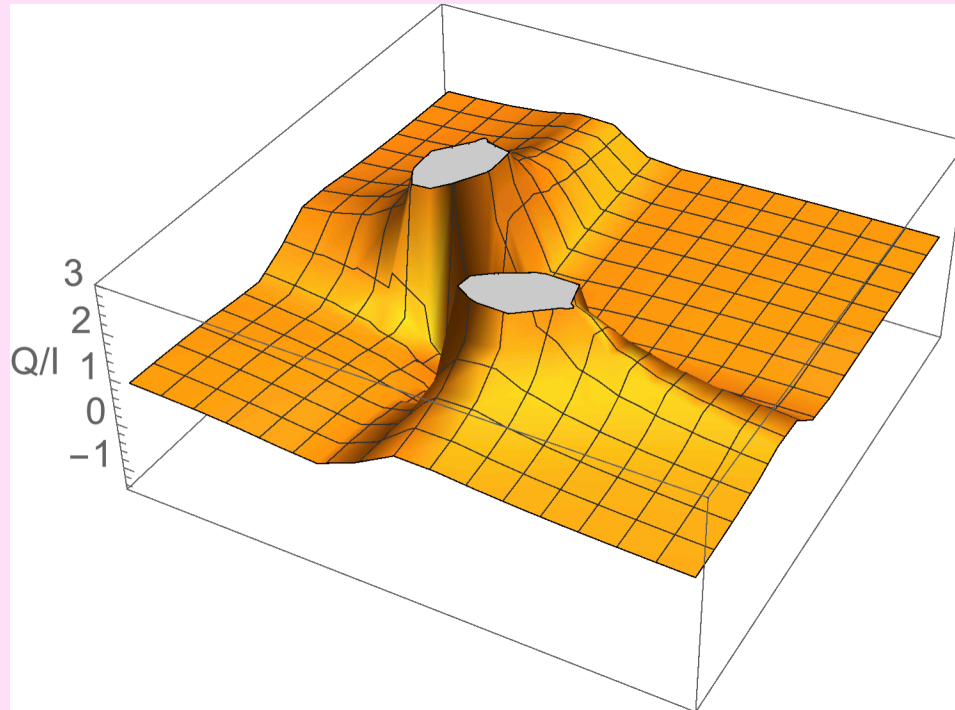

$$\frac{\left[R_{III}(\nu_1, \nu) \right]_{01}^{\text{order-2}}}{\left[R_{III}(\nu_1, \nu) \right]_{00}^{\text{order-2}}}$$

90° scattering

Na I D1 & D2 frequencies
very weak collisions

BEYOND THE MARKOV APPROXIMATION

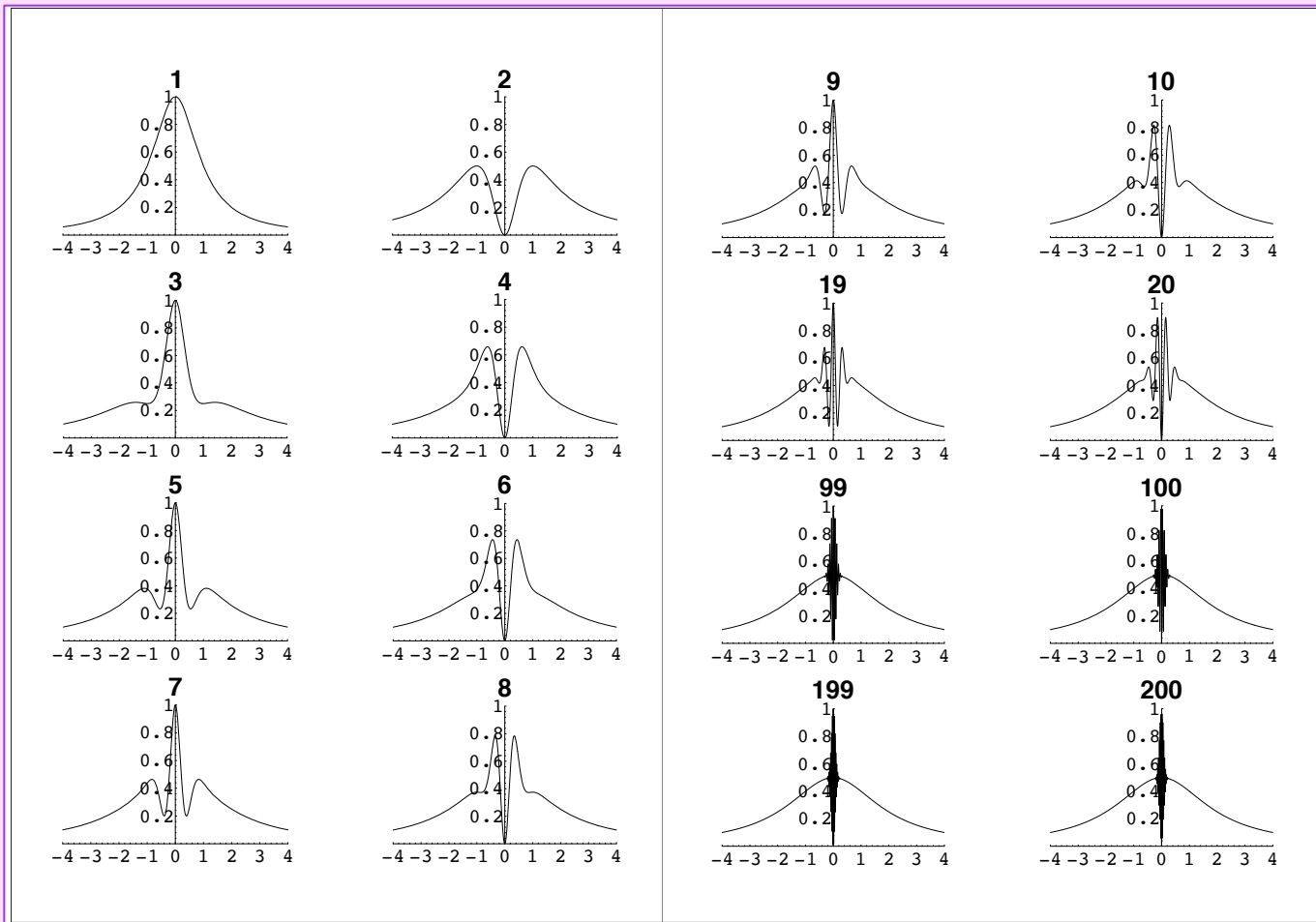

from Bommier, 1997, A&A 328, 706

the way to get the line profiles
and to incorporate the partial redistribution (PRD)

+ NEW TERM IN THE EMISSIVITY

$$\varepsilon_i(\nu, \vec{\Omega}) = \varepsilon_i^{(2)}(\nu, \vec{\Omega}) + \varepsilon_i^{(4)}(\nu, \vec{\Omega})$$

$i = 0, 1, 2, 3 \Leftrightarrow$ Stokes (I, Q, U, V)

$\varepsilon_i^{(2)}$: emission from upper levels (from order-2)

$\varepsilon_i^{(4)}$: correction for Rayleigh (coherent) scattering
in the far wings

Order-2

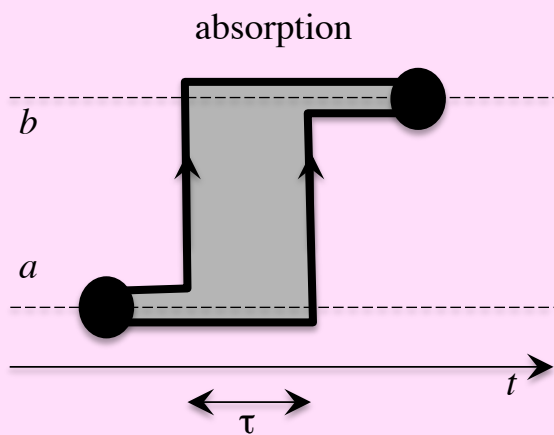

(1)

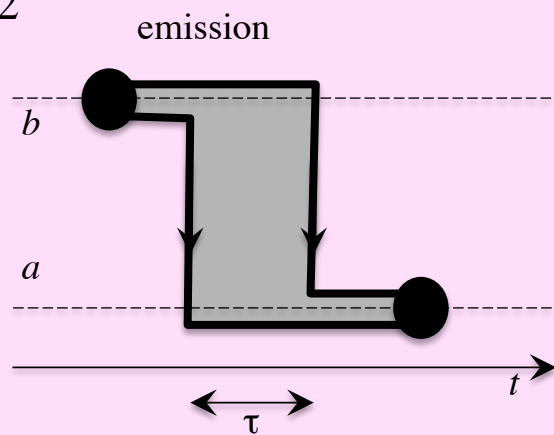

(2)

Order-4: scattering

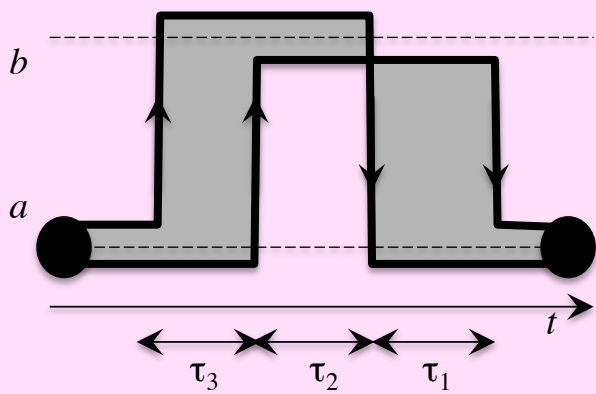

(3)

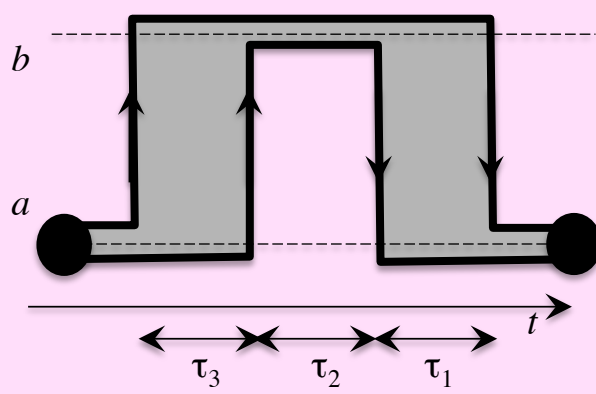

(4)

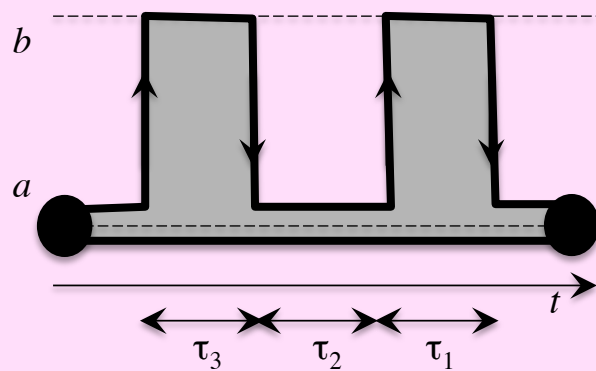
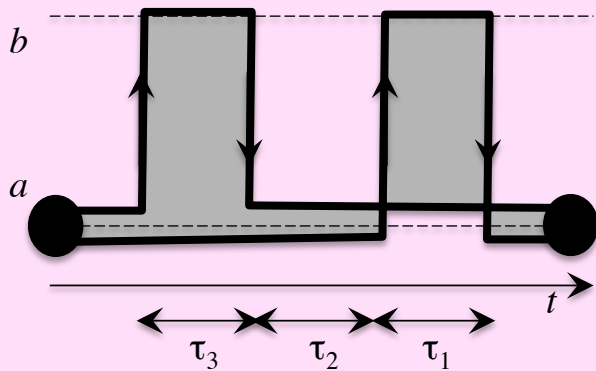

Transformation into a series development

absorption

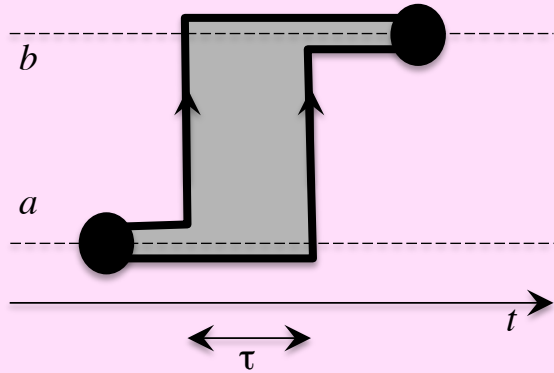

(1)

emission

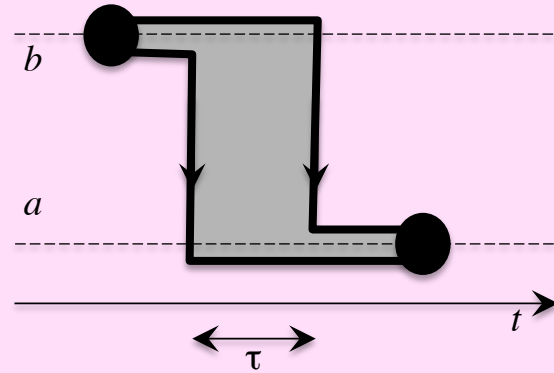

(2)

+

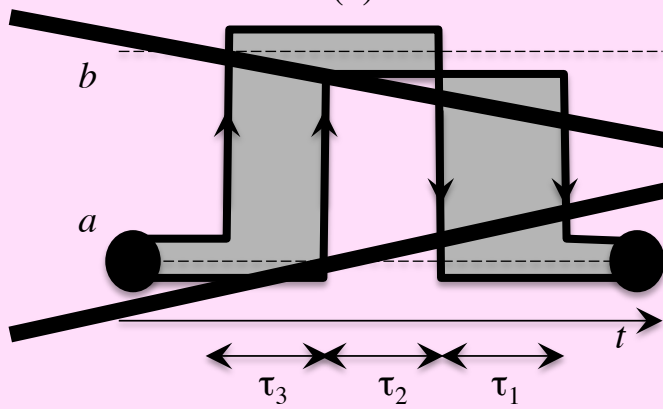

(3)

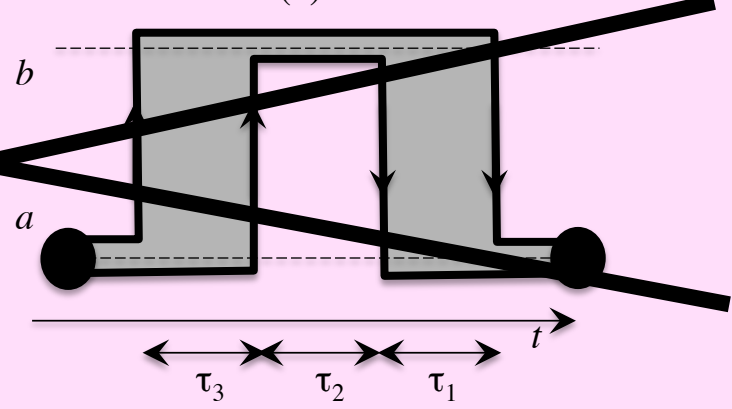

(4)

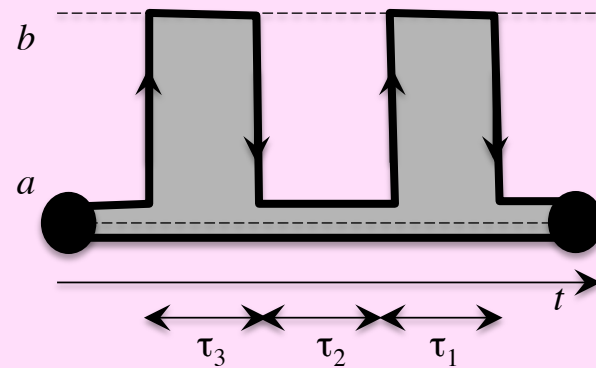
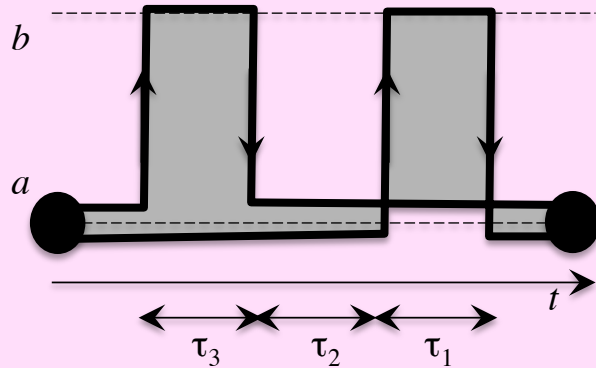

PUBLICATIONS

2-level atom:

- Bommier, 1997, A&A 328, 706
philosophy, theory
- Bommier, 1997, A&A 328, 726
+ magnetic field

generalization to the multilevel atom:

- Bommier, 2016, A&A 591, A59
philosophy, theory
- Bommier, 2016, A&A 591, A60
numerical application to solar Na I D₁ & D₂

from the first principles: Schrödinger equation
(master equation theory)

CASE OF INTEREST

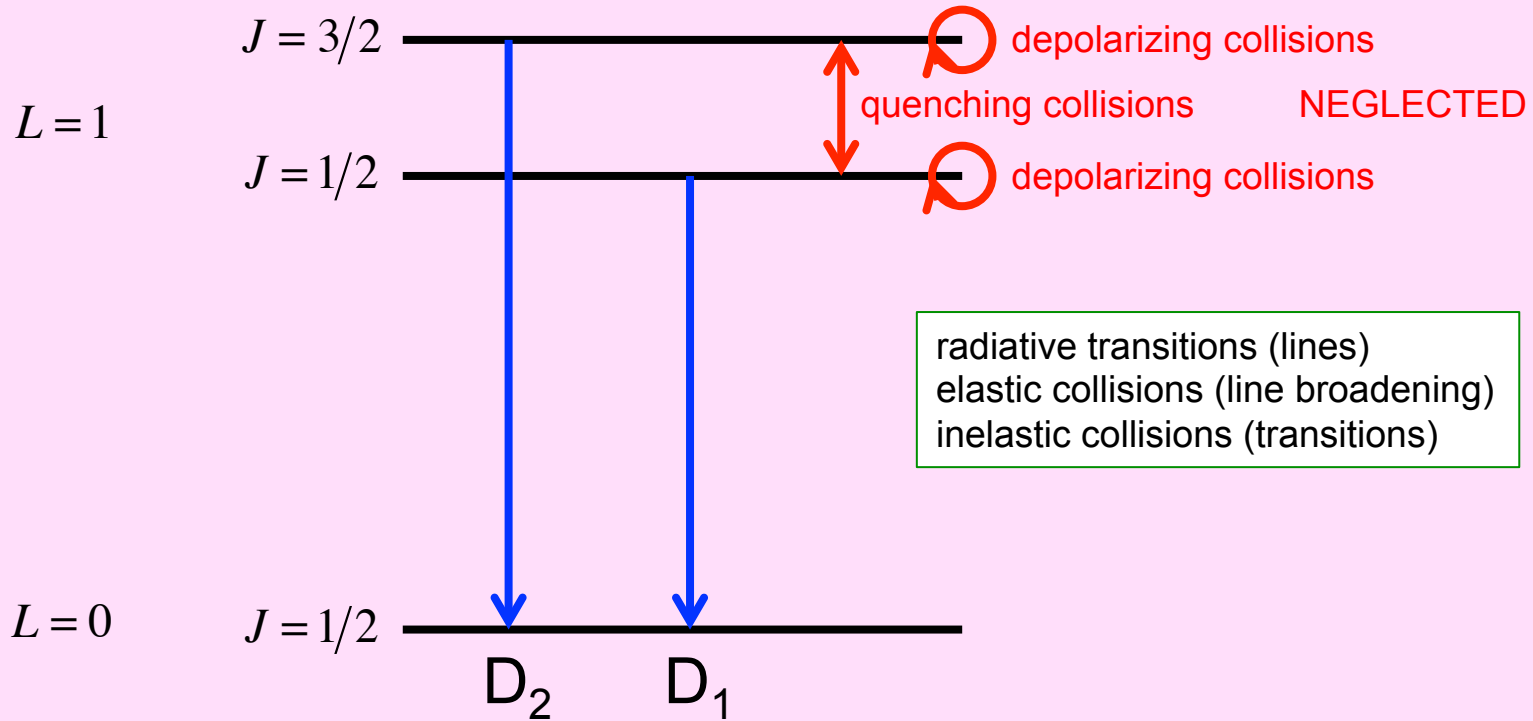

- two-term atom
- neither depolarizing nor quenching collisions, but line broadening
- unpolarized infinitely sharp lower levels

BEYOND THE MARKOV APPROXIMATION: new term in the emissivity (PRD)

$$\begin{aligned}
 [R]_{ij} &= \sum_{J_u J'_u J_\ell J'_\ell K Q} \int f(\vec{v}) d^3 \vec{v} (-1)^Q \mathcal{T}_{-Q}^K(j, \vec{\Omega}_1) \mathcal{T}_Q^K(i, \vec{\Omega}) \\
 &\times 3 \frac{2L_u + 1}{2S + 1} (2J_u + 1)(2J'_u + 1)(2J_\ell + 1)(2J'_\ell + 1) \\
 &\times \left\{ \begin{matrix} J_u & 1 & J_\ell \\ L_\ell & S & L_u \end{matrix} \right\} \left\{ \begin{matrix} J'_u & 1 & J_\ell \\ L_\ell & S & L_u \end{matrix} \right\} \left\{ \begin{matrix} J_u & 1 & J'_\ell \\ L_\ell & S & L_u \end{matrix} \right\} \left\{ \begin{matrix} J_u & 1 & J'_\ell \\ L_\ell & S & L_u \end{matrix} \right\} \left\{ \begin{matrix} K & J'_u & J_u \\ J_\ell & 1 & 1 \end{matrix} \right\} \left\{ \begin{matrix} K & J'_u & J_u \\ J'_\ell & 1 & 1 \end{matrix} \right\} \\
 &\times \{ \mathcal{R}_{II} + \mathcal{R}_{III} \} \\
 &= \sum_{J_u J'_u J_\ell J'_\ell K Q} \int f(\vec{v}) d^3 \vec{v} (-1)^Q \mathcal{T}_{-Q}^K(j, \vec{\Omega}_1) \mathcal{T}_Q^K(i, \vec{\Omega}) \\
 &\times 3 \frac{2L_u + 1}{2S + 1} (2J_u + 1)(2J'_u + 1)(2J_\ell + 1)(2J'_\ell + 1) \\
 &\times \left\{ \begin{matrix} J_u & 1 & J_\ell \\ L_\ell & S & L_u \end{matrix} \right\} \left\{ \begin{matrix} J'_u & 1 & J_\ell \\ L_\ell & S & L_u \end{matrix} \right\} \left\{ \begin{matrix} J_u & 1 & J'_\ell \\ L_\ell & S & L_u \end{matrix} \right\} \left\{ \begin{matrix} J_u & 1 & J'_\ell \\ L_\ell & S & L_u \end{matrix} \right\} \left\{ \begin{matrix} K & J'_u & J_u \\ J_\ell & 1 & 1 \end{matrix} \right\} \left\{ \begin{matrix} K & J'_u & J_u \\ J'_\ell & 1 & 1 \end{matrix} \right\} \\
 &\times \left\{ \frac{\Gamma_R + \Gamma_I}{\underbrace{\Gamma_R + \Gamma_I + \Gamma_E + i\Delta E_{J_u J'_u}}_{\text{line-width}} / \hbar} \left[\frac{1}{2} \Phi(v_{J'_u J_\ell} - \tilde{v}_1) + \frac{1}{2} \Phi^*(v_{J_u J_\ell} - \tilde{v}_1) \right] \delta(\tilde{v} - \tilde{v}_1 - \Delta E_{J_u J'_u} / \hbar) \right. \\
 &\left. + \left[\frac{\Gamma_R + \Gamma_I}{\underbrace{\Gamma_R + \Gamma_I + i\Delta E_{J_u J'_u}}_{\text{level-width}} / \hbar} - \frac{\Gamma_R + \Gamma_I}{\underbrace{\Gamma_R + \Gamma_I + \Gamma_E + i\Delta E_{J_u J'_u}}_{\text{line-width}} / \hbar} \right] \left[\frac{1}{2} \Phi(v_{J'_u J_\ell} - \tilde{v}_1) + \frac{1}{2} \Phi^*(v_{J_u J_\ell} - \tilde{v}_1) \right] \left[\frac{1}{2} \Phi(v_{J'_u J'_\ell} - \tilde{v}) + \frac{1}{2} \Phi^*(v_{J_u J'_\ell} - \tilde{v}) \right] \right\}
 \end{aligned}$$

– two-term atom

– neither depolarizing nor quenching collisions, but line broadening

– unpolarized infinitely sharp lower levels

THE BRANCHING RATIOS ARE INCLUDED (cannot be factorized)

R_{||} (coherent scattering)

B = 0

the branching ratio

includes:

- the magnetic field (see later)
- the fine and hyperfine structure

$$\begin{aligned}
 [R_{||}]_{ij} = & \sum_{J_u J'_u J_\ell J'_\ell K Q} \int f(\vec{v}) d^3 \vec{v} (-1)^Q \mathcal{T}_{-Q}^K(j, \vec{\Omega}_1) \mathcal{T}_Q^K(i, \vec{\Omega}) \\
 & \times 3 \frac{2L_u + 1}{2S + 1} (2J_u + 1)(2J'_u + 1)(2J_\ell + 1)(2J'_\ell + 1) \\
 & \times \left\{ \begin{matrix} J_u & 1 & J_\ell \\ L_\ell & S & J_u \end{matrix} \right\} \left\{ \begin{matrix} J'_u & 1 & J_\ell \\ L_\ell & S & L_u \end{matrix} \right\} \left\{ \begin{matrix} J_u & 1 & J'_\ell \\ L_\ell & S & L_u \end{matrix} \right\} \left\{ \begin{matrix} J_u & 1 & J'_\ell \\ L_\ell & S & L_u \end{matrix} \right\} \\
 & \left\{ \begin{matrix} K & J'_u & J_u \\ J_\ell & 1 & 1 \end{matrix} \right\} \left\{ \begin{matrix} K & J'_u & J_u \\ J'_\ell & 1 & 1 \end{matrix} \right\} \\
 & \times \underbrace{\frac{\Gamma_R + \Gamma_I}{\Gamma_R + \Gamma_I + \Gamma_E + i\Delta E_{J_u J'_u} / \hbar}}_{\text{line-width}} \left[\frac{1}{2} \Phi(v_{J_u J'_\ell} - \tilde{v}_1) + \frac{1}{2} \Phi^*(v_{J_u J'_\ell} - \tilde{v}_1) \right] \delta(\tilde{v} - \tilde{v}_1 - \Delta E_{J_u J'_u} / h)
 \end{aligned}$$

in agreement with

- Landi Degl'Innocenti's (ELDI & MLDI), Landolfi, 1997,
Proc. Forum THEMIS, Science with THEMIS,
N. Mein & S. Sahal-Bréchet (eds), Paris Observatory, Paris
(metalevel theory)
- Casini, MLDI, Manso Sainz, ELDI, Landolfi, 2014, ApJ, 791, 94

REWRITING OF R_{III} (incoherent scattering) in terms of branching ratios

$$\begin{aligned}
 [R_{III}]_{ij} &= \sum_{J_u, J'_u, J, J', K, Q} \int f(\vec{v}) d^3 \vec{v} (-1)^Q \mathcal{T}_{-Q}^K(j, \vec{\Omega}_1) \mathcal{T}_Q^K(i, \vec{\Omega}) \\
 &\times 3 \frac{2L_u + 1}{2S + 1} (2J_u + 1)(2J'_u + 1)(2J_\ell + 1)(2J'_\ell + 1) \\
 &\times \left\{ \begin{matrix} J_u & 1 & J_\ell \\ L_\ell & S & L_u \end{matrix} \right\} \left\{ \begin{matrix} J'_u & 1 & J_\ell \\ L_\ell & S & L_u \end{matrix} \right\} \left\{ \begin{matrix} J_u & 1 & J'_\ell \\ L_\ell & S & L_u \end{matrix} \right\} \left\{ \begin{matrix} J_u & 1 & J'_\ell \\ L_\ell & S & L_u \end{matrix} \right\} \\
 &\left\{ \begin{matrix} K & J'_u & J_u \\ J_\ell & 1 & 1 \end{matrix} \right\} \left\{ \begin{matrix} K & J'_u & J_u \\ J'_\ell & 1 & 1 \end{matrix} \right\} \\
 &+ \left[\frac{\Gamma_R + \Gamma_I}{\Gamma_R + \Gamma_I + i\Delta E_{J_u J'_u} / \hbar} - \frac{\Gamma_R + \Gamma_I}{\Gamma_R + \Gamma_I + \Gamma_E + i\Delta E_{J_u J'_u} / \hbar} \right] \left[\frac{1}{2} \Phi(v_{J_u J'_\ell} - \tilde{v}_1) + \frac{1}{2} \Phi^*(v_{J_u J'_\ell} - \tilde{v}_1) \right] \left[\frac{1}{2} \Phi(v_{J_u J'_\ell} - \tilde{v}) + \frac{1}{2} \Phi^*(v_{J_u J'_\ell} - \tilde{v}) \right] \\
 &= \sum_{J_u, J'_u, J, J', K, Q} \int f(\vec{v}) d^3 \vec{v} (-1)^Q \mathcal{T}_{-Q}^K(j, \vec{\Omega}_1) \mathcal{T}_Q^K(i, \vec{\Omega}) \\
 &\times 3 \frac{2L_u + 1}{2S + 1} (2J_u + 1)(2J'_u + 1)(2J_\ell + 1)(2J'_\ell + 1) \\
 &\times \left\{ \begin{matrix} J_u & 1 & J_\ell \\ L_\ell & S & L_u \end{matrix} \right\} \left\{ \begin{matrix} J'_u & 1 & J_\ell \\ L_\ell & S & L_u \end{matrix} \right\} \left\{ \begin{matrix} J_u & 1 & J'_\ell \\ L_\ell & S & L_u \end{matrix} \right\} \left\{ \begin{matrix} J_u & 1 & J'_\ell \\ L_\ell & S & L_u \end{matrix} \right\} \\
 &\left\{ \begin{matrix} K & J'_u & J_u \\ J_\ell & 1 & 1 \end{matrix} \right\} \left\{ \begin{matrix} K & J'_u & J_u \\ J'_\ell & 1 & 1 \end{matrix} \right\} \\
 &+ \left[\frac{\Gamma_R + \Gamma_I}{\Gamma_R + \Gamma_I + i\Delta E_{J_u J'_u} / \hbar} - \frac{\Gamma_E}{\Gamma_R + \Gamma_I + \Gamma_E + i\Delta E_{J_u J'_u} / \hbar} \right] \left[\frac{1}{2} \Phi(v_{J_u J'_\ell} - \tilde{v}_1) + \frac{1}{2} \Phi^*(v_{J_u J'_\ell} - \tilde{v}_1) \right] \left[\frac{1}{2} \Phi(v_{J_u J'_\ell} - \tilde{v}) + \frac{1}{2} \Phi^*(v_{J_u J'_\ell} - \tilde{v}) \right]
 \end{aligned}$$

the branching ratios

include:

- the magnetic field (see later)
- the fine and hyperfine structure

RESULT: PHYSICAL LINEAR POLARIZATIONS

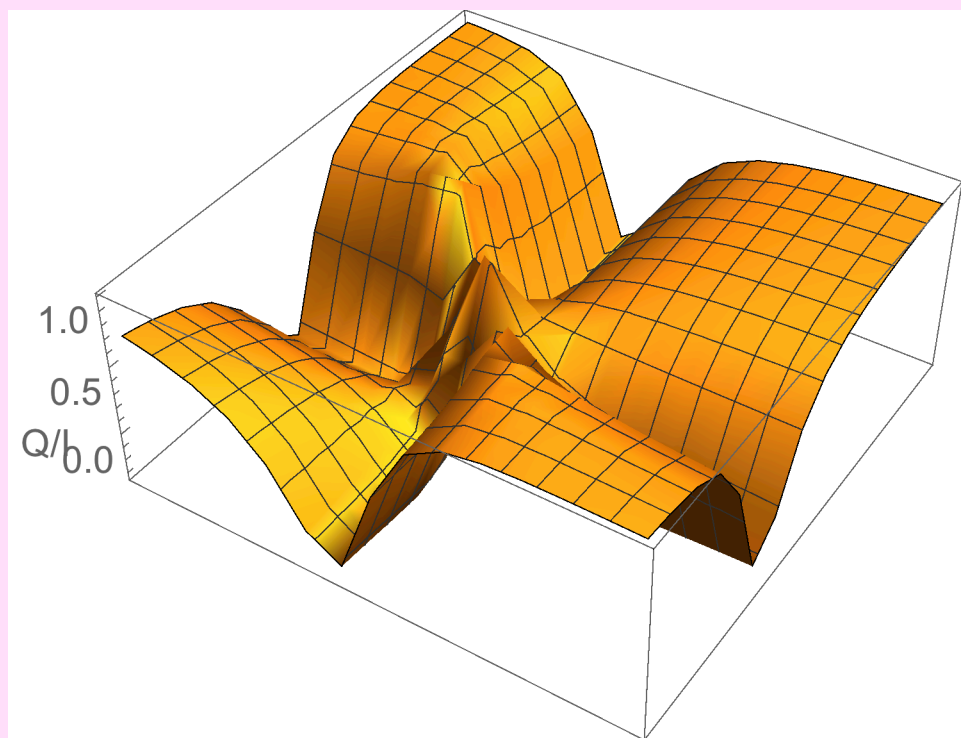

$$\frac{\left[R_{III}(\nu_1, \nu) \right]_{01}}{\left[R_{III}(\nu_1, \nu) \right]_{00}}$$

90° scattering

Na I D1 & D2 frequencies
very weak collisions

from Belluzzi & Trujillo Bueno
2014, A&A 564, A16

$$\begin{aligned}
 [R_{III}]_{ij} = & \sum_{J_u J'_u J_\ell J'_\ell K Q} \int f(\vec{v}) d^3 \vec{v} (-1)^Q \mathcal{T}_{-Q}^K(j, \vec{\Omega}_1) \mathcal{T}_Q^K(i, \vec{\Omega}) \\
 & \times 3 \frac{2L_u + 1}{2S + 1} (2J_u + 1)(2J'_u + 1)(2J_\ell + 1)(2J'_\ell + 1) \\
 & \times \left\{ \begin{matrix} J_u & 1 & J_\ell \\ L_\ell & S & L_u \end{matrix} \right\} \left\{ \begin{matrix} J'_u & 1 & J_\ell \\ L_\ell & S & L_u \end{matrix} \right\} \left\{ \begin{matrix} J_u & 1 & J'_\ell \\ L_\ell & S & L_u \end{matrix} \right\} \left\{ \begin{matrix} J_u & 1 & J'_\ell \\ L_\ell & S & L_u \end{matrix} \right\} \left\{ \begin{matrix} K & J'_u & J_u \\ J_\ell & 1 & 1 \end{matrix} \right\} \left\{ \begin{matrix} K & J'_u & J_u \\ J'_\ell & 1 & 1 \end{matrix} \right\} \\
 & + \frac{\Gamma_R + \Gamma_I}{\Gamma_R + \Gamma_I + i\Delta E_{J_u J'_u} / \hbar} \frac{\Gamma_E}{\Gamma_R + \Gamma_I + \Gamma_E + i\Delta E_{J_u J'_u} / \hbar} \left[\frac{1}{2} \Phi(v_{J_u J_\ell} - \tilde{v}_1) + \frac{1}{2} \Phi^*(v_{J_u J_\ell} - \tilde{v}_1) \right] \left[\frac{1}{2} \Phi(v_{J'_u J'_\ell} - \tilde{v}) + \frac{1}{2} \Phi^*(v_{J'_u J'_\ell} - \tilde{v}) \right]
 \end{aligned}$$

J_u instead of J'_u in the first elementary profile: consequence:

- a conjugation relation is not satisfied
- the outgoing Stokes parameters are not real quantities

using Belluzzi & Trujillo Bueno
2014, A&A 564, A16

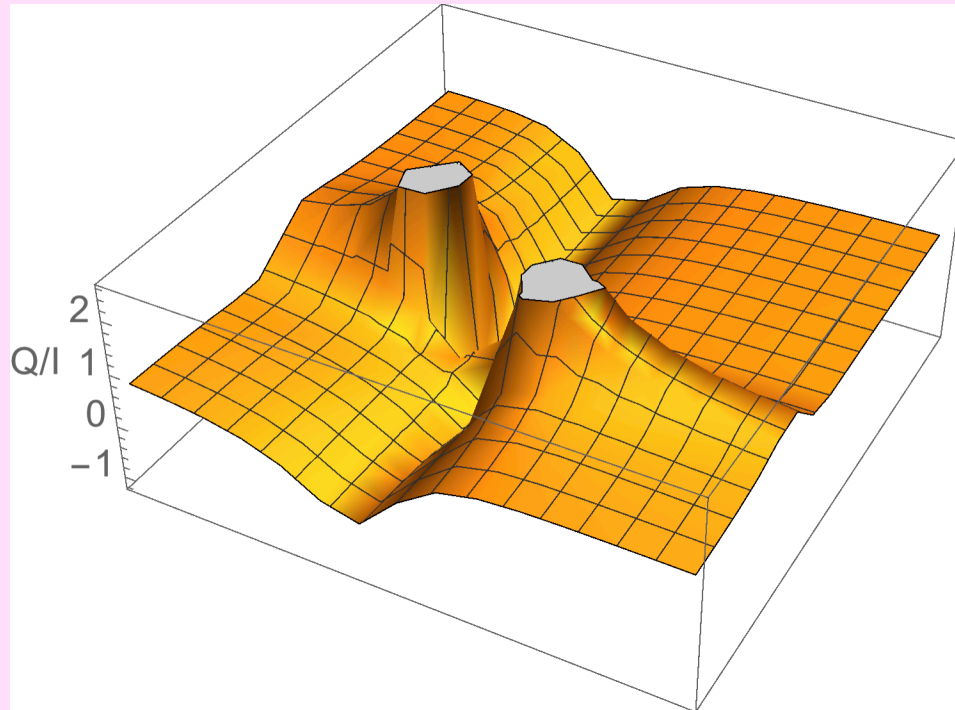

$$\frac{[R_{III}(v_1, \nu)]_{01}}{[R_{III}(v_1, \nu)]_{00}}$$

90° scattering

Na I D1 & D2 frequencies
very weak collisions

from Smitha, Nagendra, Sampurna, Stenflo
2013, JQSRT 115, 46

$$\begin{aligned}
 [R_{III}]_{ij} &= \sum_{J_u J'_u J_\ell J'_\ell K Q} \int f(\vec{v}) d^3 \vec{v} (-1)^Q \mathcal{T}_{-Q}^K(j, \vec{\Omega}_1) \mathcal{T}_Q^K(i, \vec{\Omega}) \\
 &\times 3 \frac{2L_u + 1}{2S + 1} (2J_u + 1)(2J'_u + 1)(2J_\ell + 1)(2J'_\ell + 1) \\
 &\times \left\{ \begin{matrix} J_u & 1 & J_\ell \\ L_\ell & S & L_u \end{matrix} \right\} \left\{ \begin{matrix} J'_u & 1 & J_\ell \\ L_\ell & S & L_u \end{matrix} \right\} \left\{ \begin{matrix} J_u & 1 & J'_\ell \\ L_\ell & S & L_u \end{matrix} \right\} \left\{ \begin{matrix} J_u & 1 & J'_\ell \\ L_\ell & S & L_u \end{matrix} \right\} \left\{ \begin{matrix} K & J'_u & J_u \\ J_\ell & 1 & 1 \end{matrix} \right\} \left\{ \begin{matrix} K & J'_u & J_u \\ J'_\ell & 1 & 1 \end{matrix} \right\} \\
 &+ \frac{\Gamma_R + \Gamma_I}{\Gamma_R + \Gamma_I + i\Delta E_{J_u J'_u} / \hbar} \frac{\Gamma_E}{\Gamma_R + \Gamma_I + \Gamma_E + i\Delta E_{J_u J'_u} / \hbar} \left[\frac{1}{2} \Phi(v_{J'_u J_\ell} - \tilde{v}_1) + \frac{1}{2} \Phi^*(v_{J_u J_\ell} - \tilde{v}_1) \right] \left[\frac{1}{2} \Phi(v_{J'_u J'_\ell} - \tilde{v}) + \frac{1}{2} \Phi^*(v_{J_u J'_\ell} - \tilde{v}) \right]
 \end{aligned}$$

using Smitha, Nagendra, Sampoorna, Stenflo
2013, JQSRT 115, 46

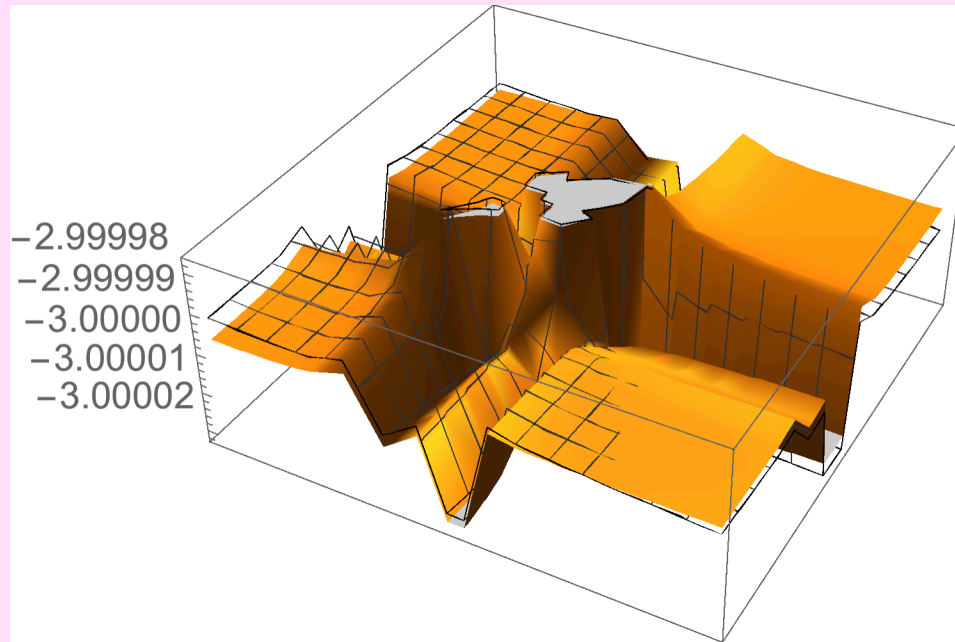

$$\frac{\left[R_{III}(\nu_1, \nu) \right]_{01}}{\left[R_{III}(\nu_1, \nu) \right]_{00}}$$

90° scattering

Na I D1 & D2 frequencies
very weak collisions

EXTENSION TO NON-ZERO MAGNETIC FIELD

B ≠ 0

$$\begin{aligned}
 [R]_{ij} = & \sum_{J_u J'_u M_u M'_u J_\ell J'_\ell M_\ell M'_\ell K Q K' Q'} \int f(\vec{v}) d^3 \vec{v} (-1)^Q \mathcal{T}_{-Q}^K(j, \vec{\Omega}_1) \mathcal{T}_{Q'}^{K'}(i, \vec{\Omega}) \\
 & \times 3 \frac{2L_u + 1}{2S + 1} (2J_u + 1)(2J'_u + 1)(2J_\ell + 1)(2J'_\ell + 1) \sqrt{(2K + 1)(2K' + 1)} \\
 & \times \left\{ \begin{matrix} J_u & 1 & J_\ell \\ L_\ell & S & L_u \end{matrix} \right\} \left\{ \begin{matrix} J'_u & 1 & J_\ell \\ L_\ell & S & L_u \end{matrix} \right\} \left\{ \begin{matrix} J_u & 1 & J'_\ell \\ L_\ell & S & L_u \end{matrix} \right\} \left\{ \begin{matrix} J_u & 1 & J'_\ell \\ L_\ell & S & L_u \end{matrix} \right\} \left\{ \begin{matrix} K & J'_u & J_u \\ J_\ell & 1 & 1 \end{matrix} \right\} \left\{ \begin{matrix} K & J'_u & J_u \\ J'_\ell & 1 & 1 \end{matrix} \right\} \\
 & \left(\begin{matrix} J_u & 1 & J_\ell \\ -M_u & p & M_\ell \end{matrix} \right) \left(\begin{matrix} J'_u & 1 & J_\ell \\ -M'_u & p' & M_\ell \end{matrix} \right) \left(\begin{matrix} J_u & 1 & J'_\ell \\ -M_u & p''' & M'_\ell \end{matrix} \right) \left(\begin{matrix} J'_u & 1 & J'_\ell \\ -M'_u & p'' & M'_\ell \end{matrix} \right) \left(\begin{matrix} 1 & 1 & K \\ -p & p' & Q \end{matrix} \right) \left(\begin{matrix} 1 & 1 & K' \\ -p''' & p'' & Q' \end{matrix} \right) \\
 & \times \left[\frac{\Gamma_R + \Gamma_I}{\underbrace{\Gamma_R + \Gamma_I + \Gamma_E + i\Delta E_{M_u M'_u}}_{\text{line-width}} / \hbar} \left[\frac{1}{2} \Phi(v_{M'_u M_\ell} - \tilde{v}_1) + \frac{1}{2} \Phi^*(v_{M_u M_\ell} - \tilde{v}_1) \right] \delta(\tilde{v} - \tilde{v}_1 - \Delta E_{M_u M'_u} / \hbar) \right. \\
 & \left. + \left[\frac{\Gamma_R + \Gamma_I}{\underbrace{\Gamma_R + \Gamma_I + i\Delta E_{M_u M'_u}}_{\text{level-width}} / \hbar} - \frac{\Gamma_R + \Gamma_I}{\underbrace{\Gamma_R + \Gamma_I + \Gamma_E + i\Delta E_{M_u M'_u}}_{\text{line-width}} / \hbar} \right] \left[\frac{1}{2} \Phi(v_{M'_u M_\ell} - \tilde{v}_1) + \frac{1}{2} \Phi^*(v_{M_u M_\ell} - \tilde{v}_1) \right] \left[\frac{1}{2} \Phi(v_{M'_u M'_\ell} - \tilde{v}) + \frac{1}{2} \Phi^*(v_{M_u M'_\ell} - \tilde{v}) \right] \right]
 \end{aligned}$$

THE BRANCHING RATIOS ARE INCLUDED (cannot be factorized)

& THEY INCLUDE:

– the magnetic field

– the fine and hyperfine structure

NUMERICAL APPLICATION

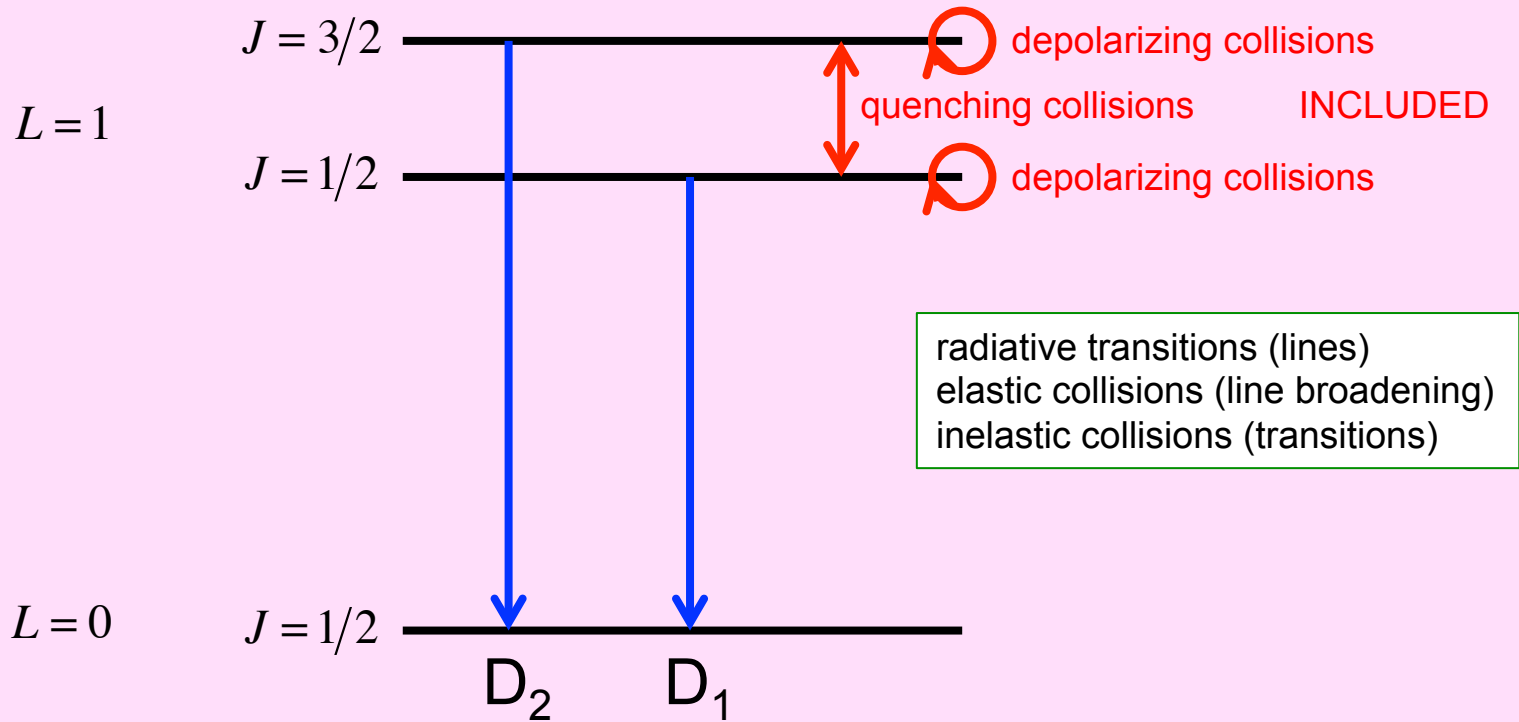

- second solar spectrum of Na I D1 & D2
- from Bommier (2016) native equations
 - resolution of the statistical equilibrium equations (for each velocity class)
 - radiative transfer integration: Feautrier's method
- unpolarized infinitely sharp lower levels

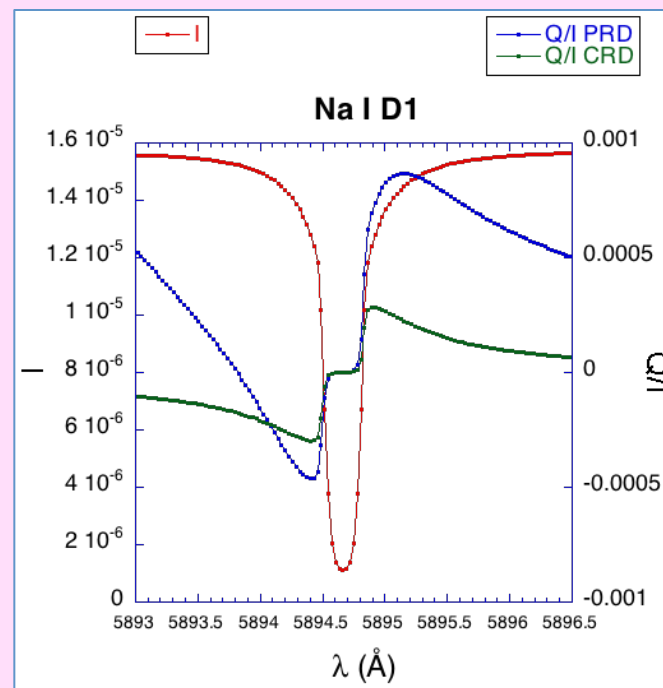
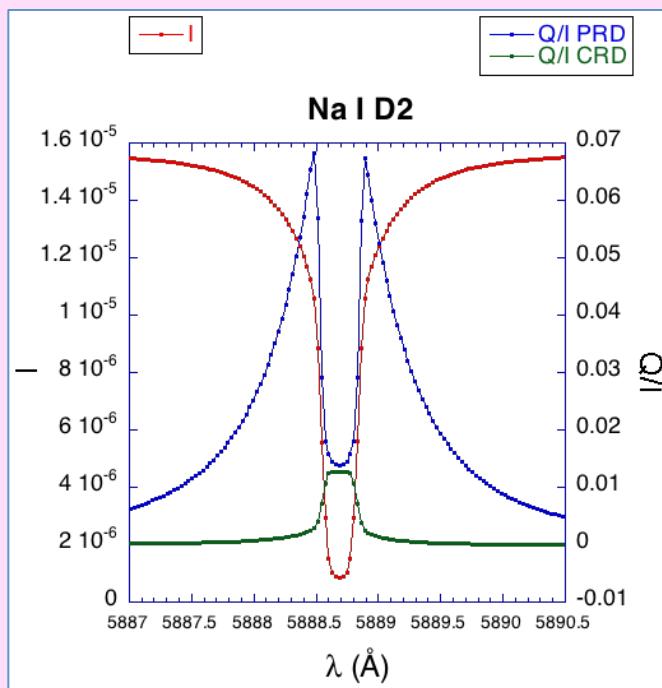
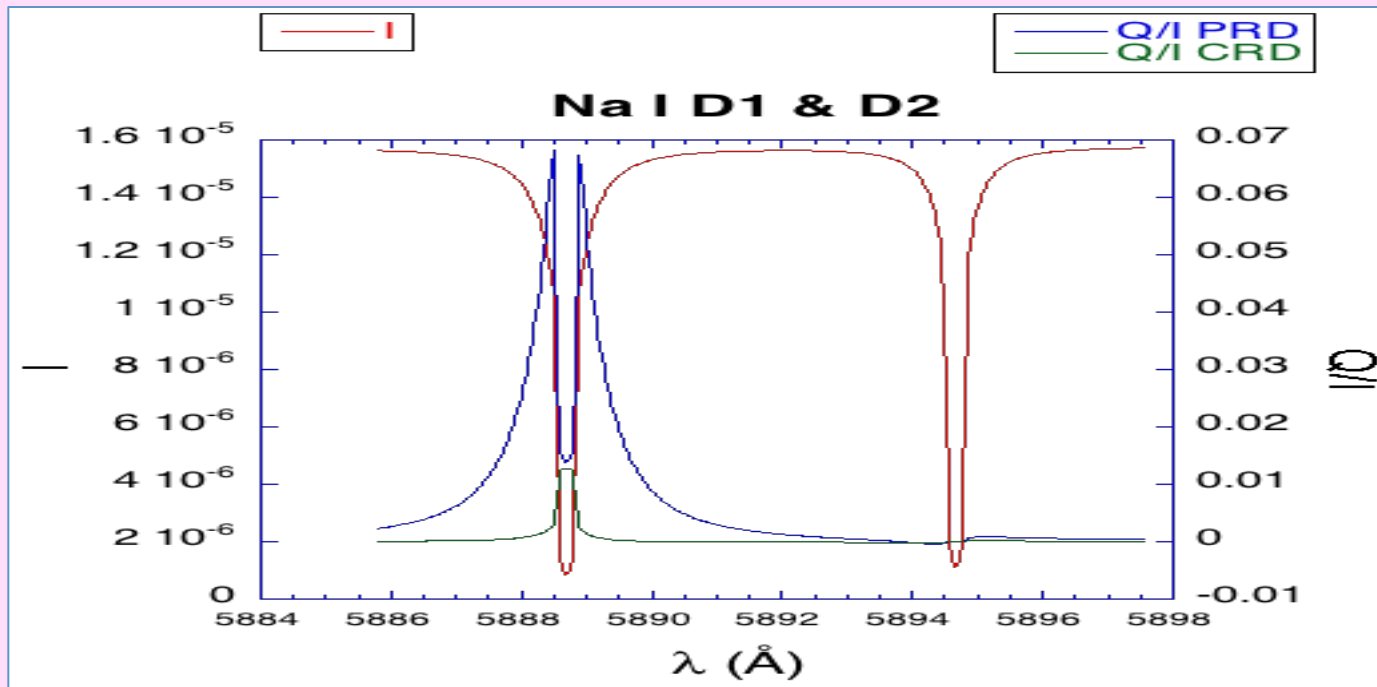

- no redistribution functions
- no source functions
- no trapezoid method integrals (all Gauss integrals)
- no angular average (dangerous for polarization !)
- present calculation: no hyperfine structure ($I=0$)

- the collisional quenching reduces the linear polarization by a factor of 2
- velocity distribution: departs up to 20% from Maxwellian in 2P states

calculation Na I D_1 & D_2 including the hyperfine structure
to be submitted to a national computing center
(16384 // threads) in 2017

THANK YOU !

