



**HAL**  
open science

## Impact of environmental conditions on the voltage profile of LV networks

Ferréol Binot, Trung Dung Le, Marc Petit

► **To cite this version:**

Ferréol Binot, Trung Dung Le, Marc Petit. Impact of environmental conditions on the voltage profile of LV networks. 2019 IEEE PES Innovative Smart Grid Technologies Europe (ISGT-Europe), Sep 2019, Bucarest, Romania. 10.1109/ISGTEurope.2019.8905767 . hal-03021368

**HAL Id: hal-03021368**

**<https://hal.science/hal-03021368>**

Submitted on 24 Nov 2020

**HAL** is a multi-disciplinary open access archive for the deposit and dissemination of scientific research documents, whether they are published or not. The documents may come from teaching and research institutions in France or abroad, or from public or private research centers.

L'archive ouverte pluridisciplinaire **HAL**, est destinée au dépôt et à la diffusion de documents scientifiques de niveau recherche, publiés ou non, émanant des établissements d'enseignement et de recherche français ou étrangers, des laboratoires publics ou privés.

# Impact of environmental conditions on the voltage profile of LV networks

Ferréol BINOT, Trung Dung LE, Marc PETIT

GeePs | Group of electrical engineering - Paris,  
CNRS, CentraleSupélec, Univ. Paris-Sud, Université Paris-Saclay, Sorbonne Université,  
3 & 11 rue Joliot-Curie, Plateau de Moulon, 91192 Gif-sur-Yvette cedex, France  
[Ferreol.binot@centralesupelec.fr](mailto:Ferreol.binot@centralesupelec.fr)

**Abstract**—European distribution system operators (DSOs) should meet EN 50160 standard requirements on the whole network. With the development of distributed energy resources (DER), DSOs need to have a better insight of their low voltage (LV) networks. In this paper, we study the joint impact of external conditions (cable temperature, the ground resistivity and the ground resistances) on the voltage profile of three LV networks in four cases. The results show that some voltage problems cannot be seen by using only usual values of those external conditions. By considering the values that are closer to the real conditions, the voltage analysis will be more accurate and in some cases, additional problems can be detected. To be sure that the EN 50160 standard is met, a global study of LV networks including the external conditions should be done.

**Index Terms**—Voltage profile, low voltage networks, temperature, ground resistivity, grounding resistance.

## I. INTRODUCTION

In Europe, distribution system operators (DSOs) should meet the EN 50160 standard requirements. The main ones for low voltage (LV) networks are that:

- Line-to-neutral voltages must be 95% of the time within the range of  $\pm 10\%$  of nominal voltage
- Line-to-neutral negative-sequence voltage must be 95% of the time less than 2% of the positive-sequence voltage

This standard has been in use for several years. With the arrival of Smart Grids and fast development of distributed energy resources (DERs), more and more new components are connected to distribution networks. They are often single-phase components, thus potentially increase unbalance and reverse power flows. This increases the risk that DSOs no longer meet the standard [1]. To address future network constraints, network codes applied in Europe define the requirements enforced to significant grid users and DSOs [2]. Furthermore, new methods for LV network planning [3] and even for network real-time management [4] have been proposed. To be able to effectively implement these methods, DSOs should have a better knowledge of LV networks. In this paper, cable models and their impact to the voltage profile will be discussed. Obviously, the cable impedance matrix depends on environmental

conditions. In LV network studies, reference values for external conditions (temperature, ground resistivity and earthing resistance) are commonly used and considered as constants [5]. However, these values are not well adapted for all networks. It could result in non-negligible errors in network analysis. The importance of studying the impact of their environment on LV cable models and voltage profiles has been highlighted in [6]–[8]. The summary of those studies are presented in Table I.

TABLE I  
IMPACT OF EXTERNAL CONDITIONS IN THE LITERATURE

Article	External condition	Affected parameter	Limits of the study
[6]	Cable temperature	Sequence impedance	Not on line-to-neutral voltage Not with 4x4 matrix
[7]	Ground resistivity	Positive sequence impedance	
[8]	Ground resistances	Line-to-neutral voltage	Only one external condition

In [6] and [7], the impact of external conditions is only studied on sequence impedances and not on line-to-neutral voltages. It is difficult to isolate the impact of only one external factor by using the sequence impedances [9]. To highlight this impact, we propose to use the 4x4 impedance matrix. It gives a better insight of the impact of the external conditions and is able to model more accurately a LV cable. All the existing works are limited insofar as they focus on each condition separately. However, we argue that they should rather be studied jointly. To our knowledge, this work has not been done yet.

The main originality of this paper is to study the joint impact of external conditions on the line-to-neutral voltages. Moreover, our work enables DSOs to know which condition has a bigger impact on line-to-neutral voltages and to check that each network with its own particularities meets the EN 50160 standard requirements. The cable model is presented in Section II. Its dependencies to the external conditions are introduced in Section III. The test cases are described in Section IV. Results and discussions are shown in Sections V and VI.

## II. CABLE MODEL

In this section, the cable model is described. The value of cable impedance is calculated for a LV cable used in many French networks.

### A. Theoretical study

In France, LV electric cables are composed of 4 conductors (Phases A, B, C and the neutral N). As a current can flow through the ground (G), a fifth wire is considered for the cable model. This gives a 5x5 impedance matrix. However, the 5x5 impedance matrix is rarely used [10]. Usually, as the sum of the currents flowing in five wires is supposed to be zero, the 5x5 matrix is reduced to a 4x4 matrix by removing the ground wire.

$$\begin{bmatrix} V_{an}^k - V_{an}^l \\ V_{bn}^k - V_{bn}^l \\ V_{cn}^k - V_{cn}^l \\ V_{ng}^k - V_{ng}^l \end{bmatrix} = \begin{bmatrix} Z_{aa} & Z_{ab} & Z_{ac} & Z_{an} \\ Z_{ba} & Z_{bb} & Z_{bc} & Z_{bn} \\ Z_{ca} & Z_{cb} & Z_{cc} & Z_{cn} \\ Z_{na} & Z_{nb} & Z_{nc} & Z_{nn} \end{bmatrix} * \begin{bmatrix} I_a^{kl} \\ I_b^{kl} \\ I_c^{kl} \\ I_n^{kl} \end{bmatrix} \quad (1)$$

Ohm's law on a section of LV cable between  $l$  and  $k$  gives the equation (1) following the configuration given in Fig. 1.  $R_e^l$  and  $R_e^k$  are the earthing resistances of  $l$  and  $k$ .

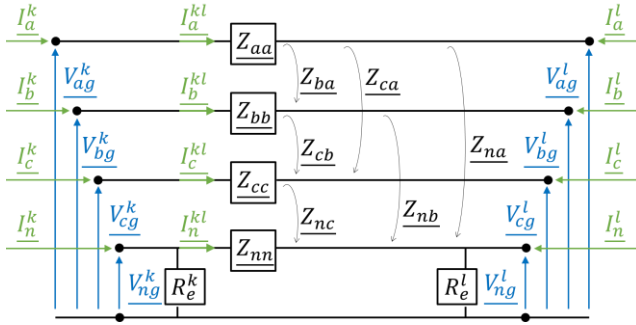

Figure 1. LV cable model

The ground wire impedance is included in the 4x4 matrix terms. We still define  $D_g$  (m), the ground radius and  $r_g$  the ground per unit length resistance equals to  $r_g = \frac{\mu_0 \omega}{8} (\Omega/m)$ . We also define  $D_{ij}$  the distance between  $i$  and  $j$  conductors (including the ground conductor),  $D_i$  (m) the geometrical mean radius given by  $D_i = e^{-1/4} R_i$  where  $R_i$  is the physical radius  $i$  of conductor, and the per unit length resistance  $r_i = \frac{\rho_i}{\pi R^2} (\Omega/m)$ .

The different terms of the 4x4 per-unit-length impedance matrix were calculated in [10]. Their expressions are as follows ( $\Omega/m$ ):

$$z_{ii} = (r_i + r_g) + j\omega \frac{\mu_0}{2\pi} * \ln \left( \frac{D_{ig} D_{gi}}{D_i D_g} \right) \quad (3)$$

$$z_{ij} = r_g + j\omega \frac{\mu_0}{2\pi} * \ln \left( \frac{D_{ig} D_{gj}}{D_{ij} D_g} \right) \quad (4)$$

Where  $i, j = a, b, c, n$  and  $i \neq j$ .

As explained in [10], it is usually to consider  $D_g = 1$  m. In this case, [11] has determined (5).

$$\frac{D_{ig} D_{gj}}{D_g} = \frac{658,9}{\sqrt{f / \rho_{ground}}} (m) \quad (5)$$

Generally, the Kron reduction can be applied to the 4x4 matrix to remove the neutral conductor and obtain a 3x3

impedance matrix [10]. In the same way, the 3x3 matrix can be transformed in a diagonal 3x3 series impedance matrix via the method of symmetrical components [10]. But, neither the Kron reduction, nor the symmetrical components transform are well adapted for such networks because of highly unbalanced currents in LV networks and asymmetry in LV cables geometry [9]. Moreover, we can no longer determine the neutral-to-ground voltage if 3x3 impedance matrices were used. We thus choose to keep the 4x4 matrix in the following sections.

### B. Analytical and finite element values

In this section, we consider the following LV cable which is used in French LV networks (Fig. 2b). The phases and neutral cross-sections are typically: 95/70, 150/95 and 240/115mm<sup>2</sup>.

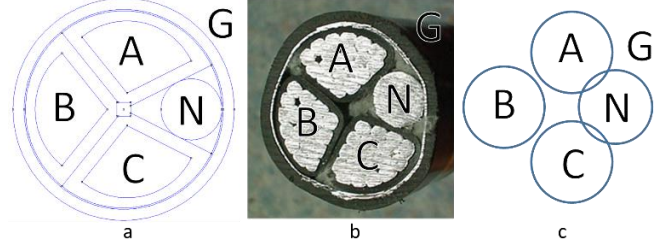

Figure 2. French 150/95mm<sup>2</sup> LV cable

- a: Picture of studied cable
- b: Finite element geometry
- c: Analytical geometry

A reference case described in [11] is considered to model LV cables and to simulate LV networks. The parameters of the reference case are defined in Table II.

TABLE II  
PARAMETERS FOR REFERENCE CASE

Cable temperature, $T$	20°C
Cable resistivity, $\rho_i$	$3.068 \times 10^{-8} \Omega m$
Ground resistivity, $\rho_g$	100 $\Omega m$
Study frequency, $f$	50 Hz

We also use this reference case to determine the 4x4 impedance matrix with analytical and finite element (FE) methods. Using analytical equations (3) and (4), the 4 x 4 matrix of 150/95mm<sup>2</sup> cable is ( $\Omega/km$ ):

$$Z_{analy} = \begin{bmatrix} 0.254 + j0.758 & 0.049 + j0.694 & 0.049 + j0.680 & 0.049 + j0.708 \\ 0.049 + j0.694 & 0.254 + j0.758 & 0.049 + j0.694 & 0.049 + j0.679 \\ 0.049 + j0.680 & 0.049 + j0.694 & 0.254 + j0.758 & 0.049 + j0.708 \\ 0.049 + j0.708 & 0.049 + j0.679 & 0.049 + j0.708 & 0.299 + j0.764 \end{bmatrix}$$

For the FE method, we consider a cable length of 1000 m and an insulation resistivity of  $10^{16} \Omega \cdot m$  modeled in the FE method magnetics (FEMM) software [10]. The mean error between analytical and FE methods is equal to 1.4%. As results of both models are similar, we consider that the analytical model has good accuracy and can be used to model the cable. We choose to keep using this model in the following sections.

### III. DEPENDENCIES ON ENVIRONMENTAL CONDITIONS

If the dependencies on environmental conditions are not considered in the previous section, this section analyses three types of external conditions: ground electrical resistivity, aluminum electrical resistivity and earthing resistances.

### A. Dependency on ground electrical resistivity

Considering (5), the imaginary parts of (3) and (4) are function of the ground resistivity. In the literature, various approaches of ground resistivity determination are proposed: geological approach [12], experimental measures [13] and manufacturers specifications [14]. They give different ranges of ground electrical resistivity. In [12], the authors describe the measurement of ground resistivity as a great method to determine soil characteristics. In that way, ground resistivity is very influenced by the soil type and varies from 1 to 10 000 Ohm-m (fig. 3).

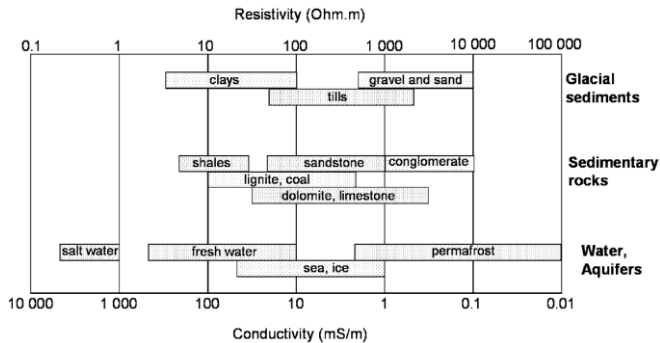

Figure 3 Typical ranges of electrical resistivity of earth materials [12]

Unfortunately, ground resistivity is also influenced by ground temperature, moisture, water conductivity and local heterogeneities (e.g. conductive pipes in the neighboring soil) [12]. It is difficult to model all these conditions to obtain a global probability density function. Moreover, the geological composition of soil is not uniform within a country.

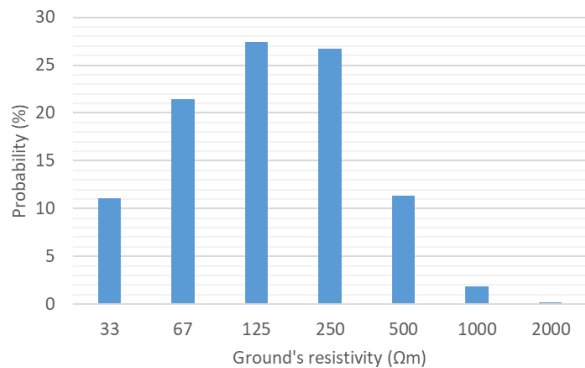

Figure 4 Probability density function of ground resistivity

Experimental measurements of ground resistivity have been conducted in the USA [13]. These measurements enabled us to draw the probability density function of ground resistivity reproduced in fig. 4. The main value of ground resistivity is around 150 Ω/m which is higher than the reference value. Finally, a manufacturer provides in Table III the ground electrical resistivity of more familiarly named soils [14].

### B. Dependency on earthing resistances

Earthing resistances do not have an impact on equations (3) and (4). However, the resistances impact the neutral-to-ground and line-to-ground voltages [8]. These resistances are function

of the soil type and the earthing techniques. Common values of earthing resistance are shown in Table III.

TABLE III  
EARTHING RESISTANCE OF DIFFERENT SOILS

Type of soil	Soil resistivity (Ω-m)	Earthing resistance (Ω)		
		Ground electrode depth		
		3 (m)	6 (m)	10 (m)
Very moist soil	30	10	5	3
Farming soil	100	33	17	10
Sandy clay soil	150	50	25	15
Moist gravel	500	160	80	48
Dry gravel	1000	330	165	100
Stoney soil	30,000	1000	500	300

### C. Dependency on aluminum electrical resistivity

This last dependency variation is better known. In fact, the real parts of (3) and (4) are a linear function of the aluminum electrical resistivity, i.e. the main cable material. Aluminum resistivity is mainly temperature dependent:

$$\rho_{alu}(T) = \rho_0 [1 + \alpha * (T - T_0)] \quad (6)$$

Where  $\alpha = 3,63 \times 10^{-3} K^{-1}$  and  $\rho_0 = 2,86 \times 10^{-8} \Omega m$  at  $T_0 = 273 K$ .

The cable temperature may vary between 0 and 100°C [4]. Intuitively, a part of this temperature variation results from Joule effect. As described in [15], pavement also has an impact on the ground and the cable temperatures. This impact is not linear and is function of the network layout. We then present a time dependent thermal FE study in the following section.

## IV. METHODOLOGY AND TEST CASES

The proportion of LV underground cables is significant in Europe. Impact of external factors described in section III cannot be directly measured. In this section, we present the method developed to analyze jointly these external effects on a 4x4 matrix and on a line-to-neutral voltage.

### A. Global approach

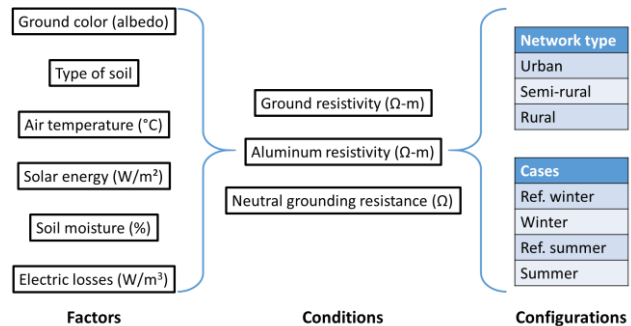

Figure 5 Factors, conditions and configurations for sensibility analysis

The three external conditions discussed before are also influenced by other external factors such as soil surface color, soil type, air temperature, solar energy, soil moisture and electric losses, as shows Fig. 5. The probability density function of all these factors is difficult to determine and all these factors are interdependent. Therefore, we consider three types of network (urban, semi-rural and rural) and simulate each of them in four types of cases (reference winter, winter, reference summer and summer).

## B. Studied networks

Parameters of the studied networks (urban, semi-rural and rural) are presented in Table IV.

TABLE IV  
LV NETWORKS TYPES PARAMETERS

Networks types	Urban	Semi-rural	Rural
Nominal power of transformer	400 kVA	250 kVA	100 kVA
Consumers number	148	31	4
Annual mean consumption	65.7 kW	24.3 kW	5 kW
Producers number	9	0	1
DER contract power	105.4 kW	0 kW	18 kW
Network length	4.0 km	4.0 km	1.0 km

These LV networks are part of the distribution dataset used in the CGMES 2.4.1 interoperability tests performed in 2016 [16]. For the ground electrical resistivity, we consider that urban, semi-rural and rural ground are respectively sandy clay soil, moist gravel and very moist soil. We also suppose that the ground electrode is 3 meters in depth and the neutral wire is not grounded at every node.

## C. Studied cases

We consider four type of cases (reference winter, winter, reference summer and summer) to illustrate the impact of the external factors. Table V gives the values of external conditions used in different configurations. Consumption and production profile are specified using data from [17] and [18]: for the 2 winter cases, we consider the most critical moments of winter, i.e. the 24 highest successive consumption values in winter (winter profile), and for the 2 summer cases, we consider the most critical moments of summer, i.e. the 24 highest production values in summer (summer profile). The calculated temperature in the more realistic cases are from a COMSOL time dependent thermal model.

TABLE V  
VALUES OF EXTERNAL CONDITIONS IN DIFFERENT CONFIGURATIONS

	Urban	Semi-rural	Rural
<b>Ref. winter</b>	$R_e = 1\Omega$ $T_{cable} = 20^\circ C$ $\rho_g = 100 \Omega m$ winter profile	$R_e = 1\Omega$ $T_{cable} = 20^\circ C$ $\rho_g = 100 \Omega m$ winter profile	$R_e = 1\Omega$ $T_{cable} = 20^\circ C$ $\rho_g = 100 \Omega m$ winter profile
<b>Winter</b>	$R_e = 1\Omega$ $T_{cable} = 35^\circ C$ $\rho_g = 150 \Omega m$ winter profile	$R_e = 1\Omega$ $T_{cable} = 25^\circ C$ $\rho_g = 500 \Omega m$ winter profile	$R_e = 1\Omega$ $T_{cable} = 15^\circ C$ $\rho_g = 30 \Omega m$ winter profile
<b>Ref. summer</b>	$R_e = 1\Omega$ $T_{cable} = 20^\circ C$ $\rho_g = 100 \Omega m$ summer profile	$R_e = 1\Omega$ $T_{cable} = 20^\circ C$ $\rho_g = 100 \Omega m$ summer profile	$R_e = 1\Omega$ $T_{cable} = 20^\circ C$ $\rho_g = 100 \Omega m$ summer profile
<b>Summer</b>	$R_e = 50\Omega$ $T_{cable} = 65^\circ C$ $\rho_g = 150 \Omega m$ summer profile	$R_e = 160\Omega$ $T_{cable} = 50^\circ C$ $\rho_g = 500 \Omega m$ summer profile	$R_e = 10\Omega$ $T_{cable} = 35^\circ C$ $\rho_g = 30 \Omega m$ summer profile

## V. RESULTS

The load flow is computed by EPRI's OpenDSS [19] on the three test networks presented previously. We analyze the impact of external conditions on voltage limits and voltage unbalance of the 24 summer moments and 24 winter moments.

### A. Voltage limits

A voltage problem occurs when a line-to-neutral voltage exceeds the range of  $\pm 10\%$ , Fig. 6 and 7 show the ratio of voltage problem  $\tau_v$  defined in (7).

$$\tau_v = \frac{N_{pbr}}{N_{node} * N_{phase} * N_{moment}} \quad (7)$$

Where  $N_{pbr}$ : the number of voltage problems,  $N_{node}$ : number of nodes,  $N_{phase}$ : the number of phases and  $N_{moment}$ : the number of studied moments.

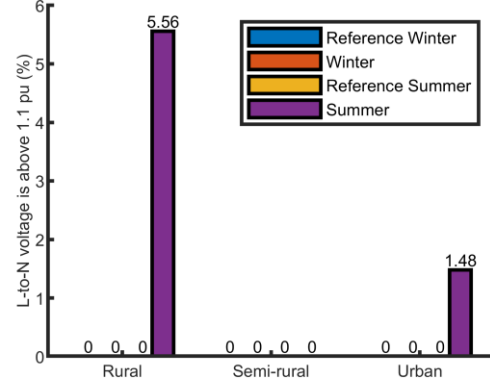

Figure 6 Percentage of upper voltage problem

In Fig. 6, the upper limit of the standard is exceeded only in summer. Production units are only connected to the urban and rural networks. Hence, the presence of producers increases the risk to exceed the EN 50160 standard requirements in summer. The increase is higher in the rural than in the urban network.

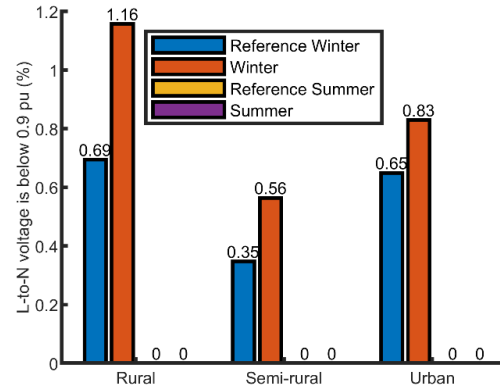

Figure 7 Percentage of lower voltage problem

In Fig. 7, the lower limit is never reached in summer. In all networks, the number of cases where line-to-neutral voltages are below 0.9 pu rises from the reference winter case to the winter case. The increase is similar in the rural and in the semi-rural networks but higher than in the urban network.

### B. Voltage unbalance

A voltage unbalance problem occurs when the negative-sequence voltage is above 2% of the positive-sequence voltage. Fig. 8 shows the ratio of voltage problem  $\tau_v$  defined in (7). The impact of external conditions is visible in the urban network, where the number of critical situations rises from 1.33% to 1.84% in winter. In the other situations, the impact is negligible.

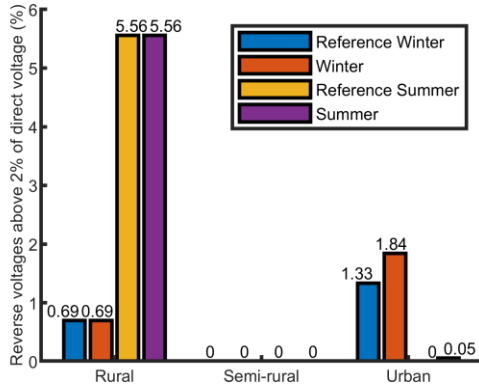

Figure 8 Percentage of voltage unbalance problem

### C. Results analysis

We also study the impact of temperature alone on the 4x4 impedance matrix and on the voltage profile. Only the real part of  $z_{aa}$  is influenced by the cable temperature [10]. Table VI shows the proportionality of these quantities in regards to the temperature in the rural network. Similar results are obtained for the two other networks.

TABLE VI  
IMPACT OF CABLE TEMPERATURE ON PER-UNIT LENGTH RESISTANCE AND AVERAGE VOLTAGE

	20°C	40°C	100°C
Variation of $Re(z_{aa})$	Default	+6.07%	+24.33%
Variation of average voltage	Default	+0.15%	+0.62%

The impact of external conditions is easily observable by using the 4x4 impedance matrix [10] instead of using the diagonal 3x3 series impedance matrix [6], [7]. However, the impact of external conditions on voltage problems depends also on the network type. Rural network feeders are often longer than urban network ones and their cable cross-sections are often smaller. Hence, line-to-neutral voltages of rural networks are usually closer to the EN 50160 standard voltage limits than urban networks. Thus the impedance matrix of rural networks should be known with higher precision than that of urban networks.

## VI. CONCLUSION

In this paper, the impact of three external conditions on the voltage profile of three LV networks is jointly studied. For each network, four cases are considered: winter, reference winter, summer, and reference summer. The results show that some voltage problems cannot be seen by using only usual values of those external conditions. By considering the values that are closer to the real conditions, the cable model parameters can be more accurately estimated. As a result, the voltage analysis will be more accurate and in some cases, additional problems can be detected. The authors recommend the use of 4x4 impedance matrix with an earthing resistance instead of the sequence impedances to describe more precisely LV networks. Besides, results show also that rural and some semi-rural networks are more prone to voltage problems than urban networks. To be sure that the EN50160 standard is met, a global study of LV

networks including the external conditions should be done. In practice, it is difficult to determine the exact value of external conditions for each network or each cable section. Then a LV parameter estimator could be an interesting solution to deal with this problem.

## REFERENCES

- [1] Y. Liu *et al.*, "Distribution network voltage control by active power/reactive power injection from PV inverters," in *2018 13th IEEE Conference on Industrial Electronics and Applications (ICIEA)*, 2018, pp. 543–547.
- [2] European Commission, "Electricity network codes and guidelines," *Energy - European Commission*, 23-Oct-2014. [Online]. Available: <https://ec.europa.eu/energy/en/topics/markets-and-consumers/wholesale-market/electricity-network-codes>. [Accessed: 08-Apr-2019].
- [3] D. F. Frame, G. W. Ault, and S. Huang, "The uncertainties of probabilistic LV network analysis," in *2012 IEEE Power and Energy Society General Meeting*, 2012, pp. 1–8.
- [4] A. Angioni, J. Shang, F. Ponci, and A. Monti, "Real-Time Monitoring of Distribution System Based on State Estimation," *IEEE Transactions on Instrumentation and Measurement*, vol. 65, no. 10, pp. 2234–2243, Oct. 2016.
- [5] W. H. Kersting, "A three-phase unbalanced line model with grounded neutrals through a resistance," in *2008 IEEE Power and Energy Society General Meeting - Conversion and Delivery of Electrical Energy in the 21st Century*, 2008, pp. 1–2.
- [6] A. Urquhart, "Accuracy of Low Voltage Electricity Distribution Network Modelling," PhD thesis, Loughborough University, 2016.
- [7] H. Keshtkar, S. K. Solanki, and J. M. Solanki, "Improving the Accuracy of Impedance Calculation for Distribution Power System," *IEEE Transactions on Power Delivery*, vol. 29, no. 2, pp. 570–579, Apr. 2014.
- [8] F. Olivier, R. Fonteneau, and D. Ernst, "Modelling of three-phase four-wire low-voltage cables taking into account the neutral connection to the earth," Jun. 2018.
- [9] L. Moreno-Díaz, E. Romero-Ramos, A. Gómez-Expósito, E. Cordero-Herrera, J. R. Rivero, and J. S. Cifuentes, "Accuracy of Electrical Feeder Models for Distribution Systems Analysis," in *2018 International Conference on Smart Energy Systems and Technologies (SEST)*, 2018, pp. 1–6.
- [10] F. Binot, T. D. Le, and M. Petit, "Modélisation de l'impédance des câbles : Étude de sensibilité et impact sur le réseau BT," in *Symposium de Génie Electrique*, 2018.
- [11] A. J. Urquhart and M. Thomson, "Series impedance of distribution cables with sector-shaped conductors," *Transmission Distribution IET Generation*, vol. 9, no. 16, pp. 2679–2685, 2015.
- [12] A. Samouëlian, I. Cousin, A. Tabbagh, A. Bruand, and G. Richard, "Electrical resistivity survey in soil science: a review," *Soil and Tillage Research*, vol. 83, no. 2, pp. 173–193, Sep. 2005.
- [13] Rural Electrification Administration, "REA BULLETIN," 1751F–802, Dec. 1994.
- [14] FLUKE, "Earth Grounding Resistance." [Online]. Available: [https://dam-assets.fluke.com/s3fs-public/4346628\\_0000\\_ENG\\_C\\_W.PDF](https://dam-assets.fluke.com/s3fs-public/4346628_0000_ENG_C_W.PDF). [Accessed: 13-Nov-2018].
- [15] H. Li, J. T. Harvey, T. J. Holland, and M. Kayhanian, "The use of reflective and permeable pavements as a potential practice for heat island mitigation and stormwater management," *Environ. Res. Lett.*, vol. 8, no. 1, p. 015023, 2013.
- [16] Entsoe, "INTEROPERABILITY TEST 'CIM FOR SYSTEM DEVELOPMENT AND OPERATIONS' 2016," European Network of Transmission System Operators for Electricity, Jul. 2016.
- [17] Commission for Energy Regulation, "Results of electricity cost-benefit analysis, customer behavior trials and technology trials. Technical report," Dublin, 2011.
- [18] Commission for Energy Regulation, "Electricity smart metering customer behavior trials findings report. Technical Report," Dublin, 2011.
- [19] "OpenDSS," *SourceForge*. [Online]. Available: <https://sourceforge.net/projects/electricdss/>. [Accessed: 03-Dec-2018].