



**HAL**  
open science

# The effect of multi-walled carbon nanotubes on the mechanical behavior of basalt fibers metal laminates: An experimental study

Hamed Aghamohammadi, Reza Eslami-Farsani, Abbas Tcharkhtchi

## ► To cite this version:

Hamed Aghamohammadi, Reza Eslami-Farsani, Abbas Tcharkhtchi. The effect of multi-walled carbon nanotubes on the mechanical behavior of basalt fibers metal laminates: An experimental study. *International Journal of Adhesion and Adhesives*, 2020, 98, pp.102538. 10.1016/j.ijadhadh.2019.102538 . hal-03001516

**HAL Id: hal-03001516**

**<https://hal.science/hal-03001516>**

Submitted on 12 Nov 2020

**HAL** is a multi-disciplinary open access archive for the deposit and dissemination of scientific research documents, whether they are published or not. The documents may come from teaching and research institutions in France or abroad, or from public or private research centers.

L'archive ouverte pluridisciplinaire **HAL**, est destinée au dépôt et à la diffusion de documents scientifiques de niveau recherche, publiés ou non, émanant des établissements d'enseignement et de recherche français ou étrangers, des laboratoires publics ou privés.

# The effect of multi-walled carbon nanotubes on the mechanical behavior of basalt fibers metal laminates: An experimental study

Hamed Aghamohammadi<sup>a</sup>, Reza Eslami-Farsani<sup>a,\*</sup>, Abbas Tcharkhtchi<sup>b</sup>

<sup>a</sup> Faculty of Materials Science and Engineering, K. N. Toosi University of Technology, Tehran, Iran

<sup>b</sup> Laboratoire D'ingénierie des Matériaux, ENSAM, Paris, France

## A B S T R A C T

### Keywords:

Fiber metal laminates  
Multi-walled carbon nanotubes  
Adhesion  
Flexural properties  
High-velocity impact behavior

Fiber metal laminates (FMLs) are a group of hybrid composite materials consisting of metal and fiber-reinforced polymer layers. In this study, the effects of multi-walled carbon nanotubes (MWCNTs) on the flexural and high-velocity impact behavior of FMLs made up of aluminum 2024-T3 and basalt fibers/epoxy layers were investigated. The fracture surfaces of samples were analyzed by scanning electron microscopy (SEM). Results showed that the adhesion of composite plies, as well as the interfaces between aluminum and basalt fibers/epoxy layers, were significantly affected by the inclusion of the MWCNTs. The good adhesion of MWCNTs within the body of FMLs caused considerable improvement in the flexural properties. In this regard, the optimal content of MWCNTs was 0.5 wt%, and compared to the samples without MWCNTs, the flexural strength and flexural modulus values improved 36.62% and 60.16%, respectively. However, contrary to the effectiveness of MWCNTs on the flexural performance of samples, the high-velocity impact properties in terms of specific absorbed energy and limit velocity values were affected adversely.

## 1. Introduction

Fiber-reinforced polymer (FRP) composites, because of their unique properties such as high specific strength, high resistance to fatigue loading and ease of processability, have been extensively used in many industries. However, the weak interlaminar shear strength of FRPs has made them susceptible to impact loading. In addition, many researchers have attempted to overcome these issues through various approaches. It is well known that modification of polymeric matrixes through the addition of nanofillers is one of the commonly used methods. Recently, to improve the mechanical, thermal and electrical properties of polymer composites, using nanoparticles such as carbon nanotubes (CNTs), nanoclay and graphene nanoplatelets (GNPs) have attracted a great deal of attention [1–5].

Before the introduction of graphene in 2004, to modify the properties of polymer composites, use of CNTs, owing to their unique mechanical, electrical and thermal properties, attracted the most attention of researchers. It is well understood that the mechanical properties of CNT-based nanocomposites can be improved through various mechanisms such as CNT pull-out, CNT bridging, CNT rupture and plastic void growth [6].

The positive roles of CNTs to enhance the mechanical properties of polymer composites have been confirmed by several studies. For example, the effect of MWCNTs on the mechanical properties of carbon fibers reinforced polymer (CFRP) composites was studied by Tehrani et al. [7]. They showed that during tensile testing, the MWCNT/CFRPs composites exhibited higher strain to failure behavior, compared to the neat sample. Furthermore, their average toughness value also increased up to 21.3%.

Contrary to expectations that the use of CNTs can always improve the mechanical properties of polymer composites, some researchers have reported different results. For example, Shokreih et al. [8] studied the influence of CNTs on the mechanical properties of chopped strand mat/polyester composites. Their results demonstrated that the inclusion of CNTs into the polymer composites did not have a significant effect on the tensile strength, although the flexural strength and modulus were significantly improved. In another study, Li et al. [9] demonstrated that the use of CNTs at low concentrations improved the tensile strength, elastic modulus and strain to failure of polymeric composites, but high loading of CNTs showed adverse effects.

The detrimental effect of CNTs can be attributed to some problems that are discussed here. Uniform dispersion of CNTs into any polymer

\* Corresponding author.

E-mail address: [eslami@kntu.ac.ir](mailto:eslami@kntu.ac.ir) (R. Eslami-Farsani).

matrix (or avoiding agglomeration) is one of the major challenges in preparing CNT-based composites. Agglomeration is mainly caused by high concentration of CNTs in composites, acting as a defect and leading to degradation of the mechanical properties [10–12]. Tarfaoui et al. [11] examined the effect of different volume fractions of CNTs on the tensile properties of polymer composites. Their findings revealed that the addition of CNTs resulted in the degradation of mechanical properties. Furthermore, they reported that CNTs did not have any effects on stiffness values.

In another study, Zhou et al. [12] investigated the mechanical behavior of epoxy/CNTs nanocomposites. They observed an increasing trend in the composite modulus as a function of CNTs loading, but the flexural strength degraded with 4 wt% CNTs. They attributed the increment in the strength and flexural modulus at smaller CNT loadings to the restriction of the polymer chains mobility.

Increasing the polymer's viscosity is another problem of CNT-based systems, causing the incomplete degassing of bubbles and voids formation during the curing process [3,10,12,13]. Gojny et al. [10] pointed out that the inclusion of double-walled CNTs into the epoxy resin resulted in the reduction of mechanical properties. Degradation of mechanical properties of CNT/epoxy composites was attributed to the incomplete degassing in their study. In another similar study, the high-velocity impact behavior of amino-functionalized multi-walled CNTs (NH<sub>2</sub>-MWCNTs) reinforced E-glass/epoxy composites was evaluated by Rahman et al. [13]. In comparison to the neat composites, absorbed energy, limit velocity and damage area values of composites were increased using 0.3 wt% NH<sub>2</sub>-MWCNTs. However, the addition of MWCNTs at 0.5 wt% had a detrimental effect on the high-velocity impact behavior of the composites. The negative effect of MWCNTs at 0.5 wt% loading was related to the agglomeration and increased resin's viscosity.

The low-velocity impact behavior of MWCNTs/CFRP composites with different impact energy levels was studied by Kotsiopoulos et al. [14]. Their results indicated that the impact behavior of composites was not significantly affected by the addition of CNTs.

The impact properties of polymeric composites can also be improved by incorporating them in fiber metal laminates (FMLs). FMLs are a class of hybrid composites consisting of alternating thin laminates of metals and FRPs, whose hybrid benefits include superior wear strength, impact and fatigue resistance [15–17]. Because of their outstanding properties, FMLs have attracted great applications in the fabrication of the aircraft components [17].

It has been reported that about 13% of total repairs of aircraft components are due to the impact collisions of different bodies. Therefore, extensive experimental and analytical investigations regarding the impact behavior of FMLs have been performed. The effects of various parameters such as metals and fibers' type, metal volume fraction, stacking sequence, scaling effects, etc. on the impact behavior of FMLs have been studied [15,16].

There are few studies on the influence of nanoparticles on the mechanical properties of adhesive joints [18–20]. The effect of MWCNTs on the flexural properties and low-velocity impact behavior of glass reinforced aluminum laminates (GLARE) was studied by Zhang et al. [21]. They reported that the flexural strength and flexural modulus values were respectively improved by 40.3% and 24.8% using 0.5 wt% MWCNTs into the epoxy resin. Additionally, they observed that, in contrast to the other samples, because of the occurrence of rebounding phenomenon, the impact energy was not fully absorbed in the samples with 0.5 and 1 wt% MWCNTs.

The effects of adding pristine and NH<sub>2</sub>-functionalized graphene on the low-velocity impact performance of a FML made up of 3D-glass fabric and magnesium sheets were investigated by Asaee et al. [22]. Their results indicated that the addition of pristine graphene did not have a considerable effect on the impact behavior of samples but the addition of 0.5 and 1 wt% NH<sub>2</sub>-graphene greatly improved their impact behavior in terms of contact force and absorbed energy. On other hands,

the results of Dizaji et al. [23] were in contrast to those observed by Asaee et al. Dizaji et al. conducted a comparative study regarding the low-velocity impact response of FMLs consisting of 3D-woven glass fabric and aluminum 2024-T3 containing graphene and silica nanoparticles. They reported that graphene promoted better impact performance compared to silica nanoparticles. However, they reported that the impact behavior of FMLs without nanoparticles was better than those of samples with nanoparticles. In their article, the restriction of damage area via incorporation of nanoparticles was introduced as the main reason for such a behavior. Based on the available studies in the literature, this study aimed to investigate the effect of MWCNTs on the static and dynamic behavior of FMLs using flexural and high-velocity impact testing.

## 2. Experimental procedures

### 2.1. Materials and fabrication of samples

The materials used for the fabrication of samples were aluminum alloy grade 2024-T3 with 0.5 mm thickness, woven basalt fibers (BAS 350.1270.A, Basaltex, Belgium) and epoxy resin (Epon 828, with hardener TETA). The resin to hardener ratio was 100:13 by weight, as recommended by the manufacturer. Carboxyl-functionalized MWCNTs (COOH-MWCNTs) were provided by Cheap Tubes Inc., USA.

To obtain the proper dispersion of MWCNTs into the epoxy resin, the mixtures of epoxy and MWCNTs at different weight percentages (0, 0.1, 0.25, 0.5 and 0.75) were ultrasonically homogenized using a probe of 14 mm tip diameter, at 320 W for 60 min duration (Ultrasonic homogenizer 400 W, 24 kHz, FAPAN Co., Ltd., Iran).

Prior to lamination, to create strong interfacial bonding between aluminum and basalt fibers/epoxy layers, sulfuric acid anodizing was applied to the aluminum sheets for 20 min. The FMLs with 2/1 configurations were fabricated by hand lay-up method. The interlayer consisted of 4 layers of basalt fibers reinforced epoxy resin. After laminating, the samples were placed in a steel-mold for curing step at ambient temperature. Applying pressure of 0.15 MPa resulted in the reduction of bubbles and removal of excess resin. Fig. 1 shows the schematic illustration of fabricated samples showing their shape and dimensions.

### 2.2. Mechanical testing and characterization

To evaluate the effect of MWCNTs on the flexural properties of FMLs, triple point bend testing was conducted at ambient temperature, according to the ASTM D790. KOPA Universal Testing Machine TB-10T was employed to conduct the tests. The flexural strength and flexural modulus values of samples were calculated using equations (1) and (2), respectively.

$$\sigma_f = \frac{3PL}{2bd^2} \quad (1)$$

And

$$E_b = \frac{L^3 m}{4bd^3} \quad (2)$$

Where  $\sigma_f$  is the flexural strength (MPa),  $E_b$  is the modulus of elasticity in bending (MPa), P is the maximum load (N) in the load-deflection curves, L is the support span (mm), b is the width of beam tested (mm), d is the depth of beam tested (mm) and m is slope of the tangent to the initial straight-line portion of the load-deflection curve (N/mm).

High-velocity impact testing was conducted by a gas gun on the FMLs with the 130 × 130 mm<sup>2</sup> size specimens. An aluminum-projectile with conical shape (21.5 mm in diameter and 26.86 g in mass) was used in the testing. In addition, to investigate the effect of projectile shape on the high-velocity impact behavior of FMLs, a hemispherical projectile (21.5

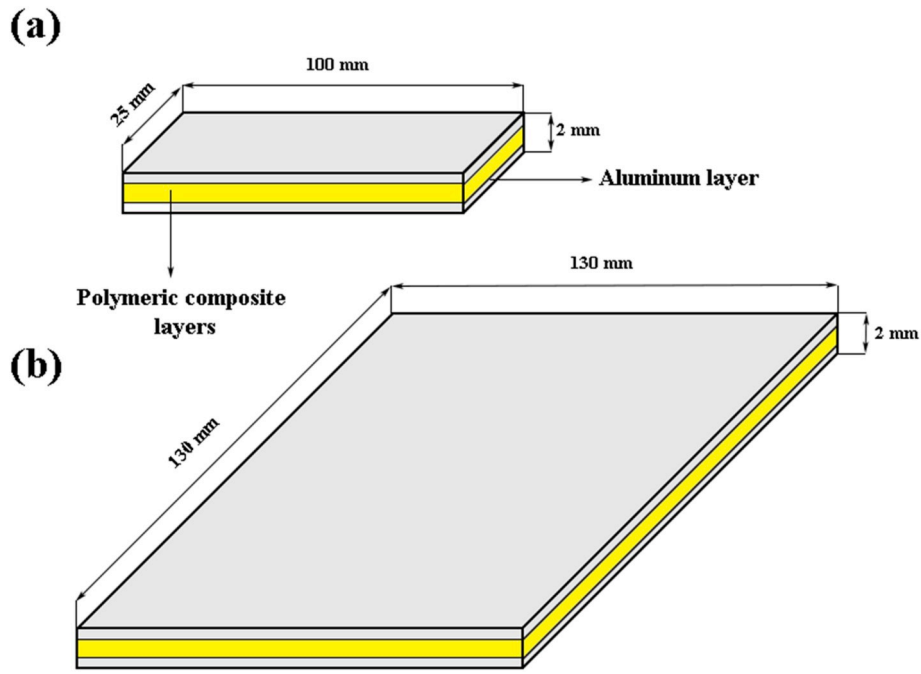

Fig. 1. The schematic illustration of samples for (a) flexural testing and (b) high-velocity impact testing.

mm in diameter and 26.94 g in mass) was used. The specific absorbed energy (J/g) of samples was calculated according to equation (3).

$$\text{Specific absorbed energy} = \frac{\frac{1}{2}mV_i^2 - \frac{1}{2}mV_r^2}{M} \quad (3)$$

Where  $m$  is the projectile mass (g),  $V_i$  is the initial velocity of the projectile (m/s),  $V_r$  is the residual velocity of the projectile (m/s) and  $M$  is the sample's mass (g). Furthermore, the limit velocity (m/s) value of samples after perforation occurrence was calculated according to equation (4).

$$\text{Limit velocity} = \sqrt{V_i^2 - V_r^2} \quad (4)$$

Additionally, to characterize the surface morphology of aluminum surface, the interface and fracture surface of FMLs, scanning electron microscopy (SEM) and field emission SEM (FESEM) were used (TESCAN).

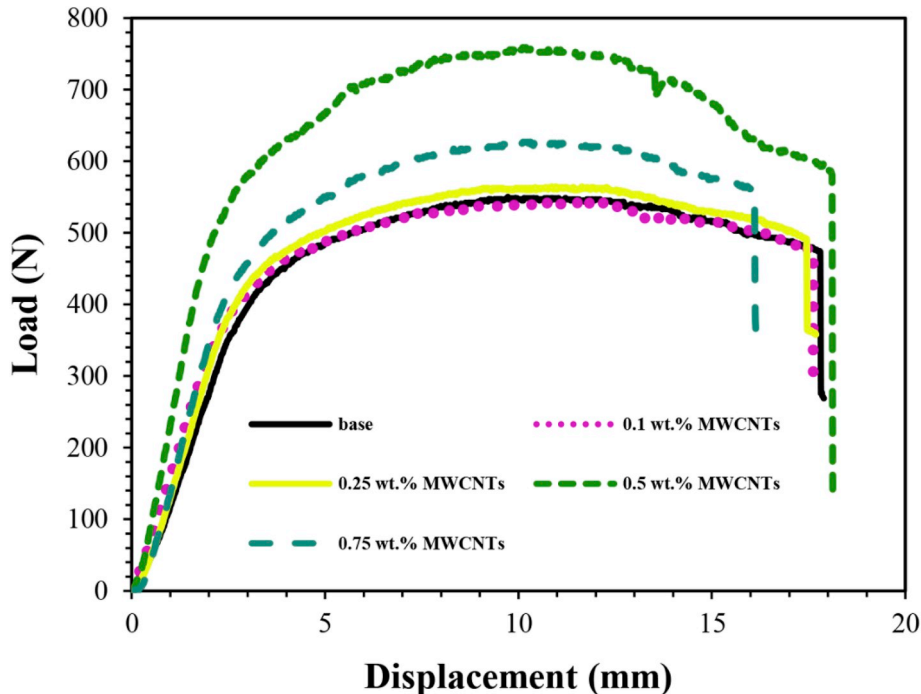

Fig. 2. The load-displacement curves obtained from flexural testing of basalt fibers/epoxy/aluminum 2024 laminates with different content of MWCNTs.



### 3. Results and discussion

#### 3.1. Flexural testing

The flexural load-displacement curves of the samples containing different weight percentages of MWCNTs are illustrated in Fig. 2. Two regions of elastic and plastic deformation are visible for the FMLs during flexural testing. Due to the presence of the aluminum sheets, the flexural load after reaching the maximum value can be plastically sustained until the occurrence of cracking in the aluminum layer. It is important to note that after sulfuric acid anodizing, a porous structure of the alumina layer is formed on the surface of aluminum sheets. As observed in Fig. 3, the surface morphology of the aluminum consisted of microscale pits and much smaller pores, after sulfuric acid anodizing. Both pits and pores on the alumina layer are the proper and relatively uniform sites for the infiltration of the epoxy resin. This phenomenon causes the development of strong adhesion within the interlayers of aluminum and polymeric composites, hindering the occurrence of interfacial debonding (Fig. 4).

From the load-displacement curves (Fig. 2), the flexural strength and flexural modulus values were calculated and are graphically presented in Fig. 5. The flexural strength (547.665 MPa) of FMLs with 0.1 wt% MWCNTs was lower than that of the base sample (557.786 MPa). In other words, the incorporation of MWCNTs at low concentrations (i.e. 0.1 and 0.25 wt%) did not have a significant effect on the flexural properties. Among all samples, the maximum flexural strength of 757.061 MPa was achieved for the FMLs with 0.5 wt% MWCNTs; the flexural strength and flexural modulus values were respectively enhanced to 36.62% and 60.16%, in comparison to the base sample.

However, in the case of FMLs with 0.75 wt% loading, although flexural strength and modulus were higher, the samples broke at lower displacement (16.102 mm), compared to the base sample (17.801 mm). In summary, it can be expressed that the flexural strength and modulus of samples had an upward enhancement up to 0.5 wt% loading, but beyond that a downward trend was observed. These results are consistent with the Zhang et al. [21] study.

In comparison with the base sample, the significant improvement in the flexural properties of FMLs containing MWCNTs is attributed to the microstructural evolution of the matrix and aluminum/epoxy interface [24,25]. In the case of CNT-based nanocomposites, the pull-out, bridging, debonding and subsequent plastic void growth are the main dominant strengthening and toughening mechanisms. Fig. 6 shows the various strengthening mechanisms in the MWCNTs-filled adhesive system, affecting the FML's properties. The MWCNTs crack bridging and breakage are clearly illustrated in Fig. 6-a (yellow arrows). Crack

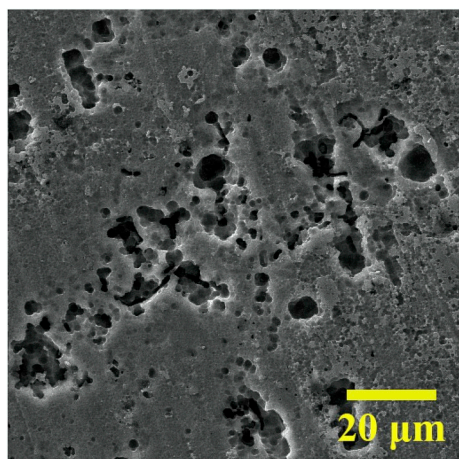

Fig. 3. SEM image of surface morphology of Al2024 after sulfuric acid anodizing.

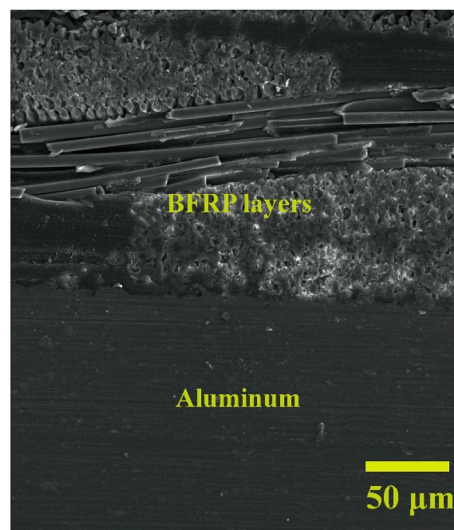

Fig. 4. SEM image of interface between aluminum 2024 and basalt fibers/epoxy layers.

bridging hinders the crack opening occurrence. Also, MWCNT rupturing provides sufficient evidence for the presence of strong bonding between MWCNTs and epoxy resin.

MWCNTs pull-out is another observed mechanism shown in Fig. 6-b. The circles in Fig. 6-b indicate the MWCNTs pull-out from the epoxy resin, implying the occurrence of plastic void growth mechanism. Plastic void growth, which occurs after nanoparticle debonding, is one of the main strengthening mechanisms for composites containing CNTs. In fact, the absorbed energy rises through the debonding and subsequent plastic void growth, improving the mechanical properties of samples. As observed in Fig. 6b, the void diameter range (100–300 nm) is larger than that of the as-received MWCNTs (10–20 nm). This observation indicated that the debonding at the MWCNTs/epoxy interface was followed by plastic deformation of the epoxy matrix, due to the strong bonding between MWCNTs and epoxy matrix. Again, the circles shown on the fracture surface of samples confirm the occurrence of plastic void growth. It is worth noting that not any critical agglomeration regions were observed on the fracture surface of MWCNTs-FMLs. Therefore, it can be deduced that utilizing COOH-MWCNTs, owing to its functional groups, provided good interaction between epoxy and MWCNTs and so, enhances the mechanical properties of FMLs.

Moreover, the rough fracture surface of basalt fibers/epoxy with 0.5 wt% MWCNTs is visible in Fig. 6-d. The higher surface area provided superior interfacial bonding within the aluminum and BFRP layers. This phenomenon provided enhanced properties by hindering crack initiation and growth in the FMLs. The fracture surface of basalt fibers/epoxy composites with 0.5 wt% loading is illustrated in Fig. 7. Microscale cracks are visible in Fig. 7-a that could be caused by the stress concentration build-up around MWCNTs in the vicinity of basalt fibers, which is unfavorable for mechanical properties of polymeric composites. Partial agglomeration and MWCNTs-bridging are also observed in Fig. 7-b and 7-c, respectively.

According to load-displacement curves (Fig. 2), it seems that the increasing tendency for flexural properties of FMLs stopped around 0.5 wt% MWCNTs loading. The negative effect of MWCNTs at higher loadings may be attributed to the following phenomena:

At first, the high concentration of MWCNTs in the epoxy resin probably led to their agglomeration. Secondly, increasing the concentration of MWCNT in polymer led to the increment of the polymer's viscosity causing some serious problems such as void formation and poor wettability of fibers by resin. In other words, the high viscosity of the epoxy resin resulted in inappropriate impregnation of basalt fibers.

The third reason is related to the interface characteristics of FMLs. As

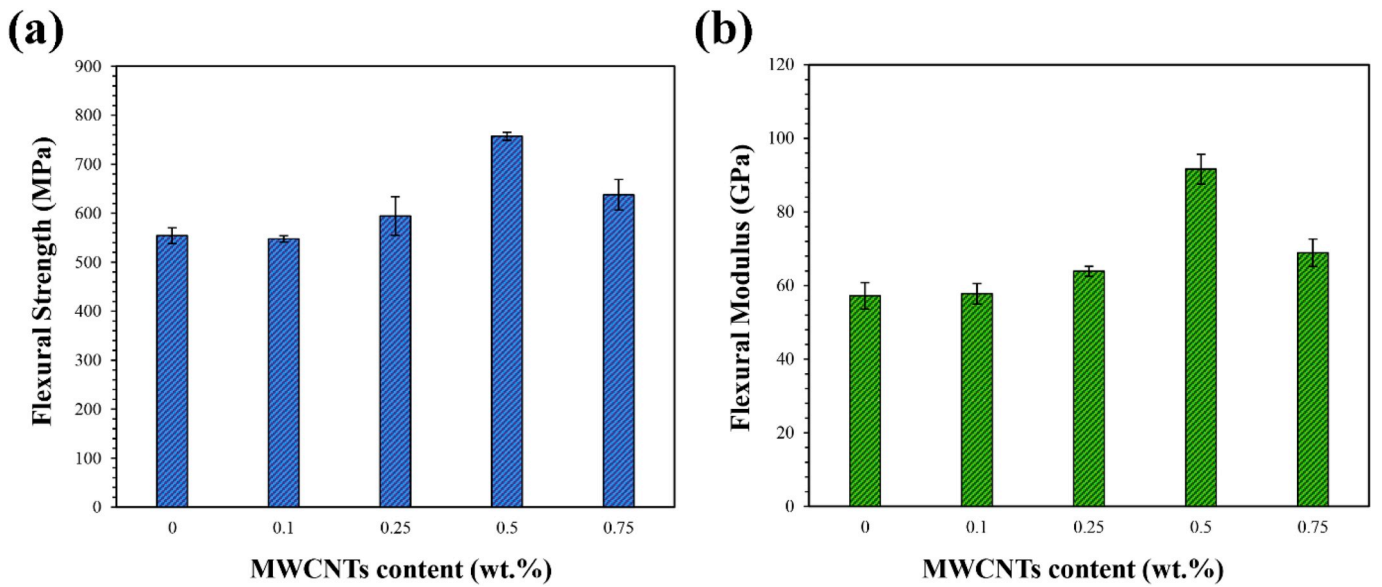

Fig. 5. Results of flexural testing for basalt fibers/epoxy/aluminum 2024 FMLs with different content of MWCNTs (a) flexural strength and (b) flexural modulus.

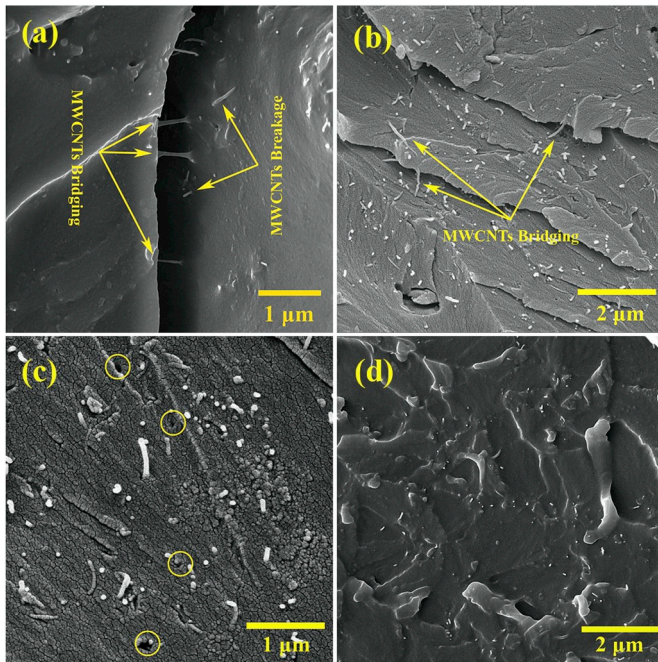

Fig. 6. The FESEM images of strengthening mechanisms of basalt fibers/epoxy composite containing 0.5 wt% MWCNTs (a) MWCNTs-crack bridging, (b) MWCNTs-pull-out and bridging, (c) plastic void growth and (d) rough fracture surface.

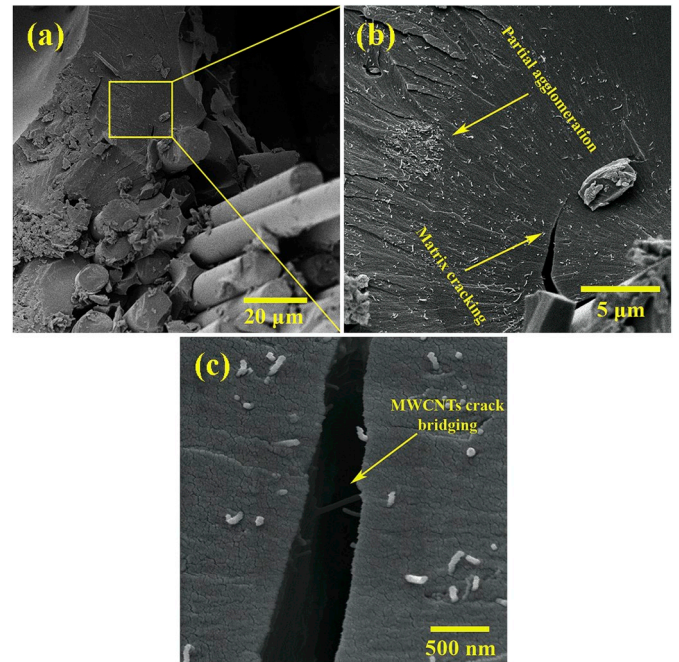

Fig. 7. FESEM images of fracture surface of basalt fibers/epoxy composite containing 0.5 wt% MWCNTs at magnifications of (a) 2000X, (b) 10000X and (c) 75000X.

mentioned earlier, the pits and pores of the anodized aluminum are appropriate sites for penetration of the epoxy resin, resulting in strong adhesive bonding [24]. Therefore, it seems that the penetration of MWCNTs in these sites can have a significant influence on the interface properties of FMLs. However, it seems that there should be an optimum content of MWCNTs for the best adhesive strength (0.5 wt% in this study). Thereby, there is a strong probability that the pores of alumina are almost filled by MWCNTs, ending up at the interface. These MWCNTs act as defects and cause degradation of adhesion at the aluminum and polymeric interfacial layers. Therefore, the lower flexural behavior of FMLs with 0.75 wt% MWCNTs can be related to the higher chance of agglomeration at metal/polymer interface, compared to FMLs

with 0.5 wt% MWCNTs. This phenomenon has also been observed by Meguid et al. [26]. They studied the role of CNTs and alumina nanoparticles on the mechanical properties of the adhesive joints between carbon fibers/epoxy and aluminum 6061. They reported that the nanofillers up to certain content strongly improved the mechanical properties of the adhesive joints but beyond that, the properties were degraded. The negative effect of nanoparticles was attributed to the inappropriate infiltration of the nanoparticles in the sites at the interface.



### 3.2. High-velocity impact testing

#### 3.2.1. Effect of projectile shape

Figs. 8 and 9 show the damage mode of base FMLs impacted by the hemispherical and conical projectiles, respectively. It is well known that the impact energy can be absorbed through various mechanisms of membrane stretching of metal layers, plugging in laminate that are caused mainly by shear, fibers' fracture, debonding and petaling in the aluminum layer on the distal side of laminate [27–29].

In Fig. 8, the global deformation and debonding between aluminum and basalt fibers/epoxy composite layers caused by the impact of hemispherical projectile is observed. Moreover, a crack in the distal side of aluminum that is aligned with the rolling direction of aluminum is observed. This crack is attributed to the different properties of the aluminum layer between this direction and its perpendicular direction. For the hemispherical impactor, the impact energy is absorbed via shear forces, while membrane stretching is the main absorbing mechanism for the conical projectile. Generally, the energy of the hemispherical-shaped projectile is propagated to high surface area of the samples, causing debonding. For the conical-shaped projectile, however, the energy of the projectile is concentrated in the small region, causing perforation in the sample. For the same incident velocity (118 m/s in this study), although using conical impactor caused to fully perforation of FMLs (Fig. 9), hemispherical impactor led to the formation of a crack on the distal side of aluminum and debonding of the FMLs. This observation suggests that limit velocity value for the hemispherical projectile is higher than that of conical impactor. These results are in good agreement with the Zarei et al. [29] study.

#### 3.2.2. Effect of MWCNTs

The high-velocity impact results are summarized in Table 1. The specific absorbed energy and limit velocity of samples are also calculated and graphically presented in Fig. 11. Contrary to the flexural results, a downward trend in the specific absorbed energy and limit velocity values is observed up to 0.5 wt% MWCNTs; despite the best flexural properties, the specific absorbed energy and limit velocity values are respectively 1.218 J/g and 82.873 m/s, the lowest values among all samples. The FMLs containing 0.75 wt% MWCNTs, contrary with the other MWCNTs-FMLs, has a comparable impact behavior to the base sample. Failure modes of front and back of FMLs with different wt. % MWCNTs are presented in Figs. 11 and 12, respectively.

Considerable information can be obtained by comparing the back

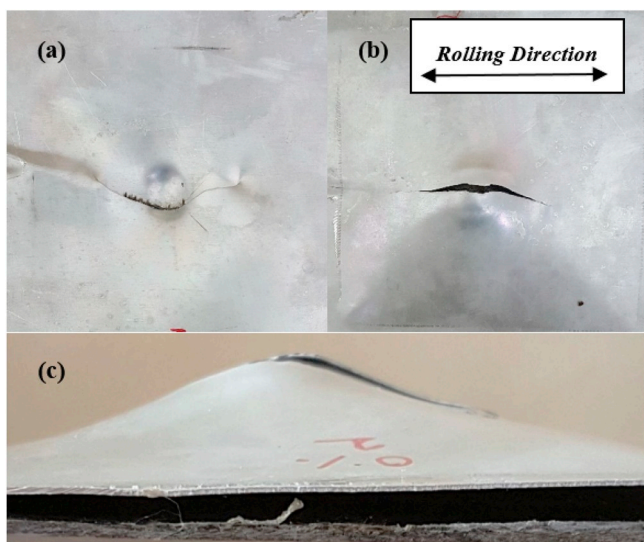

Fig. 8. Damage mode of FMLs impacted by hemispherical projectile (a) front face, (b) back face and (c) cross views.

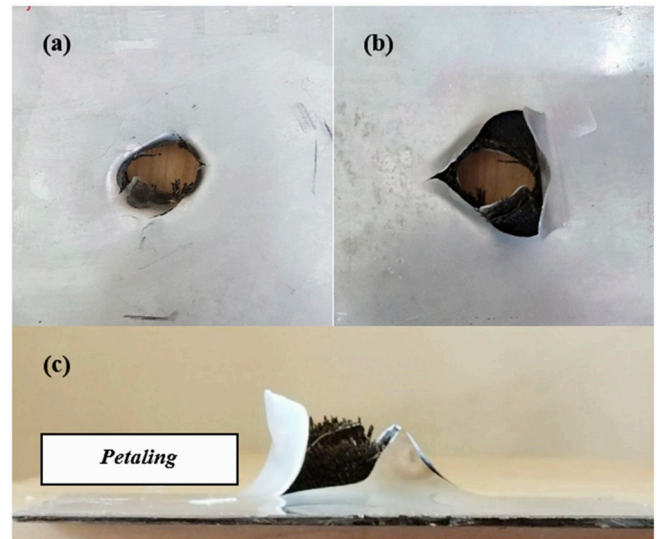

Fig. 9. Damage mode of FMLs impacted by conical projectile (a) front face, (b) back face and (c) cross views.

Table 1

Results of high-velocity impact testing of FMLs with different weight percentage of MWCNTs.

MWCNTs content (wt.%)	Weight of samples (g)	Initial velocity (m/s)	Residual velocity (m/s)
0	81.51	118	67
0.1	77.79	118	74
0.25	77.82	118	78
0.5	75.67	118	84
0.75	76.44	118	69

face of FML samples. It is obvious that the damage modes of samples are different and this is true for damaged areas, too. It can be observed that the damage mode of FMLs with 0.5 wt% MWCNTs is very different from other samples, and it has the smallest damaged area. It can be said that the damaged area of samples has become smaller as a function of MWCNTs up to 0.5 wt. Therefore, by increasing the MWCNTs content up to 0.5 wt%, the impact properties of samples in terms of specific absorbed energy and limit velocity values were enhanced.

The poor performance of FMLs with MWCNTs in terms of specific absorbed energy and limit velocity values was unusual. It is believed that the adhesion of basalt fibers/epoxy layers, as well as the interface at aluminum/composite layers, can be responsible for this behavior. As mentioned earlier, the impact energy can be dissipated through delamination of polymer composite layers and therefore, it can be concluded that the inferior adhesion between adjacent layers is suitable for the higher energy absorption.

The fracture surfaces of basalt fibers/epoxy composites at low magnification are illustrated in Fig. 13. The surfaces of basalt fibers are very smooth in the base sample (Fig. 13-a), while in the case of composites containing MWCNTs are relatively rough. Rougher surface of basalt fibers in the system with MWCNTs results in the better interfacial bonding between basalt fibers and epoxy resin. From Fig. 13, it can be presumed that the adhesion between composite plies is increased by the incorporation of MWCNTs up to 0.5 wt% loading. However, due to the increment of resin's viscosity and thus poor wettability of basalt fibers, the inferior adhesion between resin and basalt fibers is evident in the sample with 0.75 wt% MWCNTs (Fig. 13-c).

Moreover, as mentioned earlier, the adhesion between aluminum and basalt fibers/epoxy layers was improved due to the inclusion of MWCNTs up to 0.5 wt%. Thereby, another reason for the unexpected impact behavior of FMLs with MWCNTs is the lesser consumed energy

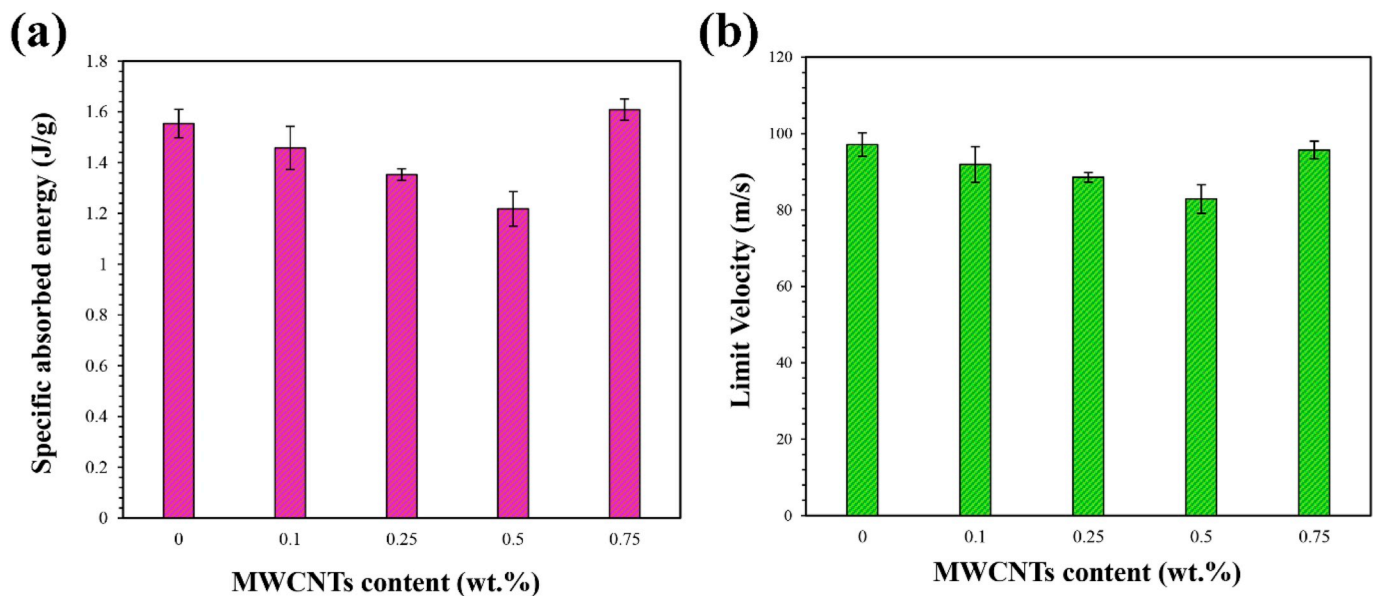

Fig. 10. Results of high-velocity impact testing of the basalt fibers/epoxy/aluminum 2024 FMLs with different content of MWCNTs (a) specific absorbed energy and (b) limit velocity.

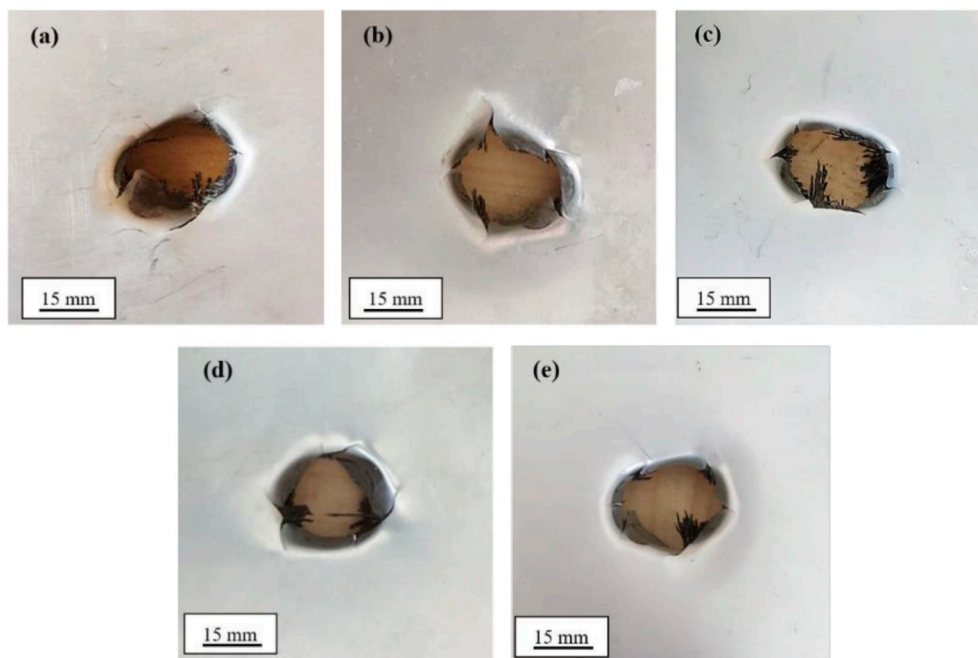

Fig. 11. Failure mode of FMLs with different weight percentage of MWCNTs (a) 0, (b) 0.1, (c) 0.25, (d) 0.5 and (e) 0.75 at front view.

via the occurrence of debonding between aluminum and composite layers. Therefore, it can be concluded that the better adhesion of FMLs with MWCNTs is not appropriate for energy absorption aims. This assumption is in agreement with the results of Li et al. [30] study. They conducted an experimental study regarding the effect of three different surface treatment methods of annealing, sandblasting and anodizing on the mechanical behavior of titanium-based FMLs. They pointed out that the FMLs with anodizing surface treatment exhibited the smallest crack length during low-velocity impact, compared with the samples with the sandblasting and annealing treatment. In addition, they proposed that the more energy absorption of FMLs with the annealing treatment was caused by the lower degree of bonding between titanium and CFRP layers.

However, the high-velocity impact results (Fig. 10) show that the specific absorbed energy and limit velocity values for FMLs with 0.75 wt % MWCNTs are similar to the base FMLs. As mentioned regarding the flexural results, with increasing the concentration of MWCNTs, the chance of agglomeration and increasing the viscosity of polymer increased. Accordingly, it can be said that for the FMLs with 0.75 wt%, the agglomerated MWCNTs and higher viscosity of epoxy matrix caused the reduction of the adhesion between aluminum and basalt fibers/epoxy layers and caused to increment the specific absorbed energy value.



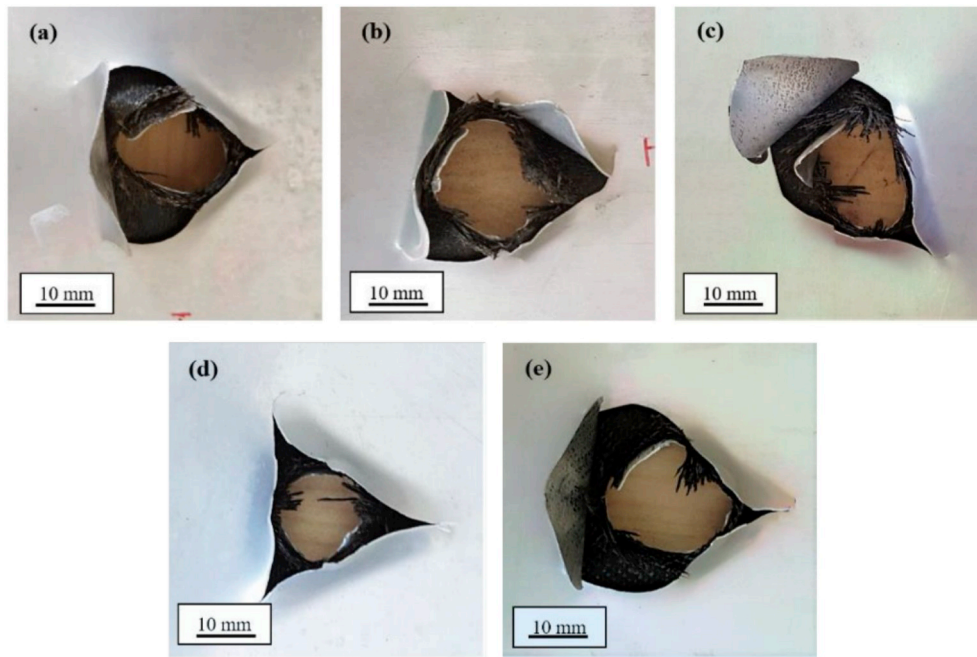

Fig. 12. Failure mode of FMLs with different weight percentage of MWCNTs (a) 0, (b) 0.1, (c) 0.25, (d) 0.5 and (e) 0.75 at back view.

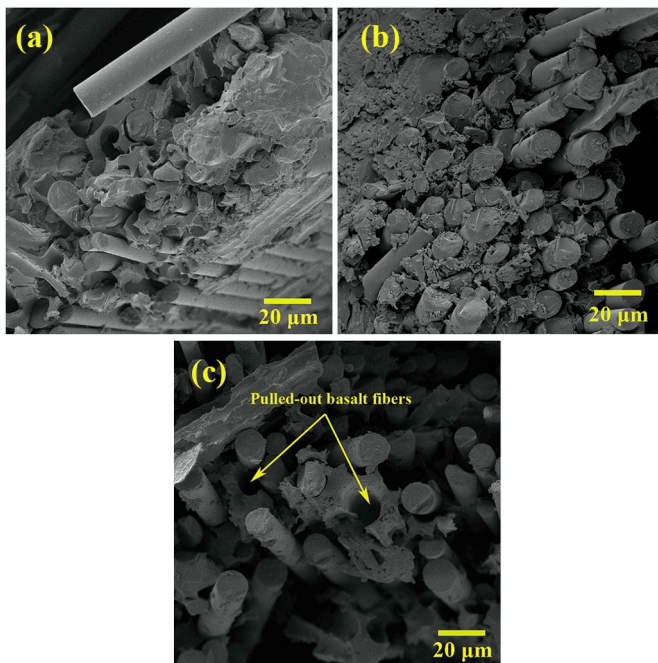

Fig. 13. FESEM images of fracture surface of basalt fibers/epoxy (a) without MWCNTs, (b) with 0.5 wt% MWCNTs and (c) with 0.75 wt% MWCNTs.

#### 4. Conclusions

This paper investigated the effect of MWCNTs on the flexural and high-velocity impact behavior of basalt fibers/epoxy/aluminum 2024-T3 FMLs. The findings of this study suggested that the adhesion of adjacent layers of composite plies and also between aluminum and basalt fibers/epoxy layers were strongly affected by the inclusion of MWCNTs. In this regard, the best flexural properties were achieved for the samples with 0.5 wt% MWCNTs. The strengthening by CNTs pull-out, CNTs bridging and plastic void growth were the main strengthening mechanisms for the enhancement of the flexural properties.

Whereas, the agglomeration and increasing in resin's viscosity resulted in the reduction of properties. Therefore, there should be a competition between improving and adverse effects of MWCNTs. In this study, the optimal content for MWCNTs was 0.5 wt%.

Contrary to the flexural results, the high-velocity impact testing revealed a negative effect of MWCNTs in terms of the specific absorbed energy and limit velocity values. Therefore, it is suggested that the appropriate adhesion between aluminum and composite layers and interface was the main reason for such behavior. In summary, the results of this study suggested that the addition of MWCNTs could have a significant effect on the adhesion and integrity of FMLs.

#### References

- [1] Ashrafi B, Guan J, Mirjalili V, Zhang Y, Chun L, Hubert P, Simard B, Kingston CT, Bourne O, Johnston A. Enhancement of mechanical performance of epoxy/carbon fiber laminate composites using single-walled carbon nanotubes. *Compos Sci Technol* 2011;71(13):1569–78.
- [2] Davis DC, Wilkerson JW, Zhu J, Ayewah DOO. Improvements in mechanical properties of a carbon fiber epoxy composite using nanotube science and technology. *Compos Struct* 2010;92(11):2653–62.
- [3] Sánchez M, Campo M, Jiménez-Suárez A, Ureña A. Effect of the carbon nanotube functionalization on flexural properties of multiscale carbon fiber/epoxy composites manufactured by VARIM. *Compos B Eng* 2013;45(1):1613–9.
- [4] Wang P, Zhang X, Lim G, Neo H, Malcolm AA, Xiang Y, Lu G, Yang J. Improvement of impact-resistant property of glass fiber-reinforced composites by carbon nanotube-modified epoxy and pre-stretched fiber fabrics. *J Mater Sci* 2015;50(18):5978–92.
- [5] Zou J, Zhang X, Zhao J, Lei C, Zhao Y, Zhu Y, Li Q. Strengthening and toughening effects by strapping carbon nanotube cross-links with polymer molecules. *Compos Sci Technol* 2016;135:123–7.
- [6] Quaresimin M, Schulte K, Zappalorto M, Chandrasekaran S. Toughening mechanisms in polymer nanocomposites: from experiments to modelling. *Compos Sci Technol* 2016;123:187–204.
- [7] Tehrani M, Boroujeni AY, Hartman TB, Haugh TP, Case SW, Al-Haik MS. Mechanical characterization and impact damage assessment of a woven carbon fiber reinforced carbon nanotube–epoxy composite. *Compos Sci Technol* 2013;75:42–8.
- [8] Shokrieh MM, Saeedi A, Chitsazzadeh M. Evaluating the effects of multi-walled carbon nanotubes on the mechanical properties of chopped strand mat/polyester composites. *Mater Des* 2014;56:274–9.
- [9] Li X, Zhang W, Zhai S, Tang S, Zhou X, Yu D, Wang X. Investigation into the toughening mechanism of epoxy reinforced with multi-wall carbon nanotubes. *E-Polymers* 2015;15(5).
- [10] Gojny F, Wichmann M, Fiedler B, Schulte K. Influence of different carbon nanotubes on the mechanical properties of epoxy matrix composites – a comparative study. *Compos Sci Technol* 2005;65(15–16):2300–13.

- [11] Tarfaoui M, Lafdi K, El Moumen A. Mechanical properties of carbon nanotubes based polymer composites. *Compos B Eng* 2016;103:113–21.
- [12] Zhou Y, Pervin F, Lewis L, Jeelani S. Experimental study on the thermal and mechanical properties of multi-walled carbon nanotube-reinforced epoxy. *Mater Sci Eng A* 2007;452–453:657–64.
- [13] Rahman M, Hosur M, Zainuddin S, Vaidya U, Tauhid A, Kumar A, Trovillion J, Jeelani S. Effects of amino-functionalized MWCNTs on ballistic impact performance of E-glass/epoxy composites using a spherical projectile. *Int J Impact Eng* 2013;57:108–18.
- [14] Kostopoulos V, Baltopoulos A, Karapappas P, Vavouliotis A, Paipetis A. Impact and after-impact properties of carbon fibre reinforced composites enhanced with multi-wall carbon nanotubes. *Compos Sci Technol* 2010;70(4):553–63.
- [15] Chai GB, Manikandan P. Low velocity impact response of fibre-metal laminates – a review. *Compos Struct* 2014;107:363–81.
- [16] Sadighi M, Alderliesten RC, Benedictus R. Impact resistance of fiber-metal laminates: a review. *Int J Impact Eng* 2012;49:77–90.
- [17] Sinmazçelik T, Avcu E, Bora MÖ, Çoban O. A review: fibre metal laminates, background, bonding types and applied test methods. *Mater Des* 2011;32(7):3671–85.
- [18] Godara A, Mezzo L, Luizi F, Warriier A, Lomov SV, van Vuure AW, Gorbatikh L, Moldenaers P, Verpoest I. Influence of carbon nanotube reinforcement on the processing and the mechanical behaviour of carbon fiber/epoxy composites. *Carbon* 2009;47(12):2914–23.
- [19] Konstantakopoulou M, Kotsikos G. Effect of MWCNT filled epoxy adhesives on the quality of adhesively bonded joints. *Plast, Rubber Compos* 2016;45(4):166–72.
- [20] Zhai LL, Ling GP, Wang YW. Effect of nano- $\text{Al}_2\text{O}_3$  on adhesion strength of epoxy adhesive and steel. *Int J Adhesion Adhes* 2008;28(1–2):23–8.
- [21] Zhang H, Gn SW, An J, Xiang Y, Yang JL. Impact behaviour of GLAREs with MWCNT modified epoxy resins. *Exp Mech* 2013;54(1):83–93.
- [22] Asaee Z, Mohamed M, De Cicco D, Taheri F. Low-velocity impact response and damage mechanism of 3D fiber-metal laminates reinforced with amino-functionalized graphene nanoplatelets. *Int J Compos Mater* 2017;7(1):20–36.
- [23] Amooyi Dizaji R, Yazdani M, Aligholizadeh E, Rashed A. Effect of 3D-woven glass fabric and nanoparticles incorporation on impact energy absorption of GLARE composites. *Polym Compos* 2018;39(10):3528–36.
- [24] Gan YX. Effect of interface structure on mechanical properties of advanced composite materials. *Int J Mol Sci* 2009;10(12):5115–34.
- [25] Miyagawa H, Drzal LT. The effect of chemical modification on the fracture toughness of montmorillonite clay/epoxy nanocomposites. *J Adhes Sci Technol* 2004;18(13):1571–88.
- [26] Meguid SA, Sun Y. On the tensile and shear strength of nano-reinforced composite interfaces. *Mater Des* 2004;25(4):289–96.
- [27] Fatt MSH, Lin C, Revilock DM, Hopkins DA. Ballistic impact of GLARE™ fiber–metal laminates. *Compos Struct* 2003;61(1):73–88.
- [28] Pärnänen T, Kanerva M, Sarlin E, Saarela O. Debonding and impact damage in stainless steel fibre metal laminates prior to metal fracture. *Compos Struct* 2015;119:777–86.
- [29] Zarei H, Sadighi M, Minak G. Ballistic analysis of fiber metal laminates impacted by flat and conical impactors. *Compos Struct* 2017;161:65–72.
- [30] Li X, Zhang X, Zhang H, Yang J, Nia AB, Chai GB. Mechanical behaviors of Ti/CFRP/Ti laminates with different surface treatments of titanium sheets. *Compos Struct* 2017;163:21–31.