

Experimental analysis and performances of an Ocean Thermal Energy Conversion prototype in a tropical French overseas island

Alexandre Dijoux (1, 2*), Frantz Sinama (1), Olivier Marc (1), Bertrand Clauzade (2) & Jean Castaing-Lasvignottes (1)

Introduction

Closed Cycle OTEC (Ocean Thermal Energy Conversion)

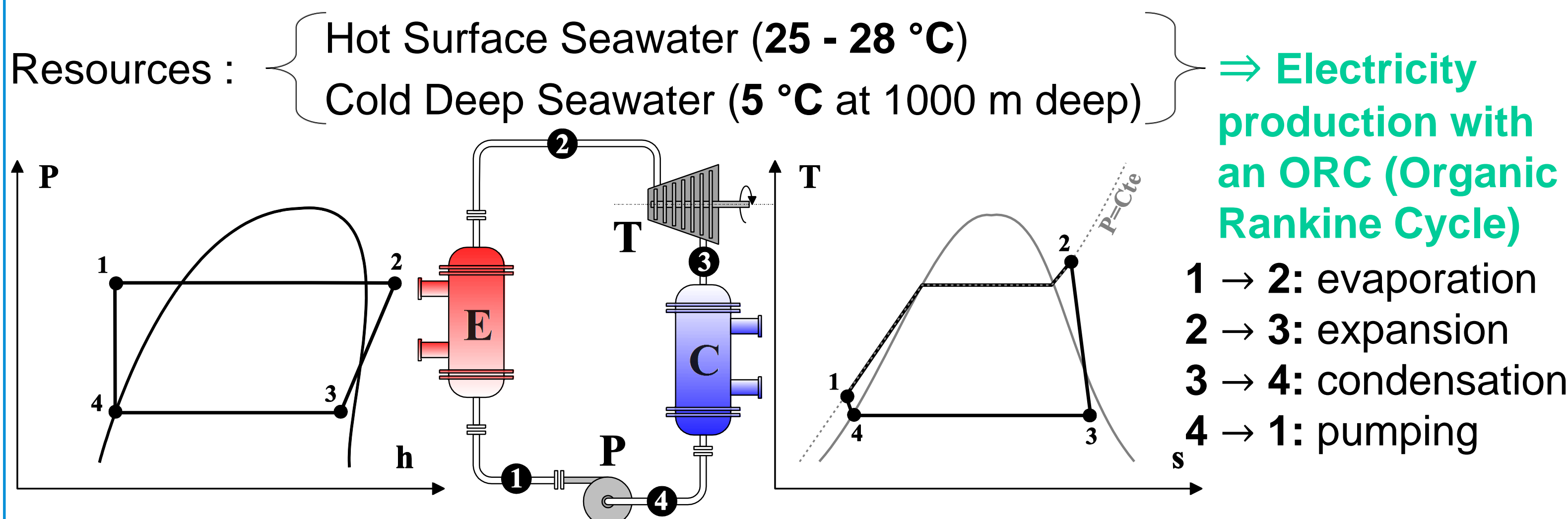

OTEC Onshore Prototype (named PAT ETM)

Experimental installation in Reunion Island, co-funded by Naval Energies and Région Réunion.

Installation in 2012.

Objectives: - Test of different heat exchangers technologies
 - Reduced but representative scale (1/125) of a real system



Example of a Steady State Test and Analysis

- **5 degrees of freedom** for the definition of instructions for a test point
- **20 minutes** of stability before validation of a steady state point

Parameters	Value
Inlet hot water temperature	27.0 °C
Inlet cold water temperature	5.3 °C
Hot water mass flow rate	43.6 kg/s
Cold water mass flow rate	31.6 kg/s
Ammonia mass flow rate	0.357 kg/s

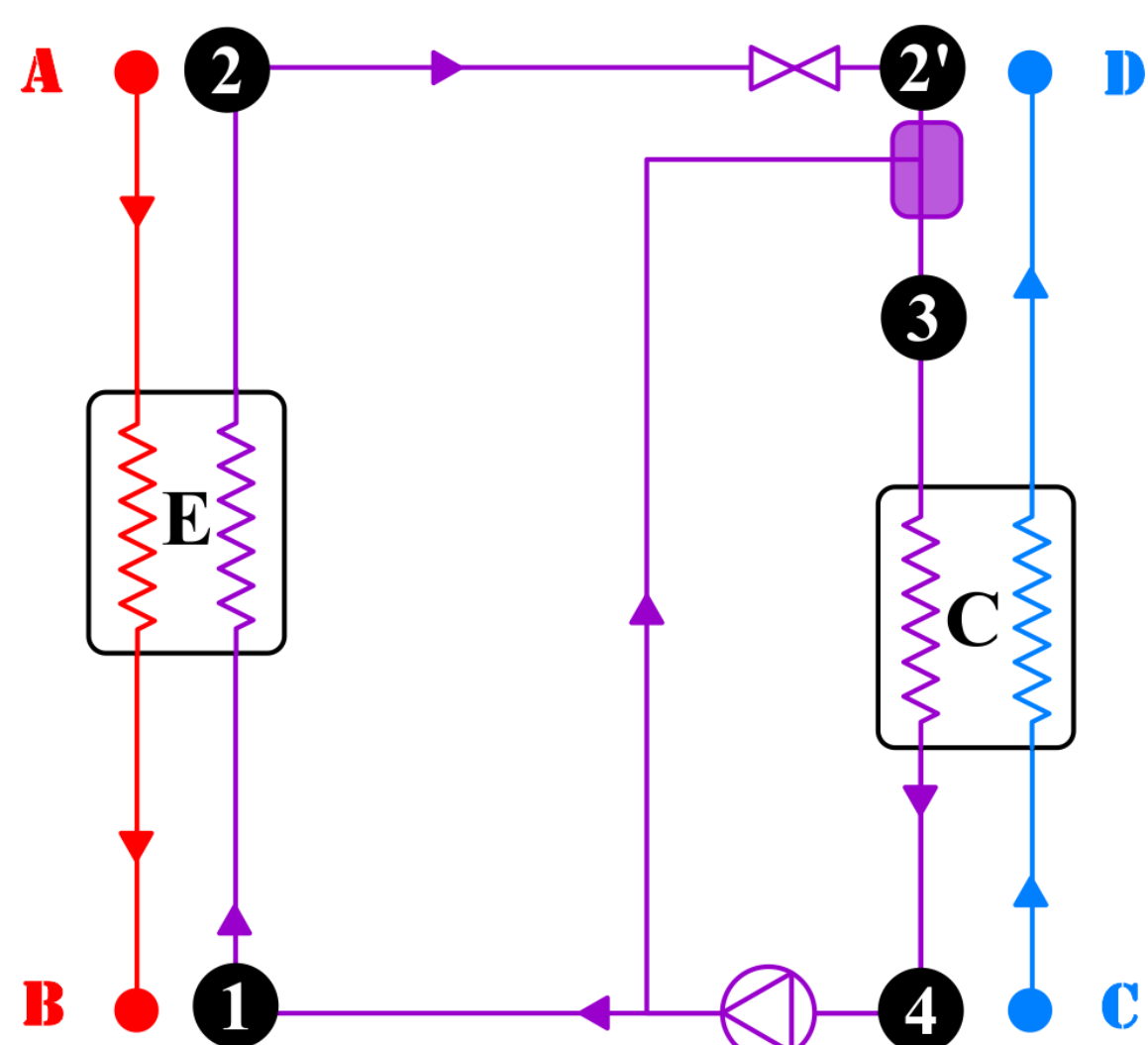

Test Conditions

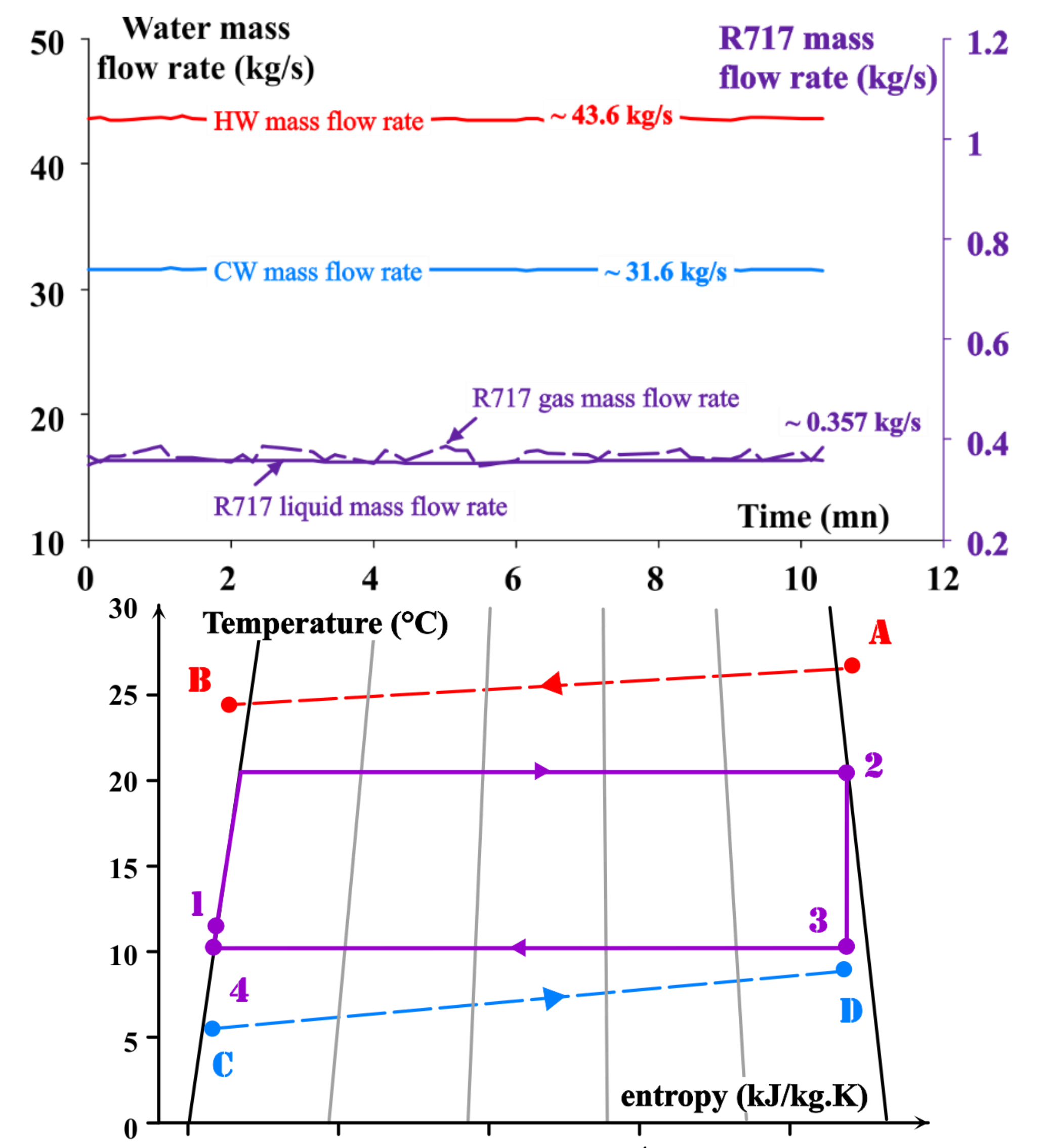
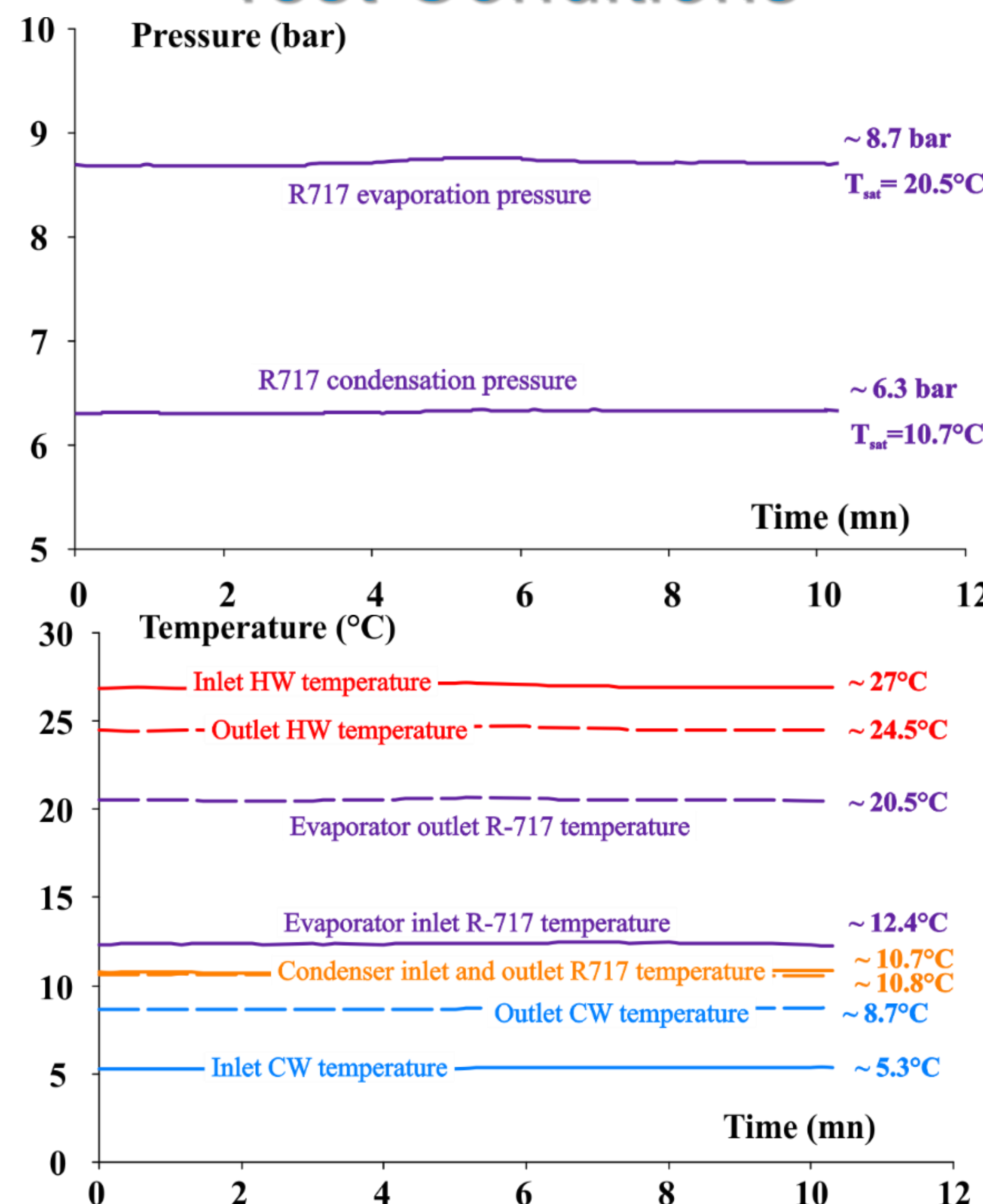

Method of the Energetic Analysis

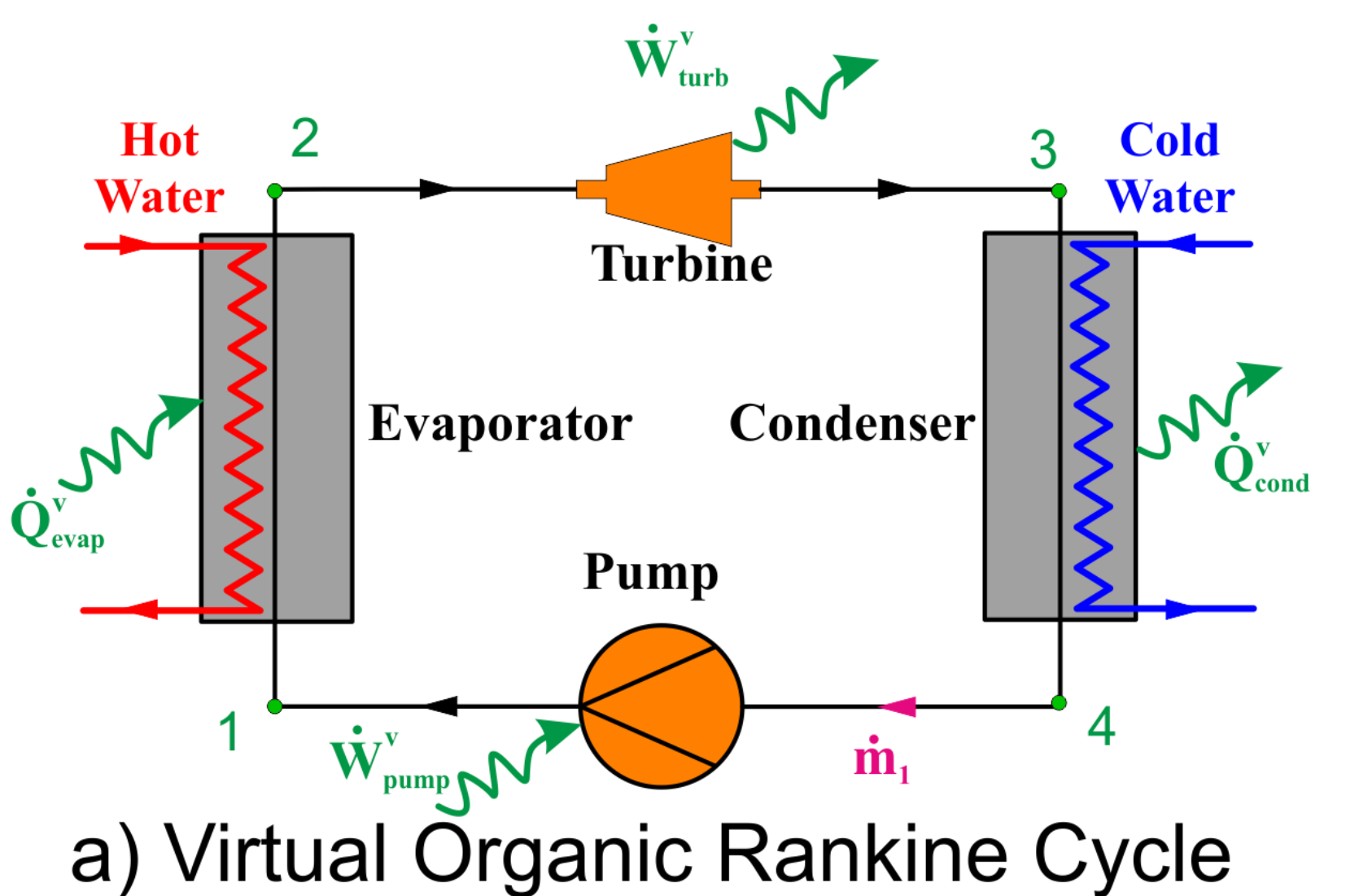

- No installed turbine:**
 ⇒ Comparison between the real cycle and a virtual ORC with a turbine.
- Hypothesis:**
- Each intensive state variable has the same value in both cycles.
 - The mass flow rate of the virtual cycle is assumed to be that in the evaporator.

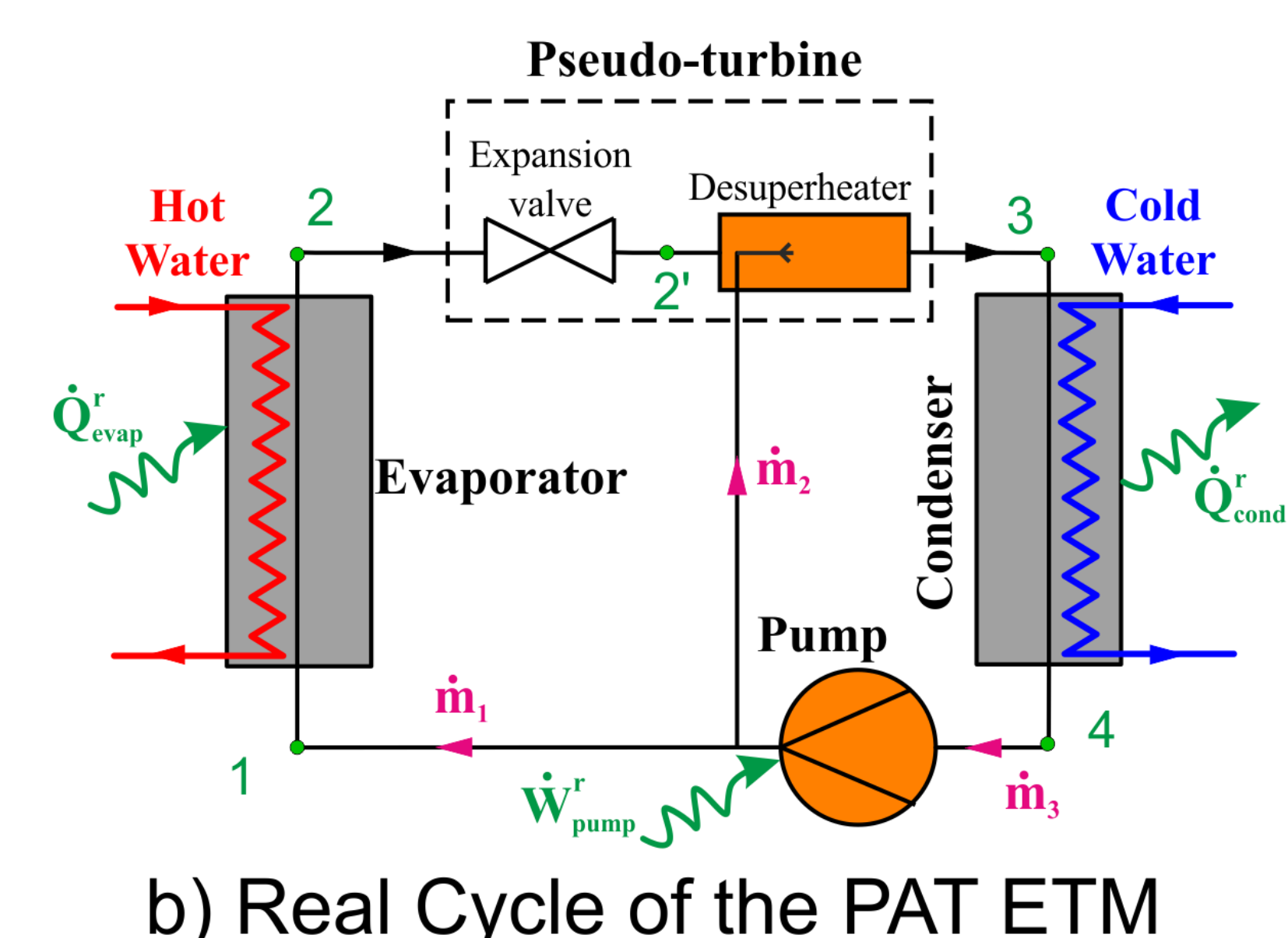

Application of the first law of thermodynamics :

$$\begin{cases} \dot{Q}_{evap}^r + \dot{W}_{pump}^r + \dot{Q}_{cond}^r + \dot{Q}_{rem}^r = 0 \\ \dot{Q}_{evap}^v + \dot{W}_{turb}^v + \dot{Q}_{cond}^v + \dot{W}_{pump}^v + \dot{Q}_{rem}^v = 0 \end{cases}$$

Energetic Balance of the System

Point	T (°C)	P (bar)	Power (kW)	Real	Virtual
1	12,37	8,83	\dot{Q}_{evap}	436,04	436,04
2	20,54	8,72	\dot{Q}_{cond}	-438,92	-425,17
2'	15,7	6,89	\dot{W}_{turb}	0	-13,74
3	10,81	6,33	\dot{W}_{pump}	2,98	2,89
4	10,67	6,40	\dot{Q}_{res}	-0,093	-0,093

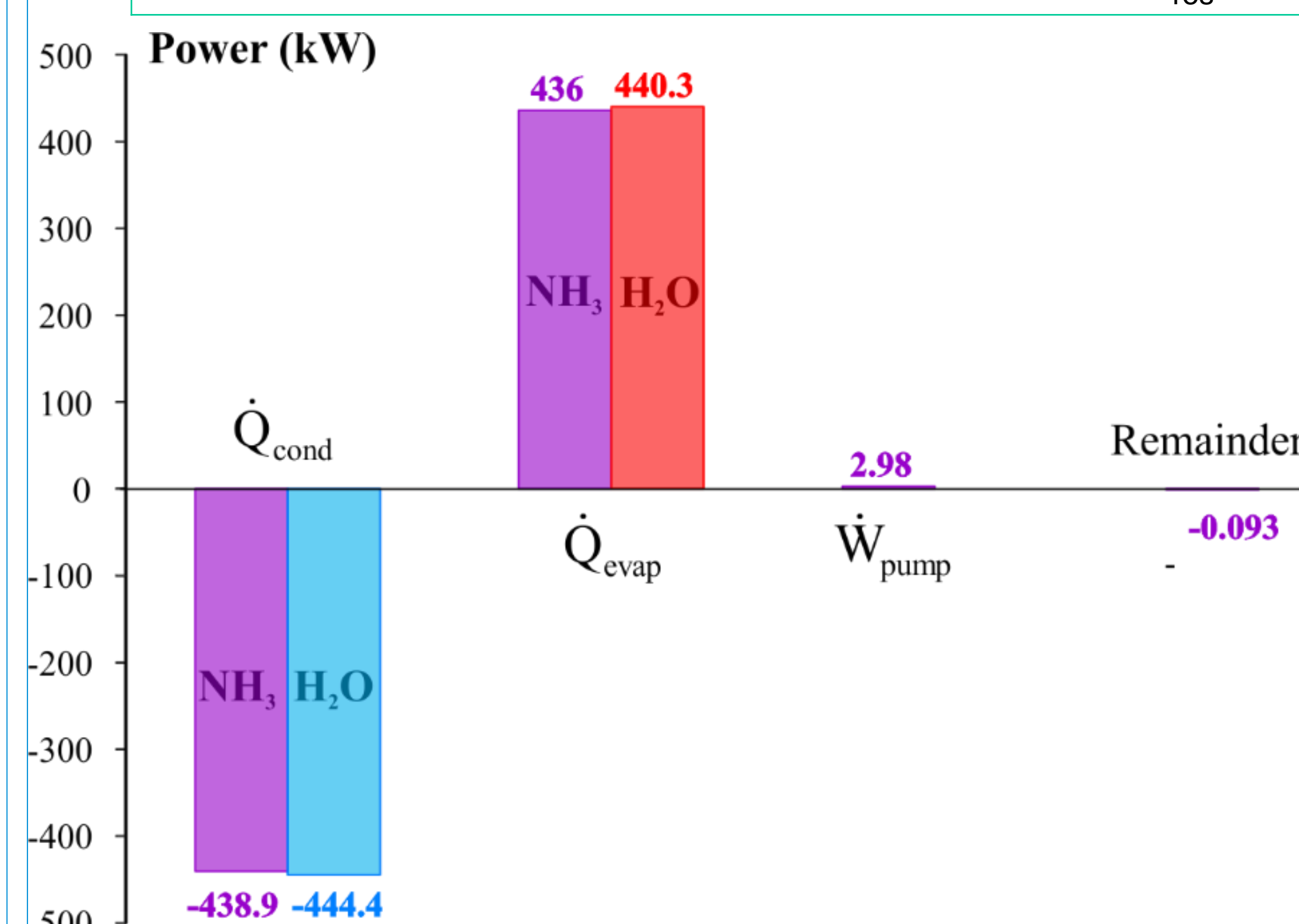

- Power output at the virtual turbine: **13,74 kW**
- Net power output: **10,86 kW**
- Thermal Efficiency: **2,49 % → 35 % of the Carnot efficiency**