

Computational Advantage from Quantum Superposition of Multiple Temporal Orders of Gates

Alastair A. Abbott

Inria Grenoble, and University of Geneva



**UNIVERSITÉ
DE GENÈVE**

GDR IQFA 2020, 2-4 Dec 2020, Virtually in Grenoble

arXiv:2002.07817

with M. Taddei, J. Cariñe, D. Martínez, T. García, N. Guerrero,
M. Araújo, C. Branciard, E. Gómez, S. Walborn, L. Aolita, G. Lima

Motivation

- Standard quantum circuit

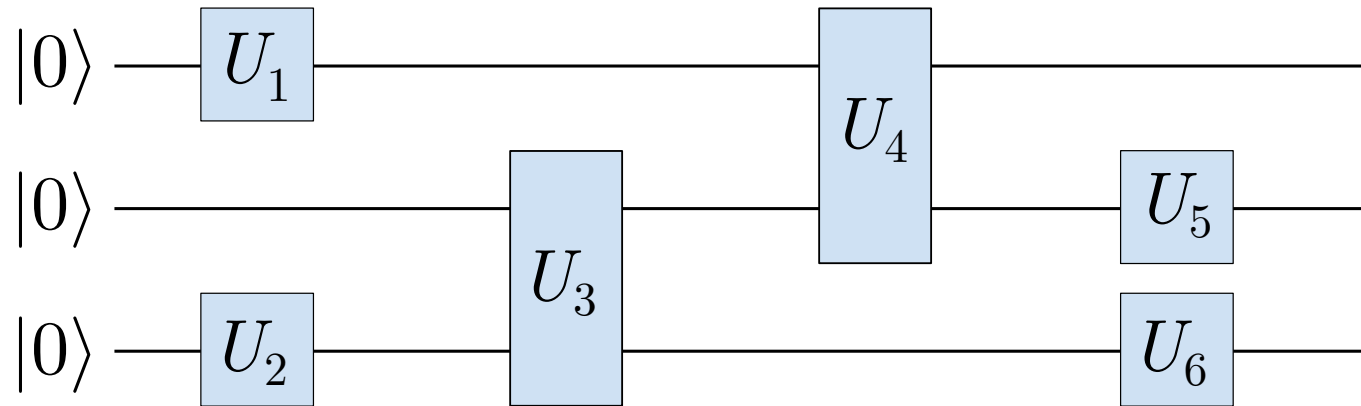

- Can we go further?

Motivation

- Standard quantum circuit

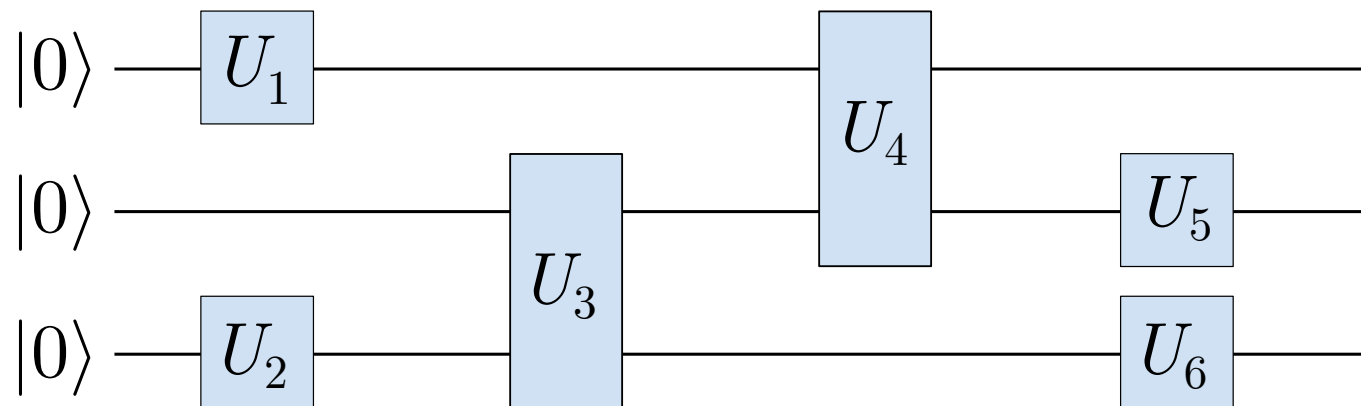

- Can we go further?

$$\frac{1}{\sqrt{2}} \left(\left| \begin{array}{c} \text{---} U_1 \text{---} U_2 \text{---} \end{array} \right\rangle + \left| \begin{array}{c} \text{---} U_2 \text{---} U_1 \text{---} \end{array} \right\rangle \right)$$

Outline

1. Higher-order quantum computation
 - The “quantum switch” – coherently controlling gate order
2. Hadamard Promise Problem
3. Experimental 4-switch

Quantum Computing with Black Boxes

- Black box access to unknown unitaries (oracles)

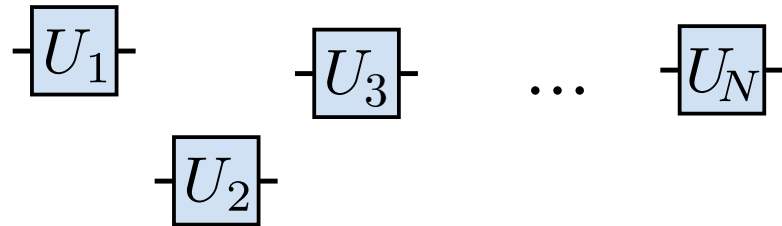

- Property to determine: $f(U_1, \dots, U_N)$

Quantum Computing with Black Boxes

- Black box access to unknown unitaries (oracles)

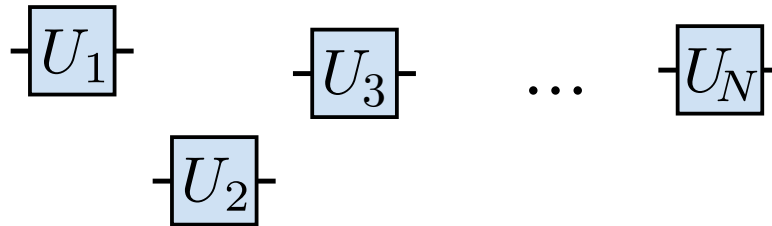

- Property to determine: $f(U_1, \dots, U_N)$
- Example: Grover's problem

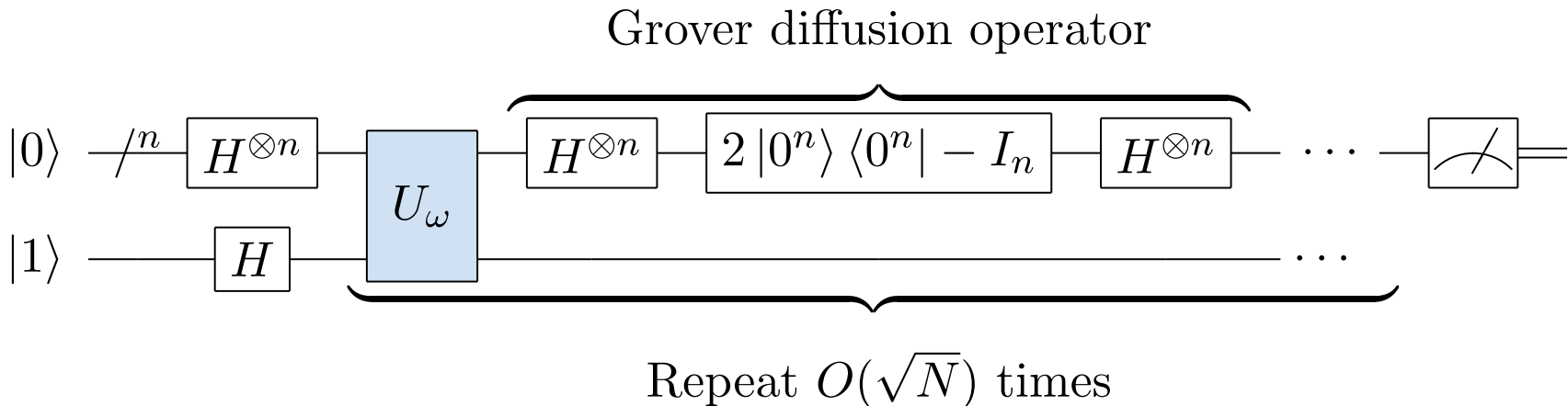

Higher-Order Quantum Computation

- Black box access to unknown unitaries (oracles)

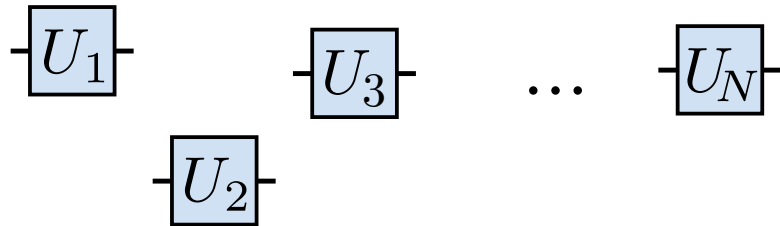

- Higher-order computation: how can the operations be composed?

Higher-Order Quantum Computation

- Black box access to unknown unitaries (oracles)

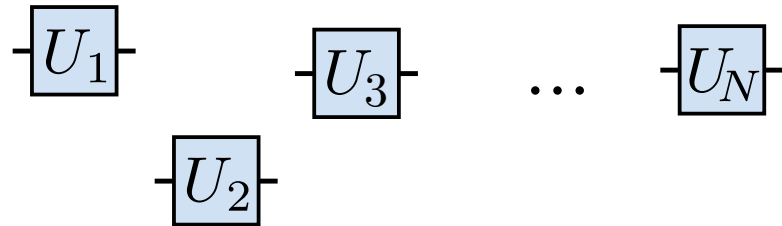

- Higher-order computation: how can the operations be composed?

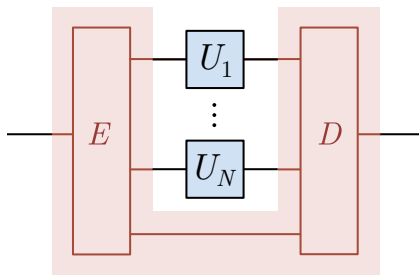

Parallel

Higher-Order Quantum Computation

- Black box access to unknown unitaries (oracles)

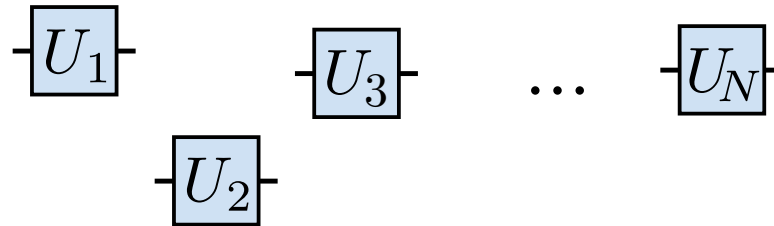

- Higher-order computation: how can the operations be composed?

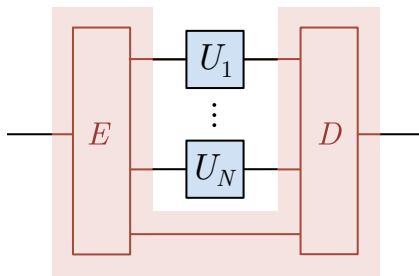

Parallel

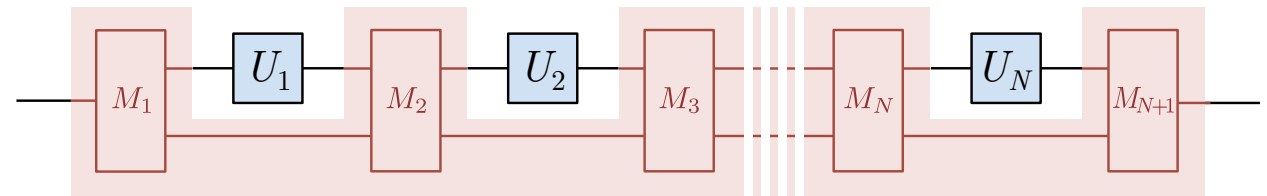

Quantum circuit (quantum comb)

[Chiribella, D'Ariano, Perinotti, PRL (2008)]

Higher-Order Quantum Computation

- Black box access to unknown unitaries (oracles)

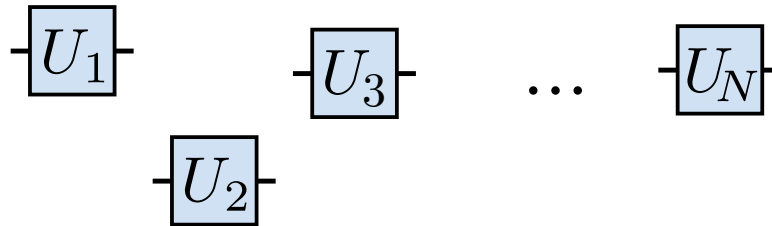

- Higher-order computation: how can the operations be composed?

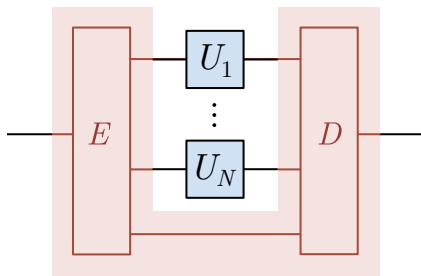

Parallel

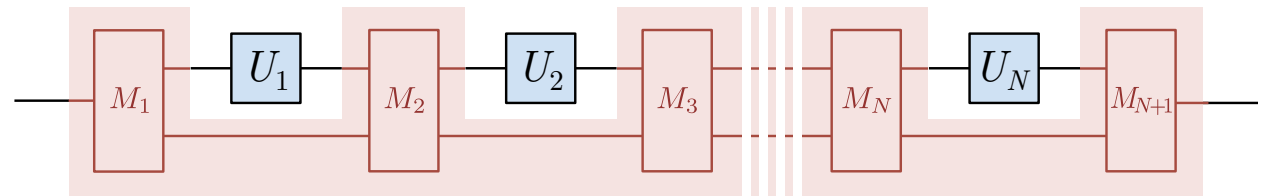

Quantum circuit (quantum comb)

[Chiribella, D'Ariano, Perinotti, PRL (2008)]

Quantum supermap
(process matrix)

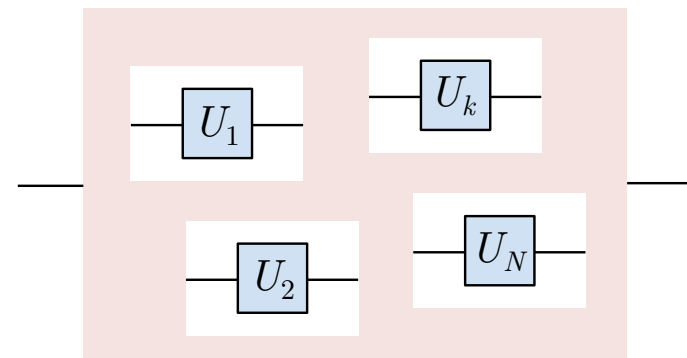

[Oreshkov, Costa, Brukner, Nat. Commun (2012)]

[Wechs, **AA**, Branciard, NJP (2019)]

The Quantum Switch

- First example of a “causally indefinite” supermap

[Chiribella, D’Ariano, Perinotti and Valiron, PRA 88 (2013); arXiv:0912.0195]

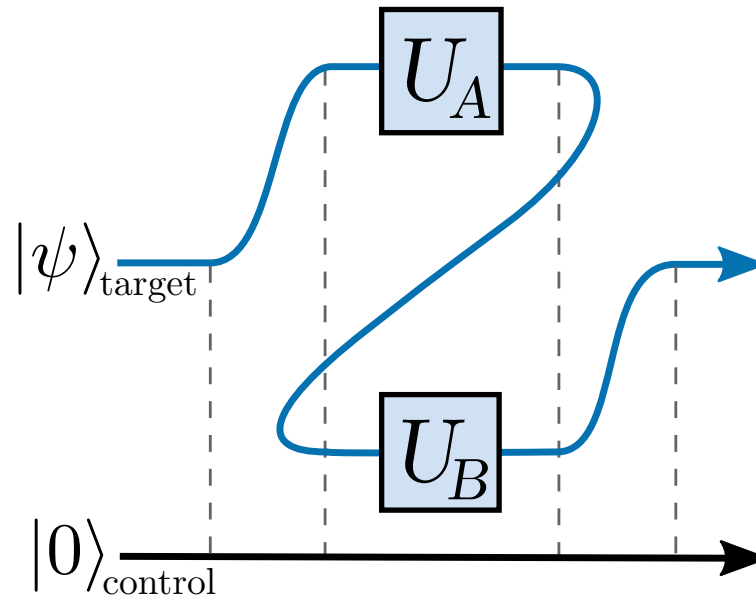

$$S_2(U_A, U_B) = |0\rangle\langle 0|^c \otimes U_B U_A + |1\rangle\langle 1|^c \otimes U_A U_B$$

- Cannot be represented in quantum circuit model
 - Would need to query one box twice

The Quantum Switch

- First example of a “causally indefinite” supermap

[Chiribella, D’Ariano, Perinotti and Valiron, PRA 88 (2013); arXiv:0912.0195]

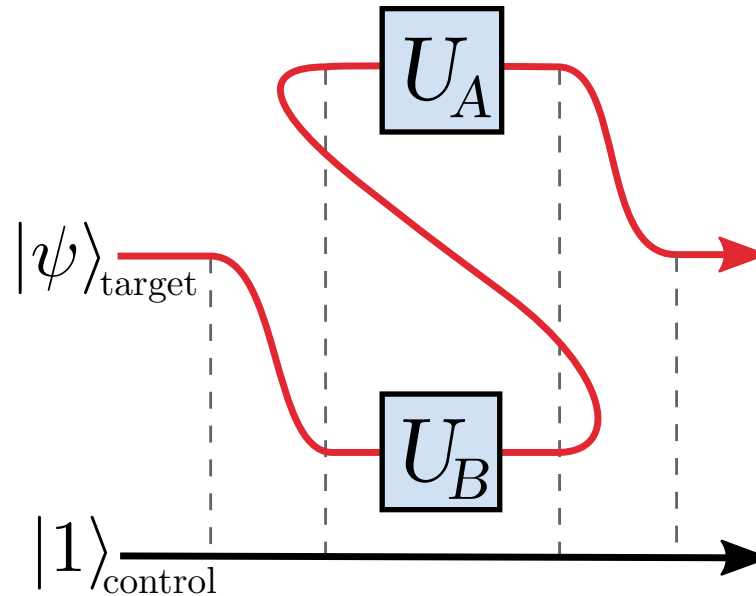

$$S_2(U_A, U_B) = |0\rangle\langle 0|^c \otimes U_B U_A + |1\rangle\langle 1|^c \otimes U_A U_B$$

- Cannot be represented in quantum circuit model
 - Would need to query one box twice

The Quantum Switch

- First example of a “causally indefinite” supermap

[Chiribella, D’Ariano, Perinotti and Valiron, PRA 88 (2013); arXiv:0912.0195]

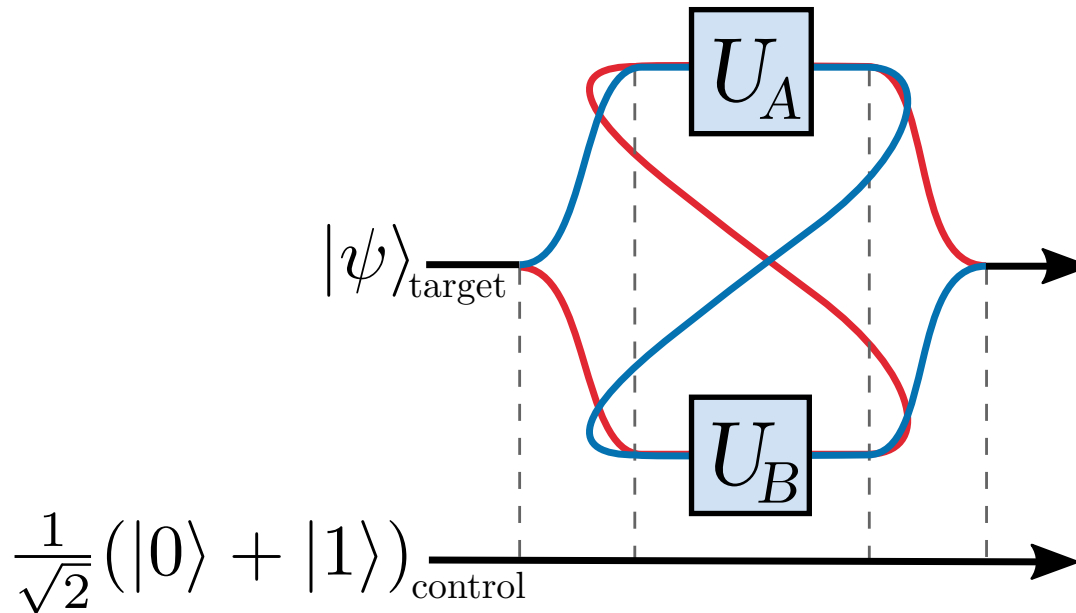

$$S_2(U_A, U_B) = |0\rangle\langle 0|^c \otimes U_B U_A + |1\rangle\langle 1|^c \otimes U_A U_B$$

- Cannot be represented in quantum circuit model
 - Would need to query one box twice

The Quantum Switch

- First example of a “causally indefinite” supermap

[Chiribella, D’Ariano, Perinotti and Valiron, PRA 88 (2013); arXiv:0912.0195]

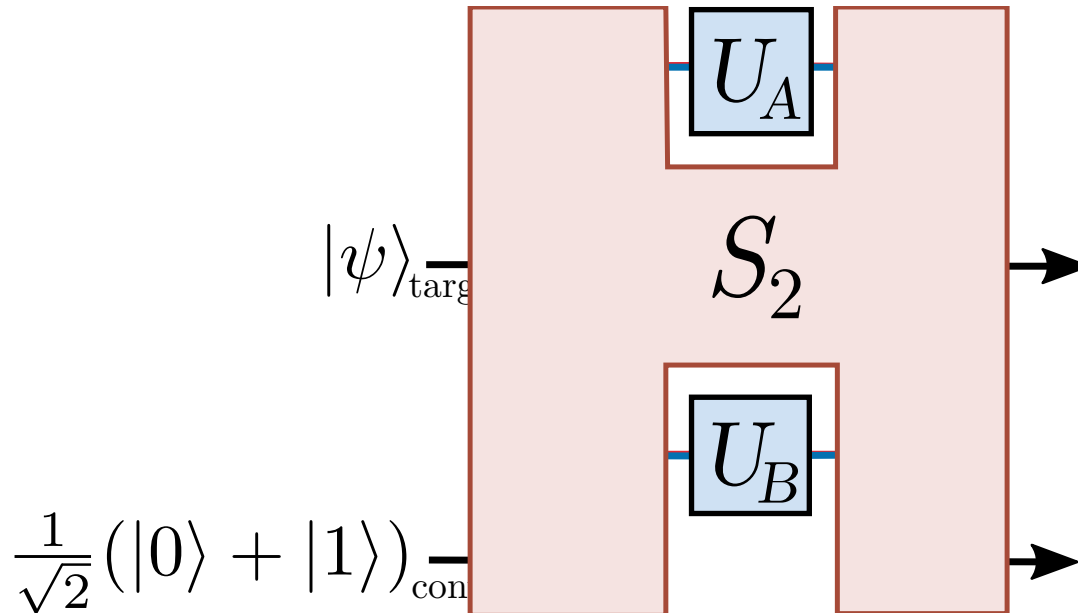

$$S_2(U_A, U_B) = |0\rangle\langle 0|^c \otimes U_B U_A + |1\rangle\langle 1|^c \otimes U_A U_B$$

- Cannot be represented in quantum circuit model
 - Would need to query one box twice

Quantum Switch: A Tool for Quantum Info?

- Quantum switch provides advantages in several settings
 - Query complexity
 - Communication complexity
 - Metrology
 - Communication through noisy channels

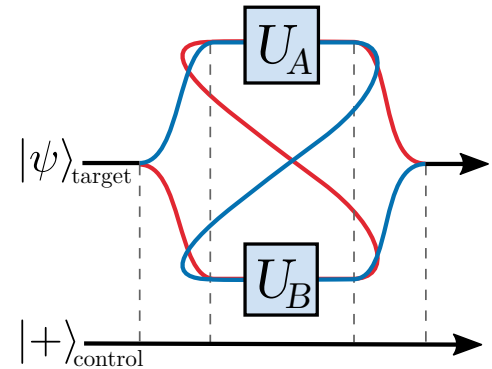

Quantum Switch: A Tool for Quantum Info?

- Quantum switch provides advantages in several settings
 - Query complexity
 - Communication complexity
 - Metrology
 - Communication through noisy channels

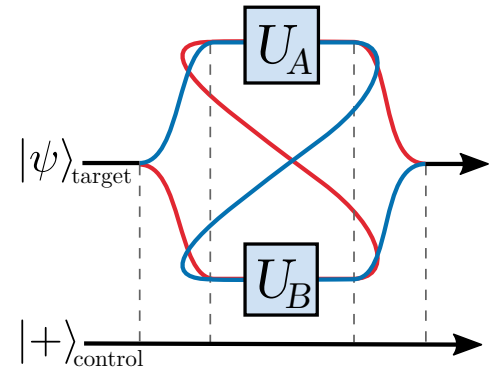

Discriminating commuting vs anticommuting U_A, U_B

[G. Chiribella, PRA (2012)]

$$[U_A, U_B] = 0 \text{ or } \{U_A, U_B\} = 0$$

- In a quantum circuit must use U_A or U_B twice
- With the quantum switch, one query to each is enough

$$\begin{aligned} \frac{1}{\sqrt{2}}(|0\rangle^c + |1\rangle^c) \otimes |\psi\rangle^t &\rightarrow \frac{1}{\sqrt{2}}(|0\rangle^c \otimes U_B U_A |\psi\rangle^t + |1\rangle^c \otimes U_A U_B |\psi\rangle^t) \\ &= |+\rangle^c \otimes \frac{1}{2} \{U_A, U_B\} |\psi\rangle^t + |-\rangle^c \otimes \frac{1}{2} [U_A, U_B] |\psi\rangle^t \end{aligned}$$

Experimentally Achieving Causal Indefiniteness

- Optical-table experiments based on conceptually simple interferometers

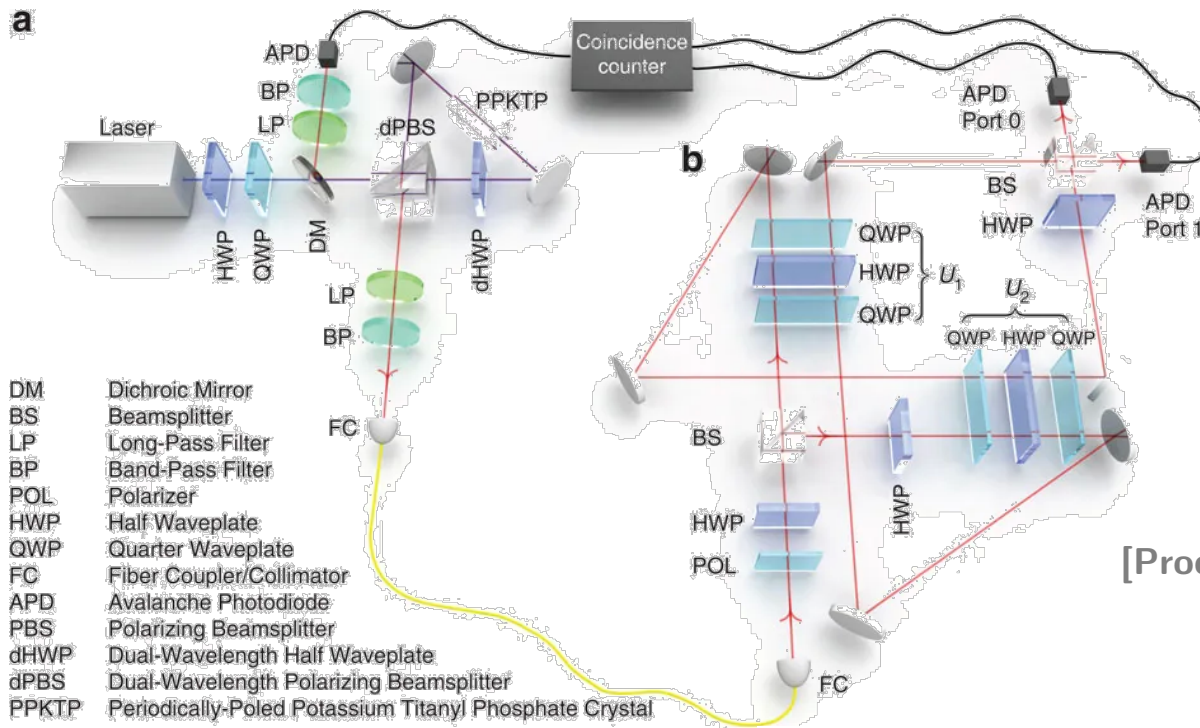

One d.o.f. of photon acts as control, another as the target system

DM	Dichroic Mirror
BS	Beamsplitter
LP	Long-Pass Filter
BP	Band-Pass Filter
POL	Polarizer
HWP	Half Waveplate
QWP	Quarter Waveplate
FC	Fiber Coupler/Collimator
APD	Avalanche Photodiode
PBS	Polarizing Beamsplitter
dHWP	Dual-Wavelength Half Waveplate
dPBS	Dual-Wavelength Polarizing Beamsplitter
PPKTP	Periodically-Poled Potassium Titanyl Phosphate Crystal

[Procopio *et al.*, Nat. Commun (2015)]

[Rubino *et al.*, Sci. Adv. (2017)]

[Goswami *et al.*, PRL (2018)]

[Wei *et al.*, PRL (2019)]

[Guo *et al.*, PRL (2020)]

How to go beyond the 2-operation quantum switch?

Quantum N -Switch

- Recall the quantum 2-switch

$$S_2(U_A, U_B) = |0\rangle\langle 0|^c \otimes U_B U_A + |1\rangle\langle 1|^c \otimes U_A U_B$$

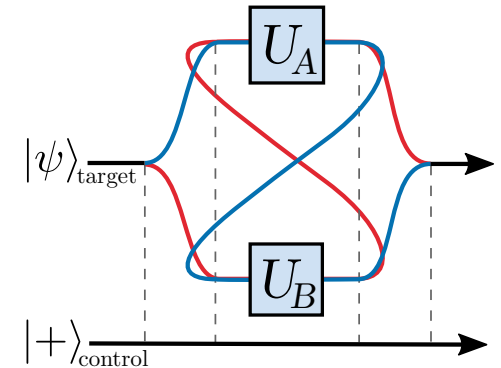

- N -switch quantum supermap

$$S_N(U_1, \dots, U_N) = \sum_{x \in [N!]} |x\rangle\langle x|^c \otimes \Pi_x$$

\uparrow
 $[N!] := \{0, 1, \dots, N! - 1\}$

$$\Pi_x := U_{\sigma_x(N)} \cdots U_{\sigma_x(1)}$$

\uparrow
 x th permutation of $\{1, \dots, N\}$

Quantum N -Switch

- Recall the quantum 2-switch

$$S_2(U_A, U_B) = |0\rangle\langle 0|^c \otimes U_B U_A + |1\rangle\langle 1|^c \otimes U_A U_B$$

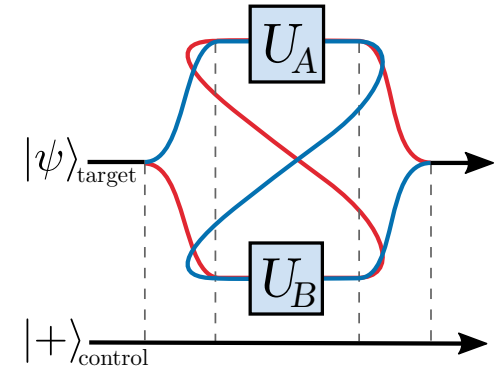

- N -switch quantum supermap

$$d_c := \dim(\mathcal{H}^c) \geq N! \quad d_t := \dim(\mathcal{H}^t)$$

$$S_N(U_1, \dots, U_N) = \sum_{x \in [N!]} |x\rangle\langle x|^c \otimes \Pi_x$$

$$[N!] := \{0, 1, \dots, N! - 1\}$$

$$\Pi_x := U_{\sigma_x(N)} \cdots U_{\sigma_x(1)}$$

x th permutation of $\{1, \dots, N\}$

Fourier Promise Problem

Setting: Oracle access to N unitary quantum gates U_1, U_2, \dots, U_N

$$\boxed{U_1} \quad \boxed{U_2} \quad \dots \quad \boxed{U_N}$$

Promise: The unitaries obey, for some y , the property

$$\mathbb{P}_y : \forall x \Pi_x = \omega^{xy} \Pi_0, \text{ with } \omega = e^{i\frac{2\pi}{N}}$$

Goal: Find y [Araújo, Costa, Brukner, PRL (2014)]

- N -switch can solve with N queries (quadratic advantage)



Fourier Promise Problem

Setting: Oracle access to N unitary quantum gates U_1, U_2, \dots, U_N

$$\boxed{U_1} \quad \boxed{U_2} \quad \dots \quad \boxed{U_N}$$

Promise: The unitaries obey, for some y , the property

$$\mathbb{P}_y : \forall x \Pi_x = \omega^{xy} \Pi_0, \text{ with } \omega = e^{i\frac{2\pi}{N!}}$$

Goal: Find y [Araújo, Costa, Brukner, PRL (2014)]

▪ N -switch can solve with N queries (quadratic advantage) 😊

- Promise can only be satisfied when $d_t \geq N!$ 😭
- (Take determinant of both sides of promise statement)

$$\det \Pi_x = \omega^{x d_t} \det \Pi_0 \implies e^{i\frac{2\pi}{N!} x d_t} = 1$$

Outline

1. Higher-order quantum computation
 - The “quantum switch” – coherently controlling gate order
2. Hadamard Promise Problem
3. Experimental 4-switch

Towards the Hadamard Promise Problem

- Now: $P \leq N!$ permutations Π'_x , $x = 0, \dots, P - 1$

Promise: The unitaries obey, for some y , the property

$$\mathbb{P}_y : \forall x \Pi'_x = m_{x,y} \Pi'_0, \quad \text{with } m_{x,y} = \pm 1 \text{ the elements of a } P \times P \text{ matrix } M$$

Goal: Find y

- Determinant condition: $\det(\Pi'_x) = m_{x,y}^{d_t} \det(\Pi'_0)$
 - d_t must be even  qubits ok!

- What kind of matrix should M be?

Hadamard Promise Problem

Promise: The unitaries obey, for some y , the property

$$\mathbb{P}_y : \forall x \Pi'_x = m_{x,y} \Pi'_0,$$

with $m_{x,y} = \pm 1$ the elements
of a $P \times P$ **Hadamard** matrix M

Goal: Find y

- Answer: A Hadamard matrix!
 - ± 1 -valued matrices with orthogonal rows and columns
 - Half of values in each row/column are $+1$, half -1
 - Satisfies $\frac{1}{P} M \cdot M^T = \mathbb{1}$
 - Only possible for $P = 1, 2$ or a multiple of 4
 - Conjectured to exist for all multiples of 4

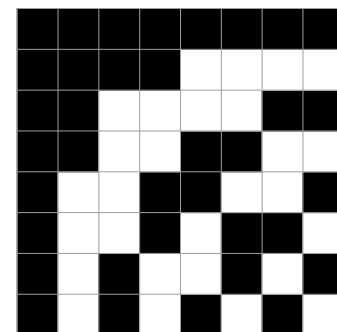
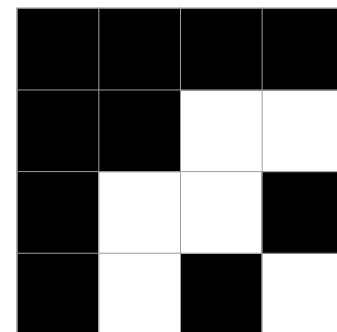
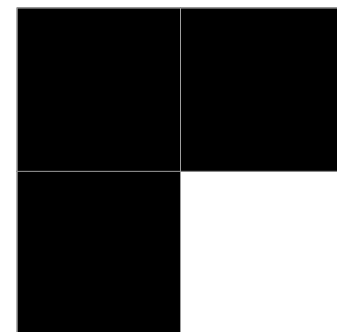

Solving the Hadamard Promise Problem

- Can solve perfectly with the N -switch
 - N -switch now coherently controls the permutations Π'_x

$$\begin{aligned}
 |0\rangle^c |\psi\rangle^t &\xrightarrow{H_P} \frac{1}{\sqrt{P}} \sum_{x \in [P]} |x\rangle^c |\psi\rangle^t \\
 &\xrightarrow{S_N} \frac{1}{\sqrt{P}} \sum_{x \in [P]} |x\rangle^c \Pi'_x |\psi\rangle^t \\
 &= \left(\frac{1}{\sqrt{P}} \sum_{x \in [P]} m_{x,y} |x\rangle^c \right) \Pi'_0 |\psi\rangle^t \\
 &\xrightarrow{H_P^\dagger} |y\rangle^c \Pi'_0 |\psi\rangle^t
 \end{aligned}$$

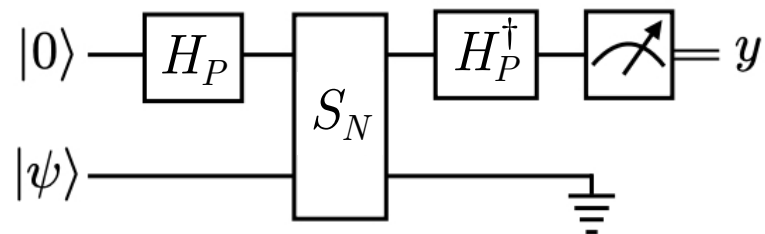

where $H_P = \frac{1}{\sqrt{P}} M$

Solving the Hadamard Promise Problem

- Can solve perfectly with the N -switch
 - N -switch now coherently controls the permutations Π'_x

$$\begin{aligned}
 |0\rangle^c |\psi\rangle^t &\xrightarrow{H_P} \frac{1}{\sqrt{P}} \sum_{x \in [P]} |x\rangle^c |\psi\rangle^t \\
 &\xrightarrow{S_N} \frac{1}{\sqrt{P}} \sum_{x \in [P]} |x\rangle^c \Pi'_x |\psi\rangle^t \\
 &= \left(\frac{1}{\sqrt{P}} \sum_{x \in [P]} m_{x,y} |x\rangle^c \right) \Pi'_0 |\psi\rangle^t \\
 &\xrightarrow{H_P^\dagger} |y\rangle^c \Pi'_0 |\psi\rangle^t
 \end{aligned}$$

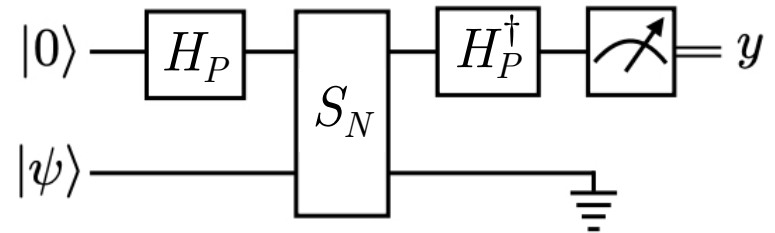

where $H_P = \frac{1}{\sqrt{P}} M$

- Solves the problem using exactly N total queries
 - Asymptotic $O(N^2)$ advantage over best known quantum circuits
- P -dimensional control, qubit target system

Outline

1. Higher-order quantum computation
 - The “quantum switch” – coherently controlling gate order
2. Hadamard Promise Problem
3. Experimentally solving the HPP with a 4-switch

Example: $N=P=4$

- Fix 4 permutations and a Hadamard matrix M

$$M = \begin{pmatrix} 1 & 1 & 1 & 1 \\ 1 & 1 & -1 & -1 \\ 1 & -1 & -1 & 1 \\ 1 & -1 & 1 & -1 \end{pmatrix}$$

$$\Pi_0 = U_4 U_3 U_2 U_1 \quad \Pi_1 = U_3 U_4 U_1 U_2$$

$$\Pi_2 = U_1 U_4 U_2 U_3 \quad \Pi_3 = U_2 U_3 U_1 U_4$$

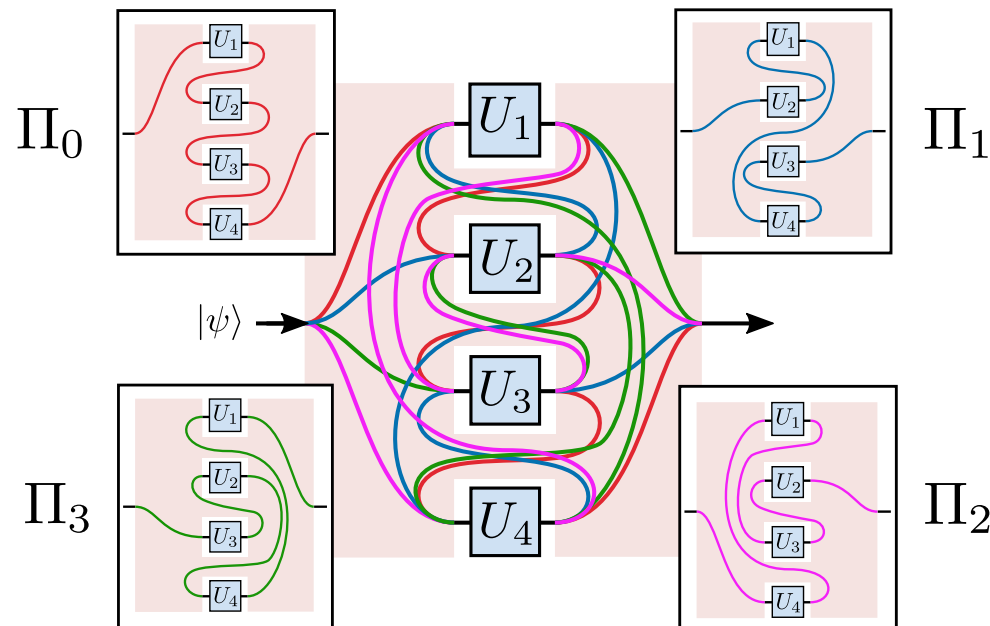

Experimental High-Dimensional Hadamards

- A sequence of 2^k balanced beamsplitters gives a Hadamard matrix

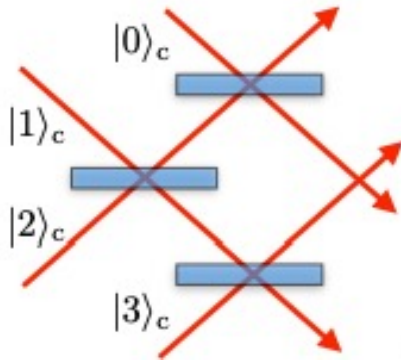

Experimental High-Dimensional Hadamards

- A sequence of 2^k balanced beamsplitters gives a Hadamard matrix

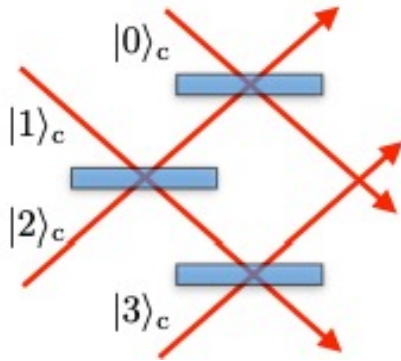

- More compactly: **multicore fibre 4-port beamsplitter**

[J. Cariñe *et al.*, *Optica* (2020)]

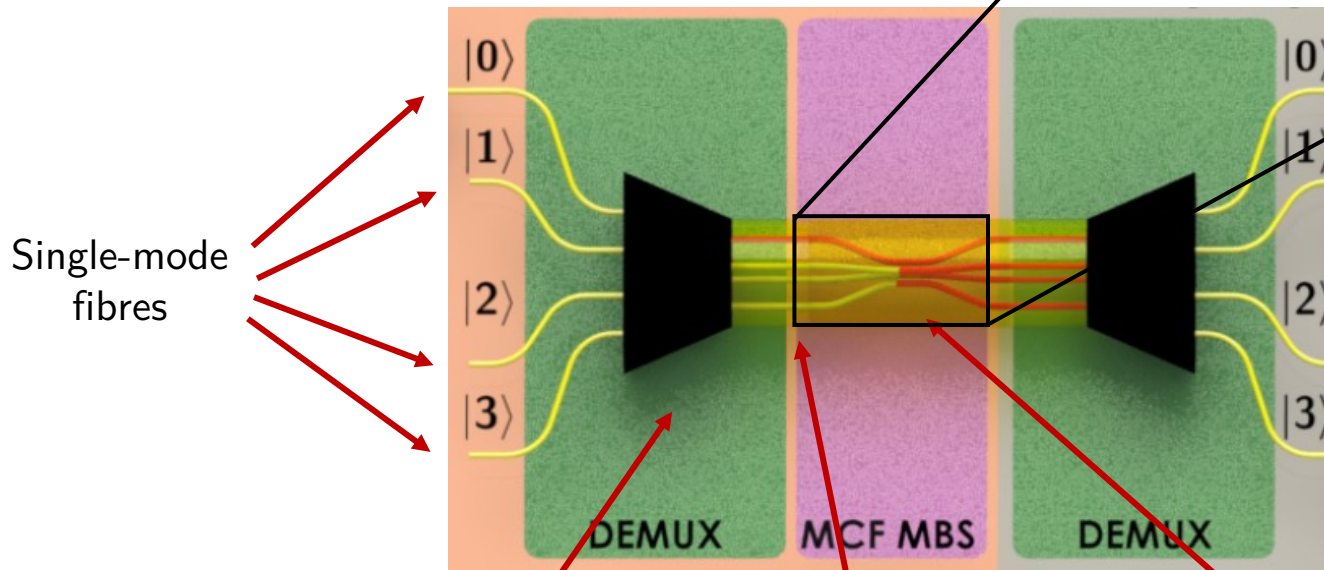
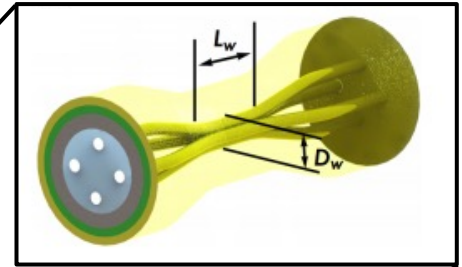

Implements

$$H_P = \frac{1}{2} \begin{pmatrix} 1 & 1 & 1 & 1 \\ 1 & 1 & -1 & -1 \\ 1 & -1 & -1 & 1 \\ 1 & -1 & 1 & -1 \end{pmatrix}$$

Spatial demultiplexer unit

4-core fibre

Evanescent-wave coupling

Photonic 4-switch Implementation

- Control system = path ququart; target system = polarisation

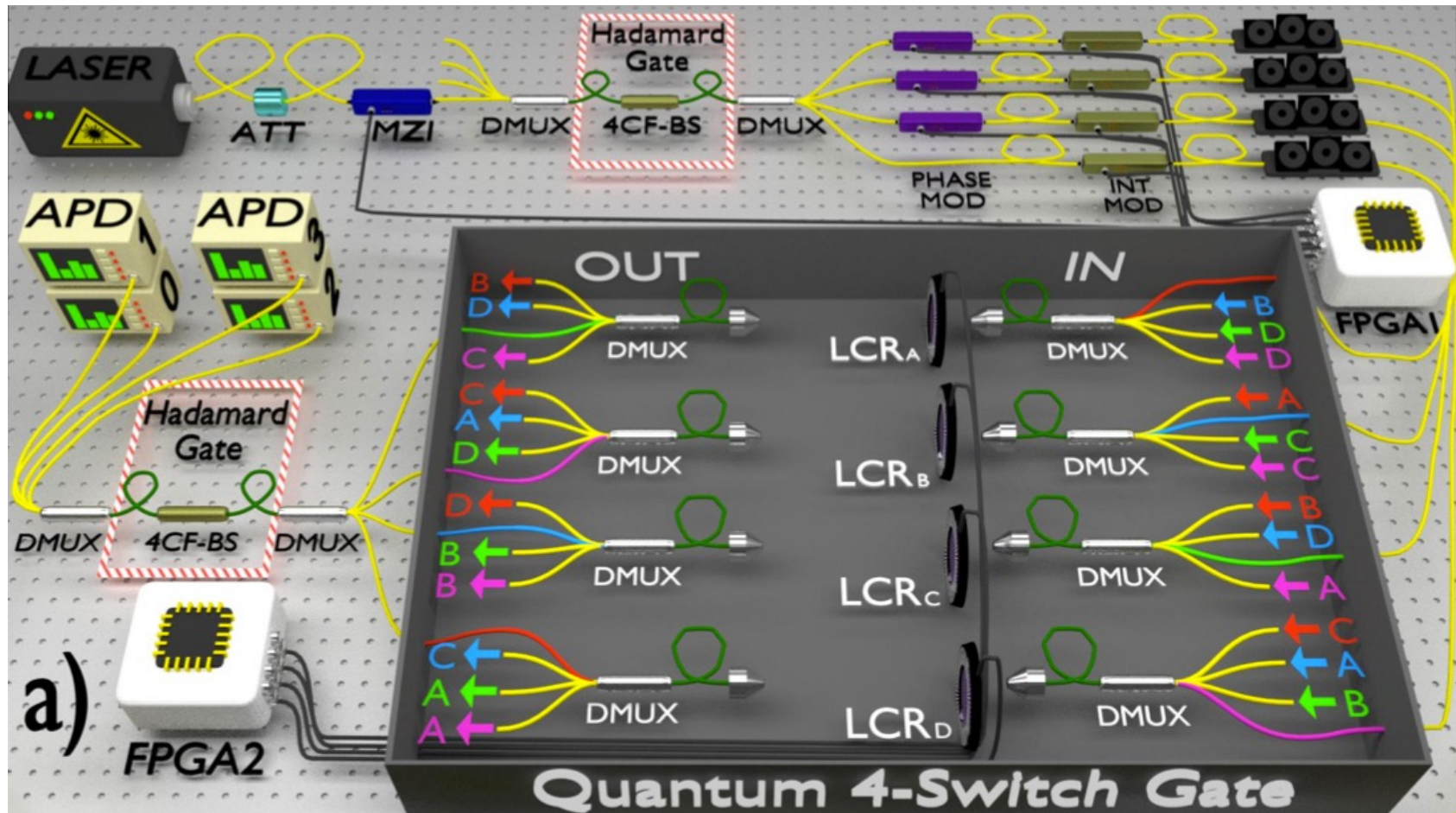

Experimentally Solving the HPP

- Implemented two different sets of unitaries

y	0	1	2	3
U_A	$\mathbb{1}$	Z	$\mathbb{1}$	Z
U_B	X	X	X	X
U_C	$\mathbb{1}$	Z	Z	$\mathbb{1}$
U_D	X	X	X	X

y	0	1	2	3
U_A	$\frac{Z+X}{\sqrt{2}}$	$\mathbb{1}$	Z	Z
U_B	$\frac{Z+X}{\sqrt{2}}$	X	X	X
U_C	$\mathbb{1}$	Z	$\mathbb{1}$	$\mathbb{1}$
U_D	$\mathbb{1}$	$\mathbb{1}$	$\mathbb{1}$	X

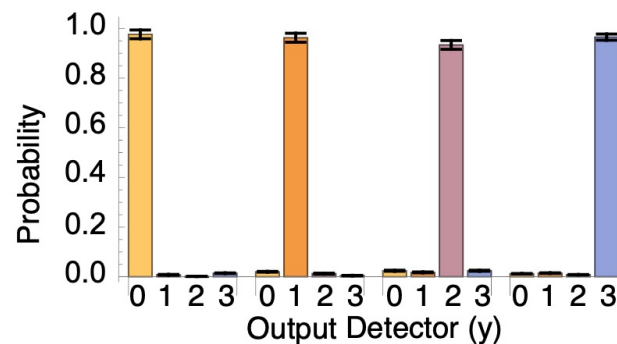
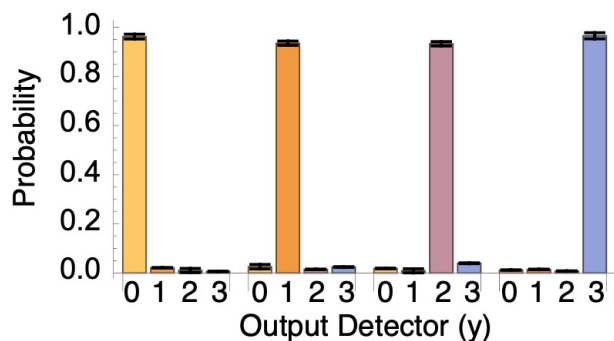

- Solved the problem with 4 total queries with $P_{\text{succ}} \approx 0.95$

Experimentally Solving the HPP

- Implemented two different sets of unitaries

y	0	1	2	3
U_A	$\mathbb{1}$	Z	$\mathbb{1}$	Z
U_B	X	X	X	X
U_C	$\mathbb{1}$	Z	Z	$\mathbb{1}$
U_D	X	X	X	X

y	0	1	2	3
U_A	$\frac{Z+X}{\sqrt{2}}$	$\mathbb{1}$	Z	Z
U_B	$\frac{Z+X}{\sqrt{2}}$	X	X	X
U_C	$\mathbb{1}$	Z	$\mathbb{1}$	$\mathbb{1}$
U_D	$\mathbb{1}$	$\mathbb{1}$	$\mathbb{1}$	X

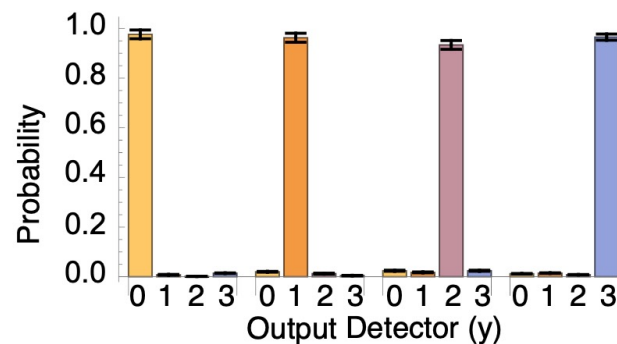
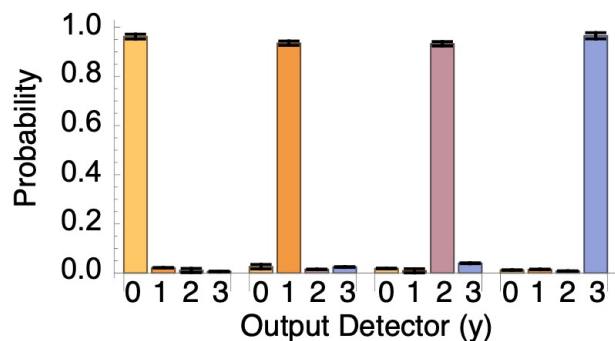

- Solved the problem with 4 total queries with $P_{\text{succ}} \approx 0.95$
- Is there an advantage over causally definite computations?

Bounding Causal Strategies

- Best P_{succ} with 4 queries in well-defined order (e.g., circuit):

Given unitaries $\{U_1^{y,i}, \dots, U_N^{y,i}\}_i$ for each y , and prior distribution $q_{y,i}$

$$\max P_{\text{succ}} = \sum_{y,i} q_{y,i} \text{Tr}[W \cdot (|y\rangle\langle y|^c \otimes \mathfrak{C}(U_1^{y,i}, \dots, U_N^{y,i}))]$$

$$\text{s.t. } W \in \mathcal{W}^{\text{causal}}$$

Process matrix

Class of computations with well defined query order

- Finding “causal bound” is a semidefinite program!

[Araújo *et al.*, NJP (2015); Wechs, **AA**, Branciard, NJP (2019)]

Bounding Causal Strategies

- Best P_{succ} with 4 queries in well-defined order (e.g., circuit):

Given unitaries $\{U_1^{y,i}, \dots, U_N^{y,i}\}_i$ for each y , and prior distribution $q_{y,i}$

$$\max P_{\text{succ}} = \sum_{y,i} q_{y,i} \text{Tr}[W \cdot (|y\rangle\langle y|^c \otimes \mathfrak{C}(U_1^{y,i}, \dots, U_N^{y,i}))]$$

$$\text{s.t. } W \in \mathcal{W}^{\text{causal}}$$

Process matrix

Class of computations with well defined query order

- Finding “causal bound” is a semidefinite program!

[Araújo *et al.*, NJP (2015); Wechs, **AA**, Branciard, NJP (2019)]

- For the sets of unitaries experimentally implemented, can have $P_{\text{succ}}=1$ with a quantum circuit!

➤ Untrusted regime

y	0	1	2	3
U_A	$\mathbb{1}$	Z	$\mathbb{1}$	Z
U_B	X	X	X	X
U_C	$\mathbb{1}$	Z	Z	$\mathbb{1}$
U_D	X	X	X	X

Bounding Causal Strategies

- 60 sets of unitaries taken from

$$\mathcal{G} = \left\{ \mathbb{1}, Z, X, Y, \frac{Z+X}{\sqrt{2}}, \frac{Z+Y}{\sqrt{2}}, \frac{X+Y}{\sqrt{2}}, \frac{\mathbb{1}+iZ}{\sqrt{2}}, \frac{\mathbb{1}+iX}{\sqrt{2}}, \frac{\mathbb{1}+iY}{\sqrt{2}} \right\}$$

- Bound: $P_{\text{succ}} \lesssim 0.92$

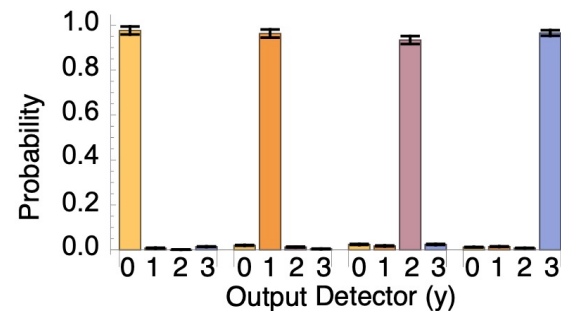

- If unitaries given in a random basis:

$$P_{\text{succ}} \lesssim 0.84$$

Bounding Causal Strategies

- 60 sets of unitaries taken from

$$\mathcal{G} = \left\{ \mathbb{1}, Z, X, Y, \frac{Z+X}{\sqrt{2}}, \frac{Z+Y}{\sqrt{2}}, \frac{X+Y}{\sqrt{2}}, \frac{\mathbb{1}+iZ}{\sqrt{2}}, \frac{\mathbb{1}+iX}{\sqrt{2}}, \frac{\mathbb{1}+iY}{\sqrt{2}} \right\}$$

- Bound: $P_{\text{succ}} \lesssim 0.92$

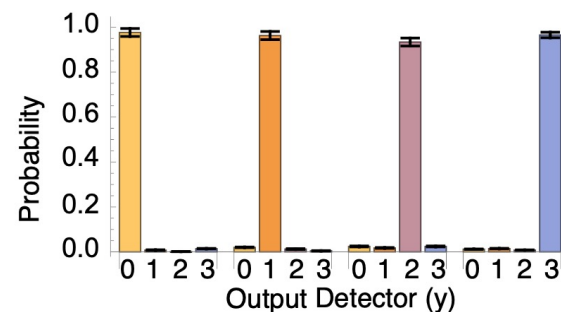

- If unitaries given in a random basis:

$$P_{\text{succ}} \lesssim 0.84$$

- Violation of bounds assuming “fair” implementation
 - No prior knowledge of sets of unitaries
- Experimentally implementing full set time-consuming, possible

Conclusions

- Query complexity advantage from superposition of query order in a problem with softer dimension constraints
- First implementation for $N > 2$ gate orders
 - (modulo philosophical discussions)
- Outlook:
 - Need more choices of unitaries to properly violate causal witness
 - More applications: communication complexity, ...
 - Coherent control of gate order beyond the N -switch

[J. Wechs, H. Dourdent, **AA**, C. Branciard, *in preparation*]

Conclusions

- Query complexity advantage from superposition of query order in a problem with softer dimension constraints
- First implementation for $N > 2$ gate orders
 - (modulo philosophical discussions)
- Outlook:
 - Need more choices of unitaries to properly violate causal witness
 - More applications: communication complexity, ...
 - **Coherent control of gate order beyond the N -switch**

[J. Wechs, H. Dourdent, **AA**, C. Branciard, *in preparation*]

arXiv:2002.07817

**Experimental computational advantage from superposition
of multiple temporal orders of quantum gates**