



HAL
open science

Preliminary non-intrusive geophysical electrical resistivity tomography surveys of a mock-up scale monitoring of an engineered barrier system at URL Tournemire

Bruna de Carvalho Faria Lima Lopes, Cédris Sachet, Philippe Sentenac, Vojtěch Beneš, Pierre Dick, Johan Bertrand, Alessandro Tarantino

► To cite this version:

Bruna de Carvalho Faria Lima Lopes, Cédris Sachet, Philippe Sentenac, Vojtěch Beneš, Pierre Dick, et al.. Preliminary non-intrusive geophysical electrical resistivity tomography surveys of a mock-up scale monitoring of an engineered barrier system at URL Tournemire. The Geology Society of London, 2019, 482, pp.331-345. 10.1144/SP482.11 . hal-02982035

HAL Id: hal-02982035

<https://hal.science/hal-02982035v1>

Submitted on 25 Jan 2021

HAL is a multi-disciplinary open access archive for the deposit and dissemination of scientific research documents, whether they are published or not. The documents may come from teaching and research institutions in France or abroad, or from public or private research centers.

L'archive ouverte pluridisciplinaire **HAL**, est destinée au dépôt et à la diffusion de documents scientifiques de niveau recherche, publiés ou non, émanant des établissements d'enseignement et de recherche français ou étrangers, des laboratoires publics ou privés.

Fiche bibliographique

N° dossier : PUB20200235

Référence :

DE CARVALHO FARIA LIMA LOPES BRUNA, SACHET Cédric, SENTENAC PHILIPPE, BENEŠ VOJTECH, DICK Pierre, BERTRAND Johan, TARANTINO ALESSANDRO

Preliminary non-intrusive geophysical electrical resistivity tomography surveys of a mock-up scale monitoring of an engineered barrier system at URL Tournemire

Geological Society Special Publications (Geological Society 2019) 331-345 | 10.1144/SP482.11 (ACL)

Auteurs dans l'ordre de la publication :

1, DE CARVALHO FARIA LIMA LOPES, BRUNA , CORRESPONDING AUTHOR

University of Strathclyde, Department of Civil and Environmental Engineering,, 65 Montrose Street, Glasgow G1 1XJ, UK, Royaume-Uni

2, SACHET, Cédric

University of Strathclyde, 1Department of Civil and Environmental Engineering, 65 Montrose Street, Glasgow G1 1XJ, Royaume-Uni

3, SENTENAC, PHILIPPE

University of Strathclyde, DEPARTMENT OF CIVIL AND ENVIRONMENTAL ENGINEERING, 65 Montrose Street, Glasgow G1 1X, Royaume-Uni

4, BENEŠ, VOJTECH

G Impuls, Přístavní 24, Praha 7, Prague 170 00, Tchéquie

5, DICK, Pierre, REFERENT

Institut de radioprotection et sûreté nucléaire, PSE-ENV/SEDRE/LETIS, Fontenay aux Roses, France

6, BERTRAND, Johan

Agence Nationale pour la Gestion des Déchets Radioactifs, Parc de la Croix Blanche, rue Jean Monnet, 92298 Chatenay Malabry, France

7, TARANTINO, ALESSANDRO

University of Strathclyde, DEPARTMENT OF CIVIL AND ENVIRONMENTAL ENGINEERING, 65 Montrose Street, Glasgow G1 1XJ, Royaume-Uni

Type : Publication écrite

Titre : Preliminary non-intrusive geophysical electrical resistivity tomography surveys of a mock-up scale monitoring of an engineered barrier system at URL Tournemire

Résumé d'auteur : Geophysical electrical resistivity tomography (ERT) is a promising measurement technique for nonintrusive monitoring of an engineered barrier system (EBS) during the operational phase of geological disposal of high-level radioactive waste. Electrical resistivity is sensitive to water content and temperature, which are the key variables characterizing the response of the EBS. In order to assess the technology readiness level of the ERT technique for EBS operational monitoring, a field demonstrator has been developed at the underground research laboratory (URL) in Tournemire (France) within the project 'Modern 2020'. Preliminary ERT surveys were carried out in January and November 2017 to establish the background resistivity of the experimental area and assess the quality of electrode installation and survey protocols. Results of the surveys confirmed that the resistivity of the host rock in the demonstrator area is quite homogenous and lower than 100 Ω m in accordance with independent measurements carried out in previous campaigns. In addition, the lesson learned from the blank tests allowed identifying key requirements for effective ERT measurements. These include the need for a 3D electrode configuration, bespoke measurement protocols designed on the basis of the sensitivity analysis of the geometric factor and the collection of reciprocal data for enhanced data quality control.

Langue : en

Revue ou ouvrage :

Intitulé de la revue ou ouvrage : Geological Society Special Publications

Abrégé ISSN :

Editeur : Geological Society

N°ISBN :

N°ISSN : 0305-8719

Date de publication : 01/01/2019

Volume :

Numéro :

Pagination : 331-345

Identifiant DOI : 10.1144/SP482.11

Informations stratégiques :

Domaine : Secteur 6 - Recherche en Radioprotection

Axe-programme : AP 003/12 - Stockage déchets et aléas naturels

Intitulé du projet : Modern2020

Type de mesure de protection :

Droits de diffusion :

Existence contrat particulier avec l'éditeur : NON

Conditions générales : Pre-prints on publicly accessible websites Post-prints on author's personal website, institutional repository, subject repository Publisher's version/PDF cannot be used Published source must be acknowledged Set statement to accompany post-print (see policy) Must link to publisher version in Lyell Collection upon publication On a non-profit server Publisher last contacted on 10/08/2015

Droits de diffusion / Postprint :

Type de restriction : restricted

Informations : <num>12</num> <period units="month">months</period> embargo

Délai d'embargo : 12

Unité : month

Droits de diffusion / Version éditeur:

Type de restriction : cannot

Informations :

Délai d'embargo : 0

Unité :

1 **Preliminary non-intrusive geophysical electrical resistivity tomography surveys of**
2 **a mock-up scale monitoring of EBS at URL Tournemire**

3 Bruna de Carvalho Faria Lima Lopes^{1*}, Cédric Sachet¹, Philippe Sentenac¹,
4 Vojtěch Beneš², Pierre Dick³, Johan Bertrand⁴ & Alessandro Tarantino¹

5 ¹*Department of Civil and Environmental Engineering, University of Strathclyde, 65 Montrose*
6 *Street Glasgow G1 1XJ, UK*

7 ²*G Impuls, Přístavní 24, Praha 7, Prague 170 00, Czech Republic*

8 ³*Institut de Radioprotection et de Sûreté Nucléaire, 31, Avenue de la Division Leclerc*
9 *Fontenay-aux-Roses 92260, France*

10 ⁴*Agence Nationale Pour La Gestion Des Déchets Radioactifs, 1-7, Rue Jean-Monnet Châtenay-*
11 *Malabry cedex 92298, France*

12 **Corresponding author (email: bruna.lopes@strath.ac.uk)*

13 ORCID: BCFL (https://orcid.org/0000-0001-7669-7236)

14 CS (https://orcid.org/0000-0002-4120-4662)

15 PD (https://orcid.org/0000-0003-3700-485X)

16 AT (https://orcid.org/0000-0001-6690-748X)

17 *Abbreviation title: Preliminary ERT surveys of mock-up EBS*

18
19 **Abstract:**

20 Geophysical Electrical Resistivity Tomography (ERT) is a promising measurement technique
21 for non-intrusive monitoring of Engineered Barrier System (EBS) during the operational phase
22 of geological disposal of high-level radioactive waste. Electrical resistivity is sensitive to water
23 content and temperature, which are the key variables characterising the response of the EBS.
24 In order to assess the technology readiness level of the ERT technique for EBS operational
25 monitoring, a field demonstrator has been developed at the URL in Tournemire (France)
26 within the project 'Modern 2020'. Preliminary ERT surveys were carried out in January and
27 November 2017 to establish the background resistivity of the experimental area and assess
28 the quality of electrode installation and survey protocols. Results of the surveys confirmed
29 that the resistivity of the host rock in the demonstrator area is quite homogenous and lower
30 than 100Ωm in accordance with independent measurements carried out in previous
31 campaigns. In addition, the lesson learned from the blank tests allowed identifying key
32 requirements for effective ERT measurements. These include the need for a 3D electrode
33 configuration, bespoke measurement protocols designed on the basis of sensitivity analysis
34 of geometric factors, and collection of reciprocal data for enhanced data quality control.

35 **Key words:** Electrical Resistivity Tomography, Engineered Barrier System, monitoring, non-
36 intrusive, geological disposal.

37

38 Introduction

39 Deep geological repository is favoured by many countries as a technically feasible and safe
40 programme for long-term disposal of high-level radioactive waste (Bredehoeft *et al.* 1978).
41 Although the selected host rock varies from country to country, all programmes consider the
42 implementation of an Engineered Barrier Systems (EBS) to directly protect and isolate the
43 waste. The material selected for the buffer surrounding waste canister as well as the material
44 that will be used to seal off the disposal galleries from the shafts leading to the surface is
45 generally based on compacted bentonite or bentonite/sand mixtures (Sellin & Leupin 2014).

46 The EBS is subjected to an inward water flow from the host rock and an outward heat flux
47 from the radioactive waste (Lin *et al.* 1995; Rothfuchs *et al.* 2004; Jockwer *et al.* 2006; White
48 *et al.* 2017). Monitoring changes in water content and temperature is therefore the key to
49 assess the performance of the EBS. EBS monitoring during the operational period cannot be
50 achieved via wired sensors installed in the buffer because wires can provide a preferential
51 pathway for radionuclide leakage as well as for water (White *et al.* 2017).

52 Geophysical electrical monitoring is potentially an ideal technique for geophysical diffuse
53 monitoring of the EBS because (i) it can be designed in a non-intrusive fashion, (ii) it allows
54 capturing local anomalies that local sensors cannot spot, and (iii) electrical resistivity is very
55 sensitive to changes in water content and temperature and is therefore very convenient to
56 monitor the EBS (Danielsen & Dahlin 2010; Korteland & Heimovaara 2015; Merritt *et al.*
57 2016; Carey *et al.* 2017; López-Sánchez *et al.* 2017; Wang *et al.* 2017; Cosenza *et al.* 2007;
58 Hermans *et al.* 2015; Merritt *et al.* 2016; Carey *et al.* 2017; López-Sánchez *et al.* 2017; Wang
59 *et al.* 2017).

60 Electrical resistivity tomography (ERT) is a well-established geophysical technique that uses
61 injection of electrical currents and measurements of the resulting voltage differential at the
62 earth's surface or in boreholes. This generates pseudo-sections displaying apparent resistivity
63 as a function of the location and electrode spacing, which in turn provides an initial picture of
64 the resistivity distribution. An inversion process of the measured data is necessary for the
65 final interpretation of the resistance data. This process transforms the apparent resistivity
66 into 2D or 3D images of the bulk electrical resistivity of the subsurface model, which is
67 discretised into a distinct number of elements of homogeneous resistivity.

68 ERT surveys have been routinely used in water exploration and contaminant flow detection
69 (de Lima *et al.* 1995; D. J. LaBrecque *et al.* 1996; Benson *et al.* 1997; Martinez-Pagan *et al.*
70 2009; Deceuster *et al.* 2013; Ntarlagiannis *et al.* 2016), engineering site investigations (Rucker
71 *et al.* 2009; Sentenac & Zielinski 2009; Banham & Pringle 2011; Jones *et al.* 2012, 2014),
72 location of buried artefacts or structures in archaeological surveys (Tonkov & Loke 2006;
73 Ullrich *et al.* 2007; Negri *et al.* 2008; Leucci & Greco 2012), as well as providing geological and

74 hydrogeological site information (Ganerød *et al.* 2006; Ramachandran *et al.* 2012; Aning *et al.*
75 2013).

76 ERT in boreholes has proven useful for environmental investigations (Daily & Owen 1991;
77 Daily *et al.* 1995; D. LaBrecque *et al.* 1996; French *et al.* 2002; Guérin 2005; Deceuster *et al.*
78 2006; Wilkinson *et al.* 2010). The method has also been demonstrated to be economically
79 efficient when using wells drilled for geotechnical pre-investigation tunnelling sites to obtain
80 information about the geology between the wells (Denis *et al.* 2002). More recently,
81 investigations using ERT in borehole have been extended to a variety of other applications
82 such as the characterization and monitoring of water infiltration (Oberdörster *et al.* 2010;
83 Coscia *et al.* 2011; Hermans *et al.* 2015) and monitoring CO₂ migration (Yang *et al.* 2015;
84 Schmidt-Hattenberger *et al.* 2016).

85 Previous researches conducted in repository-like conditions have demonstrated the potential
86 of ERT in monitoring the EBS. Rothfuchs *et al.* (2004) could detect the water intake in an
87 experiment conducted in an area at the Aespoe Hard Rock Laboratory (HRL) in Sweden. ERT
88 electrode arrays were installed in the backfill, buffer and rock and the water saturation
89 changes in those three structures were monitored for a few years. Similarly, Furche & Scuster
90 (2014) have used ERT electrodes arrays installed in the Engineered Barrier Emplacement
91 Experiment in Opalinus Clay at the Mont Terri underground laboratory in Switzerland. Several
92 ERT surveys were conducted over the 11 years of operation of the experiment to monitor
93 water intakes in different areas of the experiment. However, in both these experiments, the
94 ERT electrodes were buried inside the EBS and this arrangement is not suitable for
95 operational monitoring of the EBS. To the best of the authors' knowledge, there has been no
96 attempt to date to investigate the use of the ERT technique in a non-intrusive fashion, i.e.
97 with the electrodes positioned outside the EBS.

98 This paper presents a mock-up scale test (ERT demonstrator) conceived within the EU project
99 'Modern2020' and implemented at the Underground Research Laboratory (URL) in
100 Tournemire (France). It is intended to assess the capabilities of the Electrical Resistivity
101 Tomography as a non-intrusive technique of monitoring the Engineered Barrier System under
102 conditions as close as possible to the ones expected in the real repository. ERT electrodes
103 were installed in two boreholes drilled at either side of the buffer to perform cross-borehole
104 surveys. In the paper, three preliminary ERT surveys were carried out in January and
105 November 2017 on the shaft before the emplacement of the bentonite. These surveys were
106 aimed at a first assessment of the electrode installation technique, ERT measurement
107 protocols, and inversion procedures.

108

109 **Description of Tournemire Underground Research Laboratory**

110 *Geological context*

111 The French Institute of Radioprotection and Nuclear Safety (IRSN) uses Tournemire URL test
112 site to conduct research on geological disposal of nuclear waste in clay formations (Cabrera

113 *et al.* 2001; Gélis *et al.* 2010; Okay *et al.* 2013). Tournemire URL is located in southern France,
114 in the western border of the Causses Basin (Cabrera *et al.* 2001; Okay *et al.* 2013).

115 Fig. 1 shows the geological cross section of Tournemire. According to Okay *et al.* (2013) the
116 intermediate formation, where the tunnel is located, correspond to marls and clay-rocks and
117 is a good analogue of the Callovo-Oxfordian clay-rock in the Paris Basin, which is considered
118 to be a potential host for the long-term storage of nuclear wastes in France.

119 An old railway tunnel and six galleries are used to study the Toarcian formation (Fig. 2). In
120 general, the Toarcian formation is mainly composed of illite (5–15% weight fraction),
121 illite/smectite mixed-layer minerals (5–10% with a relative proportion of smectite of about
122 10%), chlorite (1–5%) and kaolinite (15–20%). This formation also contains 10–20% of quartz
123 grains (weight fraction), 10–40% of carbonates (mainly composed of calcite with traces of
124 dolomite and siderite) and 2–9% (in weight) of pyrite disseminated in the clay matrix
125 spreading until 160 m deep from the tunnel (Cabrera *et al.* 2001; Okay *et al.* 2013).

126 *The North-08 gallery*

127 The area selected for the ERT demonstrator at the experimental site in Tournemire URL was
128 the North-08 Gallery. The horseshoe cross-section of the North gallery is 3.7m tall and 4m
129 wide along the floor. This gallery is 20m long oriented north-south (Fig. 2).

130 On the left, approximately 3m of the area designated for the ERT demonstrator, there is a
131 water infiltration experiment (WT-1) in progress, and on the right, approximately 5m of the
132 ERT demonstrator there is an empty borehole (GN1) of 0.1m in diameter and 7.15m long,
133 located at 1.4m from the gallery floor.

134

135 **Overview of the ERT demonstrator stages**

136 The project was divided into three main stages. First stage, namely Stage 0, consisted of
137 performing two blank tests before the installation of the EBS to establish the background
138 resistivity of the rock mass. Blank test 1 comprised 2D surface measurements from the
139 North-08 Gallery wall prior to the drilling of left and right boreholes and blank test 2
140 constituted borehole measurements carried out from the left and right boreholes. Then, in
141 Stage 1, a shaft for the installation of the EBS was drilled and blank test 3 was carried out (Fig.
142 3).

143 The shaft is 60cm in diameter and approximately 9.05m long. The EBS is constituted by a 4m
144 long mixture of bentonite pellets and powder, namely mixture 3, provided by NAGRA (Garitte
145 *et al.* 2015). The average dry density of the pouring material is 1.45g/cm³ (Garitte *et al.* 2015).
146 Fig. 4 shows the particle size distribution of the material. The EBS will be closed off with a 2m
147 long concrete plug. Hydration mats will be placed on both ends of the EBS and a heater on the
148 bottom end. Two small access boreholes (Fig. 2) will be drilled perpendicular to the longitudinal
149 direction of the buffer to allow the installation of 16 local sensors: 8 Time Domain
150 Reflectometry (TDR) and 8 temperature sensors, to measure water content and temperature
151 as a way of cross-checking the geophysical measurements. For research purposes two lines of

152 16 electrodes each (0.24m spacing) will be buried inside the main shaft as well. The cross
153 section of the EBS designed for this mock-up test and the instruments setup can be seen in Fig.
154 5. The installation of the EBS is scheduled to take place in July 2018Error! Reference source not
155 found..

156 The last stage, Stage 2, consists of regularly monitoring the changes in water content and
157 temperature induced in the EBS using the local sensors and ERT measurements.

158 Several challenges surround this research experiment amongst them are: (1) electrodes
159 contact resistance problems (Day-Lewis *et al.* 2008; Danielsen & Dahlin 2010; Deceuster *et al.*
160 2013). The electrodes are installed in boreholes drilled in the rock. Usually, water is added
161 within the borehole to ensure contact in these surveys. However, this resource is not an
162 option for the ERT demonstrator since the electrode boreholes in question are horizontal. It
163 is not possible to keep water in horizontal boreholes, thus continuous injection of water
164 would be necessary in this situation, which would perturb the experiment; (2) data collection
165 and processing (Oldenborger *et al.* 2005; Day-Lewis *et al.* 2008; Wilkinson *et al.* 2008;
166 Deceuster *et al.* 2013). Borehole surveys involve several uncertainties, such as: position and
167 alignment of electrodes, selection of the most appropriate arrays and measurements
168 repeatability; (3) resolution and sensitivity of ERT in boreholes (D. LaBrecque *et al.* 1996;
169 Danielsen & Dahlin 2010; Tso *et al.* 2017).

170

171 **Data collection of preliminary surveys**

172 The main characteristics of the 2D ERT survey carried out during blank test 1 are presented in
173 Table 1. ARES II unit, manufactured by GF Instruments, was used for the data collection of
174 this blank test.

175 Two boreholes of 10cm in diameter and approximately 9.0m in length were drilled 1.20m
176 apart, on either side of the position of the EBS, accommodating 32 electrodes spaced at
177 0.29m, within an inflatable PVC tube (Fig. 6), designed and manufactured by IRSN team. The
178 inflatable system ensures contact between the electrodes and the borehole wall, as the
179 injection of water into the boreholes would potentially disturb the resistivity of the study
180 area hence it is out of question for this experiment. Cross-borehole measurements had been
181 planned for blank test 2, however one of the connectors manufactured to enable the
182 communication between the electrodes and ARES II unit did not work. As an alternative in-
183 line borehole surveys (Fig. 7a) were performed in each borehole individually and the data
184 collected from both boreholes was combined. The multiplexer that accompanies this unit
185 allows the connection of 48 electrodes in total (2 x 24 electrodes), hence the 8 most
186 superficial electrodes in each borehole were not used in these measurements (Fig. 7a). Cross-
187 borehole measurements were also performed using TERRAMETER LS ABEM unit including all
188 64 electrodes. For lack of familiarity with TERRAMETER LS ABEM unit at the time of blank test
189 2, the array used was a combination of AM-BN (Fig. 7b) - where A and B are current
190 electrodes and M and N are potential electrodes - and AB-MN (Fig. 7c), that had been
191 developed and implemented into the unit specifically for a previous IRSN research project.

192 Although part of the data collection of blank test 2 has been made on the boreholes
193 independently using in-line borehole arrays, the data collected using ARES II and
194 TERRAMETER LS ABEM units have been processed together in cross-borehole format (values
195 of geometric factor and hence resistivity were recalculated).

196 Prior to blank test 3, the shaft was drilled and two new sets of 32 electrodes each were
197 designed, manufactured and installed into the boreholes by IRSN team **Error! Reference**
198 **source not found.** Cross borehole measurements were carried out using TERRAMETER LS
199 ABEM unit. The array used was AM-BN (Fig. 7b), based on experience gained from blank test
200 2 and recommendations of other researches (Day-Lewis *et al.* 2008; Wilkinson *et al.* 2008).

201

202 Results and discussions

203 *Data quality*

204 Contact resistance checks were carried out prior to the data collection of each survey. For the
205 2D surface survey, a paste of bentonite was used to coat the electrodes wherever needed to
206 improve contact resistance. However, this resource could not be used for borehole surveys.
207 As suggested by Day-Lewis *et al.* (2008), cut-offs of 50k Ω for borehole data and 20k Ω for
208 surface data were considered, since higher values may indicate that only a limited current
209 can be injected for that electrode pair. The largest contact resistance recorded for blank test
210 1 was 3.5 k Ω , i.e. all electrodes were included. The contact resistance collected before blank
211 tests 2 and 3 are plotted in Fig. 8. Some electrodes showed contact resistance larger than 50
212 k Ω and were discarded.

213 Both units used in the three blank tests offer stacking procedure. The stack procedure
214 consists of collecting each quadripole several times and averaging the results. This procedure
215 has two clear advantages: (1) random noise is averaged out, which improves signal-to-noise
216 ratio and (2) the standard deviation (stacking error) provides means of quantifying error and
217 defining data weights for inversion. For all blank tests carried out, the minimum number of
218 stacking selected was 4 and the maximum was 8. The maximum variation coefficient
219 accepted was 2%. In practical terms, this means that if the average standard deviation of the
220 first 4 measurements for a quadripole is greater than 2% then more measurements are going
221 to be collected for that quadripole up until the maximum number selected (equal to 8 in this
222 case). The standard deviation of all data collected is then calculated and recorded, regardless
223 of whether the value is higher or lower than 2%. Data with stacking errors larger than 3%
224 were eliminated (Day-Lewis *et al.* 2008).

225 The mean stacking error of blank test 1 was 0.16% and no recorded data had stacking errors
226 larger than 3%. Fig. 9 illustrates the stacking error distribution of blank test 2 and blank test
227 3. The mean stacking error and the percentage of data larger than 3% obtained for each test
228 carried out are detailed in Table 2. The lower stacking errors observed in blank test 1
229 compared to the blank tests 2 and 3 can be justified by two main reasons, (i) the approaches
230 used to improve the electrode contacts and (ii) the survey type. In blank test 1, where surface
231 surveys were carried out, bentonite was used to improve the contact between the electrode

232 and the rock, while the electrode contacts of the other two blank tests, 2 and 3, were
233 ensured only by pressure. In addition, the protocols used for blank test 1 were well-
234 established 2D surface protocols with attested good sensitivities while the protocols of blank
235 tests 2 and 3 had not been yet properly adapted.

236 The length of the current pulse was selected equal to 300ms. Reciprocal measurements,
237 which involve swapping current and voltage electrode pairs, could not be collected due to
238 time constraints during the surveys.

239 Another concern for borehole surveys is the geometric factors, K . Geometric factors are
240 numerical multipliers used to convert the resistance R (voltage to current ratio) in apparent
241 resistivity ρ_a :

$$242 \quad \rho_a = K \cdot R$$

243 The geometric factor depends on the geometry of each electrode spacing setup. For
244 borehole surveys Wilkinson *et al.* (2008) demonstrated that large geometric sensitivities of an
245 electrode configuration occur when the geometric factor, K , changes rapidly with position. In
246 turn, this occurs when K is close to singular. In addition, K will also be large in the vicinities of
247 the singularity. Due to several operational issues, the arrays used for data collection during
248 blank test 2 were not the most suitable. Hence, a considerable amount of data collected
249 presented large K values, therefore the data collected in blank test 2 were filtered based on
250 the geometric factor, i.e. data associated with geometric factors larger than 250m^{-1} were
251 discarded. Fig. 10 shows the distribution of apparent resistivity before and after filtering out
252 measurements with high geometric factors for blank tests 2.

253 Overall, contact resistance, stacking errors, and geometric factor errors were the three
254 features used to filter the data collected in the surveys performed for the ERT demonstrator.
255 The percentage of total data removed from each survey is shown in Table 2.

256 *Inversions*

257 To investigate the benefits of filtering data according to the strategies discussed in the
258 previous section, inversions were performed on both the original and filtered data sets for
259 comparison. Table 2 shows the Root Mean Square (RMS) errors obtained from these
260 inversions.

261 Inversions were performed using the commercially available software package Res2DInv[®]
262 (Loke 2015). After carefully testing numerous inversion settings (Day-Lewis *et al.* 2008), the
263 default settings proved to be the most appropriate one. These settings were used for all
264 control parameters, which were kept identical for each inversion.

265 Tomograms plots generated from filtered data sets of blank test 1 – 2D surface survey
266 Schlumberger array; blank tests 2 – in- and cross-hole array; and blank test 3 – cross-hole
267 array are shown in Fig. 11, Fig. 12 and Fig. 13 respectively. The geometric location of WT-1
268 and GN1 are highlighted in the tomogram of blank test 1 (Fig. 11) as well as the future
269 position of the main shaft and electrodes boreholes that at this stage had not yet been
270 drilled.

271 The result of blank test 1 presented in Fig. 11 shows that higher values of resistivity are found
272 at the surface. This is reasonable since the rock face exposed to the gallery presents lower
273 degree of saturation and, hence, higher values of resistivity. Below and around 0.5m the
274 resistivity of the rock mass is fairly homogeneous with values lower than $100\Omega\text{m}$, which is
275 consistent with the results shown in blank tests 2 (Fig. 12) and 3 (Fig. 13) and also with the
276 resistivity measured in the laboratory on core samples extracted from both boreholes
277 (average of $40\Omega\text{m}$). Cosenza *et al.* (2007) and Gélis *et al.* (2016) also reported similar results
278 in terms of resistivity of Tournemire's core samples and 2D ERT surveys in Tournemire URL
279 respectively.

280 In blank test 1, there is an area of high resistivity (between chainage 14 and 17m) that could
281 suggest the presence of an anomaly. This anomaly could be related to the WT-1 shaft, which
282 is empty in the first 3.4m. There is another area of high resistivity in the model between
283 chainage 12 and 13.2m that extends to almost 2m into the wall. From all the field data and
284 information gathered so and made available by the IRSN team, there is nothing in this latest
285 segment that could justify such a high resistivity. Thus, a possible interpretation of these
286 results is that the high resistivity along the segment 14 and 17m is an artefact and WT-1 shaft
287 is actually associated with the high resistivity area between 12 and 13.2m. To investigate the
288 issue further, an inversion was tested with a priori resistivity information of WT-1 and GN1.
289 The inversion results have created an even larger artefact of high resistivity over almost the
290 whole model and the RMS error of this inversion has doubled. As the RMS indicates the
291 mismatch between the forward and calculated models, these results were not considered
292 satisfactory. Therefore, it was speculated that the problem stemmed from a 2D inversion
293 algorithms used to invert data of 3D bodies located outside the image plane (Nimmer *et al.*
294 2008).

295 The empty shaft of WT-1 presents virtually infinite resistivity and is by-passed by the current,
296 which follows more conductive paths. The stainless steel lid (35cm thick) is located at 3.4m
297 depth into the WT-1 shaft likely affecting the resistivity measurements (although the lid itself
298 is outside of the area of the inversion). Furthermore, WT-1 is located towards the edge of the
299 area covered by the inversion model, which is highly affected by boundary effects. As a
300 result, WT-1 is not clearly detected.

301 Blank test 2 (Fig. 12) was a combination of data collected from arrays involving in-hole and
302 cross-hole quadripoles combinations. The data was processed in cross-borehole format,
303 treated according to the procedure described in the data quality session and inverted. Fig. 12
304 shows that the resistivity between the two boreholes is somehow homogeneous and lower
305 than $100\Omega\text{m}$. The area of higher resistivity around the electrodes and in the middle of the
306 model (around 5m depth) is most likely due to artefacts created by the noise survey. A
307 considerable number of negative apparent resistivity data was collected during blank test 2.
308 This negative apparent resistivity does not appear to be real, since virtually no negative
309 apparent resistivity remained after filtering the data according to the data quality procedure
310 (Fig. 10).

311 Blank test 3 (Fig. 13) has an empty shaft (0.6cm in diameter and 9.05m in length) in the
312 middle of the cross borehole model, which should be characterised by high resistivity values.
313 However, higher resistivity values (greater than $500\Omega\text{m}$) can only be spotted in the first 2.0m
314 of the model, close to the gallery wall. This inconsistency was expected due to the presence
315 of the shaft. The current flow is expected to act three dimensionally avoiding the volume of
316 high resistivity. Inverting the data collected in the blank test 3 using a 3D algorithm would not
317 improve the results. The problem of this survey is the data collection itself. The main shaft
318 represents a 3D body characterised by virtually infinite resistivity. Although there has been a
319 significant improvement in the protocol used for blank test 3 when compared to the one
320 used on blank test 2, the site characteristics were very difficult to capture using 2D surveys.

321 To test this hypothesis a 3D synthetic model was created reproducing the site characteristics
322 (Fig. 14a). The model has 2.4m x 2.6m x 10m with background resistivity of $40\Omega\text{m}$, replicating
323 the resistivity of the core rock samples tested in laboratory, and a shaft of 0.6m x 0.6m x
324 9.05m in the middle with resistivity of $1\text{E}+15\Omega\text{m}$, representing the empty shaft. The synthetic
325 data were created in 3D, without adding noise, but the protocol used was the same of blank
326 test 3. Firstly, the data were inverted using a 3D algorithm (RES3DInv[®] - (Loke 2017)), and the
327 tomography result can be observed in Fig. 14b. Apart from a few artefacts of high resistivity
328 around the edges, the resistivity of the whole model is homogeneous and around $100\Omega\text{m}$.
329 Therefore, the high resistivity body representing the main shaft is not characterised in the
330 tomography results. Then, the same data were inverted using a 2D algorithm and the
331 tomography result is presented in Fig. 14c. The highest resistivity value observed is $250\Omega\text{m}$
332 in the centre towards the bottom of the model. Outside this area, the resistivity of the model is
333 homogenous and around $100\Omega\text{m}$. The higher resistivity observed in the 2D inverted model is
334 not enough to characterise precisely the empty shaft. Therefore, the outcome shows that the
335 2D protocol used in blank test 3 was unable to capture the main empty shaft regardless of
336 the inverted algorithm used.

337 For the monitoring stages of this experiment, protocols need to be improved and tested by
338 means of forward modelling and sensitivity analysis to ensure the quality of the data
339 collected and consistency of the inversion results. The possibility of adding a third borehole
340 to install electrodes at the top of the main shaft is currently being examined. This additional
341 set of electrodes could improve the tomography images. In this way, the data can be
342 collected in a real 3D fashion and inverted using 3D algorithm.

344 Conclusions

345 This paper has presented the preliminary Electrical Resistivity Tomography surveys of the ERT
346 demonstrator carried out in Tournemire URL. This demonstrator is aimed to investigate the
347 potential of ERT as non-invasive monitoring of the thermo-hydraulic response of the
348 Engineered Barrier System (EBS) during the operational stage. The blank test surveys have
349 allowed characterising the resistivity of the host rock and, most importantly, have allowed
350 identifying the most suitable ERT protocols to be adopted in the next stages of the project
351 when the EBS will be put in place.

352 Results obtained from laboratory experiments performed on core samples extracted from
353 different depths during the drilling process suggested that the resistivity of the host rock is
354 homogeneous and around $40\Omega\text{m}$. The homogeneity of the host rock was indeed
355 confirmed by blank test 1 and blank test 2, with consistent resistivity values lower than
356 $100\Omega\text{m}$. The methodology developed for the electrode installation based on the use of PVC
357 half-tubes pushed against the borehole wall by inflatable pipes has proved to be successful.
358 However, electrodes contact resistance remains a challenge that need to be addressed.

359 Inspection of the tomograms derived from in- and cross-hole array has highlighted the
360 drawbacks of the protocols used and suggested the modifications to be introduced in the
361 next stage of the experimental programme. In particular, the lesson learned from the blank
362 tests allowed the following actions to be put in place:

- 363 • Since the problem is clearly 3D, electrodes should be placed in 3D configuration, i.e. a
364 third electrode array should be added at the top of the main shaft to complement the
365 two arrays located laterally to the main shaft (on the left-hand and right-hand sides
366 respectively). In this way, data can be collected in 3D fashion and inverted using 3D
367 inversion algorithms. This measure should reduce the appearance of artefacts and
368 allow generating enhanced tomography images;
- 369 • New measurement protocols suitable for in-hole and cross-hole need to be
370 developed to allow for more efficient data collection in terms of measurement time
371 and adequate geometric factors. To ensure the quality of the measurement protocols,
372 sensitivity analysis should be carried out on various protocol datasets complemented
373 by similar analysis using synthetic data via forward model;
- 374 • Reciprocal data should be collected to allow for enhanced data quality control.

375

376 Acknowledgements

377 The authors wish to acknowledge the support of the European Commission via the project
378 MODERN2020 'Development and Demonstration of monitoring strategies and technologies
379 for geological disposal' (Grant Agreement number: 662177-Modern2020-NFRP-2014-2015)
380 under the H2020 Euratom Research and Training Programme. We also thank ANDRA and
381 IRSN for the funding support. And we thank Patrice Desveaux and Bruno Combes for their
382 support in the experiments and for manufacturing the electrodes.

383

384 References

- 385 Aning, A.A., Tucholka, P. & Danuor, S.K. 2013. 2D Electrical Resistivity Tomography (ERT)
386 Survey using the Multi-Electrode Gradient Array at the Bosumtwi Impact Crater ,. **3**, 12–
387 27.
- 388 Banham, S. & Pringle, J.K. 2011. Geophysical and intrusive site investigations to detect an
389 abandoned coal-mine access shaft, Apedale, Staffordshire, UK. *Near Surface Geophysics*,
390 **9**, 483–496.

- 391 Benson, A.K., Payne, K.L. & Stubben, M.A. 1997. Mapping groundwater contamination using
392 dc resistivity and VLF geophysical methods—A case study. *Geophysics*, **62**, 80–86,
393 <https://doi.org/10.1190/1.1444148>.
- 394 Bredehoeft, J.D., England, A.W., Stewart, D.B., Trask, N.J. & Winograd, I.J. 1978. *Geologic*
395 *Disposal of High-Level Radioactive Wastes- Earth-Science Perspectives*.
- 396 Cabrera, J., Beaucaire, C., et al. 2001. *Projet Tournemire – Synthèse Des Programmes de*
397 *Recherche 1995–1999. Report #IPSN DPRE/SERGD*. Paris.
- 398 Carey, A.M., Paige, G.B., Carr, B.J. & Dogan, M. 2017. Forward modeling to investigate
399 inversion artifacts resulting from time-lapse electrical resistivity tomography during
400 rainfall simulations. *Journal of Applied Geophysics*, **145**, 39–49,
401 <https://doi.org/10.1016/j.jappgeo.2017.08.002>.
- 402 Coscia, I., Greenhalgh, S.A., et al. 2011. 3D crosshole ERT for aquifer characterization and
403 monitoring of infiltrating river water. *Geophysics*, **76**, G49–G59,
404 <https://doi.org/10.1190/1.3553003>.
- 405 Cosenza, P., Ghorbani, A., Florsch, N. & Revil, A. 2007. Effects of drying on the low-frequency
406 electrical properties of Tournemire argillites. *Pure and Applied Geophysics*, **164**, 2043–
407 2066, <https://doi.org/10.1007/s00024-007-0253-0>.
- 408 Daily, W. & Owen, E. 1991. Cross-borehole resistivity tomography. *Geophysics*, **56**, 1228–
409 1235.
- 410 Daily, W., Ramirez, A., LaBrecque, D. & Barber, W. 1995. Electrical resistance tomography
411 experiments at the Oregon Graduate Institute. *Journal of Applied Geophysics*, **33**, 227–
412 237, [https://doi.org/10.1016/0926-9851\(95\)90043-8](https://doi.org/10.1016/0926-9851(95)90043-8).
- 413 Danielsen, B.E. & Dahlin, T. 2010. Numerical modelling of resolution and sensitivity of ERT in
414 horizontal boreholes. *Journal of Applied Geophysics*, **70**, 245–254,
415 <https://doi.org/10.1016/j.jappgeo.2010.01.005>.
- 416 Day-Lewis, F.D., Johnson, C.D., Singha, K. & Lane Jr, J.W. 2008. *Best Practices in Electrical*
417 *Resistivity Imaging: Data Collection and Processing, and Application to Data from*
418 *Corinna, Maine*.
- 419 de Lima, O.A.L., Sato, H.K. & Porsani, M.J. 1995. Imaging industrial contaminant plumes with
420 resistivity techniques. *Journal of Applied Geophysics*, **34**, 93–108,
421 [https://doi.org/10.1016/0926-9851\(95\)00014-3](https://doi.org/10.1016/0926-9851(95)00014-3).
- 422 Deceuster, J., Delgranche, J. & Kaufmann, O. 2006. 2D cross-borehole resistivity
423 tomographies below foundations as a tool to design proper remedial actions in covered
424 karst. *Journal of Applied Geophysics*, **60**, 68–86,
425 <https://doi.org/10.1016/j.jappgeo.2005.12.005>.
- 426 Deceuster, J., Kaufmann, O. & Camp, M. Van. 2013. Automated identification of changes in
427 electrode contact properties for long-term permanent ERT monitoring experiments.
428 *Geophysics*, **78**, E79–E94, <https://doi.org/10.1190/GEO2012-0088.1>.
- 429 Denis, A., Marache, A., Obellianne, T. & Breyse, D. 2002. Electrical resistivity borehole
430 measurements: Application to an urban tunnel site. *Journal of Applied Geophysics*, **50**,

- 431 319–331, [https://doi.org/10.1016/S0926-9851\(02\)00150-7](https://doi.org/10.1016/S0926-9851(02)00150-7).
- 432 French, H.K., Hardbattle, C., Binley, A., Winship, P. & Jakobsen, L. 2002. Monitoring snowmelt
433 induced unsaturated flow and transport using electrical resistivity tomography. *Journal*
434 *of Hydrology*, **267**, 273–284, [https://doi.org/10.1016/s0022-1694\(02\)00156-7](https://doi.org/10.1016/s0022-1694(02)00156-7).
- 435 Furche, M. & Scuster, K. 2014. *Long-Term Performance of Engineered Barrier Systems PEBS*.
- 436 Ganerød, G.V., Rønning, J.S., Dalsegg, E., Elvebakk, H., Holmøy, K., Nilsen, B. & Braathen, A.
437 2006. Comparison of geophysical methods for sub-surface mapping of faults and
438 fracture zones in a section of the Viggja road tunnel, Norway. *Bulletin of Engineering*
439 *Geology and the Environment*, **65**, 231–243, [https://doi.org/10.1007/s10064-006-0041-](https://doi.org/10.1007/s10064-006-0041-6)
440 6.
- 441 Garitte, B., Weber, H. & Müller, H.R. 2015. *Requirements, Manufacturing and QC of the Buffer*
442 *Components Report LUCOEX – WP2*.
- 443 Gélis, C., Revil, A., et al. 2010. Potential of electrical resistivity tomography to detect fault
444 zones in limestone and argillaceous formations in the experimental platform of
445 Tournemire, France. *Pure and Applied Geophysics*, **167**, 1405–1418,
446 <https://doi.org/10.1007/s00024-010-0097-x>.
- 447 Gélis, C., Noble, M., Cabrera, J., Penz, S., Chauris, H. & Cushing, E.M. 2016. Ability of High-
448 Resolution Resistivity Tomography to Detect Fault and Fracture Zones: Application to
449 the Tournemire Experimental Platform, France. *Pure and Applied Geophysics*, **173**, 573–
450 589, <https://doi.org/10.1007/s00024-015-1110-1>.
- 451 Guérin, R. 2005. Borehole and surface-based hydrogeophysics. *Hydrogeology Journal*, **13**,
452 251–254, <https://doi.org/10.1007/s10040-004-0415-4>.
- 453 Hermans, T., Wildemeersch, S., Jamin, P., Orban, P., Brouyère, S., Dassargues, A. & Nguyen, F.
454 2015. Quantitative temperature monitoring of a heat tracing experiment using cross-
455 borehole ERT. *Geothermics*, **53**, 14–26,
456 <https://doi.org/10.1016/j.geothermics.2014.03.013>.
- 457 Jockwer, N., Wiczorek, K., Miehe, R. & Diaz, A.M.F. 2006. *Heater Test in the Opalinus Clay of*
458 *the Mont Terri URL Gas Release and Water Redistribution*.
- 459 Jones, G., Zielinski, M. & Sentenac, P. 2012. Mapping desiccation fissures using 3-D electrical
460 resistivity tomography. *Journal of Applied Geophysics*, **84**, 39–51,
461 <https://doi.org/10.1016/j.jappgeo.2012.06.002>.
- 462 Jones, G., Sentenac, P. & Zielinski, M. 2014. Desiccation cracking detection using 2-D and 3-D
463 Electrical Resistivity Tomography : Validation on a flood embankment. *Journal of*
464 *Applied Geophysics*, **106**, 196–211, <https://doi.org/10.1016/j.jappgeo.2014.04.018>.
- 465 Korteland, S.A. & Heimovaara, T. 2015. Quantitative inverse modelling of a cylindrical object
466 in the laboratory using ERT: An error analysis. *Journal of Applied Geophysics*, **114**, 101–
467 115, <https://doi.org/10.1016/j.jappgeo.2014.10.026>.
- 468 LaBrecque, D., Miletto, M., Daily, W., Ramirez, A. & Owen, E. 1996. The effects of noise on
469 Occam’s inversion of resistivity tomography data. *Geophysics*, **61**, 538–548.

- 470 LaBrecque, D.J., Ramirez, A.L., Daily, W.D., Binley, A.M. & Schima, S.A. 1996. ERT monitoring
 471 of environmental remediation processes. *Measurement Science and Technology*, **7**, 375–
 472 383, <https://doi.org/10.1088/0957-0233/7/3/019>.
- 473 Leucci, G. & Greco, F. 2012. 3D ERT Survey to Reconstruct Archaeological Features in the
 474 Subsoil of the ‘ Spirito Santo ’ Church Ruins at the Site of Occhiolà (Sicily , Italy).
 475 *Archaeology*, **1**, 1–6, <https://doi.org/10.5923/j.archaeology.20120101.01>.
- 476 Lin, W., Wilder, D.G., et al. 1995. A Heated Large Block Test for High Level Nuclear Waste
 477 Management 2. *In: 2nd International Conference on Mechanics of Jointed and Faulted*
 478 *Rock (MJFR-2)*. Vienna.
- 479 Loke, M.H. 2015. RES2DINV. Rapid 2-D Resistivity & IP inversion using the least-squares
 480 method. 127P.
- 481 Loke, M.H. 2017. *Rapid 3-D Resistivity & IP Inversion Using the Least-Squares Method*.
- 482 López-Sánchez, M., Mansilla-Plaza, L. & Sánchez-de-laOrden, M. 2017. Geometric factor and
 483 influence of sensors in the establishment of a resistivity-moisture relation in soil
 484 samples. *Journal of Applied Geophysics*, **145**, 1–11,
 485 <https://doi.org/10.1016/j.jappgeo.2017.07.011>.
- 486 Martínez-Pagan, P., Faz, A. & Aracil, E. 2009. The use of 2D electrical tomography to assess
 487 pollution in slurry ponds of the Murcia region, SE Spain. *Near Surface Geophysics*, **7**, 49–
 488 61, <https://doi.org/10.3997/1873-0604.2008033>.
- 489 Merritt, A.J., Chambers, J.E., Wilkinson, P.B., West, L.J., Murphy, W., Gunn, D. & Uhlemann, S.
 490 2016. Measurement and modelling of moisture-electrical resistivity relationship of fine-
 491 grained unsaturated soils and electrical anisotropy. *Journal of Applied Geophysics*, **124**,
 492 155–165, <https://doi.org/10.1016/j.jappgeo.2015.11.005>.
- 493 Negri, S., Leucci, G. & Mazzone, F. 2008. High resolution 3D ERT to help GPR data
 494 interpretation for researching archaeological items in a geologically complex subsurface.
 495 *Journal of Applied Geophysics*, **65**, 111–120,
 496 <https://doi.org/10.1016/j.jappgeo.2008.06.004>.
- 497 Nimmer, R.E., Osiensky, J.L., Binley, A.M. & Williams, B.C. 2008. Three-dimensional effects
 498 causing artifacts in two-dimensional, cross-borehole, electrical imaging. *Journal of*
 499 *Hydrology*, **359**, 59–70, <https://doi.org/10.1016/j.jhydrol.2008.06.022>.
- 500 Ntarlagiannis, D., Robinson, J., Soupios, P. & Slater, L. 2016. Field-scale electrical geophysics
 501 over an olive oil mill waste deposition site: Evaluating the information content of
 502 resistivity versus induced polarization (IP) images for delineating the spatial extent of
 503 organic contamination. *Journal of Applied Geophysics*, **135**, 418–426,
 504 <https://doi.org/10.1016/j.jappgeo.2016.01.017>.
- 505 Oberdörster, C., Vanderborght, J., Kemna, A. & Vereecken, H. 2010. Investigating Preferential
 506 Flow Processes in a Forest Soil Using Time Domain Reflectometry and Electrical
 507 Resistivity Tomography. *Vadose Zone Journal*, **9**, 350–361,
 508 <https://doi.org/10.2136/vzj2009.0073>.
- 509 Okay, G., Cosenza, P., Ghorbani, A., Camerlynck, C., Cabrera, J., Florsch, N. & Revil, A. 2013.
 510 Localization and characterization of cracks in clay-rocks using frequency and time-

- 511 domain induced polarization. *Geophysical Prospecting*, **61**, 134–152,
512 <https://doi.org/10.1111/j.1365-2478.2012.01054.x>.
- 513 Oldenborger, G.A., Routh, P.S. & Knoll, M.D. 2005. Sensitivity of electrical resistivity
514 tomography data to electrode position errors. *Geophys. J. Int.*, 1–9,
515 <https://doi.org/10.1111/j.1365-246X.2005.02714.x>.
- 516 Ramachandran, K., Tapp, B., Rigsby, T. & Lewallen, E. 2012. Imaging of fault and fracture
517 controls in the arbuckle-simpson aquifer, Southern Oklahoma, USA, through electrical
518 resistivity sounding and tomography methods. *International Journal of Geophysics*, 1–
519 10, <https://doi.org/10.1155/2012/184836>.
- 520 Rothfuchs, T., Mieke, R., Moog, H. & Wieczorek, K. 2004. *Geoelectric Investigation of*
521 *Bentonite Barrier Saturation*.
- 522 Rucker, D.F., Levitt, M.T. & Greenwood, W.J. 2009. Three-dimensional electrical resistivity
523 model of a nuclear waste disposal site. *Journal of Applied Geophysics*, **69**, 150–164,
524 <https://doi.org/10.1016/j.jappgeo.2009.09.001>.
- 525 Schmidt-Hattenberger, C., Bergmann, P., Labitzke, T., Wagner, F. & Rippe, D. 2016.
526 Permanent crosshole electrical resistivity tomography (ERT) as an established method
527 for the long-term CO₂ monitoring at the Ketzin pilot site. *International Journal of*
528 *Greenhouse Gas Control*, **52**, 432–448, <https://doi.org/10.1016/j.ijggc.2016.07.024>.
- 529 Sellin, P. & Leupin, O.X. 2014. The use of clay as an engineered barrier in radioactive-waste
530 management - A review. *Clays and Clay Minerals*, **61**, 477–498,
531 <https://doi.org/10.1346/CCMN.2013.0610601>.
- 532 Sentenac, P. & Zielinski, M. 2009. Clay fine fissuring monitoring using miniature geo-electrical
533 resistivity arrays. *Environmental Earth Sciences*, **59**, 205–214,
534 <https://doi.org/10.1007/s12665-009-0017-5>.
- 535 Tonkov, N. & Loke, M.H. 2006. A resistivity survey of a burial mound in the ‘Valley of the
536 Thracian Kings’. *Archaeological Prospection*, **13**, 129–136,
537 <https://doi.org/10.1002/arp.273>.
- 538 Tso, C.H.M., Kuras, O., et al. 2017. Improved characterisation and modelling of measurement
539 errors in electrical resistivity tomography (ERT) surveys. *Journal of Applied Geophysics*,
540 **146**, 103–119, <https://doi.org/10.1016/j.jappgeo.2017.09.009>.
- 541 Ullrich, B., Guenther, T. & Ruecker, C. 2007. Electrical Resistivity Tomography Methods for
542 Archaeological Prospection. *Geophysical Prospecting*, 1–7.
- 543 Wang, J., Zhang, X. & Du, L. 2017. A laboratory study of the correlation between the thermal
544 conductivity and electrical resistivity of soil. *Journal of Applied Geophysics*, **145**, 12–16,
545 <https://doi.org/10.1016/j.jappgeo.2017.07.009>.
- 546 White, M., Farrow, J. & Crawford, M. 2017. *Deliverable D2.1 : Repository Monitoring*
547 *Strategies and Screening Methodologies*.
- 548 Wilkinson, P.B., Chambers, J.E., Lelliott, M., Wealthall, G.P. & Ogilvy, R.D. 2008. Extreme
549 sensitivity of crosshole electrical resistivity tomography measurements to geometric
550 errors. *Geophysical Journal International*, **173**, 49–62, <https://doi.org/10.1111/j.1365->

551 246X.2008.03725.x.

552 Wilkinson, P.B., Meldrum, P.I., Kuras, O., Chambers, J.E., Holyoake, S.J. & Ogilvy, R.D. 2010.
553 High-resolution Electrical Resistivity Tomography monitoring of a tracer test in a
554 confined aquifer. *Journal of Applied Geophysics*, **70**, 268–276,
555 <https://doi.org/10.1016/j.jappgeo.2009.08.001>.

556 Yang, X., Lassen, R.N., Jensen, K.H. & Looms, M.C. 2015. Monitoring CO₂ migration in a
557 shallow sand aquifer using 3D crosshole electrical resistivity tomography. *International*
558 *Journal of Greenhouse Gas Control*, **42**, 534–544,
559 <https://doi.org/10.1016/j.ijggc.2015.09.005>.

560

561 Figure captions

562 Fig. 1. Geological cross section of Tournemire URL.

563 Fig. 2. Position of the galleries at the experimental site.

564 Fig. 3. Overview of ERT demonstrator stages, preliminary surveys – blank tests 1, 2 and 3.

565 Fig. 4. *Bentonite pellets and powder particle size distribution* (Garitte et al. 2015).

566 Fig. 5. Cross section of *Engineered Barrier System setup*.

567 Fig. 6. *Scheme of electrodes setup used for blank test 2 and 3 developed by IRSN*.

568 Fig. 7. (a) ERT protocol used for blank test 2 with ARES II unit – in-line array, (b) ERT protocol
569 used for blank test 2 with TERRAMETER LS – cross-borehole array AM-BN (c) ERT protocol
570 used for blank test 2 with TERRAMETER LS – cross-borehole array AB-MN, where A and B are
571 current electrodes and M and N are potential electrodes.

572 Fig. 8. *Electrodes resistance contacts (a) blank test 2 and (b) blank test 3*.

573 Fig. 9. *Stacking errors (a) blank test 2 and (b) blank test 3*.

574 Fig. 10. *Distribution of apparent resistivity before and after filtering out measurements*
575 *associated with large geometric factors, black and grey bars respectively, for blank test 2*.

576 Fig. 11. *Blank test 1: 2D surface survey, Schlumberger array (GN1 and WT-1 indicated by black*
577 *rectangles and main shaft and electrodes boreholes of ERT demonstrator area indicated by*
578 *black dashed rectangles).*

579 Fig. 12. *Blank test 2: borehole survey*.

580 Fig. 13. *Blank test 3: cross borehole survey (buffer shaft indicated by black rectangle)*.

581 Fig. 14. Synthetic data analysis. (a) 3D model (Model 2.4 x 2.6 x 10m, shaft 0.6 x 0.6 x 9.05m)
582 (b) Perspective and cross section (at same plane where electrode boreholes are) view of 3D
583 Data inverted using 3D algorithm and the AM-BN protocol of Blank test 3 and (c) 3D Data
584 inverted using 2D algorithm and the AM-BN protocol of Blank test 3 (where A and B are
585 current electrodes and M and N potential electrodes).

586 **Table 1.** *Main characteristics of blank test 1.*

Electrodes spacing	0.4m
Total number of electrodes	48
Total length	18.8m
Position of electrodes in z-axis	1.4m from the gallery floor
First electrode (EI 0) in x-axis	On the right: standing on Gallery North_08 and facing the ERT demonstrator location
Measurement type	2D surface
Unit used	ARES II
Array used	Schlumberger
Electrodes used	Conventional metal sticks (surface)

587

588 **Table 2.** *Summary of number of data collected, stacking errors recorded, percentage of data*
 589 *removed in all blank tests and RMS errors obtained from inversions performed on original and*
 590 *filtered data sets.*

Surveys	Total No. of data	Mean stacking error (%)	Data stacking error > 3% (%)	Data removed (%)	Original data RMS (%)	Filtered data RMS (%)
Blank test 1	522	0.16	0.0	0.0	9.20	-
Blank test 2	1831	6.91	18.51	46.0	30.72	12.69
Blank test 3	1059	2.22	13.4	14.5	7.18	5.64

591

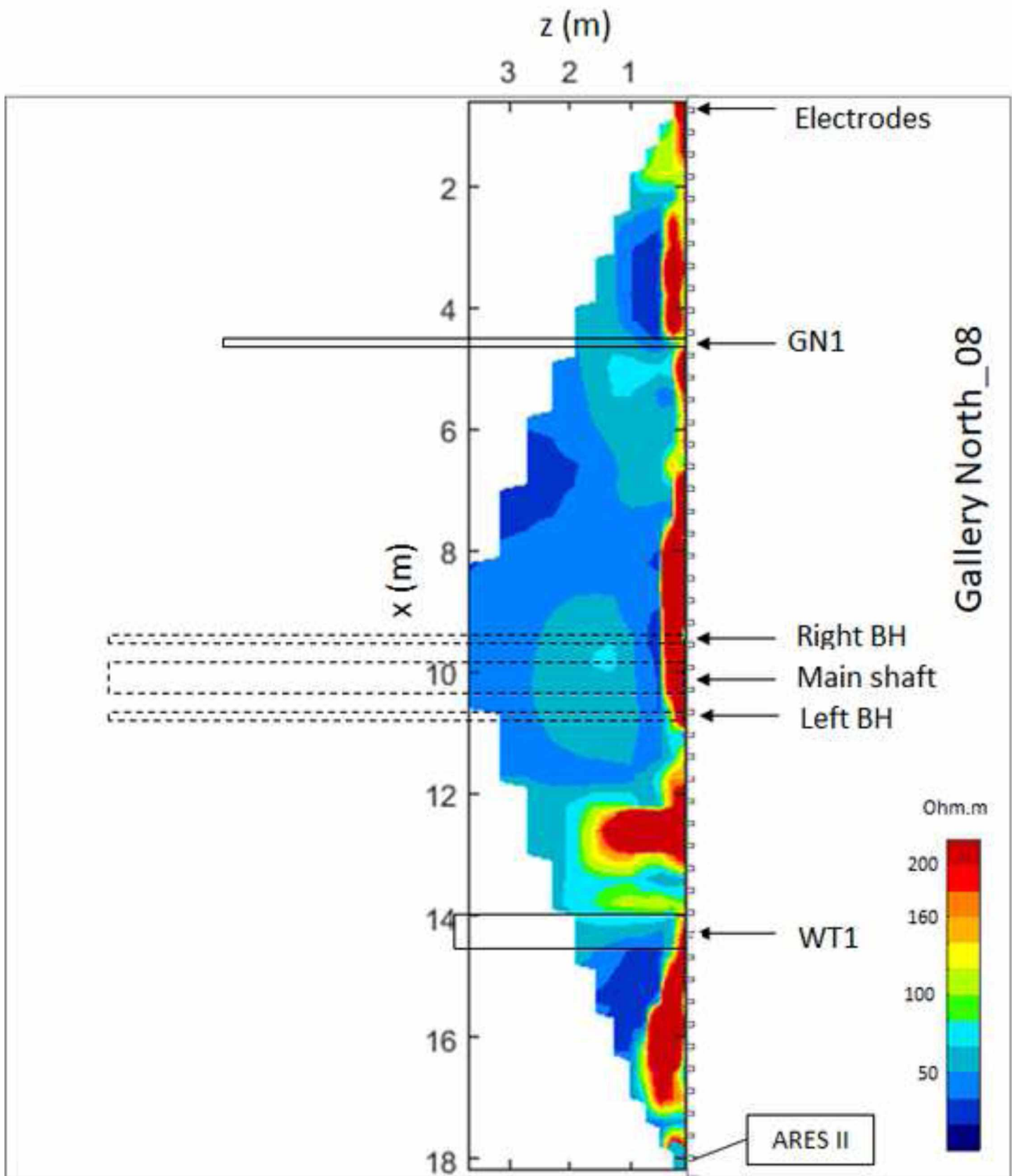

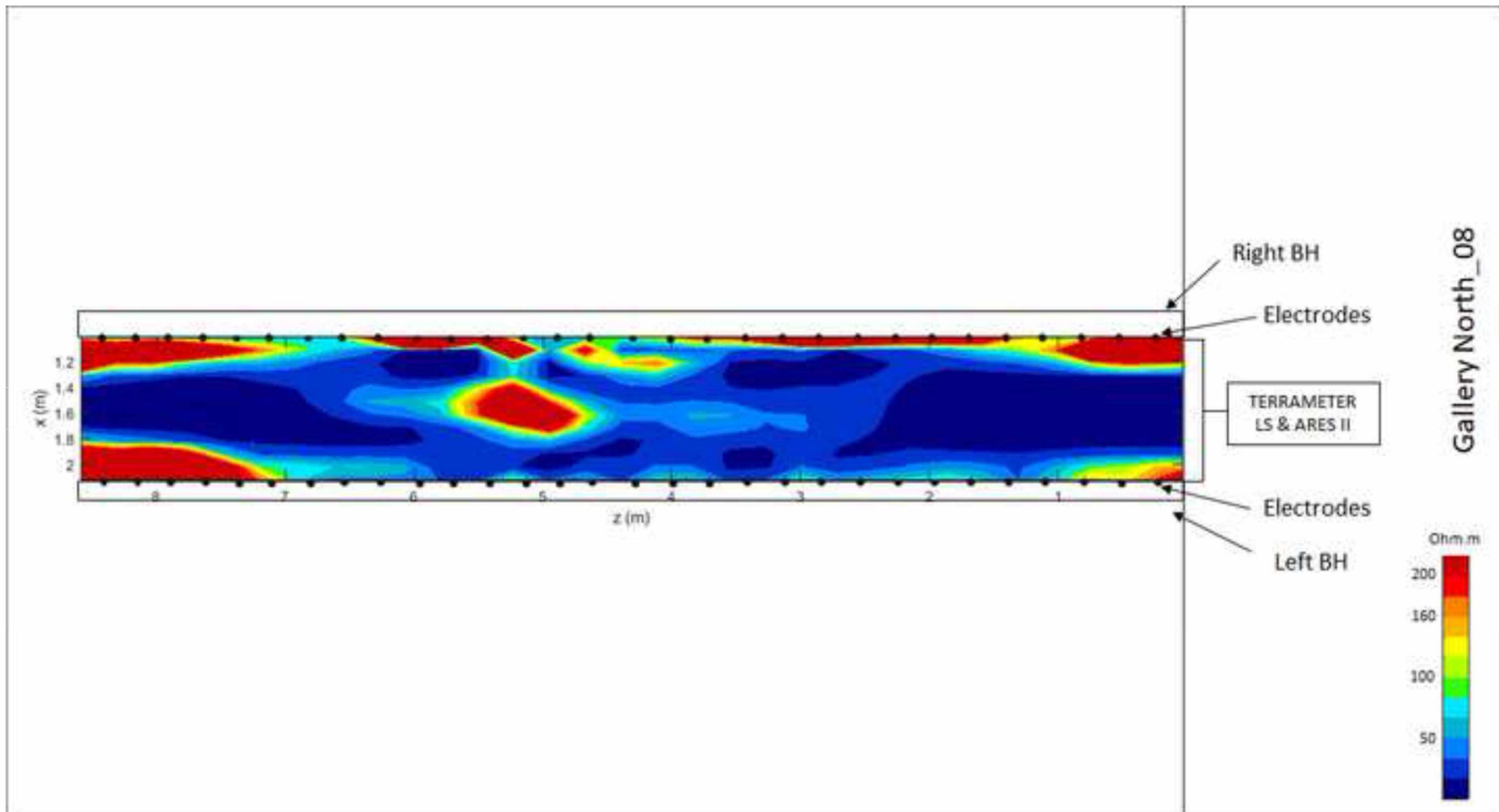

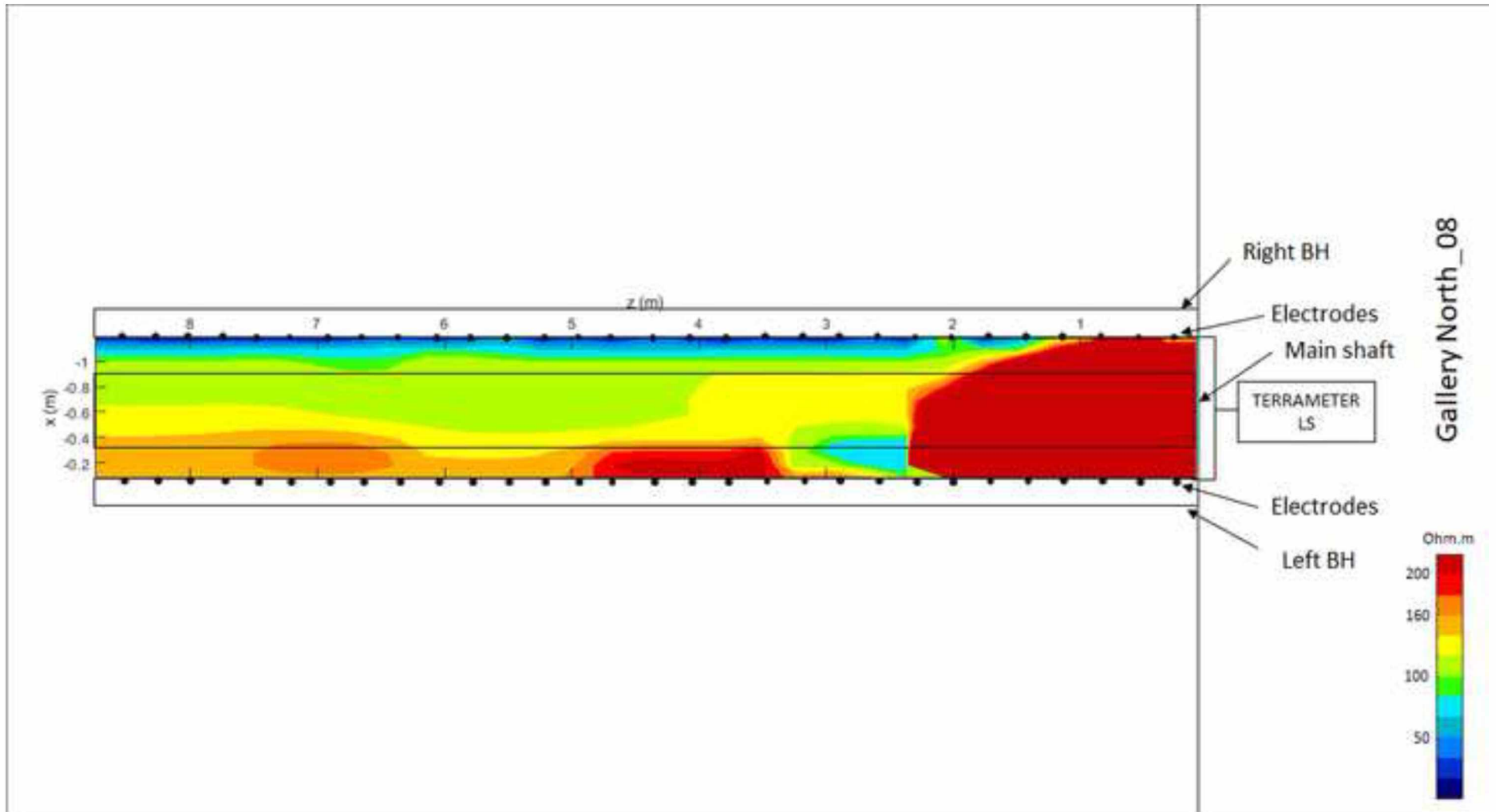

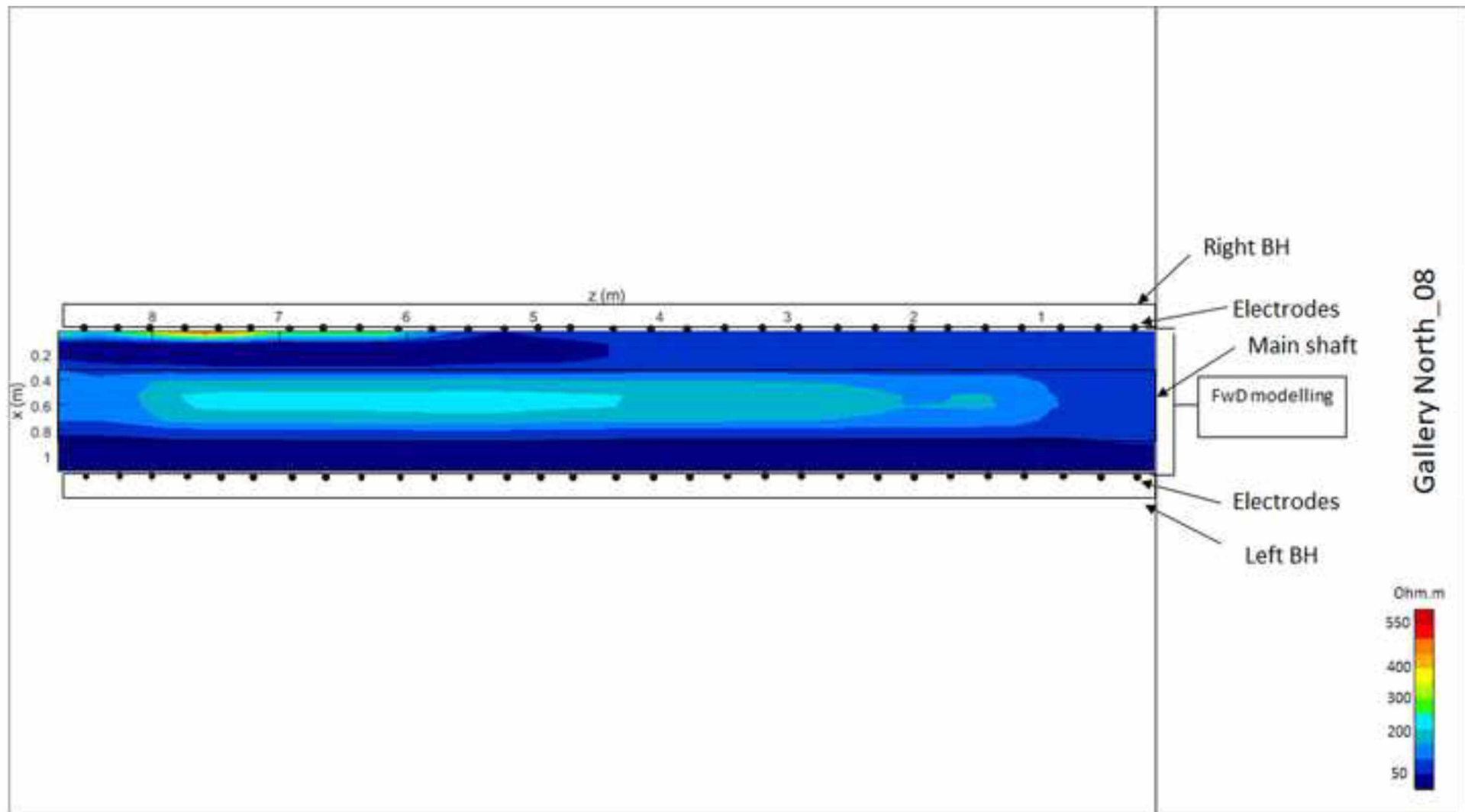

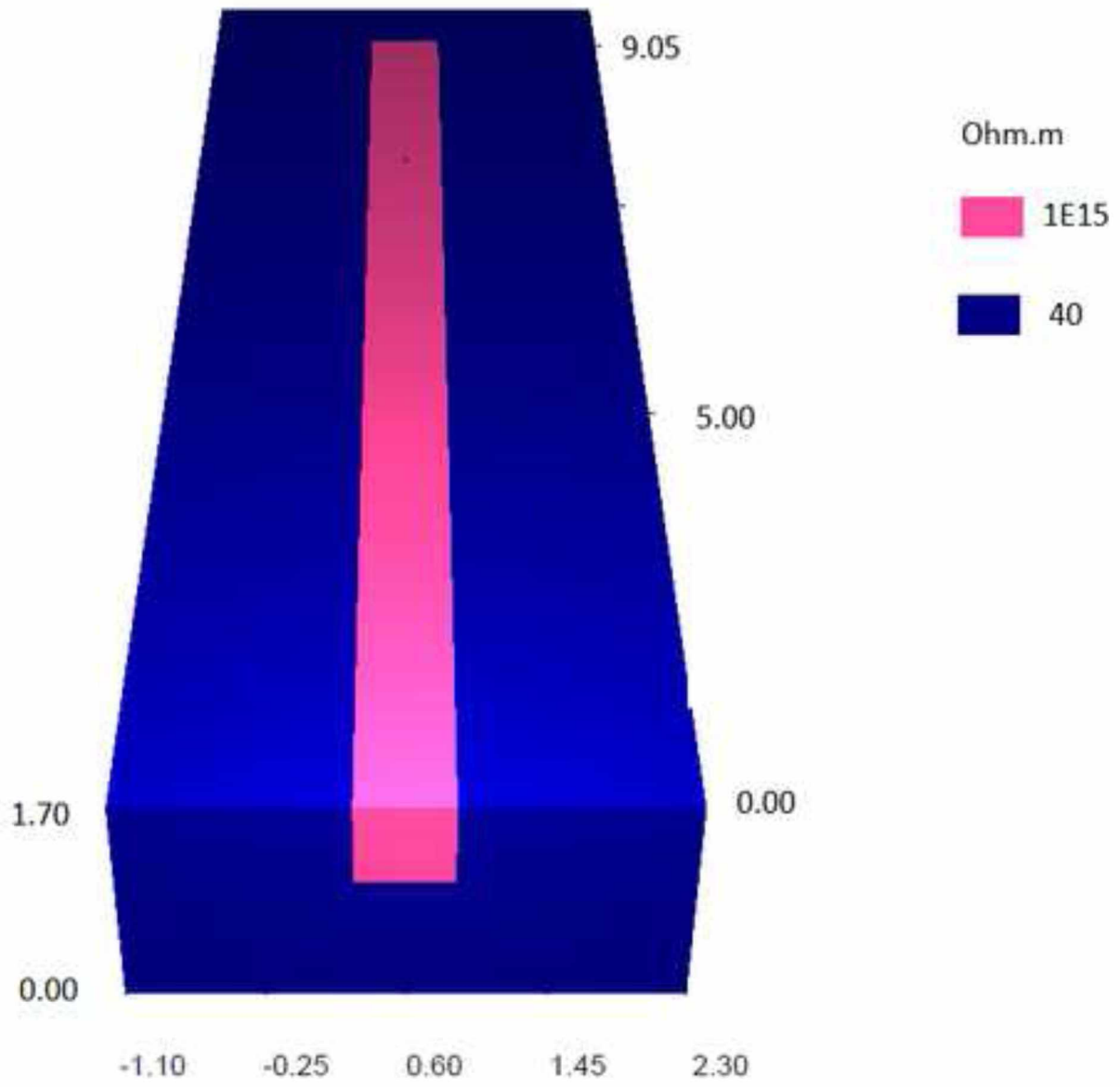

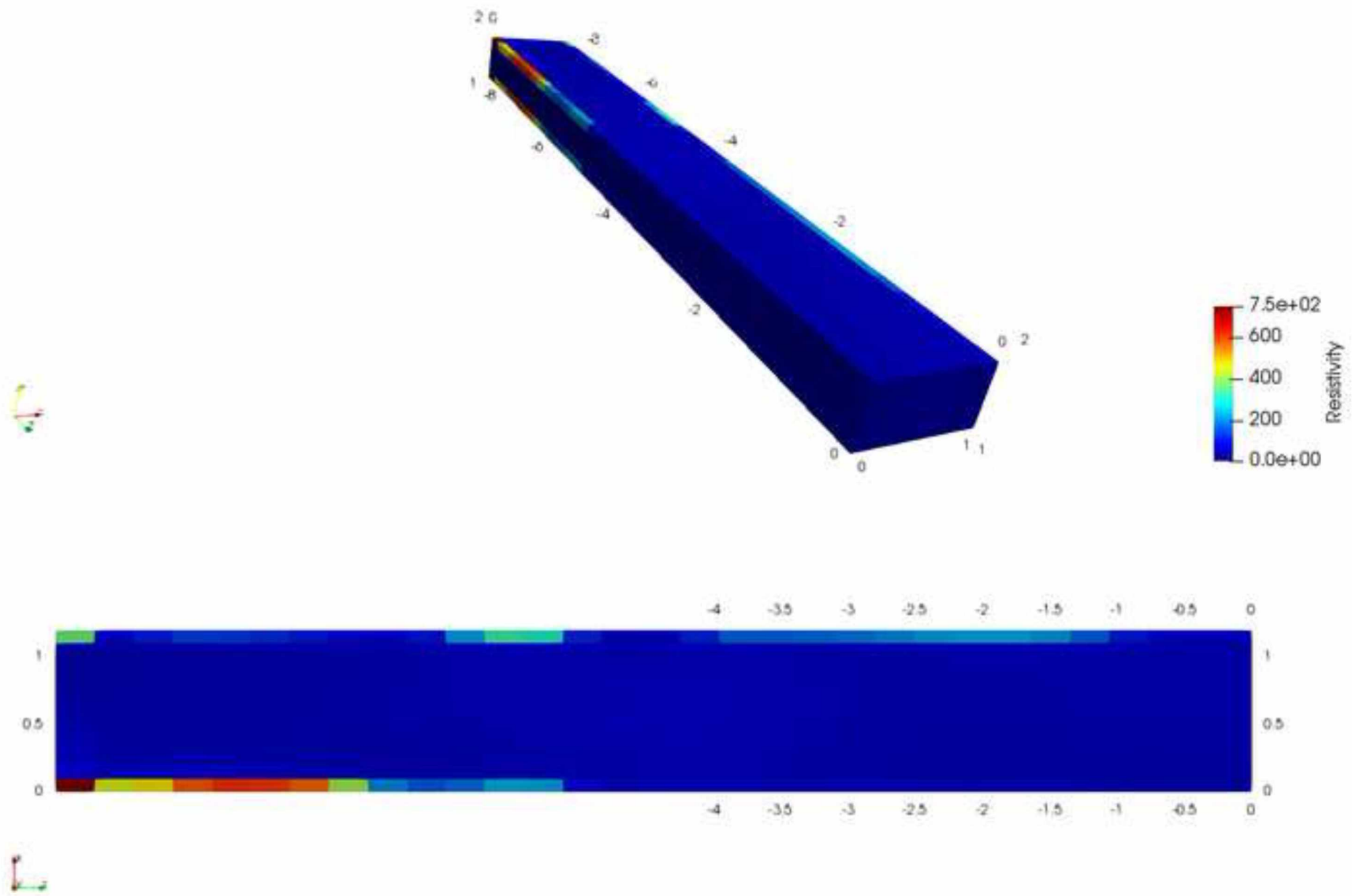

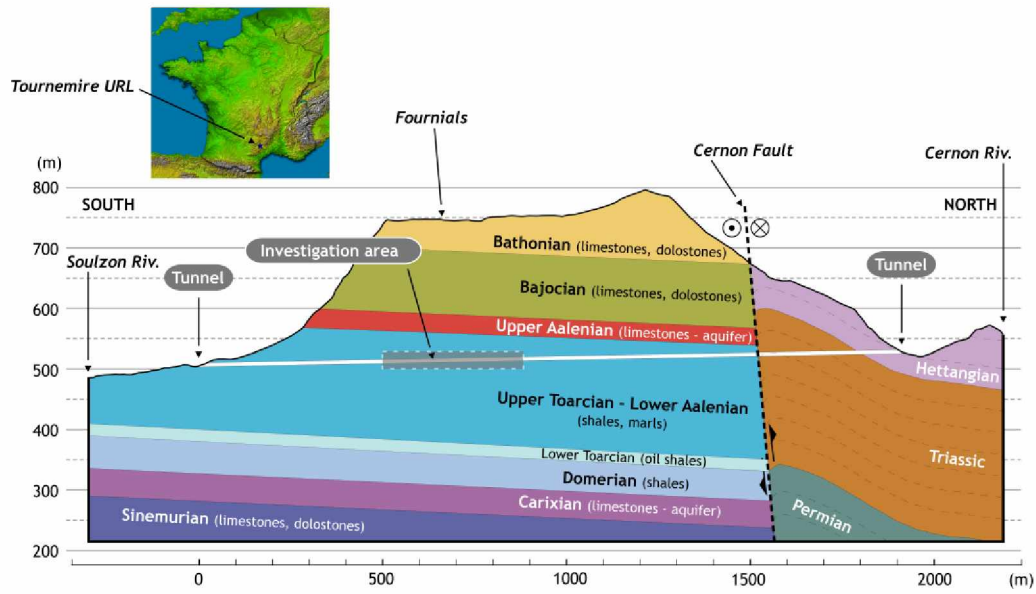

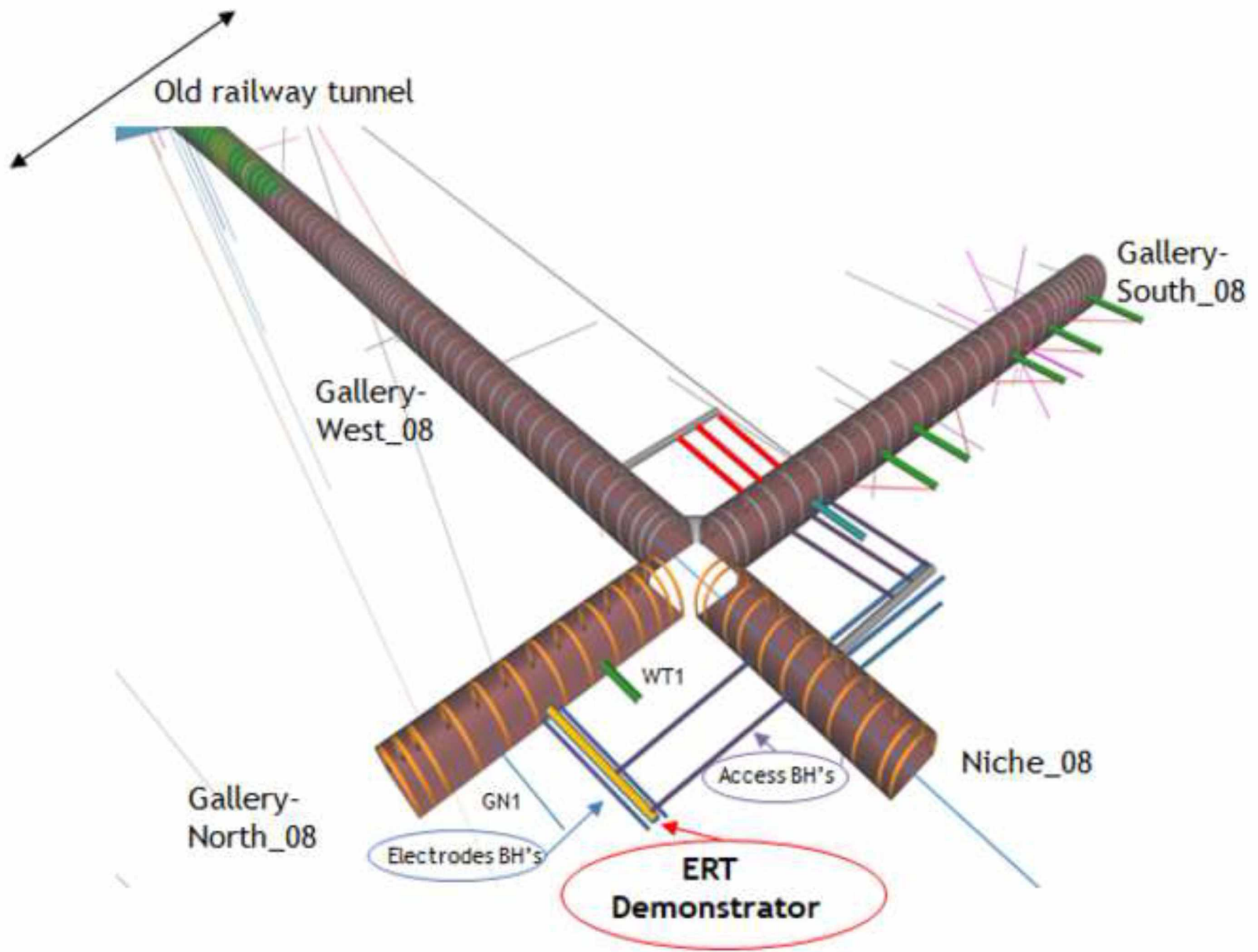

BLANK TEST 1 - January 2017

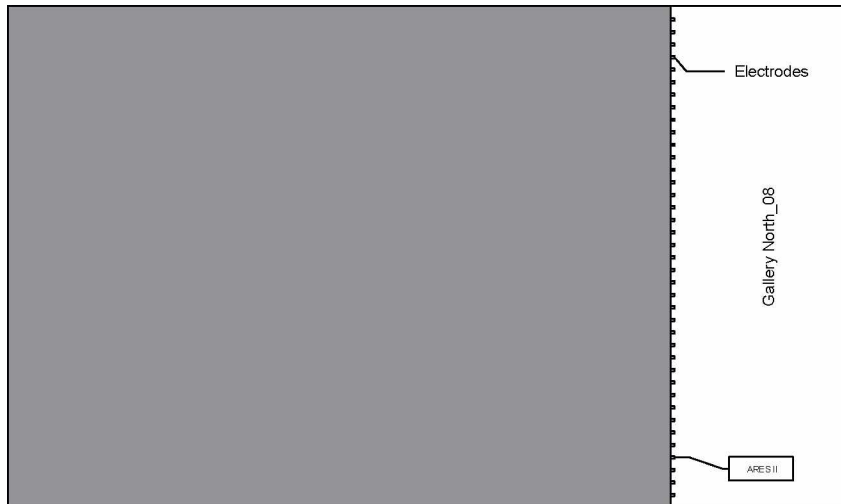

BLANK TEST 2 - January 2017

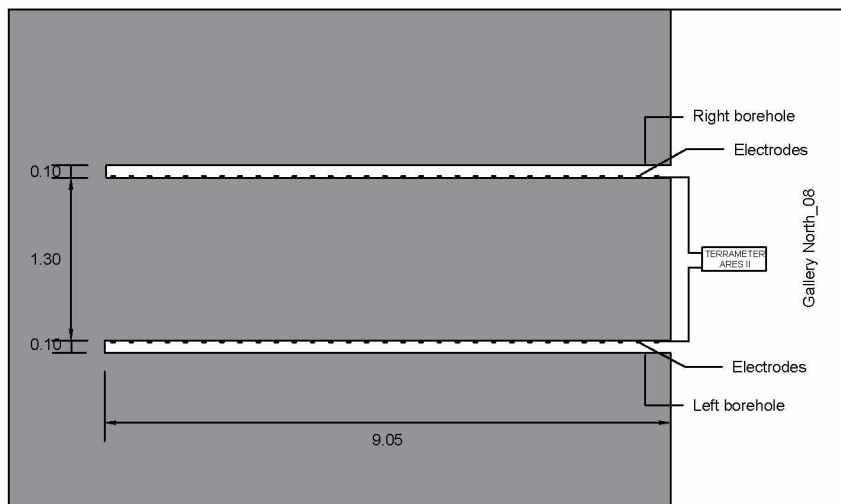

BLANK TEST 3 - November 2017

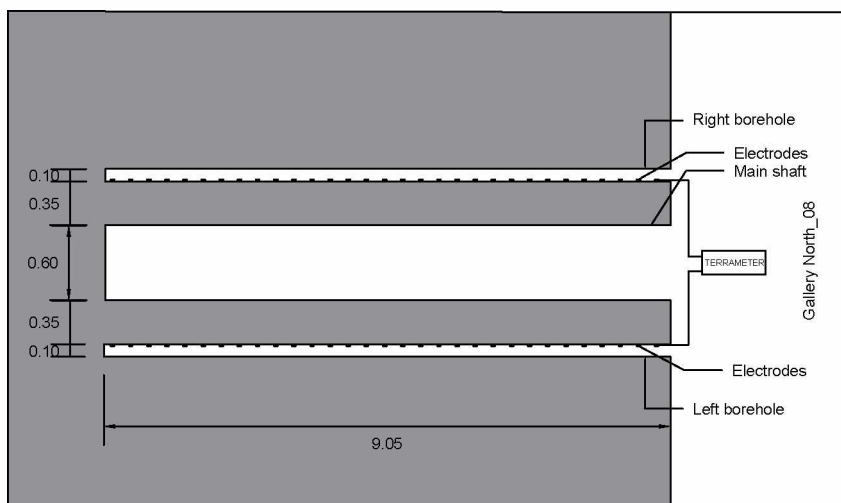

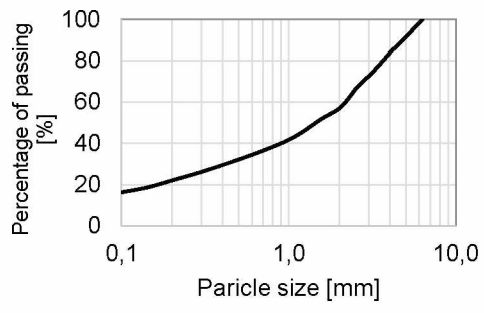

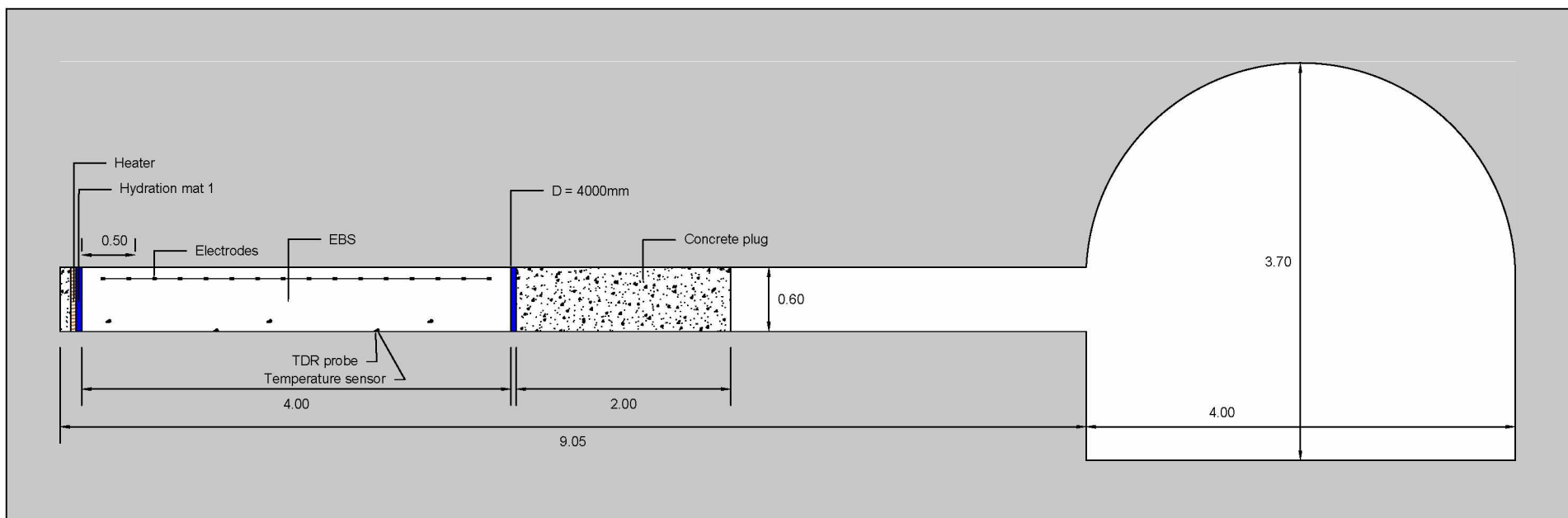

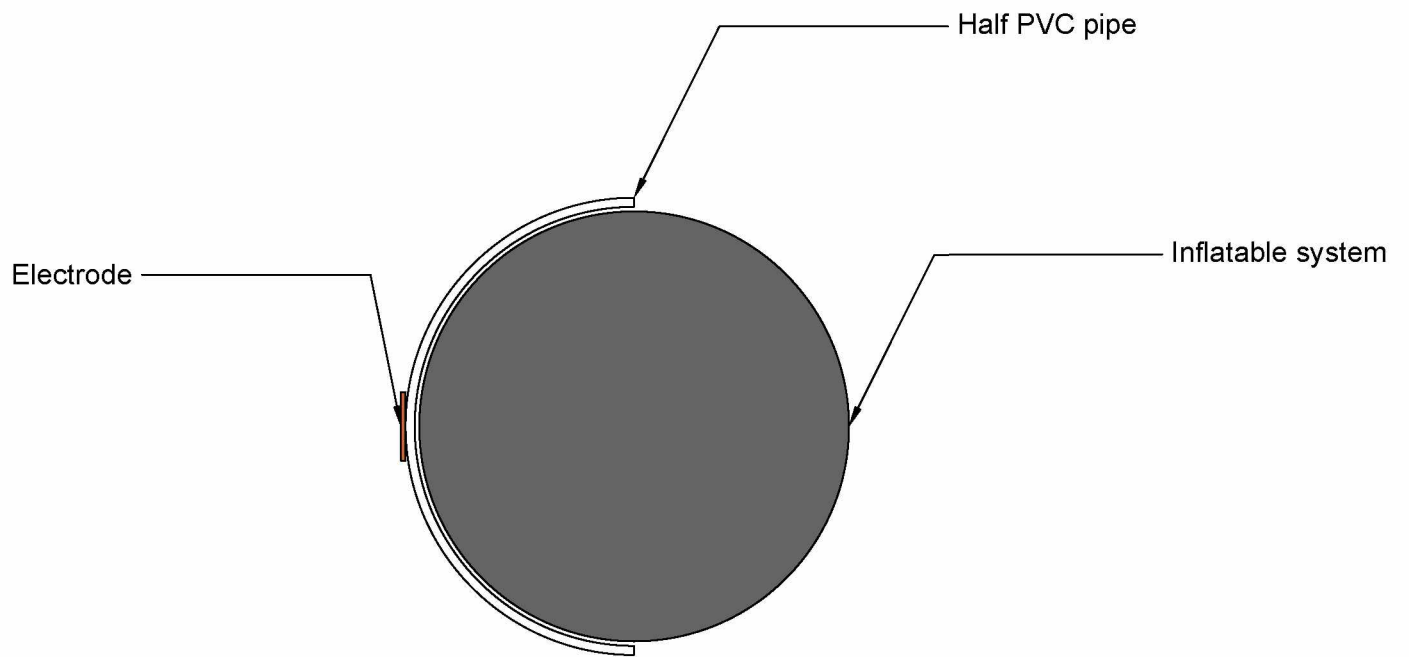

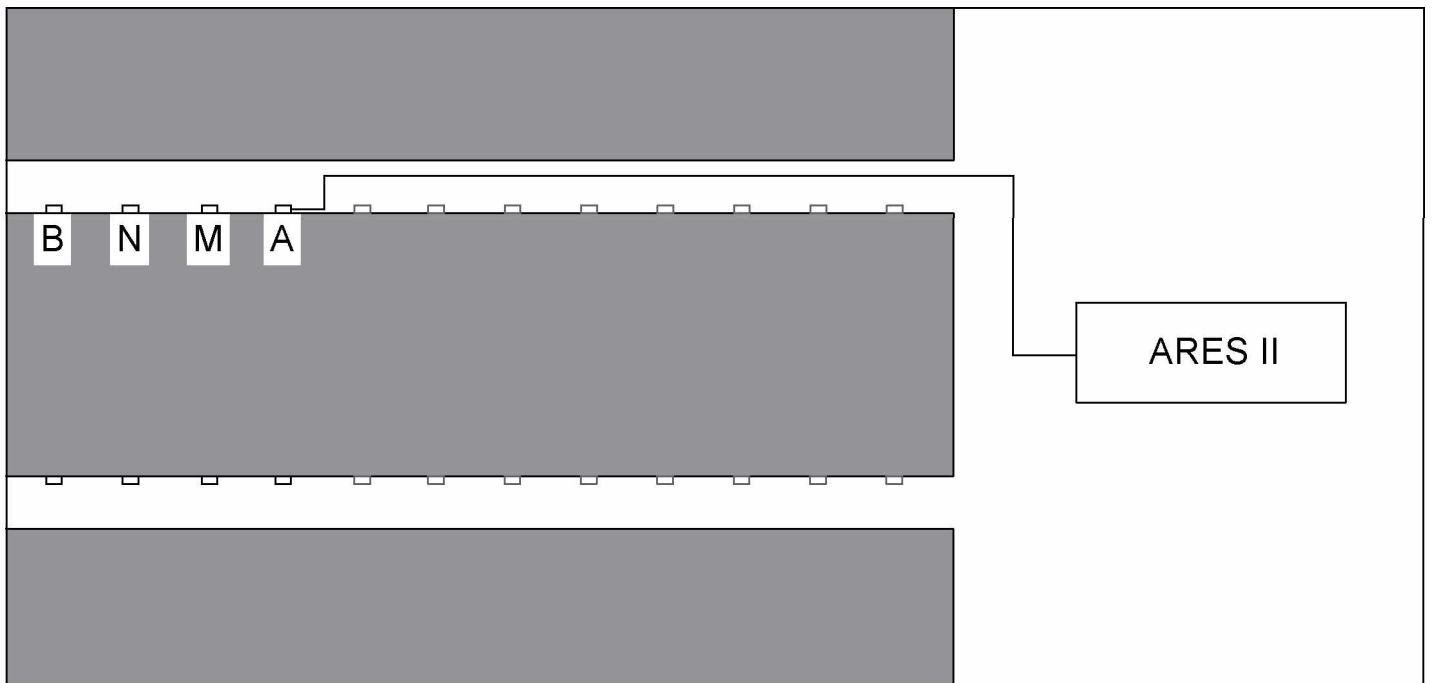

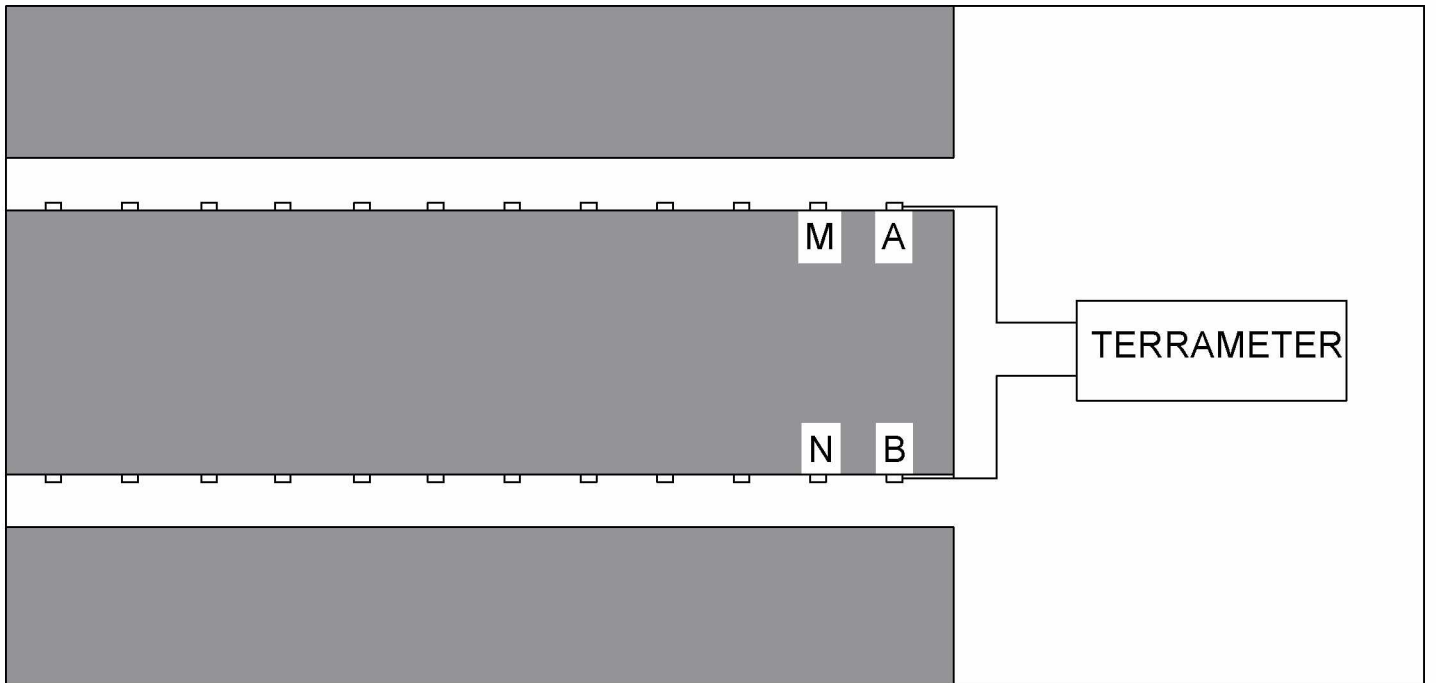

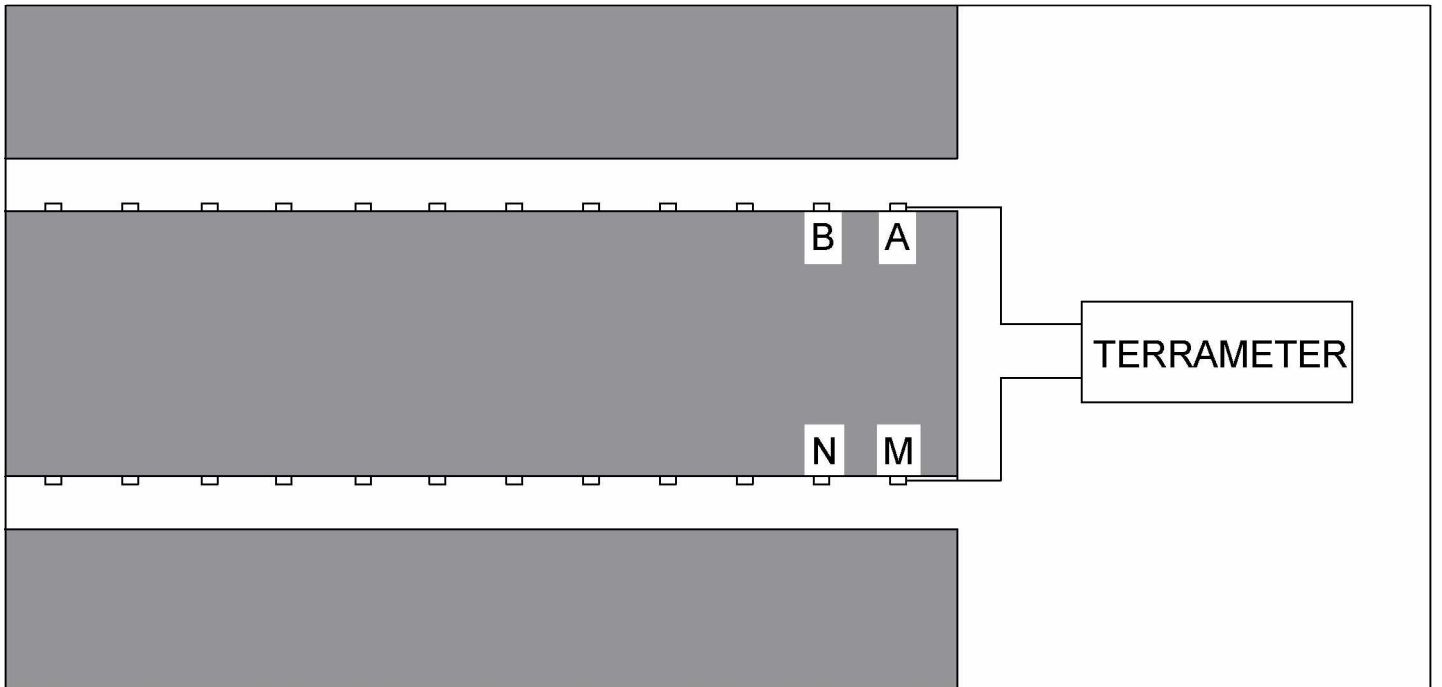

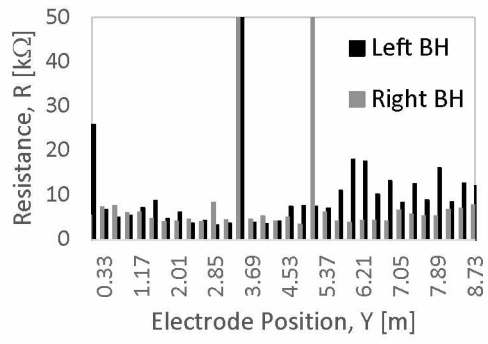

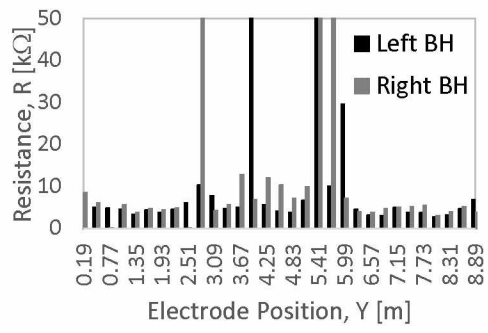

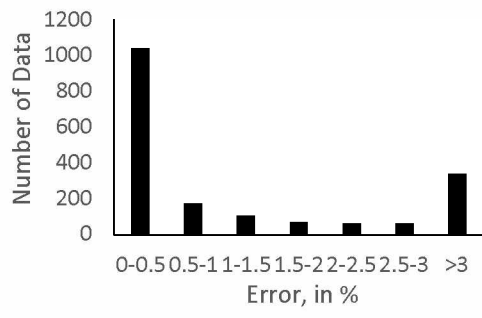

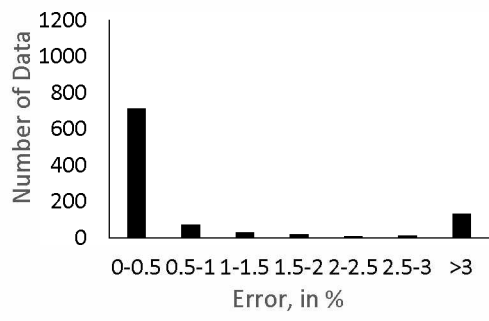

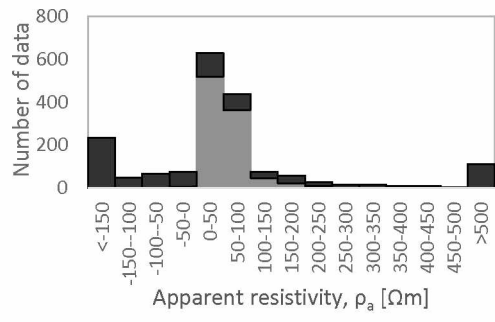

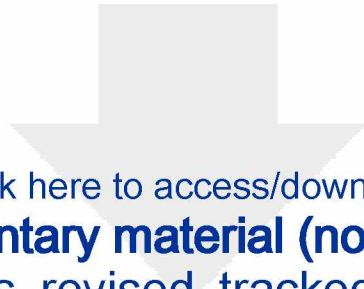

Click here to access/download
supplementary material (not datasets)
Lopes_revised_tracked.docx

