



**HAL**  
open science

# Electro-magneto-mechanical interactions in nonlinear vibrations of asynchronous electrical machines with air-gap eccentricity

Xiaowen Li, Adeline Bourdon, Samuel Koechlin, Dany Prieto

► **To cite this version:**

Xiaowen Li, Adeline Bourdon, Samuel Koechlin, Dany Prieto. Electro-magneto-mechanical interactions in nonlinear vibrations of asynchronous electrical machines with air-gap eccentricity. 24ème Congrès Français de Mécanique, Aug 2019, Brest, France. hal-02977494

**HAL Id: hal-02977494**

**<https://hal.science/hal-02977494v1>**

Submitted on 25 Oct 2020

**HAL** is a multi-disciplinary open access archive for the deposit and dissemination of scientific research documents, whether they are published or not. The documents may come from teaching and research institutions in France or abroad, or from public or private research centers.

L'archive ouverte pluridisciplinaire **HAL**, est destinée au dépôt et à la diffusion de documents scientifiques de niveau recherche, publiés ou non, émanant des établissements d'enseignement et de recherche français ou étrangers, des laboratoires publics ou privés.

# Electro-magneto-mechanical interactions in nonlinear vibrations of asynchronous electrical machines with air-gap eccentricity

Xiaowen. LI<sup>ab</sup>, Adeline. BOURDON<sup>a</sup>, Didier. REMOND<sup>a</sup>  
Samuel. KOEHLIN<sup>b</sup>, Dany. PRIETO<sup>b</sup>

a. Univ Lyon, INSA-Lyon, CNRS UMR5259, LaMCoS, F-69621, Villeurbanne, France

xiaowen.li,adeline.bourdon,didier.remond@insa-lyon.fr

b. NIDEC PSA emotors, 212, Bd Pelletier - 78 955 Carrieres-Sous-Poissy

Samuel.KOEHLIN, Dany.PRIETO@mail.nidec.com

## Résumé :

*Ce papier présente un modèle analytique multi-physique avec un couplage fort des phénomènes électro-magnéto-mécaniques pour simuler les comportements dynamiques d'une machine électrique asynchrone en présence d'excentricité. La force électromagnétique, y compris l'attraction magnétique non équilibrée (UMP), est élaborée sur la base d'une méthode de travail virtuelle. En comparant les résultats simulés du modèle couplé ou non couplé à la partie mécanique, l'effet d'interaction électro-magnéto-mécanique est étudié dans le cas de l'excentricité statique. Les paramètres d'un moteur électrique de 7,5 kW sont utilisés pour valider une partie du modèle proposé. Grâce à l'approche angulaire, des phénomènes de modulation riches liés aux couplage fort et des harmoniques de fréquence caractéristiques sont identifiés dans les spectres angulaires des résultats simulés.*

## Abstract :

*This paper presents a multi-physics analytical model with a strong electro-magneto-mechanical coupling to simulate the dynamic behaviors of an asynchronous electrical machine with an air-gap eccentricity. The electromagnetic force including the unbalanced magnetic pull (UMP) is worked out based on virtual work method. By comparing the simulation results from the model coupled or not coupled with the mechanical part, the electro-magneto-mechanical interactions effect is studied in the case with static eccentricity. The parameters of a 7.5 Kw electric motor is used to validate part of the proposed model. Thanks to the framework of angular approaches, rich modulation phenomenas corresponding to strong coupling effect and characteristic frequency harmonics are identified in the simulation results spectrum.*

**Mots clefs : Electro-magneto-mechanical coupling, unbalanced magnetic pull (UMP), air-gap eccentricity, displacement spectrum**

# 1 Introduction

With the development of electrical machines, more attention has been given to vibrations generated inside the machine. Among them, electromagnetic vibrations are the main type for those small and medium-sized electrical motors. These vibrations come from uneven radial electromagnetic forces around the rotor circumference caused by either unbalanced mechanical part (air-gap eccentricity) or uneven electromagnetic field. [1] In order to satisfy some special requirements in industry like optimizing the motor's installation position, some changes are realized in the structure that even worsen the vibration problem. One of the most harmful consequences is the rub-impact between the stator and the rotor. Hence, it is very important to analyze the dynamic behavior of the rotor by creating a simulation model of the electrical machine. Due to different operation mechanisms of the electromagnetic part and the mechanical part, most of researchers used to analyze this phenomenon in two separate systems. [2] [3] [4] [5] [6] The common way is to calculate the electromagnetic force produced from the electromagnetic field and apply it to the mechanical structure as an external force in order to perform the vibration analysis. It does work with the assumption of the constant angular speed but once the machine passes into non-stationary operating conditions, this weak electromechanical coupling cannot represent motor's real dynamic behavior anymore.

Therefore, a multi-physics analytical model considering a strong electro-magneto-mechanical coupling of a cage induction motor is developed in this paper. Base on the previous work of Fourati et al. [7], the electromagnetic force including the unbalanced magnetic pull (UMP) is worked out by virtual work method. In order to demonstrate the advantage of the coupled model, the comparison with several simulation results from the uncoupled model (without the mechanical part) are discussed at the rated operation state. By performing FFT spectral analysis in the angular field, some interesting differences are displayed in the simulation results spectrum. Not only rich modulation phenomenas but also characteristic frequency harmonics are identified from the coupled model [5]. Moreover, thanks to the framework of angular approaches [7], this model is capable to simulate the dynamic behavior of the motor in non-stationary operating conditions in speed or load without any assumption on their fluctuations with reasonable calculating efforts.

## 2 Methods of analysis

### 2.1 The existing model

Fourati et al. presented a simple analytical model based on angular approach to describe the electromagnetic-mechanical interactions in an induction motor. They determined the whole system in three physical fields and with two subsystems : a simple rotor shaft model for the mechanical modeling and a permeance network model to describe the electromagnetic model. The two subsystems are coupled by solving the global differential equations with a global state vectors. More details are available in [7]. However in this paper, instead of only considering the electromagnetic torque in the coupled magnetic force term, the unbalanced magnetic pull is also taken into account as an important influence factor especially in the case with air-gap eccentricity. It reinforces the strong multi-physics coupling in the motor's modeling described in Figure 1.

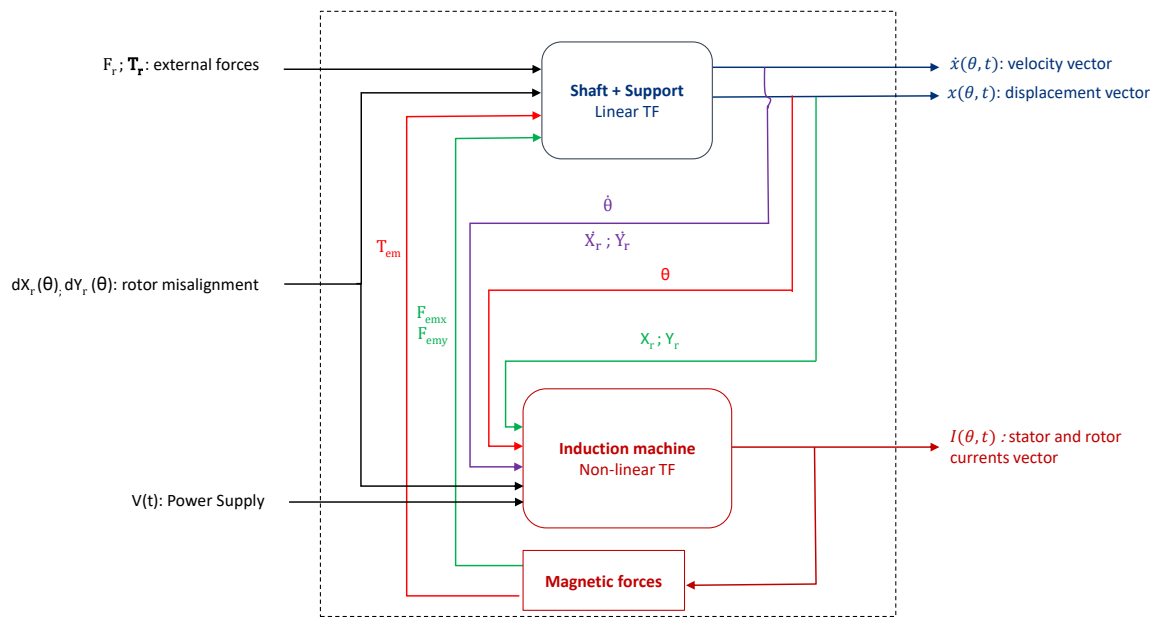

FIGURE 1 – Multi-physics couplings

## 2.2 Electro-Magnetic model (model EM)

In order to identify the electro-magneto-mechanical interaction, two similar models have been created. If we consider only the electromagnetic part (the red square in Figure 1) without the coupling of the mechanical subsystem, it is model EM seeing Figure 2. This uncoupled model has three inputs. By entering the perfect three-phase AC power supply, fixed rotor misalignment and a decided angular speed, several results like stator and rotor currents; electromagnetic force and some intermediate magnetic variables are obtained as outputs. The operation state of simulations is controlled by the defined angular speed. In model EM, state vectors are simplified to contain only the electrical variables : stator and rotor currents.

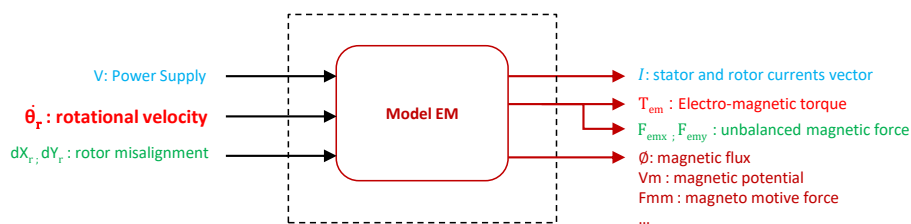

FIGURE 2 – Electro-Magnetic model

## 2.3 Electro-Magneto-Mechanical model (model EMM)

In the coupled model seeing Figure 3, except for those input values discussed in the model EM ( $V, dX_r, dY_r$ ), it also needs to add the external force and all the mechanical parameters as inputs to generate the rotor center orbit and the instantaneous angular speed. Another difference from model EM is that the operation state is assigned by controlling the input resistant torque in model EMM, knowing that in a simple mechanic system the generated electromagnetic torque should equal the input resistant torque value.

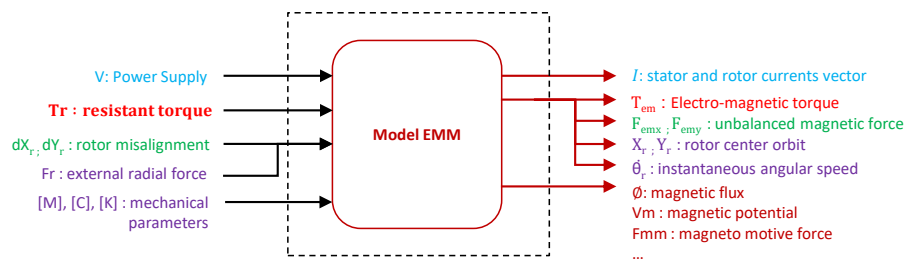

FIGURE 3 – Electro-magneto-mechanical model

### 3 Simulation results

#### 3.1 The studied motor

The studied motor is a 7.5Kw two-pole squirrel cage asynchronous electrical machine. The principal parameters of the motor are shown in Table 1. In order to simplify the calculation, the bearing part is represented by a roughly estimated stiffness value  $K_x = K_y = 5 \cdot 10^8 \text{ N/m}$ . The reference motor is simulated at its rated operation state : rated velocity  $\omega_n = 309.2 \text{ rad/s}$  for model EM and rated torque  $C_n = 24.3 \text{ Nm}$  for model EMM. Only the simulation with 10% static eccentricity are discussed in this paper.

Parameter	Value
Number of poles	2
Number of phases	3
Number of parallel paths	1
Radial air-gap length [mm]	0.96
Number of stator slots	36
Number of rotor slots	30
Connection	Y
Rated voltage [V]	400
Rated frequency [Hz]	50
Rated power [Kw]	7.5
Mass of the rotor [Kg]	17.05
Moment of inertia [ $kg \cdot m^2$ ]	0.01102

TABLE 1 – Motor parameters

#### 3.2 Macroscopic results

In order to obtain macroscopic values in the steady state, all the simulations run two times : firstly during 26 revolutions and then for 200 revolutions with respect to eliminate the initial transient effects. These macroscopic average results are verified by comparing to the reference machine data provided by our industrial partner Nidec-Leroy Somer.

From the macroscopic results, there is no evident difference between the two models. But according to Figure 4 : the variation of unbalanced magnetic forces during the last 50 revolutions, it's easily to find that with electro-magneto-mechanical interactions, UMP from model EMM takes more revolutions to attain the steady state and its variation waveform has smaller amplitude than the one generated from model EM.

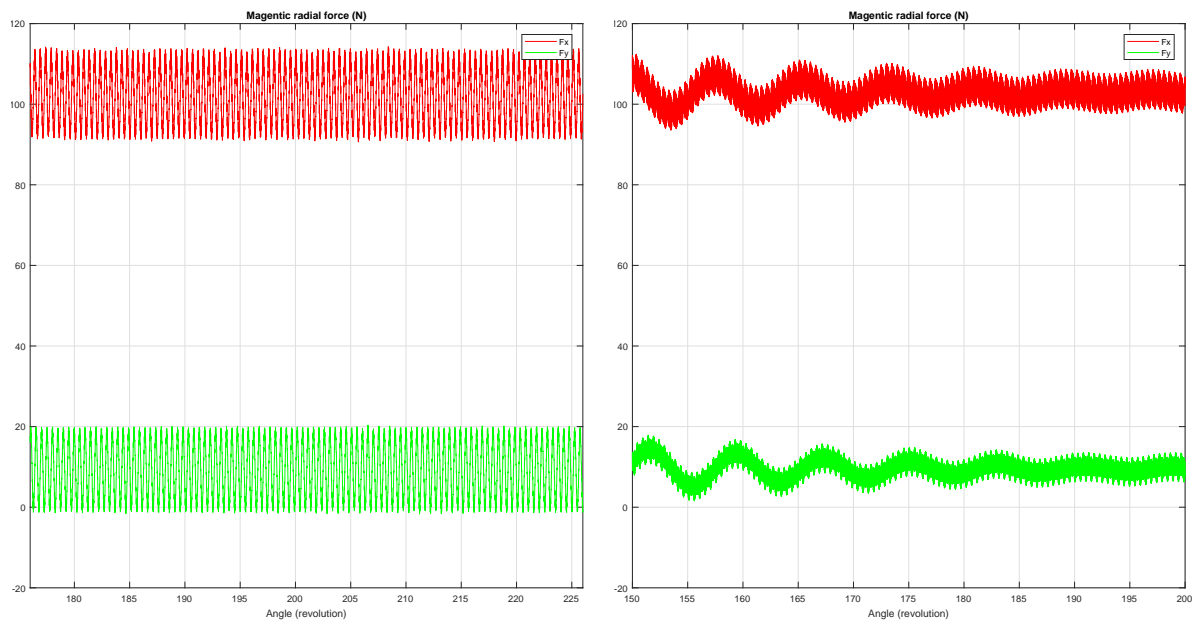

FIGURE 4 – The variation of UMP in function of angle (Left : Model EM, Right : Model EMM)

### 3.3 Frequency spectral analysis

Unlike the traditional time-frequency spectral analysis, in this paper it is applied in the angular field. Therefore the synchronous frequency 50 Hz is shown as

$$f_{\theta_s} = 2 * \pi * \frac{f_s(Hz)}{\omega(rad/s)} = 1.016 \text{ ev/tr} \quad (1)$$

in the angular spectrum of the simulation at the rated velocity :  $\omega_n = 309.2 \text{ rad/s}$ . Frequency responses are achieved by doing the Fast Fourier Transform analysis on the results of 200 revolutions. The spectrum of two models are superposed in the same figure to search for the difference.

Figure 6, 7, 8 illustrate separately angular spectrum of each simulation results : electromagnetic force (UMP) magnitude; electromagnetic torque and first phase stator current in the case with 10% static eccentricity. We can see clearly that there are some frequency peaks only appearing in model EMM like three times supply frequency harmonic " $3 * f_{\theta_s} = 3.045$ " in Figure 7. Additionally, some characteristic harmonics ( like synchronous frequency harmonic "2.03, 4.065, 6.095, 8.131, ..." in Figure 5 and rotor slot harmonics "30, 60, 90, ..." in Figure 5 and 6 ) and several modulation phenomenas ( like rotor slot harmonics modulated with synchronous frequency "28.98 & 31.02" in Figure 7 or with its harmonics 27.97 & 32.03 in Figure 5 ) corresponding to the machine geometry can also be identified easily from the spectrum. Some of them correspond with the results identified in [8].

## 4 Conclusions

The proposed strong coupling model offered us a better description of the electrical motor's dynamic behaviors. Electromagnetic radial force (UMP) is calculated and taken into consideration in the coupled system. Through the comparison between model EM and model EMM, electro-magneto-mechanical interactions are confirmed to play an important role in induction motors specially in the case with eccentricity. Many modulation phenomena and characteristic frequency harmonics are identified from the

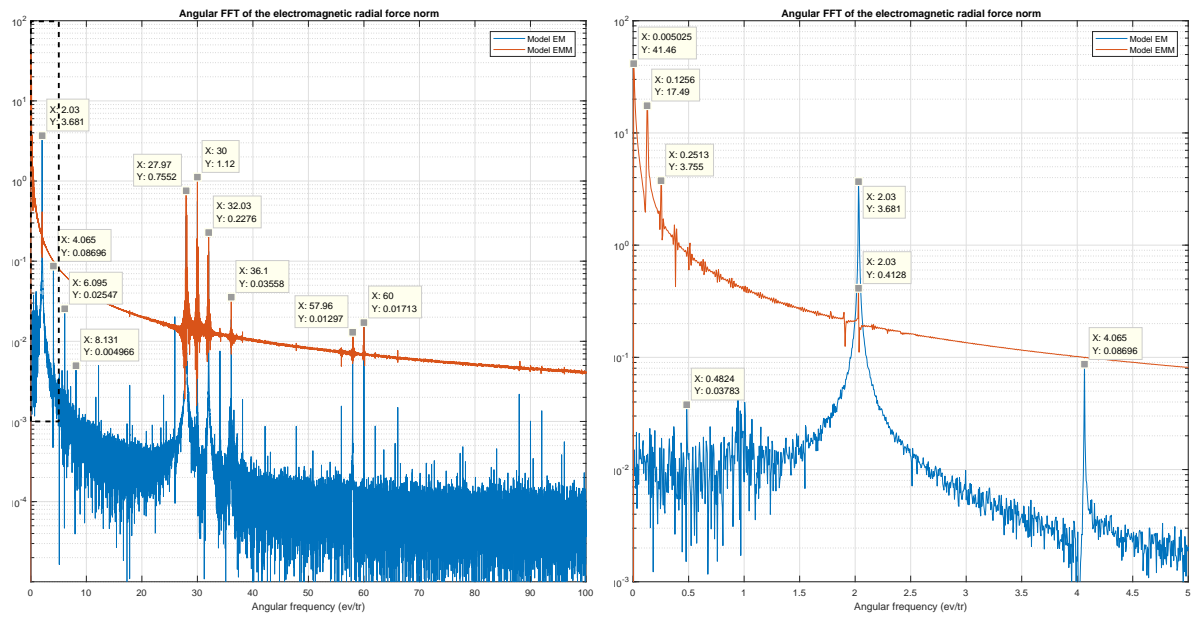

FIGURE 5 – Spectrum of electromagnetic force magnitude (Right : zoom from the black square)

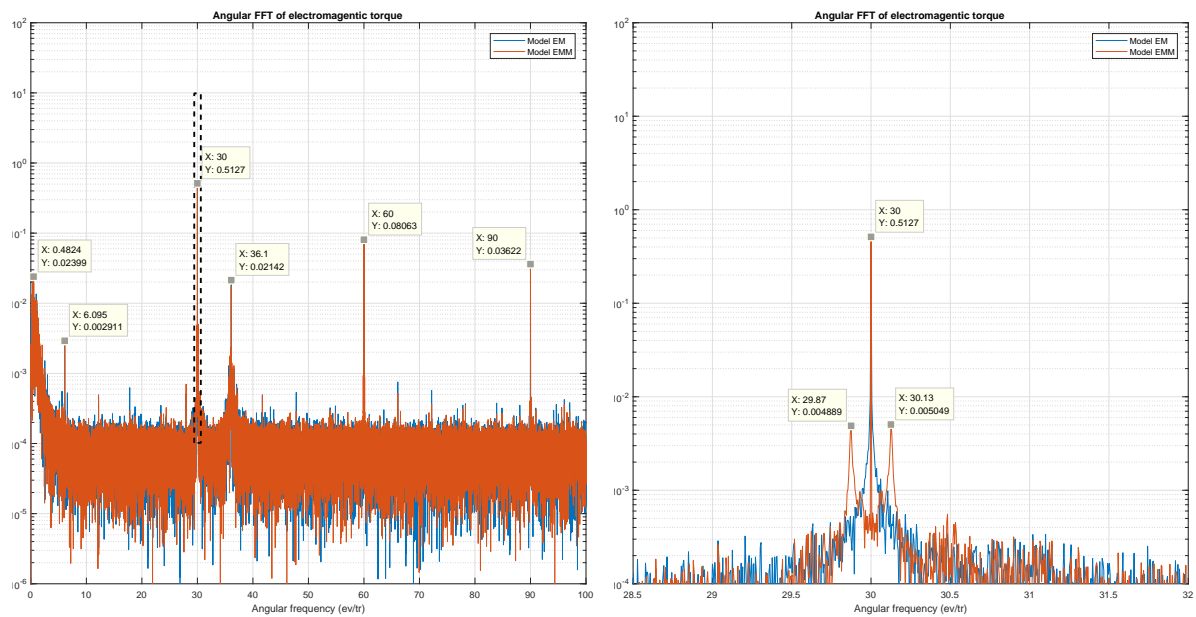

FIGURE 6 – Spectrum of electromagnetic torque (Right : zoom from the black square)

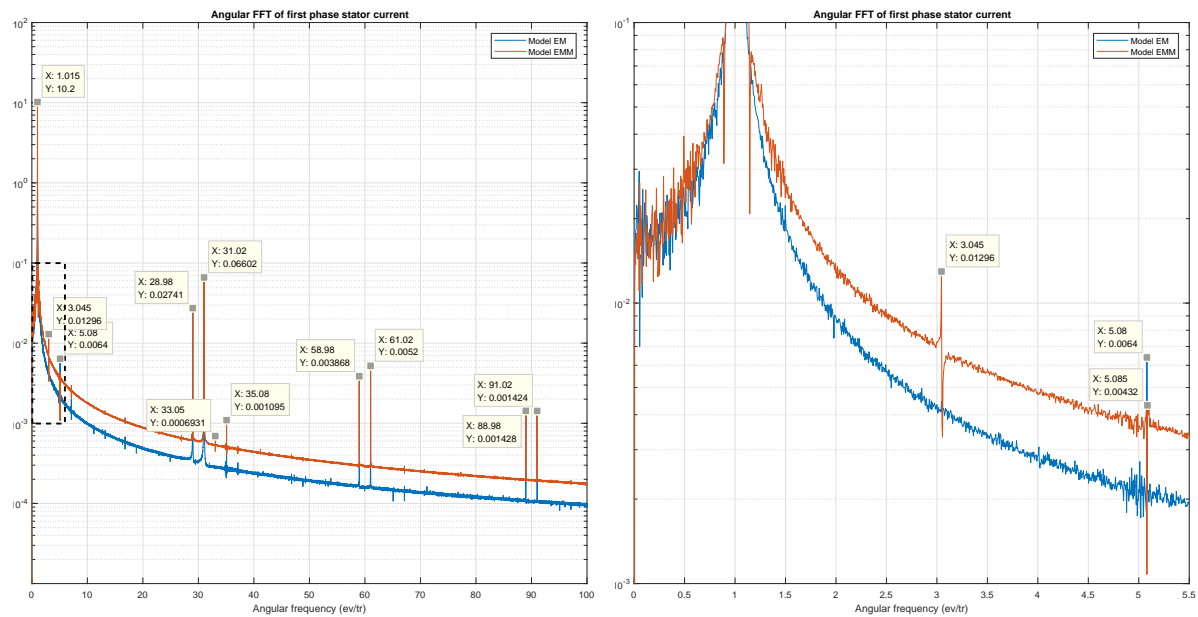

FIGURE 7 – Spectrum of first phase stator current (Right : zoom from the black square)

simulation results spectrum thanks to the angular approach. Some of them can be verified by the observation in other literatures and the rests need more simulations to analyze them. The imbalance of the electromagnetic field is considered to be integrated in this model in the future work.

## Références

- [1] X. Xu, Q. Han, and F. Chu. Review of electromagnetic vibration in electrical machines. *Energies*, 11(7), 2018.
- [2] D. Guo, F. Chu, and D. Chen. The unbalanced magnetic pull and its effects on vibration in a three-phase generator with eccentric rotor. *Journal of Sound and Vibration*, 254(2) :297–312, 2003.
- [3] X. Han and A. Palazzolo. Unstable force analysis for induction motor eccentricity. *Journal of Sound and Vibration*, 370 :230–258, 2016.
- [4] T. P. Holopainen. *Electromechanical interaction in rotordynamics of cage induction motors*. Number 543 in VTT Publications. 2004.
- [5] A. Mahyob, M. Y. O. Elmoctar, P. Reghem, and G. Barakat. Induction machine modelling using permeance network method for dynamic simulation of air-gap eccentricity. In *2007 European Conference on Power Electronics and Applications, EPE*, 2007.
- [6] X. Xu, Q. Han, and F. Chu. Nonlinear vibration of a generator rotor with unbalanced magnetic pull considering both dynamic and static eccentricities. *Archive of Applied Mechanics*, 86(8) :1521–1536, 2016.
- [7] A. Fourati, A. Bourdon, N. Feki, D. Remond, F. Chaari, and M. Haddar. Angular-based modeling of induction motors for monitoring. *Journal of Sound and Vibration*, 395 :371–392, 2017.
- [8] David G. Dorrell, William T. Thomson, and Steven Roach. Analysis of airgap flux, current, and vibration signals as a function of the combination of static and dynamic airgap eccentricity in 3-phase induction motors. *IEEE Transactions on Industry Applications*, 33(1) :24–34, 1997.