



HAL
open science

Innovative new type of Stirling engine

Pierre Normandajc Lecanu, Joël Bréard, Jean-Michel Reboul, Jérôme Thiebot

► **To cite this version:**

Pierre Normandajc Lecanu, Joël Bréard, Jean-Michel Reboul, Jérôme Thiebot. Innovative new type of Stirling engine. 2021. hal-02977390v4

HAL Id: hal-02977390

<https://hal.science/hal-02977390v4>

Preprint submitted on 8 Feb 2021 (v4), last revised 11 Feb 2021 (v5)

HAL is a multi-disciplinary open access archive for the deposit and dissemination of scientific research documents, whether they are published or not. The documents may come from teaching and research institutions in France or abroad, or from public or private research centers.

L'archive ouverte pluridisciplinaire **HAL**, est destinée au dépôt et à la diffusion de documents scientifiques de niveau recherche, publiés ou non, émanant des établissements d'enseignement et de recherche français ou étrangers, des laboratoires publics ou privés.

Innovative new type of Stirling engine

Pierre Lecanu, AjcInnov * 7 chemin du Mont Desert 14400 Esquay sur Seulles
Joël Bréard, CNRS-CAEN-Normandy Jean-Michel, Reboul ESIX Caen University
 Jérôme, Thiebot ESIX Caen University

February 8, 2021

*Inventor of the innovative new type of Stirling engine : Protected by a patent : normandajc@laposte.net

1 Abstract

The Stirling engine [[8]] is a very old engine invented by Robert Stirling in 1816. He added to his engine a regenerator to increase the efficiency of the engine. The Stirling engine requires both, a hot and a cold source. In the industrial world, hot sources are usually lost and therefore wasted. A hot source can be a solar energy through solar thermal panels for example . The Stirling engine has a longer lifespan than internal combustion engines. The Stirling engine is a durable and a recyclable product.

The theoretical efficiency of the Stirling engine with a regenerator is the same as the one of Carnot [[2]].

$$\eta_{Carnot} = \eta_{Stirling} = 1 - \frac{T_{froid}}{T_{chaud}}$$

In practise, the efficiency is minimal in comparasion to the theoretical one.

The temperature difference between hot and cold springs can be small. The theoretical efficiency is therefore low. The optimisation of the Stirling engine 's design is a paramount. Currently there are mainly three types of engines α, β, γ . To obtain powerful engines with these types of engines is possible and complex, those are very expensive engines. Instead of trying to optimize these types of engines, the idea was to rethink the engine design with maximum respect for the Stirling cycle. A priority has been that the working volumes of the gases be distinct and specific to each operation of the Striling cycle. The heat transfer exchange time is longer than possible. A new type of engine has been designed and is the subject of this article.

2 Preliminary

this article presents the new type of motor. it is detailed the concept of the motor, the theoretical calculation of the efficiency and a calculation of the efficiency by numerical modeling.

3 Stirling's cycle

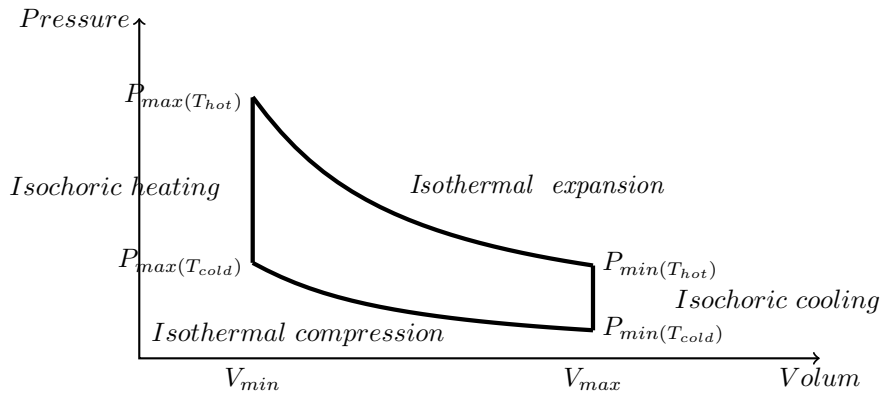

Considering an ideal gas, the equation of state is $PV = nRT$ [[3]]

P represents the pressure P , V is the volume and T is the temperature; n is the amount of substance; and R is the ideal gas constant.

$$P \text{ (Pa)} \quad V \text{ (m}^3\text{)} \quad n \text{ (mol)} \quad T \text{ (K)} \quad R = 3.314 \left(\frac{J}{K} \right)$$

In order to have a functional system, in an outside environment, work ∂W and heat transfer ∂Q are necessary.

The variation of the internal energy is $dU = \partial W + \partial Q$

During a cycle, the number of moles is constant $dn = 0$.

for isothermal transformation $dT = 0 \quad dU = 0$ [[7]]

$$W = -Q = P_{initial} V_{initial} \ln \frac{V_{final}}{V_{initial}} = nRT \ln \frac{P_{final}}{P_{initial}}$$

for isochoric transformation $dV = 0 \quad dW = 0$ [[7]]

$$U_{final} - U_{initial} = Q = nc_v(T_{final} - T_{initial})$$

with $c_v = \frac{dU}{dT}|_V = \frac{nR}{\gamma-1}$ specific heat capacity ($\frac{molJ}{K}$) $\gamma (= 1.67 \text{ monoatomic gas})$ ($= 1.4 \text{ diatomic gas}$)

The efficiency of the Stirling cycle with perfect regenerator is

$$\eta_{without \ regenerator} = \frac{W_{available}}{Q_{supplied}} = \frac{nR(T_{hot} - T_{cold}) \ln \frac{V_{min}}{V_{max}}}{nc_v(T_{hot} - T_{cold}) + nRT_{hot} \ln \frac{V_{min}}{V_{max}}}$$

$$\eta_{with \ perfect \ regenerator} = \frac{nR(T_{hot} - T_{cold}) \ln \frac{V_{min}}{V_{max}}}{nRT_{hot} \ln \frac{V_{min}}{V_{max}}} = 1 - \frac{T_{cold}}{T_{hot}}$$

4 The four phases of the cycle

4.1 with a ideal regenerator :

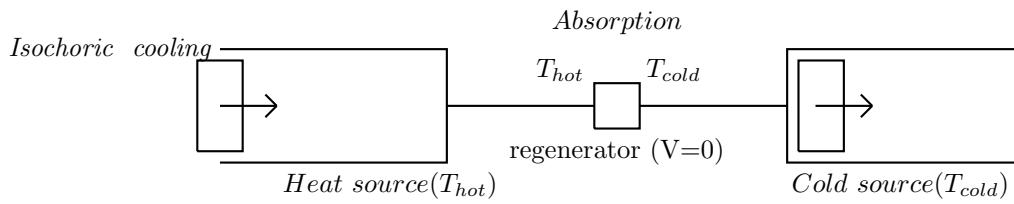
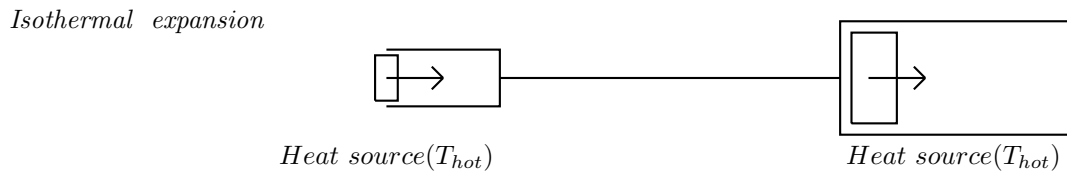
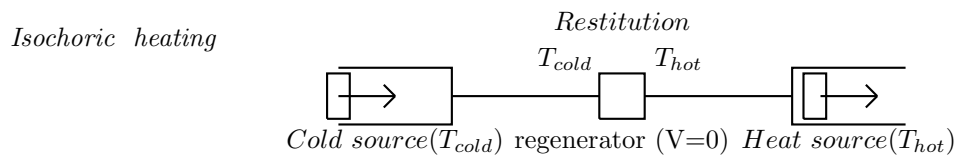
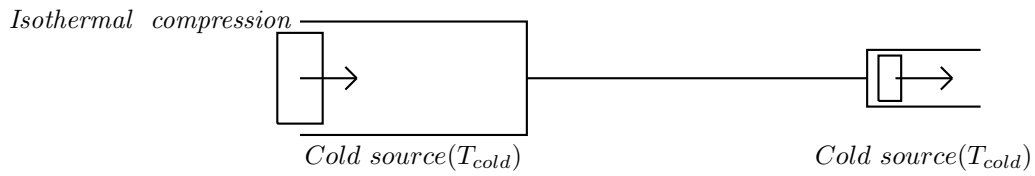

5 the stirling engine in practice

The regenerator must immediately recover the energy required for isochoric heating and must be instantly ready for a later stage. Thermal inertia of the regenerator must be low combined with large heat exchange surfaces. The volume of this regenerator becomes large.

In Stirling engines of type α , β and γ , the regenerator volume of the regime is active in all four phases of the Stirling cycle. The regenerator volume is a dead volume that affects the performance of the compression and the expansion phases.

In Stirling engines of type α , β and γ the work volumes of the different phases are not distinct. The different exchange surfaces at different temperatures are in communication with each other via the gas. The gases are partially mixed at different temperatures.

To maximise and optimise the performance of the Stirling engine type α , β and γ , complex technologie, such as the ceramics, must be used in order to limit undesired heat.

6 Innovative new type of Stirling engine

6.1 Principle :

In order to speed up the temperature exchange, the novel technology consists in using two revollutions.

the working volumes are perfectly distinct.

Instead of using a regenerator which is complex to develop, an exchanger can be used and will result by immediate heat exchange. The exchanger can be either co-current or counter-current type.

For that specific case, a counter current exchanger is highly recommended.

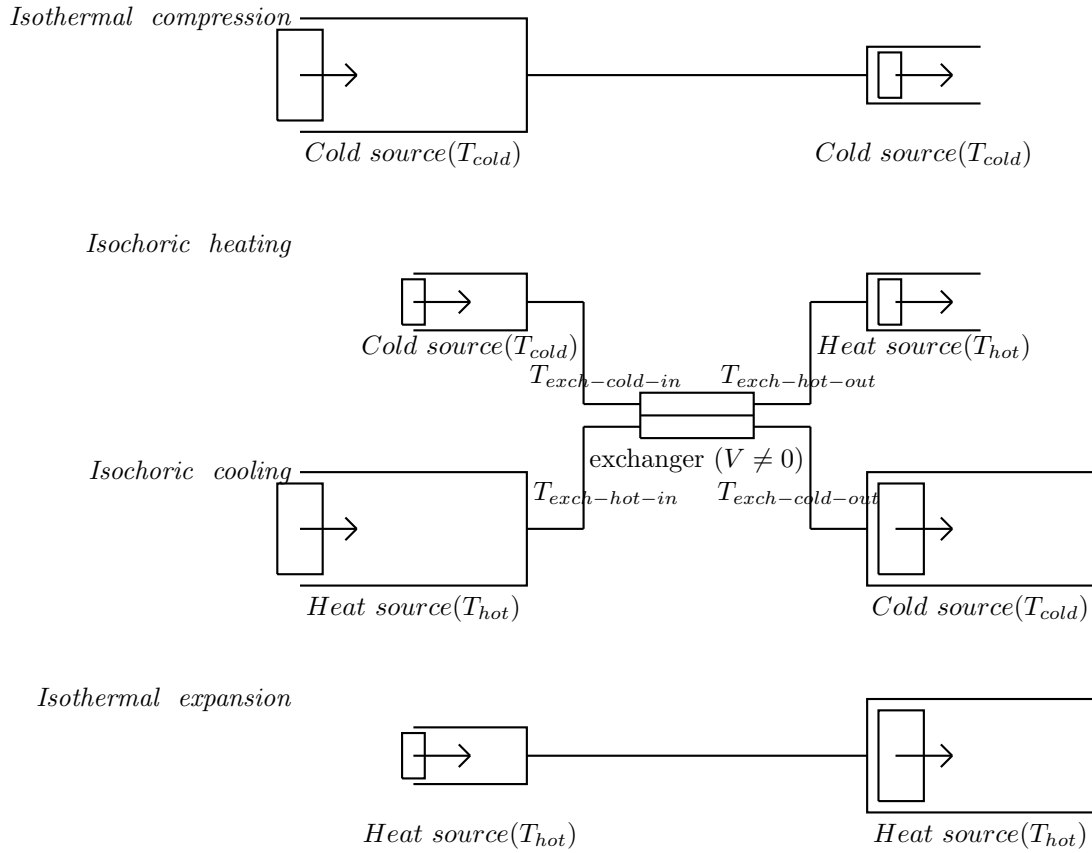

Compression and expansion transformations are fully isothermal

This excludes the addition of the dead volume.

Gas volumes are transferred from chamber to chamber and they are not mixing with each other.

Each phase of the Stirling engine is preceded by a 180 degrees rotation of the engine.

The exchange of gas performs also throughout a 180 degrees rotations.

The exchanger is unable to transfer one hundred percent of the energy from hot gas to cold gas.

With a co-current exchanger, the temperature of the outlet gases converges to a value which is usually the average value of the hot and cold gas temperatures. With a counter-current exchanger, a higher outlet temperature is obtained for the gas to be raised in temperature. However, it remains lower than the hot gas temperature.

The gas leaving the exchanger enters the heated chamber and is at a lower temperature compared to the gas already in the chamber.

The efficiency of the motor is less than that of a Stirling (or Carnot).

$$\eta_{Stirling} = \frac{nR(T_{hot} - T_{cold}) \ln \frac{V_{min}}{P_{max}}}{nRT_{hot} \ln \frac{V_{min}}{V_{max}}} = 1 - \frac{T_{cold}}{T_{hot}}$$

$$\eta_{Two-stroke-stirling-engine} = \frac{W_{available}}{Q_{supplied}} = \frac{nR(T_{hot} - T_{cold}) \ln \frac{V_{min}}{P_{max}}}{n c_v (T_{hot} - T_{exch-hot-out}) + nRT_{hot} \ln \frac{V_{min}}{V_{max}}}$$

the term $nc_v(T_{hot} - T_{exch-hot-out})$ may have a low value.
 The yield tends to approach the efficiency of Stirling (or Carnot)

6.2 Description of two-stroke Stirling engine:

(website : [6])

During the first engine revolution, the engine is in this configuration.

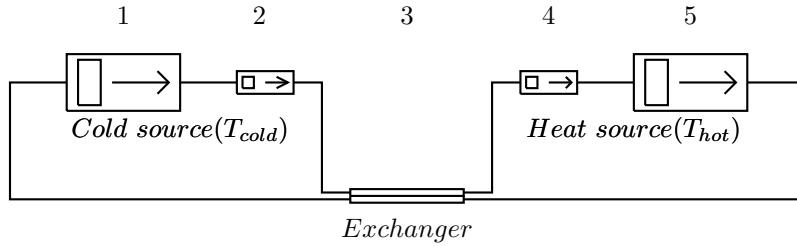

The pistons of cylinders 1, 2, 4, 5 are driven by a connecting rod and crank system and are in phase.
 The gas contained in cylinder 1 is transferred to cylinder 2 to be compressed.
 The cold gas contained in cylinder 2 is transferred to cylinder 4 for a temperature increase via exchanger 3 (preheating).
 The gas contained in cylinder 4 is transferred to cylinder 5 for a expansion (engine phase).
 The gas contained in the cylinder 5 is transferred to the cylinder 1 to be cooled via the exchanger 3 to recover heat.

During the second engine revolution, the engine is in this configuration.

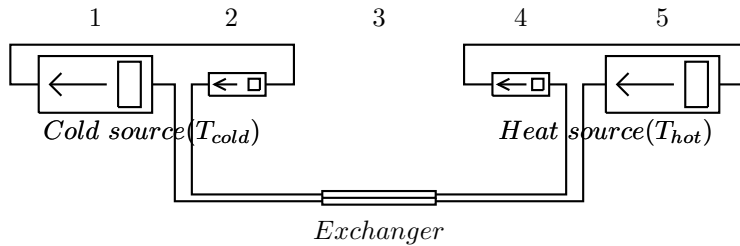

The description is during the first engine revolution.
 The four phases run simultaneously at each engine revolution. The motor is permanently in motor phase.

6.3 Alternatif counter current exchanger :

For every half turn of the engine, to increase heat recovery, the hot and cold side of the exchanger is alternated. This way the cold gas with a high temperature will enter the exchanger which is already hot, which allows to obtain a gas at the exit of the exchanger with the temperature of the exchanger. The efficiency of the exchanger is increased.

6.4 stirling engine data :

The data are defined according to the article "Numerical thermodynamic model of alpha-type Stirling engine" of Khaled M. Bataine. [[1]]

The comparative study will be made from the Pressure-volume diagram defined in this article.

Volume-pressure diagram (dashdotted represent ideal cycle)

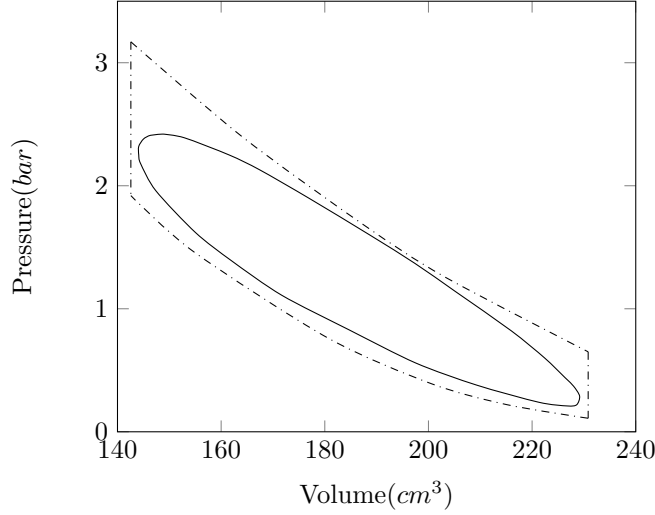

$$\frac{\text{experimental cycle area}}{\text{theoretical cycle area}} = 66.4\%$$

Correction : It is impossible to obtain a pressure at the end of compression of 1.92 bar (+1 atm) with a cold temperature of 15°C starting from a pressure of 0.11 bar (+1 atm) with these volumes of 230.9 cm³ and 142.6 cm³. In fact the exact volumes are 142.6 cm³ and 373.5 cm³ (142.6+230.9=373.5).

Data for calculations.

V_{max} cm ³	V_{min} cm ³	$rpm \frac{rev}{min}$	T_{hot} °C	T_{cold} °C	P_{min} kPa
371	141.4	450	150	15	112.3

Gas	C_p 300K $\frac{J}{kgK}$	C_p 400K $\frac{J}{kgK}$	h $\frac{W}{m^2K}$	R_{gas} $\frac{J}{K}$	γ
Helium	5193	5193	75	8.314	1.4

c_p is the specific heat capacity ($\frac{J}{kgK}$)

h is the heat transfer coefficient ($\frac{W}{m^2K}$)

R_{gas} is the gas constant

γ is the adiabatic index

6.5 Theoretical calculation :

6.5.1 compression isothermal :

$$n = \frac{P_{min} V_{max}}{R_{gas} T_{cold}} = 0.017 \text{ mol} \quad W_{compression} = - Q_{expansion} = n R_{gas} T_{cold} \ln \frac{V_{max}}{V_{min}} = 39.7 \text{ J}$$

$$P_{compression} = P_{min} \frac{V_{max}}{V_{min}} = 291.3 \text{ kPa}$$

6.5.2 Isochoric heating :

$$P_{heating} = P_{compression} \frac{T_{hot}}{T_{cold}} = 427.8 \text{ kPa}$$

$$Q_{heating \text{ without exchanger}} = \frac{nR_{gas}}{\gamma - 1} (T_{hot} - T_{cold}) = 48.2 \text{ J}$$

With a counter-courant exchanger hypothesis $T_{out \text{ exchanger}} = 109.5 \text{ }^\circ\text{C}$

$$Q_{heating \text{ with exchanger counter-current}} = \frac{nR_{gas}}{\gamma - 1} (T_{hot} - T_{out \text{ exchanger}}) = 14.5 \text{ J}$$

With a counter-courant exchanger hypothesis $T_{out \text{ exchanger}} = 129.7 \text{ }^\circ\text{C}$

$$Q_{heating \text{ with exchanger counter-current}} = \frac{nR_{gas}}{\gamma - 1} (T_{hot} - T_{out \text{ exchanger}}) = 7.2 \text{ J}$$

6.5.3 expansion isothermal :

$$W_{expansion} = - Q_{expansion} = nR_{gas} T_{hot} \ln \frac{V_{min}}{V_{max}} = -58.3 \text{ J}$$

$$P_{expansion} = P_{heating} \frac{V_{min}}{V_{max}} = 163 \text{ kPa}$$

6.5.4 counter-courant exchanger :

Using the formula (4) in the Annexe "Counter-current exchanger"

$$\frac{nR_{gas}}{\gamma - 1} (T_{hot} - T_{cold}) = S U (T_{hot}(in) - T_{cold}(out)) \Delta t_{half \text{ engine revolution}}$$

U is the general heat transfer coefficient

S is exchange surface of the exchanger

$\Delta t_{half \text{ engine revolution}}$ is the time to complete half a revolution of the engine

$$\Delta t_{half \text{ engine revolution}} = \frac{1}{2 \text{ rpm}} = 0.067 \text{ s} \quad T_{hot}(in) = 150^\circ\text{C} \quad U = 37.5 \frac{\text{W}}{\text{m}^2 \text{ K}}$$

$$\text{if } T_{cold}(out) = 140^\circ \quad S = \frac{Q_{heating \text{ without exchanger}}}{\Delta t_{half \text{ engine revolution}} U ((T_{hot}(out) - T_{cold}(in)))} \quad \sqrt{S} = 140 \text{ cm}$$

It is possible to realize an exchanger with this surface and with a volume inferior to 150 cm^3 for each chamber of the exchanger.

6.5.5 Efficiency :

$$\eta_{Carnot} = \eta_{Stirling} = 1 - \frac{T_{cold}}{T_{hot}} = 31.9 \%$$

Efficiency of experimental cycle of article

$$\eta_{\text{experimental article}} = \eta_{\text{Carnot}} \frac{\text{experimental cycle area}}{\text{theoretical cycle area}} = 21.1\%$$

by taking a Mechanical effectiveness of 90%.

$$\eta_{\text{without exchanger}} = \frac{|W_{\text{expansion}} + W_{\text{compression}}|}{Q_{\text{heating without exchanger}} + |W_{\text{expansion}}|} = 17.5 \%$$

$$\eta_{\text{with exchan. counter-courant}} = \frac{|W_{\text{expansion}} + W_{\text{compression}}|}{Q_{\text{heating without exchanger}} + |W_{\text{expansion}}|} = 25.6 \% \quad T_{\text{out exchanger}} = 109.5 \text{ } ^\circ\text{C}$$

$$\eta_{\text{with exchan. counter-courant}} = \frac{|W_{\text{expansion}} + W_{\text{compression}}|}{Q_{\text{heating without exchanger}} + |W_{\text{expansion}}|} = 28.3 \% \quad T_{\text{out exchanger}} = 129.7 \text{ } ^\circ\text{C}$$

With a simple exchanger, we get the same performance as the experimental version of the article. [[1]]
With a studied exchanger, one obtains a yield close to that of Stirling or Carnot.

6.6 Approximation of the speed of rotation :

Using Newton's second law $M \vec{\gamma} = \vec{F}$

By multiplying by \vec{v} and dt

$$d\left(\frac{1}{2}Mv^2\right) = dW = M v dv = -PdV = -nR_{\text{gas}}T \frac{dV}{V}$$

With a flywheel :

$$v = \dot{\beta} R = \omega R \quad \omega = 2 \pi \text{ rps}$$

Squared rotation speed is directly related to temperature. [[4]]

7 Numerical modeling :

As the engine is a chamber-to-chamber gas transfer, those gases are not blending with each other at temperatures, except at the exchanger.

As the gas volumes are transferred from chamber to chamber. The volume of moles must be the same in each chamber.

If the mole volume in chamber 1 is: $n_1 = \frac{P_1 V_1}{R_{\text{gas}} T_{\text{cold}}}$

The pressure in chamber 2 must be $P_2 = \frac{n_1 R_{\text{gas}} T_{\text{cold}}}{V_2}$

As long as the engine is cold, the pressure in chambers 4 and 5 is $P_4 = P_2$ $P_5 = P_1$

With the engine warmed up, the pressures become $P_4 = \frac{n_1 R_{\text{gas}} T_{\text{hot}}}{V_4}$ and $P_5 = \frac{n_1 R_{\text{gas}} T_{\text{hot}}}{V_5}$

7.1 Pressure variations :

Considering an ideal gas, the equation of state is $PV = nRT$ [[3]]

$$dp = P\left(\frac{dn}{n} + \frac{dT}{T} - \frac{dV}{V}\right)$$

The gas is transferred from chamber to chamber $dn = 0$

The variations of volume dV are linked to the geometry of the rod-crank system. annexe (2)

The variations of temperature are non-existent during isothermal transformations

The variations of temperature during the isochoric transformations are determined from the energy balances

7.2 Isothermal compression :

$$dn = 0 \quad dT = 0 \quad P(t + dt) = P(t)\left(1 - \frac{V(t + dt) - V(t)}{V(t)}\right)$$

$$W(t + dt) = W(t) - P(t)(V(t + dt) - V(t))$$

$$P(\theta + d\theta) = P(\theta)\left(1 - \frac{V(\theta + d\theta) - V(\theta)}{V(\theta)}\right)$$

$$W(\theta + d\theta) = W(\theta) - P(\theta)(V(\theta + d\theta) - V(\theta))$$

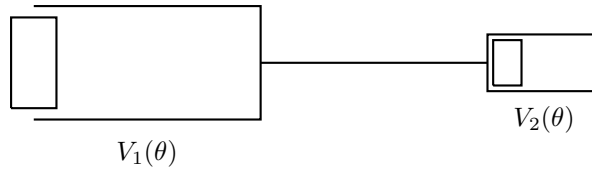

$$V(\theta) = V_1(\theta) + V_2(\theta) \quad V_1(0^\circ) = V_{max} \quad V_2(180^\circ) = V_{min}$$

pressure as a function of the angle of rotation

$P(0^\circ)$	$P(10^\circ)$	$P(45^\circ)$	$P(90^\circ)$	$P(135^\circ)$	$P(170^\circ)$	$P(180^\circ)$
111 kPa	111.8 kPa	129.8 kPa	193.1 kPa	264.5 kPa	288.1 kPa	289.2 kPa

$$W_{compression}(180^\circ) = 39.4 J$$

7.3 Isochoric heating :

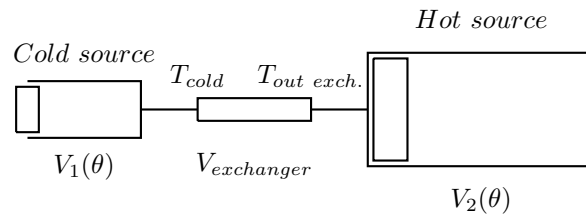

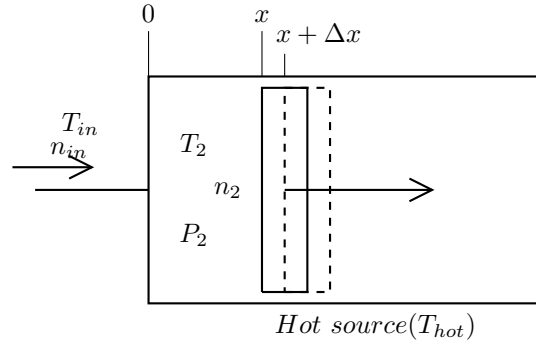

Pressure becomes immediately uniform annexe (5)

$$dn = dn_1 + dn_{exchanger} + dn_2 = 0$$

$$\frac{dP}{P} + \frac{dV_1}{V_1} + \frac{dT_1}{T_1} + \frac{dV_{exchanger}}{V_{exchanger}} + \frac{dT_{exchanger}}{T_{exchanger}} + \frac{dV_2}{V_2} + \frac{dT_2}{T_2} = 0$$

The temperature in the exchanger isn't uniform. But the exchanger has a quasi-stationary regime.

$$\frac{dT_{exchanger}}{dt} = 0 \quad dV_{exchanger} = 0 \quad \frac{dV_2}{V_2} = -\frac{dV_1}{V_1} \quad T_1 = T_{cold} \quad dT_1 = 0 \quad \Rightarrow \quad \frac{dP}{P} + \frac{dT_2}{T_2} + \frac{dT_{exchanger}}{T_{exchanger}} = 0$$

the temperature variation in the heat exchanger varies linearly (4) in the Annexe "Counter-current exchanger"

$$dP = P \left(\frac{dT_2}{T_2} + \frac{dT_{exchanger}}{T_{exchanger}} \right)$$

Thermal energy balance in hot chamber depends on :

The incoming energy flow from the exchanger

The energy flow from the walls maintained at temperature by the hot source

Variation of energy stored by the gas in the chamber

$$\dot{m}_{in} C_p (T_{in} - T_2) + h S_{wall} (T_{hot} - T_2) = \rho S_{piston} x C_p \frac{\partial T_2}{\partial t} \quad T_{in} = T_{out \ exchanger}$$

$$T_2(\theta + d\theta) = T_2(\theta) + \frac{\Delta x}{x C_p} (T_{in} - T_2(\theta)) + \frac{h P e_{wall} x(\theta) \Delta t}{n_2(\theta) m_{gas} C_p} (T_{hot} - T_2(\theta)) \quad (1)$$

$$P e_{wall} \text{ perimeter } S_{wall} = P e_{wall} x(\theta) \quad m_{air} = 29g$$

$$P_2(\theta + d\theta) = P_2(\theta) \left(1 - \frac{V_2(\theta + d\theta) - V_2(\theta)}{V_2(\theta)} \right)$$

$$Q_{heating}(\theta) = n_2(\theta) \frac{R_{gaz}}{\gamma - 1} (T_2(\theta) - T_{in})$$

With a counter-courant exchanger hypothesis $T_{out \ exchanger} = 109.5 \text{ } ^\circ\text{C}$

	Calculation	Theoretical
$T_2(180^\circ)$	150 °C	150 °C
$Q(180^\circ)$	14.4 J	14.5 J
$P(180^\circ)$	425 kPa	427.8 kPa
$V_{chamber}$	100.3 cm ³	-

$V_{chamber}$ volume of one of the two chambers of the exchanger.

With a counter-courant exchanger hypothesis $T_{out\ exchanger} = 129.7\ ^\circ C$

	<i>Calculation</i>	<i>Theoretical</i>
$T_2(180^\circ)$	150 °C	150 °C
$Q(180^\circ)$	7.2 J	7.2 J
$P(180^\circ)$	425 kPa	427.8 kPa
$V_{chamber}$	1105.9 cm ³	-

$V_{chamber}$ volume of one of the two chambers of the exchanger.

The temperature and pressure obtained are inferior than the theoretical values

By defining $A = \frac{hPe_{wall}x(\theta)\Delta t}{n_2(\theta)M_{gas}C_p}$ the equation (1) is

$$T_2(\theta + d\theta) = T_2(\theta) + \frac{\Delta x}{x C_p}(T_{in} - T_2(\theta)) + A(T_{hot} - T_2(\theta))$$

As $1 - \frac{\Delta x}{x C_p} - A \approx 1$, the equation becomes

$$T_2(\theta + d\theta) = T_2(\theta) + \frac{\Delta x}{x C_p}T_{in} + A T_{hot} \quad \text{with} \quad A = \frac{h P e_{wall} x(\theta) \Delta t}{n_2(\theta) M_{gas} C_p}$$

In order to bring the calculated values closer to the target values, it is possible to

- increase the value of T_{in}
- Increase the piston stroke $x(180^\circ)$.
- Use another gas
- Increase the heat exchange surface of the walls S_{wall}

7.3.1 reduction in motor speed :

Calculated values

$$T_{hot} = 150^\circ C \quad P = 427.8\ kPa \quad Q = 7.2\ J$$

Numerical values : With a counter-courant exchanger hypothesis $T_{out\ exchanger} = 129.7\ ^\circ C$

<i>rpm</i> $\frac{rev}{min}$	$T_2\ ^\circ C$	$P_2\ kPa$	$Q\ J$
450	150	425	7.2
350	136	424.9	7.2
175	140.5	424.9	7.2

By increasing the piston stroke by the rotational speed will be reduced

Heat exchange times are longer.

This is not an important factor to take into account when defining the motor.

7.3.2 Increase of wall surface area :

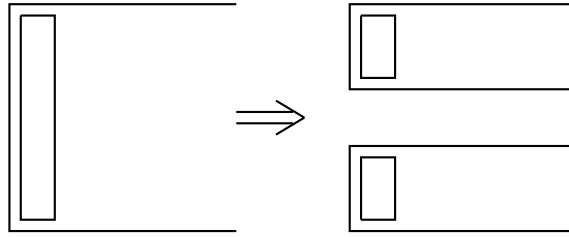

Coef : area multiplier
Calculated values

$$T_{hot} = 150^{\circ}C \quad P = 427.8 \text{ kPa} \quad Q = 7.2 \text{ J}$$

Numerical values

<i>Coef</i>	$T_2 \text{ }^{\circ}C$	$P_2 \text{ kPa}$	$Q \text{ J}$
1	150	424.9	7.2
2	150	427.8	7.2
5	150	427.8	6.9

It is a valuable factor to be considered when defining the motor.
A close theoretical can be obtained by the expansion of the surface area.

Nicolas Lanciaux proposes in his thesis to use a needle piston to solve the matter of dead volumes of Stirling engines of type α , β and γ and to expand the exchange surfaces. [5]
Increasing the exchange surface improves the efficiency, but complicates enormously the manufacture of the piston.

8 Conclusion :

In this article, it was presented the interest to design a new type of engine. Achieving heat transfer times over a half engine revolution is an important development. The engine will be efficient with the optimization of the heat exchanger. Studies will have to be carried out for a development of this motor with a alternating counter- current exchanger. Currently a Stirling motor is efficient with high pressures to increase the number of moles and if the temperature difference between the hot and cold source is high. The aim of the studies to be carried out with this new type of motor is to design a high performance Stirling motor at low cost.

Due to the current circumstances, energy choices which have been made in the past are reconsidered. The planet offers full of natural resources (sun, wind, gravity, magnetism, sea currents,...) and we can exploit those energies wisely and sustainably without any transformations.

For example, a Stirling engine coupled with the sun allows us to produce energy in a sustainable and recyclable way.

This new type will make it possible to realize a powerful engine with simple technologies.

Alpha, beta, gamma Stirling engines have a Stirling cycle that takes place over one engine revolution. The transfer times are shorter which makes the engine more difficult to optimize. In addition, there is only one volume of gas

that is in constant contact with the hot and cold source. To describe this engine, it is necessary to calculate the variations of partial mass.

The new engine makes the equations simpler to describe since it is volumes of gas that are transferred from chamber to chamber. Using an exchanger instead of a regenerator means that the exchange volume does not participate in either the compression phase or the expansion phase. This is not the case for alpha, beta, gamma Striling engines.

As a result of these conclusions, a model with alternating counter- current exchanger will have to be made in order to be able to continue its development and research on this subject.

References

- [1] Khaled M. Bataineh. Numerical thermodynamic model of alpha-type stirling engine. *Case Studies in Thermal Engineering*, 12:104 – 116, 2018.
- [2] S. Carnot. *Reflexions sur la puissance motrice du feu et sur les machines propres*. Bachelier Libraire, 1824.
- [3] E. Clapeyron. *Memoire sur la puissance motrice de la chaleur*, 1834.
- [4] Uswatun Hasanah, Rahmatsyah, and Eva Marlina Ginting. Development of stirling engine based thermodynamics tools. *Journal of Physics: Conference Series*, 1485:012015, 2020.
- [5] Nicolas Lanciaux. *Contribution au développement d'un moteur Stirling : de la cogénération dans le bâtiment à l'autonomie énergétique*. PhD thesis, 2015. Thèse de doctorat dirigée par Feng, Zhi-Qiang et Porcher, Gérard Mécanique énergétique Evry-Val d'Essonne 2015.
- [6] Pierre Lecanu. "two-stroke stirling engine". <http://www.cyberquebec.ca/normandajc/>, put online in August 2020.
- [7] H. Lumbroso. *Thermodynamique problèmes résolus*, volume isbn= 2-84074-017-6. Ediscience international.
- [8] R. Stirling. *Stirling air engine and the heat regenerator*, 1816.

rod-crank system :

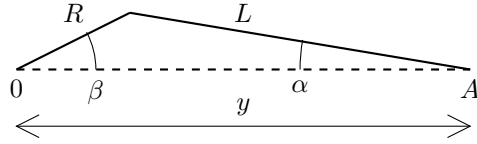

$$y = R \cos \beta + L \left(1 - \frac{R^2}{L^2} \sin^2 \beta\right)^{0.5} \quad (2)$$

$$\dot{y} = R \sin \beta - \frac{L \frac{R^2}{L^2} \cos \beta \sin \beta}{\left(1 - \frac{R^2}{L^2} \sin^2 \beta\right)^{0.5}}$$

In order to link the rotational speed *rpm* and the travel speed of point **A**

$$\Delta t = \frac{1}{rpm} \quad v(A) = \dot{y} \frac{1}{\Delta t}$$

counter-current exchanger :

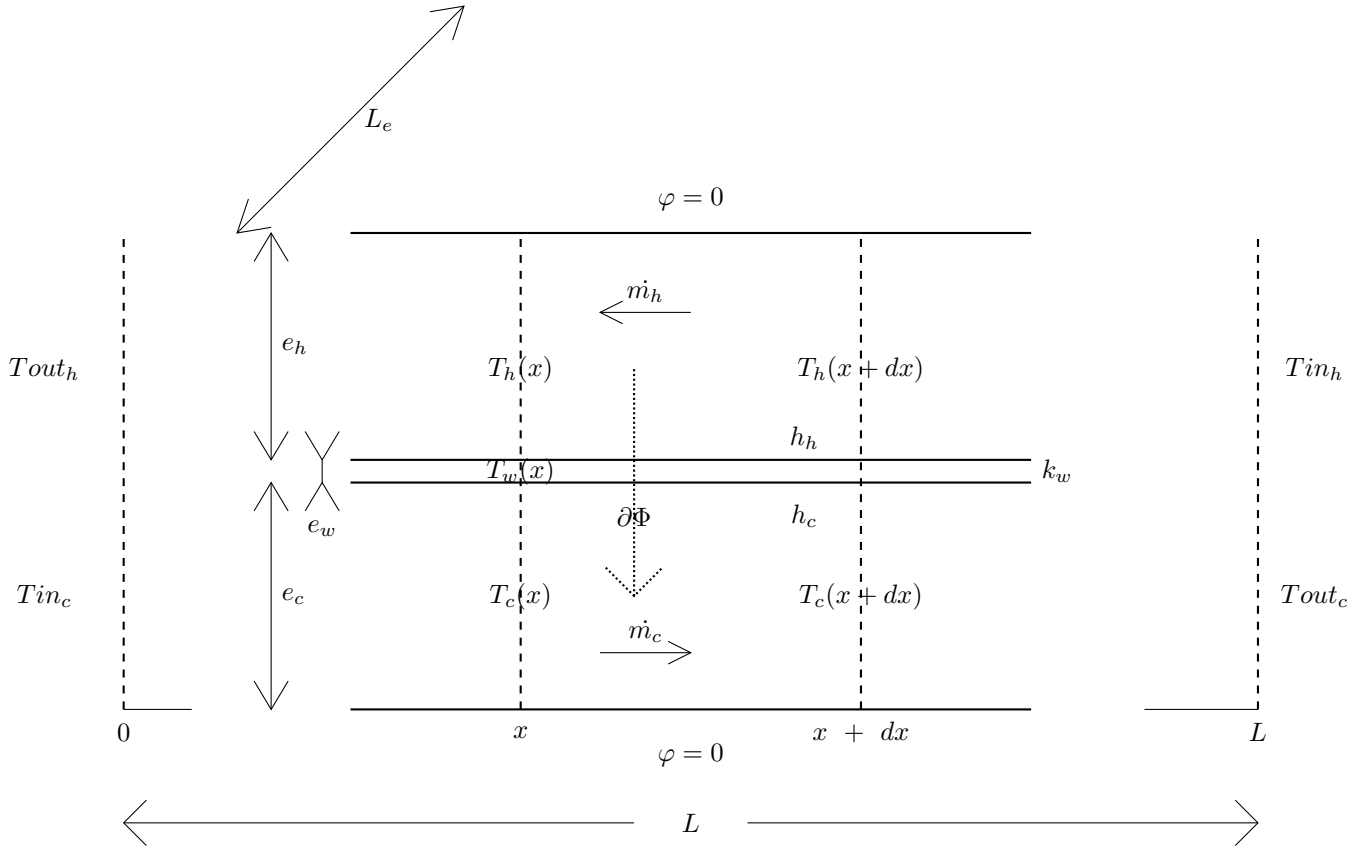

The walls of the exchanger are insulated a part from for the middle exchange wall.

term $\frac{e_w}{k_w}$ is negligible. ($\frac{e_w}{k_w} \ll \frac{1}{h_c}$)

h is the heat transfer coefficient ($\frac{W}{m^2K}$)

c_p is the specific heat capacity ($\frac{J}{kgK}$)

thermal energy balance

$$\begin{aligned} -d\phi &= \dot{m}_h C_{p_h} (T_h(x+dx) - T_h(x)) = -L_e dx h_h (T_h(x) - T_w(x)) \\ d\phi &= \dot{m}_c C_{p_c} (T_c(x+dx) - T_c(x)) = -L_e dx h_c (T_c(x) - T_w(x)) \end{aligned} \quad (3)$$

Defining a global coefficient U

$$d\phi = L_e dx U (T_h(x) - T_c(x)) \quad \text{with} \quad U = \left(\frac{1}{h_h} + \frac{e_w}{\lambda_w} + \frac{1}{h_c} \right)^{-1} \approx \left(\frac{1}{h_h} + \frac{1}{h_c} \right)^{-1}$$

From these equations

$$\begin{aligned} dT_h(x) &= T_h(x+dx) - T_h(x) & dT_c(x) &= T_c(x+dx) - T_c(x) \\ \frac{dT_h(x)}{dx} &= L_e U (T_h(x) - T_c(x)) \frac{-1}{\dot{m}_h C_{p_h}} & \frac{dT_c(x)}{dx} &= L_e U (T_h(x) - T_c(x)) \frac{-1}{\dot{m}_c C_{p_c}} \end{aligned}$$

$$d(T_h(x) - T_c(x)) = L_e U (T_h(x) - T_c(x)) \left(\frac{-1}{\dot{m}_h C_{p_h}} - \frac{-1}{\dot{m}_c C_{p_c}} \right)$$

Defining $\Delta T(x) = T_h(x) - T_c(x)$ $A = L_e U \left(\frac{1}{\dot{m}_h C_{p_h}} - \frac{1}{\dot{m}_c C_{p_c}} \right)$

$$\frac{d\Delta T(x)}{dx} = A \Delta T(x) \quad \text{with} \quad \Delta T(0) = T_h(0) - T_c(0)$$

As $\dot{m}_h = \dot{m}_c = \dot{m}$ $A = \frac{L_e U}{\dot{m}} \left(\frac{1}{C_{p_h}} - \frac{1}{C_{p_c}} \right)$

For air gas $C_{p_{1300K}} = 1197 \frac{J}{kg \cdot K}$ $C_{p_{300K}} = 1006 \frac{J}{kg \cdot K}$ $\left(\frac{1}{C_{p_{1300K}}} - \frac{1}{C_{p_{300K}}} \right) = 1.5E-04$

For hydrogen gas $C_{p_{850K}} = 15170 \frac{J}{kg \cdot K}$ $C_{p_{300K}} = 14320 \frac{J}{kg \cdot K}$ $\left(\frac{1}{C_{p_{850K}}} - \frac{1}{C_{p_{300K}}} \right) = 3.9E-06$

The coefficient A can be approximated to 0. $\Delta T(x) = T_h(x) - T_c(x) = T_{hot\ out} - T_{cold}$ **is constant.**

in using equations of thermal energy balance (3)

As $\Delta T(x) = T_h(x) - T_c(x)$ **is constant,** $T_h(x) - T_w(x)$ **is constant and** $T_c(x) - T_w(x)$ **is constant.**

$\dot{m}_h = \dot{m}_c$ $T_h(x+dx) - T_h(x)$ **is constant and** $T_c(x+dx) - T_c(x)$ **is constant.**

Isochoric heating

$$Q_{heating\ without\ exchanger} = \frac{nR_{gas}}{\gamma - 1} (T_{hot} - T_{cold})$$

This equation must be verified

$$\frac{nR_{gas}}{\gamma - 1} (T_{hot} - T_{cold}) \geq Q_{heat\ transfer} = \int_0^L L_e U (T_h(x) - T_c(x)) dx > L L_e U (T_h(x) - T_c(x)) \quad (4)$$

The heat transfer takes place over a half turn.

It is a linear function that depends on these parameters L , L_e , U , ..

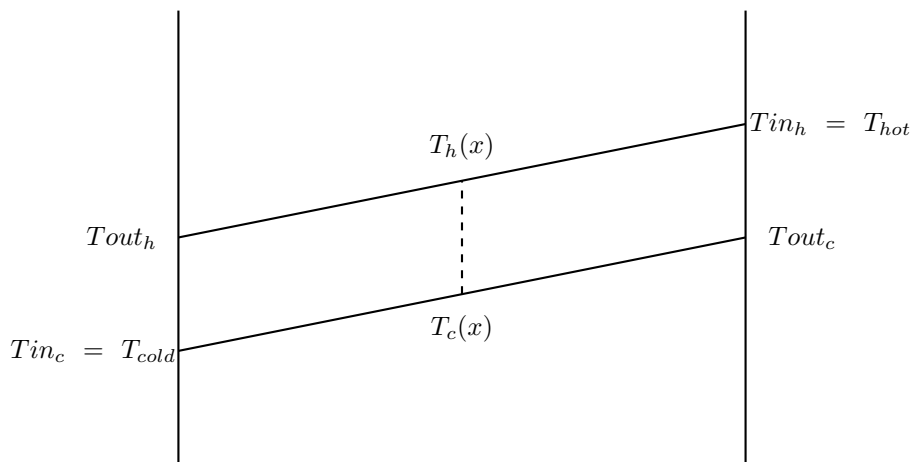

$T_h(x) - T_c(x)$ is small if :
the surface $L L_e$ is large.
the general heat transfer coefficient U is great.

It is possible to increase the exchange surface without increasing the volume.

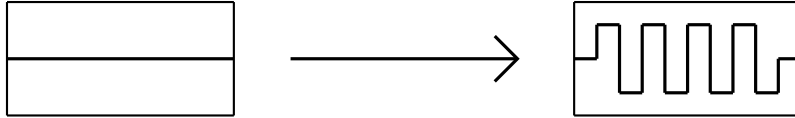

The volume of the heat exchanger do not play a role in the calculation of isothermal transformations and do not affect engine performance.

Uniform pressure : [[7]]

The conservation of the number of particles and Fick's law makes it possible to establish the equation of diffusion of a gas.

$$\frac{\partial n}{\partial t} = D \frac{\partial^2 n}{\partial x^2}$$

D is the diffusion coefficient

n is the amount of substance

The diffusion coefficient is proportional to the average particle velocity \bar{v} .

$$\bar{v} = \left(\frac{8R_{gas}T}{\pi M} \right)^{0.5} \quad D = \frac{l\bar{v}}{3}$$

l is the mean free path

For air at $20^\circ C$ the average particle velocity is

$$\bar{v} = \left(\frac{8 \cdot 8.32 \cdot 290}{\pi \cdot 29 \cdot 10^{-3}} \right)^{0.5} = 460 \frac{m}{s}$$

The speed at which the gas ($< 10 \frac{m}{s}$) moves through the engine is much lower than the average particle velocity.

$$10 \frac{m}{s} \ll 460 \frac{m}{s} \quad (5)$$

The pressure in the engine immediately becomes uniform.