



HAL
open science

A compact absorbing FSS structure for antenna decoupling in the 5G 3.5 GHz band

Faissal Merzaki, Maëlle Sergolle, Xavier Castel, Mohamed Himdi, Philippe Besnier, Thierry Levavasseur, Patrick Caldamone, Patrick Parneix

► **To cite this version:**

Faissal Merzaki, Maëlle Sergolle, Xavier Castel, Mohamed Himdi, Philippe Besnier, et al.. A compact absorbing FSS structure for antenna decoupling in the 5G 3.5 GHz band. EMC Europe 2020, Sep 2020, Rome, Italy. 6 pp. hal-02971821

HAL Id: hal-02971821

<https://hal.science/hal-02971821>

Submitted on 23 Jun 2021

HAL is a multi-disciplinary open access archive for the deposit and dissemination of scientific research documents, whether they are published or not. The documents may come from teaching and research institutions in France or abroad, or from public or private research centers.

L'archive ouverte pluridisciplinaire **HAL**, est destinée au dépôt et à la diffusion de documents scientifiques de niveau recherche, publiés ou non, émanant des établissements d'enseignement et de recherche français ou étrangers, des laboratoires publics ou privés.

A Compact Absorbing FSS Structure for Antenna Decoupling in the 5G 3.5GHz Band

F. Merzaki, M. Sergolle, X. Castel, M. Himdi, P. Besnier
Univ Rennes, INSA Rennes, CNRS
IETR - UMR 6164
F-35000, Rennes, France
faissal.merzaki@insa-rennes.fr

K. Desmars, T. Levavasseur, P. Caldamone
Séribase
F-53200, Château-Gontier, France
p.caldamone@seribase.fr

P. Parneix
Naval Group
F-44340, Bouguenais, France
patrick.parneix@naval-group.com

Abstract— *Antenna decoupling has gained a large interest in the last years, especially for MIMO 5G communications. In this frame, a high isolation is required between the multiple antennas of a transmitting array of a base station while preserving the specified radiation pattern and the compactness of the antenna array. Different solutions were proposed in the literature to provide decoupling performance. Among these, the absorbing frequency selective surface (FSS) structures have shown interesting properties. In this paper, a new type of compact FSS is introduced, using composite material technology and screen-printing. It takes advantage of a specific geometrical pattern that lowers its operation frequency with a similar spatial periodicity. We provide simulations of its absorbing properties together with an experimental validation of its performance. The proposed absorbing structure will be further adapted to decouple patch antennas in composite material technology.*

Keywords— *Frequency selective surface (FSS), electromagnetic band-gap (EBG), Defected Ground Structure (DGS), antenna decoupling, absorbing material.*

I. INTRODUCTION

Adjusting to the speed of the development of the wireless communication technology, the mobile communication is growing faster in such a way to reach every aspect of life. Nowadays the fifth generation (5G) of mobile communication has become a fertile land for research because of its promising performance and transmission rate. The [3.4- 3.6] frequency band is one of the “pioneer” frequency bands allocated to the 5G deployment in Europe. In order to push up the channel capacity without increasing the transmitted power multiple-input multiple-output (MIMO) techniques are deployed. However, communication equipment suppliers aim at miniaturizing the geometrical dimensions of the communication stations. This implies that the volume dedicated to antenna arrays has significantly decreased, which leads to the necessity of miniaturizing antennas and decreasing the space between them. Hence, the reduction of the mutual coupling between the antenna elements of these arrays becomes a challenge.

Various techniques have been introduced in the literature according to the nature of the coupling path between antennas. First, the electromagnetic band gap (EBG) technique is used to prevent the surface wave propagation from one antenna to another through the dielectric substrate [1]. Another decoupling approach presented in [2][3] consists in etching the common ground structure shared by several antennas. This so-called defected ground structure (DGS) technique consists in patterning resonating slots within the ground plane in order to prevent galvanic couplings.

Structures that behave like artificial magnetic conductors (AMCs) when printed on a grounded dielectric substrate also offer interesting properties by introducing an in-phase reflection of the incident wave. This kind of structure is used as a constructive reflector in order to send back the energy propagating in an unwilling direction of coupling [1]. A close solution but alternate one consists of achieving an absorbing FSS, which may be narrowband (thin absorber), or wideband (thick absorber) [4]. The absorption is achieved through a resistive pattern according to the original idea in [5]. Absorbers based on perfect metamaterials absorbers were recently proposed as a decoupling structure for 5G MIMO antennas [6].

The two first groups of solutions suffer from different drawbacks. The EBG structures are only useful for high permittivity substrates. The DGS solutions are based on quarter wavelength resonating structure. There are therefore not that compact and very narrowband in nature. The AMC or FSS solutions are efficient but still suffer from being cumbersome and are therefore difficult to implement. In this paper, we focus on a proposal of a new absorbing and compact FSS structure. A compact FSS structure for antenna decoupling in the [3.4-3.6] GHz band is presented in section II and its fabrication technology and process is depicted in section III. Its absorbing performances are simulated and compared to experimental measurements in section IV. Finally, we draw some conclusions and perspective in section V.

II. THE PROPOSED FSS STRUCTURE

A FSS is a structure consisting of two-dimensional periodic elements. The Fig. 1 shows a structure made of a periodic array (with period D) of resistive patch elements over a grounded dielectric substrate with thickness h and ϵ its dielectric permittivity [4]. The surface impedance of the patch is adapted to the equivalent impedance of the EM wave impinging on the structure, which depends on its reflection on the ground plane.

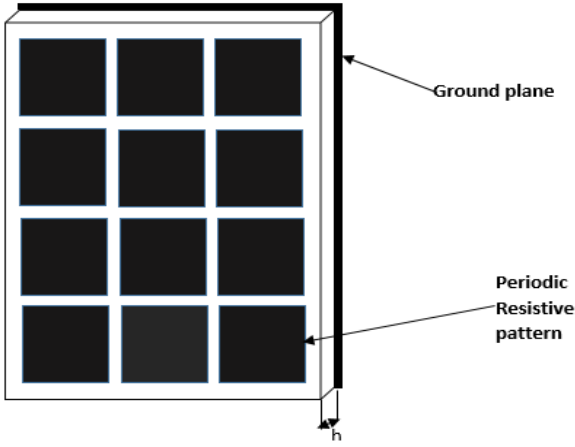

Figure 1: periodic arrangement of a patch FSS structure

The behavior of a freestanding FSS (i.e. an array of periodic patterns in free space without substrate and ground plane) illuminated by a plane wave at normal incidence may be represented by an equivalent circuit. This equivalent circuit is a series R,L,C circuit where the lumped resistance R is proportional to the surface resistance R_s of the patterns, the lumped capacitor C and inductance L account for mutual electric (respectively magnetic) coupling between patches (Fig. 2)[3].

The impedance of the lossy FSS can be written as:

$$Z_{FSS} = R - j \frac{1 - \omega^2 LC}{\omega C} = R + jX \quad (1)$$

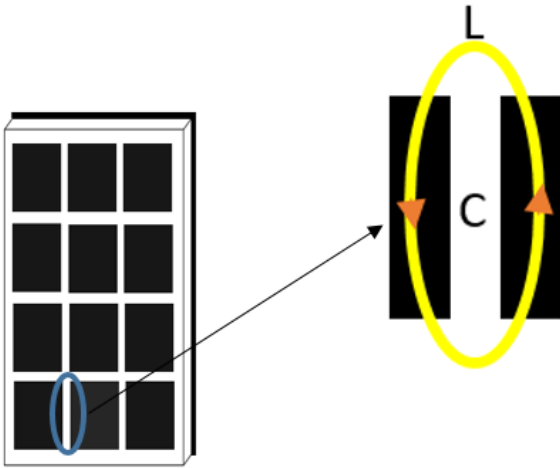

Figure 2: A physical representation of the mutual inductance and capacitance

The impedance at the interface of the FSS is composed of the previous equivalent impedance Z_{FSS} in parallel to the impedance seen by the EM wave propagating towards the ground plane and then reflected back. This latter impedance is complex and purely imaginary (dielectric losses of the substrate are neglected) and noted $+jZ_d$ where j is the imaginary unit number.

$$Z_d = Z_m^{TE, TM} \tan(\beta h) \quad (2)$$

Where $Z_m^{TE} = \omega \frac{\mu_r \mu_0}{\beta}$; $Z_m^{TM} = \beta / (\omega \epsilon_r \epsilon_0)$ are the characteristic impedance of the slab for TE and TM polarization.

The input impedance of the entire absorber can be written as:

$$Z_{IN} = \frac{jZ_d Z_{FSS}}{jZ_d + Z_{FSS}} \quad (3)$$

$$Re(Z_{IN}) = \frac{RZ_d^2}{R^2 + (X + Z_d)^2} \quad (4)$$

$$Im(Z_{IN}) = \frac{XZ_d \cdot (X + Z_d) + R^2 Z_d}{(X + Z_d)^2 + R^2} \quad (5)$$

The properties of the grounded dielectric impedance depend on the thickness of the dielectric substrate. When $h < \lambda/4$, the impedance of the grounded dielectric is inductive, this implies that a first resonance occurs associating the capacitive reactance X of the resistive FSS and the inductive impedance of the back-propagating wave ($X = -Z_d$) from the grounded dielectric.

$$Re(Z_{IN}) = \frac{Z_d^2}{R} \quad (6)$$

At the resonance, the imaginary part of Z_{IN} is non null and equals to Z_d , Z_d remaining much smaller than Z_0 , the free space impedance of the impinging wave. In order to get the absorption of the impinging signal the input impedance should match the free space impedance Z_0 .

$$R_{opt} = \frac{Z_d^2}{Z_0} \quad (7)$$

In this expression R_{opt} corresponds to the optimized equivalent resistive impedance of the 2-D surface of periodic patterns. When $h > \lambda/4$ the impedance of the grounded dielectric becomes capacitive. As a result, a second resonance takes place above the resonance frequency of the free standing FSS, which becomes inductive.

In this article, a thin ($h < \lambda/4$) and narrowband FSS absorber is handled, which implies that the second resonance will not be taken into account for the rest of the analysis.

A key feature to obtain a compact structure, i.e. a structure that would operate at lower frequency range for the same D , consists of achieving higher equivalent capacitance and inductance for the FSS. As a starting point, we chose a structure presented in [7] and with the geometrical parameters shown in Fig.3. This structure is characterized by its periodicity $D = 13.3$ mm.

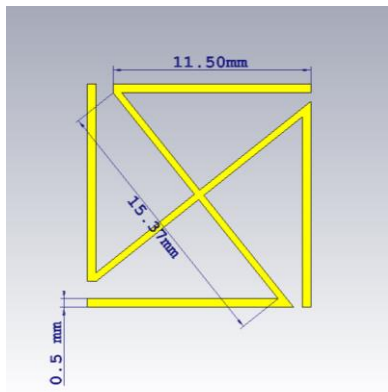

Figure 3: Unit cell of the initial FSS with copper filaments ($D=13.3$ mm)

In order to have an insight about the resonant phenomenon generated by the LC circuit, a freestanding FSS simulation is performed by arranging periodically metallic FSS using copper unit cell to form an infinite FSS sheet in vacuum Fig.4.

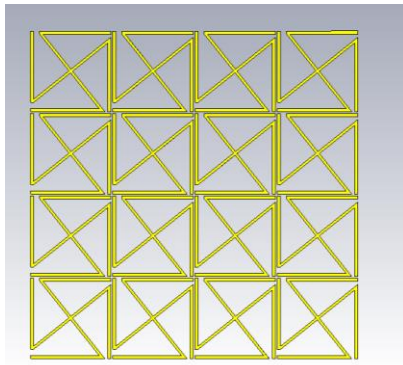

Figure 4: Partial view of an infinite 2D sheet of the freestanding FSS periodic structure based on the unit cell of Fig.3

This simulation is performed using CST microwave software by setting a periodic boundary condition in the xy plane and open boundary conditions in the z -axis. The structure is illuminated with a plane wave at normal incidence along the z -axis and we estimate the magnitude of the reflected plane wave. Figure 5 shows the reflection coefficient of the plane wave. As a matter of fact, the maximum reflection occurs at 3 GHz which corresponds to the resonance of the series L,C circuit of the freestanding FSS of Fig. 4.

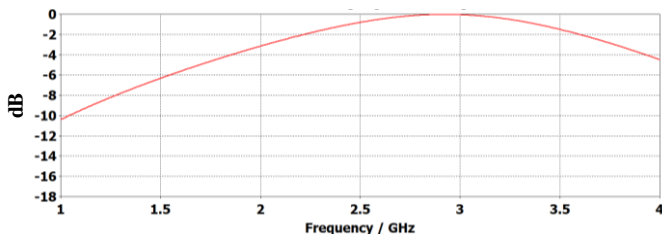

Figure 5: Simulation of the reflection coefficient of the initial structure of Fig. 4

A significant increase of the equivalent capacitance can be obtained by interdigitating the adjacent cell, without

modifying the periodicity D . Figure 6 shows the top view of the interdigitating FSS structure

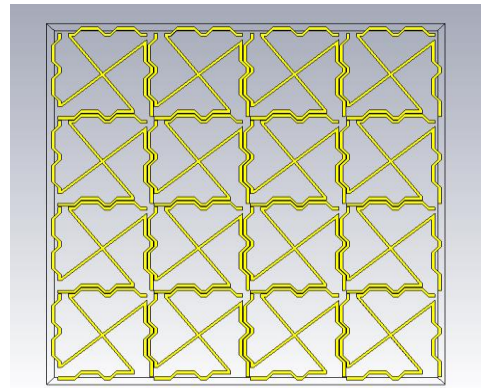

Figure 6: Freestanding FSS structure with interdigitating of adjacent metallic bands

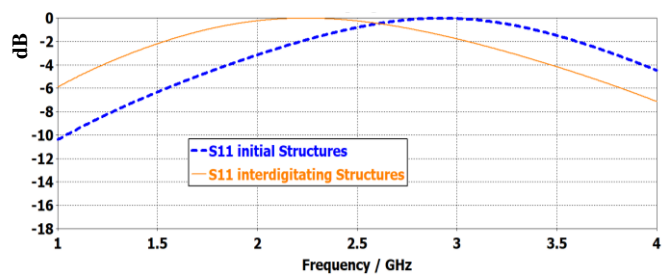
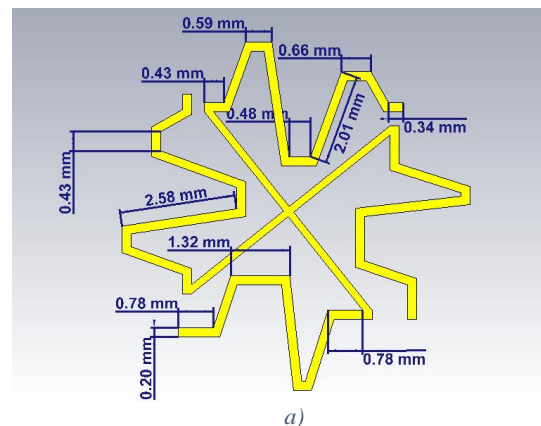

Figure 7: Simulation of the reflection coefficient of the initial (Fig.4) and interdigitated (Fig. 6) metallic FSS structures

As a consequence, the curve of the reflection coefficient is now shifted towards the low frequency (Fig. 7).The maximum reflection occurs at 2.2 GHz instead of 3 GHz. It can be explained from the physical nature of the L,C lumped elements. Modifying the geometry (Fig. 6) of the electrically conductive filaments of the initial structure (Fig. 6), we increase their length, and we minimize distances between filaments of adjacent cells. This implies that the mutual capacitance increases as well. Meanwhile, the current path is also lengthened, which increases the mutual inductance. This leads to the observed shift of the resonance frequency.

Based on this analysis of a freestanding FSS behavior, an optimized compact absorbing FSS structure at 3.5GHz is proposed as detailed in Fig. 8. This absorber is characterized by a periodicity of only $D=5.9$ mm ($\lambda/14.5$ at 3.5GHz)



a)

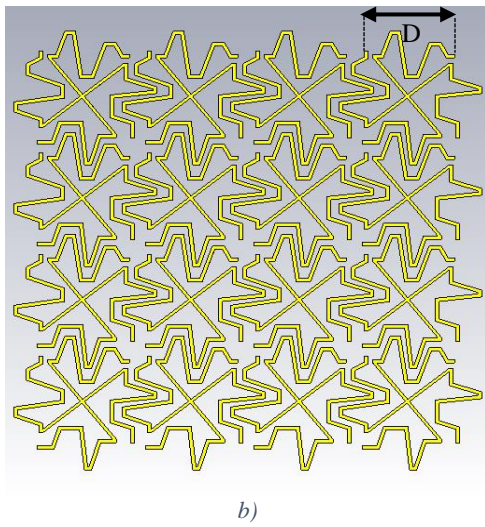

Figure 8: Final design of a compact freestanding FSS structure a) Unit cell b) Full FSS structure

The sheet resistance of the filaments is 1.5 Ohm/sq and embedded in a grounded dielectric substrate. This substrate is a composite material made of polypropylene fibers and polyester resin. It is characterized by its relative dielectric permittivity $\epsilon_r = 2.3$, its low loss tangent $tg\delta=0.0047$ and its thickness of 4 mm ($\lambda/21.5$ at 3.5GHz). Illustrations of the proposed absorbing structures are proposed in Fig. 9 and 10. Should such an absorber be based on the initial pattern of Fig. 3 at the same frequency, the periodicity D would be 7.4 mm rather than 5.9 mm. The gain in size is therefore of 20%.

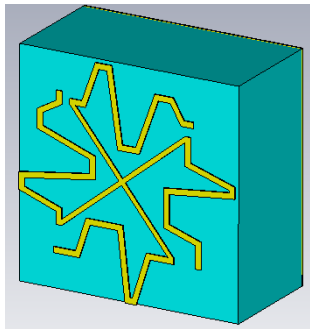

Figure 9: The final FSS unit cell over its grounded substrate

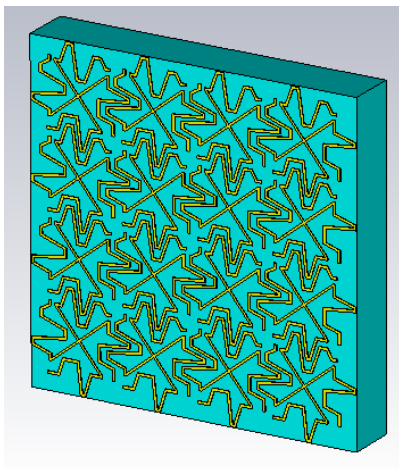

Figure 10: The periodic absorbing FSS structure based on Fig.9

Simulations of the reflection coefficient of the complete structure (FSS pattern + substrate) are performed in the same conditions as above with CST.

The simulation results are shown in Fig.11. The FSS structure shows a peak of absorption at 3.48 GHz. Its frequency range (corresponding to a reflection coefficient below -10dB) is [3.3 - 3.7] GHz, which entirely covers the 5G frequency band for Europe.

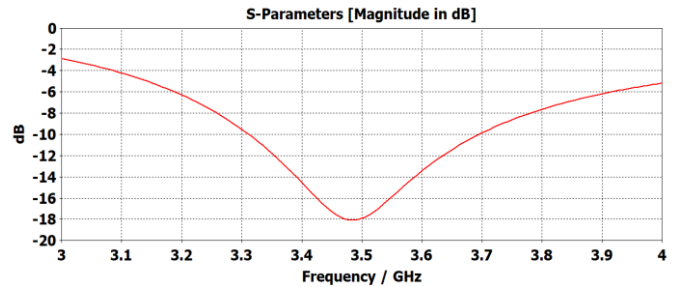

Figure 11: Simulation of the reflection coefficient of the compact FSS structure of Fig. 10

III. FABRICATION OF THE ABSORBING DEVICE

Two prototypes of FSS absorbers were fabricated using two different supports. The resistive FSS pattern is obtained from a screen-printing process. The resolution of the applied process reaches an accuracy of 100 μ m. The resistive FSS has been patterned using two supports, PET and glossy paper of total size 35 cm x 35 cm. Figure 12 shows the resistive surface painted on a glossy paper. The ink has been made by mixing 53.1% silver ink PF410 and 46.9% of Carbone ink 6017SS.

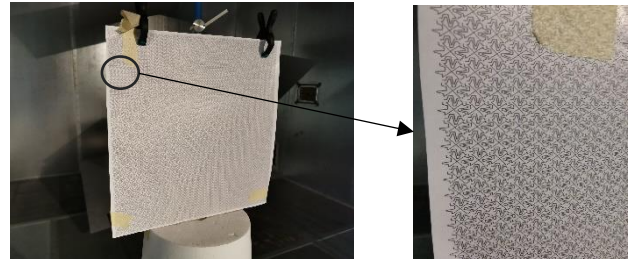

Figure 12: A view of the Resistive FSS screen-printed on a glossy paper

The dielectric substrate consists in a InnegraTM fabrics (woven polypropylene fibers, namely a 340 g/m² taffeta) infused with polyester resin. The fabricated substrate exhibits a dielectric permittivity $\epsilon_r = 2.3 \pm 0.4$ and dielectric loss tangent $tg\delta = 4.7 \times 10^{-3} \pm 0.5 \times 10^{-3}$ at 1 GHz (retrieved from impedance measurements). The dielectric composite material and the ground plane have the same dimension as the full printed FSS structure (Fig.13).



Figure 13: Metallic ground plane and the dielectric substrate

IV. CHARACTERIZATION OF THE FSS STRUCTURE

A. Measurement Principle:

The measurement of absorbing efficiency is based on the retrieval of radar cross-section (RCS) in a reverberation chamber. It is made possible thanks to the extraction of the ballistic backscattered wave from the target and by analyzing the scattering S parameter as measured from a single transmitting / receiving antenna. Identification of the target, considered as a point source scatterer, is achieved through a sine wave regression estimation over a relatively small bandwidth frequency response of the RC. Further details are provided in [8]. The test of the absorbing FSS structure follows a two-step procedure. The first step consists in measuring the RCS of a metallic plate. The second step consists in measuring the FSS of the same size installed on top of the metallic plate. The contrast of RCS provides the absorbing performance of the FSS device, at normal incidence of the electromagnetic quasi-plane wave.

B. Measurement Results:

Once the reference RCS is measured for the metallic plane, we perform a measurement with the addition of the only dielectric substrate to check its potential impact the measured RCS. Then, the last measurement is carried out once the screen-printed FSS film is stuck on top of the grounded dielectric substrate.

All results are gathered in Fig. 14. The metallic plate (black curve) provides the highest RCS (σ in dBm²). The interposition of the composite substrate does not provide any modification of this RCS coefficient. Once adding the printed FSS pattern either on a PET film or on a glossy paper an absorption mechanism takes place. The FSS pattern printed on a PET film provides an average of 5dB absorption in the [3.4-3.7] GHz frequency range. The glossy paper reaches an excellent performance, presenting an average absorption of 12 dB, between 3.2 and 3.7 GHz. This higher performance is due to a better control of the sheet resistance of the printed ink in the case of the glossy paper.

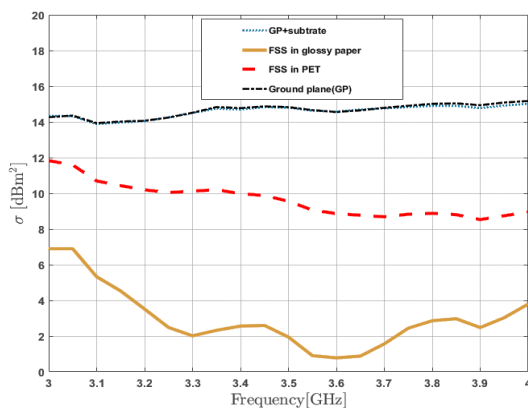

Figure 14: RCS measurement results of the FSS structure

The Fig.15 shows a comparison of the simulated reflection coefficient of the FSS absorber and that of the glossy paper version of the FSS as deduced from measurements in Fig. 14.

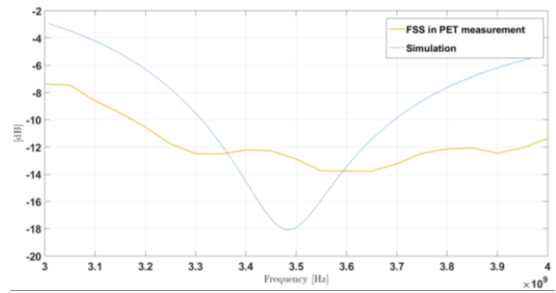

Figure 15: Comparison of the absorption level between simulation and FSS structure

The experimental results indicate that the realized absorbing FSS owns a larger bandwidth than the simulated one. It may be partially due to the glossy paper support, which was not accounted for in the simulation.

V. CONCLUSION

In this paper, we have briefly recalled the operating principle of an absorbing FSS structure. We have determined a way of increasing the mutual capacitance and inductance of the periodic elements of the FSS array minimizing the periodicity of the array at the targeted 3.5 GHz 5G frequency band. A simulation of the reflection coefficient of the freestanding FSS pattern has been performed to confirm that our proposed interdigitated unit cell enables to shift the resonance frequency of the periodic structure towards a lower frequency. Based on this new pattern an absorbing FSS was optimized and fabricated from the combination of a composite low-loss substrate and a screen-printed support (PET or glossy paper). Experimental results using RCS measurements at normal incidence in a reverberation chamber show very good performance for the glossy paper version. This FSS-type absorber is currently under adaptation (shape and size) in order to decouple the patch antennas of an array.

ACKNOWLEDGMENT

This project is part of the STARCOM project supported by the French “FUI” program. This work was also supported in part by the European Union through the European Regional Development Fund, in part by the Ministry of Higher Education and Research, in part by the Région Bretagne, in part by the Départements d’Ille et Vilaine et des Côtes d’Armor, and in part by Rennes Métropole and Saint-Brieuc Armor Agglomération, through the CPER Projects 2015-2020 MATECOM and SOPHIE / STIC and Ondes.

REFERENCES

- [1] G. Goussetis, A.P. Feresidis, and J.C. Vardaxoglou, “Tailoring the AMC and EBG Characteristics of Periodic Metallic Arrays Printed on Grounded Dielectric Substrate,” *IEEE Trans. Antennas Propagat.*, vol. 54, no 1, pp 82-89, Jan. 2006.
- [2] D-J Woo, L. Taek-Kyung, and N. Sangwook, “A Modeling Method for Dumbbell-Shaped DGS and its Parameter Extraction,” *Microwave and Optical Technology Letters* 56, no 12, pp.2910-2913, Dec. 2014.
- [3] Z. Zakaria, N. A. Shairi, R. Sulaiman, and W. Y. Sam, “Design of Reconfigurable Defected Ground Structure (DGS) for UWB Application,” In 2012 IEEE Asia-Pacific Conference on Applied Electromagnetics (APACE), Melaka, Malaysia, pp. 195-198, 2012.
- [4] F. Costa, A. Monorchio, and G. Manara, “Analysis and Design of Ultra Thin Electromagnetic Absorbers Comprising Resistively Loaded High Impedance Surfaces,” *IEEE Trans. Antennas Propagat.*, vol. 58, no 5, pp. 1551-1558, May 2010.

[5] N. Engheta, "Thin Absorbing Screens Using Metamaterial Surfaces," In IEEE Antennas and Propagation Society International Symposium. San Antonio, TX, USA: IEEE, pp 392-95, 2002.

[6] Z. Xu, Q. Zhang and L. Guo. « A Compact 5G Decoupling MIMO Antenna Based on Split-Ring Resonators ». International Journal of Antennas and Propagation, pp 1-10, Jun. 2019.

[7] S. Barbagallo, A. Monorchio, and G. Manara, "Small Periodicity FSS Screens with Enhanced Bandwidth Performance," Electronics Letters, vol. 42, no 7, pp. 382-384, 2006.

[8] P. Besnier, J. Sol and S. Méric, "Estimating radar cross-section of canonical targets in reverberation chamber," 2017 International Symposium on Electromagnetic Compatibility - EMC EUROPE, pp. 1-5, 2017.